

HEARING AID COMPATIBILITY

Applicant Name:
LG Electronics U.S.A, Inc.
1000 Sylvan Avenue
Englewood Cliffs, NJ 07632
United States

Date of Testing:
01/07/2019 - 01/22/2019
Test Site/Location:
PCTEST Lab, Columbia, MD, USA
Test Report Serial No.:
1M1811230205-13-R4.ZNF

FCC ID: ZNFV450PM

APPLICANT: LG ELECTRONICS U.S.A, INC.

Scope of Test: Audio Band Magnetic Testing (T-Coil)
Application Type: Certification
FCC Rule Part(s): CFR §20.19(b)
HAC Standard: ANSI C63.19-2011
285076 D01 HAC Guidance v05
285076 D02 T-Coil testing for CMRS IP v03
DUT Type: Portable Handset
Model: LM-V450PM
Additional Model(s): LMV450PM, V450PM
Test Device Serial No.: Pre-Production Sample [S/N: 00444, 00386, 00004]

C63.19-2011 HAC Category: T3 (SIGNAL TO NOISE CATEGORY)



Note: This revised Test Report (S/N: 1M1811230205-13-R4.ZNF) supersedes and replaces the previously issued test report on the same subject device for the same type of testing as indicated. Please discard or destroy the previously issued test report(s) and dispose of it accordingly.

This wireless portable device has been shown to be hearing-aid compatible under the above rated category, specified in ANSI/IEEE Std. C63.19-2011 and has been tested in accordance with the specified measurement procedures. Test results reported herein relate only to the item(s) tested. Hearing-Aid Compatibility is based on the assumption that all production units will be designed electrically identical to the device tested in this report. North American Bands only.

I attest to the accuracy of data. All measurements reported herein were performed by me or were made under my supervision and are correct to the best of my knowledge and belief. I assume full responsibility for the completeness of these measurements and vouch for the qualifications of all persons taking them.



Randy Ortanez
President



FCC ID: ZNFV450PM		HAC (T-COIL) TEST REPORT		Approved by: Quality Manager
Filename: 1M1811230205-13-R4.ZNF	Test Dates: 01/07/2019 - 01/22/2019	DUT Type: Portable Handset	Page 1 of 90	

T A B L E O F C O N T E N T S

1.	INTRODUCTION	3
2.	DUT DESCRIPTION.....	4
3.	ANSI C63.19-2011 PERFORMANCE CATEGORIES	6
4.	METHOD OF MEASUREMENT	8
5.	VOLTE TEST SYSTEM SETUP AND DUT CONFIGURATION	18
6.	VOWIFI TEST SYSTEM SETUP AND DUT CONFIGURATION	22
7.	OTT VOIP TEST SYSTEM AND DUT CONFIGURATION	25
8.	FCC 3G MEASUREMENTS	28
9.	T-COIL TEST SUMMARY	30
10.	MEASUREMENT UNCERTAINTY	43
11.	EQUIPMENT LIST	44
12.	TEST DATA	45
13.	CALIBRATION CERTIFICATES.....	78
14.	CONCLUSION.....	85
15.	REFERENCES	86
16.	TEST SETUP PHOTOGRAPHS	88

FCC ID: ZNFV450PM	 <small>PCTEST ENGINEERING LABORATORY, INC.</small>	HAC (T-COIL) TEST REPORT		Approved by: Quality Manager
Filename: 1M1811230205-13-R4.ZNF	Test Dates: 01/07/2019 - 01/22/2019	DUT Type: Portable Handset	Page 2 of 90	

1. INTRODUCTION

On July 10, 2003, the Federal Communications Commission (FCC) adopted new rules requiring wireless manufacturers and service providers to provide digital wireless phones that are compatible with hearing aids. The FCC has modified the exemption for wireless phones under the Hearing Aid Compatibility Act of 1998 (HAC Act) in WT Docket 01-309 RM-8658¹ to extend the benefits of wireless telecommunications to individuals with hearing disabilities. These benefits encompass business, social and emergency communications, which increase the value of the wireless network for everyone. An estimated more than 10% of the population in the United States show signs of hearing impairment and of that fraction, almost 80% use hearing aids. Approximately 500 million people worldwide and 30 million people in the United States suffer from hearing loss.

Compatibility Tests Involved:

The standard calls for wireless communications devices to be measured for:

- RF Electric-field emissions
- T-coil mode, magnetic-signal strength in the audio band
- T-coil mode, magnetic-signal frequency response through the audio band
- T-coil mode, magnetic-signal and noise articulation index

The hearing aid must be measured for:

- RF immunity in microphone mode
- RF immunity in T-coil mode

In the following tests and results, this report includes the evaluation for a wireless communications device.

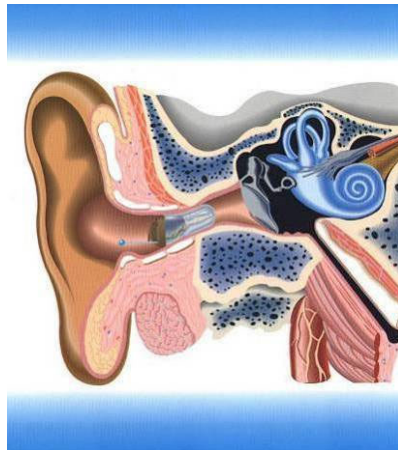



Figure 1-1 Hearing Aid *in-vitu*

¹ FCC Rule & Order, WT Docket 01-309 RM-8658

FCC ID: ZNFV450PM		HAC (T-COIL) TEST REPORT		Approved by: Quality Manager
Filename: 1M1811230205-13-R4.ZNF	Test Dates: 01/07/2019 - 01/22/2019	DUT Type: Portable Handset	Page 3 of 90	

2. DUT DESCRIPTION





FCC ID: ZNFV450PM
Applicant: LG Electronics U.S.A, Inc.
1000 Sylvan Avenue
Englewood Cliffs, NJ 07632
United States
Model: LM-V450PM
Additional Model(s): LMV450PM, V450PM
Serial Number: 00444, 00386, 00004
HW Version: Rev.A
SW Version: V450P06h
Antenna: Internal Antenna
DUT Type: Portable Handset

I. LTE Band Selection

This device supports the following pairs of LTE bands with similar frequencies: LTE B12 & B17, B5 & B26, B4 & B66, and B2 & B25. These pairs of LTE bands have the same target power and share the same transmission path. Since the supported frequency spans for the smaller LTE bands are completely covered by the larger LTE bands, only the larger LTE bands (LTE B12, B26, B66, and B25) were evaluated for hearing-aid compliance.

II. Device Serial Numbers

Several samples with identical hardware were used to support HAC testing. The manufacturer has confirmed that the device(s) tested have the same physical, mechanical, and thermal characteristics are within operational tolerances expected for production units. The serial numbers used for each test are indicated alongside the results in Section 9.

FCC ID: ZNFV450PM		HAC (T-COIL) TEST REPORT		Approved by: Quality Manager
Filename: 1M1811230205-13-R4.ZNF	Test Dates: 01/07/2019 - 01/22/2019	DUT Type: Portable Handset	Page 4 of 90	



© 2019 PCTEST Engineering Laboratory, Inc.

REV 3.2.M
04/17/2018

© 2019 PCTEST Engineering Laboratory, Inc. All rights reserved. Unless otherwise specified, no part of this report may be reproduced or utilized in any part, form or by any means, electronic or mechanical, including photocopying and microfilm, without permission in writing from PCTEST Engineering Laboratory, Inc. If you have any questions about this international copyright or have an enquiry about obtaining additional rights to this report or assembly of contents thereof, please contact INFO@PCTEST.COM.

**Table 2-1
ZNFV450PM HAC Air Interfaces**

Air-Interface	Band (MHz)	Type Transport	HAC Tested	Simultaneous But Not Tested	Name of Voice Service	Audio Codec Evaluated
CDMA	835	VO	Yes	Yes: WIFI or BT	CMRS Voice ¹	EVRC
	1900					
	EvDO	VD	Yes	Yes: WIFI or BT	Google Duo ²	OPUS
GSM	850	VO	Yes	Yes: WIFI or BT	CMRS Voice ¹	EFR
	1900					
	GPRS/EDGE	VD	Yes	Yes: WIFI or BT	Google Duo ²	OPUS
UMTS	850	VD	Yes	Yes: WIFI or BT	CMRS Voice ¹	NB AMR
	1700					
	1900					
	HSPA	VD	Yes	Yes: WIFI or BT	Google Duo ²	OPUS
LTE (FDD)	680 (B71)	VD	Yes ³	Yes: WIFI or BT	VoLTE ¹ , Google Duo ²	VoLTE: NB AMR, WB AMR, EVS Google Duo: OPUS
	700 (B12)					
	700 (B17)					
	780 (B13)					
	850 (B5)					
	850 (B26)					
	1700 (B4)					
	1700 (B66)					
	1900 (B2)					
1900 (B25)						
LTE (TDD)	2600 (B41)	VD	Yes	Yes: WIFI or BT	VoLTE ¹ , Google Duo ²	VoLTE: NB AMR, WB AMR, EVS Google Duo: OPUS
NR	2600 (Band n41)	VD	Yes	Yes: WIFI or BT	Google Duo ²	OPUS
WIFI	2450	VD	Yes	Yes: CDMA, GSM, UMTS, or LTE	VoWIFI ² , Google Duo ²	VoWIFI: NB AMR, WB AMR, EVS Google Duo: OPUS
	5200 (U-NII 1)					
	5300 (U-NII 2A)					
	5500 (U-NII 2C)					
	5800 (U-NII 3)					
BT	2450	DT	No	Yes: CDMA, GSM, UMTS, or LTE	N/A	N/A
Type Transport VO = Voice Only DT = Digital Data - Not intended for Voice Services VD = CMRS and/or IP Voice over Data Transport			Notes: ¹ Reference level in accordance with 7.4.2.1 of ANSI C63.19-2011 and July 2012 C63 VoLTE Interpretation. ² Reference level is -20dBm0 in accordance with FCC KDB 285076 D02 ³ LTE B71, while outside the scope of ANSI C63.19 and FCC HAC regulations, was additionally tested according to the existing HAC procedures.			

FCC ID: ZNFV450PM		HAC (T-COIL) TEST REPORT		Approved by: Quality Manager
Filename: 1M1811230205-13-R4.ZNF	Test Dates: 01/07/2019 - 01/22/2019	DUT Type: Portable Handset	Page 5 of 90	

3. ANSI C63.19-2011 PERFORMANCE CATEGORIES

I. MAGNETIC COUPLING

Axial and Radial Field Intensity

All orientations of the magnetic field, in the axial and radial position along the measurement plane shall be ≥ -18 dB(A/m) at 1 kHz in a 1/3 octave band filter per §8.3.1.

Frequency Response

The frequency response of the axial component of the magnetic field shall follow the response curve specified in EIA RS-504-1983, over the frequency range 300 Hz – 3000 Hz per §8.3.2.

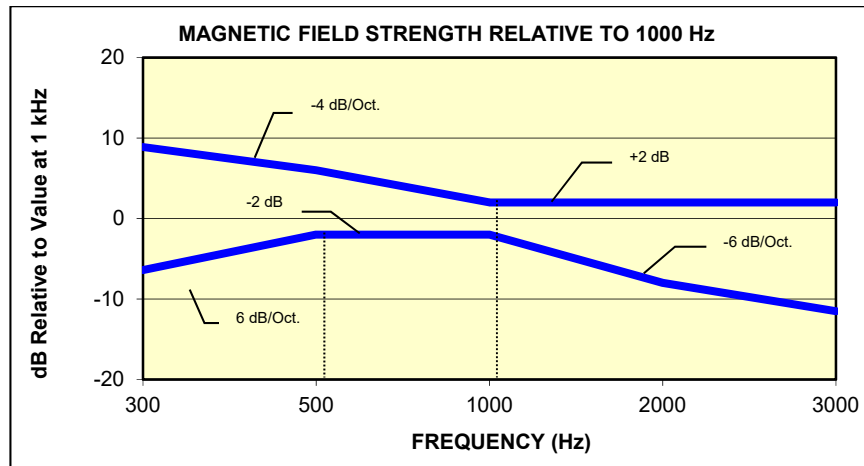

Figure 3-1
Magnetic field frequency response for Wireless Devices with an axial field ≤ -15 dB(A/m) at 1 kHz

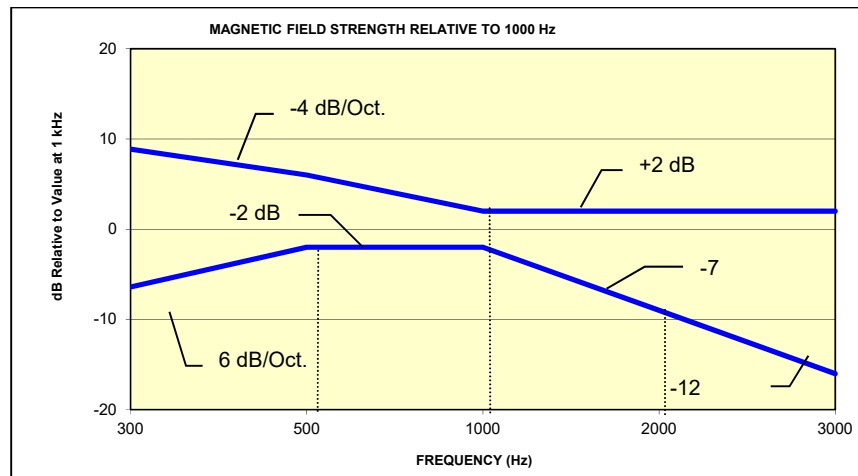



Figure 3-2
Magnetic Field frequency response for wireless devices with an axial field that exceeds -15 dB(A/m) at 1 kHz

FCC ID: ZNFV450PM		HAC (T-COIL) TEST REPORT		Approved by: Quality Manager
Filename: 1M1811230205-13-R4.ZNF	Test Dates: 01/07/2019 - 01/22/2019	DUT Type: Portable Handset		Page 6 of 90

Signal Quality



The table below provides the signal quality requirement for the intended audio magnetic signal from a wireless device. Only the RF immunity of the hearing aid is measured in T-coil mode. It is assumed that a hearing aid can have no immunity to an interference signal in the audio band, which is the intended reception band for this mode. The only criterion that can be measured is the RF immunity in T-coil mode. This is measured using the same procedure as the audio coupling mode at the same levels.

The signal quality of the axial and radial components of the magnetic field was used to determine the T-coil mode category.

Category	Telephone RF Parameters
	Wireless Device Signal Quality [(Signal + Noise)-to-noise ratio in dB]
T1	0 to 10 dB
T2	10 to 20 dB
T3	20 to 30 dB
T4	> 30 dB

Table 3-1
Magnetic Coupling Parameters

Note: The FCC limit for SNNR is 20dB and the test data margins will indicate a margin from the FCC limit for compliance.

FCC ID: ZNFV450PM	 PCTEST ENGINEERING LABORATORY, INC.	HAC (T-COIL) TEST REPORT		Approved by: Quality Manager
Filename: 1M1811230205-13-R4.ZNF	Test Dates: 01/07/2019 - 01/22/2019	DUT Type: Portable Handset		Page 7 of 90

© 2019 PCTEST Engineering Laboratory, Inc.

REV 3.2.M
04/17/2018

© 2019 PCTEST Engineering Laboratory, Inc. All rights reserved. Unless otherwise specified, no part of this report may be reproduced or utilized in any part, form or by any means, electronic or mechanical, including photocopying and microfilm, without permission in writing from PCTEST Engineering Laboratory, Inc. If you have any questions about this international copyright or have an enquiry about obtaining additional rights to this report or assembly of contents thereof, please contact INFO@PCTEST.COM.

4. METHOD OF MEASUREMENT

I. Test Setup

The equipment was connected as shown in an acoustic/RF hemi-anechoic chamber:

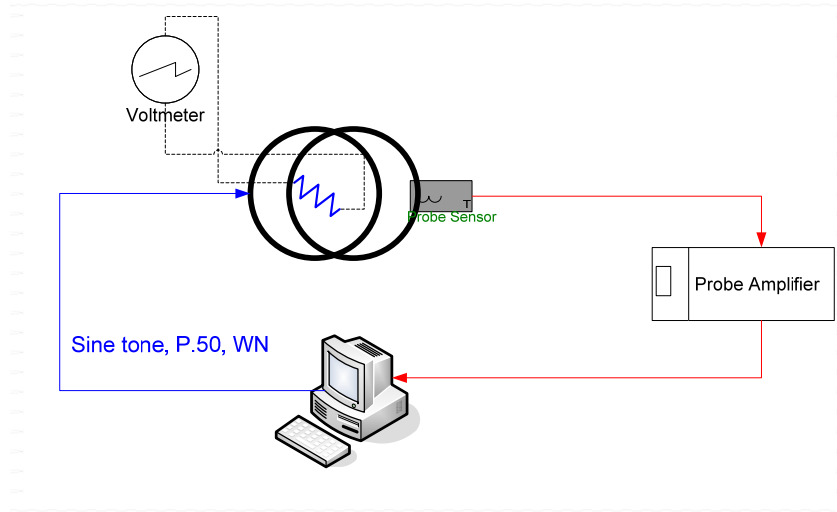

Figure 4-1
Validation Setup with Helmholtz Coil

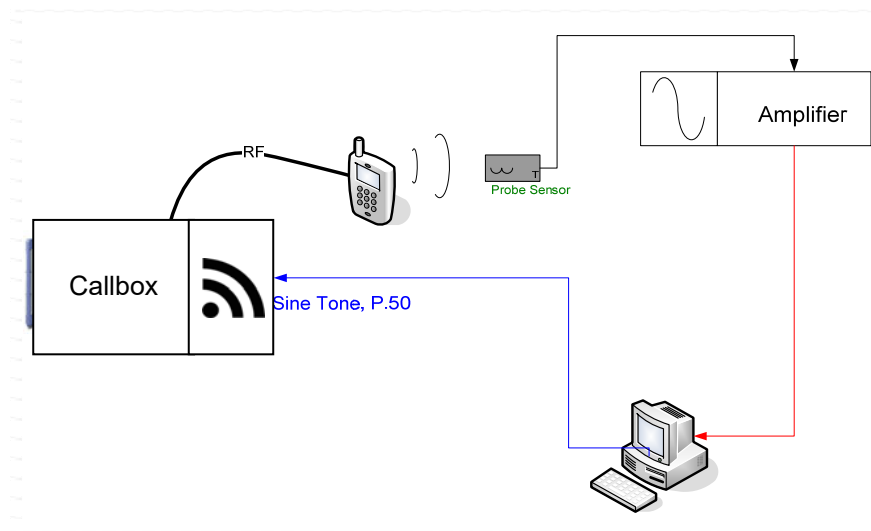



Figure 4-2
T-Coil Test Setup

FCC ID: ZNFV450PM		HAC (T-COIL) TEST REPORT		Approved by: Quality Manager
Filename: 1M1811230205-13-R4.ZNF	Test Dates: 01/07/2019 - 01/22/2019	DUT Type: Portable Handset		Page 8 of 90

© 2019 PCTEST Engineering Laboratory, Inc.

REV 3.2.M

04/17/2018

© 2019 PCTEST Engineering Laboratory, Inc. All rights reserved. Unless otherwise specified, no part of this report may be reproduced or utilized in any part, form or by any means, electronic or mechanical, including photocopying and microfilm, without permission in writing from PCTEST Engineering Laboratory, Inc. If you have any questions about this international copyright or have an enquiry about obtaining additional rights to this report or assembly of contents thereof, please contact INFO@PCTEST.COM.

II. Scanning Mechanism

Manufacturer:	TEM
Accuracy:	± 0.83 cm/meter
Minimum Step Size:	0.1 mm
Maximum speed	6.1 cm/sec
Line Voltage:	115 VAC
Line Frequency:	60 Hz
Material Composite:	Delrin (Acetal)
Data Control:	Parallel Port
Dynamic Range (X-Y-Z):	45 x 31.75 x 47 cm
Dimensions:	36" x 25" x 38"
Operating Area:	36" x 49" x 55"
Reflections:	< -20 dB (in anechoic chamber)

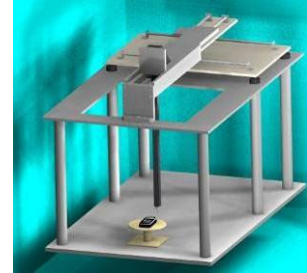

Figure 4-3
RF Near-Field Scanner

III. ITU-T P.50 Artificial Voice

Manufacturer:	ITU-T
Active Frequency Range:	100 Hz – 8 kHz
Stimulus Type:	Male and Female, no spaces
Single Sample Duration:	20.96 seconds
Activity Level:	100%

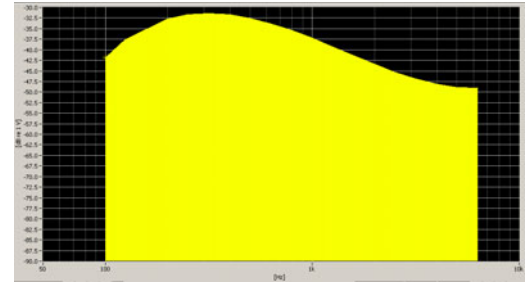

Figure 4-4
Spectral Characteristic of full P.50

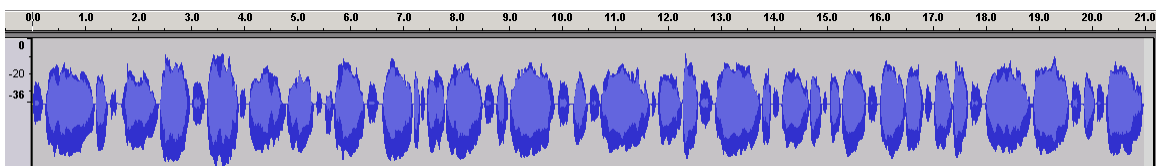



Figure 4-5
Temporal Characteristic of full P.50

FCC ID: ZNFV450PM		HAC (T-COIL) TEST REPORT		Approved by: Quality Manager
Filename: 1M1811230205-13-R4.ZNF	Test Dates: 01/07/2019 - 01/22/2019	DUT Type: Portable Handset	Page 9 of 90	

© 2019 PCTEST Engineering Laboratory, Inc.

REV 3.2.M
04/17/2018

© 2019 PCTEST Engineering Laboratory, Inc. All rights reserved. Unless otherwise specified, no part of this report may be reproduced or utilized in any part, form or by any means, electronic or mechanical, including photocopying and microfilm, without permission in writing from PCTEST Engineering Laboratory, Inc. If you have any questions about this international copyright or have an enquiry about obtaining additional rights to this report or assembly of contents thereof, please contact INFO@PCTEST.COM.

ABM1 Measurement Block Diagram:

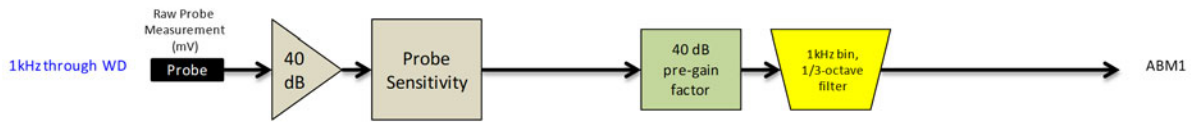

ABM2 Measurement Block Diagram:

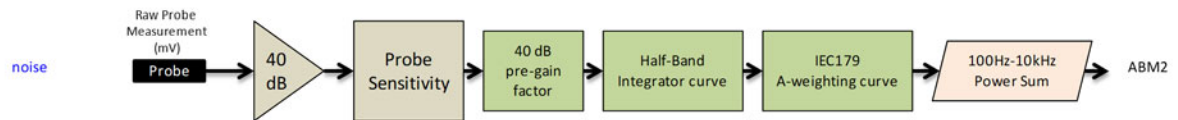

Figure 4-6 Magnetic Measurement Processing Steps

IV. Test Procedure

1. Ambient Noise Check per C63.19 §7.3.1
 - a. Ambient interference was monitored using a Real-Time Analyzer between 100-10,000 Hz with 1/3 octave filtering.
 - b. “A-weighting” and Half-Band Integration was applied to the measurements.
 - c. Since this measurement was measured in the same method as ABM2 measurements, this level was verified to be more than 10 dB below the lowest measurement signal (which is the highest ABM2 measurement for a T4 WD). Therefore the maximum noise level for a T4 WD with an ABM1 = -18 dBA/m is:

$$-18 - 30 - 10 = -58 \text{ dBA/m}$$
2. Measurement System Validation(See Figure 4-1)
 - a. The measurement system including the probe, pre-amplifier and acquisition system were validated as an entire system to ensure the reliability of test measurements.
 - b. ABM1 Validation
 The magnetic field at the center of the Helmholtz coil is given by the equation (per C63.19 Annex D.10.1):

$$H_c = \frac{NI}{r\sqrt{1.25^3}} = \frac{N\left(\frac{V}{R}\right)}{r\sqrt{1.25^3}}$$

Where H_c = magnetic field strength in amperes per meter

N = number of turns per coil

For the Helmholtz Coil, $N=20$; $r=0.13\text{m}$; $R=10.193\Omega$ and using $V=29\text{mV}$:

$$H_c = \frac{20 \cdot \left(\frac{0.029}{10.193}\right)}{0.13 \cdot \sqrt{1.25^3}} = 0.316 \text{ A/m} \approx -10 \text{ dB(A/m)}$$

Therefore a pure tone of 1kHz was applied into the coils such that 29mV was observed across the resistor. The voltmeter used for measurement was verified to be capable of measurements in the audio band range. This theoretically generates an expected field of -10 dB(A/m) in the center of the Helmholtz coil which was used to validate the probe measurement at -10dB(A/m). This was verified to be within ± 0.5 dB of the -10dB(A/m) value (see Page 41).

FCC ID: ZNFV450PM		HAC (T-COIL) TEST REPORT		Approved by: Quality Manager
Filename: 1M1811230205-13-R4.ZNF	Test Dates: 01/07/2019 - 01/22/2019	DUT Type: Portable Handset		Page 10 of 90

c. Frequency Response Validation

The frequency response through the Helmholtz Coil was verified to be within 0.5 dB relative to 1kHz, between 300 – 3000 Hz using the P.50 signal as shown below:

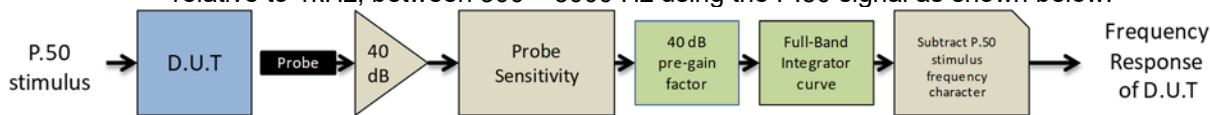

Figure 4-7 Frequency Response Validation

d. ABM2 Measurement Validation

WD noise measurements are filtered with A-weighting and Half-Band Integration over a frequency range of 100Hz – 10kHz to process ABM2 measurements. Below is the verification of the system processing A-weighting and Half-Band integration between system input to output within 0.5 dB of the theoretical result:

Table 4-1
ABM2 Frequency Response Validation

f (Hz)	HBI, A - Measured (dB re 1kHz)	HBI, A - Theoretical (dB re 1kHz)	dB Var.
100	-16.180	-16.170	-0.010
125	-13.257	-13.250	-0.007
160	-10.347	-10.340	-0.007
200	-8.017	-8.010	-0.007
250	-5.925	-5.920	-0.005
315	-4.045	-4.040	-0.005
400	-2.405	-2.400	-0.005
500	-1.212	-1.210	-0.002
630	-0.349	-0.350	0.001
800	0.071	0.070	0.001
1000	0.000	0.000	0.000
1250	-0.503	-0.500	-0.003
1600	-1.513	-1.510	-0.003
2000	-2.778	-2.780	0.002
2500	-4.316	-4.320	0.004
3150	-6.166	-6.170	0.004
4000	-8.322	-8.330	0.008
5000	-10.573	-10.590	0.017
6300	-13.178	-13.200	0.022
8000	-16.241	-16.270	0.029
10000	-19.495	-19.520	0.025

FCC ID: ZNFV450PM	PCTEST ENGINEERING LABORATORY, INC.	HAC (T-COIL) TEST REPORT	LG	Approved by: Quality Manager
Filename: 1M1811230205-13-R4.ZNF	Test Dates: 01/07/2019 - 01/22/2019	DUT Type: Portable Handset		Page 11 of 90

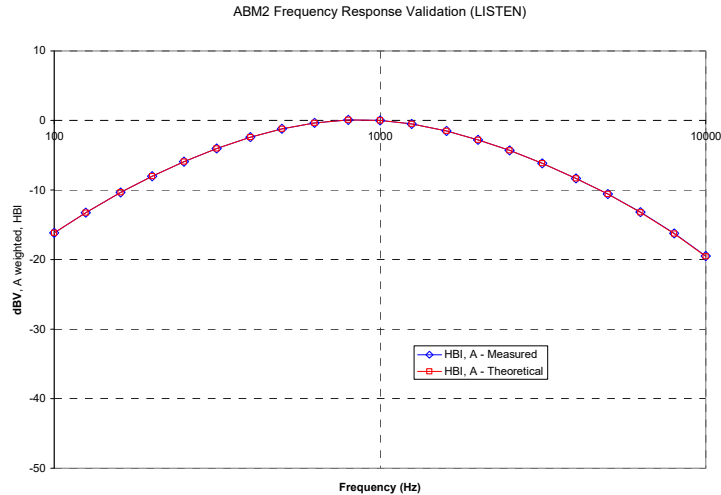

Figure 4-8
ABM2 Frequency Response Validation

The ABM2 result is a power sum from 100Hz to 10kHz with half-band integration and A-weighting. To verify the power sum measurement, a power sum over the full band was measured and verified to track with the source level (See Figure 4-9). Therefore the setup in this step was used to verify the power sum post-processing for ABM2 measurements. See below block diagram:

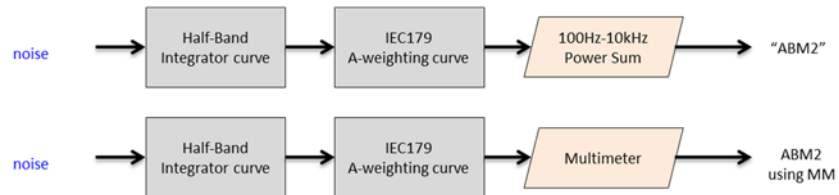

Figure 4-9
ABM2 Validation Block Diagram

The power summed output results for a known input were compared to the multi-meter results to verify any deviation in the post-processing implemented with the power-sum.

Table 4-2
ABM2 Power Sum Validation

WN Input (dBV)	Power Sum (dBV)	Multimeter-Full (dBV)	Dev (dB)
-60	-60.36	-60.2	0.16
-50	-50.19	-50.13	0.06
-40	-40.14	-40.03	0.11
-30	-30.13	-30.01	0.12
-20	-20.12	-20	0.12
-10	-10.14	-10	0.14

FCC ID: ZNFV450PM	PCTEST ENGINEERING LABORATORY, INC.	HAC (T-COIL) TEST REPORT	LG	Approved by: Quality Manager
Filename: 1M1811230205-13-R4.ZNF	Test Dates: 01/07/2019 - 01/22/2019	DUT Type: Portable Handset		Page 12 of 90

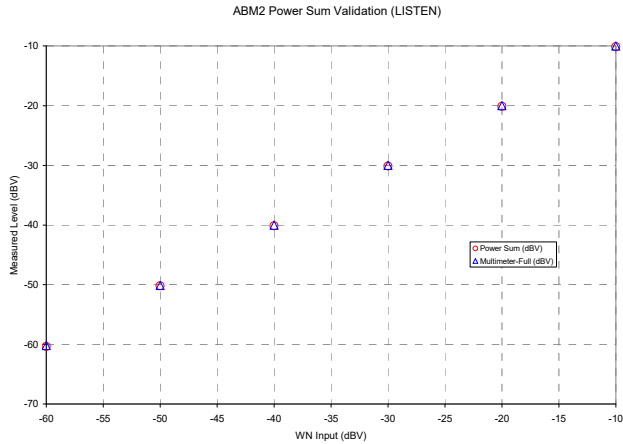

Figure 4-10
ABM2 Power Sum Validation

3. Measurement Test Setup

a. Fine scan above the WD (TEM)

- i. A multitone signal was applied to the handset such that the phone acoustic output was stable within 1dB over the probe settling time and with the acoustic output level at the C63.19 specified levels (below). The measurement step size was in 2 mm increments at a distance of 10 mm between the surface of the wireless device as shown below (note that in Figure 4-12, the grid is not to scale but merely a graphical representation of the coordinate system in use):

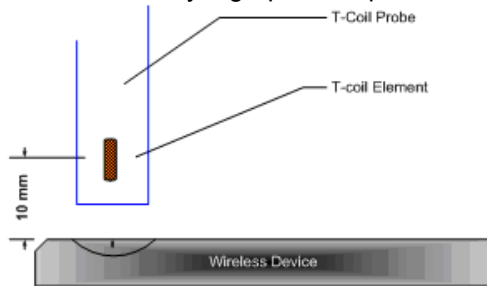

Figure 4-11
Measurement Distance

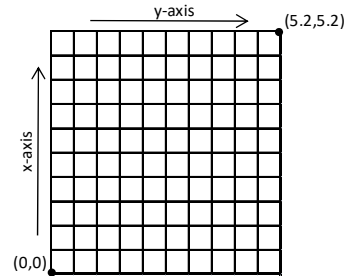





Figure 4-12
Measurement Grid

- ii. After scanning, the planar field maximum point was determined. The position of the probe was moved to this location to setup the test using the SoundCheck system.
 - iii. These steps were repeated for all T-coil orientations (axial and radial) per Figure 4-14 after a T-coil orientation was fully measured with the SoundCheck system.
- b. Speech Signal Setup to Base Station Simulator
- i. C63.19 Table 7-1 states audio reference input levels for various technologies:

Standard	Technology	Input Level (dBm0)
TIA/EIA/IS-2000	CDMA	-18
J-STD-007	GSM (217)	-16
T1/T1P1/3GPP	UMTS (WCDMA)	-16
IDEN™	TDMA (22 and 11 Hz)	-18

FCC ID: ZNFV450PM	 PCTEST ENGINEERING LABORATORY, INC.	HAC (T-COIL) TEST REPORT	 LG	Approved by: Quality Manager
Filename: 1M1811230205-13-R4.ZNF	Test Dates: 01/07/2019 - 01/22/2019	DUT Type: Portable Handset		Page 13 of 90

- ii. See Section 5 and 6 for more information regarding CMW500 audio level settings for Voice Over LTE (VoLTE), and Voice Over WIFI (VoWIFI) testing.
 - iii. See Section 7 for more information regarding audio level settings for Over-The-Top (OTT) Voice Over IP (VoIP) Testing.
 - c. Real-Time Analyzer (RTA)
 - i. The Real-Time Analyzer was configured to analyze measurements using 1/3 Octave band weighted filtering.
 - d. WD Radio Configuration Selection
 - i. The device was chosen to be tested in the worst-case ABM2 condition (See Section 8 for more information regarding worst-case configurations for CDMA and UMTS. LTE configuration information can be found in Section 5. WIFI configuration information can be found in Section 6 and 7.)
 - ii. Supported GSM vocoders were investigated for the worst-case ABM2 condition. GSM-EFR was deemed the worst-case condition for the GSM air interface.
- 4. Signal Quality Data Analysis
 - a. Narrow-band Magnetic Intensity
 - i. The standard specifies a 1kHz 1/3 octave band minimum field intensity for a sine tone. The ABM1 measurements were evaluated at 1kHz with 1/3 octave band filtering over an averaged period of 10 seconds.
 - b. Frequency Response
 - i. The appropriate frequency response curve was measured to curves in Figure 3-1 or Figure 3-2 between 300 – 3000 Hz using digital linear averaging (limit lines chosen according to measurement found in step 4a). A linear average over 3x the length of the artificial voice signal (3x sampling) was performed. A 10 second delay was configured in the measurement process of the stimulus to ensure handset vocoder latency effects and echo cancellation devices (if any) were appropriately stabilized during measurements.
 - ii. The appropriate post-processing was applied according to the system processing chain illustrated in Figure 4-7. All R10 frequencies were plotted with respect to 0dB at 1kHz value and aligned with respect to the EIA-504 mask.
 - iii. The margin is represented by the closest measured data point on the curve to the EIA-504 limit lines, in dB.

FCC ID: ZNFV450PM		HAC (T-COIL) TEST REPORT		Approved by: Quality Manager
Filename: 1M1811230205-13-R4.ZNF	Test Dates: 01/07/2019 - 01/22/2019	DUT Type: Portable Handset	Page 14 of 90	

c. Signal Quality Index

- i. Ensuring the WD was at maximum RF power, maximum volume, backlight off, display on, maximum contrast setting, keypad lights on (when possible) with no audio signal through the vocoder, the WD was measured over at least 100 Hz – 10,000 Hz, maximized over 5 seconds with a 50ms sample time for the ABM2 measurement (5 second time period is used in noise measurements under standards such as IEEE 269, etc.).
- ii. After applying half-band integration and A-weighting to the result, a power sum was applied over each 1/3 octave bandwidth frequency for an ABM2 value.
- iii. This result was subtracted from the ABM1 result in step a, to obtain the Signal Quality.

V. Test Setup

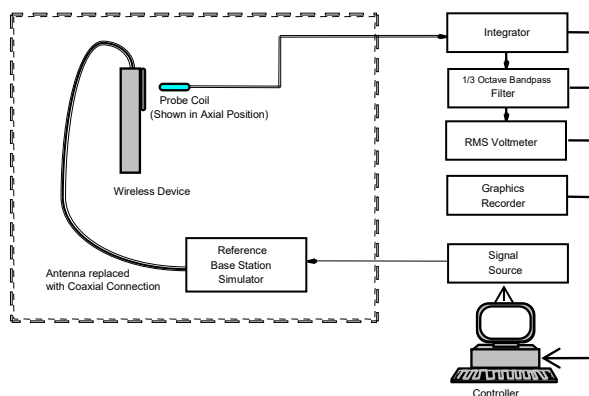



Figure 4-13
Audio Magnetic Field Test Setup

VI. Deviation from C63.19 Test Procedure

Non-conducted RF connection due to inaccessible RF ports.

VII. Air Interface Technologies Tested

All air interfaces which support voice capabilities over a managed CMRS or pre-installed OTT VoIP applications were tested for T-coil unless otherwise noted. See Table 2-1 for more details regarding which modes were tested.

FCC ID: ZNFV450PM		HAC (T-COIL) TEST REPORT		Approved by: Quality Manager
Filename: 1M1811230205-13-R4.ZNF	Test Dates: 01/07/2019 - 01/22/2019	DUT Type: Portable Handset		Page 15 of 90

VIII. Wireless Device Channels and Frequencies

1. 2G/3G Modes

The frequencies listed in the table below are those that lie in the center of the bands used for cellular telephony. Low, middle and high channels were tested in each band for FCC compliance evaluation to ensure the maximum emission is captured across the entire band. Only middle channels were evaluated for data modes.

**Table 4-3
Center Channels and Frequencies**

Test frequencies & associated channels	
Channel	Frequency (MHz)
Secondary Cellular 820	
564 (CDMA)	820.10
Cellular 850	
384 (CDMA)	836.52
190 (GSM)	836.60
4183 (UMTS)	836.60
AWS 1750	
1412 (UMTS)	1730.40
PCS 1900	
600 (CDMA)	1880
661 (GSM)	1880
9400 (UMTS)	1880

2. 4G (LTE) Modes



The middle channel for every band and bandwidth combination was tested for each probe orientation. The band and bandwidth combination from each probe orientation resulting in the worst-case SNNR was additionally tested using low and high channels for that band and bandwidth combination. Low-mid and mid-high channels are additionally tested for LTE TDD B41. The middle channel and supported bandwidths from the worst-case bands according to Tables 7-6 and 7-7 were additionally evaluated with OTT VoIP for each probe orientation. See Tables 9-5 to 9-12 as well as 9-20 to 9-21 for LTE bandwidths and channels.

3. 5G (NR) Modes

The middle channel for every band and bandwidth combination was tested for each probe orientation for OTT VoIP. The band and bandwidth combination from each probe orientation resulting in the worst-case SNNR was additionally tested using low and high channels for that band and bandwidth combination. Low-mid and mid-high channels are additionally tested for NR Band n41. See Table 9-22 for NR Band n41 bandwidths and channels.

4. WIFI

The middle channel for each 802.11 standard was tested for each probe orientation. The 2.4GHz 802.11 standard from each probe orientation resulting in the worst-case SNNR was additionally tested using low and high channels. The 5GHz 802.11 standard from each probe orientation resulting in the worst-case SNNR was additionally tested on higher U-NII bands as well as applicable low and high channels. See Tables 9-13 to 9-16 as well as 9-23 to 9-26 for WIFI standards and channels.

FCC ID: ZNFV450PM		HAC (T-COIL) TEST REPORT		Approved by: Quality Manager
Filename: 1M1811230205-13-R4.ZNF	Test Dates: 01/07/2019 - 01/22/2019	DUT Type: Portable Handset		Page 16 of 90

IX. Test Flow

The flow diagram below was followed (From C63.19):

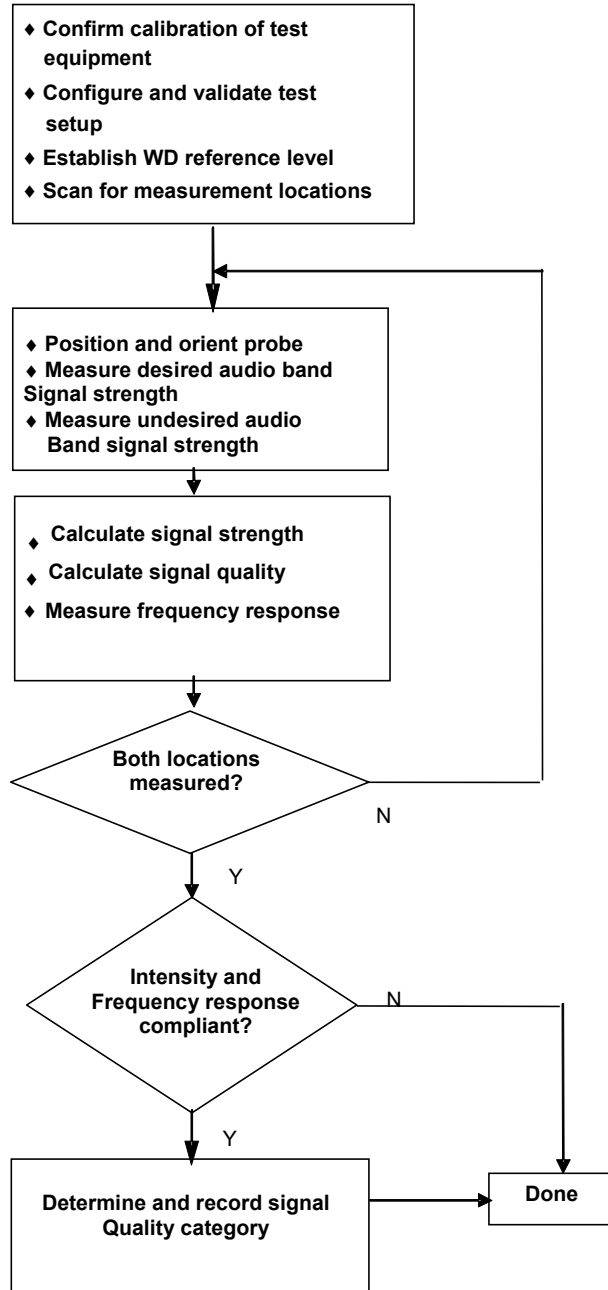



Figure 4-14
C63.19 T-Coil Signal Test Process

FCC ID: ZNFV450PM	 PCTEST ENGINEERING LABORATORY, INC.	HAC (T-COIL) TEST REPORT	 LG	Approved by: Quality Manager
Filename: 1M1811230205-13-R4.ZNF	Test Dates: 01/07/2019 - 01/22/2019	DUT Type: Portable Handset		Page 17 of 90

© 2019 PCTEST Engineering Laboratory, Inc.

REV 3.2.M

04/17/2018

© 2019 PCTEST Engineering Laboratory, Inc. All rights reserved. Unless otherwise specified, no part of this report may be reproduced or utilized in any part, form or by any means, electronic or mechanical, including photocopying and microfilm, without permission in writing from PCTEST Engineering Laboratory, Inc. If you have any questions about this international copyright or have an enquiry about obtaining additional rights to this report or assembly of contents thereof, please contact INFO@PCTEST.COM.

5. VOLTE TEST SYSTEM SETUP AND DUT CONFIGURATION

I. Test System Setup for VoLTE over IMS T-coil Testing

1. Equipment Setup

The general test setup used for VoLTE over IMS is shown below. The callbox used when performing VoLTE over IMS T-coil measurements is a CMW500. The Data Application Unit (DAU) of the CMW500 was used to simulate the IP Multimedia Subsystem (IMS) server.

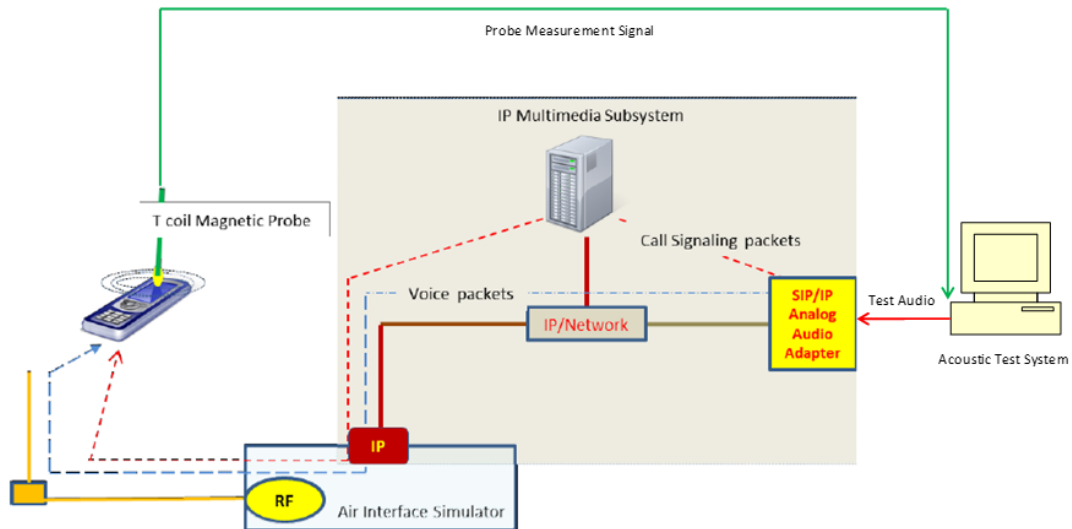



Figure 5-1
Test Setup for VoLTE over IMS T-Coil Measurements

2. Audio Level Settings

According to the July 2012 interpretations by the C63 Committee regarding the appropriate audio levels to be used for VoLTE over IMS T-coil testing, -16dBm0 shall be used for the normal speech input level*. The CMW500 base station simulator was manually configured to ensure that the settings for speech input and full scale levels resulted in the -16dBm0 speech input level to the DUT for the VoLTE over IMS connection.

* http://c63.org/documents/misc/posting/new_interpretations.htm

FCC ID: ZNFV450PM		HAC (T-COIL) TEST REPORT		Approved by: Quality Manager
Filename: 1M1811230205-13-R4.ZNF	Test Dates: 01/07/2019 - 01/22/2019	DUT Type: Portable Handset		Page 18 of 90

© 2019 PCTEST Engineering Laboratory, Inc.

REV 3.2.M

04/17/2018

© 2019 PCTEST Engineering Laboratory, Inc. All rights reserved. Unless otherwise specified, no part of this report may be reproduced or utilized in any part, form or by any means, electronic or mechanical, including photocopying and microfilm, without permission in writing from PCTEST Engineering Laboratory, Inc. If you have any questions about this international copyright or have an enquiry about obtaining additional rights to this report or assembly of contents thereof, please contact INFO@PCTEST.COM.

II. DUT Configuration for VoLTE over IMS T-coil Testing

1. Radio Configuration

An investigation was performed to determine the modulation and RB configuration to be used for testing. 16QAM, 1RB, 0RB offset was used for the testing as the worst-case configuration for the handset. See below table for SNNR comparison between different radio configurations:

Table 5-1
VoLTE over IMS SNNR by Radio Configuration

Frequency [MHz]	Channel	Bandwidth [MHz]	Modulation	RB Size	RB Offset	ABM1 [dB(A/m)]	ABM2 [dB(A/m)]	SNNR [dB]
1745.0	132322	20	QPSK	1	0	2.93	-44.77	47.70
1745.0	132322	20	QPSK	1	50	2.98	-45.17	48.15
1745.0	132322	20	QPSK	1	99	2.50	-45.00	47.50
1745.0	132322	20	QPSK	50	0	2.94	-47.70	50.64
1745.0	132322	20	QPSK	50	25	3.00	-47.03	50.03
1745.0	132322	20	QPSK	50	50	2.98	-47.86	50.84
1745.0	132322	20	QPSK	100	0	2.92	-46.63	49.55
1745.0	132322	20	16QAM	1	0	2.80	-39.02	41.82
1745.0	132322	20	16QAM	1	50	2.88	-39.41	42.29
1745.0	132322	20	16QAM	1	99	2.75	-40.52	43.27
1745.0	132322	20	16QAM	50	0	3.16	-47.76	50.92
1745.0	132322	20	16QAM	50	25	2.94	-46.28	49.22
1745.0	132322	20	16QAM	50	50	2.91	-47.07	49.98
1745.0	132322	20	16QAM	100	0	2.88	-47.16	50.04
1745.0	132322	20	64QAM	1	0	3.19	-40.06	43.25
1745.0	132322	20	64QAM	1	50	2.87	-41.57	44.44
1745.0	132322	20	64QAM	1	99	3.06	-41.72	44.78
1745.0	132322	20	64QAM	50	0	2.67	-46.94	49.61
1745.0	132322	20	64QAM	50	25	2.96	-47.28	50.24
1745.0	132322	20	64QAM	50	50	2.96	-47.20	50.16
1745.0	132322	20	64QAM	100	0	2.86	-47.51	50.37

2. Codec Configuration

An investigation was performed to determine the audio codec configuration to be used for testing. The WB AMR 6.60kbps setting was used for the audio codec on the CMW500 for VoLTE over IMS T-coil testing. See below table for comparisons between different codecs and codec data rates:

Table 5-2
AMR Codec Investigation – VoLTE over IMS

Codec Setting:	WB AMR 23.85kbps	WB AMR 6.60kbps	NB AMR 12.2kbps	NB AMR 4.75kbps	Orientation	Band / BW	Channel
ABM1 (dBA/m)	3.57	2.86	3.83	3.83	Axial	Band 66 20MHz	132322
ABM2 (dBA/m)	-38.53	-38.37	-38.77	-38.61			
Frequency Response	Pass	Pass	Pass	Pass			
S+N/N (dB)	42.10	41.23	42.60	42.44			



FCC ID: ZNFV450PM	 PCTEST ENGINEERING LABORATORY, INC.	HAC (T-COIL) TEST REPORT	 LG	Approved by: Quality Manager
Filename: 1M1811230205-13-R4.ZNF	Test Dates: 01/07/2019 - 01/22/2019	DUT Type: Portable Handset		Page 19 of 90

Table 5-3
EVS Codec Investigation - VoLTE over IMS

Codec Setting:	EVS Primary SWB 24.4kbps	EVS Primary SWB 9.6kbps	EVS Primary WB 24.4kbps	EVS Primary WB 9.6kbps	Orientation	Band / BW	Channel
ABM1 (dBA/m)	2.69	3.20	2.62	3.15	Axial	Band 66 20MHz	132322
ABM2 (dBA/m)	-38.79	-38.52	-38.98	-38.49			
Frequency Response	Pass	Pass	Pass	Pass			
S+N/N (dB)	41.48	41.72	41.60	41.64			

- Mute on; Backlight off; Max Volume; Max Contrast
- TPC = "Max Power"

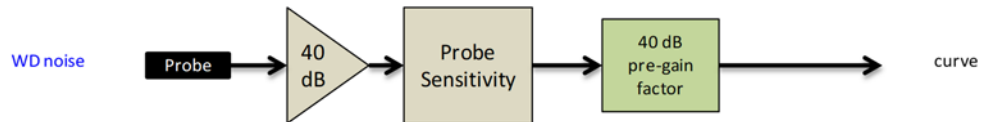

Figure 5-2
Audio Band Magnetic Curve Measurement Block Diagram

3. LTE TDD Uplink-Downlink Configuration Investigation for VoLTE over IMS

An investigation was performed to determine the worst-case Uplink-Downlink configuration for VoLTE over IMS T-Coil testing.

Per 3GPP TS 36.211, the total frame length for each TDD radio frame of length $T_f = 307200 \cdot T_s$ = 10 ms, where T_s is a number of time units equal to $1/(15000 \times 2048)$ seconds. Additionally, each radio frame consists of 10 subframes, each of length $30720 \cdot T_s = 1$ ms, and subframes can be designated as uplink (U), downlink (D), or special subframe (S), depending on the Uplink-Downlink configuration as indicated in Table 4.2-2 of 3GPP TS 36.211. In the transmission duty factor calculation, the special subframe configuration with the shortest UpPTS duration within the special subframe is used and will be applied for measurement. From 3GPP TS 36.211 Table 4.2-1, the shortest UpPTS is $2192 \cdot T_s$ which occurs in the normal cyclic prefix and special subframe configuration 4.

See table below outlining the calculated transmission duty cycles for each Uplink-Downlink configuration:

Table 5-4
Uplink-Downlink Configurations for Type 2 Frame Structures

Uplink-downlink configuration	Downlink-to-Uplink Switch-point periodicity	Subframe number										Calculated Transmission Duty Cycle (%)
		0	1	2	3	4	5	6	7	8	9	
0	5 ms	D	S	U	U	U	D	S	U	U	U	61.4%
1	5 ms	D	S	U	U	D	D	S	U	U	D	41.4%
2	5 ms	D	S	U	D	D	D	S	U	D	D	21.4%
3	10 ms	D	S	U	U	U	D	D	D	D	D	30.7%
4	10 ms	D	S	U	U	D	D	D	D	D	D	20.7%
5	10 ms	D	S	U	D	D	D	D	D	D	D	10.7%
6	5 ms	D	S	U	U	U	D	S	U	U	D	51.4%

FCC ID: ZNFV450PM		HAC (T-COIL) TEST REPORT		Approved by: Quality Manager
Filename: 1M1811230205-13-R4.ZNF	Test Dates: 01/07/2019 - 01/22/2019	DUT Type: Portable Handset		Page 20 of 90

a. Power Class 3 Uplink-Downlink Configuration Investigation

Power class 3 was evaluated with the following radio configuration: channel 40620, 20MHz BW, 16QAM, 1RB, 0RB Offset. For Power Class 3, all configurations (0-6) are supported. The configuration which resulted in the worst SNNR was used for full testing. Uplink-Downlink configuration 6 was used as the worst-case configuration for Power Class 3 VoLTE over IMS T-Coil testing. See table below for the SNNR comparison between each Uplink-Downlink configuration:

**Table 5-5
Power Class 3 VoLTE over IMS SNNR by UL-DL Configuration**

Frequency [MHz]	Channel	Bandwidth [MHz]	Modulation	RB Size	RB Offset	UL-DL Configuration	ABM1 [dB(A/m)]	ABM2 [dB(A/m)]	SNNR [dB]
2593.0	40620	20	16QAM	1	0	0	7.31	-36.49	43.80
2593.0	40620	20	16QAM	1	0	1	6.88	-36.90	43.78
2593.0	40620	20	16QAM	1	0	2	7.28	-37.10	44.38
2593.0	40620	20	16QAM	1	0	3	7.15	-39.07	46.22
2593.0	40620	20	16QAM	1	0	4	7.03	-39.63	46.66
2593.0	40620	20	16QAM	1	0	5	7.10	-39.47	46.57
2593.0	40620	20	16QAM	1	0	6	7.28	-35.90	43.18

b. Power Class 2 Uplink-Downlink Configuration Investigation

Power Class 2 was evaluated with the following radio configuration: channel 40620, 20MHz BW, 16QAM, 1RB, 0RB Offset. For Power Class 2, configurations 1-5 are supported. The configuration which resulted in the worst SNNR was used for full testing. Uplink-Downlink configuration 1 was used as the worst-case configuration for Power Class 2 VoLTE over IMS T-Coil testing. See table below for the SNNR comparison between each Uplink-Downlink configuration:



**Table 5-6
Power Class 2 VoLTE over IMS SNNR by UL-DL Configuration**

Frequency [MHz]	Channel	Bandwidth [MHz]	Modulation	RB Size	RB Offset	UL-DL Configuration	ABM1 [dB(A/m)]	ABM2 [dB(A/m)]	SNNR [dB]
2593.0	40620	20	16QAM	1	0	1	7.16	-35.33	42.49
2593.0	40620	20	16QAM	1	0	2	6.98	-36.32	43.30
2593.0	40620	20	16QAM	1	0	3	6.93	-38.17	45.10
2593.0	40620	20	16QAM	1	0	4	6.89	-37.38	44.27
2593.0	40620	20	16QAM	1	0	5	6.87	-39.03	45.90

Note: LTE TDD B41 Power Class 2 only supports UL-DL configurations 1-5, not 0 or 6.

c. Conclusion

Per the investigations above, UL-DL Configuration 6 was used to evaluate Power Class 3 VoLTE over IMS and UL-DL Configuration 1 was used to evaluate Power Class 2 VoLTE over IMS.

FCC ID: ZNFV450PM	 PCTEST ENGINEERING LABORATORY, INC.	HAC (T-COIL) TEST REPORT		Approved by: Quality Manager
Filename: 1M1811230205-13-R4.ZNF	Test Dates: 01/07/2019 - 01/22/2019	DUT Type: Portable Handset		Page 21 of 90

6. VOWIFI TEST SYSTEM SETUP AND DUT CONFIGURATION

I. Test System Setup for VoWIFI over IMS T-coil Testing

1. Equipment Setup

The general test setup used for VoWIFI over IMS, or CMRS WIFI Calling, is shown below. The callbox used when performing VoWIFI over IMS T-coil measurements is a CMW500. The Data Application Unit (DAU) of the CMW500 was used to simulate the IP Multimedia Subsystem (IMS) server.

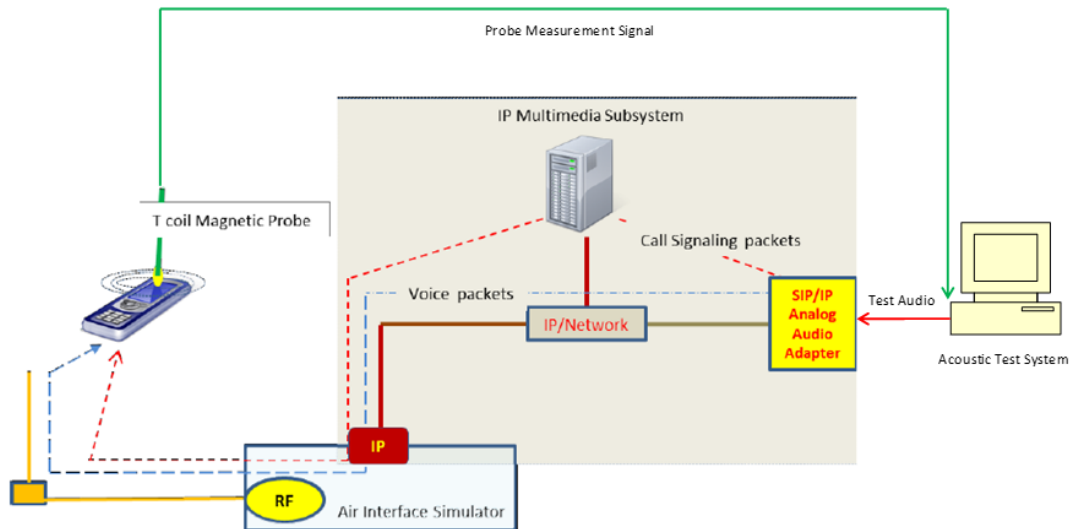



Figure 6-1
Test Setup for VoWIFI over IMS T-Coil Measurements

2. Audio Level Settings

According to KDB 285076 D02 released by the FCC OET regarding the appropriate audio levels to be used for VoWIFI over IMS T-Coil testing, -20dBm_0 shall be used for the normal speech input level². The CMW500 base station simulator was manually configured to ensure that the settings for speech input and full scale levels resulted in the -20dBm_0 speech input level to the DUT for the VoWIFI over IMS connection.

² FCC Office of Engineering and Technology KDB, "285076 D02 T-Coil Testing for CMRS IP v03," September 13, 2017

FCC ID: ZNFV450PM		HAC (T-COIL) TEST REPORT		Approved by: Quality Manager
Filename: 1M1811230205-13-R4.ZNF	Test Dates: 01/07/2019 - 01/22/2019	DUT Type: Portable Handset		Page 22 of 90

II. DUT Configuration for VoWiFi over IMS T-coil Testing

1. Radio Configuration

An investigation was performed on all applicable data rates and modulations to determine the radio configuration to be used for testing. See tables below for SNNR comparison between radio configurations in each 802.11 standard:

Table 6-1
802.11b SNNR by Radio Configuration

Mode	Channel	Modulation	Data Rate [Mbps]	ABM1 [dB(A/m)]	ABM2 [dB(A/m)]	SNNR [dB]
802.11b	6	DSSS	1	0.00	-36.08	36.08
802.11b	6	DSSS	2	-0.25	-35.58	35.33
802.11b	6	CCK	5.5	-0.17	-35.12	34.95
802.11b	6	CCK	11	-0.34	-35.33	34.99

Table 6-2
802.11g/a SNNR by Radio Configuration

Mode	Channel	Modulation	Data Rate [Mbps]	ABM1 [dB(A/m)]	ABM2 [dB(A/m)]	SNNR [dB]
802.11g	6	BPSK	6	0.03	-36.59	36.62
802.11g	6	BPSK	9	0.00	-36.49	36.49
802.11g	6	QPSK	12	-0.33	-38.83	38.50
802.11g	6	QPSK	18	-0.35	-40.55	40.20
802.11g	6	16-QAM	24	-0.33	-40.44	40.11
802.11g	6	16-QAM	36	0.18	-42.40	42.58
802.11g	6	64-QAM	48	-0.35	-42.92	42.57
802.11g	6	64-QAM	54	0.21	-44.01	44.22

Table 6-3
802.11n/ac 20MHz BW SNNR by Radio Configuration

Mode	Bandwidth [MHz]	Channel	Modulation	Data Rate [Mbps]	ABM1 [dB(A/m)]	ABM2 [dB(A/m)]	SNNR [dB]
802.11n	20	40	BPSK	6.5	0.25	-42.40	42.65
802.11n	20	40	QPSK	13	-0.13	-44.17	44.04
802.11n	20	40	QPSK	19.5	-0.27	-44.33	44.06
802.11n	20	40	16-QAM	26	-0.26	-45.88	45.62
802.11n	20	40	16-QAM	39	-0.36	-46.26	45.90
802.11n	20	40	64-QAM	52	-0.36	-43.73	43.37
802.11n	20	40	64-QAM	58.5	-0.36	-44.71	44.35
802.11n	20	40	64-QAM	65	0.25	-44.30	44.55
802.11ac	20	40	256-QAM	78	-0.32	-45.69	45.37



FCC ID: ZNFV450PM		HAC (T-COIL) TEST REPORT		Approved by: Quality Manager
Filename: 1M1811230205-13-R4.ZNF	Test Dates: 01/07/2019 - 01/22/2019	DUT Type: Portable Handset		Page 23 of 90

Table 6-4
802.11n/ac 40MHz BW SNNR by Radio Configuration

Mode	Bandwidth [MHz]	Channel	Modulation	Data Rate [Mbps]	ABM1 [dB(A/m)]	ABM2 [dB(A/m)]	SNNR [dB]
802.11n	40	38	BPSK	13.5	-0.36	-41.66	41.30
802.11n	40	38	QPSK	27	-0.44	-44.40	43.96
802.11n	40	38	QPSK	40.5	0.08	-45.67	45.75
802.11n	40	38	16-QAM	54	0.00	-43.80	43.80
802.11n	40	38	16-QAM	81	0.03	-45.07	45.10
802.11n	40	38	64-QAM	108	0.03	-46.08	46.11
802.11n	40	38	64-QAM	121.5	-0.43	-44.96	44.53
802.11n	40	38	64-QAM	135	0.02	-45.57	45.59
802.11ac	40	38	256-QAM	162	-0.51	-44.60	44.09
802.11ac	40	38	256-QAM	180	-0.53	-45.20	44.67

2. Codec Configuration

An investigation was performed to determine the audio codec configuration to be used for testing. The WB AMR 6.60kbps setting was used for the audio codec on the CMW500 for VoWiFi over IMS T-coil testing. See below table for comparisons between different codecs and codec data rates:

Table 6-5
AMR Codec Investigation – VoWiFi over IMS

Codec Setting:	WB AMR 23.85kbps	WB AMR 6.60kbps	NB AMR 12.2kbps	NB AMR 4.75kbps	Orientation	Band	Standard	Channel
ABM1 (dBA/m)	0.94	0.01	1.32	1.21	Axial	2.4GHz	IEEE 802.11b	6
ABM2 (dBA/m)	-36.37	-36.17	-36.16	-35.90				
Frequency Response	Pass	Pass	Pass	Pass				
S+N/N (dB)	37.31	36.18	37.48	37.11				

Table 6-6
EVS Codec Investigation – VoWiFi over IMS

Codec Setting:	EVS Primary SWB 24.4kbps	EVS Primary SWB 9.6kbps	EVS Primary WB 24.4kbps	EVS Primary WB 9.6kbps	Orientation	Band	Standard	Channel
ABM1 (dBA/m)	-0.07	-0.12	-0.30	-0.29	Axial	2.4GHz	IEEE 802.11b	6
ABM2 (dBA/m)	-41.27	-40.69	-40.86	-39.31				
Frequency Response	Pass	Pass	Pass	Pass				
S+N/N (dB)	41.20	40.57	40.56	39.02				

- Mute on; Backlight off; Max Volume; Max Contrast

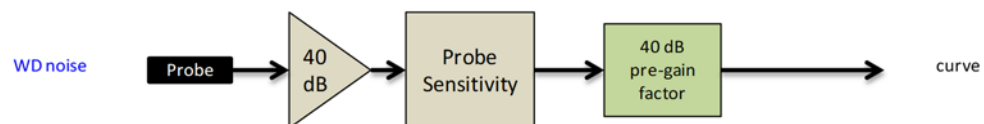

Figure 6-2
Audio Band Magnetic Curve Measurement Block Diagram

FCC ID: ZNFV450PM		HAC (T-COIL) TEST REPORT		Approved by: Quality Manager
Filename: 1M1811230205-13-R4.ZNF	Test Dates: 01/07/2019 - 01/22/2019	DUT Type: Portable Handset		Page 24 of 90

7. OTT VOIP TEST SYSTEM AND DUT CONFIGURATION

I. Test System Setup for OTT VoIP T-Coil Testing

1. OTT VoIP Application

Google Duo is a pre-installed application on the DUT which allows for VoIP calls in a held-to-ear scenario. Duo uses the OPUS audio codec and supports a bitrate range of 6kb/s to 64kb/s. All air interfaces capable of a data connection were evaluated with Google Duo.

2. Equipment Setup

A CMW500 callbox was used to perform OTT VoIP T-coil measurements. The Data Application Unit (DAU) of the CMW500 was connected to the internet and allowed for an IP data connection on the DUT. An auxiliary VoIP unit was used to initiate an OTT VoIP call to the DUT. The auxiliary VoIP unit allowed for the configuration and monitoring of the OTT VoIP codec bitrate during a call. Both high and low bitrate settings were evaluated in to determine the worst-case configuration.

3. Audio Level Settings

According to KDB 285076 D02, the average speech level of -20dBm0 shall be used for protocols not specifically listed in Table 7.1 of ANSI C63.19-2011 or the ANSI C63.19-2011 VoLTE interpretation³. The auxiliary VoIP unit allowed for monitoring the signal input level to ensure that the settings for speech input and full scale levels resulted in the -20dBm0 speech input level to the DUT for the OTT VoIP call.

II. DUT Configuration for OTT VoIP T-Coil Testing



1. Codec Configuration

An investigation was performed for each applicable data mode to determine the audio codec configuration to be used for testing. The 64kbps codec setting was used for the audio codec on the auxiliary VoIP unit for OTT VoIP T-Coil testing. See below tables for comparisons between codec data rates on all applicable data modes:

**Table 7-1
Codec Investigation – OTT VoIP (EvDO)**

Codec Setting:	64kbps	6kbps	Orientation	Channel
ABM1 (dBA/m)	15.14	15.13	Axial	600
ABM2 (dBA/m)	-50.11	-52.13		
Frequency Response	Pass	Pass		
S+N/N (dB)	65.25	67.26		

³ FCC Office of Engineering and Technology KDB, "285076 D02 T-Coil Testing for CMRS IP v03," September 13, 2017

FCC ID: ZNFV450PM	 PCTEST ENGINEERING LABORATORY, INC.	HAC (T-COIL) TEST REPORT	 LG	Approved by: Quality Manager
Filename: 1M1811230205-13-R4.ZNF	Test Dates: 01/07/2019 - 01/22/2019	DUT Type: Portable Handset		Page 25 of 90

**Table 7-2
Codec Investigation – OTT VoIP (EDGE)**

Codec Setting:	64kbps	6kbps	Orientation	Channel
ABM1 (dBA/m)	15.66	15.79	Axial	190
ABM2 (dBA/m)	-24.69	-25.58		
Frequency Response	Pass	Pass		
S+N/N (dB)	40.35	41.37		

**Table 7-3
Codec Investigation – OTT VoIP (HSPA)**

Codec Setting:	64kbps	6kbps	Orientation	Channel
ABM1 (dBA/m)	14.86	14.92	Axial	9400
ABM2 (dBA/m)	-50.11	-51.47		
Frequency Response	Pass	Pass		
S+N/N (dB)	64.97	66.39		

**Table 7-4
Codec Investigation – OTT VoIP (LTE)**

Codec Setting:	64kbps	6kbps	Orientation	Band / BW	Channel
ABM1 (dBA/m)	15.78	15.35	Axial	Band 25 20MHz BW	26365
ABM2 (dBA/m)	-44.87	-46.89			
Frequency Response	Pass	Pass			
S+N/N (dB)	60.65	62.24			

**Table 7-5
Codec Investigation – OTT VoIP (WIFI)**

Codec Setting:	64kbps	6kbps	Orientation	Band	Standard	Channel
ABM1 (dBA/m)	15.49	15.01	Axial	2.4GHz	IEEE 802.11b	6
ABM2 (dBA/m)	-33.25	-33.99				
Frequency Response	Pass	Pass				
S+N/N (dB)	48.74	49.00				

- Mute on; Backlight off; Max Volume; Max Contrast
- Radio Configurations can be found in Section 9.II.H

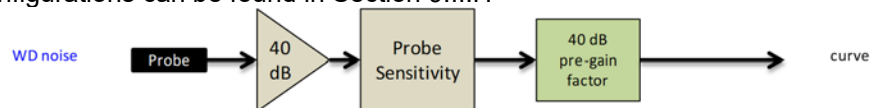

**Figure 7-1
Audio Band Magnetic Curve Measurement Block Diagram**

FCC ID: ZNFV450PM		HAC (T-COIL) TEST REPORT		Approved by: Quality Manager
Filename: 1M1811230205-13-R4.ZNF	Test Dates: 01/07/2019 - 01/22/2019	DUT Type: Portable Handset		Page 26 of 90

2. Radio Configuration for OTT VoIP (LTE)

An investigation was performed to determine the worst-case LTE band to be used for OTT VoIP testing. LTE Band 12 was used for FDD testing and LTE Band 41 (PC2) was used for TDD testing as the worst-case configurations for the handset. See below tables for SNNR comparison between different LTE bands:

Table 7-6
OTT VoIP (LTE) SNNR by LTE FDD Band

Band	Frequency [MHz]	Channel	Bandwidth [MHz]	Modulation	RB Size	RB Offset	ABM1 [dB(A/m)]	ABM2 [dB(A/m)]	SNNR [dB]
71	680.5	133297	20	16QAM	1	0	15.40	-48.11	63.51
66	1745.0	132322	20	16QAM	1	0	15.49	-45.45	60.94
25	1882.5	26365	20	16QAM	1	0	15.74	-46.38	62.12
26	831.5	26865	15	16QAM	1	0	15.64	-47.89	63.53
12	707.5	23095	10	16QAM	1	0	15.75	-38.41	54.16
13	782.0	23230	10	16QAM	1	0	15.74	-45.88	61.62

Table 7-7
OTT VoIP (LTE) SNNR by LTE TDD Band

Band	Frequency [MHz]	Channel	Bandwidth [MHz]	Modulation	RB Size	RB Offset	ABM1 [dB(A/m)]	ABM2 [dB(A/m)]	SNNR [dB]
41 (PC3)	2593.0	40620	20	16QAM	1	0	15.02	-35.13	50.15
41 (PC2)	2593.0	40620	20	16QAM	1	0	15.11	-33.37	48.48

3. LTE TDD Uplink Carrier Aggregation for OTT VoIP

LTE TDD ULCA was evaluated to ensure LTE TDD standalone was the worst-case scenario. The configurations in Table 7-8 were determined from Table 7-7 and satisfy the configuration requirements as defined in 3GPP 36.101. See results below:

Table 7-8
LTE SNNR for OTT VoIP Uplink Carrier Aggregation



Combination	PCC Band	PCC Bandwidth [MHz]	PCC (UL/DL) Channel	PCC (UL/DL) Frequency	Modulation	PCC UL# RB	PCC UL RB Offset	SCC Band	SCC Bandwidth [MHz]	SCC (UL/DL) Channel	SCC (UL/DL) Frequency	Modulation	SCC UL# RB	SCC UL RB Offset	ABM1 [dB(A/m)]	ABM2 [dB(A/m)]	SNNR [dB]

4. NR Band n41 Radio Configuration for OTT VoIP

An investigation was performed to determine the modulation and RB configuration to be used for NR Band n41 testing. Due to equipment limitations, the worst-case ABM1 from LTE B41 was used (see Section 9) with the ABM2 measured for each NR Band n41 modulation and RB configuration. CP-OFDM 64QAM, 1RB, 1RB offset was determined to be the worst-case configuration for the handset and will be used for full testing in Section 9.

Table 7-9
NR Band n41 OTT VoIP SNNR by Radio Configuration

Frequency [MHz]	Channel	Bandwidth [MHz]	Modulation	RB Size	RB Offset	ABM1 [dB(A/m)]	ABM2 [dB(A/m)]	SNNR [dB]
2592.99	518598	60	CP-OFDM QPSK	1	1	14.96	-38.42	53.38
2592.99	518598	60	CP-OFDM QPSK	1	81	14.96	-39.46	54.42
2592.99	518598	60	CP-OFDM QPSK	1	160	14.96	-39.41	54.37
2592.99	518598	60	CP-OFDM QPSK	80	40	14.96	-39.22	54.18
2592.99	518598	60	CP-OFDM QPSK	162	0	14.96	-38.70	53.66
2592.99	518598	60	CP-OFDM 16QAM	1	1	14.96	-39.65	54.61
2592.99	518598	60	CP-OFDM 16QAM	1	81	14.96	-39.85	54.81
2592.99	518598	60	CP-OFDM 16QAM	1	160	14.96	-39.40	54.36
2592.99	518598	60	CP-OFDM 16QAM	80	40	14.96	-39.74	54.70
2592.99	518598	60	CP-OFDM 16QAM	162	0	14.96	-40.31	55.27
2592.99	518598	60	CP-OFDM 64QAM	1	1	14.96	-37.43	52.39
2592.99	518598	60	CP-OFDM 64QAM	1	81	14.96	-39.36	54.32
2592.99	518598	60	CP-OFDM 64QAM	1	160	14.96	-39.55	54.51
2592.99	518598	60	CP-OFDM 64QAM	80	40	14.96	-38.55	53.51
2592.99	518598	60	CP-OFDM 64QAM	162	0	14.96	-38.72	53.68

FCC ID: ZNFV450PM		HAC (T-COIL) TEST REPORT		Approved by: Quality Manager
Filename: 1M1811230205-13-R4.ZNF	Test Dates: 01/07/2019 - 01/22/2019	DUT Type: Portable Handset		Page 27 of 90

8. FCC 3G MEASUREMENTS

I. CDMA Test Configurations

Radio Configuration 1, Service Option 3 (thick, green data curve) was used for the testing as the worst-case configuration for the handset due to vocoder gating from the EVRC logic. See below plot for ABM noise comparison between operational field service options and radio configurations for a CDMA2000 handset:

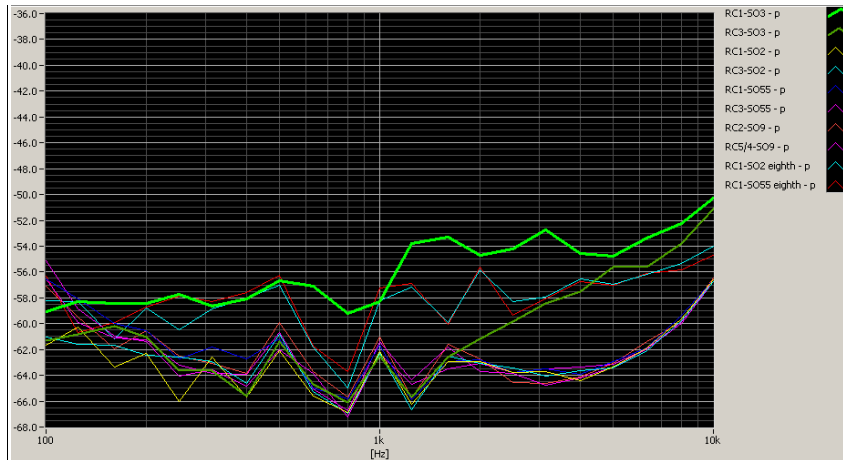

Figure 8-1
CDMA Audio Band Magnetic Noise

Table 8-1
FCC 3G ABM Measurements for ZNFV450PM (CDMA)

Configuration:	RC1/SO3	RC3/SO3	RC4/SO3	Orientation	Channel
ABM1 (dBA/m)	2.15	1.53	1.94	Axial	600
ABM2 (dBA/m)	-41.42	-50.29	-49.93		
Frequency Response	Pass	Pass	Pass		
S+N/N (dB)	43.57	51.82	51.87		

- Mute on; Backlight off; Max Volume; Max Contrast
- Power Control Bits = "All Up"

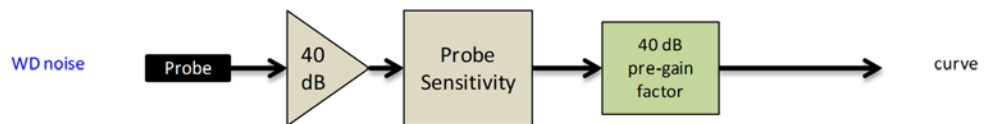

Figure 8-2
Audio Band Magnetic Curve Measurement Block Diagram

FCC ID: ZNFV450PM	PCTEST ENGINEERING LABORATORY, INC.	HAC (T-COIL) TEST REPORT	LG	Approved by: Quality Manager
Filename: 1M1811230205-13-R4.ZNF	Test Dates: 01/07/2019 - 01/22/2019	DUT Type: Portable Handset		Page 28 of 90

© 2019 PCTEST Engineering Laboratory, Inc.

REV 3.2.M
04/17/2018

© 2019 PCTEST Engineering Laboratory, Inc. All rights reserved. Unless otherwise specified, no part of this report may be reproduced or utilized in any part, form or by any means, electronic or mechanical, including photocopying and microfilm, without permission in writing from PCTEST Engineering Laboratory, Inc. If you have any questions about this international copyright or have an enquiry about obtaining additional rights to this report or assembly of contents thereof, please contact INFO@PCTEST.COM.

II. UMTS Test Configurations

AMR at 12.2kbps, 13.6kbps SRB was used for the testing as the worst-case configuration for the handset. See below plot for ABM noise comparison between vocoder rates:

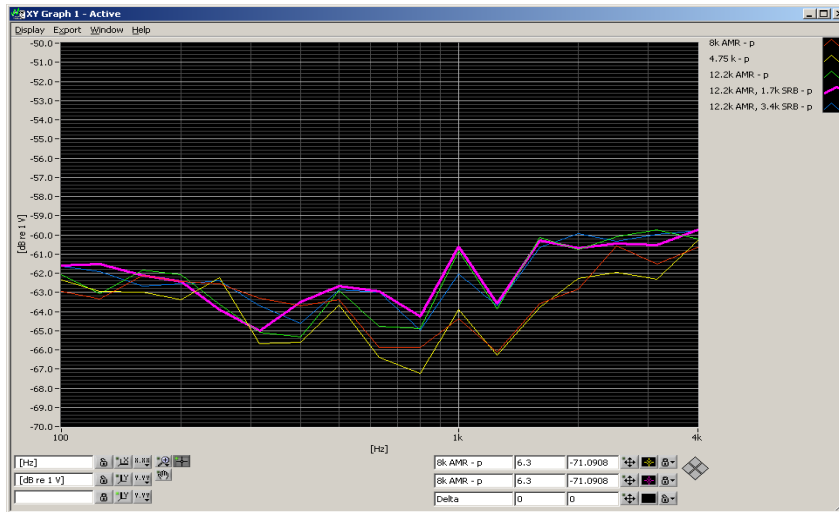

Figure 8-3
UMTS Audio Band Magnetic Noise

Table 8-2
Codec Investigation - UMTS

Codec Setting:	AMR 12.2kbps	AMR 7.95kbps	AMR 4.75kbps	Orientation	Channel
ABM1 (dBA/m)	7.30	7.25	7.23	Axial	9400
ABM2 (dBA/m)	-44.08	-44.15	-44.55		
Frequency Response	Pass	Pass	Pass		
S+N/N (dB)	51.38	51.40	51.78		

- Mute on; Backlight off; Max Volume; Max Contrast
- TPC="All 1s"

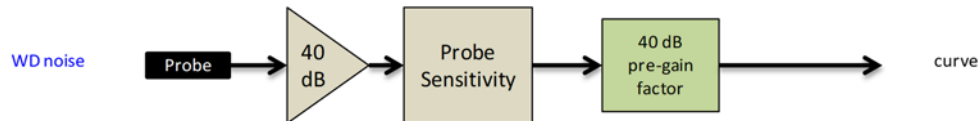





Figure 8-4
Audio Band Magnetic Curve Measurement Block Diagram

FCC ID: ZNFV450PM		HAC (T-COIL) TEST REPORT		Approved by: Quality Manager
Filename: 1M1811230205-13-R4.ZNF	Test Dates: 01/07/2019 - 01/22/2019	DUT Type: Portable Handset		Page 29 of 90

9. T-COIL TEST SUMMARY

**Table 9-1
Consolidated Tabled Results**

C63.19 Section	Freq. Response Margin		Magnetic Intensity Verdict		FCC SNNR Verdict		Margin from FCC Limit (dB)	C63.19-2011 Rating
	8.3.2		8.3.1		8.3.4			
	Axial	Radial	Axial	Radial	Axial	Radial		
CDMA	Secondary Cellular	PASS	NA	PASS	PASS	PASS	-16.04	T4
	Cellular	PASS	NA	PASS	PASS	PASS		
	PCS	PASS	NA	PASS	PASS	PASS		
EvDO (OTT VoIP)	Secondary Cellular	PASS	NA	PASS	PASS	PASS	-38.08	T4
	Cellular	PASS	NA	PASS	PASS	PASS		
	PCS	PASS	NA	PASS	PASS	PASS		
GSM	Cellular	PASS	NA	PASS	PASS	PASS	-7.27	T3
	PCS	PASS	NA	PASS	PASS	PASS		
EDGE (OTT VoIP)	Cellular	PASS	NA	PASS	PASS	PASS	-17.51	T4
	PCS	PASS	NA	PASS	PASS	PASS		
UMTS	Cellular	PASS	NA	PASS	PASS	PASS	-30.14	T4
	AWS	PASS	NA	PASS	PASS	PASS		
	PCS	PASS	NA	PASS	PASS	PASS		
HSPA (OTT VoIP)	Cellular	PASS	NA	PASS	PASS	PASS	-40.46	T4
	AWS	PASS	NA	PASS	PASS	PASS		
	PCS	PASS	NA	PASS	PASS	PASS		
LTE FDD	B71	PASS	NA	PASS	PASS	PASS	-22.37	T4
	B12	PASS	NA	PASS	PASS	PASS		
	B13	PASS	NA	PASS	PASS	PASS		
	B26	PASS	NA	PASS	PASS	PASS		
	B5	PASS	NA	PASS	PASS	PASS		
	B66	PASS	NA	PASS	PASS	PASS		
	B25	PASS	NA	PASS	PASS	PASS		
LTE FDD (OTT VoIP)	B12	PASS	NA	PASS	PASS	PASS	-33.13	T4
LTE TDD	B41 (PC3)	PASS	NA	PASS	PASS	PASS	-22.94	T4
	B41 (PC2)	PASS	NA	PASS	PASS	PASS		
LTE TDD (OTT VoIP)	B41 (PC2)	PASS	NA	PASS	PASS	PASS	-26.60	T4
NR (OTT VoIP)	n41	NA	NA	PASS	PASS	PASS	-32.72	T4
WLAN	802.11b	PASS	NA	PASS	PASS	PASS	-13.42	T4
	802.11g	PASS	NA	PASS	PASS	PASS		
	802.11n	PASS	NA	PASS	PASS	PASS		
	802.11ac	PASS	NA	PASS	PASS	PASS		
WLAN (OTT VoIP)	802.11b	PASS	NA	PASS	PASS	PASS	-21.39	T4
	802.11g	PASS	NA	PASS	PASS	PASS		
	802.11n	PASS	NA	PASS	PASS	PASS		
	802.11ac	PASS	NA	PASS	PASS	PASS		
U-NII	802.11a	PASS	NA	PASS	PASS	PASS	-8.09	T3
	802.11n	PASS	NA	PASS	PASS	PASS		
	802.11ac	PASS	NA	PASS	PASS	PASS		
U-NII (OTT VoIP)	802.11a	PASS	NA	PASS	PASS	PASS	-16.35	T4
	802.11n	PASS	NA	PASS	PASS	PASS		
	802.11ac	PASS	NA	PASS	PASS	PASS		

FCC ID: ZNFV450PM		HAC (T-COIL) TEST REPORT		Approved by: Quality Manager
Filename: 1M1811230205-13-R4.ZNF	Test Dates: 01/07/2019 - 01/22/2019	DUT Type: Portable Handset		Page 30 of 90



I. Raw Handset Data

Table 9-2
Raw Data Results for CDMA

Mode	Orientation	Channel	DUT S/N	ABM1 [dB(A/m)]	ABM2 [dB(A/m)]	Ambient Noise [dB(A/m)]	Frequency Response Margin (dB)	S+N/N (dB)	FCC Limit (dB)	Margin from FCC Limit (dB)	C63.19-2011 Rating	Test Coordinates
Secondary Cellular	Axial	476	00386	5.50	-38.43	-61.64	1.56	43.93	20.00	-23.93	T4	2.2, 3.4
		564	00386	5.17	-37.81		1.56	42.98	20.00	-22.98	T4	
		684	00386	4.61	-40.14		1.61	44.75	20.00	-24.75	T4	
	Radial	476	00386	-0.74	-36.78	-64.63	N/A	36.04	20.00	-16.04	T4	2.2, 2.2
		564	00386	-0.69	-36.87		36.18	20.00	-16.18	T4		
		684	00386	-1.06	-39.20		38.14	20.00	-18.14	T4		
Cellular	Axial	1013	00386	5.78	-42.17	-61.64	1.62	47.95	20.00	-27.95	T4	2.2, 3.4
		384	00386	5.85	-40.17		1.59	46.02	20.00	-26.02	T4	
		777	00386	4.96	-41.84		1.62	46.80	20.00	-26.80	T4	
	Radial	1013	00386	-0.92	-40.23	-64.63	N/A	39.31	20.00	-19.31	T4	2.2, 2.2
		384	00386	-0.74	-38.30		37.56	20.00	-17.56	T4		
		777	00386	-0.85	-39.44		38.59	20.00	-18.59	T4		
PCS	Axial	25	00386	5.22	-45.57	-61.64	1.58	50.79	20.00	-30.79	T4	2.2, 3.4
		600	00386	5.06	-45.63		1.52	50.69	20.00	-30.69	T4	
		1175	00386	4.87	-44.37		1.59	49.24	20.00	-29.24	T4	
	Radial	25	00386	-0.96	-43.10	-64.63	N/A	42.14	20.00	-22.14	T4	2.2, 2.2
		600	00386	-1.00	-43.09		42.09	20.00	-22.09	T4		
		1175	00386	-0.99	-41.59		40.60	20.00	-20.60	T4		

Table 9-3
Raw Data Results for GSM

Mode	Orientation	Channel	DUT S/N	ABM1 [dB(A/m)]	ABM2 [dB(A/m)]	Ambient Noise [dB(A/m)]	Frequency Response Margin (dB)	S+N/N (dB)	FCC Limit (dB)	Margin from FCC Limit (dB)	C63.19-2011 Rating	Test Coordinates
GSM850	Axial	128	00386	7.61	-21.75	-61.64	1.51	29.36	20.00	-9.36	T3	2.2, 3.4
		190	00386	7.85	-21.67		1.49	29.52	20.00	-9.52	T3	
		251	00386	7.57	-22.17		1.51	29.74	20.00	-9.74	T3	
	Radial	128	00386	-2.73	-30.49	-62.60	N/A	27.76	20.00	-7.76	T3	2.2, 2.2
		190	00386	-2.99	-30.26		27.27	20.00	-7.27	T3		
		251	00386	-2.70	-30.13		27.43	20.00	-7.43	T3		
GSM1900	Axial	512	00386	7.77	-25.47	-61.64	1.54	33.24	20.00	-13.24	T4	2.2, 3.4
		661	00386	7.69	-26.24		1.51	33.93	20.00	-13.93	T4	
		810	00386	7.70	-25.61		1.51	33.31	20.00	-13.31	T4	
	Radial	512	00386	-2.83	-35.37	-62.60	N/A	32.54	20.00	-12.54	T4	2.2, 2.2
		661	00386	-2.66	-35.72		33.06	20.00	-13.06	T4		
		810	00386	-2.66	-35.59		32.93	20.00	-12.93	T4		

FCC ID: ZNFV450PM	 PCTEST ENGINEERING LABORATORY, INC.	HAC (T-COIL) TEST REPORT		Approved by: Quality Manager
Filename: 1M1811230205-13-R4.ZNF	Test Dates: 01/07/2019 - 01/22/2019	DUT Type: Portable Handset		Page 31 of 90

© 2019 PCTEST Engineering Laboratory, Inc.

REV 3.2.M
04/17/2018

© 2019 PCTEST Engineering Laboratory, Inc. All rights reserved. Unless otherwise specified, no part of this report may be reproduced or utilized in any part, form or by any means, electronic or mechanical, including photocopying and microfilm, without permission in writing from PCTEST Engineering Laboratory, Inc. If you have any questions about this international copyright or have an enquiry about obtaining additional rights to this report or assembly of contents thereof, please contact INFO@PCTEST.COM.

**Table 9-4
Raw Data Results for UMTS**

Mode	Orientation	Channel	DUT S/N	ABM1 [dB(A/m)]	ABM2 [dB(A/m)]	Ambient Noise [dB(A/m)]	Frequency Response Margin (dB)	S+N/N (dB)	FCC Limit (dB)	Margin from FCC Limit (dB)	C63.19-2011 Rating	Test Coordinates
UMTS V	Axial	4132	00386	7.33	-43.70	-61.64	1.53	51.03	20.00	-31.03	T4	2.2, 3.4
		4183	00386	7.33	-44.24		1.48	51.57	20.00	-31.57	T4	
		4233	00386	7.31	-42.83		1.54	50.14	20.00	-30.14	T4	
	Radial	4132	00386	-3.21	-58.38	-62.60	N/A	55.17	20.00	-35.17	T4	2.2, 2.2
		4183	00386	-3.21	-58.25			55.04	20.00	-35.04	T4	
		4233	00386	-3.21	-58.19			54.98	20.00	-34.98	T4	
UMTS IV	Axial	1312	00386	7.45	-44.54	-61.64	1.54	51.99	20.00	-31.99	T4	2.2, 3.4
		1412	00386	7.42	-43.90		1.52	51.32	20.00	-31.32	T4	
		1513	00386	7.33	-44.92		1.54	52.25	20.00	-32.25	T4	
	Radial	1312	00386	-3.20	-58.26	-62.60	N/A	55.06	20.00	-35.06	T4	2.2, 2.2
		1412	00386	-3.22	-58.34			55.12	20.00	-35.12	T4	
		1513	00386	-3.20	-58.29			55.09	20.00	-35.09	T4	
UMTS II	Axial	9262	00386	7.40	-42.86	-61.64	1.55	50.26	20.00	-30.26	T4	2.2, 3.4
		9400	00386	7.37	-43.52		1.54	50.89	20.00	-30.89	T4	
		9538	00386	7.45	-42.85		1.54	50.30	20.00	-30.30	T4	
	Radial	9262	00386	-3.21	-58.36	-62.60	N/A	55.15	20.00	-35.15	T4	2.2, 2.2
		9400	00386	-3.21	-58.61			55.40	20.00	-35.40	T4	
		9538	00386	-3.23	-58.79			55.56	20.00	-35.56	T4	

**Table 9-5
Raw Data Results for LTE B71**

Mode	Orientation	Bandwidth	Channel	DUT S/N	ABM1 [dB(A/m)]	ABM2 [dB(A/m)]	Ambient Noise [dB(A/m)]	Frequency Response Margin (dB)	S+N/N (dB)	FCC Limit (dB)	Margin from FCC Limit (dB)	C63.19-2011 Rating	Test Coordinates
LTE Band 71	Axial	20MHz	133297	00386	7.17	-41.36	-61.64	0.96	48.53	20.00	-28.53	T4	2.2, 3.4
		15MHz	133297	00386	7.36	-40.15		0.94	47.51	20.00	-27.51	T4	
		10MHz	133297	00386	7.16	-39.70		1.00	46.86	20.00	-26.86	T4	
		5MHz	133297	00386	6.80	-38.73		0.92	45.53	20.00	-25.53	T4	
	Radial	20MHz	133297	00386	-2.96	-54.72	-61.59	N/A	51.76	20.00	-31.76	T4	2.2, 2.2
		15MHz	133297	00386	-2.89	-54.71			51.82	20.00	-31.82	T4	
		10MHz	133297	00386	-2.55	-54.79			52.24	20.00	-32.24	T4	
		5MHz	133297	00386	-2.56	-53.98			51.42	20.00	-31.42	T4	

**Table 9-6
Raw Data Results for LTE B12**

Mode	Orientation	Bandwidth	Channel	DUT S/N	ABM1 [dB(A/m)]	ABM2 [dB(A/m)]	Ambient Noise [dB(A/m)]	Frequency Response Margin (dB)	S+N/N (dB)	FCC Limit (dB)	Margin from FCC Limit (dB)	C63.19-2011 Rating	Test Coordinates
LTE Band 12	Axial	10MHz	23095	00386	7.19	-37.49	-61.64	1.10	44.68	20.00	-24.68	T4	2.2, 3.4
		5MHz	23095	00386	7.08	-37.62		1.00	44.70	20.00	-24.70	T4	
		3MHz	23095	00386	7.20	-38.10		1.12	45.30	20.00	-25.30	T4	
		1.4MHz	23095	00386	7.07	-40.60		1.08	47.67	20.00	-27.67	T4	
	Radial	10MHz	23095	00386	-2.90	-53.86	-61.59	N/A	50.96	20.00	-30.96	T4	2.2, 2.2
		5MHz	23095	00386	-3.07	-53.23			50.16	20.00	-30.16	T4	
		3MHz	23095	00386	-2.56	-54.34			51.78	20.00	-31.78	T4	
		1.4MHz	23095	00386	-3.06	-54.64			51.58	20.00	-31.58	T4	

**Table 9-7
Raw Data Results for LTE B13**

Mode	Orientation	Bandwidth	Channel	DUT S/N	ABM1 [dB(A/m)]	ABM2 [dB(A/m)]	Ambient Noise [dB(A/m)]	Frequency Response Margin (dB)	S+N/N (dB)	FCC Limit (dB)	Margin from FCC Limit (dB)	C63.19-2011 Rating	Test Coordinates
LTE Band 13	Axial	10MHz	23230	00386	7.13	-36.31	-61.64	0.95	43.44	20.00	-23.44	T4	2.2, 3.4
		5MHz	23230	00386	7.02	-37.37		1.11	44.39	20.00	-24.39	T4	
	Radial	10MHz	23230	00386	-2.88	-53.21	-61.59	N/A	50.33	20.00	-30.33	T4	2.2, 2.2
		5MHz	23230	00386	-2.60	-52.91			50.31	20.00	-30.31	T4	



FCC ID: ZNFV450PM	 PCTEST ENGINEERING LABORATORY, INC.	HAC (T-COIL) TEST REPORT	 LG	Approved by: Quality Manager
Filename: 1M1811230205-13-R4.ZNF	Test Dates: 01/07/2019 - 01/22/2019	DUT Type: Portable Handset		Page 32 of 90

Table 9-8
Raw Data Results for LTE B26

Mode	Orientation	Bandwidth	Channel	DUT S/N	ABM1 [dB(A/m)]	ABM2 [dB(A/m)]	Ambient Noise [dB(A/m)]	Frequency Response Margin (dB)	S+N/N (dB)	FCC Limit (dB)	Margin from FCC Limit (dB)	C63.19-2011 Rating	Test Coordinates
LTE Band 26	Axial	15MHz	26865	00386	7.08	-38.76	-61.64	1.05	45.84	20.00	-25.84	T4	2.2, 3.4
		10MHz	26865	00386	7.28	-38.20		1.04	45.48	20.00	-25.48	T4	
		5MHz	26865	00386	7.27	-37.29		0.98	44.56	20.00	-24.56	T4	
		3MHz	26865	00386	7.06	-37.40		1.05	44.46	20.00	-24.46	T4	
		1.4MHz	26865	00386	6.90	-37.73		0.98	44.63	20.00	-24.63	T4	
	Radial	15MHz	26865	00386	-3.06	-52.49	-61.59	N/A	49.43	20.00	-29.43	T4	2.2, 2.2
		10MHz	26865	00386	-2.72	-53.82			51.10	20.00	-31.10	T4	
		5MHz	26865	00386	-2.86	-52.66			49.80	20.00	-29.80	T4	
		3MHz	26865	00386	-2.93	-53.08			50.15	20.00	-30.15	T4	
		1.4MHz	26865	00386	-2.90	-53.65			50.75	20.00	-30.75	T4	

Table 9-9
Raw Data Results for LTE B66

Mode	Orientation	Bandwidth	Channel	DUT S/N	ABM1 [dB(A/m)]	ABM2 [dB(A/m)]	Ambient Noise [dB(A/m)]	Frequency Response Margin (dB)	S+N/N (dB)	FCC Limit (dB)	Margin from FCC Limit (dB)	C63.19-2011 Rating	Test Coordinates
LTE Band 66	Axial	20MHz	132572	00004	3.08	-39.54	-63.39	1.11	42.62	20.00	-22.62	T4	2.2, 3.4
		20MHz	132322	00004	2.68	-40.71		1.12	43.39	20.00	-23.39	T4	
		20MHz	132072	00004	2.93	-39.44		1.10	42.37	20.00	-22.37	T4	
		15MHz	132322	00004	2.64	-42.52		1.04	45.16	20.00	-25.16	T4	
		10MHz	132322	00004	2.67	-42.77		1.03	45.44	20.00	-25.44	T4	
		5MHz	132322	00004	2.87	-42.62		1.15	45.49	20.00	-25.49	T4	
		3MHz	132322	00004	2.66	-43.29		1.13	45.95	20.00	-25.95	T4	
		1.4MHz	132322	00004	2.53	-42.54		1.14	45.07	20.00	-25.07	T4	
		Radial	20MHz	132322	00004	-2.65		-47.04	-64.63	N/A	44.39	20.00	
	15MHz		132322	00004	-2.51	-48.02	45.51	20.00			-25.51	T4	
	10MHz		132322	00004	-2.45	-47.98	45.53	20.00			-25.53	T4	
	5MHz		132322	00004	-2.83	-48.80	45.97	20.00			-25.97	T4	
	3MHz		132657	00004	-2.10	-47.55	45.45	20.00			-25.45	T4	
	3MHz		132322	00004	-2.62	-46.97	44.35	20.00			-24.35	T4	
	3MHz		131987	00004	-2.35	-46.36	44.01	20.00			-24.01	T4	
	1.4MHz		132322	00004	-2.77	-49.21	46.44	20.00			-26.44	T4	

Table 9-10
Raw Data Results for LTE B25

Mode	Orientation	Bandwidth	Channel	DUT S/N	ABM1 [dB(A/m)]	ABM2 [dB(A/m)]	Ambient Noise [dB(A/m)]	Frequency Response Margin (dB)	S+N/N (dB)	FCC Limit (dB)	Margin from FCC Limit (dB)	C63.19-2011 Rating	Test Coordinates
LTE Band 25	Axial	20MHz	26365	00386	7.31	-40.02	-61.64	1.23	47.33	20.00	-27.33	T4	2.2, 3.4
		15MHz	26365	00386	7.20	-41.96		1.03	49.16	20.00	-29.16	T4	
		10MHz	26365	00386	7.17	-39.69		1.01	46.86	20.00	-26.86	T4	
		5MHz	26365	00386	7.13	-42.39		1.09	49.52	20.00	-29.52	T4	
		3MHz	26365	00386	7.26	-42.28		1.03	49.54	20.00	-29.54	T4	
		1.4MHz	26365	00386	6.83	-41.89		1.07	48.72	20.00	-28.72	T4	
		Radial	20MHz	26365	00386	-2.93		-54.83	-61.59	N/A	51.90	20.00	
	15MHz		26365	00386	-2.85	-54.85	52.00	20.00			-32.00	T4	
	10MHz		26365	00386	-2.57	-54.39	51.82	20.00			-31.82	T4	
	5MHz		26365	00386	-2.56	-54.54	51.98	20.00			-31.98	T4	
	3MHz		26365	00386	-2.57	-55.03	52.46	20.00			-32.46	T4	
	1.4MHz		26365	00386	-2.97	-55.03	52.06	20.00			-32.06	T4	

Table 9-11
Raw Data Results for LTE B41 Power Class 3

Mode	Orientation	Bandwidth	Channel	DUT S/N	ABM1 [dB(A/m)]	ABM2 [dB(A/m)]	Ambient Noise [dB(A/m)]	Frequency Response Margin (dB)	S+N/N (dB)	FCC Limit (dB)	Margin from FCC Limit (dB)	C63.19-2011 Rating	Test Coordinates
LTE Band 41	Axial	20MHz	40620	00386	7.33	-36.07	-61.64	0.99	43.40	20.00	-23.40	T4	2.2, 3.4
		15MHz	40620	00386	7.19	-36.99		1.05	44.18	20.00	-24.18	T4	
		10MHz	40620	00386	7.19	-37.02		1.09	44.21	20.00	-24.21	T4	
		5MHz	40620	00386	7.38	-37.08		1.03	44.46	20.00	-24.46	T4	
	Radial	20MHz	40620	00386	-2.75	-48.85	-61.59	N/A	46.10	20.00	-26.10	T4	2.2, 2.2
		15MHz	40620	00386	-3.20	-49.04			45.84	20.00	-25.84	T4	
		10MHz	40620	00386	-3.02	-48.95			45.93	20.00	-25.93	T4	
		5MHz	40620	00386	-2.86	-48.92			46.06	20.00	-26.06	T4	



FCC ID: ZNFV450PM	 PCTEST ENGINEERING LABORATORY, INC.	HAC (T-COIL) TEST REPORT	 LG	Approved by: Quality Manager
Filename: 1M1811230205-13-R4.ZNF	Test Dates: 01/07/2019 - 01/22/2019	DUT Type: Portable Handset		Page 33 of 90

Table 9-12
Raw Data Results for LTE B41 Power Class 2

Mode	Orientation	Bandwidth	Channel	DUT S/N	ABM1 [dB(A/m)]	ABM2 [dB(A/m)]	Ambient Noise [dB(A/m)]	Frequency Response Margin (dB)	S+N/N (dB)	FCC Limit (dB)	Margin from FCC Limit (dB)	C63.19-2011 Rating	Test Coordinates
LTE Band 41	Axial	20MHz	40620	00386	7.43	-36.15	-61.64	0.89	43.58	20.00	-23.58	T4	2.2, 3.4
		15MHz	40620	00386	7.47	-36.38		1.10	43.85	20.00	-23.85	T4	
		10MHz	41490	00386	7.15	-35.86		1.02	43.01	20.00	-23.01	T4	
		10MHz	41055	00386	7.53	-35.41		1.08	42.94	20.00	-22.94	T4	
		10MHz	40620	00386	7.16	-36.15		1.05	43.31	20.00	-23.31	T4	
		10MHz	40185	00386	7.35	-36.82		1.06	44.17	20.00	-24.17	T4	
		10MHz	39750	00386	7.30	-36.79		1.00	44.09	20.00	-24.09	T4	
		5MHz	40620	00386	7.60	-35.92		1.01	43.52	20.00	-23.52	T4	
		Radial	20MHz	40620	00386	-2.75		-48.80	-61.59	N/A	46.05	20.00	
	15MHz		40620	00386	-3.01	-48.91	45.90	20.00			-25.90	T4	
	10MHz		40620	00386	-2.80	-48.72	45.92	20.00			-25.92	T4	
	5MHz		41490	00386	-2.79	-48.73	45.94	20.00			-25.94	T4	
	5MHz		41055	00386	-2.74	-47.77	45.03	20.00			-25.03	T4	
	5MHz		40620	00386	-3.10	-48.83	45.73	20.00			-25.73	T4	
	5MHz		40185	00386	-2.89	-48.97	46.08	20.00			-26.08	T4	
	5MHz		39750	00386	-3.10	-48.94	45.84	20.00			-25.84	T4	

Table 9-13
Raw Data Results for 2.4GHz WIFI

Mode	Orientation	Channel	DUT S/N	ABM1 [dB(A/m)]	ABM2 [dB(A/m)]	Ambient Noise [dB(A/m)]	Frequency Response Margin (dB)	S+N/N (dB)	FCC Limit (dB)	Margin from FCC Limit (dB)	C63.19-2011 Rating	Test Coordinates
IEEE 802.11b	Axial	1	00444	-0.10	-34.22	-61.64	0.94	34.12	20.00	-14.12	T4	2.2, 3.4
		6	00444	-0.05	-33.47		1.02	33.42	20.00	-13.42	T4	
		11	00444	-0.21	-34.70		0.96	34.49	20.00	-14.49	T4	
	Radial	1	00444	-6.74	-42.30	-64.63	N/A	35.56	20.00	-15.56	T4	2.2,2.2
		6	00444	-6.43	-42.17			35.74	20.00	-15.74	T4	
		11	00444	-6.83	-41.02			34.19	20.00	-14.19	T4	
IEEE 802.11g	Axial	6	00444	-0.32	-37.25	-61.64	0.98	36.93	20.00	-16.93	T4	2.2, 3.4
	Radial	6	00444	-6.43	-46.15	-64.63	N/A	39.72	20.00	-19.72	T4	2.2,2.2
IEEE 802.11n	Axial	6	00444	-0.08	-38.16	-61.64	1.11	38.08	20.00	-18.08	T4	2.2, 3.4
	Radial	6	00444	-6.63	-44.98	-64.63	N/A	38.35	20.00	-18.35	T4	2.2,2.2
IEEE 802.11ac	Axial	6	00444	0.02	-38.93	-61.64	1.19	38.95	20.00	-18.95	T4	2.2, 3.4
	Radial	6	00444	-6.70	-45.19	-64.63	N/A	38.49	20.00	-18.49	T4	2.2,2.2

Table 9-14
Raw Data Results for 5GHz WIFI 802.11a

Mode	Orientation	Bandwidth	U-NII	Channel	DUT S/N	ABM1 [dB(A/m)]	ABM2 [dB(A/m)]	Ambient Noise [dB(A/m)]	Frequency Response Margin (dB)	S+N/N (dB)	FCC Limit (dB)	Margin from FCC Limit (dB)	C63.19-2011 Rating	Test Coordinates
IEEE 802.11a	Axial	20MHz	1	40	00444	-0.15	-45.41	-63.39	0.99	45.26	20.00	-25.26	T4	2.2, 3.4
	Radial	20MHz	1	40	00444	-6.88	-38.05	-64.63	N/A	31.17	20.00	-11.17	T4	2.2,2.2



FCC ID: ZNFV450PM	 PCTEST ENGINEERING LABORATORY, INC.	HAC (T-COIL) TEST REPORT	 LG	Approved by: Quality Manager
Filename: 1M1811230205-13-R4.ZNF	Test Dates: 01/07/2019 - 01/22/2019	DUT Type: Portable Handset	Page 34 of 90	

Table 9-15
Raw Data Results for 5GHz WIFI 802.11n

Mode	Orientation	Bandwidth	U-NII	Channel	DUT S/N	ABM1 [dB(A/m)]	ABM2 [dB(A/m)]	Ambient Noise [dB(A/m)]	Frequency Response Margin (dB)	S+N/N (dB)	FCC Limit (dB)	Margin from FCC Limit (dB)	C63.19-2011 Rating	Test Coordinates
IEEE 802.11n	Axial	40MHz	1	38	00444	-0.11	-44.63	-63.39	1.06	44.52	20.00	-24.52	T4	2.2, 3.4
		20MHz	1	40	00444	-0.13	-43.95		1.17	43.82	20.00	-23.82	T4	
		40MHz	2A	54	00444	-0.34	-45.31		1.10	44.97	20.00	-24.97	T4	
		20MHz	2A	56	00444	-0.25	-45.46		1.02	45.21	20.00	-25.21	T4	
		40MHz	2C	118	00444	-0.22	-45.04		1.10	44.82	20.00	-24.82	T4	
		20MHz	2C	120	00444	-0.31	-45.37		0.95	45.06	20.00	-25.06	T4	
		40MHz	3	151	00444	-0.19	-43.89		1.16	43.70	20.00	-23.70	T4	
		40MHz	3	159	00444	-0.32	-43.63		1.04	43.31	20.00	-23.31	T4	
		20MHz	3	157	00444	-0.16	-45.26		1.11	45.10	20.00	-25.10	T4	
	Radial	40MHz	1	38	00444	-6.71	-36.47	-64.63	N/A	29.76	20.00	-9.76	T3	2.2,2.2
		20MHz	1	40	00444	-6.65	-36.22			29.57	20.00	-9.57	T3	
		40MHz	2A	54	00444	-6.81	-35.77			28.96	20.00	-8.96	T3	
		20MHz	2A	56	00444	-6.79	-35.63			28.84	20.00	-8.84	T3	
		40MHz	2C	118	00444	-6.76	-35.97			29.21	20.00	-9.21	T3	
		20MHz	2C	100	00444	-6.87	-35.04			28.17	20.00	-8.17	T3	
		20MHz	2C	120	00444	-6.79	-34.88			28.09	20.00	-8.09	T3	
		20MHz	2C	144	00444	-7.00	-36.53			29.53	20.00	-9.53	T3	
		40MHz	3	151	00444	-6.69	-35.88			29.19	20.00	-9.19	T3	
20MHz		3	157	00444	-6.57	-35.43	28.86			20.00	-8.86	T3		

Table 9-16
Raw Data Results for 5GHz WIFI 802.11ac

Mode	Orientation	Bandwidth	U-NII	Channel	DUT S/N	ABM1 [dB(A/m)]	ABM2 [dB(A/m)]	Ambient Noise [dB(A/m)]	Frequency Response Margin (dB)	S+N/N (dB)	FCC Limit (dB)	Margin from FCC Limit (dB)	C63.19-2011 Rating	Test Coordinates
IEEE 802.11ac	Axial	40MHz	1	38	00444	-0.20	-45.56	-63.39	0.98	45.36	20.00	-25.36	T4	2.2, 3.4
		20MHz	1	40	00444	-0.15	-45.79		1.13	45.64	20.00	-25.64	T4	
	Radial	40MHz	1	38	00444	-6.82	-37.10	-64.63	N/A	30.28	20.00	-10.28	T4	2.2,2.2
		20MHz	1	40	00444	-6.56	-36.76			30.20	20.00	-10.20	T4	

Table 9-17
Raw Data Results for EvDO (OTT VoIP)

Mode	Orientation	Channel	DUT S/N	ABM1 [dB(A/m)]	ABM2 [dB(A/m)]	Ambient Noise [dB(A/m)]	Frequency Response Margin (dB)	S+N/N (dB)	FCC Limit (dB)	Margin from FCC Limit (dB)	C63.19-2011 Rating	Test Coordinates
Secondary Cellular EvDO	Axial	564	00444	15.09	-49.16	-63.19	1.44	64.25	20.00	-44.25	T4	2.2,3.4
	Radial	564	00444	8.46	-49.62	-62.60	N/A	58.08	20.00	-38.08	T4	2.2,2.2
Cellular EvDO	Axial	384	00444	15.06	-50.08	-63.19	1.40	65.14	20.00	-45.14	T4	2.2,3.4
	Radial	384	00444	8.93	-50.24	-62.60	N/A	59.17	20.00	-39.17	T4	2.2,2.2
PCS EvDO	Axial	600	00444	15.15	-50.53	-63.19	1.46	65.68	20.00	-45.68	T4	2.2,3.4
	Radial	600	00444	8.52	-50.18	-62.60	N/A	58.70	20.00	-38.70	T4	2.2,2.2

Table 9-18
Raw Data Results for EDGE (OTT VoIP)

Mode	Orientation	Channel	DUT S/N	ABM1 [dB(A/m)]	ABM2 [dB(A/m)]	Ambient Noise [dB(A/m)]	Frequency Response Margin (dB)	S+N/N (dB)	FCC Limit (dB)	Margin from FCC Limit (dB)	C63.19-2011 Rating	Test Coordinates
EDGE850	Axial	190	00444	15.71	-24.32	-63.19	1.45	40.03	20.00	-20.03	T4	2.2,3.4
	Radial	190	00444	8.23	-29.28	-62.60	N/A	37.51	20.00	-17.51	T4	2.2,2.2
EDGE1900	Axial	661	00444	15.72	-23.70	-63.19	1.35	39.42	20.00	-19.42	T4	2.2,3.4
	Radial	661	00444	8.11	-33.69	-62.60	N/A	41.80	20.00	-21.80	T4	2.2, 2.2



FCC ID: ZNFV450PM	 PCTEST ENGINEERING LABORATORY, INC.	HAC (T-COIL) TEST REPORT	 LG	Approved by: Quality Manager
Filename: 1M1811230205-13-R4.ZNF	Test Dates: 01/07/2019 - 01/22/2019	DUT Type: Portable Handset	Page 35 of 90	

Table 9-19
Raw Data Results for HSPA (OTT VoIP)

Mode	Orientation	Channel	DUT S/N	ABM1 [dB(A/m)]	ABM2 [dB(A/m)]	Ambient Noise [dB(A/m)]	Frequency Response Margin (dB)	S+N/N (dB)	FCC Limit (dB)	Margin from FCC Limit (dB)	C63.19-2011 Rating	Test Coordinates
HSPA V	Axial	4183	00444	15.75	-50.06	-61.64	1.41	65.81	20.00	-45.81	T4	2.2,3.4
	Radial	4183	00444	8.33	-54.43	-61.59	N/A	62.76	20.00	-42.76	T4	2.2,2.2
HSPA IV	Axial	1412	00444	15.45	-45.01	-61.64	1.43	60.46	20.00	-40.46	T4	2.2,3.4
	Radial	1412	00444	8.25	-54.62	-61.59	N/A	62.87	20.00	-42.87	T4	2.2,2.2
HSPA II	Axial	9400	00444	15.69	-47.75	-61.64	1.45	63.44	20.00	-43.44	T4	2.2,3.4
	Radial	9400	00444	8.03	-54.77	-61.59	N/A	62.80	20.00	-42.80	T4	2.2,2.2

Table 9-20
Raw Data Results for LTE FDD B12 (OTT VoIP)

Mode	Orientation	Bandwidth	Channel	DUT S/N	ABM1 [dB(A/m)]	ABM2 [dB(A/m)]	Ambient Noise [dB(A/m)]	Frequency Response Margin (dB)	S+N/N (dB)	FCC Limit (dB)	Margin from FCC Limit (dB)	C63.19-2011 Rating	Test Coordinates
LTE Band 12	Axial	10MHz	23095	00444	15.67	-38.20	-63.19	1.48	53.87	20.00	-33.87	T4	2.2,3.4
		5MHz	23155	00444	15.73	-39.18		1.46	54.91	20.00	-34.91	T4	
		5MHz	23095	00444	15.14	-37.99		1.47	53.13	20.00	-33.13	T4	
		5MHz	23035	00444	15.76	-42.48		1.46	58.24	20.00	-38.24	T4	
		3MHz	23095	00444	15.71	-40.60		1.47	56.31	20.00	-36.31	T4	
		1.4MHz	23095	00444	15.56	-42.99		1.41	58.55	20.00	-38.55	T4	
	Radial	10MHz	23130	00444	8.37	-47.24	-62.60	N/A	55.61	20.00	-35.61	T4	2.2,2.2
		10MHz	23095	00444	8.29	-46.69			54.98	20.00	-34.98	T4	
		10MHz	23060	00444	8.41	-45.96			54.37	20.00	-34.37	T4	
		5MHz	23095	00444	8.25	-46.95			55.20	20.00	-35.20	T4	
		3MHz	23095	00444	8.29	-47.23			55.52	20.00	-35.52	T4	
		1.4MHz	23095	00444	8.26	-47.73			55.99	20.00	-35.99	T4	

Table 9-21
Raw Data Results for LTE TDD B41 (PC2) (OTT VoIP)

Mode	Orientation	Bandwidth	Channel	DUT S/N	ABM1 [dB(A/m)]	ABM2 [dB(A/m)]	Ambient Noise [dB(A/m)]	Frequency Response Margin (dB)	S+N/N (dB)	FCC Limit (dB)	Margin from FCC Limit (dB)	C63.19-2011 Rating	Test Coordinates
LTE Band 41	Axial	20MHz	40620	00386	15.17	-33.53	-63.19	1.47	48.70	20.00	-28.70	T4	2.2,3.4
		15MHz	40620	00386	15.12	-33.48		1.50	48.60	20.00	-28.60	T4	
		10MHz	41490	00386	14.96	-33.47		1.49	48.43	20.00	-28.43	T4	
		10MHz	41055	00386	15.03	-32.86		1.46	47.89	20.00	-27.89	T4	
		10MHz	40620	00386	15.00	-33.39		1.50	48.39	20.00	-28.39	T4	
		10MHz	40185	00386	14.97	-33.87		1.51	48.84	20.00	-28.84	T4	
		10MHz	39750	00386	15.21	-33.64		1.50	48.85	20.00	-28.85	T4	
		5MHz	40620	00386	15.08	-33.32		1.38	48.40	20.00	-28.40	T4	
		Radial	20MHz	40620	00386	7.81		-41.17	-62.60	N/A	48.98	20.00	
	15MHz		41490	00386	7.69	-40.45	48.14	20.00			-28.14	T4	
	15MHz		41055	00386	7.79	-39.99	47.78	20.00			-27.78	T4	
	15MHz		40620	00386	7.82	-40.78	48.60	20.00			-28.60	T4	
	15MHz		40185	00386	7.86	-41.03	48.89	20.00			-28.89	T4	
	15MHz		39750	00386	7.82	-38.78	46.60	20.00			-26.60	T4	
	10MHz		40620	00386	7.78	-40.85	48.63	20.00			-28.63	T4	
	5MHz		40620	00386	7.82	-40.91	48.73	20.00			-28.73	T4	



FCC ID: ZNFV450PM	 PCTEST ENGINEERING LABORATORY, INC.	HAC (T-COIL) TEST REPORT	 LG	Approved by: Quality Manager
Filename: 1M1811230205-13-R4.ZNF	Test Dates: 01/07/2019 - 01/22/2019	DUT Type: Portable Handset	Page 36 of 90	

Table 9-22
Raw Data Results for NR Band n41 (OTT VoIP)

Mode	Orientation	Bandwidth	Channel	DUT S/N	ABM1 [dB(A/m)]	ABM2 [dB(A/m)]	Ambient Noise [dB(A/m)]	Frequency Response Margin (dB)	S+N/N (dB)	FCC Limit (dB)	Margin from FCC Limit (dB)	C63.19-2011 Rating	Test Coordinates
NR n41	Axial	60MHz	531996	00386	14.96	-38.93	-63.39	N/A	53.89	20.00	-33.89	T4	2.2, 3.4
		60MHz	525300	00386	14.96	-41.22			56.18	20.00	-36.18	T4	
		60MHz	518598	00386	14.96	-38.38			53.34	20.00	-33.34	T4	
		60MHz	511902	00386	14.96	-38.44			53.40	20.00	-33.40	T4	
		60MHz	505200	00386	14.96	-39.71			54.67	20.00	-34.67	T4	
		40MHz	518598	00386	14.96	-39.47			54.43	20.00	-34.43	T4	
		60MHz	531996	00386	7.69	-46.34			54.03	20.00	-34.03	T4	
	Radial	60MHz	525300	00386	7.69	-45.89	-64.63	N/A	53.58	20.00	-33.58	T4	2.2, 2.2
		60MHz	518598	00386	7.69	-45.03			52.72	20.00	-32.72	T4	
		60MHz	511902	00386	7.69	-45.51			53.20	20.00	-33.20	T4	
		60MHz	505200	00386	7.69	-45.15			52.84	20.00	-32.84	T4	
		40MHz	518598	00386	7.69	-46.07			53.76	20.00	-33.76	T4	

Table 9-23
Raw Data Results for 2.4GHz WIFI (OTT VoIP)

Mode	Orientation	Channel	DUT S/N	ABM1 [dB(A/m)]	ABM2 [dB(A/m)]	Ambient Noise [dB(A/m)]	Frequency Response Margin (dB)	S+N/N (dB)	FCC Limit (dB)	Margin from FCC Limit (dB)	C63.19-2011 Rating	Test Coordinates
IEEE 802.11b	Axial	6	00444	15.89	-32.91	-63.19	1.47	48.80	20.00	-28.80	T4	2.2,3.4
	Radial	6	00444	8.33	-41.44	-62.60	N/A	49.77	20.00	-29.77	T4	2.2,2.2
IEEE 802.11g	Axial	6	00444	15.69	-31.95	-63.19	1.42	47.64	20.00	-27.64	T4	2.2,3.4
	Radial	6	00444	8.31	-34.78	-62.60	N/A	43.09	20.00	-23.09	T4	2.2,2.2
IEEE 802.11n	Axial	1	00444	15.57	-31.41	-63.19	1.49	46.98	20.00	-26.98	T4	2.2,3.4
		6	00444	15.80	-31.20		1.45	47.00	20.00	-27.00	T4	
		11	00444	15.74	-31.58		1.44	47.32	20.00	-27.32	T4	
	Radial	1	00444	8.35	-33.04	-62.60	N/A	41.39	20.00	-21.39	T4	2.2,2.2
		6	00444	8.41	-33.69		42.10	20.00	-22.10	T4		
		11	00444	8.67	-33.97		42.64	20.00	-22.64	T4		
IEEE 802.11ac	Axial	6	00444	15.69	-31.65	-63.19	1.44	47.34	20.00	-27.34	T4	2.2,3.4
	Radial	6	00444	8.15	-35.15	-62.60	N/A	43.30	20.00	-23.30	T4	2.2,2.2

Table 9-24
Raw Data Results for 5GHz WIFI 802.11a (OTT VoIP)

Mode	Orientation	Bandwidth	U-NII	Channel	DUT S/N	ABM1 [dB(A/m)]	ABM2 [dB(A/m)]	Ambient Noise [dB(A/m)]	Frequency Response Margin (dB)	S+N/N (dB)	FCC Limit (dB)	Margin from FCC Limit (dB)	C63.19-2011 Rating	Test Coordinates
IEEE 802.11a	Axial	20MHz	1	40	00444	15.76	-41.25	-63.19	1.46	57.01	20.00	-37.01	T4	2.2,3.4
		20MHz	2A	56	00444	15.64	-43.00		1.43	58.64	20.00	-38.64	T4	
		20MHz	2C	100	00444	15.77	-41.14		1.47	56.91	20.00	-36.91	T4	
		20MHz	2C	120	00444	15.41	-40.66		1.43	56.07	20.00	-36.07	T4	
		20MHz	2C	144	00444	15.65	-40.54		1.45	56.19	20.00	-36.19	T4	
		20MHz	3	157	00444	15.66	-42.98		1.47	58.64	20.00	-38.64	T4	
		Radial	20MHz	1	40	00444	8.16		-28.38	-62.60	N/A	36.54	20.00	
	20MHz		2A	52	00444	8.28	-28.55	36.83	20.00		-16.83	T4		
	20MHz		2A	56	00444	8.13	-28.22	36.35	20.00		-16.35	T4		
	20MHz		2A	64	00444	8.23	-28.58	36.81	20.00		-16.81	T4		
	20MHz		2C	120	00444	8.19	-28.50	36.69	20.00		-16.69	T4		
	20MHz		3	157	00444	8.15	-29.63	37.78	20.00		-17.78	T4		

Table 9-25
Raw Data Results for 5GHz WIFI 802.11n (OTT VoIP)

Mode	Orientation	Bandwidth	U-NII	Channel	DUT S/N	ABM1 [dB(A/m)]	ABM2 [dB(A/m)]	Ambient Noise [dB(A/m)]	Frequency Response Margin (dB)	S+N/N (dB)	FCC Limit (dB)	Margin from FCC Limit (dB)	C63.19-2011 Rating	Test Coordinates
IEEE 802.11n	Axial	40MHz	1	38	00444	15.73	-41.32	-63.19	1.44	57.05	20.00	-37.05	T4	2.2,3.4
		20MHz	1	40	00444	15.60	-42.31		1.45	57.91	20.00	-37.91	T4	
	Radial	40MHz	1	38	00444	8.23	-29.85	-62.60	N/A	38.08	20.00	-18.08	T4	2.2,2.2
		20MHz	1	40	00444	8.16	-28.82		36.98	20.00	-16.98	T4		



FCC ID: ZNFV450PM		HAC (T-COIL) TEST REPORT		Approved by: Quality Manager
Filename: 1M1811230205-13-R4.ZNF	Test Dates: 01/07/2019 - 01/22/2019	DUT Type: Portable Handset		Page 37 of 90

Table 9-26
Raw Data Results for 5GHz WIFI 802.11ac (OTT VoIP)

Mode	Orientation	Bandwidth	U-NII	Channel	DUT S/N	ABM1 [dB(A/m)]	ABM2 [dB(A/m)]	Ambient Noise [dB(A/m)]	Frequency Response Margin (dB)	S+N/N (dB)	FCC Limit (dB)	Margin from FCC Limit (dB)	C63.19-2011 Rating	Test Coordinates
IEEE 802.11ac	Axial	40MHz	1	38	00444	15.68	-44.96	-63.19	1.45	60.64	20.00	-40.64	T4	2.2.3.4
		20MHz	1	40	00444	15.72	-44.02		1.47	59.74	20.00	-39.74	T4	
	Radial	40MHz	1	38	00444	8.23	-33.14	-62.60	N/A	41.37	20.00	-21.37	T4	
		20MHz	1	40	00444	8.20	-33.28			41.48	20.00	-21.48	T4	

II. Test Notes

A. General

1. Phone Condition: Mute on; Backlight off; Max Volume; Max Contrast
2. 'Radial' orientation refers to radial transverse.
3. Hearing Aid Mode (**Phone→Call Settings→Additional Settings→Hearing aids**) was set to ON for Frequency Response compliance
4. Speech Signal: ITU-T P.50 Artificial Voice
5. Bluetooth and WIFI were disabled while testing 2G/3G/4G modes.
6. Licensed data modes and Bluetooth were disabled while testing WIFI modes.
7. The Margin from FCC limit column indicates a margin from the FCC limit for compliance (T3).

B. CDMA

1. Power Configuration: Power Control Bits = "All Up"
2. Vocoder Configuration: RC1/SO3 (CDMA – EVRC)

C. GSM

1. Power Configuration: GSM850: PCL=5, GSM1900: PCL=0;
2. Vocoder Configuration: EFR (GSM);

D. UMTS



1. Power Configuration: TPC= "All 1s";
2. Vocoder Configuration: AMR 12.2 kbps (UMTS);

E. LTE FDD

1. Power Configuration: TPC = "Max Power"
2. Radio Configuration: 16QAM, 1RB, 0RB offset
3. Vocoder Configuration: WB AMR 6.60kbps
4. The worst-case band and bandwidth combination for each probe orientation is additionally tested on the low and high channels for those combinations. LTE Band 66 at 20MHz is the worst-case for the Axial probe orientation. LTE Band 66 at 3MHz is the worst-case for the Radial probe orientation.

F. LTE TDD

1. Power Configuration: TPC = "Max Power"
2. Radio Configuration: 16QAM, 1RB, 0RB offset
3. Power Class 3 Uplink-Downlink configuration: 6
4. Power Class 2 Uplink-Downlink configuration: 1
5. Vocoder Configuration: WB AMR 6.60kbps
6. The worst-case band and bandwidth combination for each probe orientation is additionally tested on the low, low-mid, mid-high and high channels for those combinations. LTE Band 41 (PC2) at 10MHz is the worst-case for the Axial probe orientation. LTE Band 41 (PC2) at 5MHz bandwidth is the worst-case for the Radial probe orientation.



FCC ID: ZNFV450PM	 PCTEST ENGINEERING LABORATORY, INC.	HAC (T-COIL) TEST REPORT	 LG	Approved by: Quality Manager
Filename: 1M1811230205-13-R4.ZNF	Test Dates: 01/07/2019 - 01/22/2019	DUT Type: Portable Handset	Page 38 of 90	

G. WIFI

1. Radio Configuration
 - a. 802.11b: CCK, 5.5Mbps
 - b. 802.11g/a: BPSK, 9Mbps
 - c. 802.11n/ac 20MHz: BPSK, 6.5Mbps
 - d. 802.11n/ac 40MHz: BPSK, 13.5Mbps
2. Vocoder Configuration: WB AMR 6.60kbps
3. The worst-case standard for 2.4GHz WIFI in each probe orientation is additionally tested on the low and high channels. 802.11b is the worst-case for both the Axial and Radial probe orientation.
4. The worst-case standard for 5GHz WIFI in each probe orientation is additionally tested on higher U-NII bands as well as applicable low and high channels. 802.11n (40MHz BW, U-NII 3) is the worst-case for the Axial probe orientation. 802.11n (20MHz BW, U-NII 2C) is the worst-case for the Radial probe orientation.

H. OTT VoIP

1. Vocoder Configuration: 64kbps
2. EvDO Configuration
 - a. Revision: A
3. EDGE Configuration
 - a. MCS Index: 7
 - b. Number of TX slots: 2
4. HSPA Configuration:
 - a. Release: 6
 - b. 3GPP 34.121 Subtest 1
5. LTE FDD Configuration:
 - a. Power Configuration: TPC = "Max Power"
 - b. Radio Configuration: 16QAM, 1RB, 0RB offset
 - c. LTE Band 12 was the worst-case band from Table 7-6 and was used to test both Axial and Radial probe orientations.
 - d. The worst-case band and bandwidth combination for each probe orientation is additionally tested on the low and high channels for those combinations. LTE Band 12 at 5MHz is the worst-case for the Axial probe orientation. LTE Band 12 at 10MHz bandwidth is the worst-case for the Radial probe orientation.
6. LTE TDD Configuration:
 - a. Power Configuration: TPC = "Max Power"
 - b. Radio Configuration: 16QAM, 1RB, 0RB offset
 - c. Power Class 2 Uplink-Downlink configuration: 1
 - d. LTE Band 41 (Power Class 2) was the worst-case band from Table 7-7 and was used to test both Axial and Radial probe orientations.
 - e. The worst-case band and bandwidth combination for each probe orientation is additionally tested on the low, low-mid, high-mid, and high channels for those combinations. LTE Band 41 (Power Class 2) at 10MHz is the worst-case for the Axial probe orientation and LTE Band 41 (Power Class 2) at 15MHz is the Radial probe orientation.
7. NR Band n41 Configuration:
 - a. Power Configuration: TxAGC is set such that DUT operates at max power
 - b. Radio Configuration: CP-OFDM 64QAM, 1RB, 1RB offset
 - c. Due to equipment limitations, ABM1 measurements were not possible. Therefore, the worst-case ABM1 measurements from LTE TDD OTT VoIP testing for Axial and Radial were combined with NR Band n41 ABM2 measurements to obtain SNNR values. Additionally, Frequency Response measurements were not possible due to equipment limitations.

FCC ID: ZNFV450PM		HAC (T-COIL) TEST REPORT		Approved by: Quality Manager
Filename: 1M1811230205-13-R4.ZNF	Test Dates: 01/07/2019 - 01/22/2019	DUT Type: Portable Handset	Page 39 of 90	

8. WIFI Configuration:

- a. Radio Configuration
 - i. 802.11b: CCK, 5.5Mbps
 - ii. 802.11g/a: BPSK, 9Mbps
 - iii. 802.11n/ac 20MHz: BPSK, 6.5Mbps
 - iv. 802.11n/ac 40MHz: BPSK, 13.5Mbps
- b. The worst-case standard for 2.4GHz WIFI in each probe orientation is additionally tested on the low and high channels. 802.11n is the worst-case for both the Axial and Radial probe orientations.
- c. The worst-case standard for 5GHz WIFI in each probe orientation is additionally tested on higher U-NII bands as well as applicable low and high channels. 802.11a (U-NII 2C) is the worst-case for the Axial probe orientation. 802.11a (U-NII 2A) is the worst-case for the Radial probe orientation.

III. 1 kHz Vocoder Application Check

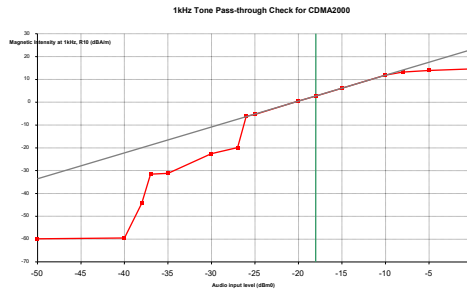

This model was verified to be within the linear region for ABM1 measurements at -18 dBm0 for CDMA. This measurement was taken in the axial configuration above the maximum location.

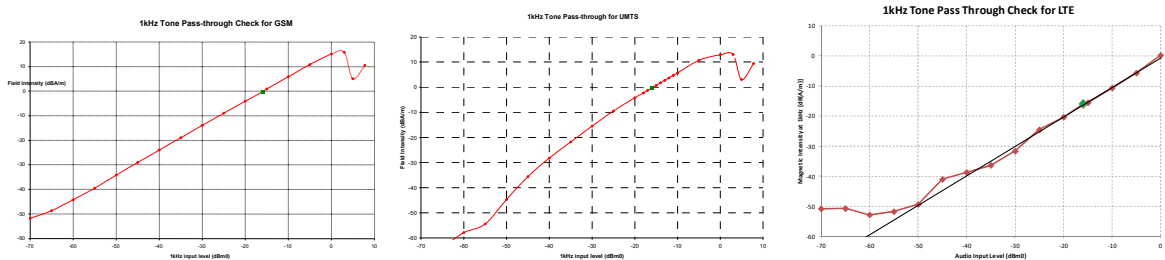

This model was verified to be within the linear region for ABM1 measurements at -16 dBm0 for GSM, UMTS, and VoLTE over IMS. This measurement was taken in the axial configuration above the maximum location.

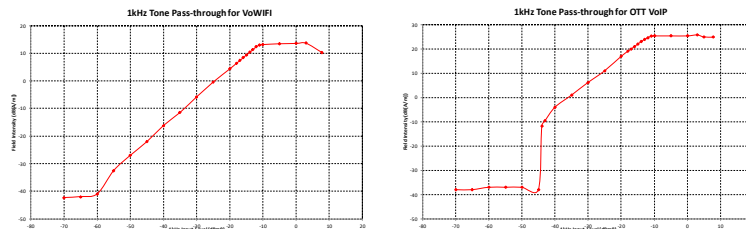

This model was verified to be within the linear region for ABM1 measurements at -20 dBm0 for VoWiFi over IMS and OTT VoIP. This measurement was taken in the axial configuration above the maximum location.

FCC ID: ZNFV450PM	PCTEST ENGINEERING LABORATORY, INC.	HAC (T-COIL) TEST REPORT	LG	Approved by: Quality Manager
Filename: 1M1811230205-13-R4.ZNF	Test Dates: 01/07/2019 - 01/22/2019	DUT Type: Portable Handset		Page 40 of 90

IV. T-Coil Validation Test Results

**Table 9-27
Helmholtz Coil Validation Table of Results – 01/07/2019**



Item	Target	Result	Verdict
Axial			
Magnetic Intensity, -10 dBA/m	-10 ± 0.5 dB	-9.793	PASS
Environmental Noise	< -58 dBA/m	-61.64	PASS
Frequency Response, from limits	> 0 dB	0.80	PASS
Radial			
Magnetic Intensity, -10 dBA/m	-10 ± 0.5 dB	-10.041	PASS
Environmental Noise	< -58 dBA/m	-61.59	PASS
Frequency Response, from limits	> 0 dB	0.80	PASS

**Table 9-28
Helmholtz Coil Validation Table of Results – 01/14/2019**

Item	Target	Result	Verdict
Axial			
Magnetic Intensity, -10 dBA/m	-10 ± 0.5 dB	-9.758	PASS
Environmental Noise	< -58 dBA/m	-63.19	PASS
Frequency Response, from limits	> 0 dB	0.70	PASS
Radial			
Magnetic Intensity, -10 dBA/m	-10 ± 0.5 dB	-10.032	PASS
Environmental Noise	< -58 dBA/m	-62.60	PASS
Frequency Response, from limits	> 0 dB	0.80	PASS

**Table 9-29
Helmholtz Coil Validation Table of Results – 01/22/2019**

Item	Target	Result	Verdict
Axial			
Magnetic Intensity, -10 dBA/m	-10 ± 0.5 dB	-9.881	PASS
Environmental Noise	< -58 dBA/m	-63.39	PASS
Frequency Response, from limits	> 0 dB	0.80	PASS
Radial			
Magnetic Intensity, -10 dBA/m	-10 ± 0.5 dB	-9.994	PASS
Environmental Noise	< -58 dBA/m	-64.63	PASS
Frequency Response, from limits	> 0 dB	0.80	PASS

FCC ID: ZNFV450PM	 PCTEST ENGINEERING LABORATORY, INC.	HAC (T-COIL) TEST REPORT	 LG	Approved by: Quality Manager
Filename: 1M1811230205-13-R4.ZNF	Test Dates: 01/07/2019 - 01/22/2019	DUT Type: Portable Handset	Page 41 of 90	

© 2019 PCTEST Engineering Laboratory, Inc.

REV 3.2.M
04/17/2018

© 2019 PCTEST Engineering Laboratory, Inc. All rights reserved. Unless otherwise specified, no part of this report may be reproduced or utilized in any part, form or by any means, electronic or mechanical, including photocopying and microfilm, without permission in writing from PCTEST Engineering Laboratory, Inc. If you have any questions about this international copyright or have an enquiry about obtaining additional rights to this report or assembly of contents thereof, please contact INFO@PCTEST.COM.

V. ABM1 Magnetic Field Distribution Scan Overlays

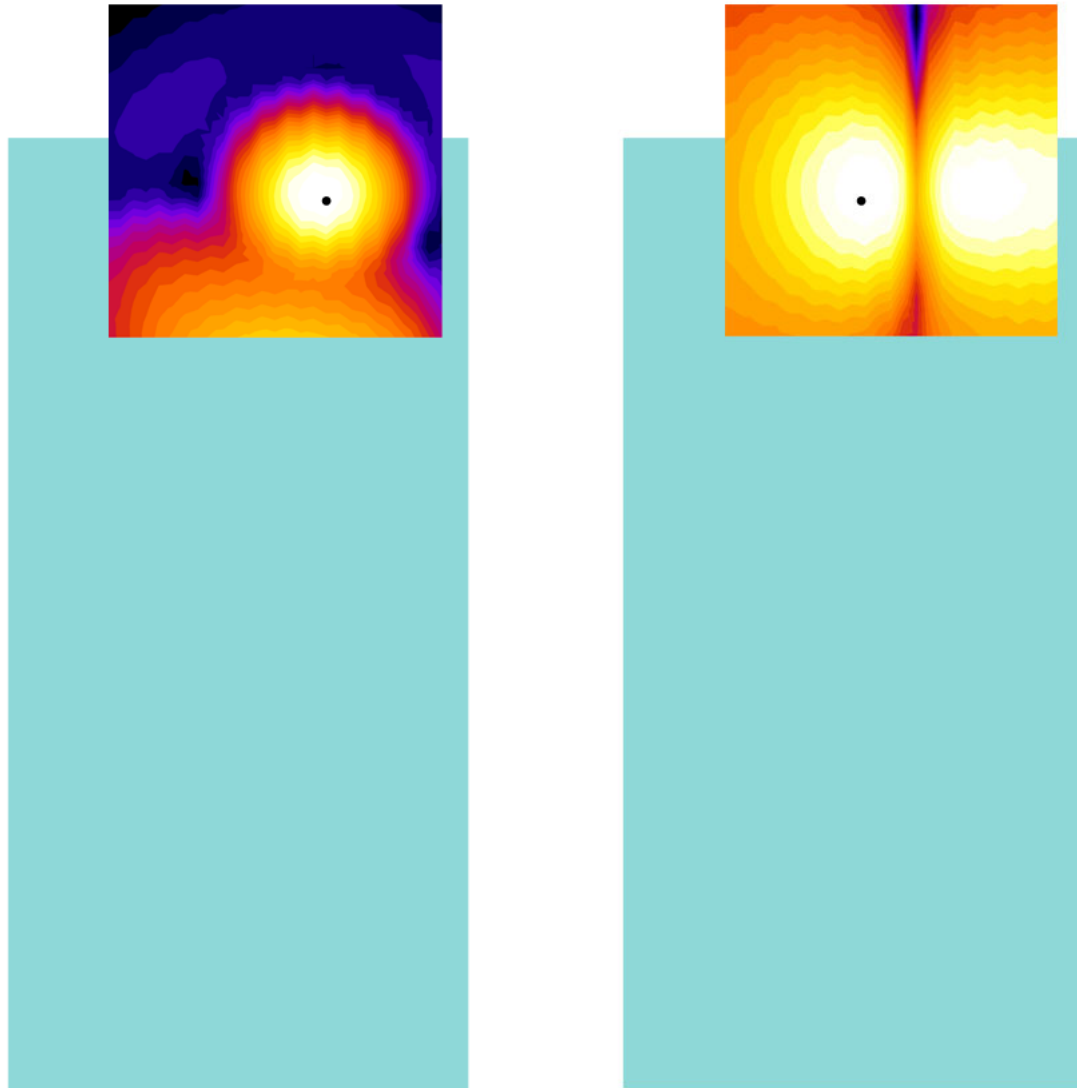



Axial

Radial (Transverse)

**Figure 9-1
T-Coil Scan Overlay Magnetic Field Distributions**

Notes:

1. Final measurement locations are indicated by a cursor on the contour plots.
2. See Test Setup Photographs for actual WD overlay.

FCC ID: ZNFV450PM		HAC (T-COIL) TEST REPORT		Approved by: Quality Manager
Filename: 1M1811230205-13-R4.ZNF	Test Dates: 01/07/2019 - 01/22/2019	DUT Type: Portable Handset	Page 42 of 90	

10. MEASUREMENT UNCERTAINTY



**Table 10-1
Uncertainty Estimation Table**

Contribution	Data +/- %	Data +/- dB	Data Type	Probability distribution	Divisor	Standard uncertainty	Standard Uncertainty (dB)
ABM Noise	7.0%	0.29	Std. Dev.	Normal k=1	1.00	7.0%	
RF Reflections	4.7%	0.20	Specification	Rectangular	1.73	2.7%	
Reference Signal Level	12.2%	0.50	Specification	Rectangular	1.73	7.0%	
Positioning Accuracy	10.0%	0.41	Uncertainty	Rectangular	1.73	5.8%	
Probe Coil Sensitivity	12.2%	0.50	Specification	Rectangular	1.73	7.0%	
Probe Linearity	2.4%	0.10	Std. Dev.	Normal k=1	1.00	2.4%	
Cable Loss	2.8%	0.12	Specification	Rectangular	1.73	1.6%	
Frequency Analyzer	5.0%	0.21	Specification	Rectangular	1.73	2.9%	
System Repeatability	5.0%	0.21	Std. Dev.	Normal k=1	1.00	5.0%	
WD Repeatability	9.0%	0.37	Std. Dev.	Normal k=1	1.00	9.0%	
Positioner Accuracy	1.0%	0.04	Specification	Rectangular	1.73	0.6%	
Combined standard uncertainty, uc (k=1)						17.7%	0.71
Expanded uncertainty (k=2), 95% confidence level						35.3%	1.31

Notes:

1. Test equipments are calibrated according to techniques outlined in NIS81, NIS3003 and NIST Tech Note 1297.
2. All equipments have traceability according to NIST. Measurement Uncertainties are defined in further detail in NIS 81 and NIST Tech Note 1297 and UKAS M3003.



Measurement uncertainty reflects the quality and accuracy of a measured result as compared to the true value. Such statements are generally required when stating results of measurements so that it is clear to the intended audience that the results may differ when reproduced by different facilities. Measurement results vary due to the measurement uncertainty of the instrumentation, measurement technique, and test engineer. Most uncertainties are calculated using the tolerances of the instrumentation used in the measurement, the measurement setup variability, and the technique used in performing the test. While not generally included, the variability of the equipment under test also figures into the overall measurement uncertainty. Another component of the overall uncertainty is based on the variability of repeated measurements (so-called Type A uncertainty). This may mean that the Hearing Aid compatibility tests may have to be repeated by taking down the test setup and resetting it up so that there are a statistically significant number of repeat measurements to identify the measurement uncertainty. By combining the repeat measurement results with that of the instrumentation chain using the technique contained in NIS 81 and NIS 3003, the overall measurement uncertainty was estimated.

FCC ID: ZNFV450PM		HAC (T-COIL) TEST REPORT		Approved by: Quality Manager
Filename: 1M1811230205-13-R4.ZNF	Test Dates: 01/07/2019 - 01/22/2019	DUT Type: Portable Handset		Page 43 of 90

11. EQUIPMENT LIST

**Table 11-1
Equipment List**

Manufacturer	Model	Description	Cal Date	Cal Interval	Cal Due	Serial Number
Control Company	4040	Temperature / Humidity Monitor	2/28/2018	Biennial	2/28/2020	150761911
Dell	Latitude E6540	SoundCheck Acoustic Analyzer Laptop	4/11/2017	Biennial	4/11/2019	7BFNM32
Listen	SoundConnect	Microphone Power Supply	9/6/2018	Biennial	9/6/2020	0899-PS150
RME	Fireface UC	Soundcheck Acoustic Analyzer External Audio Interface	4/11/2017	Biennial	4/11/2019	23528889
Rohde & Schwarz	CMW500	Wideband Radio Communication Tester	1/19/2018	Annual	1/19/2019	162125
Rohde & Schwarz	CMW500	Radio Communication tester	8/3/2018	Annual	8/3/2019	140144
Rohde & Schwarz	CMW500	Radio Communication Tester	4/20/2018	Annual	4/20/2019	128635
Seekonk	NC-100	Torque Wrench (8" lb)	5/10/2018	Biennial	5/10/2020	21053
TEM	Axial T-Coil Probe	Axial T-Coil Probe	9/19/2018	Biennial	9/19/2020	TEM-1123
TEM	Radial T-Coil Probe	Radial T-Coil Probe	9/19/2018	Biennial	9/19/2020	TEM-1129
TEM	Helmholtz Coil	Helmholtz Coil	10/10/2018	Biennial	10/10/2020	SBI 1052
TEM		HAC System Controller with Software	N/A		N/A	N/A
TEM		HAC Positioner	N/A		N/A	N/A



FCC ID: ZNFV450PM	 PCTEST ENGINEERING LABORATORY, INC.	HAC (T-COIL) TEST REPORT		Approved by: Quality Manager
Filename: 1M1811230205-13-R4.ZNF	Test Dates: 01/07/2019 - 01/22/2019	DUT Type: Portable Handset		Page 44 of 90

© 2019 PCTEST Engineering Laboratory, Inc.

REV 3.2.M
04/17/2018

© 2019 PCTEST Engineering Laboratory, Inc. All rights reserved. Unless otherwise specified, no part of this report may be reproduced or utilized in any part, form or by any means, electronic or mechanical, including photocopying and microfilm, without permission in writing from PCTEST Engineering Laboratory, Inc. If you have any questions about this international copyright or have an enquiry about obtaining additional rights to this report or assembly of contents thereof, please contact INFO@PCTEST.COM.

12. TEST DATA

FCC ID: ZNFV450PM		HAC (T-COIL) TEST REPORT		Approved by: Quality Manager
Filename: 1M1811230205-13-R4.ZNF	Test Dates: 01/07/2019 - 01/22/2019	DUT Type: Portable Handset	Page 45 of 90	

© 2019 PCTEST Engineering Laboratory, Inc.

REV 3.2.M
04/17/2018

© 2019 PCTEST Engineering Laboratory, Inc. All rights reserved. Unless otherwise specified, no part of this report may be reproduced or utilized in any part, form or by any means, electronic or mechanical, including photocopying and microfilm, without permission in writing from PCTEST Engineering Laboratory, Inc. If you have any questions about this international copyright or have an enquiry about obtaining additional rights to this report or assembly of contents thereof, please contact INFO@PCTEST.COM.



PCTEST Hearing-Aid Compatibility Facility

DUT: HH Coil – SN: SBI 1052

Type: HH Coil
Serial: SBI 1052

Measurement Standard: ANSI C63.19-2011

Equipment:

- Probe: Axial T-Coil Probe – SN: TEM-1123; Calibrated: 09/19/2018
- Helmholtz Coil – SN: SBI 1052; Calibrated: 10/10/2018

Noise Spectrum

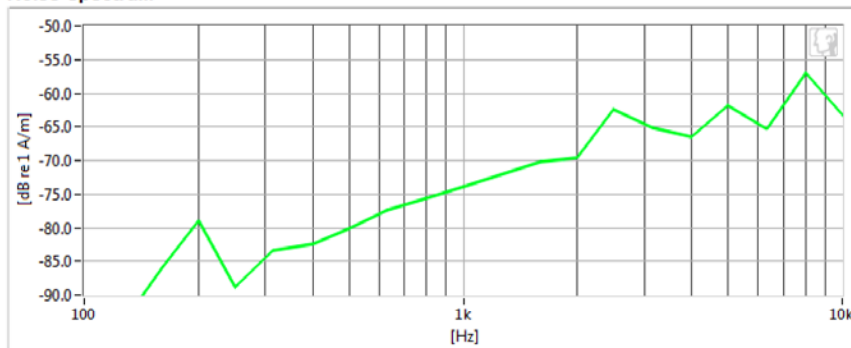

Frequency Response

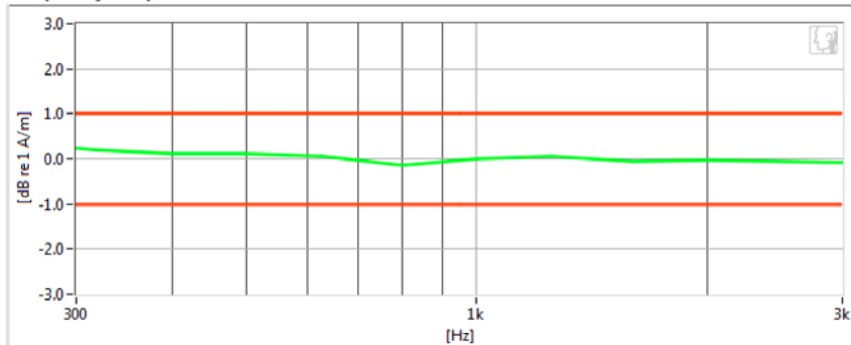

Results

Verification 1kHz Intensity	-9.793 dB	✓	Max/Min	-9.5/-10.5
Verification ABM2	-61.64 dB	✓	Maximum	-58.0
Frequency Response Margin	800m dB	✓	Tolerance curves	Aligned Data

PCTEST 2019

FCC ID: ZNFV450PM		HAC (T-COIL) TEST REPORT		Approved by: Quality Manager
Filename: 1M1811230205-13-R4.ZNF	Test Dates: 01/07/2019 - 01/22/2019	DUT Type: Portable Handset		Page 46 of 90

© 2019 PCTEST Engineering Laboratory, Inc.

REV 3.2.M
04/17/2018

© 2019 PCTEST Engineering Laboratory, Inc. All rights reserved. Unless otherwise specified, no part of this report may be reproduced or utilized in any part, form or by any means, electronic or mechanical, including photocopying and microfilm, without permission in writing from PCTEST Engineering Laboratory, Inc. If you have any questions about this international copyright or have an enquiry about obtaining additional rights to this report or assembly of contents thereof, please contact INFO@PCTEST.COM.



PCTEST Hearing-Aid Compatibility Facility

DUT: HH Coil – SN: SBI 1052

Type: HH Coil
Serial: SBI 1052

Measurement Standard: ANSI C63.19-2011

Equipment:

- Probe: Axial T-Coil Probe – SN: TEM-1123; Calibrated: 09/19/2018
- Helmholtz Coil – SN: SBI 1052; Calibrated: 10/10/2018

Noise Spectrum

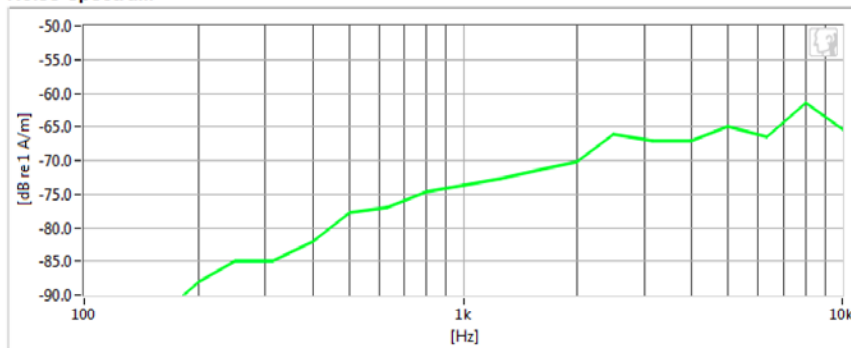

Frequency Response

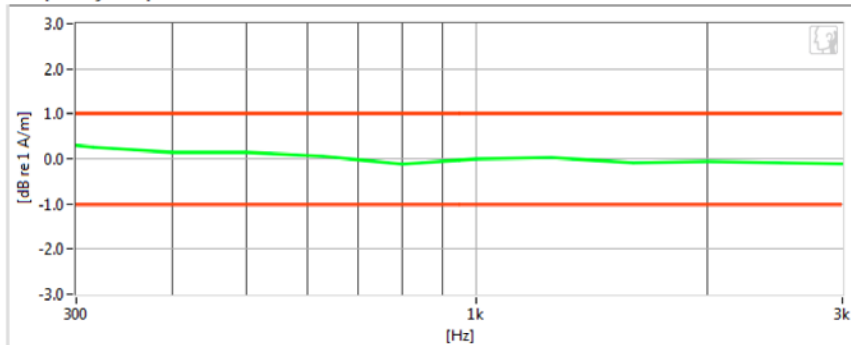

Results

Verification 1kHz Intensity	-9.758 dB	✓	Max/Min	-9.5/-10.5
Verification ABM2	-63.19 dB	✓	Maximum	-58.0
Frequency Response Margin	700m dB	✓	Tolerance curves	Aligned Data

PCTEST 2019

FCC ID: ZNFV450PM		HAC (T-COIL) TEST REPORT		Approved by: Quality Manager
Filename: 1M1811230205-13-R4.ZNF	Test Dates: 01/07/2019 - 01/22/2019	DUT Type: Portable Handset		Page 47 of 90

© 2019 PCTEST Engineering Laboratory, Inc.

REV 3.2.M
04/17/2018

© 2019 PCTEST Engineering Laboratory, Inc. All rights reserved. Unless otherwise specified, no part of this report may be reproduced or utilized in any part, form or by any means, electronic or mechanical, including photocopying and microfilm, without permission in writing from PCTEST Engineering Laboratory, Inc. If you have any questions about this international copyright or have an enquiry about obtaining additional rights to this report or assembly of contents thereof, please contact INFO@PCTEST.COM.



PCTEST Hearing-Aid Compatibility Facility

DUT: HH Coil – SN: SBI 1052

Type: HH Coil
Serial: SBI 1052

Measurement Standard: ANSI C63.19-2011

Equipment:

- Probe: Axial T-Coil Probe – SN: TEM-1123; Calibrated: 09/19/2018
- Helmholtz Coil – SN: SBI 1052; Calibrated: 10/10/2018

Noise Spectrum

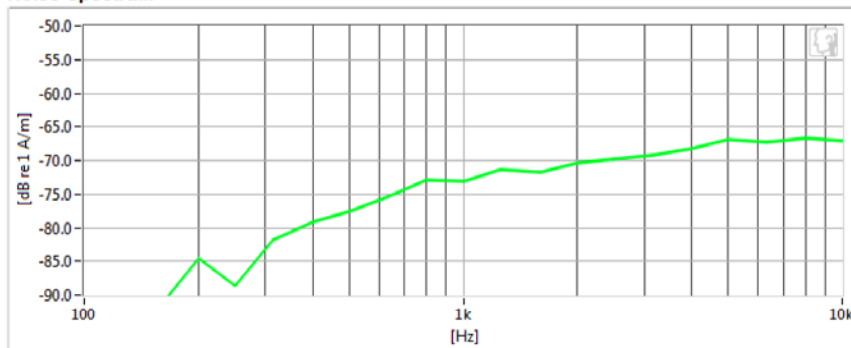

Frequency Response

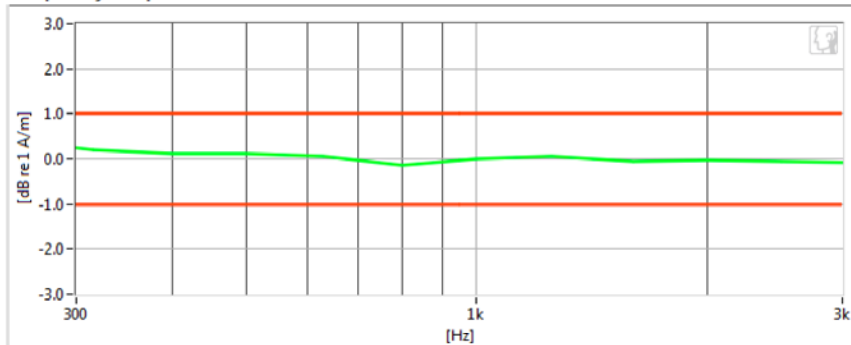

Results

Verification 1kHz Intensity	-9.881 dB	✓	Max/Min	-9.5/-10.5
Verification ABM2	-63.39 dB	✓	Maximum	-58.0
Frequency Response Margin	800m dB	✓	Tolerance curves	Aligned Data

PCTEST 2019

FCC ID: ZNFV450PM		HAC (T-COIL) TEST REPORT		Approved by: Quality Manager
Filename: 1M1811230205-13-R4.ZNF	Test Dates: 01/07/2019 - 01/22/2019	DUT Type: Portable Handset		Page 48 of 90

© 2019 PCTEST Engineering Laboratory, Inc.

REV 3.2.M

04/17/2018

© 2019 PCTEST Engineering Laboratory, Inc. All rights reserved. Unless otherwise specified, no part of this report may be reproduced or utilized in any part, form or by any means, electronic or mechanical, including photocopying and microfilm, without permission in writing from PCTEST Engineering Laboratory, Inc. If you have any questions about this international copyright or have an enquiry about obtaining additional rights to this report or assembly of contents thereof, please contact INFO@PCTEST.COM.



PCTEST Hearing-Aid Compatibility Facility

DUT: HH Coil – SN: SBI 1052

Type: HH Coil
Serial: SBI 1052

Measurement Standard: ANSI C63.19-2011

Equipment:

- Probe: Radial T-Coil Probe – SN: TEM-1129; Calibrated: 09/19/2018
- Helmholtz Coil – SN: SBI 1052; Calibrated: 10/10/2018

Noise Spectrum

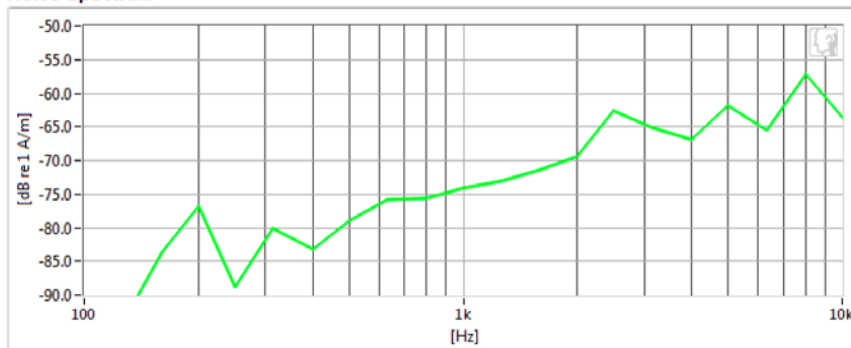

Frequency Response

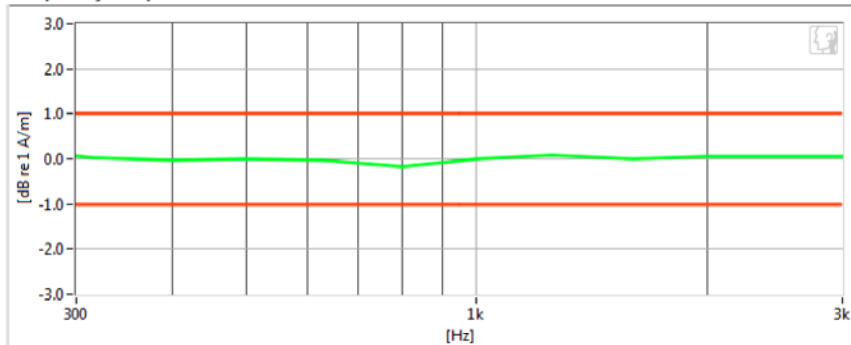

Results

Verification 1kHz Intensity	-10.041 dB	✓	Max/Min	-9.5/-10.5
Verification ABM2	-61.59 dB	✓	Maximum	-58.0
Frequency Response Margin	800m dB	✓	Tolerance curves	Aligned Data

PCTEST 2019

FCC ID: ZNFV450PM		HAC (T-COIL) TEST REPORT		Approved by: Quality Manager
Filename: 1M1811230205-13-R4.ZNF	Test Dates: 01/07/2019 - 01/22/2019	DUT Type: Portable Handset		Page 49 of 90

© 2019 PCTEST Engineering Laboratory, Inc.

REV 3.2.M
04/17/2018

© 2019 PCTEST Engineering Laboratory, Inc. All rights reserved. Unless otherwise specified, no part of this report may be reproduced or utilized in any part, form or by any means, electronic or mechanical, including photocopying and microfilm, without permission in writing from PCTEST Engineering Laboratory, Inc. If you have any questions about this international copyright or have an enquiry about obtaining additional rights to this report or assembly of contents thereof, please contact INFO@PCTEST.COM.



PCTEST Hearing-Aid Compatibility Facility

DUT: HH Coil – SN: SBI 1052

Type: HH Coil
Serial: SBI 1052

Measurement Standard: ANSI C63.19-2011

Equipment:

- Probe: Radial T-Coil Probe – SN: TEM-1129; Calibrated: 09/19/2018
- Helmholtz Coil – SN: SBI 1052; Calibrated: 10/10/2018

Noise Spectrum

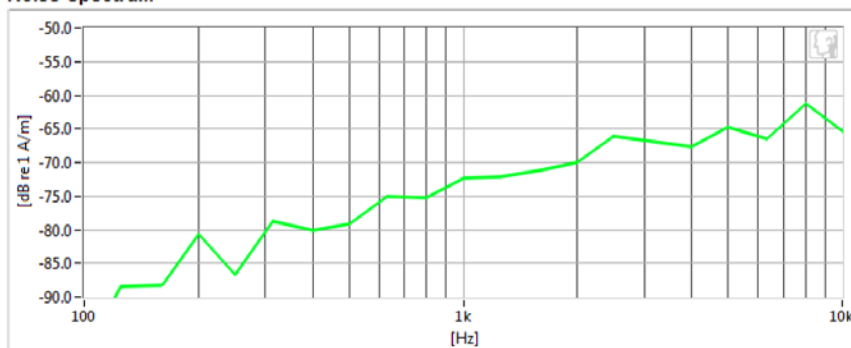

Frequency Response

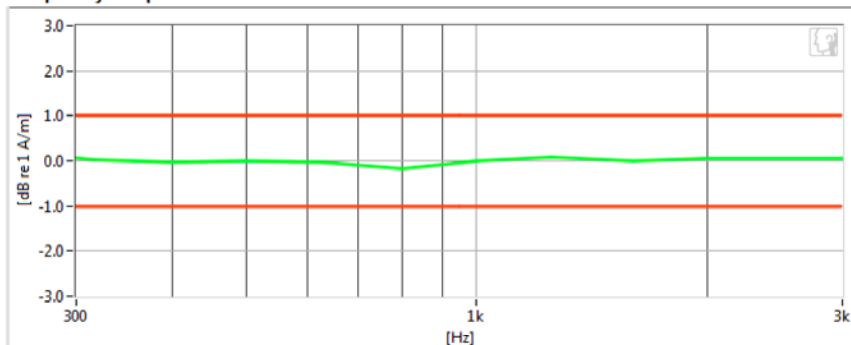

Results

Verification 1kHz Intensity	-10.032 dB	✓	Max/Min	-9.5/-10.5
Verification ABM2	-62.6 dB	✓	Maximum	-58.0
Frequency Response Margin	800m dB	✓	Tolerance curves	Aligned Data

PCTEST 2019

FCC ID: ZNFV450PM		HAC (T-COIL) TEST REPORT		Approved by: Quality Manager
Filename: 1M1811230205-13-R4.ZNF	Test Dates: 01/07/2019 - 01/22/2019	DUT Type: Portable Handset		Page 50 of 90

© 2019 PCTEST Engineering Laboratory, Inc.

REV 3.2.M
04/17/2018

© 2019 PCTEST Engineering Laboratory, Inc. All rights reserved. Unless otherwise specified, no part of this report may be reproduced or utilized in any part, form or by any means, electronic or mechanical, including photocopying and microfilm, without permission in writing from PCTEST Engineering Laboratory, Inc. If you have any questions about this international copyright or have an enquiry about obtaining additional rights to this report or assembly of contents thereof, please contact INFO@PCTEST.COM.



PCTEST Hearing-Aid Compatibility Facility

DUT: HH Coil – SN: SBI 1052

Type: HH Coil
Serial: SBI 1052

Measurement Standard: ANSI C63.19-2011

Equipment:

- Probe: Radial T-Coil Probe – SN: TEM-1129; Calibrated: 09/19/2018
- Helmholtz Coil – SN: SBI 1052; Calibrated: 10/10/2018

Noise Spectrum

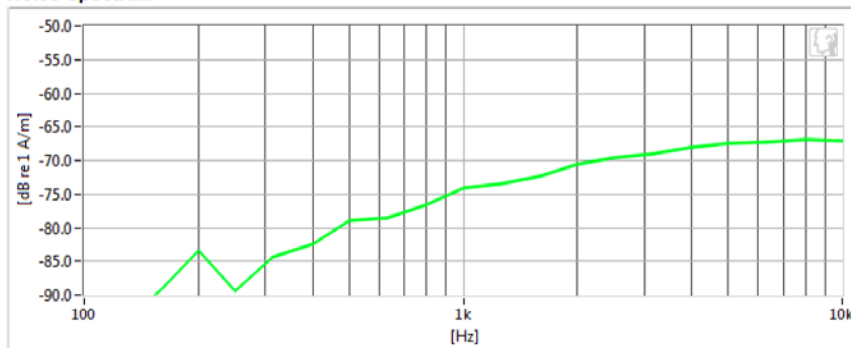

Frequency Response

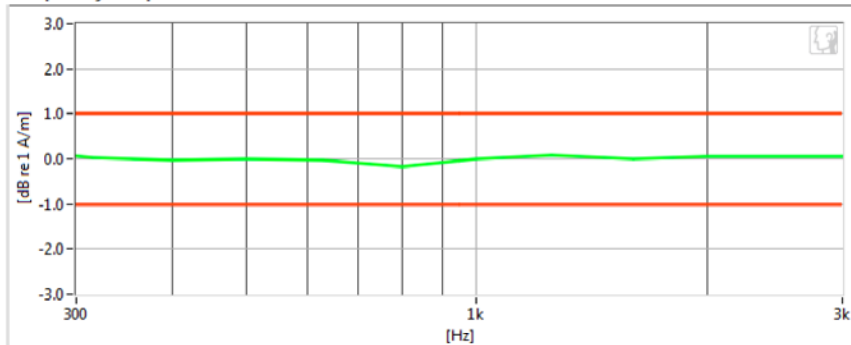

Results

Verification 1kHz Intensity	-9.994 dB	✓	Max/Min	-9.5/-10.5
Verification ABM2	-64.63 dB	✓	Maximum	-58.0
Frequency Response Margin	800m dB	✓	Tolerance curves	Aligned Data

PCTEST 2019

FCC ID: ZNFV450PM		HAC (T-COIL) TEST REPORT		Approved by: Quality Manager
Filename: 1M1811230205-13-R4.ZNF	Test Dates: 01/07/2019 - 01/22/2019	DUT Type: Portable Handset		Page 51 of 90

© 2019 PCTEST Engineering Laboratory, Inc.

REV 3.2.M
04/17/2018

© 2019 PCTEST Engineering Laboratory, Inc. All rights reserved. Unless otherwise specified, no part of this report may be reproduced or utilized in any part, form or by any means, electronic or mechanical, including photocopying and microfilm, without permission in writing from PCTEST Engineering Laboratory, Inc. If you have any questions about this international copyright or have an enquiry about obtaining additional rights to this report or assembly of contents thereof, please contact INFO@PCTEST.COM.



PCTEST Hearing-Aid Compatibility Facility

DUT: ZNFV450PM

Type: Portable Handset
Serial: 00386

Measurement Standard: ANSI C63.19-2011

Equipment:

- Probe: Axial T-Coil Probe – SN: TEM-1123; Calibrated: 09/19/2018

Test Configuration:

- Mode: Secondary Cellular CDMA
- Channel: 564
- Speech Signal: ITU-T P.50 Artificial Voice

Noise Spectrum

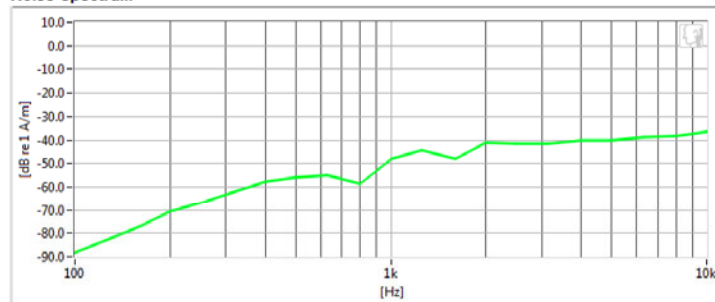

Frequency Response

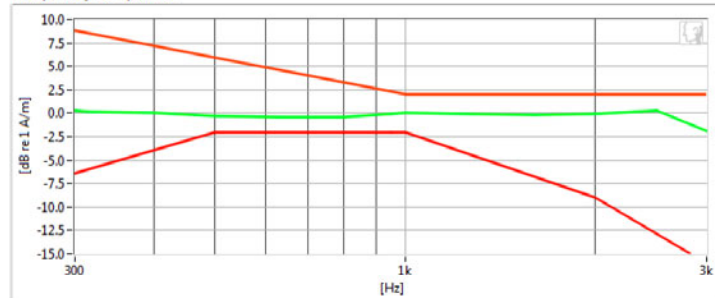

Results

ABM1	5.17 dB	✓	Minimum	-18.0
ABM2	-37.8 dB	✓	Maximum	0
SNNR	42.98 dB	✓	Minimum	20
Aligned Response - P.50	1.56 dB	✓	Tolerance curves	Aligned Data

PCTEST 2019

FCC ID: ZNFV450PM		HAC (T-COIL) TEST REPORT		Approved by: Quality Manager
Filename: 1M1811230205-13-R4.ZNF	Test Dates: 01/07/2019 - 01/22/2019	DUT Type: Portable Handset	Page 52 of 90	

© 2019 PCTEST Engineering Laboratory, Inc.

REV 3.2.M
04/17/2018

© 2019 PCTEST Engineering Laboratory, Inc. All rights reserved. Unless otherwise specified, no part of this report may be reproduced or utilized in any part, form or by any means, electronic or mechanical, including photocopying and microfilm, without permission in writing from PCTEST Engineering Laboratory, Inc. If you have any questions about this international copyright or have an enquiry about obtaining additional rights to this report or assembly of contents thereof, please contact INFO@PCTEST.COM.



PCTEST Hearing-Aid Compatibility Facility

DUT: ZNFV450PM

Type: Portable Handset
Serial: 00386

Measurement Standard: ANSI C63.19-2011

Equipment:

- Probe: Axial T-Coil Probe – SN: TEM-1123; Calibrated: 09/19/2018

Test Configuration:

- Mode: Cellular CDMA
- Channel: 384
- Speech Signal: ITU-T P.50 Artificial Voice

Noise Spectrum

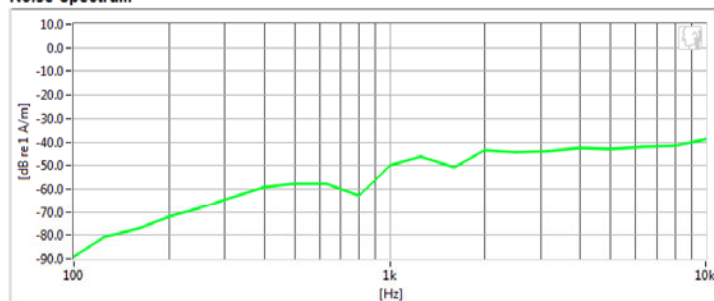

Frequency Response

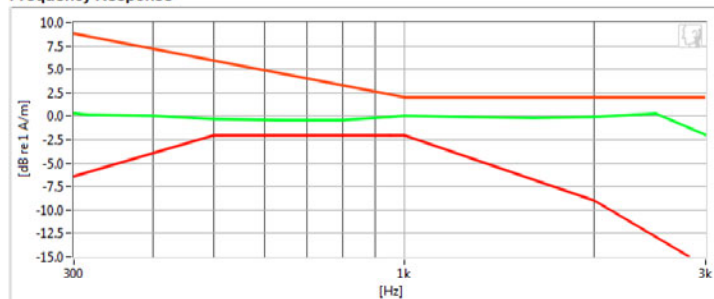

Results

ABM1	5.85 dB	✓	Minimum	-18.0
ABM2	-40.16 dB	✓	Maximum	0
SNNR	46.02 dB	✓	Minimum	20
Aligned Response - P.50	1.59 dB	✓	Tolerance curves	Aligned Data

PCTEST 2019

FCC ID: ZNFV450PM		HAC (T-COIL) TEST REPORT		Approved by: Quality Manager
Filename: 1M1811230205-13-R4.ZNF	Test Dates: 01/07/2019 - 01/22/2019	DUT Type: Portable Handset		Page 53 of 90

© 2019 PCTEST Engineering Laboratory, Inc.

REV 3.2.M
04/17/2018

© 2019 PCTEST Engineering Laboratory, Inc. All rights reserved. Unless otherwise specified, no part of this report may be reproduced or utilized in any part, form or by any means, electronic or mechanical, including photocopying and microfilm, without permission in writing from PCTEST Engineering Laboratory, Inc. If you have any questions about this international copyright or have an enquiry about obtaining additional rights to this report or assembly of contents thereof, please contact INFO@PCTEST.COM.



PCTEST Hearing-Aid Compatibility Facility

DUT: ZNFV450PM

Type: Portable Handset
Serial: 00386

Measurement Standard: ANSI C63.19-2011

Equipment:

- Probe: Axial T-Coil Probe – SN: TEM-1123; Calibrated: 09/19/2018

Test Configuration:

- Mode: PCS CDMA
- Channel: 1175
- Speech Signal: ITU-T P.50 Artificial Voice

Noise Spectrum

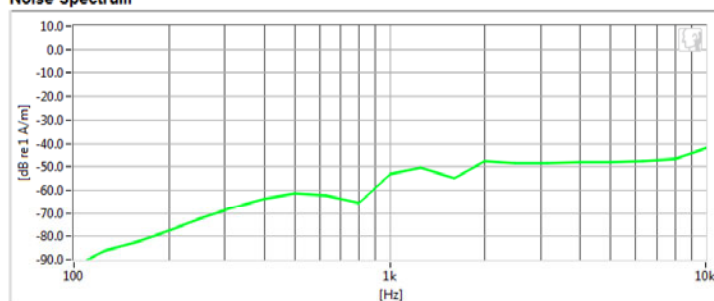

Frequency Response

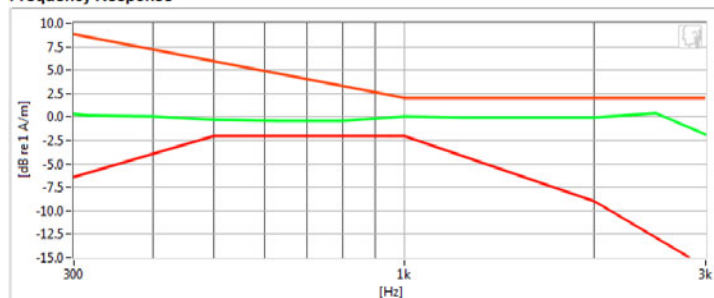

Results

ABM1	4.87 dB	✓	Minimum	-18.0
ABM2	-44.37 dB	✓	Maximum	0.0
SNNR	49.24 dB	✓	Minimum	20.0
Aligned Response - P.50	1.59 dB	✓	Tolerance curves	Aligned Data

PCTEST 2019

FCC ID: ZNFV450PM		HAC (T-COIL) TEST REPORT		Approved by: Quality Manager
Filename: 1M1811230205-13-R4.ZNF	Test Dates: 01/07/2019 - 01/22/2019	DUT Type: Portable Handset	Page 54 of 90	

© 2019 PCTEST Engineering Laboratory, Inc.

REV 3.2.M
04/17/2018

© 2019 PCTEST Engineering Laboratory, Inc. All rights reserved. Unless otherwise specified, no part of this report may be reproduced or utilized in any part, form or by any means, electronic or mechanical, including photocopying and microfilm, without permission in writing from PCTEST Engineering Laboratory, Inc. If you have any questions about this international copyright or have an enquiry about obtaining additional rights to this report or assembly of contents thereof, please contact INFO@PCTEST.COM.



PCTEST Hearing-Aid Compatibility Facility

DUT: ZNFV450PM

Type: Portable Handset
Serial: 00386

Measurement Standard: ANSI C63.19-2011

Equipment:

- Probe: Axial T-Coil Probe – SN: TEM-1123; Calibrated: 09/19/2018

Test Configuration:

- Mode: GSM850
- Channel: 128
- Speech Signal: ITU-T P.50 Artificial Voice

Noise Spectrum

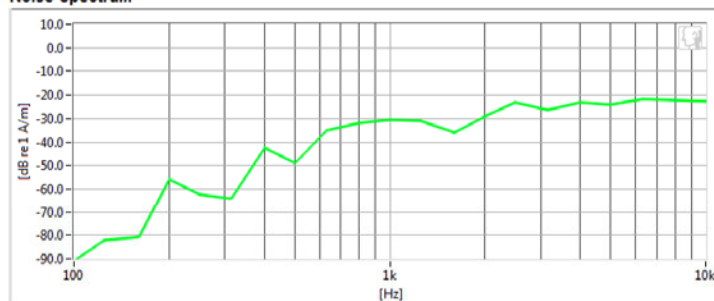

Frequency Response

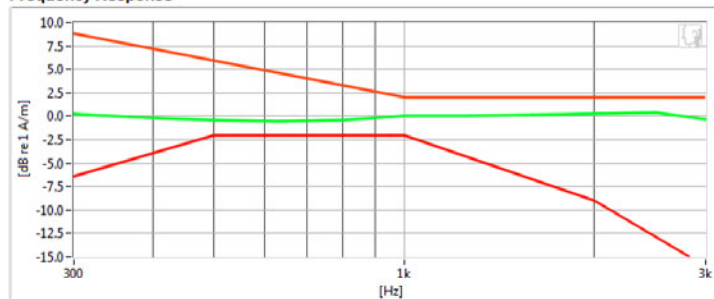

Results

ABM1	7.61 dB	✓	Minimum	-18.0
ABM2	-21.76 dB	✓	Maximum	0
SNNR	29.36 dB	✓	Minimum	20
Aligned Response - P.50	1.51 dB	✓	Tolerance curves	Aligned Data

PCTEST 2019

FCC ID: ZNFV450PM		HAC (T-COIL) TEST REPORT		Approved by: Quality Manager
Filename: 1M1811230205-13-R4.ZNF	Test Dates: 01/07/2019 - 01/22/2019	DUT Type: Portable Handset		Page 55 of 90

© 2019 PCTEST Engineering Laboratory, Inc.

REV 3.2.M
04/17/2018

© 2019 PCTEST Engineering Laboratory, Inc. All rights reserved. Unless otherwise specified, no part of this report may be reproduced or utilized in any part, form or by any means, electronic or mechanical, including photocopying and microfilm, without permission in writing from PCTEST Engineering Laboratory, Inc. If you have any questions about this international copyright or have an enquiry about obtaining additional rights to this report or assembly of contents thereof, please contact INFO@PCTEST.COM.



PCTEST Hearing-Aid Compatibility Facility

DUT: ZNFV450PM

Type: Portable Handset
Serial: 00386

Measurement Standard: ANSI C63.19-2011

Equipment:

- Probe: Axial T-Coil Probe – SN: TEM-1123; Calibrated: 09/19/2018

Test Configuration:

- Mode: GSM1900
- Channel: 512
- Speech Signal: ITU-T P.50 Artificial Voice

Noise Spectrum

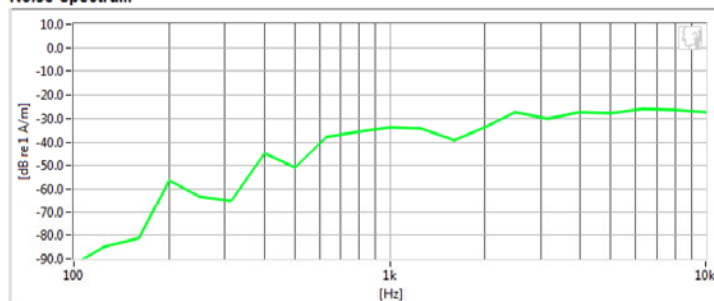

Frequency Response

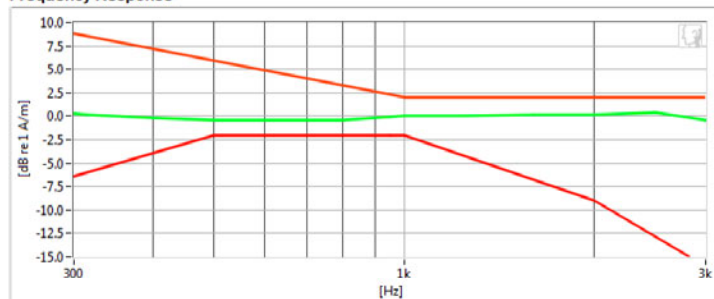

Results

ABM1	7.77 dB	✓	Minimum	-18.0
ABM2	-25.47 dB	✓	Maximum	0
SNNR	33.24 dB	✓	Minimum	20
Aligned Response - P.50	1.54 dB	✓	Tolerance curves	Aligned Data

PCTEST 2019

FCC ID: ZNFV450PM		HAC (T-COIL) TEST REPORT		Approved by: Quality Manager
Filename: 1M1811230205-13-R4.ZNF	Test Dates: 01/07/2019 - 01/22/2019	DUT Type: Portable Handset	Page 56 of 90	

© 2019 PCTEST Engineering Laboratory, Inc.

REV 3.2.M
04/17/2018

© 2019 PCTEST Engineering Laboratory, Inc. All rights reserved. Unless otherwise specified, no part of this report may be reproduced or utilized in any part, form or by any means, electronic or mechanical, including photocopying and microfilm, without permission in writing from PCTEST Engineering Laboratory, Inc. If you have any questions about this international copyright or have an enquiry about obtaining additional rights to this report or assembly of contents thereof, please contact INFO@PCTEST.COM.



PCTEST Hearing-Aid Compatibility Facility

DUT: ZNFV450PM

Type: Portable Handset
Serial: 00386

Measurement Standard: ANSI C63.19-2011

Equipment:

- Probe: Axial T-Coil Probe – SN: TEM-1123; Calibrated: 09/19/2018

Test Configuration:

- Mode: UMTS V
- Channel: 4233
- Speech Signal: ITU-T P.50 Artificial Voice

Noise Spectrum

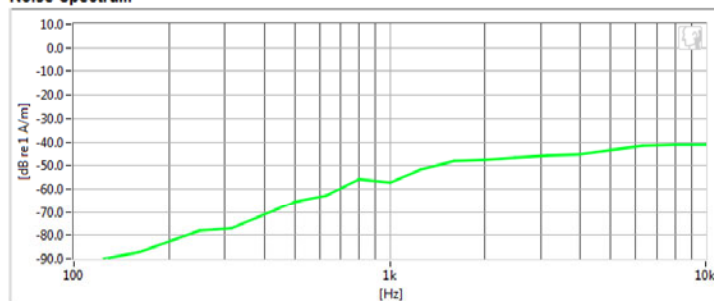

Frequency Response

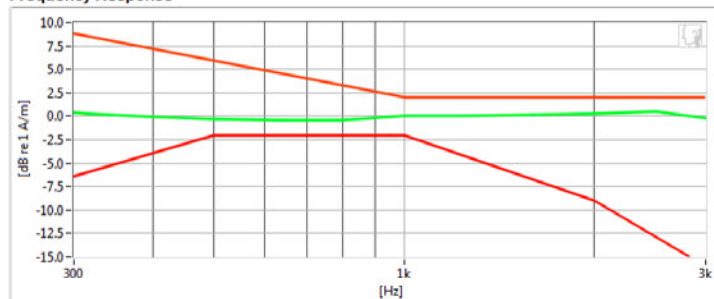

Results

ABM1	7.31 dB	✓	Minimum	-18.0
ABM2	-42.83 dB	✓	Maximum	0
SNNR	50.14 dB	✓	Minimum	20
Aligned Response - P.50	1.54 dB	✓	Tolerance curves	Aligned Data

PCTEST 2019

FCC ID: ZNFV450PM		HAC (T-COIL) TEST REPORT		Approved by: Quality Manager
Filename: 1M1811230205-13-R4.ZNF	Test Dates: 01/07/2019 - 01/22/2019	DUT Type: Portable Handset		Page 57 of 90

© 2019 PCTEST Engineering Laboratory, Inc.

REV 3.2.M
04/17/2018

© 2019 PCTEST Engineering Laboratory, Inc. All rights reserved. Unless otherwise specified, no part of this report may be reproduced or utilized in any part, form or by any means, electronic or mechanical, including photocopying and microfilm, without permission in writing from PCTEST Engineering Laboratory, Inc. If you have any questions about this international copyright or have an enquiry about obtaining additional rights to this report or assembly of contents thereof, please contact INFO@PCTEST.COM.



PCTEST Hearing-Aid Compatibility Facility

DUT: ZNFV450PM

Type: Portable Handset
Serial: 00386

Measurement Standard: ANSI C63.19-2011

Equipment:

- Probe: Axial T-Coil Probe – SN: TEM-1123; Calibrated: 09/19/2018

Test Configuration:

- Mode: UMTS IV
- Channel: 1412
- Speech Signal: ITU-T P.50 Artificial Voice

Noise Spectrum

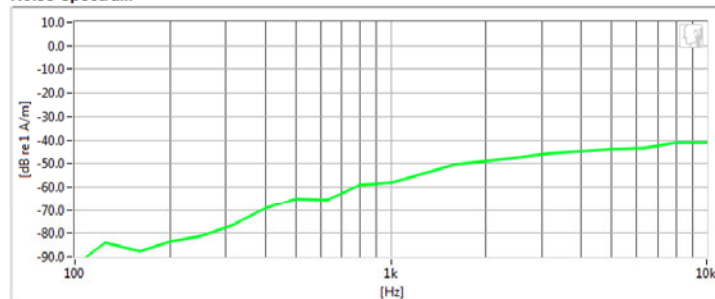

Frequency Response

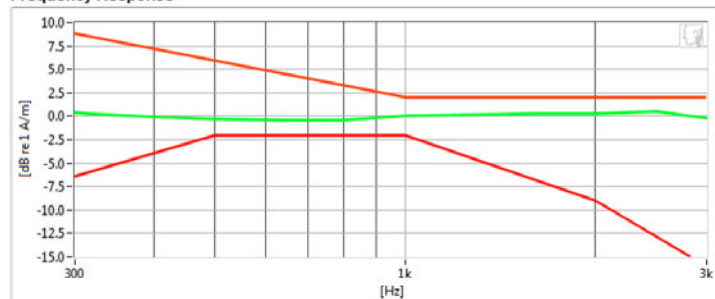

Results

ABM1	7.42 dB	✓	Minimum	-18.0
ABM2	-43.9 dB	✓	Maximum	0
SNNR	51.32 dB	✓	Minimum	20
Aligned Response - P.50	1.52 dB	✓	Tolerance curves	Aligned Data

PCTEST 2019

FCC ID: ZNFV450PM		HAC (T-COIL) TEST REPORT		Approved by: Quality Manager
Filename: 1M1811230205-13-R4.ZNF	Test Dates: 01/07/2019 - 01/22/2019	DUT Type: Portable Handset	Page 58 of 90	

© 2019 PCTEST Engineering Laboratory, Inc.

REV 3.2.M
04/17/2018

© 2019 PCTEST Engineering Laboratory, Inc. All rights reserved. Unless otherwise specified, no part of this report may be reproduced or utilized in any part, form or by any means, electronic or mechanical, including photocopying and microfilm, without permission in writing from PCTEST Engineering Laboratory, Inc. If you have any questions about this international copyright or have an enquiry about obtaining additional rights to this report or assembly of contents thereof, please contact INFO@PCTEST.COM.



PCTEST Hearing-Aid Compatibility Facility

DUT: ZNFV450PM

Type: Portable Handset
Serial: 00386

Measurement Standard: ANSI C63.19-2011

Equipment:

- Probe: Axial T-Coil Probe – SN: TEM-1123; Calibrated: 09/19/2018

Test Configuration:

- Mode: UMTS II
- Channel: 9262
- Speech Signal: ITU-T P.50 Artificial Voice

Noise Spectrum

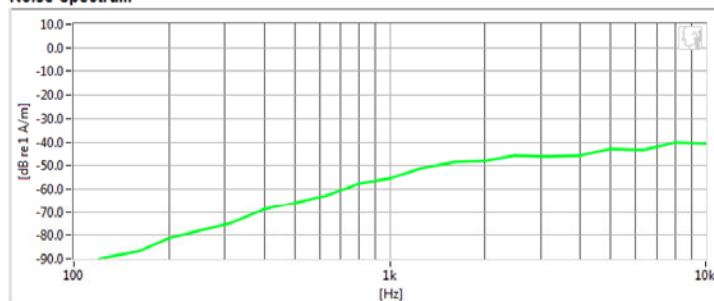

Frequency Response

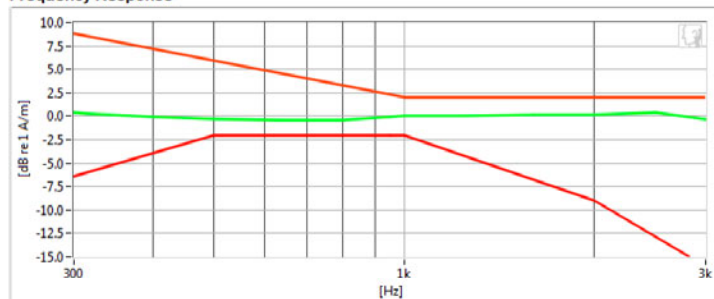

Results

ABM1	7.4 dB	✓	Minimum	-18.0
ABM2	-42.87 dB	✓	Maximum	0
SNNR	50.26 dB	✓	Minimum	20
Aligned Response - P.50	1.55 dB	✓	Tolerance curves	Aligned Data

PCTEST 2019

FCC ID: ZNFV450PM		HAC (T-COIL) TEST REPORT		Approved by: Quality Manager
Filename: 1M1811230205-13-R4.ZNF	Test Dates: 01/07/2019 - 01/22/2019	DUT Type: Portable Handset	Page 59 of 90	

© 2019 PCTEST Engineering Laboratory, Inc.

REV 3.2.M
04/17/2018

© 2019 PCTEST Engineering Laboratory, Inc. All rights reserved. Unless otherwise specified, no part of this report may be reproduced or utilized in any part, form or by any means, electronic or mechanical, including photocopying and microfilm, without permission in writing from PCTEST Engineering Laboratory, Inc. If you have any questions about this international copyright or have an enquiry about obtaining additional rights to this report or assembly of contents thereof, please contact INFO@PCTEST.COM.



PCTEST Hearing-Aid Compatibility Facility

DUT: ZNFV450PM

Type: Portable Handset
Serial: 00004

Measurement Standard: ANSI C63.19-2011

Equipment:

- Probe: Axial T-Coil Probe – SN: TEM-1123; Calibrated: 09/19/2018

Test Configuration:

- Mode: LTE FDD B66
- Bandwidth: 20MHz
- Channel: 132072
- Speech Signal: ITU-T P.50 Artificial Voice

Noise Spectrum

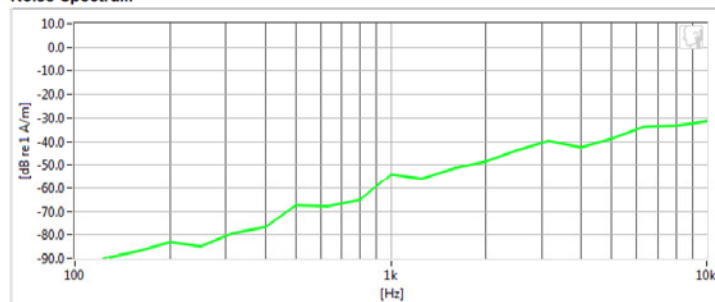

Frequency Response

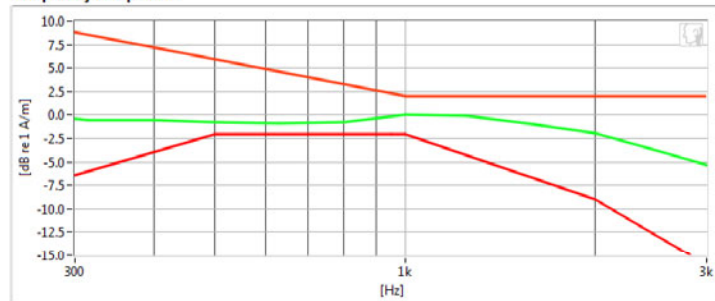

Results

ABM1	2.93 dB	✓	Minimum	-18.0
ABM2	-39.44 dB	✓	Maximum	0
SNNR	42.37 dB	✓	Minimum	20
Aligned Response - P.50	1.1 dB	✓	Tolerance curves	Aligned Data

PCTEST 2019

FCC ID: ZNFV450PM		HAC (T-COIL) TEST REPORT		Approved by: Quality Manager
Filename: 1M1811230205-13-R4.ZNF	Test Dates: 01/07/2019 - 01/22/2019	DUT Type: Portable Handset	Page 60 of 90	

© 2019 PCTEST Engineering Laboratory, Inc.

REV 3.2.M
04/17/2018

© 2019 PCTEST Engineering Laboratory, Inc. All rights reserved. Unless otherwise specified, no part of this report may be reproduced or utilized in any part, form or by any means, electronic or mechanical, including photocopying and microfilm, without permission in writing from PCTEST Engineering Laboratory, Inc. If you have any questions about this international copyright or have an enquiry about obtaining additional rights to this report or assembly of contents thereof, please contact INFO@PCTEST.COM.



PCTEST Hearing-Aid Compatibility Facility

DUT: ZNFV450PM

Type: Portable Handset
Serial: 00386

Measurement Standard: ANSI C63.19-2011

Equipment:

- Probe: Axial T-Coil Probe – SN: TEM-1123; Calibrated: 09/19/2018

Test Configuration:

- Mode: LTE TDD B41 (PC2)
- Bandwidth: 10MHz
- Channel: 41055
- Speech Signal: ITU-T P.50 Artificial Voice

Noise Spectrum

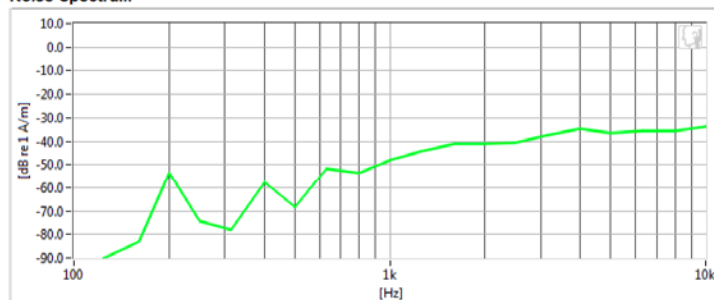

Frequency Response

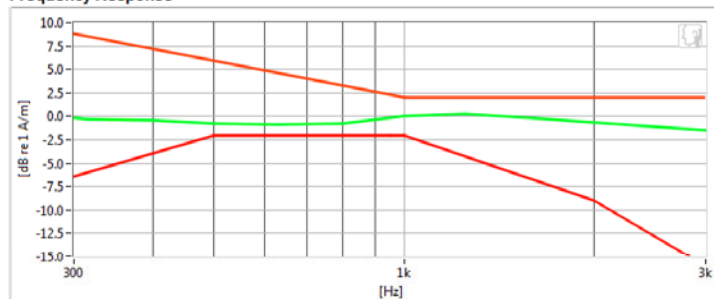

Results

ABM1	7.53 dB	✓	Minimum	-18.0
ABM2	-35.41 dB	✓	Maximum	0
SNNR	42.94 dB	✓	Minimum	20
Aligned Response - P.50	1.08 dB	✓	Tolerance curves	Aligned Data

PCTEST 2019

FCC ID: ZNFV450PM		HAC (T-COIL) TEST REPORT		Approved by: Quality Manager
Filename: 1M1811230205-13-R4.ZNF	Test Dates: 01/07/2019 - 01/22/2019	DUT Type: Portable Handset		Page 61 of 90

© 2019 PCTEST Engineering Laboratory, Inc.

REV 3.2.M
04/17/2018

© 2019 PCTEST Engineering Laboratory, Inc. All rights reserved. Unless otherwise specified, no part of this report may be reproduced or utilized in any part, form or by any means, electronic or mechanical, including photocopying and microfilm, without permission in writing from PCTEST Engineering Laboratory, Inc. If you have any questions about this international copyright or have an enquiry about obtaining additional rights to this report or assembly of contents thereof, please contact INFO@PCTEST.COM.



PCTEST Hearing-Aid Compatibility Facility

DUT: ZNFV450PM

Type: Portable Handset
Serial: 00444

Measurement Standard: ANSI C63.19-2011

Equipment:

- Probe: Axial T-Coil Probe – SN: TEM-1123; Calibrated: 09/19/2018

Test Configuration:

- Mode: 2.4GHz WIFI
- Standard: IEEE 802.11b
- Channel: 6
- Speech Signal: ITU-T P.50 Artificial Voice

Noise Spectrum

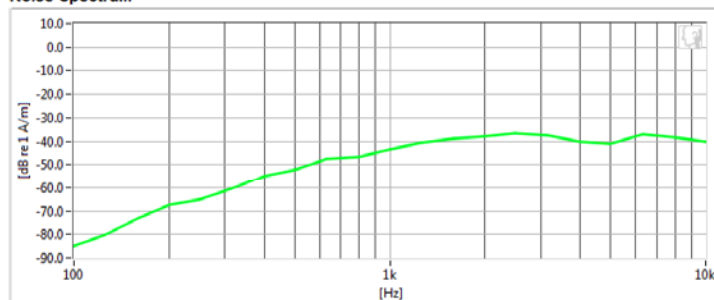

Frequency Response

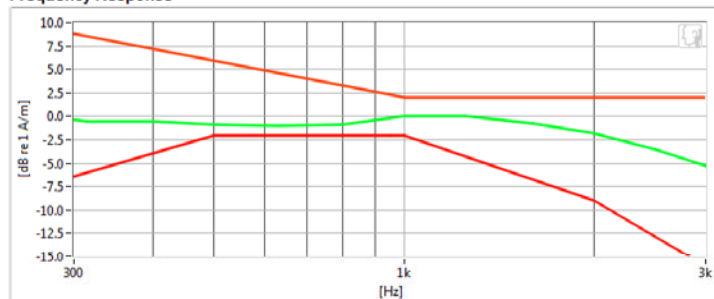

Results

ABM1	-50m dB	✓	Minimum	-18.0
ABM2	-33.47 dB	✓	Maximum	0
SNNR	33.42 dB	✓	Minimum	20
Aligned Response - P.50	1.02 dB	✓	Tolerance curves	Aligned Data

PCTEST 2019

FCC ID: ZNFV450PM		HAC (T-COIL) TEST REPORT		Approved by: Quality Manager
Filename: 1M1811230205-13-R4.ZNF	Test Dates: 01/07/2019 - 01/22/2019	DUT Type: Portable Handset	Page 62 of 90	

© 2019 PCTEST Engineering Laboratory, Inc.

REV 3.2.M
04/17/2018

© 2019 PCTEST Engineering Laboratory, Inc. All rights reserved. Unless otherwise specified, no part of this report may be reproduced or utilized in any part, form or by any means, electronic or mechanical, including photocopying and microfilm, without permission in writing from PCTEST Engineering Laboratory, Inc. If you have any questions about this international copyright or have an enquiry about obtaining additional rights to this report or assembly of contents thereof, please contact INFO@PCTEST.COM.



PCTEST Hearing-Aid Compatibility Facility

DUT: ZNFV450PM

Type: Portable Handset
Serial: 00444

Measurement Standard: ANSI C63.19-2011

Equipment:

- Probe: Axial T-Coil Probe – SN: TEM-1123; Calibrated: 09/19/2018

Test Configuration:

- Mode: 5GHz WiFi
- Standard: IEEE 802.11n (U-NII 3)
- Bandwidth: 40MHz
- Channel: 159
- Speech Signal: ITU-T P.50 Artificial Voice

Noise Spectrum

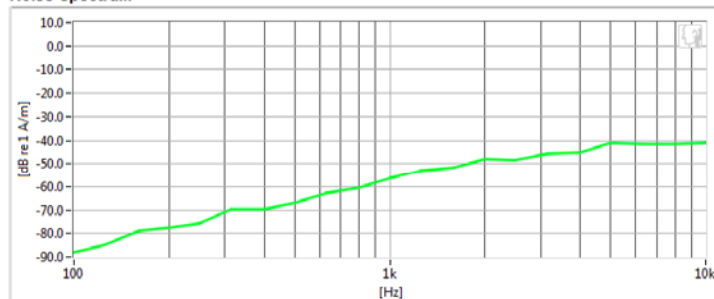

Frequency Response

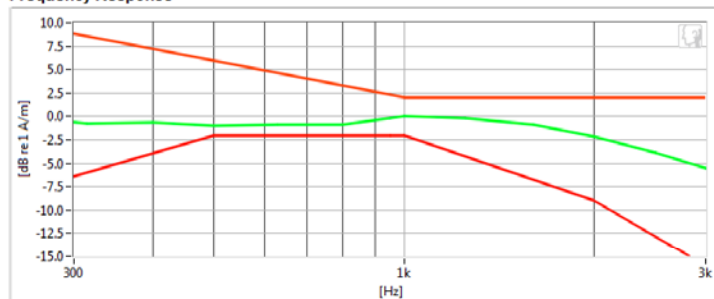

Results

ABM1	-320m dB	✓	Minimum	-18.0
ABM2	-43.63 dB	✓	Maximum	0
SNNR	43.31 dB	✓	Minimum	20
Aligned Response - P.50	1.04 dB	✓	Tolerance curves	Aligned Data

PCTEST 2019

FCC ID: ZNFV450PM		HAC (T-COIL) TEST REPORT		Approved by: Quality Manager
Filename: 1M1811230205-13-R4.ZNF	Test Dates: 01/07/2019 - 01/22/2019	DUT Type: Portable Handset	Page 63 of 90	

© 2019 PCTEST Engineering Laboratory, Inc.

REV 3.2.M
04/17/2018

© 2019 PCTEST Engineering Laboratory, Inc. All rights reserved. Unless otherwise specified, no part of this report may be reproduced or utilized in any part, form or by any means, electronic or mechanical, including photocopying and microfilm, without permission in writing from PCTEST Engineering Laboratory, Inc. If you have any questions about this international copyright or have an enquiry about obtaining additional rights to this report or assembly of contents thereof, please contact INFO@PCTEST.COM.



PCTEST Hearing-Aid Compatibility Facility

DUT: ZNFV450PM

Type: Portable Handset
Serial: 00444

Measurement Standard: ANSI C63.19-2011

Equipment:

- Probe: Axial T-Coil Probe – SN: TEM-1123; Calibrated: 09/19/2018

Test Configuration:

- VoIP Application: Google Duo
- Mode: EDGE1900
- Channel: 661
- Speech Signal: ITU-T P.50 Artificial Voice

Noise Spectrum

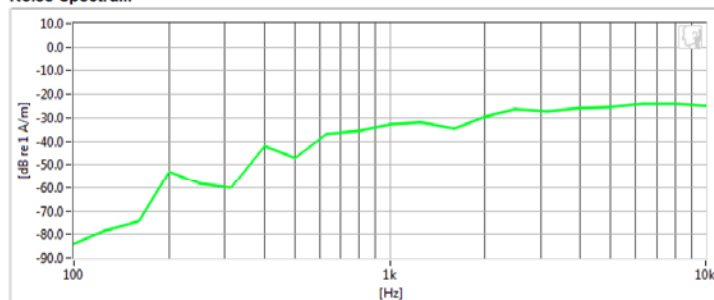

Frequency Response

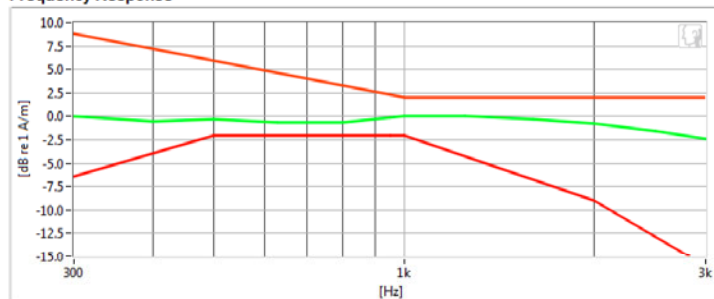

Results

ABM1	15.72 dB	✓	Minimum	-18.0
ABM2	-23.7 dB	✓	Maximum	0
SNNR	39.42 dB	✓	Minimum	20
Aligned Response - P.50	1.35 dB	✓	Tolerance curves	Aligned Data

PCTEST 2019

FCC ID: ZNFV450PM		HAC (T-COIL) TEST REPORT		Approved by: Quality Manager
Filename: 1M1811230205-13-R4.ZNF	Test Dates: 01/07/2019 - 01/22/2019	DUT Type: Portable Handset	Page 64 of 90	

© 2019 PCTEST Engineering Laboratory, Inc.

REV 3.2.M
04/17/2018

© 2019 PCTEST Engineering Laboratory, Inc. All rights reserved. Unless otherwise specified, no part of this report may be reproduced or utilized in any part, form or by any means, electronic or mechanical, including photocopying and microfilm, without permission in writing from PCTEST Engineering Laboratory, Inc. If you have any questions about this international copyright or have an enquiry about obtaining additional rights to this report or assembly of contents thereof, please contact INFO@PCTEST.COM.



PCTEST Hearing-Aid Compatibility Facility

DUT: ZNFV450PM

Type: Portable Handset
Serial: 00386

Measurement Standard: ANSI C63.19-2011

Equipment:

- Probe: Radial T-Coil Probe – SN: TEM-1129; Calibrated: 09/19/2018

Test Configuration:

- Mode: Secondary Cellular CDMA
- Channel: 476

Noise Spectrum

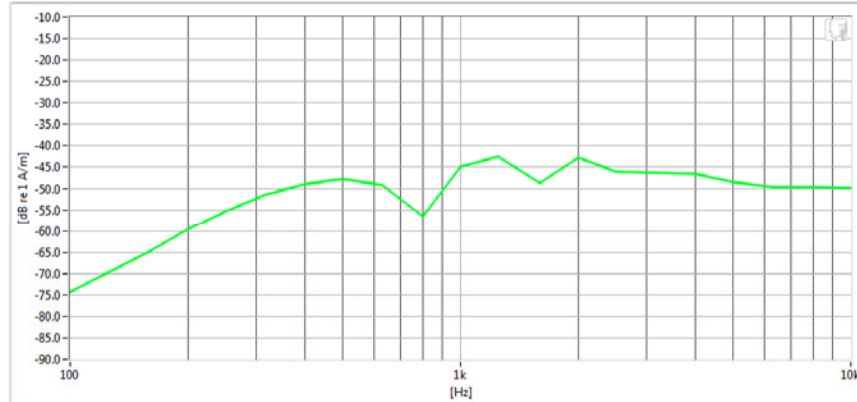

Results

ABM1	-740m dB	✓	Minimum	-18.0
ABM2	-36.77 dB	✓	Maximum	0.0
SNNR	36.04 dB	✓	Minimum	20.0

PCTEST 2019

FCC ID: ZNFV450PM		HAC (T-COIL) TEST REPORT		Approved by: Quality Manager
Filename: 1M1811230205-13-R4.ZNF	Test Dates: 01/07/2019 - 01/22/2019	DUT Type: Portable Handset	Page 65 of 90	

© 2019 PCTEST Engineering Laboratory, Inc.

REV 3.2.M
04/17/2018

© 2019 PCTEST Engineering Laboratory, Inc. All rights reserved. Unless otherwise specified, no part of this report may be reproduced or utilized in any part, form or by any means, electronic or mechanical, including photocopying and microfilm, without permission in writing from PCTEST Engineering Laboratory, Inc. If you have any questions about this international copyright or have an enquiry about obtaining additional rights to this report or assembly of contents thereof, please contact INFO@PCTEST.COM.



PCTEST Hearing-Aid Compatibility Facility

DUT: ZNFV450PM

Type: Portable Handset
Serial: 00386

Measurement Standard: ANSI C63.19-2011

Equipment:

- Probe: Radial T-Coil Probe – SN: TEM-1129; Calibrated: 09/19/2018

Test Configuration:

- Mode: Cellular CDMA
- Channel: 384

Noise Spectrum

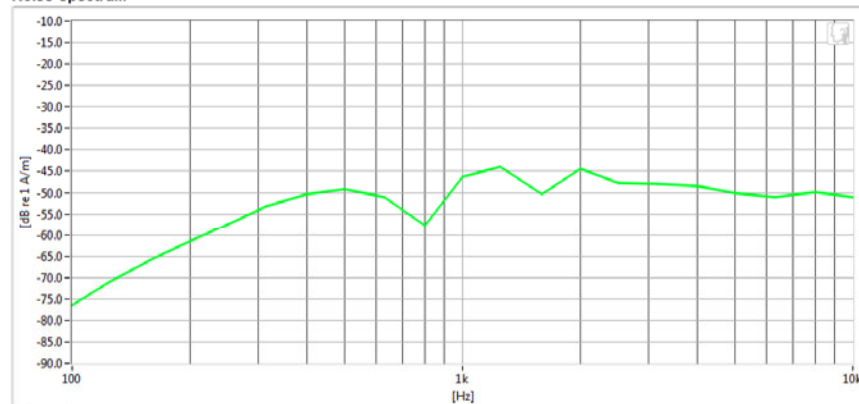

Results

ABM1	-740m dB	✓	Minimum	-18.0
ABM2	-38.3 dB	✓	Maximum	0.0
SNNR	37.56 dB	✓	Minimum	20.0

PCTEST 2019

FCC ID: ZNFV450PM		HAC (T-COIL) TEST REPORT		Approved by: Quality Manager
Filename: 1M1811230205-13-R4.ZNF	Test Dates: 01/07/2019 - 01/22/2019	DUT Type: Portable Handset	Page 66 of 90	

© 2019 PCTEST Engineering Laboratory, Inc.

REV 3.2.M
04/17/2018

© 2019 PCTEST Engineering Laboratory, Inc. All rights reserved. Unless otherwise specified, no part of this report may be reproduced or utilized in any part, form or by any means, electronic or mechanical, including photocopying and microfilm, without permission in writing from PCTEST Engineering Laboratory, Inc. If you have any questions about this international copyright or have an enquiry about obtaining additional rights to this report or assembly of contents thereof, please contact INFO@PCTEST.COM.



PCTEST Hearing-Aid Compatibility Facility

DUT: ZNFV450PM

Type: Portable Handset
Serial: 00386

Measurement Standard: ANSI C63.19-2011

Equipment:

- Probe: Radial T-Coil Probe – SN: TEM-1129; Calibrated: 09/19/2018

Test Configuration:

- Mode: PCS CDMA
- Channel: 1175

Noise Spectrum

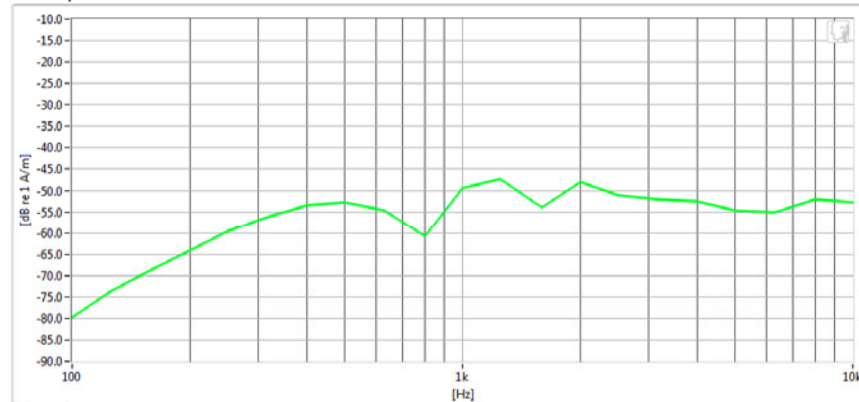

Results

ABM1	-990m dB	✓	Minimum	-18.0
ABM2	-41.59 dB	✓	Maximum	0.0
SNNR	40.6 dB	✓	Minimum	20.0

PCTEST 2019

FCC ID: ZNFV450PM		HAC (T-COIL) TEST REPORT		Approved by: Quality Manager
Filename: 1M1811230205-13-R4.ZNF	Test Dates: 01/07/2019 - 01/22/2019	DUT Type: Portable Handset	Page 67 of 90	

© 2019 PCTEST Engineering Laboratory, Inc.

REV 3.2.M
04/17/2018

© 2019 PCTEST Engineering Laboratory, Inc. All rights reserved. Unless otherwise specified, no part of this report may be reproduced or utilized in any part, form or by any means, electronic or mechanical, including photocopying and microfilm, without permission in writing from PCTEST Engineering Laboratory, Inc. If you have any questions about this international copyright or have an enquiry about obtaining additional rights to this report or assembly of contents thereof, please contact INFO@PCTEST.COM.



PCTEST Hearing-Aid Compatibility Facility

DUT: ZNFV450PM

Type: Portable Handset
Serial: 00386

Measurement Standard: ANSI C63.19-2011

Equipment:

- Probe: Radial T-Coil Probe – SN: TEM-1129; Calibrated: 09/19/2018

Test Configuration:

- Mode: GSM850
- Channel: 190

Noise Spectrum

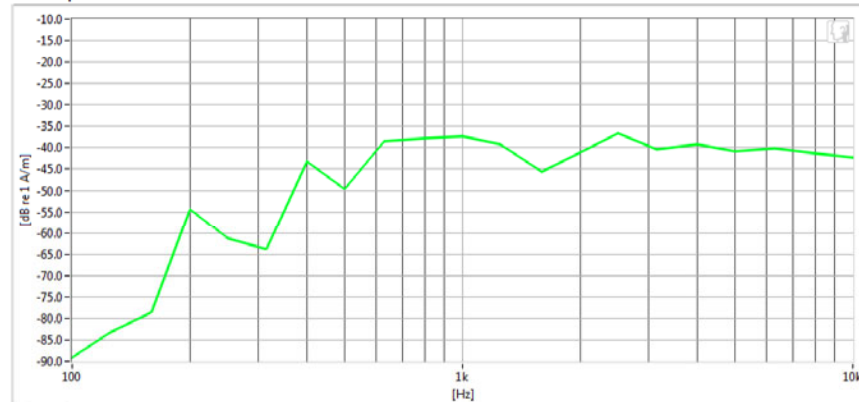

Results

ABM1	-2.99 dB	✓	Minimum	-18.0
ABM2	-30.26 dB	✓	Maximum	0.0
SNNR	27.27 dB	✓	Minimum	20.0

PCTEST 2019

FCC ID: ZNFV450PM		HAC (T-COIL) TEST REPORT		Approved by: Quality Manager
Filename: 1M1811230205-13-R4.ZNF	Test Dates: 01/07/2019 - 01/22/2019	DUT Type: Portable Handset	Page 68 of 90	

© 2019 PCTEST Engineering Laboratory, Inc.

REV 3.2.M
04/17/2018

© 2019 PCTEST Engineering Laboratory, Inc. All rights reserved. Unless otherwise specified, no part of this report may be reproduced or utilized in any part, form or by any means, electronic or mechanical, including photocopying and microfilm, without permission in writing from PCTEST Engineering Laboratory, Inc. If you have any questions about this international copyright or have an enquiry about obtaining additional rights to this report or assembly of contents thereof, please contact INFO@PCTEST.COM.



PCTEST Hearing-Aid Compatibility Facility

DUT: ZNFV450PM

Type: Portable Handset
Serial: 00386

Measurement Standard: ANSI C63.19-2011

Equipment:

- Probe: Radial T-Coil Probe – SN: TEM-1129; Calibrated: 09/19/2018

Test Configuration:

- Mode: GSM1900
- Channel: 512

Noise Spectrum

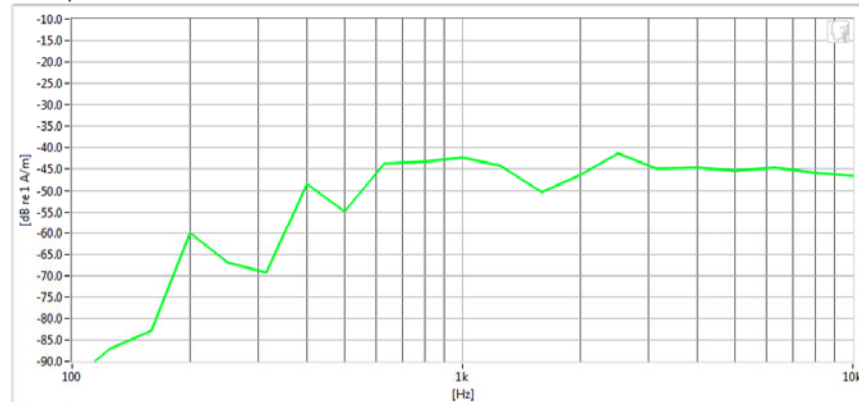

Results

ABM1	-2.83 dB	✓	Minimum	-18.0
ABM2	-35.37 dB	✓	Maximum	0.0
SNNR	32.54 dB	✓	Minimum	20.0

PCTEST 2019

FCC ID: ZNFV450PM		HAC (T-COIL) TEST REPORT		Approved by: Quality Manager
Filename: 1M1811230205-13-R4.ZNF	Test Dates: 01/07/2019 - 01/22/2019	DUT Type: Portable Handset	Page 69 of 90	

© 2019 PCTEST Engineering Laboratory, Inc.

REV 3.2.M
04/17/2018

© 2019 PCTEST Engineering Laboratory, Inc. All rights reserved. Unless otherwise specified, no part of this report may be reproduced or utilized in any part, form or by any means, electronic or mechanical, including photocopying and microfilm, without permission in writing from PCTEST Engineering Laboratory, Inc. If you have any questions about this international copyright or have an enquiry about obtaining additional rights to this report or assembly of contents thereof, please contact INFO@PCTEST.COM.



PCTEST Hearing-Aid Compatibility Facility

DUT: ZNFV450PM

Type: Portable Handset
Serial: 00386

Measurement Standard: ANSI C63.19-2011

Equipment:

- Probe: Radial T-Coil Probe – SN: TEM-1129; Calibrated: 09/19/2018

Test Configuration:

- Mode: UMTS V
- Channel: 4233

Noise Spectrum

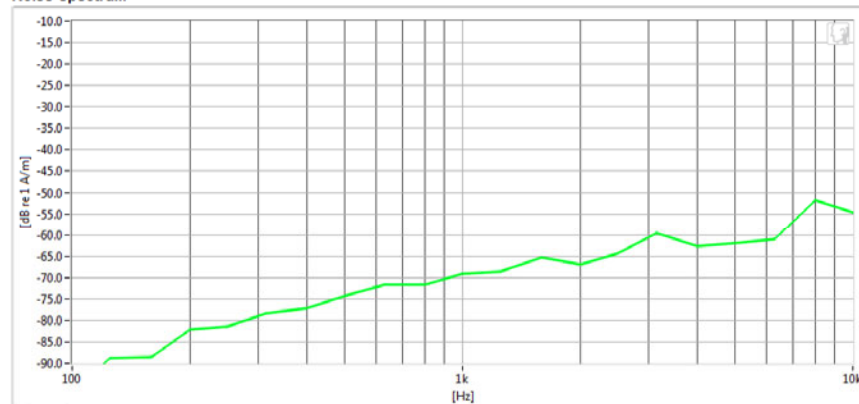

Results

ABM1	-3.21 dB	✓	Minimum	-18.0
ABM2	-58.18 dB	✓	Maximum	0.0
SNNR	54.98 dB	✓	Minimum	20.0

PCTEST 2019

FCC ID: ZNFV450PM		HAC (T-COIL) TEST REPORT		Approved by: Quality Manager
Filename: 1M1811230205-13-R4.ZNF	Test Dates: 01/07/2019 - 01/22/2019	DUT Type: Portable Handset	Page 70 of 90	

© 2019 PCTEST Engineering Laboratory, Inc.

REV 3.2.M
04/17/2018

© 2019 PCTEST Engineering Laboratory, Inc. All rights reserved. Unless otherwise specified, no part of this report may be reproduced or utilized in any part, form or by any means, electronic or mechanical, including photocopying and microfilm, without permission in writing from PCTEST Engineering Laboratory, Inc. If you have any questions about this international copyright or have an enquiry about obtaining additional rights to this report or assembly of contents thereof, please contact INFO@PCTEST.COM.



PCTEST Hearing-Aid Compatibility Facility

DUT: ZNFV450PM

Type: Portable Handset
Serial: 00386

Measurement Standard: ANSI C63.19-2011

Equipment:

- Probe: Radial T-Coil Probe – SN: TEM-1129; Calibrated: 09/19/2018

Test Configuration:

- Mode: UMTS IV
- Channel: 1312

Noise Spectrum

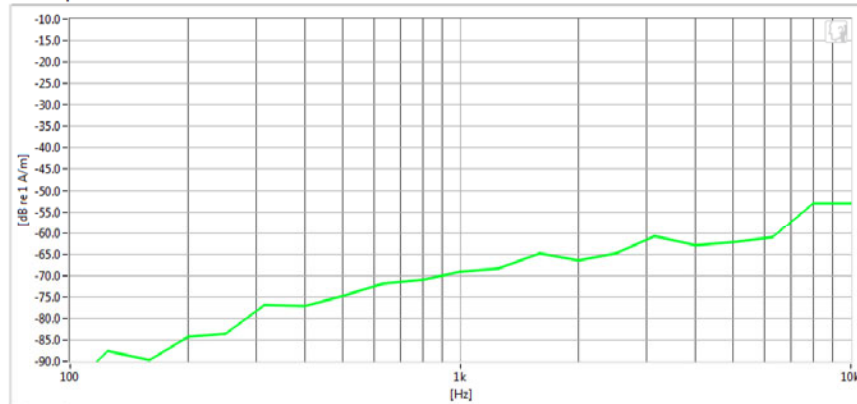

Results

ABM1	-3.2 dB	✓	Minimum	-18.0
ABM2	-58.26 dB	✓	Maximum	0.0
SNNR	55.06 dB	✓	Minimum	20.0

PCTEST 2019

FCC ID: ZNFV450PM		HAC (T-COIL) TEST REPORT		Approved by: Quality Manager
Filename: 1M1811230205-13-R4.ZNF	Test Dates: 01/07/2019 - 01/22/2019	DUT Type: Portable Handset	Page 71 of 90	

© 2019 PCTEST Engineering Laboratory, Inc.

REV 3.2.M
04/17/2018

© 2019 PCTEST Engineering Laboratory, Inc. All rights reserved. Unless otherwise specified, no part of this report may be reproduced or utilized in any part, form or by any means, electronic or mechanical, including photocopying and microfilm, without permission in writing from PCTEST Engineering Laboratory, Inc. If you have any questions about this international copyright or have an enquiry about obtaining additional rights to this report or assembly of contents thereof, please contact INFO@PCTEST.COM.



PCTEST Hearing-Aid Compatibility Facility

DUT: ZNFV450PM

Type: Portable Handset
Serial: 00386

Measurement Standard: ANSI C63.19-2011

Equipment:

- Probe: Radial T-Coil Probe – SN: TEM-1129; Calibrated: 09/19/2018

Test Configuration:

- Mode: UMTS II
- Channel: 9262

Noise Spectrum

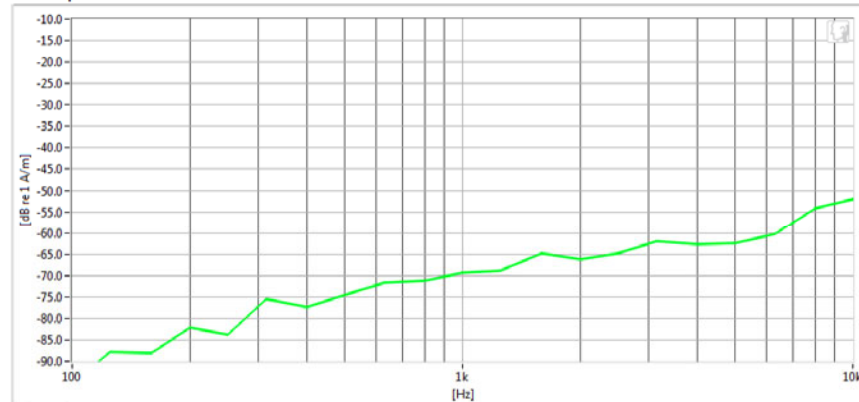

Results

ABM1	-3.21 dB	✓	Minimum	-18.0
ABM2	-58.36 dB	✓	Maximum	0.0
SNNR	55.15 dB	✓	Minimum	20.0

PCTEST 2019

FCC ID: ZNFV450PM		HAC (T-COIL) TEST REPORT		Approved by: Quality Manager
Filename: 1M1811230205-13-R4.ZNF	Test Dates: 01/07/2019 - 01/22/2019	DUT Type: Portable Handset	Page 72 of 90	

© 2019 PCTEST Engineering Laboratory, Inc.

REV 3.2.M
04/17/2018

© 2019 PCTEST Engineering Laboratory, Inc. All rights reserved. Unless otherwise specified, no part of this report may be reproduced or utilized in any part, form or by any means, electronic or mechanical, including photocopying and microfilm, without permission in writing from PCTEST Engineering Laboratory, Inc. If you have any questions about this international copyright or have an enquiry about obtaining additional rights to this report or assembly of contents thereof, please contact INFO@PCTEST.COM.



PCTEST Hearing-Aid Compatibility Facility

DUT: ZNFV450PM

Type: Portable Handset
Serial: 00004

Measurement Standard: ANSI C63.19-2011

Equipment:

- Probe: Radial T-Coil Probe – SN: TEM-1129; Calibrated: 09/19/2018

Test Configuration:

- Mode: LTE FDD B66
- Bandwidth: 3MHz
- Channel: 131987

Noise Spectrum

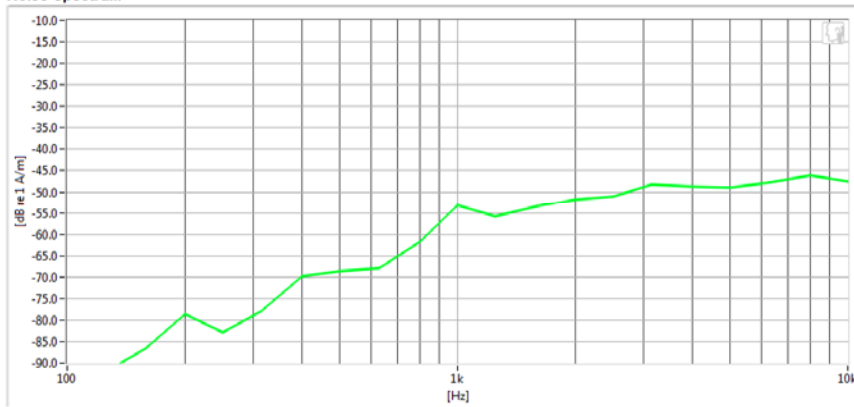

Results

ABM1	-2.35 dB	✓	Minimum	-18.0
ABM2	-46.36 dB	✓	Maximum	0.0
SNNR	44.01 dB	✓	Minimum	20.0

PCTEST 2019

FCC ID: ZNFV450PM		HAC (T-COIL) TEST REPORT		Approved by: Quality Manager
Filename: 1M1811230205-13-R4.ZNF	Test Dates: 01/07/2019 - 01/22/2019	DUT Type: Portable Handset		Page 73 of 90

© 2019 PCTEST Engineering Laboratory, Inc.

REV 3.2.M
04/17/2018

© 2019 PCTEST Engineering Laboratory, Inc. All rights reserved. Unless otherwise specified, no part of this report may be reproduced or utilized in any part, form or by any means, electronic or mechanical, including photocopying and microfilm, without permission in writing from PCTEST Engineering Laboratory, Inc. If you have any questions about this international copyright or have an enquiry about obtaining additional rights to this report or assembly of contents thereof, please contact INFO@PCTEST.COM.



PCTEST Hearing-Aid Compatibility Facility

DUT: ZNFV450PM

Type: Portable Handset
Serial: 00386

Measurement Standard: ANSI C63.19-2011

Equipment:

- Probe: Radial T-Coil Probe – SN: TEM-1129; Calibrated: 09/19/2018

Test Configuration:

- Mode: LTE TDD B41 (PC2)
- Bandwidth: 5MHz
- Channel: 41055

Noise Spectrum

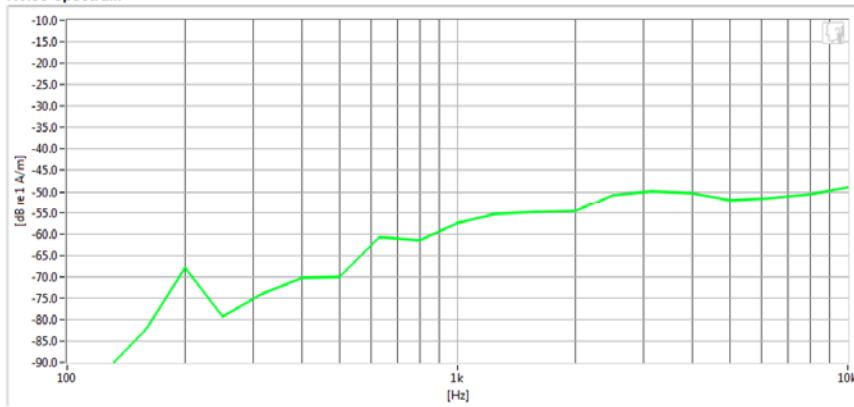

Results

ABM1	-2.74 dB	✓	Minimum	-18.0
ABM2	-47.77 dB	✓	Maximum	0.0
SNNR	45.03 dB	✓	Minimum	20.0

PCTEST 2019

FCC ID: ZNFV450PM		HAC (T-COIL) TEST REPORT		Approved by: Quality Manager
Filename: 1M1811230205-13-R4.ZNF	Test Dates: 01/07/2019 - 01/22/2019	DUT Type: Portable Handset	Page 74 of 90	

© 2019 PCTEST Engineering Laboratory, Inc.

REV 3.2.M
04/17/2018

© 2019 PCTEST Engineering Laboratory, Inc. All rights reserved. Unless otherwise specified, no part of this report may be reproduced or utilized in any part, form or by any means, electronic or mechanical, including photocopying and microfilm, without permission in writing from PCTEST Engineering Laboratory, Inc. If you have any questions about this international copyright or have an enquiry about obtaining additional rights to this report or assembly of contents thereof, please contact INFO@PCTEST.COM.



PCTEST Hearing-Aid Compatibility Facility

DUT: ZNFV450PM

Type: Portable Handset
Serial: 00444

Measurement Standard: ANSI C63.19-2011

Equipment:

- Probe: Radial T-Coil Probe – SN: TEM-1129; Calibrated: 09/19/2018

Test Configuration:

- Mode: 2.4GHz WIFI
- Standard: IEEE 802.11b
- Channel: 11

Noise Spectrum

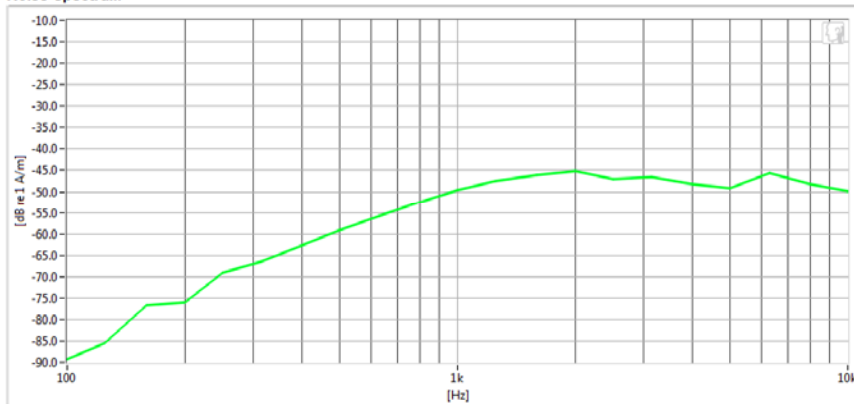

Results

ABM1	-6.83 dB	✓	Minimum	-18.0
ABM2	-41.02 dB	✓	Maximum	0.0
SNNR	34.19 dB	✓	Minimum	20.0

PCTEST 2019

FCC ID: ZNFV450PM		HAC (T-COIL) TEST REPORT		Approved by: Quality Manager
Filename: 1M1811230205-13-R4.ZNF	Test Dates: 01/07/2019 - 01/22/2019	DUT Type: Portable Handset	Page 75 of 90	

© 2019 PCTEST Engineering Laboratory, Inc.

REV 3.2.M
04/17/2018

© 2019 PCTEST Engineering Laboratory, Inc. All rights reserved. Unless otherwise specified, no part of this report may be reproduced or utilized in any part, form or by any means, electronic or mechanical, including photocopying and microfilm, without permission in writing from PCTEST Engineering Laboratory, Inc. If you have any questions about this international copyright or have an enquiry about obtaining additional rights to this report or assembly of contents thereof, please contact INFO@PCTEST.COM.



PCTEST Hearing-Aid Compatibility Facility

DUT: ZNFV450PM

Type: Portable Handset
Serial: 00444

Measurement Standard: ANSI C63.19-2011

Equipment:

- Probe: Radial T-Coil Probe – SN: TEM-1129; Calibrated: 09/19/2018

Test Configuration:

- Mode: 5GHz WIFI
- Standard: IEEE 802.11n (U-NII 2C)
- Bandwidth: 20MHz
- Channel: 120

Noise Spectrum

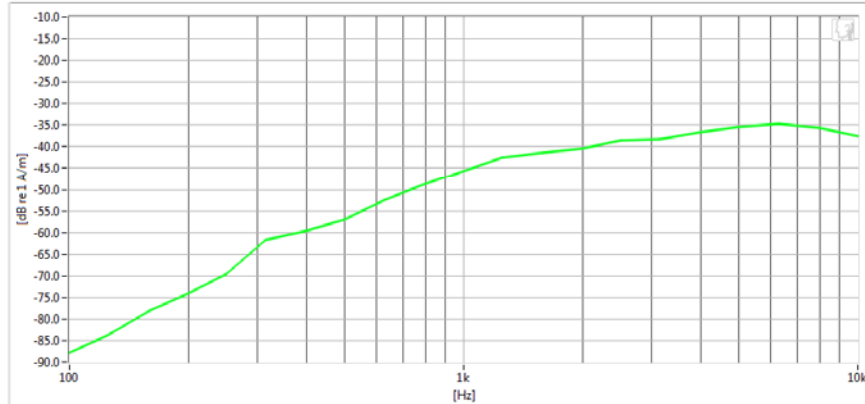

Results

ABM1	-6.79 dB	✓	Minimum	-18.0
ABM2	-34.88 dB	✓	Maximum	0.0
SNNR	28.09 dB	✓	Minimum	20.0

PCTEST 2019

FCC ID: ZNFV450PM		HAC (T-COIL) TEST REPORT		Approved by: Quality Manager
Filename: 1M1811230205-13-R4.ZNF	Test Dates: 01/07/2019 - 01/22/2019	DUT Type: Portable Handset	Page 76 of 90	

© 2019 PCTEST Engineering Laboratory, Inc.

REV 3.2.M
04/17/2018

© 2019 PCTEST Engineering Laboratory, Inc. All rights reserved. Unless otherwise specified, no part of this report may be reproduced or utilized in any part, form or by any means, electronic or mechanical, including photocopying and microfilm, without permission in writing from PCTEST Engineering Laboratory, Inc. If you have any questions about this international copyright or have an enquiry about obtaining additional rights to this report or assembly of contents thereof, please contact INFO@PCTEST.COM.



PCTEST Hearing-Aid Compatibility Facility

DUT: ZNFV450PM

Type: Portable Handset
Serial: 00444

Measurement Standard: ANSI C63.19-2011

Equipment:

- Probe: Radial T-Coil Probe – SN: TEM-1129; Calibrated: 09/19/2018

Test Configuration:

- VoIP Application: Google Duo
- Mode: 5GHz WIFI
- Standard: IEEE 802.11a (U-NII 2A)
- Channel: 56

Noise Spectrum

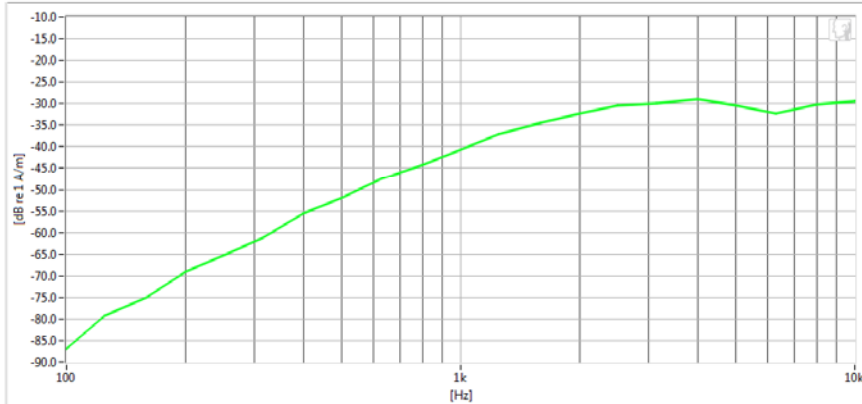

Results

ABM1	8.13 dB	✓	Minimum	-18.0
ABM2	-28.22 dB	✓	Maximum	0.0
SNNR	36.35 dB	✓	Minimum	20.0

PCTEST 2019



FCC ID: ZNFV450PM		HAC (T-COIL) TEST REPORT		Approved by: Quality Manager
Filename: 1M1811230205-13-R4.ZNF	Test Dates: 01/07/2019 - 01/22/2019	DUT Type: Portable Handset	Page 77 of 90	

© 2019 PCTEST Engineering Laboratory, Inc.

REV 3.2.M
04/17/2018

© 2019 PCTEST Engineering Laboratory, Inc. All rights reserved. Unless otherwise specified, no part of this report may be reproduced or utilized in any part, form or by any means, electronic or mechanical, including photocopying and microfilm, without permission in writing from PCTEST Engineering Laboratory, Inc. If you have any questions about this international copyright or have an enquiry about obtaining additional rights to this report or assembly of contents thereof, please contact INFO@PCTEST.COM.

13. CALIBRATION CERTIFICATES

FCC ID: ZNFV450PM		HAC (T-COIL) TEST REPORT		Approved by: Quality Manager
Filename: 1M1811230205-13-R4.ZNF	Test Dates: 01/07/2019 - 01/22/2019	DUT Type: Portable Handset	Page 78 of 90	

© 2019 PCTEST Engineering Laboratory, Inc.

REV 3.2.M
04/17/2018

© 2019 PCTEST Engineering Laboratory, Inc. All rights reserved. Unless otherwise specified, no part of this report may be reproduced or utilized in any part, form or by any means, electronic or mechanical, including photocopying and microfilm, without permission in writing from PCTEST Engineering Laboratory, Inc. If you have any questions about this international copyright or have an enquiry about obtaining additional rights to this report or assembly of contents thereof, please contact INFO@PCTEST.COM.

West Caldwell Calibration Laboratories Inc.

Certificate of Calibration

for

AXIAL T COIL PROBE

Manufactured by: **TEM CONSULTING LP**
 Model No: **AXIAL T COIL PROBE**
 Serial No: **TEM-1123**
 Calibration Recall No: **29156**

Submitted By:

Customer: **Andrew Harwell**
 Company: **PCTest Engineering Lab**
 Address: **6660-B Dobbin Road**
 Columbia **MD 21045**

The subject instrument was calibrated to the indicated specification using standards traceable to the National Institute of Standards and Technology or to accepted values of natural physical constants. This document certifies that the instrument met the following specification upon its return to the submitter.

West Caldwell Calibration Laboratories Procedure No. **AXIAL T C TEM C**

Upon receipt for Calibration, the instrument was found to be:

Within (X)

VAA
12/4/2019

tolerance of the indicated specification. See attached Report of Calibration.
 The information supplied relates to the calibrated item listed above.
 West Caldwell Calibration Laboratories' calibration control system meets the requirements, ISO 10012-1 MIL-STD-45662A, ANSI/NCSL Z540-1, IEC Guide 25, ISO 9001:2008 and ISO 17025.

Note: With this Certificate, Report of Calibration is included.

Approved by: *Fc*

Calibration Date: **19-Sep-18**

Felix Christopher (QA Mgr.)

Certificate No: **29156 -2**

ISO/IEC 17025:2005



QA Doc. #1051 Rev. 2.0 10/1/01

Certificate Page 1 of 1

West Caldwell Calibration Laboratories, Inc.
 uncompromised calibration
 1575 State Route 96, Victor, NY 14564, U.S.A.



Calibration Lab. Cert. # 1533.01

FCC ID: ZNFV450PM		HAC (T-COIL) TEST REPORT		Approved by: Quality Manager
Filename: 1M1811230205-13-R4.ZNF	Test Dates: 01/07/2019 - 01/22/2019	DUT Type: Portable Handset		Page 79 of 90



REPORT OF CALIBRATION

for

TEM Consulting LP Axial T Coil Probe
Company: PCTest Engineering Lab

Model No.: Axial T Coil Probe

Serial No.: TEM-1123
I. D. No.: XXXX

Calibration results:

Probe Sensitivity measured with Helmholtz Coil

Helmholtz Coil;
the number of turns on each coil; 10 No.
the radius of each coil, in meters; 0.204 m
the current in the coils, in amperes.; 0.08 A
Helmholtz Coil Constant; 7.09 A/m/V
Helmholtz Coil magnetic field; 5.95 A/m

Before & after data same: ...X...

Laboratory Environment:
Ambient Temperature: 22.7 °C
Ambient Humidity: 52.1 % RH
Ambient Pressure: 99.326 kPa
Calibration Date: 19-Sep-2018
Calibration Due:
Report Number: 29156 -2
Control Number: 29156

Probe Sensitivity at 1000 Hz.
was -59.89 dBV/A/m
1.013 mV/A/m
Probe resistance 903 Ohms

The above listed instrument meets or exceeds the tested manufacturer's specifications.

This Calibration is traceable through NIST test numbers: 683/284413-14
The expanded uncertainty of calibration: 0.30dB at 95% confidence level with a coverage factor of k=2.
Graph represents Probes Frequency Response.

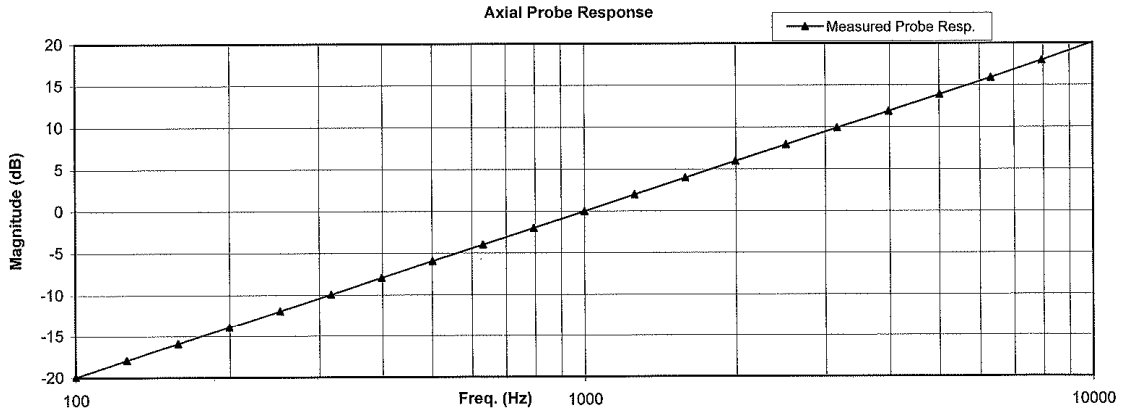

The above listed instrument was checked using calibration procedure documented in West Caldwell Calibration Laboratories Inc. procedure : Rev. 7.0 Jan. 24, 2014 Doc. # 1038 HCATEMC
Calibration was performed by West Caldwell Calibration Laboratories Inc. under Operating Procedures intended to implement the requirements of ISO10012-1, IEC Guide 25, ANSI/NCSL Z540-1, (MIL-STD-45662A) and ISO 9001:2008, ISO 17025

Cal. Date: 19-Sep-2018

Measurements performed by: *James Zhu*

Calibrated on WCCL system type 9700

James Zhu

This document shall not be reproduced, except in full, without the written approval from West Caldwell Cal. Labs. Inc.

Rev. 7.0 Jan. 24, 2014 Doc. # 1038 HCATEMC

FCC ID: ZNFV450PM		HAC (T-COIL) TEST REPORT		Approved by: Quality Manager
Filename: 1M1811230205-13-R4.ZNF	Test Dates: 01/07/2019 - 01/22/2019	DUT Type: Portable Handset		Page 80 of 90

HCATEMC_TEM-1123_Sep-19-2018

West Caldwell Calibration Laboratories Inc.

1575 State Route 96, Victor NY 14564
Tel. (585) 586-3900 FAX (585) 586-4327

Calibration Data Record

TEM Consulting LP Axial T Coil Probe
Company: PCTest Engineering Lab

for
Model No.: Axial T Coil Probe

Serial No.: TEM-1123

Test	Function	Tolerance		Measured values		
				Before	Out	Remarks
1.0	Probe Sensitivity at	1000 Hz.	dBV/A/m	-59.89		
2.0	Probe Level Linearity	Ref. (0 dB)	dB			
			6	6.03		
			0	0.00		
			-6	-6.03		
			-12	-12.05		
3.0	Probe Frequency Response	Ref. (0 dB)	Hz			
			100	-19.9		
			126	-17.9		
			158	-15.9		
			200	-13.9		
			251	-11.9		
			316	-9.9		
			398	-7.9		
			501	-6.0		
			631	-4.0		
			794	-2.0		
			1000	0.0		
			1259	2.0		
			1585	4.0		
			1995	5.9		
			2512	7.9		
			3162	9.9		
3981	11.9					
5012	13.9					
6310	15.9					
7943	18.0					
10000	20.1					

Instruments used for calibration:			Date of Cal.	Traceability No.	Due Date
HP	34401A	S/N US360641	25-Jul-2018	,287708	25-Jul-2019
HP	34401A	S/N US361024	25-Jul-2018	,287708	25-Jul-2019
HP	33120A	S/N US360437	25-Jul-2018	,287708	25-Jul-2019
B&K	2133	S/N 1583254	25-Jul-2018	683/284413-14	25-Jul-2019



Cal. Date: 19-Sep-2018

Tested by: James Zhu

Calibrated on WCCL system type 9700

This document shall not be reproduced, except in full, without the written approval from West Caldwell Cal. Labs. Inc.

Rev. 7.0 Jan. 24, 2014 Doc. # 1038 HCATEMC

FCC ID: ZNFV450PM		HAC (T-COIL) TEST REPORT		Approved by: Quality Manager
Filename: 1M1811230205-13-R4.ZNF	Test Dates: 01/07/2019 - 01/22/2019	DUT Type: Portable Handset		Page 81 of 90

West Caldwell Calibration Laboratories Inc.

Certificate of Calibration

for

RADIAL T COIL PROBE

Manufactured by: TEM CONSULTING LP
 Model No: RADIAL T COIL PROBE
 Serial No: TEM-1129
 Calibration Recall No: 29156

Submitted By:

Customer: Andrew Harwell
 Company: PCTest Engineering Lab
 Address: 6660-B Dobbin Road
 Columbia MD 21045

The subject instrument was calibrated to the indicated specification using standards traceable to the National Institute of Standards and Technology or to accepted values of natural physical constants. This document certifies that the instrument met the following specification upon its return to the submitter.

West Caldwell Calibration Laboratories Procedure No. RADIAL T TEM C

Upon receipt for Calibration, the instrument was found to be:

Within (X)

JAH
12/4/2018

tolerance of the indicated specification. See attached Report of Calibration. The information supplied relates to the calibrated item listed above.

West Caldwell Calibration Laboratories' calibration control system meets the requirements, ISO 10012-1 MIL-STD-45662A, ANSI/NCCL Z540-1, IEC Guide 25, ISO 9001:2008 and ISO 17025.

Note: With this Certificate, Report of Calibration is included.

Approved by: *FC*

Calibration Date: 19-Sep-18

Felix Christopher (QA Mgr.)

Certificate No: 29156 -1

ISO/IEC 17025:2005



QA Doc. #1051 Rev. 2.0 10/1/01

Certificate Page 1 of 1

West Caldwell Calibration Laboratories, Inc.
 uncompromised calibration
 1575 State Route 96, Victor, NY 14564, U.S.A.



Calibration Lab. Cert. # 1533.01

FCC ID: ZNFV450PM	 PCTEST ENGINEERING LABORATORY, INC.	HAC (T-COIL) TEST REPORT		Approved by: Quality Manager
Filename: 1M1811230205-13-R4.ZNF	Test Dates: 01/07/2019 - 01/22/2019	DUT Type: Portable Handset		Page 82 of 90



REPORT OF CALIBRATION

for

TEM Consulting LP Radial T Coil Probe
Company: PCTest Engineering Lab

Model No.: Radial T Coil Probe

Serial No.: TEM-1129
I. D. No.: XXXX

Calibration results:			
Probe Sensitivity measured with Helmholtz Coil			
<i>Helmholtz Coil;</i>			
the number of turns on each coil;	10	No.	Before & after data same: ...X...
the radius of each coil, in meters;	0.204	m	
the current in the coils, in amperes.;	0.08	A	
<i>Helmholtz Coil Constant;</i>	7.09	A/m/V	Laboratory Environment: Ambient Temperature: 22.7 °C Ambient Humidity: 52.1 % RH Ambient Pressure: 99.326 kPa Calibration Date: 19-Sep-2018 Re-calibration Due: Report Number: 29156 -1 Control Number: 29156
<i>Helmholtz Coil magnetic field;</i>	5.95	A/m	
Probe Sensitivity at	1000	Hz.	
was	-60.37	dBV/A/m	
	0.958	mV/A/m	
Probe resistance	886	Ohms	

The above listed instrument meets or exceeds the tested manufacturer's specifications.

This Calibration is traceable through NIST test numbers: 683/284413-14

The expanded uncertainty of calibration: 0.30dB at 95% confidence level with a coverage factor of k=2.

Graph represents Probes Frequency Response.

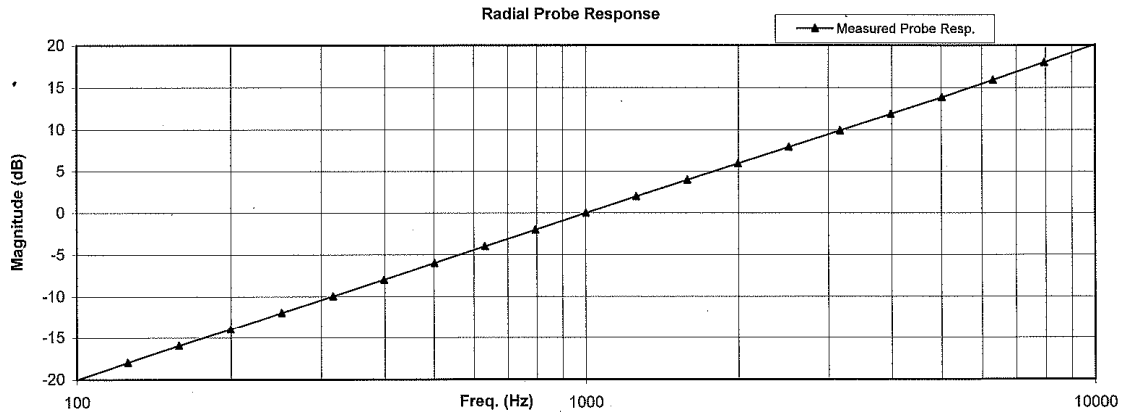

The above listed instrument was checked using calibration procedure documented in West Caldwell Calibration Laboratories Inc. procedure : Rev. 7.0 Jan. 24, 2014 Doc. # 1038 HCRTEMC
Calibration was performed by West Caldwell Calibration Laboratories Inc. under Operating Procedures intended to implement the requirements of ISO10012-1, IEC Guide 25, ANSI/NCSL Z540-1, (MIL-STD-45662A) and ISO 9001:2008, ISO 17025

Cal. Date: 19-Sep-2018

Measurements performed by: James Zhu

Calibrated on WCCL system type 9700

James Zhu

This document shall not be reproduced, except in full, without the written approval from West Caldwell Cal. Labs. Inc.

Rev. 7.0 Jan. 24, 2014 Doc. # 1038 HCRTEMC

FCC ID: ZNFV450PM		HAC (T-COIL) TEST REPORT		Approved by: Quality Manager
Filename: 1M1811230205-13-R4.ZNF	Test Dates: 01/07/2019 - 01/22/2019	DUT Type: Portable Handset		Page 83 of 90

West Caldwell Calibration Laboratories Inc.

1575 State Route 96, Victor NY 14564
Tel. (585) 586-3900 FAX (585) 586-4327

Calibration Data Record

TEM Consulting LP Radial T Coil Probe
Company: PCTest Engineering Lab

for
Model No.: Radial T Coil Probe

Serial No.: TEM-1129

Test	Function	Tolerance	Measured values			
			Before	Out	Remarks	
1.0	Probe Sensitivity at	1000 Hz. dBV/A/m	-60.37			
2.0	Probe Level Linearity	dB				
		6	6.03			
		0	0.00			
		-6	-6.03			
		Ref. (0 dB)	-12	-12.05		
3.0	Probe Frequency Response	Hz				
		100	-20.0			
		126	-17.9			
		158	-15.9			
		200	-14.0			
		251	-12.0			
		316	-10.0			
		398	-8.0			
		501	-6.0			
		631	-4.0			
		794	-2.0			
			Ref. (0 dB)	1000	0.0	
				1259	2.0	
				1585	4.0	
				1995	6.0	
				2512	7.9	
				3162	9.9	
				3981	11.9	
				5012	13.9	
		6310	15.9			
		7943	18.0			
		10000	20.1			



Instruments used for calibration:			Date of Cal.	Traceability No.	Due Date
HP	34401A	S/N US360641	25-Jul-2018	,287708	25-Jul-2019
HP	34401A	S/N US361024	25-Jul-2018	,287708	25-Jul-2019
HP	33120A	S/N US360437	25-Jul-2018	,287708	25-Jul-2019
B&K	2133	S/N 1583254	25-Jul-2018	683/284413-14	25-Jul-2019

Cal. Date: 19-Sep-2018
Calibrated on WCCL system type 9700

Tested by: James Zhu

This document shall not be reproduced, except in full, without the written approval from West Caldwell Cal. Labs, Inc.



Rev. 7.0 Jan. 24, 2014 Doc. # 1038 HCRTEMC

FCC ID: ZNFV450PM		HAC (T-COIL) TEST REPORT		Approved by: Quality Manager
Filename: 1M1811230205-13-R4.ZNF	Test Dates: 01/07/2019 - 01/22/2019	DUT Type: Portable Handset		Page 84 of 90

14. CONCLUSION

The measurements indicate that the wireless communications device complies with the HAC limits specified in accordance with the ANSI C63.19 Standard and FCC WT Docket No. 01-309 RM-8658. Precise laboratory measures were taken to assure repeatability of the tests. The tested device complies with the requirements in respect to all parameters specific to the test. The test results and statements relate only to the item(s) tested.

The measurement system and techniques presented in this evaluation are proposed in the ANSI standard as a means of best approximating wireless device compatibility with a hearing-aid. The literature is under continual re-construction.

FCC ID: ZNFV450PM		HAC (T-COIL) TEST REPORT		Approved by: Quality Manager
Filename: 1M1811230205-13-R4.ZNF	Test Dates: 01/07/2019 - 01/22/2019	DUT Type: Portable Handset		Page 85 of 90



© 2019 PCTEST Engineering Laboratory, Inc.

REV 3.2.M
04/17/2018

© 2019 PCTEST Engineering Laboratory, Inc. All rights reserved. Unless otherwise specified, no part of this report may be reproduced or utilized in any part, form or by any means, electronic or mechanical, including photocopying and microfilm, without permission in writing from PCTEST Engineering Laboratory, Inc. If you have any questions about this international copyright or have an enquiry about obtaining additional rights to this report or assembly of contents thereof, please contact INFO@PCTEST.COM.

15. REFERENCES

1. ANSI C63.19-2011, American National Standard for Methods of Measurement of Compatibility between Wireless communication devices and Hearing Aids., New York, NY, IEEE, May 2011
2. FCC Office of Engineering and Technology KDB, "285076 D01 HAC Guidance v05," September 13, 2017
3. FCC Office of Engineering and Technology KDB, "285076 D02 T-Coil Testing for CMRS IP v03," September 13, 2017
4. FCC Public Notice DA 06-1215, *Wireless Telecommunications Bureau and Office of Engineering and Technology Clarify Use of Revised Wireless Phone Hearing Aid Compatibility Standard*, June 6, 2006
5. FCC 3G Review Guidance, Laboratory Division OET FCC, May/June 2006
6. Berger, H. S., "Compatibility Between Hearing Aids and Wireless Devices," Electronic Industries Forum, Boston, MA, May, 1997
7. Berger, H. S., "Hearing Aid and Cellular Phone Compatibility: Working Toward Solutions," Wireless Telephones and Hearing Aids: New Challenges for Audiology, Gallaudet University, Washington, D.C., May, 1997 (To be reprinted in the American Journal of Audiology).
8. Berger, H. S., "Hearing Aid Compatibility with Wireless Communications Devices," IEEE International Symposium on Electromagnetic Compatibility, Austin, TX, August, 1997.
9. Bronaugh, E. L., "Simplifying EMI Immunity (Susceptibility) Tests in TEM Cells," in the 1990 IEEE International Symposium on Electromagnetic Compatibility Symposium Record, Washington, D.C., August 1990, pp. 488-491
10. Byrne, D. and Dillon, H., The National Acoustics Laboratory (NAL) New Procedure for Selecting the Gain and Frequency Response of a Hearing Aid, *Ear and Hearing* 7:257-265, 1986.
11. Crawford, M. L., "Measurement of Electromagnetic Radiation from Electronic Equipment using TEM Transmission Cells," U.S. Department of Commerce, National Bureau of Standards, NBSIR 73-306, Feb. 1973.
12. Crawford, M. L., and Workman, J. L., "Using a TEM Cell for EMC Measurements of Electronic Equipment," U.S. Department of Commerce, National Bureau of Standards. Technical Note 1013, July 1981.
13. EHIMA GSM Project, Development phase, Project Report (1st part) Revision A. Technical-Audiological Laboratory and Telecom Denmark, October 1993.
14. EHIMA GSM Project, Development phase, Part II Project Report. Technical-Audiological Laboratory and Telecom Denmark, June 1994.
15. EHIMA GSM Project Final Report, Hearing Aids and GSM Mobile Telephones: Interference Problems, Methods of Measurement and Levels of Immunity. Technical-Audiological Laboratory and Telecom Denmark, 1995.
16. HAMPIS Report, Comparison of Mobile phone electromagnetic near field with an upscaled electromagnetic far field, using hearing aid as reference, 21 October 1999.



FCC ID: ZNFV450PM		HAC (T-COIL) TEST REPORT		Approved by: Quality Manager
Filename: 1M1811230205-13-R4.ZNF	Test Dates: 01/07/2019 - 01/22/2019	DUT Type: Portable Handset	Page 86 of 90	

© 2019 PCTEST Engineering Laboratory, Inc.

REV 3.2.M
04/17/2018

© 2019 PCTEST Engineering Laboratory, Inc. All rights reserved. Unless otherwise specified, no part of this report may be reproduced or utilized in any part, form or by any means, electronic or mechanical, including photocopying and microfilm, without permission in writing from PCTEST Engineering Laboratory, Inc. If you have any questions about this international copyright or have an enquiry about obtaining additional rights to this report or assembly of contents thereof, please contact INFO@PCTEST.COM.

17. Hearing Aids/GSM, Report from OTWIDAM, Technical-Audiological Laboratory and Telecom Denmark, April 1993.
18. IEEE 100, The Authoritative Dictionary of IEEE Standards Terms, Seventh Edition.
19. Joyner, K. H., et. al., Interference to Hearing Aids by the New Digital Mobile Telephone System, Global System for Mobile (GSM) Communication Standard, National Acoustic Laboratory, Australian Hearing Series, Sydney 1993.
20. Joyner, K. H., et. al., Interference to Hearing Aids by the Digital Mobile Telephone System, Global System for Mobile Communications (GSM), NAL Report #131, National Acoustic Laboratory, Australian Hearing Series, Sydney, 1995.
21. Kecker, W. T., Crawford, M. L., and Wilson, W. A., "Construction of a Transverse Electromagnetic Cell", U.S. Department of Commerce, National Bureau of Standards, Technical Note 1011, Nov. 1978.
22. Konigstein, D., and Hansen, D., "A New Family of TEM Cells with enlarged bandwidth and Optimized working Volume," in the Proceedings of the 7th International Symposium on EMC, Zurich, Switzerland, March 1987; 50:9, pp. 127-132.
23. Kuk, F., and Hjorstgaard, N. K., "Factors affecting interference from digital cellular telephones," Hearing Journal, 1997; 50:9, pp 32-34.
24. Ma, M. A., and Kanda, M., "Electromagnetic Compatibility and Interference Metrology," U.S. Department of Commerce, National Bureau of Standards, Technical Note 1099, July 1986, pp. 17-43.
25. Ma, M. A., Sreenivashiah, I. , and Chang, D. C., "A Method of Determining the Emission and Susceptibility Levels of Electrically Small Objects Using a TEM Cell," U.S. Department of Commerce, National Bureau of Standards, Technial Note 1040, July 1981.
26. McCandless, G. A., and Lyregaard, P. E., Prescription of Gain/Output (POGO) for Hearing Aids, Hearing Instruments 1:16-21, 1983
27. Skopec, M., "Hearing Aid Electromagnetic Interference from Digital Wireless Telephones, "IEEE Transactions on Rehabilitation Engineering, vol. 6, no. 2, pp. 235-239, June 1998.
28. Technical Report, GSM 05.90, GSM EMC Considerations, European Telecommunications Standards Institute, January 1993.
29. Victorian, T. A., "Digital Cellular Telephone Interference and Hearing Aid Compatibility—an Update," Hearing Journal 1998; 51:10, pp. 53-60
30. Wong, G. S. K., and Embleton, T. F. W., eds., AIP Handbook of Condenser Microphones: Theory, Calibration and Measurements, AIP Press.

FCC ID: ZNFV450PM		HAC (T-COIL) TEST REPORT		Approved by: Quality Manager
Filename: 1M1811230205-13-R4.ZNF	Test Dates: 01/07/2019 - 01/22/2019	DUT Type: Portable Handset	Page 87 of 90	

© 2019 PCTEST Engineering Laboratory, Inc.

REV 3.2.M

04/17/2018

© 2019 PCTEST Engineering Laboratory, Inc. All rights reserved. Unless otherwise specified, no part of this report may be reproduced or utilized in any part, form or by any means, electronic or mechanical, including photocopying and microfilm, without permission in writing from PCTEST Engineering Laboratory, Inc. If you have any questions about this international copyright or have an enquiry about obtaining additional rights to this report or assembly of contents thereof, please contact INFO@PCTEST.COM.