

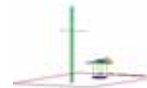

# PCTEST ENGINEERING LABORATORY, INC.

6660-B Dobbin Road, Columbia, MD 21045 USA  
Tel. 410.290.6652 / Fax 410.290.6654  
http://www.pctestlab.com



## MEASUREMENT REPORT FCC PART 15.247 / IC RSS-210 Bluetooth

**Applicant Name:**  
LG Electronics MobileComm U.S.A., Inc.  
10101 Old Grove Road,  
San Diego, CA 92131  
USA

**Date of Testing:**  
January 5, 28, 2012  
**Test Site/Location:**  
PCTEST Lab. Columbia, MD, USA  
**Test Report Serial No.:**  
0Y1201030002.ZNF

<b>FCC ID:</b>	<b>ZNFLG530G</b>
<b>APPLICANT:</b>	<b>LG Electronics MobileComm U.S.A., Inc.</b>

**Application Type:** Certification

**Model(s):** LG530G, LG530g

**EUT Type:** Portable Handset

**Max. RF Output Power:** 8.091 mW (9.08dBm) Conducted

**Frequency Range:** 2402 – 2480MHz (Bluetooth for US)

**Type of Modulation:** GFSK,  $\pi/4$ -DQPSK, 8DPSK

**FCC Classification:** FCC Part 15 Spread Spectrum Transmitter (DSS)

**FCC Rule Part(s):** Part 15 Subpart C (15.247)

**IC Specification(s):** RSS-210 Issue 8

This equipment has been shown to be capable of compliance with the applicable technical standards as indicated in the measurement report and was tested in accordance with the measurement procedures specified in ANSI C63.4-2003. Test results reported herein relate only to the item(s) tested.



I attest to the accuracy of data. All measurements reported herein were performed by me or were made under my supervision and are correct to the best of my knowledge and belief. I assume full responsibility for the completeness of these measurements and vouch for the qualifications of all persons taking them.

*Grant Conditions: Power output listed is conducted.*

*PCTEST certifies that no party to this application has been subject to a denial of Federal benefits that includes FCC benefits pursuant to Section 5301 of the Anti-Drug Abuse Act of 1988, 21 U.S.C. 862.*

  
\_\_\_\_\_  
Randy Ortanez  
President





<b>FCC ID:</b> ZNFLG530G		<b>FCC Pt. 15.247 BLUETOOTH TEST REPORT (CERTIFICATION)</b>		<b>Reviewed by:</b> Quality Manager
<b>Test Report S/N:</b> 0Y1201030002.ZNF	<b>Test Dates:</b> January 5, 28, 2012	<b>EUT Type:</b> Portable Handset	Page 1 of 35	

# TABLE OF CONTENTS

---

FCC PART 15.247 MEASUREMENT REPORT.....		3
1.0 INTRODUCTION.....		4
1.1 SCOPE.....		4
1.2 PCTEST TEST LOCATION.....		4
2.0 PRODUCT INFORMATION.....		5
2.1 EQUIPMENT DESCRIPTION.....		5
2.2 DEVICE CAPABILITIES.....		5
2.3 EMI SUPPRESSION DEVICE(S)/MODIFICATIONS.....		5
2.4 LABELING REQUIREMENTS.....		5
3.0 DESCRIPTION OF TEST.....		6
3.1 EVALUATION PROCEDURE.....		6
3.2 CONDUCTED EMISSIONS.....		6
3.3 RADIATED EMISSIONS.....		7
4.0 ANTENNA REQUIREMENTS.....		8
5.0 TEST EQUIPMENT CALIBRATION DATA.....		9
6.0 TEST RESULTS.....		10
6.1 SUMMARY.....		10
6.2 20DB BANDWIDTH MEASUREMENT.....		11
6.3 OUTPUT POWER MEASUREMENT.....		17
6.4 BAND EDGE COMPLIANCE.....		18
6.5 CARRIER FREQUENCY SEPARATION.....		21
6.6 TIME OF OCCUPANCY.....		22
6.7 NUMBER OF HOPPING CHANNELS.....		23
6.8 CONDUCTED SPURIOUS EMISSIONS.....		24
6.9 RADIATED SPURIOUS EMISSION MEASUREMENTS.....		28
6.10 RADIATED RESTRICTED BAND EDGE MEASUREMENTS.....		32
6.11 LINE-CONDUCTED TEST DATA.....		33
7.0 CONCLUSION.....		35

<b>FCC ID:</b> ZNFLG530G		<b>FCC Pt. 15.247 BLUETOOTH TEST REPORT (CERTIFICATION)</b>		<b>Reviewed by:</b> Quality Manager
<b>Test Report S/N:</b> 0Y1201030002.ZNF	<b>Test Dates:</b> January 5, 28, 2012	<b>EUT Type:</b> Portable Handset	Page 2 of 35	

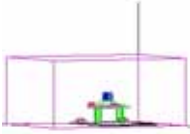

# MEASUREMENT REPORT

## FCC Part 15.247

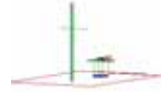

### § 2.1033 General Information



**APPLICANT:** LG Electronics MobileComm U.S.A., Inc.  
**APPLICANT ADDRESS:** 10101 Old Grove Road,  
 San Diego, CA 92131, USA  
**TEST SITE:** PCTEST ENGINEERING LABORATORY, INC.  
**TEST SITE ADDRESS:** 6660-B Dobbin Road, Columbia, MD 21045 USA  
**FCC RULE PART(S):** Part 15 Subpart C (15.247)  
**IC SPECIFICATION(S):** RSS-210 Issue 8  
**BASE MODEL:** LG530G  
**FCC ID:** ZNFLG530G  
**Test Device Serial No.:** 111KPRW096110,  Production  Pre-Production  Engineering  
 111KPPB096112  
**FCC CLASSIFICATION:** FCC Part 15 Spread Spectrum Transmitter (DSS)  
**Method/System:** Frequency Hopping Spread Spectrum (FHSS)  
**DATE(S) OF TEST:** January 5, 28, 2012  
**TEST REPORT S/N:** 0Y1201030002.ZNF

### Test Facility / Accreditations

Measurements were performed at PCTEST Engineering Lab located in Columbia, MD 21045, U.S.A.



- PCTEST facility is an FCC registered (PCTEST Reg. No. 90864) test facility with the site description report on file and has met all the requirements specified in Section 2.948 of the FCC Rules and Industry Canada (2451A-1).
- PCTEST Lab is accredited to ISO 17025 by U.S. National Institute of Standards and Technology (NIST) under the National Voluntary Laboratory Accreditation Program (NVLAP Lab code: 100431-0) in EMC, FCC and Telecommunications.
- PCTEST Lab is accredited to ISO 17025-2005 by the American Association for Laboratory Accreditation (A2LA) in Specific Absorption Rate (SAR) testing, Hearing Aid Compatibility (HAC) testing, CTIA Test Plans, and wireless testing for FCC and Industry Canada Rules.
- PCTEST Lab is a recognized U.S. Conformity Assessment Body (CAB) in EMC and R&TTE (n.b. 0982) under the U.S.-EU Mutual Recognition Agreement (MRA).
- PCTEST TCB is a Telecommunication Certification Body (TCB) accredited to ISO/IEC Guide 65 by the American National Standards Institute (ANSI) in all scopes of FCC Rules and Industry Canada Standards (RSS).
- PCTEST facility is an IC registered (2451A-1) test laboratory with the site description on file at Industry Canada.
- PCTEST is a CTIA Authorized Test Laboratory (CATL) for AMPS, CDMA, and EvDO wireless devices and for Over-the-Air (OTA) Antenna Performance testing for AMPS, CDMA, GSM, GPRS, EGPRS, UMTS (W-CDMA), CDMA 1xEVDO, and CDMA 1xRTT.

<b>FCC ID:</b> ZNFLG530G	 <b>FCC Pt. 15.247 BLUETOOTH TEST REPORT</b> <b>(CERTIFICATION)</b>			<b>Reviewed by:</b> Quality Manager
<b>Test Report S/N:</b> 0Y1201030002.ZNF	<b>Test Dates:</b> January 5, 28, 2012	<b>EUT Type:</b> Portable Handset		Page 3 of 35

## 1.0 INTRODUCTION

### 1.1 Scope

Measurement and determination of electromagnetic emissions (EMC) of radio frequency devices including intentional and/or unintentional radiators for compliance with the technical rules and regulations of the Federal Communications Commission and the Industry Canada Certification and Engineering Bureau.

### 1.2 PCTEST Test Location

The map below shows the location of the PCTEST LABORATORY, its proximity to the FCC Laboratory, the Columbia vicinity, the Baltimore-Washington Intern'l (BWI) airport, the city of Baltimore and the Washington, DC area. (see Figure 1-1).

These measurement tests were conducted at the PCTEST Engineering Laboratory, Inc. facility in New Concept Business Park, Guilford Industrial Park, Columbia, Maryland. The site address is 6660-B Dobbin Road, Columbia, MD 21045. The test site is one of the highest points in the Columbia area with an elevation of 390 feet above mean sea level. The site coordinates are 39° 11'15" N latitude and 76° 49'38" W longitude. The facility is 1.5 miles North of the FCC laboratory, and the ambient signal and ambient signal strength are approximately equal to those of the FCC laboratory. There are no FM or TV transmitters within 15 miles of the site. The detailed description of the measurement facility was found to be in compliance with the requirements of § 2.948 according to ANSI C63.4-2003 on January 28, 2009.

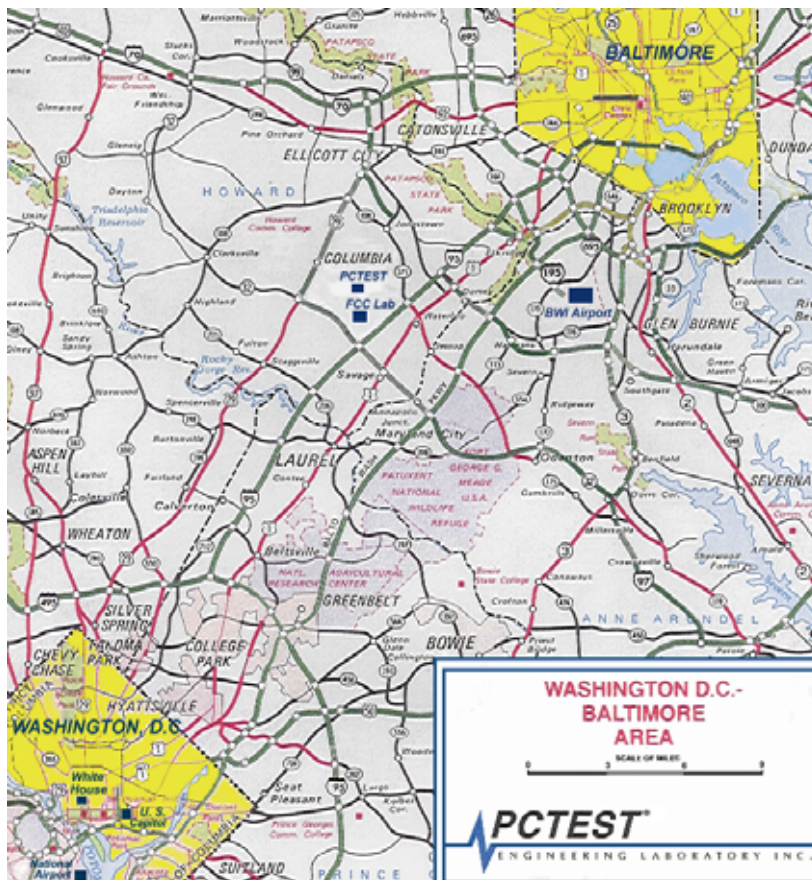



Figure 1-1. Map of the Greater Baltimore and Metropolitan Washington, D.C. area

FCC ID: ZNFLG530G		FCC Pt. 15.247 BLUETOOTH TEST REPORT (CERTIFICATION)		Reviewed by: Quality Manager
Test Report S/N: 0Y1201030002.ZNF	Test Dates: January 5, 28, 2012	EUT Type: Portable Handset		Page 4 of 35

## 2.0 PRODUCT INFORMATION

### 2.1 Equipment Description

The Equipment Under Test (EUT) is the **LGE Portable Handset FCC ID: ZNFLG530G**. The test data contained in this report pertains only to the emissions due to the EUT's Bluetooth transmitter.

- This Bluetooth module has been tested by a Bluetooth Qualification Lab, and we confirm the following:
  - A) The hopping sequence is pseudorandom
  - B) All channels are used equally on average
  - C) The receiver input bandwidth equals the transmit bandwidth
  - D) The receiver hops in sequence with the transmit signal
- 15.247(g): In accordance with the Bluetooth Industry Standard, the system is designed to comply with all of the regulations in Section 15.247 when the transmitter is presented with a continuous data (or information) system.
- 15.247(h): In accordance with the Bluetooth Industry Standard, the system does not coordinate its channels selection/ hopping sequence with other frequency hopping systems for the express purpose of avoiding the simultaneous occupancy of individual hopping frequencies by multiple transmitters.
- The EUT consisted of the following component(s):

Manufacturer / Base Model	FCC ID	Description
LGE / Model: LG530G	ZNFLG530G	Portable Handset

**Table 2-1. EUT Equipment Description**

### 2.2 Device Capabilities

This device contains the following capabilities:

850/1900 GSM/GPRS, EDGE Rx, 850/1900 WCDMA, Bluetooth

### 2.3 EMI Suppression Device(s)/Modifications



No EMI suppression device(s) were added and no modifications were made during testing.

### 2.4 Labeling Requirements

Per 15.19; Docket 95-19

The label shall be permanently affixed at a conspicuous location on the device; instruction manual or pamphlet supplied to the user and be readily visible to the purchaser at the time of purchase. However, when the device is so small wherein placement of the label with specified statement is not practical, only the trade name and FCC ID must be displayed on the device per Section 15.19(b)(2).

Please see attachment for FCC ID label and label location.

FCC ID: ZNFLG530G			FCC Pt. 15.247 BLUETOOTH TEST REPORT (CERTIFICATION)		Reviewed by: Quality Manager
Test Report S/N: 0Y1201030002.ZNF	Test Dates: January 5, 28, 2012	EUT Type: Portable Handset			Page 5 of 35

## 3.0 DESCRIPTION OF TEST

### 3.1 Evaluation Procedure

The measurement procedure described in the American National Standard for Methods of Measurement of Radio-Noise Emission from Low-Voltage Electrical and Electronic Equipment in the Range of 9kHz to 40GHz (ANSI C63.4-2003) and FCC Public Notice DA 00-705 dated March 30, 2000 entitled "Filing and Measurement Guidelines for Frequency Hopping Spread Spectrum Systems" were used in the measurement of the **LGE Portable Handset FCC ID: ZNFLG530G**.

Deviation from measurement procedure.....None

### 3.2 Conducted Emissions

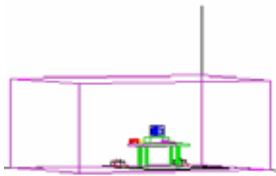

**Figure 3-1. Shielded Enclosure Line-Conducted Test Facility**



**Figure 3-2. Line Conducted Emission Test Set-Up**

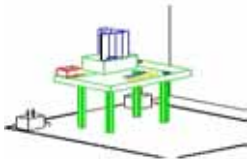

**Figure 3-3. Wooden Table & Bonded LISNs**

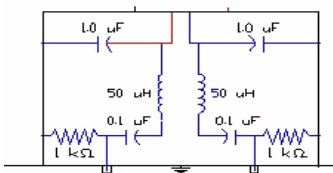

**Figure 3-4. LISN Schematic Diagram**

The line-conducted facility is located inside a 16'x20'x10' shielded enclosure, manufactured by Ray Proof Series 81 (see Figure 3-1). The shielding effectiveness of the shielded room is in accordance with MIL-Std-285 or NSA 65-5. A 1m x 1.5m wooden table 80cm high is placed 40cm away from the vertical wall and 1.5m away from the sidewall of the shielded room (see Figure 3-2). Solar Electronics and EMCO Model 3725/2 (10kHz-30MHz) 50Ω/50μH Line-Impedance Stabilization Networks (LISNs) are bonded to the shielded room (see Figure 3-3). The EUT is powered from the Solar LISN and the support equipment is powered from the EMCO LISN. Power to the LISNs are filtered by a high-current high-insertion loss Ray Proof power line filter (100dB 14Hz-10GHz). The purpose of the filter is to attenuate ambient signal interference and this filter is also bonded to the shielded enclosure. All electrical cables are shielded by braided tinned copper zipper tubing with an inner diameter of ½". If the EUT is a DC-powered device, power will be derived from the source power supply it normally will be powered from and this supply line(s) will be connected to the Solar LISN. The LISN schematic diagram is shown (see Figure 3-4). All interconnecting cables more than 1 meter were shortened to a 1 meter length by non-inductive bundling (serpentine fashion). Sufficient time for the EUT, support equipment, and test equipment was allowed in order for them to warm up to their normal operating condition. The RF output of the LISN was connected to the spectrum analyzer to determine the frequency producing the maximum EME from the EUT.

The spectrum was scanned from 150kHz to 30MHz with a spectrum analyzer. The detector function was set to CISPR quasi-peak and average mode. The bandwidth of the analyzer was set to 10kHz. The EUT, support equipment, and interconnecting cables were arranged and manipulated to maximize each EME emission. Each emission was maximized by: switching power lines; varying the mode of operation or resolution; clock or data exchange speed; scrolling H pattern to the EUT and/or support equipment, and powering the monitor from the floor mounted outlet box and the computer aux AC outlet, if applicable; whichever determined the worst-case emission. Photographs of the worst-case emission can be seen in the test setup photographs. Each EME reported was calibrated using the Agilent E8257D (250kHz – 20GHz) PSG Signal Generator.

FCC ID: ZNFLG530G		FCC Pt. 15.247 BLUETOOTH TEST REPORT (CERTIFICATION)		Reviewed by: Quality Manager
Test Report S/N: 0Y1201030002.ZNF	Test Dates: January 5, 28, 2012	EUT Type: Portable Handset		Page 6 of 35

### 3.3 Radiated Emissions

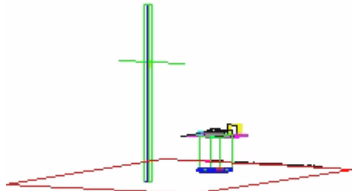

**Figure 3-5. 3-Meter Test Site**

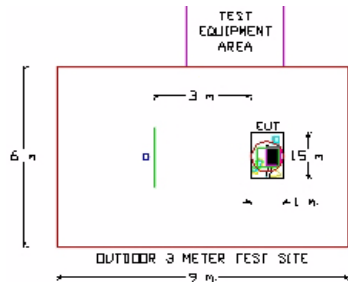

**Figure 3-6. Dimensions of Outdoor Test Site**

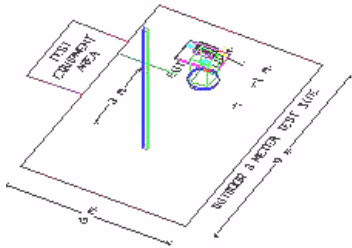

**Figure 3-7. Turntable and System Setup**

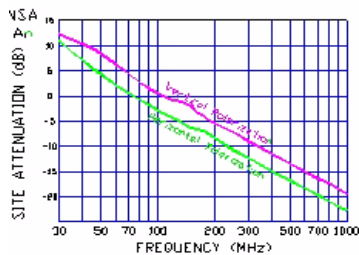

**Figure 3-8. Normalized Site Attenuation Curves (H&V)**

Preliminary measurements were made indoors at 1-meter using broadband antennas, broadband amplifiers, and spectrum analyzers to determine the frequency producing the maximum EME. Appropriate precaution was taken to ensure that all EME from the EUT were maximized and investigated. The system configuration, clock speed, mode of operation or video resolution, and turntable azimuth with respect to the antenna was noted for each frequency found. The spectrum was scanned from 30 to 200 MHz using a bi-conical antenna and from 200 to 1000 MHz using a log-spiral antenna. Above 1 GHz, linearly polarized double ridge horn antennas were used.

Final measurements were made outdoors at 3-meter test range using Roberts™ Dipole antennas or horn antennas (see Figure 3-5). The test equipment was placed on a wooden and plastic bench situated on a 1.5m x 2m area adjacent to the measurement area (see Figure 3-6). Sufficient time for the EUT, support equipment, and test equipment was allowed in order for them to warm up to their normal operating condition. The detector function was set to CISPR quasi-peak mode and the bandwidth of the spectrum analyzer was set to 100kHz for frequencies below 1GHz or 1MHz for frequencies above 1GHz. Above 1GHz the detector function was set to average mode (RBW = 1MHz, VBW = 10Hz).

The half-wave dipole antenna was tuned to the frequency found during preliminary radiated measurements. The EUT, support equipment and interconnecting cables were re-configured to the set-up producing the maximum emission for the frequency and were placed on top of a 0.8-meter high non-metallic 1 x 1.5 meter table (see Figure 3-7). The EUT, support equipment, and interconnecting cables were re-arranged and manipulated to maximize each EME emission. The turntable containing the system was rotated and the height of the receive antenna was varied 1 to 4 meters and stopped at the azimuth and height producing the maximum emission. Each emission was maximized by: varying the mode of operation or resolution; clock or data exchange speed; scrolling H pattern to the EUT and/or support equipment, and powering the monitor from the floor mounted outlet box and the computer aux AC outlet, if applicable; and changing the polarity of the antenna, whichever determined the worst-case emission. Photographs of the worst-case emission can be seen in the test setup photographs. Each EME reported was calibrated using the Agilent E8257D (250kHz – 20GHz) PSG Signal Generator. The Theoretical Normalized Site Attenuation Curves for both horizontal and vertical polarization are shown in Figure 3-8.

FCC ID: ZNFLG530G		FCC Pt. 15.247 BLUETOOTH TEST REPORT (CERTIFICATION)		Reviewed by: Quality Manager
Test Report S/N: 0Y1201030002.ZNF	Test Dates: January 5, 28, 2012	EUT Type: Portable Handset		Page 7 of 35

## 4.0 ANTENNA REQUIREMENTS

### Excerpt from §15.203 of the FCC Rules/Regulations:

“An intentional radiator antenna shall be designed to ensure that no antenna other than that furnished by the responsible party can be used with the device. The use of a permanently attached antenna or of an antenna that uses a unique coupling to the intentional radiator shall be considered sufficient to comply with the provisions of this section.”



- The antennas of the LGE Portable Handset are **permanently attached**.
- There are no provisions for connection to an external antenna.

### Conclusion:

The **LGE Portable Handset FCC ID: ZNFLG530G** unit complies with the requirement of §15.203.

Ch.	Frequency (MHz)
00	2402
:	:
39	2441
:	:
78	2480

**Table 4-1. Frequency/ Channel Operations**

<b>FCC ID:</b> ZNFLG530G		<b>FCC Pt. 15.247 BLUETOOTH TEST REPORT (CERTIFICATION)</b>		<b>Reviewed by:</b> Quality Manager
<b>Test Report S/N:</b> 0Y1201030002.ZNF	<b>Test Dates:</b> January 5, 28, 2012	<b>EUT Type:</b> Portable Handset		Page 8 of 35





## 5.0 TEST EQUIPMENT CALIBRATION DATA

Test Equipment Calibration is traceable to the National Institute of Standards and Technology (NIST).

Manufacturer	Model	Description	Cal Date	Cal Interval	Cal Due	Serial Number
Agilent	N4010A	Wireless Connectivity Test Set	N/A		N/A	GB44450273
Agilent	N9038A	MXE EMI Receiver	8/5/2011	Annual	8/5/2012	MY51210133
Agilent	N9020A	MXA Signal Analyzer	10/10/2011	Annual	10/10/2012	US46470561
Anritsu	ML2495A	Power Meter	10/13/2011	Annual	10/13/2012	1039008
Emco	3816/2	LISN	11/3/2010	Biennial	11/3/2012	9707-1079
ETS Lindgren	3117	1-18 GHz DRG Horn (Medium)	7/22/2011	Annual	7/22/2012	125518
ETS Lindgren	3160-09	18-26.5 GHz Standard Gain Horn	5/31/2011	Annual	5/31/2012	135427
Rohde & Schwarz	CMU200	Base Station Simulator	N/A		N/A	836536/0005
Rohde & Schwarz	RS-PR26	18-26.5 GHz Pre-Amplifier	6/9/2011	Annual	6/9/2012	100040
Rohde & Schwarz	RS-PR18	1-18 GHz Pre-Amplifier	6/9/2011	Annual	6/9/2012	100071
Schwarzbeck	VULB-9161SE	Trilog Super Broadband Test Antenna	11/8/2011	Biennial	11/8/2013	9161-4075

**Table 5-1. Annual Test Equipment Calibration Schedule**

<b>FCC ID:</b> ZNFLG530G		<b>FCC Pt. 15.247 BLUETOOTH TEST REPORT (CERTIFICATION)</b>		<b>Reviewed by:</b> Quality Manager
<b>Test Report S/N:</b> 0Y1201030002.ZNF	<b>Test Dates:</b> January 5, 28, 2012	<b>EUT Type:</b> Portable Handset	Page 9 of 35	



## 6.0 TEST RESULTS

### 6.1 Summary

Company Name: LG Electronics MobileComm U.S.A., Inc.  
 FCC ID: ZNFLG530G  
 Method/System: Frequency Hopping Spread Spectrum (FHSS)  
 Number of Channels: 79

FCC Part Section(s)	RSS Section(s)	Test Description	Test Limit	Test Condition	Test Result	Reference
<b>TRANSMITTER MODE (Tx)</b>						
15.247(a)(1)(iii)	RSS-210 [A8.1]	20dB Bandwidth	< 1 MHz only if using less than 15 non-overlapping channels	CONDUCTED	PASS	Section 6.2
15.247(b)(1)	RSS-210 [A8.4(2)]	Peak Transmitter Output Power	< 1 Watt if $\geq 75$ non-overlapping channels used		PASS	Section 6.3
15.247(a)(1)	RSS-210 [A8.1(2)]	Channel Separation	> 2/3 of 20 dB BW for systems with Output Power < 125mW		PASS	Section 6.5
15.247(a)(1)(iii)	RSS-210 [A8.1(4)]	Number of Channels	> 15 Channels		PASS	Section 6.7
15.247(a)(1)(iii)	RSS-210 [A8.1(4)]	Time of Occupancy	< 0.4 sec in 31.6 sec period		PASS	Section 6.6
15.247(d)	RSS-210 [A8.5]	Band Edge / Out-of-Band Emissions	Conducted < 20dBc		PASS	Section 6.4, Section 6.8
15.205 15.209	RSS-210 [A8.5]	General Field Strength Limits (Restricted Bands and Radiated Emission Limits)	Emissions in restricted bands must meet the radiated limits detailed in 15.209 (RSS-210 table 3 limits)	RADIATED	PASS	Section 6.9, Section 6.10
15.207	RSS-Gen [7.2.2]	AC Conducted Emissions 150kHz – 30MHz	< FCC 15.207 limits or < RSS-Gen table 2 limits	LINE CONDUCTED	PASS	Section 6.11
<b>RECEIVER MODE (Rx) / DIGITAL DEVICE</b>						
15.107	RSS-Gen [7.2.2]	AC Conducted Emissions 150kHz – 30MHz	< FCC 15.107 limits or < RSS-Gen table 2 limits	LINE CONDUCTED	PASS	Part 15B Test Report
15.109	RSS-Gen [7.2.3.2]	General Field Strength Limits (Restricted Bands and Radiated Emissions Limits)	< FCC 15.109 limits or < RSS-Gen limits [Section 6; Table1]	RADIATED (30MHz-1GHz) (1-25 GHz)	PASS	Part 15B Test Report

**Table 6-1. Summary of Test Results**

FCC ID: ZNFLG530G	 <b>FCC Pt. 15.247 BLUETOOTH TEST REPORT (CERTIFICATION)</b>			Reviewed by: Quality Manager
Test Report S/N: 0Y1201030002.ZNF	Test Dates: January 5, 28, 2012	EUT Type: Portable Handset	Page 10 of 35	

## 6.2 20dB Bandwidth Measurement

**§15.247 (a)(1)(iii); RSS-210 (A8.1)**



The bandwidth at 20dB down from the highest in-band spectral density is measured with a spectrum analyzer connected to the receive antenna while the EUT is operating in transmission mode at the appropriate frequencies. **The maximum permissible 20dB bandwidth is 1 MHz, unless more than 15 non-overlapping channels are employed.**

Frequency [MHz]	Data Rate [Mbps]	Channel No.	20dB Bandwidth Test Results	
			[kHz]	Pass/Fail
2402	1.0	0	956	Pass
2441	1.0	39	954	Pass
2480	1.0	78	956	Pass
2402	2.0	0	1268	Pass
2441	2.0	39	1266	Pass
2480	2.0	78	1272	Pass
2402	3.0	0	1256	Pass
2441	3.0	39	1254	Pass
2480	3.0	78	1260	Pass

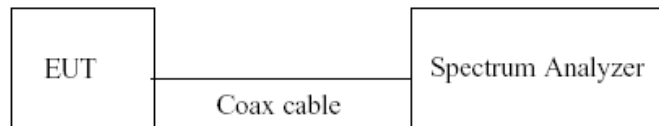
**Table 6-2. Conducted 20dB Bandwidth Measurements**



**Figure 6-1. Test Instrument & Measurement Setup**

FCC ID: ZNFLG530G	 FCC Pt. 15.247 BLUETOOTH TEST REPORT (CERTIFICATION)			Reviewed by: Quality Manager
Test Report S/N: 0Y1201030002.ZNF	Test Dates: January 5, 28, 2012	EUT Type: Portable Handset	Page 11 of 35	





Plot 6-3. 20dB Bandwidth Plot (Bluetooth, 1Mbps – Ch. 78)

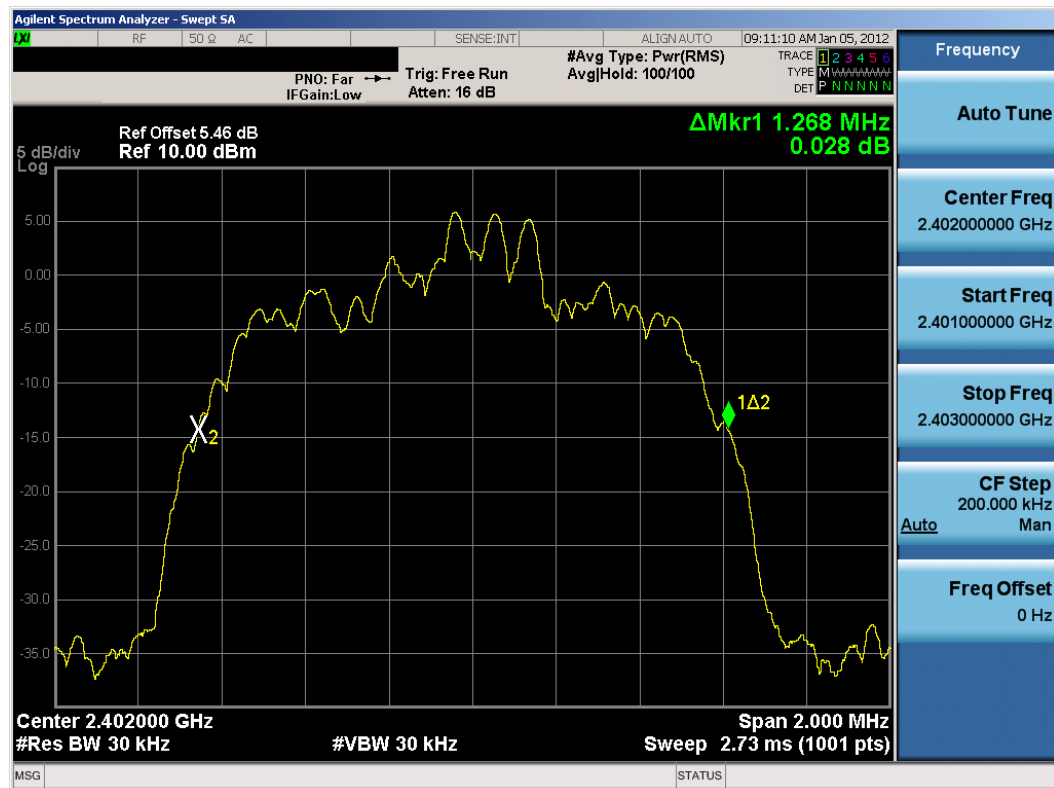

Plot 6-4. 20dB Bandwidth Plot (Bluetooth, 2Mbps – Ch. 0)

FCC ID: ZNFLG530G		FCC Pt. 15.247 BLUETOOTH TEST REPORT (CERTIFICATION)		Reviewed by: Quality Manager
Test Report S/N: 0Y1201030002.ZNF	Test Dates: January 5, 28, 2012	EUT Type: Portable Handset		Page 13 of 35



Plot 6-5. 20dB Bandwidth Plot (Bluetooth, 2Mbps – Ch. 39)

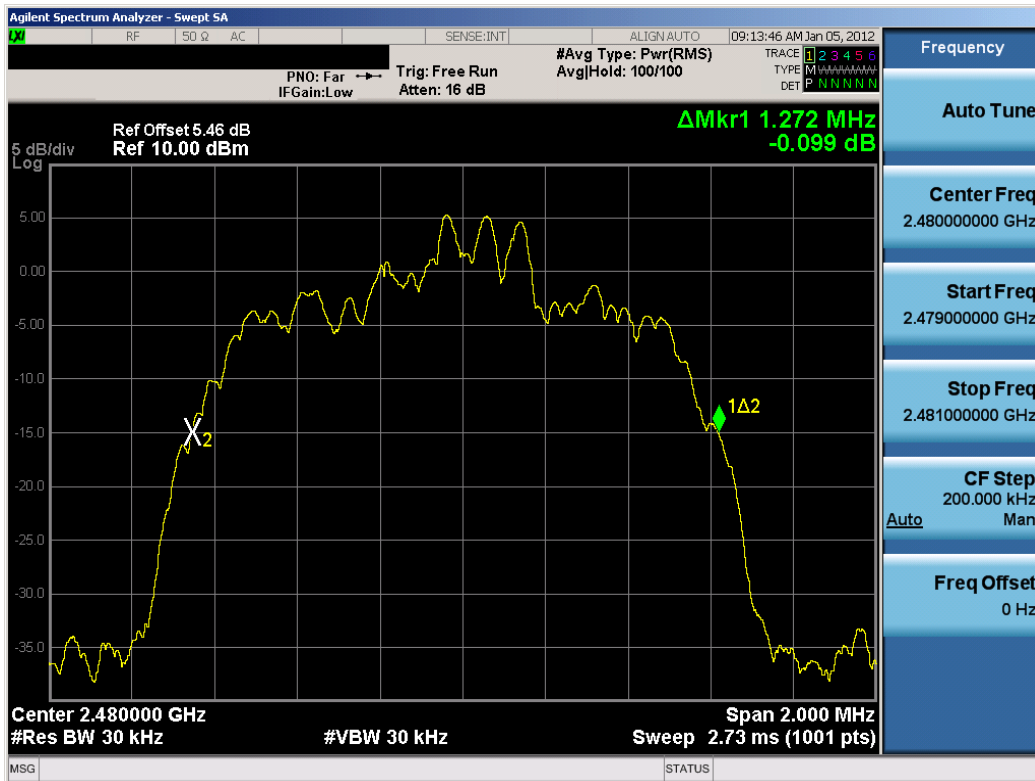

Plot 6-6. 20dB Bandwidth Plot (Bluetooth, 2Mbps – Ch. 78)

FCC ID: ZNFLG530G		FCC Pt. 15.247 BLUETOOTH TEST REPORT (CERTIFICATION)		Reviewed by: Quality Manager
Test Report S/N: 0Y1201030002.ZNF	Test Dates: January 5, 28, 2012	EUT Type: Portable Handset		Page 14 of 35

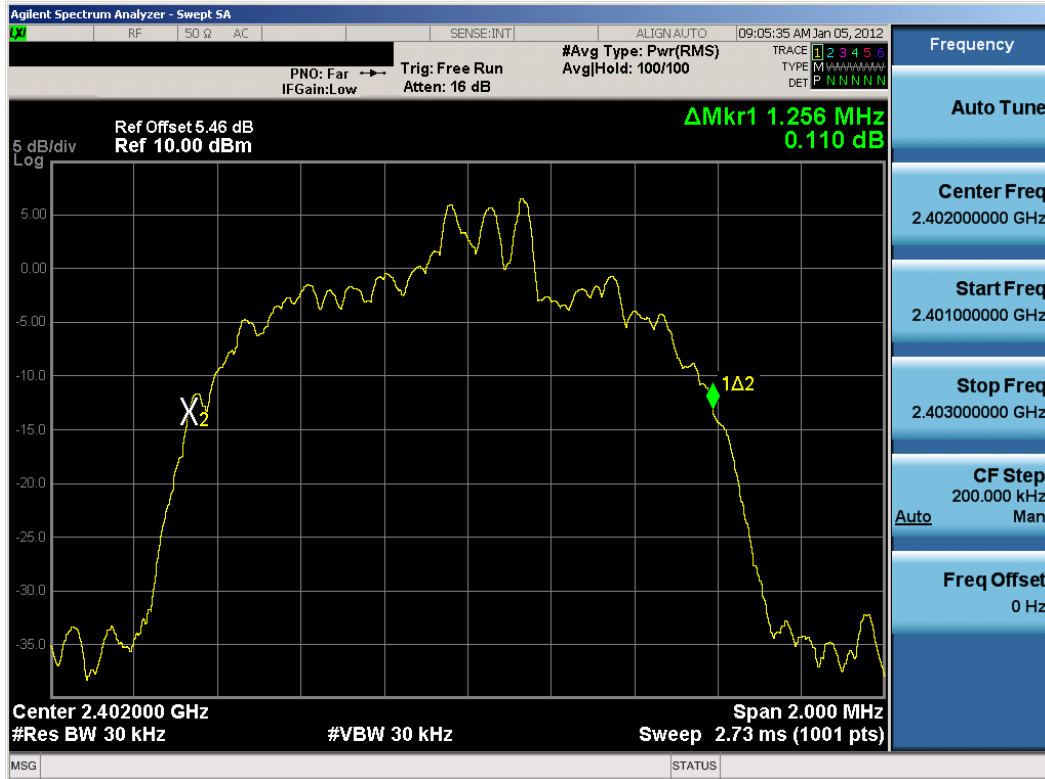

Plot 6-7. 20dB Bandwidth Plot (Bluetooth, 3Mbps – Ch. 0)

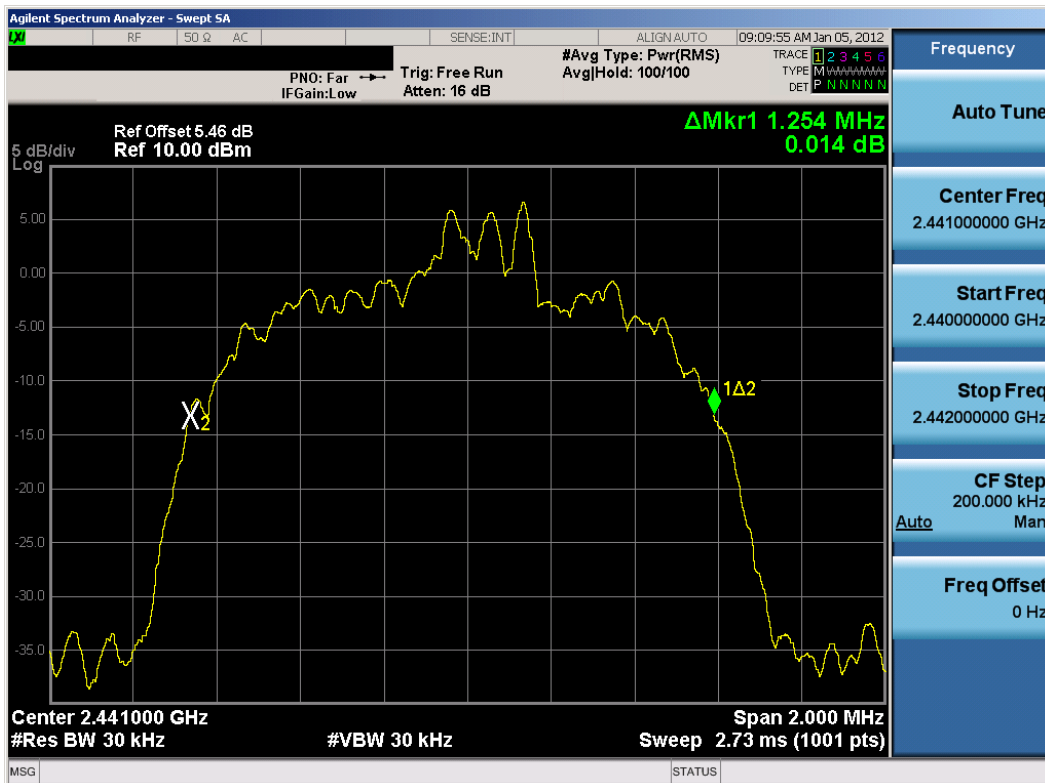

Plot 6-8. 20dB Bandwidth Plot (Bluetooth, 3Mbps – Ch. 39)

FCC ID: ZNFLG530G		FCC Pt. 15.247 BLUETOOTH TEST REPORT (CERTIFICATION)		Reviewed by: Quality Manager
Test Report S/N: 0Y1201030002.ZNF	Test Dates: January 5, 28, 2012	EUT Type: Portable Handset		Page 15 of 35

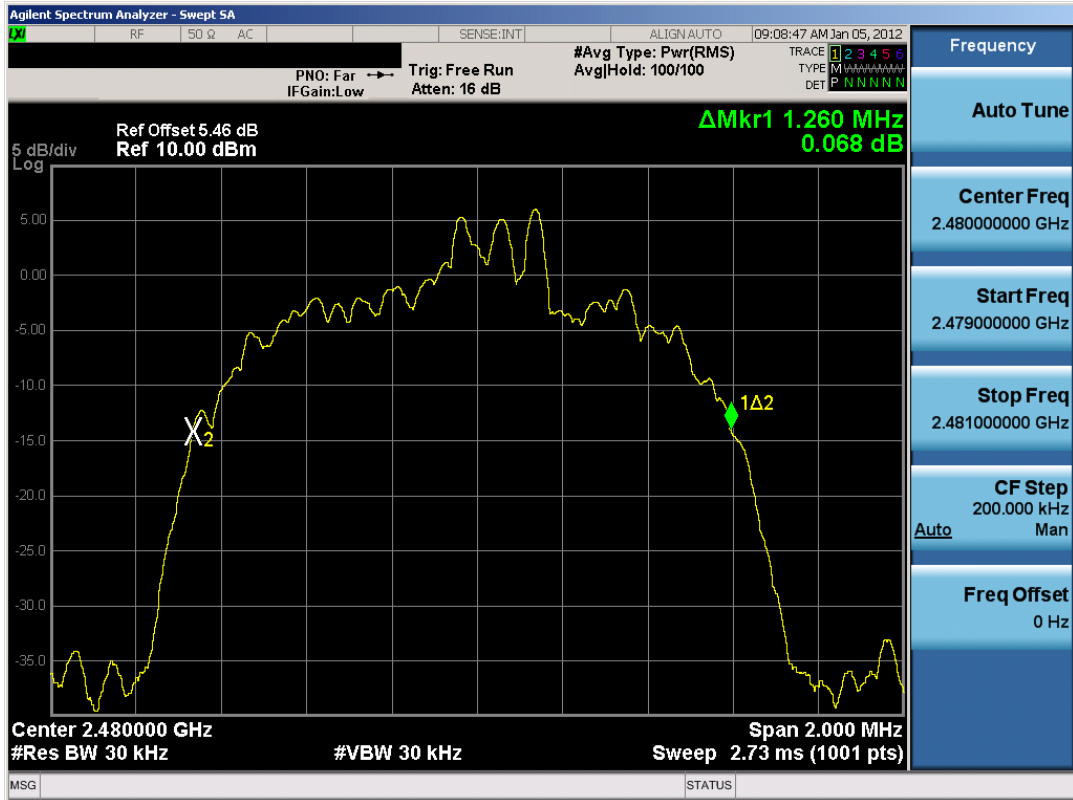

Plot 6-9. 20dB Bandwidth Plot (Bluetooth, 3Mbps – Ch. 78)

FCC ID: ZNFLG530G		FCC Pt. 15.247 BLUETOOTH TEST REPORT (CERTIFICATION)		Reviewed by: Quality Manager
Test Report S/N: 0Y1201030002.ZNF	Test Dates: January 5, 28, 2012	EUT Type: Portable Handset		Page 16 of 35



### 6.3 Output Power Measurement

**§15.247 (b)(1); RSS-210 (A8.4 (2))**

Measurement is made while the EUT is operating in non-hopping transmission mode. The powers shown below are peak powers measured using a Bluetooth signaling test set (Agilent Model: N4010A) and a spectrum analyzer set to peak detector with RBW = VBW = 3MHz. **The maximum permissible output power is 1 Watt.**

This unit was tested with all possible data rates and the highest power is reported with the unit transmitting at 3Mbps.

Frequency [MHz]	Data Rate [Mbps]	Channel No.	Peak Conducted Power	
			[dBm]	[mW]
2402	1.0	0	8.36	6.855
2441	1.0	39	8.34	6.823
2480	1.0	78	7.78	5.998
2402	2.0	0	8.76	7.516
2441	2.0	39	8.77	7.534
2480	2.0	78	8.12	6.486
2402	3.0	0	9.07	8.072
2441	3.0	39	9.08	8.091
2480	3.0	78	8.55	7.161

**Table 6-3. Conducted Output Power Measurements**

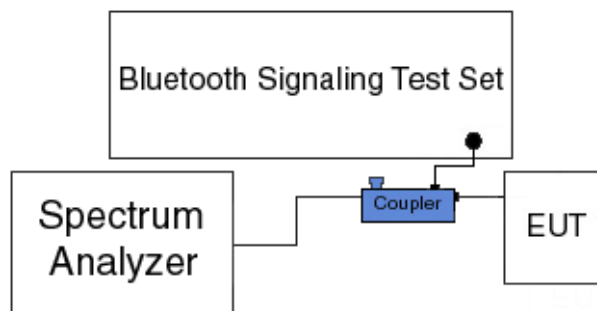



**Figure 6-2. Test Instrument & Measurement Setup**

**Note**

Final results were obtained using calibrated couplers, attenuators and cables. The following formula was used:

$$\text{Output Power (dBm)} = \text{Raw Analyzer Level (dBm)} + \text{Cable Loss (dB)} + \text{Loss in Directional Coupler/Insertion Loss (dB)}$$

FCC ID: ZNFLG530G		FCC Pt. 15.247 BLUETOOTH TEST REPORT (CERTIFICATION)		Reviewed by: Quality Manager
Test Report S/N: 0Y1201030002.ZNF	Test Dates: January 5, 28, 2012	EUT Type: Portable Handset	Page 17 of 35	

## 6.4 Band Edge Compliance

### §15.247 (d); RSS-210 (A8.5)

Measurement is taken at the highest point located outside of the emission bandwidth. **The maximum permissible emission level is 20 dBc. Any emission lying outside of the emission bandwidth and in a restricted band is subject to a field strength limit specified in Section 15.209 of the Title 47 CFR.**

Out of band conducted spurious emissions at the band edge were investigated for all data rates and the worst case emissions were found with the EUT transmitting at 3Mbps. Band edge emissions were also investigated with the EUT transmitting in all data rates and with hopping enabled/disabled. Plots of the worst case emissions are shown below.

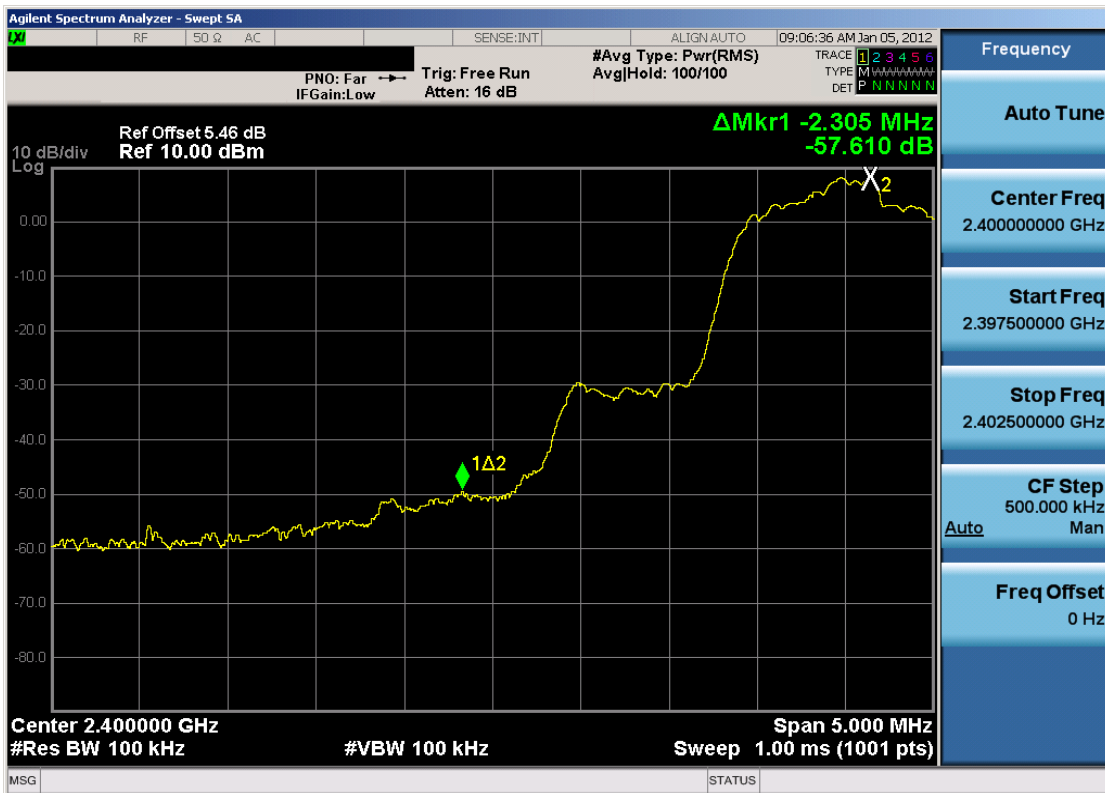

Plot 6-10. Band Edge Plot (Bluetooth with Hopping Disabled, 3Mbps – Ch. 0)

FCC ID: ZNFLG530G		FCC Pt. 15.247 BLUETOOTH TEST REPORT (CERTIFICATION)		Reviewed by: Quality Manager
Test Report S/N: 0Y1201030002.ZNF	Test Dates: January 5, 28, 2012	EUT Type: Portable Handset		Page 18 of 35

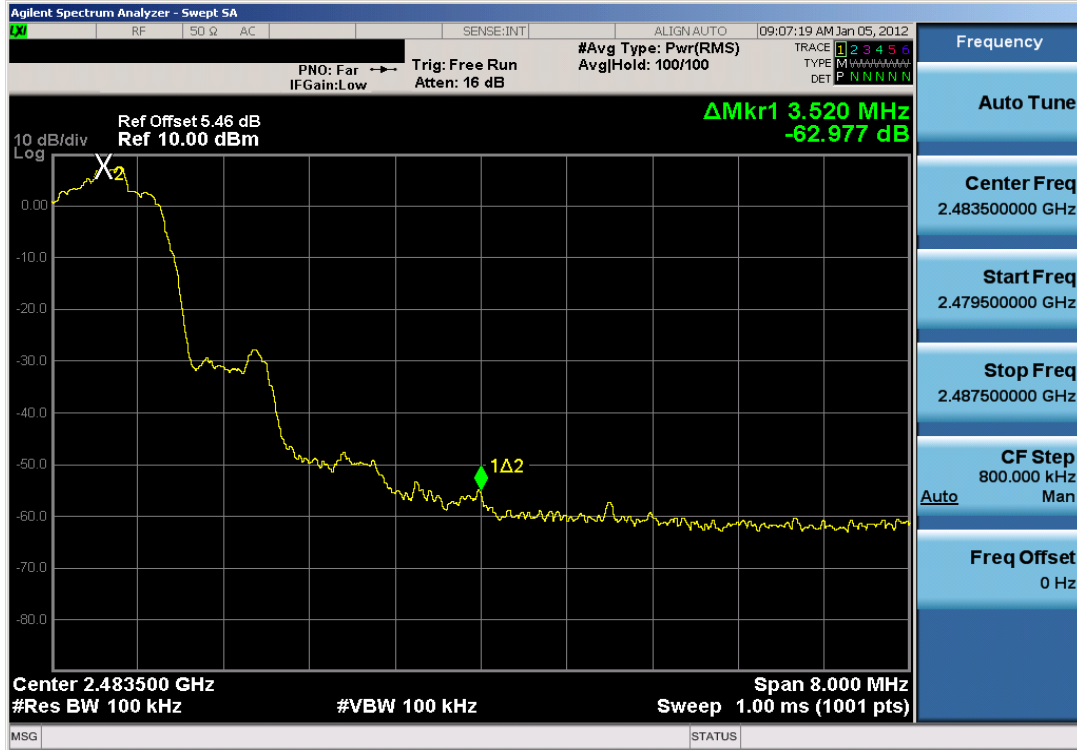

Plot 6-11. Band Edge Plot (Bluetooth with Hopping Disabled, 3Mbps – Ch. 78)



Plot 6-12. Band Edge Plot (Bluetooth with Hopping Enabled, 3Mbps – Ch. 0)

FCC ID: ZNFLG530G		FCC Pt. 15.247 BLUETOOTH TEST REPORT (CERTIFICATION)		Reviewed by: Quality Manager
Test Report S/N: 0Y1201030002.ZNF	Test Dates: January 5, 28, 2012	EUT Type: Portable Handset		Page 19 of 35

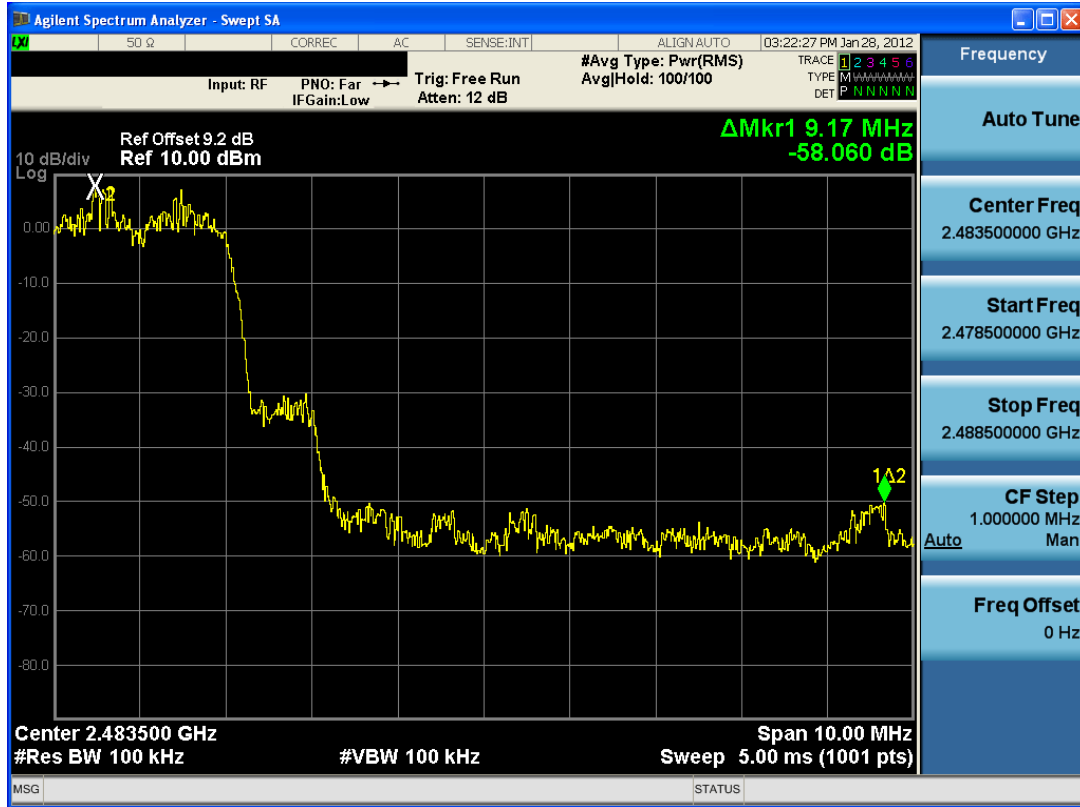

Plot 6-13. Band Edge Plot (Bluetooth with Hopping Enabled, 3Mbps – Ch. 78)

FCC ID: ZNFLG530G		FCC Pt. 15.247 BLUETOOTH TEST REPORT (CERTIFICATION)		Reviewed by: Quality Manager
Test Report S/N: 0Y1201030002.ZNF	Test Dates: January 5, 28, 2012	EUT Type: Portable Handset		Page 20 of 35

## 6.5 Carrier Frequency Separation

§15.247 (a)(1); RSS-210 (A8.1 (2))

Measurement is made with EUT operating in hopping mode. *The minimum permissible channel separation for this system is 2/3 the value of the 20dB BW.*

Frequency [MHz]	Data Rate [Mbps]	Channel No.	Min. Channel Separation [MHz]
2402	1.0	0	0.844
2441	1.0	39	0.844
2480	1.0	78	0.845
2402	2.0	0	0.845
2441	2.0	39	0.844
2480	2.0	78	0.848
2402	3.0	0	0.837
2441	3.0	39	0.836
2480	3.0	78	0.840

Table 6-4. Minimum Channel Separation

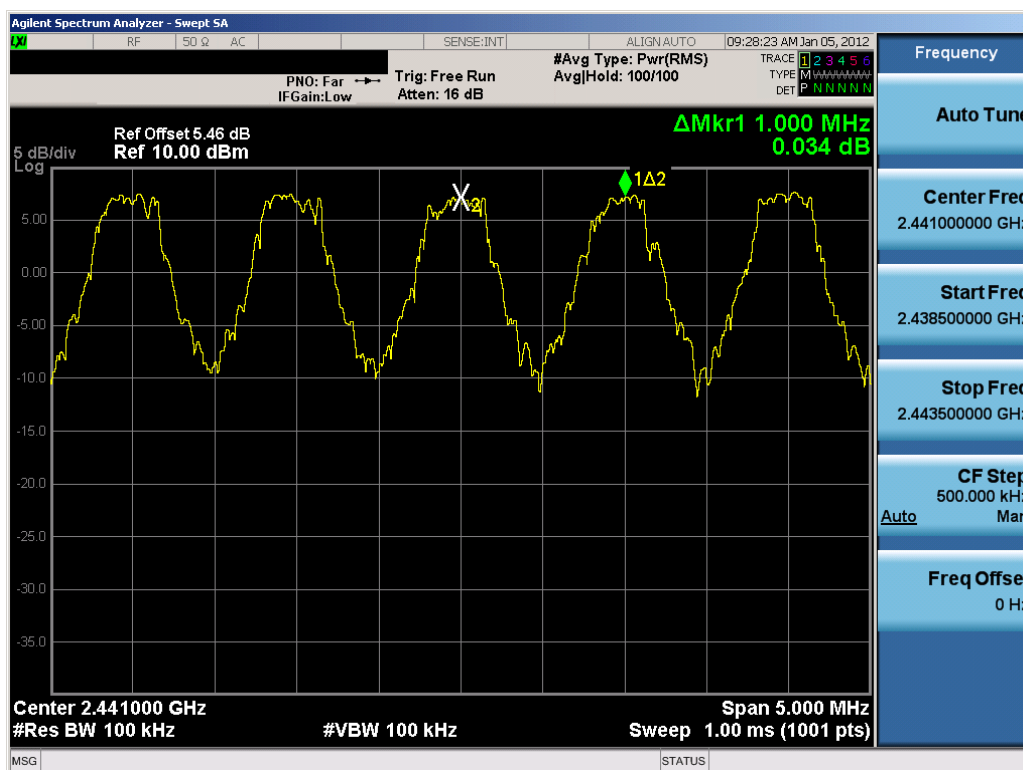

Plot 6-14. Channel Spacing Plot (Bluetooth)

FCC ID: ZNFLG530G		FCC Pt. 15.247 BLUETOOTH TEST REPORT (CERTIFICATION)		Reviewed by: Quality Manager
Test Report S/N: 0Y1201030002.ZNF	Test Dates: January 5, 28, 2012	EUT Type: Portable Handset		Page 21 of 35

## 6.6 Time of Occupancy

**§15.247 (a)(1)(iii); RSS-210 (A8.1 (4))**

Measurement is made while EUT is operating in hopping mode with the spectrum analyzer set to zero span. **The maximum permissible time of occupancy is 400 ms within a period of 400ms multiplied by the number of hopping channels employed.**

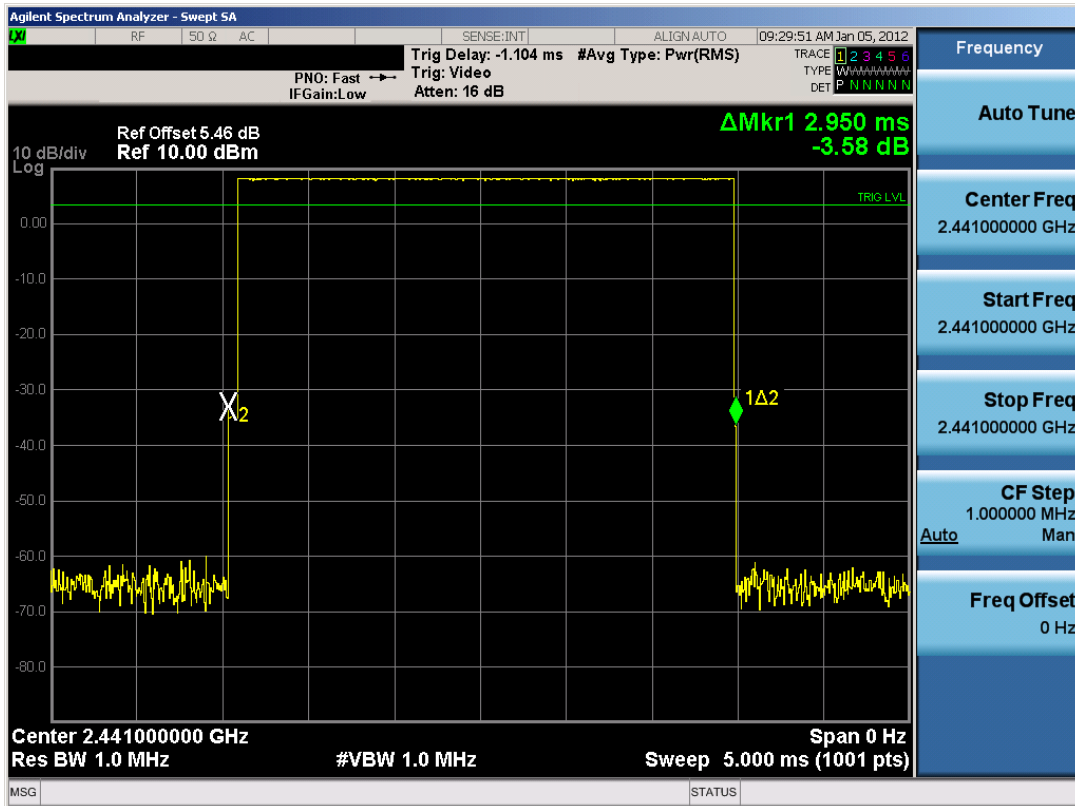

**Plot 6-15. Time of Occupancy Plot (Bluetooth)**

### Sample Calculation

Time of Occupancy for one pulse width = 2ms.

- 400ms x 79 hopping channels = 31.6sec
- 2ms x 79 hopping channels = 158ms (total duration of all channels)
- 31.6sec / 158ms = 200 (number of times one channel transmits within a 31.6sec time frame)
- 200 x 2ms = 400ms (total duration of time that one channel transmits within a 31.6sec time frame)

FCC ID: ZNFLG530G		FCC Pt. 15.247 BLUETOOTH TEST REPORT (CERTIFICATION)		Reviewed by: Quality Manager
Test Report S/N: 0Y1201030002.ZNF	Test Dates: January 5, 28, 2012	EUT Type: Portable Handset		Page 22 of 35

## 6.7 Number of Hopping Channels §15.247 (a)(1)(iii); RSS-210 (A8.1 (4))

Measurement is made while EUT is operating in hopping mode. *This frequency hopping system must employ a minimum of 15 hopping channels.*

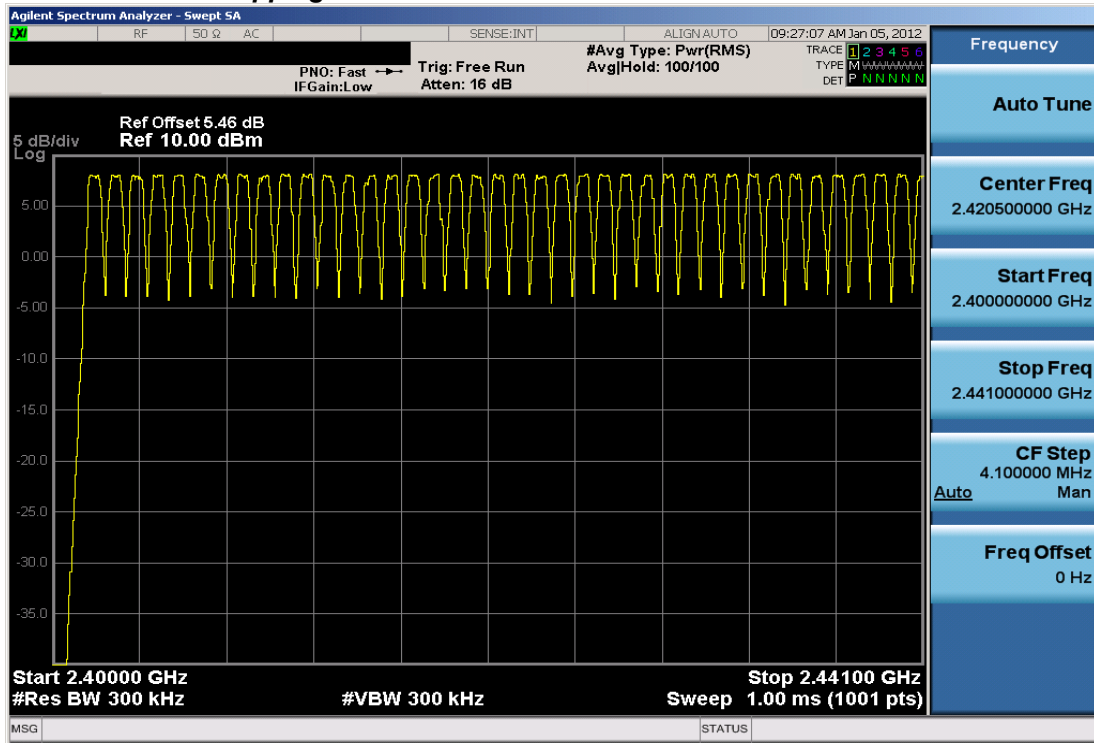

Plot 6-16. Low End Spectrum Channel Hopping Plot (Bluetooth)

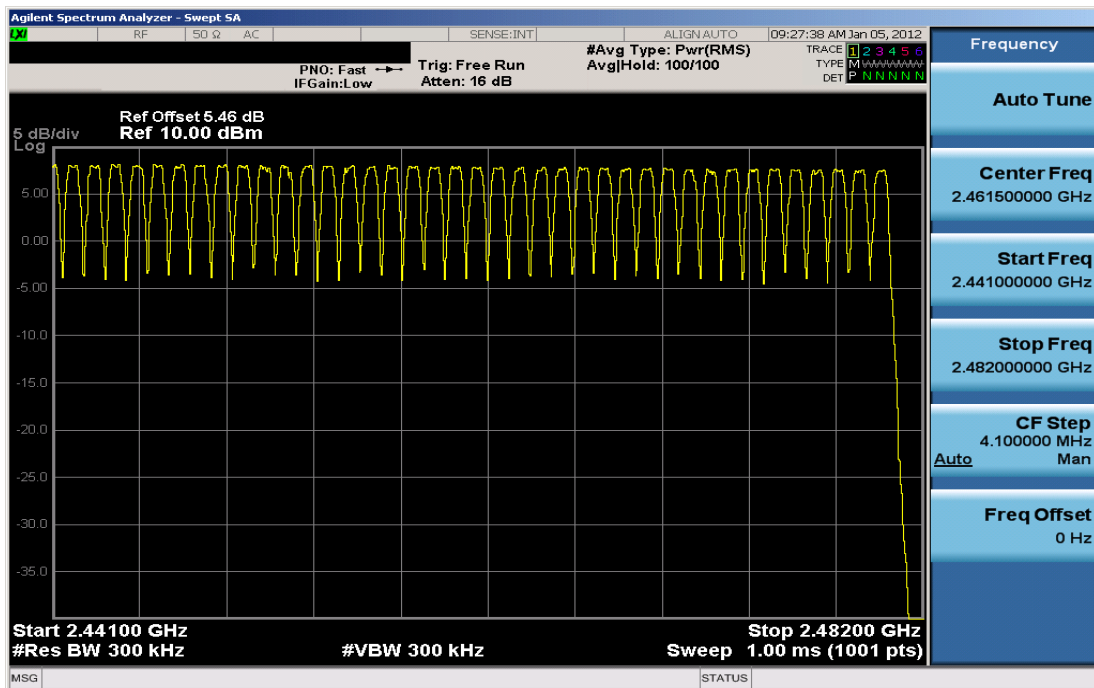

Plot 6-17. High End Spectrum Channel Hopping Plot (Bluetooth)

FCC ID: ZNFLG530G		FCC Pt. 15.247 BLUETOOTH TEST REPORT (CERTIFICATION)		Reviewed by: Quality Manager
Test Report S/N: 0Y1201030002.ZNF	Test Dates: January 5, 28, 2012	EUT Type: Portable Handset		Page 23 of 35

## 6.8 Conducted Spurious Emissions

### §15.247 (d)

Out of band conducted spurious emissions were investigated for all data rates and the worst case emissions were found with the EUT transmitting at 3Mbps. Plots of the worst case emissions are shown below.

The display line shown in the following plots denotes the limit at 20dB below the fundamental emission level measured in a 100kHz bandwidth. However, since the traces in the following plots are measured with a 1MHz RBW, the display line may not necessarily appear to be 20dB below the level of the fundamental in a 1MHz bandwidth.

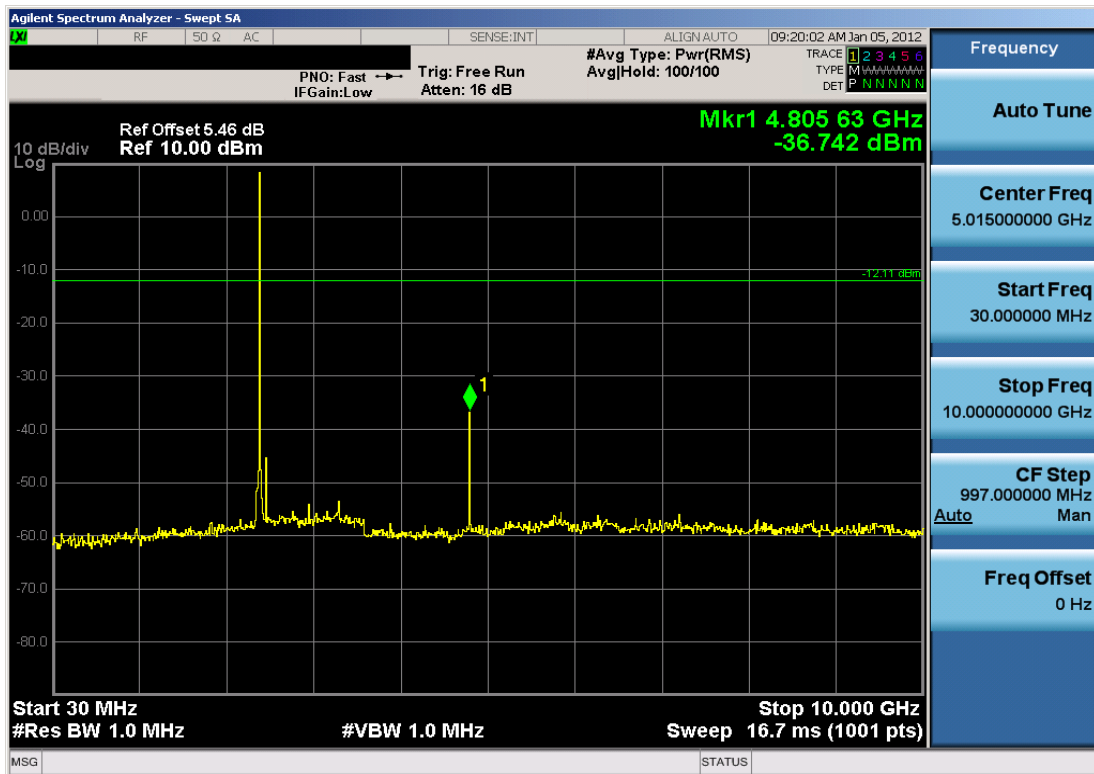

Plot 6-18. Conducted Spurious Plot (Bluetooth, 3Mbps – Ch. 0)

FCC ID: ZNFLG530G		FCC Pt. 15.247 BLUETOOTH TEST REPORT (CERTIFICATION)		Reviewed by: Quality Manager
Test Report S/N: 0Y1201030002.ZNF	Test Dates: January 5, 28, 2012	EUT Type: Portable Handset		Page 24 of 35





Plot 6-19. Conducted Spurious Plot (Bluetooth, 3Mbps – Ch. 0)

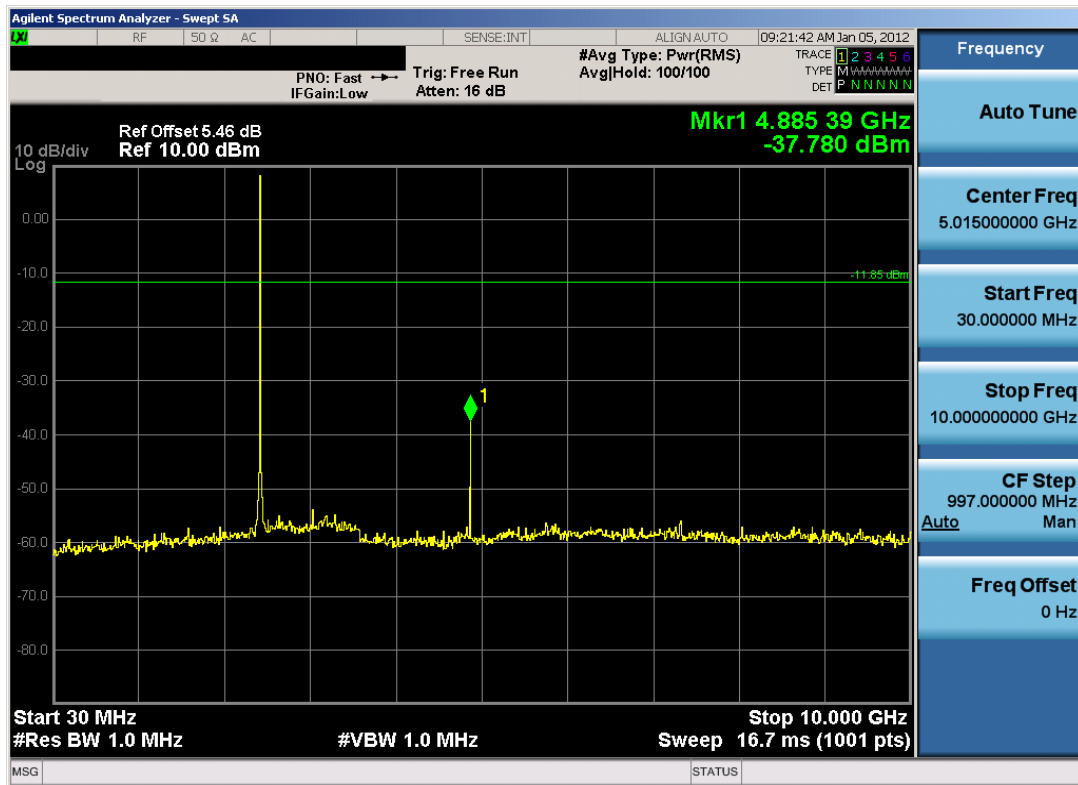

Plot 6-20. Conducted Spurious Plot (Bluetooth, 3Mbps – Ch. 39)

FCC ID: ZNFLG530G		FCC Pt. 15.247 BLUETOOTH TEST REPORT (CERTIFICATION)		Reviewed by: Quality Manager
Test Report S/N: 0Y1201030002.ZNF	Test Dates: January 5, 28, 2012	EUT Type: Portable Handset		Page 25 of 35



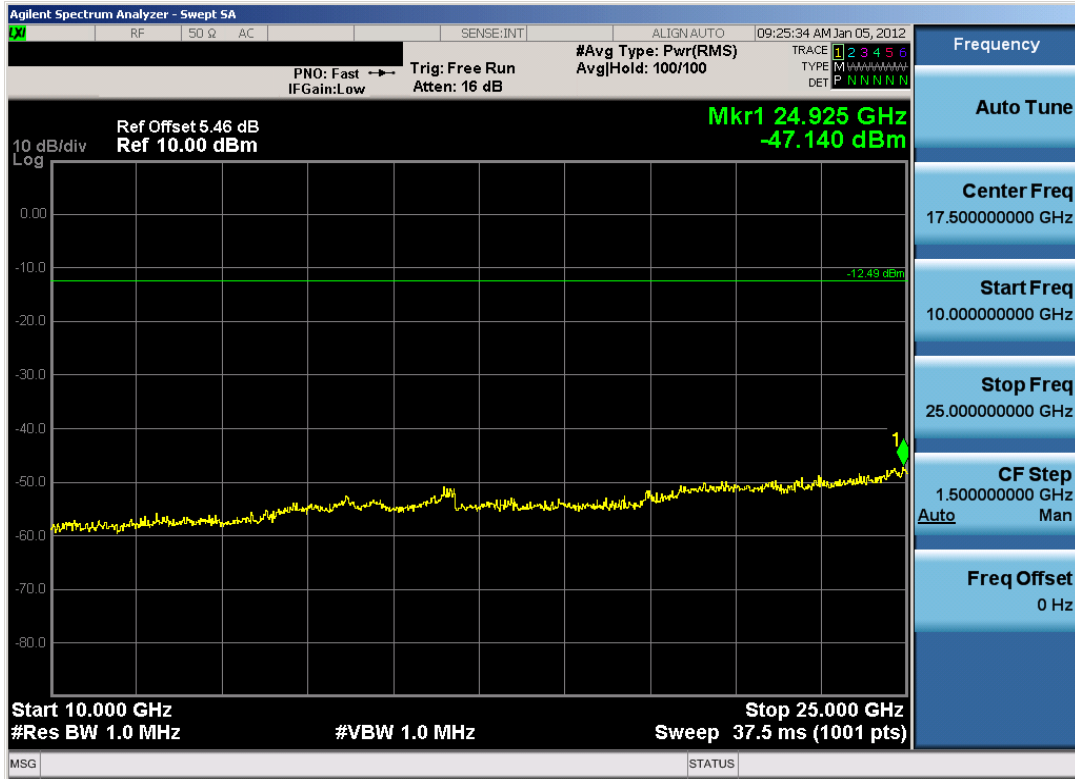

Plot 6-23. Conducted Spurious Plot (Bluetooth, 3Mbps – Ch. 78)

FCC ID: ZNFLG530G		FCC Pt. 15.247 BLUETOOTH TEST REPORT (CERTIFICATION)		Reviewed by: Quality Manager
Test Report S/N: 0Y1201030002.ZNF	Test Dates: January 5, 28, 2012	EUT Type: Portable Handset		Page 27 of 35

## 6.9 Radiated Spurious Emission Measurements

**§15.205 & §15.209, §15.247 (d); RSS-210 (A8.5)**

The EUT was tested from 9kHz and up to the 10<sup>th</sup> harmonic of the fundamental frequency of the transmitter using CISPR quasi peak detector below 1GHz. Above 1 GHz, average measurement was used, using RBW = 1MHz, VBW = 1kHz  $\geq 1/\tau$  Hz, where  $\tau$  is the Bluetooth pulse width in seconds, and linearly polarized horn antennas. All out of band emissions appearing in a restricted band as specified in Section 15.205 of the Title 47 CFR must not exceed the limits shown in Table 6-5 per Section 15.209. This unit was tested with all possible data rates and the highest power is reported with the unit transmitting at 3Mbps. No significant radiated emissions were found in the 2310 - 2390MHz restricted band.

Frequency	Field Strength [ $\mu\text{V/m}$ ]	Measured Distance [Meters]
0.009 – 0.490 MHz	2400/F (kHz)	300
0.490 – 1.705 MHz	24000/F (kHz)	30
1.705 – 30.00 MHz	30	30
30.00 – 88.00 MHz	100	3
88.00 – 216.0 MHz	150	3
216.0 – 960.0 MHz	200	3
Above 960.0 MHz	500	3



**Table 6-5. Radiated Limits**

### Sample Calculation

- Field Strength Level  $_{[\text{dB}\mu\text{V/m}]}$  = Analyzer Level  $_{[\text{dBm}]}$  + 107 + AFCL  $_{[\text{dB}]}$  + Duty Cycle Correction  $_{[\text{dB}]}$

### Notes:

- AFCL = Antenna Factor  $_{[\text{dB}]}$  + Cable Loss  $_{[\text{dB}]}$
- Duty Cycle Correction Factor Calculation:
  - Time to cycle through all channels =  $\Delta t = \tau_{[\text{ms}]} \times 79 \text{ channels} = 233.05\text{ms}$ , where  $\tau$  = pulse width
  - $100\text{ms} / \Delta t_{[\text{ms}]} = H \rightarrow$  Round up to next highest integer, to account for worst case,  $H' = 1$
  - Worst Case Dwell Time =  $\tau_{[\text{ms}]} \times H' = 2.95\text{ms}$
  - Duty Cycle Correction =  $20\log(\text{Worst Case Dwell Time}/100\text{ms})_{[\text{dB}]} = -30.604\text{dB}$

FCC ID: ZNFLG530G		FCC Pt. 15.247 BLUETOOTH TEST REPORT (CERTIFICATION)		Reviewed by: Quality Manager
Test Report S/N: 0Y1201030002.ZNF	Test Dates: January 5, 28, 2012	EUT Type: Portable Handset		Page 28 of 35

## Radiated Spurious Emission Measurements (Cont'd)

§15.205 & §15.209, §15.247 (d); RSS-210 (A8.5)

Mode: Bluetooth

Measurement Distance: 3 Meters

Operating Frequency: 2402MHz



Channel: 0

Frequency [MHz]	Analyzer Level [dBm]	Detector	Pol [H/V]	AFCL [dB]	Duty Cycle Correction [dB]	Field Strength [dB $\mu$ V/m]	Limit [dB $\mu$ V/m]	Margin [dB]
4804.00	-106.32	Avg	H	42.09	-30.60	12.17	53.98	-41.81
4804.00	-97.80	Peak	H	42.09	0.00	51.29	73.98	-22.69
12010.00	-135.00	Avg	H	58.48	0.00	30.48	53.98	-23.50
12010.00	-125.00	Peak	H	58.48	0.00	40.48	73.98	-33.50

**Table 6-6. Radiated Measurements**

**NOTES:**

- All emissions shown lie in the restricted bands specified in §15.205 and are below the limit shown in Table 6-5.
- Average measurements > 1GHz using RBW = 1MHz and VBW = 1kHz  $\geq 1/\tau$  Hz, where  $\tau$  = pulse width in seconds. Peak measurements > 1GHz using RBW = VBW = 1MHz.
- The antenna is manipulated through typical positions, polarity and length during the tests. The EUT is manipulated through three orthogonal planes.
- The EUT is supplied with nominal AC voltage and/or a new/fully-recharged battery.
- The spectrum is measured from 9kHz to the 10<sup>th</sup> harmonic and the worst-case emissions are reported. No significant emissions were found beyond the fifth harmonic for this device.
- Levels at - 135 dBm represent the analyzer noise floor and signify that no emission was detected.
- Above 960MHz the limit is 500  $\mu$ V/m (54dB $\mu$ /m) at 3 meters radiated.

FCC ID: ZNFLG530G		FCC Pt. 15.247 BLUETOOTH TEST REPORT (CERTIFICATION)		Reviewed by: Quality Manager
Test Report S/N: 0Y1201030002.ZNF	Test Dates: January 5, 28, 2012	EUT Type: Portable Handset		Page 29 of 35

## Radiated Spurious Emission Measurements (Cont'd)

§15.205 & §15.209, §15.247 (d); RSS-210 (A8.5)

Mode: Bluetooth

Measurement Distance: 3 Meters

Operating Frequency: 2441MHz



Channel: 39

Frequency [MHz]	Analyzer Level [dBm]	Detector	Pol [H/V]	AFCL [dB]	Duty Cycle Correction [dB]	Field Strength [dB $\mu$ V/m]	Limit [dB $\mu$ V/m]	Margin [dB]
4882.00	-107.25	Avg	H	42.20	-30.60	11.35	53.98	-42.63
4882.00	-98.15	Peak	H	42.20	0.00	51.05	73.98	-22.93
7323.00	-135.00	Avg	H	48.86	0.00	20.86	53.98	-33.12
7323.00	-125.00	Peak	H	48.86	0.00	30.86	73.98	-43.12
12205.00	-135.00	Avg	H	58.73	0.00	30.73	53.98	-23.25
12205.00	-125.00	Peak	H	58.73	0.00	40.73	73.98	-33.25

**Table 6-7. Radiated Measurements**

**NOTES:**

- All emissions shown lie in the restricted bands specified in §15.205 and are below the limit shown in Table 6-5.
- Average measurements > 1GHz using RBW = 1MHz and VBW = 1kHz  $\geq 1/\tau$  Hz, where  $\tau$  = pulse width in seconds. Peak measurements > 1GHz using RBW = VBW = 1MHz.
- The antenna is manipulated through typical positions, polarity and length during the tests. The EUT is manipulated through three orthogonal planes.
- The EUT is supplied with nominal AC voltage and/or a new/fully-recharged battery.
- The spectrum is measured from 9kHz to the 10<sup>th</sup> harmonic and the worst-case emissions are reported. No significant emissions were found beyond the fifth harmonic for this device.
- Levels at - 135 dBm represent the analyzer noise floor and signify that no emission was detected.
- Above 960MHz the limit is 500  $\mu$ V/m (54dB $\mu$ /m) at 3 meters radiated.

FCC ID: ZNFLG530G		FCC Pt. 15.247 BLUETOOTH TEST REPORT (CERTIFICATION)		Reviewed by: Quality Manager
Test Report S/N: 0Y1201030002.ZNF	Test Dates: January 5, 28, 2012	EUT Type: Portable Handset		Page 30 of 35

## Radiated Spurious Emission Measurements (Cont'd)

§15.205 & §15.209, §15.247 (d); RSS-210 (A8.5)

Mode: Bluetooth

Measurement Distance: 3 Meters

Operating Frequency: 2480MHz



Channel: 78

Frequency [MHz]	Analyzer Level [dBm]	Detector	Pol [H/V]	AFCL [dB]	Duty Cycle Correction [dB]	Field Strength [dB $\mu$ V/m]	Limit [dB $\mu$ V/m]	Margin [dB]
4960.00	-107.90	Avg	H	42.38	-30.60	10.88	53.98	-43.10
4960.00	-97.52	Peak	H	42.38	0.00	51.86	73.98	-22.11
7440.00	-135.00	Avg	H	48.95	0.00	20.95	53.98	-33.03
7440.00	-125.00	Peak	H	48.95	0.00	30.95	73.98	-43.03
12400.00	-135.00	Avg	H	58.74	0.00	30.74	53.98	-23.24
12400.00	-125.00	Peak	H	58.74	0.00	40.74	73.98	-33.24

**Table 6-8. Radiated Measurements**

**NOTES:**

- All emissions shown lie in the restricted bands specified in §15.205 and are below the limit shown in Table 6-5.
- Average measurements > 1GHz using RBW = 1MHz and VBW = 1kHz  $\geq 1/\tau$  Hz, where  $\tau$  = pulse width in seconds. Peak measurements > 1GHz using RBW = VBW = 1MHz.
- The antenna is manipulated through typical positions, polarity and length during the tests. The EUT is manipulated through three orthogonal planes.
- The EUT is supplied with nominal AC voltage and/or a new/fully-recharged battery.
- The spectrum is measured from 9kHz to the 10<sup>th</sup> harmonic and the worst-case emissions are reported. No significant emissions were found beyond the fifth harmonic for this device.
- Levels at - 135 dBm represent the analyzer noise floor and signify that no emission was detected.
- Above 960MHz the limit is 500  $\mu$ V/m (54dB $\mu$ /m) at 3 meters radiated.

FCC ID: ZNFLG530G			FCC Pt. 15.247 BLUETOOTH TEST REPORT (CERTIFICATION)		Reviewed by: Quality Manager
Test Report S/N: 0Y1201030002.ZNF	Test Dates: January 5, 28, 2012	EUT Type: Portable Handset	Page 31 of 35		

## 6.10 Radiated Restricted Band Edge Measurements

§15.205 & §15.209, §15.247 (d); RSS-210 (A8.5)

Mode: Bluetooth

Measurement Distance: 3 Meters

Operating Frequency: 2480MHz



Channel: 78

Frequency [MHz]	Analyzer Level [dBm]	Detector	Pol [H/V]	AFCL [dB]	Duty Cycle Correction [dB]	Field Strength [dB $\mu$ V/m]	Limit [dB $\mu$ V/m]	Margin [dB]
2483.50	-103.03	Avg	H	36.34	-30.60	9.71	53.98	-44.27
2483.50	-90.87	Peak	H	36.34	0.00	52.47	73.98	-21.51
2485.25	-104.09	Avg	H	36.35	-30.60	8.66	53.98	-45.32
2485.25	-92.42	Peak	H	36.35	0.00	50.93	73.98	-23.05
2492.91	-97.93	Avg	H	36.38	-30.60	14.85	53.98	-39.13
2492.91	-91.56	Peak	H	36.38	0.00	51.82	73.98	-22.16

**Table 6-9. Radiated Restricted Band Edge Measurements at 3-meters**

### NOTES:

- All emissions shown lie in the restricted bands specified in §15.205 and are below the limit shown in Table 6-5.
- Average measurements > 1GHz using RBW = 1MHz and VBW = 1kHz  $\geq 1/\tau$  Hz, where  $\tau$  = pulse width in seconds. Peak measurements > 1GHz using RBW = VBW = 1MHz.
- The antenna is manipulated through typical positions, polarity and length during the tests. The EUT is manipulated through three orthogonal planes.
- The EUT is supplied with nominal AC voltage and/or a new/fully-recharged battery.
- The spectrum is measured from 9kHz to the 10<sup>th</sup> harmonic and the worst-case emissions are reported. No significant emissions were found beyond the fifth harmonic for this device.
- Levels at - 135 dBm represent the analyzer noise floor and signify that no emission was detected.
- Above 960MHz the limit is 500  $\mu$ V/m (54dB $\mu$ /m) at 3 meters radiated.

FCC ID: ZNFLG530G		FCC Pt. 15.247 BLUETOOTH TEST REPORT (CERTIFICATION)		Reviewed by: Quality Manager
Test Report S/N: 0Y1201030002.ZNF	Test Dates: January 5, 28, 2012	EUT Type: Portable Handset		Page 32 of 35



**6.11 Line-Conducted Test Data**  
**§15.207; RSS-Gen (7.2.2)**

# PCTEST Engineering Laboratory Inc.

Company : LG Electronics MobileComm  
 Model Number : LG530G  
 FCC ID Code : ZNFLG530G  
 Standard : FCC Part 15C, 15.207

Power Source : AC120V/60Hz  
 Tested Date : 01/05/2012  
 Note : Tested with Bluetooth ON

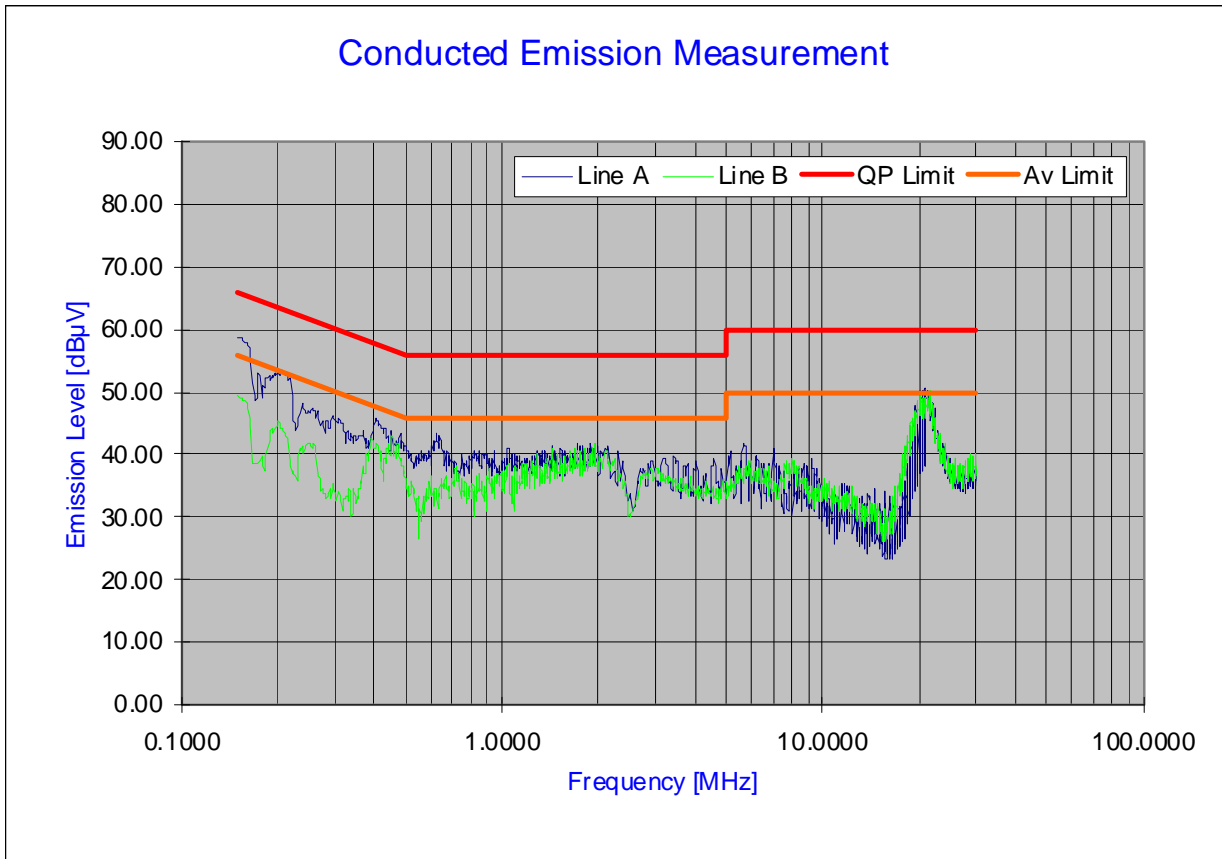

Ver.1.1 ©PCTEST 2006.08

**Plot 6-24. Line Conducted Plot with Bluetooth**

**Notes:**

1. All modes of operation were investigated and the worst-case emissions are reported with a 3Mbps data rate on channel 39.
2. The limit for Class B device(s) from 150kHz to 30MHz are specified in Section 15.207 of the Title 47 CFR.
3. Line A = Phase; Line B = Neutral
4. Traces shown in plot are made using a peak detector.
5. Deviations to the Specifications: None.

<b>FCC ID:</b> ZNFLG530G		<b>FCC Pt. 15.247 BLUETOOTH TEST REPORT (CERTIFICATION)</b>		<b>Reviewed by:</b> Quality Manager
<b>Test Report S/N:</b> 0Y1201030002.ZNF	<b>Test Dates:</b> January 5, 28, 2012	<b>EUT Type:</b> Portable Handset	Page 33 of 35	



**Line-Conducted Test Data (Cont'd)**  
**§15.207; RSS-Gen (7.2.2)**

No.	Line	Frequency [MHz]	Factor [dB]	QP [dBμV]	Limit [dBμV]	Margin [dB]	Average [dBμV]	Limit [dBμV]	Margin [dB]
1	A	0.150	6.85	54.95	66.00	-11.05	40.97	56.00	-15.03
2	A	0.157	6.85	49.97	65.64	-15.67	31.80	55.64	-23.84
3	A	0.199	6.87	47.36	63.65	-16.29	34.93	53.65	-18.72
4	A	20.052	8.48	44.36	60.00	-15.64	33.42	50.00	-16.58
5	A	20.307	8.51	44.09	60.00	-15.91	33.49	50.00	-16.51
6	A	20.681	8.56	44.72	60.00	-15.28	34.02	50.00	-15.98
7	A	20.817	8.58	44.78	60.00	-15.22	34.10	50.00	-15.90
8	A	21.202	8.63	44.66	60.00	-15.34	34.34	50.00	-15.66
9	A	21.664	8.68	43.28	60.00	-16.72	33.75	50.00	-16.25
10	A	21.734	8.69	42.96	60.00	-17.04	33.32	50.00	-16.68
11	B	0.445	6.95	38.01	56.96	-18.95	27.40	46.96	-19.56
12	B	1.433	7.10	38.00	56.00	-18.00	25.61	46.00	-20.39
13	B	1.679	7.12	37.90	56.00	-18.10	25.36	46.00	-20.64
14	B	1.928	7.14	35.91	56.00	-20.09	25.03	46.00	-20.97
15	B	1.949	7.15	37.00	56.00	-19.00	24.87	46.00	-21.13
16	B	18.869	8.47	39.21	60.00	-20.79	29.07	50.00	-20.93
17	B	20.096	8.56	43.39	60.00	-16.61	33.53	50.00	-16.47
18	B	20.580	8.64	43.64	60.00	-16.36	33.97	50.00	-16.03
19	B	20.880	8.68	43.98	60.00	-16.02	34.29	50.00	-15.71
20	B	21.409	8.75	44.26	60.00	-15.74	34.25	50.00	-15.75

**Table 6-10. Line Conducted Data with Bluetooth**



**Notes:**

1. All modes of operation were investigated and the worst-case emissions are reported with a 3Mbps data rate on channel 39.
2. The limit for Class B device(s) from 150kHz to 30MHz are specified in Section 15.207 of the Title 47 CFR.
3. Line A = Phase; Line B = Neutral
4. Traces shown in plot are made using a peak detector.
5. Deviations to the Specifications: None.

<b>FCC ID:</b> ZNFLG530G		<b>FCC Pt. 15.247 BLUETOOTH TEST REPORT (CERTIFICATION)</b>		<b>Reviewed by:</b> Quality Manager
<b>Test Report S/N:</b> 0Y1201030002.ZNF	<b>Test Dates:</b> January 5, 28, 2012	<b>EUT Type:</b> Portable Handset	Page 34 of 35	

## 7.0 CONCLUSION

The data collected relate only to the item(s) tested and show that the **LGE Portable Handset FCC ID: ZNFLG530G** is in compliance with Part 15 Subpart C (15.247) of the FCC Rules and RSS-210 of the Industry Canada Rules.

<b>FCC ID:</b> ZNFLG530G		<b>FCC Pt. 15.247 BLUETOOTH TEST REPORT (CERTIFICATION)</b>		<b>Reviewed by:</b> Quality Manager
<b>Test Report S/N:</b> 0Y1201030002.ZNF	<b>Test Dates:</b> January 5, 28, 2012	<b>EUT Type:</b> Portable Handset		Page 35 of 35