

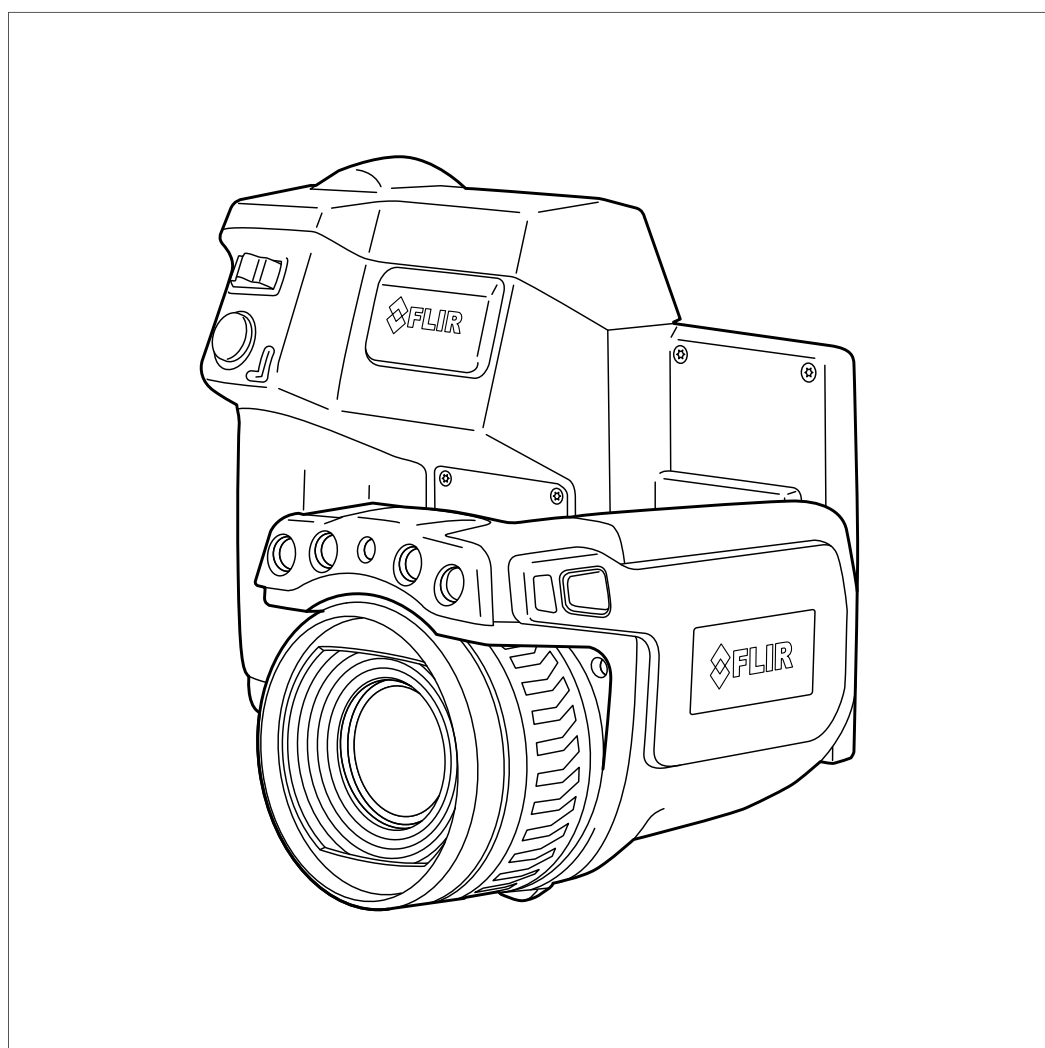

User's manual FLIR T6xx series



Important note

Before operating the device, you must read, understand, and follow all instructions, warnings, cautions, and legal disclaimers.

Důležitá poznámka

Před použitím zařízení si přečtěte veškeré pokyny, upozornění, varování a vyvázání se ze záruky, ujistěte se, že jim rozumíte, a řiďte se jimi.

Viktig meddelelse

Før du betjener enheden, skal du læse, forstå og følge alle anvisninger, advarsler, sikkerhedsforanstaltninger og ansvarsfraskrivelser.

Wichtiger Hinweis

Bevor Sie das Gerät in Betrieb nehmen, lesen, verstehen und befolgen Sie unbedingt alle Anweisungen, Warnungen, Vorsichtshinweise und Haftungsausschlüsse

Σημαντική σημείωση

Πριν από τη λειτουργία της συσκευής, πρέπει να διαβάσετε, να κατανοήσετε και να ακολουθήσετε όλες τις οδηγίες, προειδοποιήσεις, προφυλάξεις και νομικές αποποιήσεις.

Nota importante

Antes de usar el dispositivo, debe leer, comprender y seguir toda la información sobre instrucciones, advertencias, precauciones y renuncias de responsabilidad.

Tärkeä huomautus

Ennen laitteen käyttämistä on luettava ja ymmärrettävä kaikki ohjeet, vakavat varoitukset, varoitukset ja lakitiedotteet sekä noudatettava niitä.

Remarque importante

Avant d'utiliser l'appareil, vous devez lire, comprendre et suivre l'ensemble des instructions, avertissements, mises en garde et clauses légales de non-responsabilité.

Fontos megjegyzés

Az eszköz használatá elótt figyelmesen olvassa el és tartsa be az összes utasítást, figyelmeztetést, óvintézkedést és jogi nyilatkozatot.

Nota importante

Prima di utilizzare il dispositivo, è importante leggere, capire e seguire tutte le istruzioni, avvertenze, precauzioni ed esclusioni di responsabilità legali.

重要な注意

デバイスをご使用になる前に、あらゆる指示、警告、注意事項、および免責条項をお読み頂き、その内容を理解して従ってください。

중요한 참고 사항

장치를 작동하기 전에 반드시 다음의 사용 설명서와 경고, 주의사항, 법적 책임제한을 읽고 이해하며 따라야 합니다.

Viktig

Før du bruker enheten, må du lese, forstå og følge instruksjoner, advarsler og informasjon om ansvarsfraskrivelse.

Belangrijke opmerking

Zorg ervoor dat u, voordat u het apparaat gaat gebruiken, alle instructies, waarschuwingen en juridische informatie hebt doorgelezen en begrepen, en dat u deze opvolgt en in acht neemt.

Ważna uwaga

Przed rozpoczęciem korzystania z urządzenia należy koniecznie zapoznać się z wszystkimi instrukcjami, ostrzeżeniami, przestrożami i uwagami prawnymi. Należy zawsze postępować zgodnie z zaleceniami tam zawartymi.

Nota importante

Antes de utilizar o dispositivo, deverá proceder à leitura e compreensão de todos os avisos, precauções, instruções e isenções de responsabilidade legal e assegurar-se do seu cumprimento.

Важное примечание

До того, как пользоваться устройством, вам необходимо прочитать и понять все предупреждения, предостережения и юридические ограничения ответственности и следовать им.

Viktig information

Innan du använder enheten måste du läsa, förstå och följa alla anvisningar, varningar, försiktighetsåtgärder och ansvarsfriskrivningar.

Önemli not

Cihazı çalıştırmadan önce tüm talimatları, uyarıları, ikazları ve yasal açıklamaları okumalı, anlamalı ve bunlara uymalısınız.

重要注意事項

在操作设备之前，您必须阅读、理解并遵循所有说明、警告、注意事项和法律免责声明。

重要注意事項

操作裝置之前，您務必閱讀、了解並遵循所有說明、警告、注意事項與法律免責聲明。



User's manual FLIR T6xx series



Table of contents

1	Disclaimers	1
1.1	Legal disclaimer	1
1.2	Usage statistics	1
1.3	Changes to registry	1
1.4	U.S. Government Regulations	1
1.5	Copyright	1
1.6	Quality assurance	1
1.7	Patents	1
1.8	EULA Terms	1
1.9	EULA Terms	1
2	Safety information	2
3	Notice to user	6
3.1	User-to-user forums	6
3.2	Calibration	6
3.3	Accuracy	6
3.4	Disposal of electronic waste	6
3.5	Training	6
3.6	Documentation updates	6
3.7	Important note about this manual	7
3.8	Note about authoritative versions	7
4	Customer help	8
4.1	General	8
4.2	Submitting a question	8
4.3	Downloads	8
5	Quick start guide	10
5.1	Procedure	10
6	List of accessories and services	11
7	A note about ergonomics	13
7.1	General	13
7.2	Figure	13
8	Camera parts	14
8.1	View from the right	14
8.1.1	Figure	14
8.1.2	Explanation	14
8.2	View from the left	15
8.2.1	Figure	15
8.2.2	Explanation	15
8.3	View from the rear	16
8.3.1	Figure	16
8.3.2	Explanation	16
8.4	View from the bottom	17
8.4.1	Figure	17
8.4.2	Explanation	17
8.5	Battery condition LED indicator	18
8.5.1	Figure	18
8.5.2	Explanation	18
8.6	Power LED indicator	18
8.6.1	Figure	18
8.6.2	Explanation	18
8.7	Laser pointer	19
8.7.1	Figure	19
8.7.2	Laser warning label	19
8.7.3	Laser rules and regulations	19

Table of contents

9	Screen elements	20
9.1	Figure	20
9.2	Explanation	20
10	Navigating the menu system	21
10.1	Figure	21
10.2	Explanation	21
11	Pairing Bluetooth devices	22
11.1	General	22
11.2	Procedure	22
12	Configuring Wi-Fi	23
12.1	General	23
12.2	Setting up a peer-to-peer connection (most common use)	23
12.3	Connecting the camera to a wireless local area network (less common use)	23
13	Handling the camera	24
13.1	Charging the battery	24
13.1.1	Using the power supply to charge the battery	24
13.1.2	Using the stand-alone battery charger to charge the battery	24
13.2	Turning on the camera	24
13.2.1	Procedure	24
13.3	Turning off the camera	24
13.3.1	Procedure	24
13.4	Adjusting the viewfinder's dioptic correction	25
13.4.1	Figure	25
13.4.2	Procedure	25
13.5	Adjusting the angle of the lens	26
13.5.1	Figure	26
13.6	Adjusting the infrared camera focus manually	26
13.6.1	Figure	26
13.6.2	Procedure	26
13.7	Autofocusing the infrared camera	27
13.7.1	Figure	27
13.7.2	Procedure	27
13.8	Continuous autofocus	27
13.8.1	General	27
13.8.2	Procedure	27
13.9	Operating the laser pointer	28
13.9.1	Figure	28
13.9.2	Procedure	28
13.10	Using the digital zoom function	29
13.10.1	Figure	29
13.10.2	Procedure	29
13.11	Changing lenses	29
13.12	Calibrating the compass	31
13.12.1	Procedure	31
13.13	Changing the viewfinder eyecup	31
13.14	Using the camera lamp as a flash	33
13.14.1	General	33
13.14.2	Procedure	33
14	Working with images	34
14.1	Saving an image	34
14.1.1	General	34
14.1.2	About UltraMax	34
14.1.3	Image capacity	34

Table of contents

14.1.4	Naming convention.....	34
14.1.5	Procedure	34
14.2	Previewing an image	35
14.2.1	General.....	35
14.2.2	Procedure	35
14.3	Opening a saved image.....	35
14.3.1	General.....	35
14.3.2	Procedure	35
14.4	Editing a saved image.....	35
14.4.1	General.....	35
14.4.2	Procedure	36
14.5	Adjusting an infrared image.....	36
14.5.1	General.....	36
14.5.2	Example 1	36
14.5.3	Example 2	37
14.5.4	Procedure	37
14.6	Performing a non-uniformity correction (NUC)	37
14.6.1	What is a non-uniformity correction?.....	37
14.6.2	When to perform a non-uniformity correction?	37
14.6.3	Procedure	37
14.7	Changing the temperature range	38
14.7.1	General.....	38
14.7.2	Procedure	38
14.8	Hiding overlay graphics (programmable button).....	38
14.8.1	General.....	38
14.8.2	Procedure	38
14.9	Changing the color palette	39
14.9.1	General.....	39
14.9.2	Procedure	39
14.10	Deleting an image.....	39
14.10.1	General.....	39
14.10.2	Procedure	39
14.11	Deleting all images.....	39
14.11.1	General.....	39
14.11.2	Procedure	39
14.12	Creating a PDF report in the camera	40
14.12.1	General.....	40
14.12.2	Naming convention.....	40
14.12.3	Procedure	40
15	Working with image modes.....	41
15.1	General	41
15.2	Image examples	41
15.3	Selecting the image mode	42
16	Working with measurement tools	43
16.1	General	43
16.2	Adding/removing measurement tools	43
16.3	Working with user presets.....	43
16.3.1	General.....	43
16.3.2	Procedure	43
16.4	Resizing or moving a measurement tool.....	44
16.4.1	General.....	44
16.4.2	Procedure	44
16.5	Changing object parameters	45
16.5.1	General.....	45
16.5.2	Types of parameters	45

Table of contents

16.5.3	Recommended values.....	45
16.5.4	Procedure	45
16.5.5	Related topics	46
16.6	Displaying values in the result table and displaying a graph	47
16.6.1	General.....	47
16.6.2	Procedure	47
16.7	Creating and setting up a difference calculation	47
16.7.1	General.....	47
16.7.2	Procedure	47
16.8	Setting a measurement alarm	48
16.8.1	General.....	48
16.8.2	Types of alarm	48
16.8.3	Alarm signals	48
16.8.4	Procedure	48
17	Fetching data from external FLIR meters	51
17.1	General	51
17.2	Supported FLIR meters.....	51
17.3	Technical support for external meters	51
17.4	Typical moisture measurement and documentation procedure	51
17.4.1	General.....	51
17.4.2	Procedure	52
17.5	More information	52
18	Working with color alarms and isotherms.....	53
18.1	Color alarms	53
18.1.1	General.....	53
18.1.2	Image examples	53
18.2	Setting up above, below, and interval alarms.....	54
18.3	Building isotherms	55
18.3.1	About the <i>Condensation alarm</i>	55
18.3.2	About the <i>Insulation alarm</i>	55
18.3.3	Setting up condensation and insulation alarms	55
19	Annotating images	56
19.1	General	56
19.2	Adding a note	56
19.2.1	General.....	56
19.2.2	Procedure	56
19.3	Adding a table.....	57
19.3.1	General.....	57
19.3.2	Procedure	57
19.4	Adding a voice annotation.....	57
19.4.1	General.....	57
19.4.2	Procedure	57
19.5	Adding a sketch.....	58
19.5.1	General.....	58
19.5.2	Procedure	58
20	Programming the camera (time lapse)	59
20.1	General	59
20.2	Procedure	59
21	Recording video clips	60
21.1	General	60
21.2	Procedure	60
22	Screening alarm	61
22.1	General	61

Table of contents

22.2	Procedure	61
23	Changing settings	62
23.1	General	62
23.1.1	<i>Define user presets</i>	62
23.1.2	<i>Save options</i>	62
23.1.3	<i>Programmable button</i>	62
23.1.4	<i>Reset options</i>	62
23.1.5	<i>Device settings</i>	62
23.2	Procedure	63
24	Technical data.....	64
24.1	Online field-of-view calculator	65
24.2	Note about technical data	65
24.3	Note about authoritative versions.....	65
24.4	FLIR T600 15° (incl. Wi-Fi and Ext. cal.).....	66
24.5	FLIR T600 15° (incl. Wi-Fi).....	72
24.6	FLIR T600 25° (incl. Wi-Fi and Ext. cal.).....	78
24.7	FLIR T600 25° (incl. Wi-Fi).....	84
24.8	FLIR T600 25° and 15° w/case.....	90
24.9	FLIR T600 25° and 45° w/case.....	96
24.10	FLIR T600 45° (incl. Wi-Fi and Ext. cal.).....	102
24.11	FLIR T600 45° (incl. Wi-Fi).....	108
24.12	FLIR T600bx 25° (incl. Wi-Fi and Ext. cal.).....	114
24.13	FLIR T600bx 25° (incl. Wi-Fi).....	120
24.14	FLIR T600bx 45° (incl. Wi-Fi and Ext. cal.).....	126
24.15	FLIR T600bx 45° (incl. Wi-Fi).....	132
24.16	FLIR T610 15° (incl. Wi-Fi).....	138
24.17	FLIR T610 25° (incl. Wi-Fi).....	144
24.18	FLIR T610 45° (incl. Wi-Fi).....	150
24.19	FLIR T620 15° (incl. Wi-Fi and Ext. cal.).....	156
24.20	FLIR T620 15° (incl. Wi-Fi).....	162
24.21	FLIR T620 25° (incl. Wi-Fi and Ext. cal.).....	168
24.22	FLIR T620 25° (incl. Wi-Fi).....	174
24.23	FLIR T620 25° and 15° (incl. Wi-Fi).....	180
24.24	FLIR T620 25° and 45° (incl. Wi-Fi).....	186
24.25	FLIR T620 45° (incl. Wi-Fi and Ext. cal.).....	192
24.26	FLIR T620 45° (incl. Wi-Fi).....	198
24.27	FLIR T620bx 15° (incl. Wi-Fi and Ext. cal.).....	204
24.28	FLIR T620bx 15° (incl. Wi-Fi).....	210
24.29	FLIR T620bx 25° (incl. Wi-Fi and Ext. cal.).....	216
24.30	FLIR T620bx 25° (incl. Wi-Fi).....	222
24.31	FLIR T620bx 45° (incl. Wi-Fi and Ext. cal.).....	228
24.32	FLIR T620bx 45° (incl. Wi-Fi).....	234
24.33	FLIR T630 15° (incl. Wi-Fi).....	240
24.34	FLIR T630 25° (incl. Wi-Fi).....	246
24.35	FLIR T630 45° (incl. Wi-Fi).....	252
24.36	FLIR T630sc 15° (incl. Wi-Fi).....	258
24.37	FLIR T630sc 25° (incl. Wi-Fi).....	264
24.38	FLIR T630sc 25° and 45° w/case	270
24.39	FLIR T630sc 45° (incl. Wi-Fi).....	276
24.40	FLIR T640 15° (incl. Wi-Fi and Ext. cal.).....	282
24.41	FLIR T640 15° (incl. Wi-Fi).....	288
24.42	FLIR T640 25° (incl. Wi-Fi and Ext. cal.).....	294
24.43	FLIR T640 25° (incl. Wi-Fi).....	300
24.44	FLIR T640 25° and 15° (incl. Wi-Fi).....	306
24.45	FLIR T640 25° and 45° (incl. Wi-Fi).....	312

Table of contents

24.46	FLIR T640 45° (incl. Wi-Fi and Ext. cal.)	318
24.47	FLIR T640 45° (incl. Wi-Fi)	324
24.48	FLIR T640bx 15° (incl. Wi-Fi and Ext. cal.)	330
24.49	FLIR T640bx 15° (incl. Wi-Fi)	336
24.50	FLIR T640bx 25° (incl. Wi-Fi and Ext. cal.)	342
24.51	FLIR T640bx 25° (incl. Wi-Fi)	348
24.52	FLIR T640bx 45° (incl. Wi-Fi and Ext. cal.)	354
24.53	FLIR T640bx 45° (incl. Wi-Fi)	360
24.54	FLIR T650sc 15° (incl. Wi-Fi)	366
24.55	FLIR T650sc 25° (incl. Wi-Fi)	372
24.56	FLIR T650sc 25° and 15° w/case	378
24.57	FLIR T650sc 25° and 45° w/case	384
24.58	FLIR T650sc 45° (incl. Wi-Fi)	390
24.59	FLIR T660 15° (incl. Wi-Fi and Ext. cal.)	396
24.60	FLIR T660 15° (incl. Wi-Fi)	402
24.61	FLIR T660 25° (incl. Wi-Fi and Ext. cal.)	408
24.62	FLIR T660 25° (incl. Wi-Fi)	414
24.63	FLIR T660 25° and 15° w/case	420
24.64	FLIR T660 25° and 45° w/case	426
24.65	FLIR T660 45° (incl. Wi-Fi and Ext. cal.)	432
24.66	FLIR T660 45° (incl. Wi-Fi)	438
25	Mechanical drawings	444
26	CE Declaration of conformity	454
27	Cleaning the camera	456
27.1	Camera housing, cables, and other items	456
27.1.1	Liquids	456
27.1.2	Equipment	456
27.1.3	Procedure	456
27.2	Infrared lens	456
27.2.1	Liquids	456
27.2.2	Equipment	456
27.2.3	Procedure	456
27.3	Infrared detector	457
27.3.1	General	457
27.3.2	Procedure	457
28	Application examples	458
28.1	Moisture & water damage	458
28.1.1	General	458
28.1.2	Figure	458
28.2	Faulty contact in socket	458
28.2.1	General	458
28.2.2	Figure	458
28.3	Oxidized socket	459
28.3.1	General	459
28.3.2	Figure	459
28.4	Insulation deficiencies	460
28.4.1	General	460
28.4.2	Figure	460
28.5	Draft	460
28.5.1	General	460
28.5.2	Figure	460
29	About FLIR Systems	462
29.1	More than just an infrared camera	463
29.2	Sharing our knowledge	463

Table of contents

	29.3	Supporting our customers.....	464
30		Terms, laws, and definitions.....	465
31		Thermographic measurement techniques	467
	31.1	Introduction	467
	31.2	Emissivity.....	467
	31.2.1	Finding the emissivity of a sample.....	467
	31.3	Reflected apparent temperature.....	471
	31.4	Distance	471
	31.5	Relative humidity	471
	31.6	Other parameters.....	471
32		History of infrared technology.....	472
33		Theory of thermography.....	475
	33.1	Introduction	475
	33.2	The electromagnetic spectrum.....	475
	33.3	Blackbody radiation.....	475
	33.3.1	Planck's law	476
	33.3.2	Wien's displacement law.....	477
	33.3.3	Stefan-Boltzmann's law	478
	33.3.4	Non-blackbody emitters.....	479
	33.4	Infrared semi-transparent materials.....	481
34		The measurement formula.....	482
35		Emissivity tables	486
	35.1	References.....	486
	35.2	Tables	486

1.1 Legal disclaimer

All products manufactured by FLIR Systems are warranted against defective materials and workmanship for a period of one (1) year from the delivery date of the original purchase, provided such products have been under normal storage, use and service, and in accordance with FLIR Systems instruction.

Uncooled handheld infrared cameras manufactured by FLIR Systems are warranted against defective materials and workmanship for a period of two (2) years from the delivery date of the original purchase, provided such products have been under normal storage, use and service, and in accordance with FLIR Systems instruction, and provided that the camera has been registered within 60 days of original purchase.

Detectors for uncooled handheld infrared cameras manufactured by FLIR Systems are warranted against defective materials and workmanship for a period of ten (10) years from the delivery date of the original purchase, provided such products have been under normal storage, use and service, and in accordance with FLIR Systems instruction, and provided that the camera has been registered within 60 days of original purchase.

Products which are not manufactured by FLIR Systems but included in systems delivered by FLIR Systems to the original purchaser, carry the warranty, if any, of the particular supplier only. FLIR Systems has no responsibility whatsoever for such products.

The warranty extends only to the original purchaser and is not transferable. It is not applicable to any product which has been subjected to misuse, neglect, accident or abnormal conditions of operation. Expendable parts are excluded from the warranty.

In the case of a defect in a product covered by this warranty the product must not be further used in order to prevent additional damage. The purchaser shall promptly report any defect to FLIR Systems or this warranty will not apply.

FLIR Systems will, at its option, repair or replace any such defective product free of charge if, upon inspection, it proves to be defective in material or workmanship and provided that it is returned to FLIR Systems within the said one-year period.

FLIR Systems has no other obligation or liability for defects than those set forth above.

No other warranty is expressed or implied. FLIR Systems specifically disclaims the implied warranties of merchantability and fitness for a particular purpose.

FLIR Systems shall not be liable for any direct, indirect, special, incidental or consequential loss or damage, whether based on contract, tort or any other legal theory.

This warranty shall be governed by Swedish law.

Any dispute, controversy or claim arising out of or in connection with this warranty, shall be finally settled by arbitration in accordance with the Rules of the Arbitration Institute of the Stockholm Chamber of Commerce. The place of arbitration shall be Stockholm. The language to be used in the arbitral proceedings shall be English.

1.2 Usage statistics

FLIR Systems reserves the right to gather anonymous usage statistics to help maintain and improve the quality of our software and services.

1.3 Changes to registry

The registry entry HKEY_LOCAL_MACHINE\SYSTEM\CurrentControlSet\Control\Lsa\LmCompatibilityLevel will be automatically changed to level 2 if the FLIR Camera Monitor service detects a FLIR camera connected to the computer with a USB cable. The modification will only be executed if the camera device implements a remote network service that supports network logons.

1.4 U.S. Government Regulations

This product may be subject to U.S. Export Regulations. Please send any inquiries to exportquestions@flir.com.

1.5 Copyright

© 2016, FLIR Systems, Inc. All rights reserved worldwide. No parts of the software including source code may be reproduced, transmitted, transcribed or translated into any language or computer language in any form or by any means, electronic, magnetic, optical, manual or otherwise, without the prior written permission of FLIR Systems.

The documentation must not, in whole or part, be copied, photocopied, reproduced, translated or transmitted to any electronic medium or machine readable form without prior consent, in writing, from FLIR Systems.

Names and marks appearing on the products herein are either registered trademarks or trademarks of FLIR Systems and/or its subsidiaries. All other trademarks, trade names or company names referenced herein are used for identification only and are the property of their respective owners.

1.6 Quality assurance

The Quality Management System under which these products are developed and manufactured has been certified in accordance with the ISO 9001 standard.

FLIR Systems is committed to a policy of continuous development; therefore we reserve the right to make changes and improvements on any of the products without prior notice.

1.7 Patents







000439161; 000653423; 000726344; 000859020; 001707738; 001707746; 001707787; 001776519; 001954074; 002021543; 002021543-0002; 002058180; 002249953; 002531178; 002816785; 002816793; 011200326; 014347553; 057692; 061609; 07002405; 100414275; 101796816; 101796817; 101796818; 102334141; 1062100; 11063060001; 11517895; 1226865; 12300216; 12300224; 1285345; 1299699; 1325808; 1336775; 1391114; 1402918; 1404291; 1411581; 1415075; 1421497; 1458284; 1678485; 1732314; 17399650; 1880950; 1886650; 2007301511414; 2007303395047; 2008301285812; 2009301900619; 20100060357; 2010301761271; 2010301761303; 2010301761572; 2010305959313; 2011304423549; 2012304717443; 2012306207318; 2013302676195; 2015202354035; 2015304259171; 204465713; 204967995; 2106017; 2107799; 2115696; 2172004; 2315433; 2381417; 2794760001; 3006596; 3006597; 303330211; 4358936; 483782; 484155; 4889913; 4937897; 4995790001; 5177595; 540838; 579475; 584755; 599392; 60122153; 6020040116815; 602006006500.0; 6020080347796; 6020110003453; 615113; 615116; 664580; 664581; 665004; 665440; 67023029; 6707044; 677298; 68657; 69036179; 70022216; 70028915; 70028923; 70057990; 7034300; 710424; 7110035; 7154093; 7157705; 718801; 723605; 7237946; 7312822; 7332716; 7336823; 734803; 7544944; 7606484; 7634157; 7667198; 7809258; 7826736; 8018649; 8153971; 8212210; 8289372; 8340414; 8354639; 8384783; 8520970; 8565547; 8595689; 8599262; 8654239; 8680468; 8803093; 8823803; 8853631; 8933403; 9171361; 9191583; 9279728; 9280812; 9338352; 9423940; 9471970; 9595087; D549758.











1.8 EULA Terms

- You have acquired a device ("INFRARED CAMERA") that includes software licensed by FLIR Systems AB from Microsoft Licensing, GP or its affiliates ("MS"). Those installed software products of MS origin, as well as associated media, printed materials, and "online" or electronic documentation ("SOFTWARE") are protected by international intellectual property laws and treaties. The SOFTWARE is licensed, not sold. All rights reserved.
- IF YOU DO NOT AGREE TO THIS END USER LICENSE AGREEMENT ("EULA"), DO NOT USE THE DEVICE OR COPY THE SOFTWARE. INSTEAD, PROMPTLY CONTACT FLIR Systems AB FOR INSTRUCTIONS ON RETURN OF THE UNUSED DEVICE(S) FOR A REFUND. **ANY USE OF THE SOFTWARE, INCLUDING BUT NOT LIMITED TO USE ON THE DEVICE, WILL CONSTITUTE YOUR AGREEMENT TO THIS EULA (OR RATIFICATION OF ANY PREVIOUS CONSENT).**
- GRANT OF SOFTWARE LICENSE.** This EULA grants you the following license:
 - You may use the SOFTWARE only on the DEVICE.
 - NOT FAULT TOLERANT.** THE SOFTWARE IS NOT FAULT TOLERANT. FLIR Systems AB HAS INDEPENDENTLY DETERMINED HOW TO USE THE SOFTWARE IN THE DEVICE, AND MS HAS RELIED UPON FLIR Systems AB TO CONDUCT SUFFICIENT TESTING TO DETERMINE THAT THE SOFTWARE IS SUITABLE FOR SUCH USE.
 - NO WARRANTIES FOR THE SOFTWARE.** THE SOFTWARE is provided "AS IS" and with all faults. THE ENTIRE RISK AS TO SATISFACTORY QUALITY, PERFORMANCE, ACCURACY, AND EFFORT (INCLUDING LACK OF NEGLIGENCE) IS WITH YOU. ALSO, THERE IS NO WARRANTY AGAINST INTERFERENCE WITH YOUR ENJOYMENT OF THE SOFTWARE OR AGAINST INFRINGEMENT. **IF YOU HAVE RECEIVED ANY WARRANTIES REGARDING THE DEVICE OR THE SOFTWARE, THOSE WARRANTIES DO NOT ORIGINATE FROM, AND ARE NOT BINDING ON, MS.**
 - No Liability for Certain Damages. **EXCEPT AS PROHIBITED BY LAW, MS SHALL HAVE NO LIABILITY FOR ANY INDIRECT, SPECIAL, CONSEQUENTIAL OR INCIDENTAL DAMAGES ARISING FROM OR IN CONNECTION WITH THE USE OR PERFORMANCE OF THE SOFTWARE. THIS LIMITATION SHALL APPLY EVEN IF ANY REMEDY FAILS OF ITS ESSENTIAL PURPOSE. IN NO EVENT SHALL MS BE LIABLE FOR ANY AMOUNT IN EXCESS OF U.S. TWO HUNDRED FIFTY DOLLARS (U.S.\$250.00).**
 - Limitations on Reverse Engineering, Decompilation, and Disassembly.** You may not reverse engineer, decompile, or disassemble the SOFTWARE, except and only to the extent that such activity is expressly permitted by applicable law notwithstanding this limitation.
 - SOFTWARE TRANSFER ALLOWED BUT WITH RESTRICTIONS.** You may permanently transfer rights under this EULA only as part of a permanent sale or transfer of the Device, and only if the recipient agrees to this EULA. If the SOFTWARE is an upgrade, any transfer must also include all prior versions of the SOFTWARE.
 - EXPORT RESTRICTIONS.** You acknowledge that SOFTWARE is subject to U.S. export jurisdiction. You agree to comply with all applicable international and national laws that apply to the SOFTWARE, including the U.S. Export Administration Regulations, as well as end-user, end-use and destination restrictions issued by U.S. and other governments. For additional information see <http://www.microsoft.com/exporting/>.











1.9 EULA Terms







Qt4 Core and Qt4 GUI, Copyright ©2013 Nokia Corporation and FLIR Systems AB. This Qt library is a free software; you can redistribute it and/or modify it under the terms of the GNU Lesser General Public License as published by the Free Software Foundation; either version 2.1 of the License, or (at your option) any later version. This library is distributed in the hope that it will be useful, but WITHOUT ANY WARRANTY; without even the implied warranty of MERCHANTABILITY or FITNESS FOR A PARTICULAR PURPOSE. See the GNU Lesser General Public License, <http://www.gnu.org/licenses/lgpl-2.1.html>. The source code for the libraries Qt4 Core and Qt4 GUI may be requested from FLIR Systems AB.

 WARNING
<p>Applicability: Class B digital devices.</p> <p>This equipment has been tested and found to comply with the limits for a Class B digital device, pursuant to Part 15 of the FCC Rules. These limits are designed to provide reasonable protection against harmful interference in a residential installation. This equipment generates, uses and can radiate radio frequency energy and, if not installed and used in accordance with the instructions, may cause harmful interference to radio communications. However, there is no guarantee that interference will not occur in a particular installation. If this equipment does cause harmful interference to radio or television reception, which can be determined by turning the equipment off and on, the user is encouraged to try to correct the interference by one or more of the following measures:</p> <ul style="list-style-type: none"> • Reorient or relocate the receiving antenna. • Increase the separation between the equipment and receiver. • Connect the equipment into an outlet on a circuit different from that to which the receiver is connected. • Consult the dealer or an experienced radio/TV technician for help.
 WARNING
<p>Applicability: Digital devices subject to 15.19/RSS-247.</p> <p>NOTICE: This device complies with Part 15 of the FCC Rules and with RSS-247 of Industry Canada. Operation is subject to the following two conditions:</p> <ol style="list-style-type: none"> 1. this device may not cause harmful interference, and 2. this device must accept any interference received, including interference that may cause undesired operation.
 WARNING
<p>Applicability: Digital devices subject to 15.21.</p> <p>NOTICE: Changes or modifications made to this equipment not expressly approved by FLIR Systems may void the FCC authorization to operate this equipment.</p>
 WARNING
<p>Applicability: Devices subject to RSS-102/47CFR2.1093.</p> <p>This device has been tested and meets the FCC/ISED RF exposure guidelines, or the device is exempted from SAR because of the low output power. Nevertheless, the device should be used in such a manner that the potential for human contact during normal operation is minimized.</p>
 WARNING
<p>Applicability: Cameras with one or more laser pointers.</p> <p>Do not look directly into the laser beam. The laser beam can cause eye irritation.</p>
 WARNING
<p>Applicability: Cameras with one or more batteries.</p> <p>Do not disassemble or do a modification to the battery. The battery contains safety and protection devices which, if damage occurs, can cause the battery to become hot, or cause an explosion or an ignition.</p>
 WARNING
<p>Applicability: Cameras with one or more batteries.</p> <p>If there is a leak from the battery and you get the fluid in your eyes, do not rub your eyes. Flush well with water and immediately get medical care. The battery fluid can cause injury to your eyes if you do not do this.</p>

 WARNING
Applicability: Cameras with one or more batteries. Do not continue to charge the battery if it does not become charged in the specified charging time. If you continue to charge the battery, it can become hot and cause an explosion or ignition. Injury to persons can occur.
 WARNING
Applicability: Cameras with one or more batteries. Only use the correct equipment to remove the electrical power from the battery. If you do not use the correct equipment, you can decrease the performance or the life cycle of the battery. If you do not use the correct equipment, an incorrect flow of current to the battery can occur. This can cause the battery to become hot, or cause an explosion. Injury to persons can occur.
 WARNING
Make sure that you read all applicable MSDS (Material Safety Data Sheets) and warning labels on containers before you use a liquid. The liquids can be dangerous. Injury to persons can occur.
 CAUTION
Do not point the infrared camera (with or without the lens cover) at strong energy sources, for example, devices that cause laser radiation, or the sun. This can have an unwanted effect on the accuracy of the camera. It can also cause damage to the detector in the camera.
 CAUTION
Do not use the camera in temperatures more than +50°C (+122°F), unless other information is specified in the user documentation or technical data. High temperatures can cause damage to the camera.
 CAUTION
Applicability: Cameras with one or more laser pointers. To prevent damage, put the protective cap on the laser pointer when you do not operate the laser pointer. Damage to the laser pointer can occur if you do not do this.
 CAUTION
Applicability: Cameras with one or more batteries. Do not attach the batteries directly to a car's cigarette lighter socket, unless FLIR Systems supplies a specific adapter to connect the batteries to a cigarette lighter socket. Damage to the batteries can occur.
 CAUTION
Applicability: Cameras with one or more batteries. Do not connect the positive terminal and the negative terminal of the battery to each other with a metal object (such as wire). Damage to the batteries can occur.
 CAUTION
Applicability: Cameras with one or more batteries. Do not get water or salt water on the battery, or permit the battery to become wet. Damage to the batteries can occur.
 CAUTION
Applicability: Cameras with one or more batteries. Do not make holes in the battery with objects. Damage to the battery can occur.

Safety information

 CAUTION
Applicability: Cameras with one or more batteries. Do not hit the battery with a hammer. Damage to the battery can occur.
 CAUTION
Applicability: Cameras with one or more batteries. Do not put your foot on the battery, hit it or cause shocks to it. Damage to the battery can occur.
 CAUTION
Applicability: Cameras with one or more batteries. Do not put the batteries in or near a fire, or into direct sunlight. When the battery becomes hot, the built-in safety equipment becomes energized and can stop the battery charging procedure. If the battery becomes hot, damage can occur to the safety equipment and this can cause more heat, damage or ignition of the battery.
 CAUTION
Applicability: Cameras with one or more batteries. Do not put the battery on a fire or increase the temperature of the battery with heat. Damage to the battery and injury to persons can occur.
 CAUTION
Applicability: Cameras with one or more batteries. Do not put the battery on or near fires, stoves, or other high-temperature locations. Damage to the battery and injury to persons can occur.
 CAUTION
Applicability: Cameras with one or more batteries. Do not solder directly onto the battery. Damage to the battery can occur.
 CAUTION
Applicability: Cameras with one or more batteries. Do not use the battery if, when you use, charge, or put the battery in storage, there is an unusual smell from the battery, the battery feels hot, changes color, changes shape, or is in an unusual condition. Speak with your sales office if one or more of these problems occurs. Damage to the battery and injury to persons can occur.
 CAUTION
Applicability: Cameras with one or more batteries. Only use a specified battery charger when you charge the battery. Damage to the battery can occur if you do not do this.
 CAUTION
Applicability: Cameras with one or more batteries. Only use a specified battery for the camera. Damage to the camera and the battery can occur if you do not do this.
 CAUTION
Applicability: Cameras with one or more batteries. The temperature range through which you can charge the battery is 0°C to +45°C (+32°F to +113°F). If you charge the battery at temperatures out of this range, it can cause the battery to become hot or to break. It can also decrease the performance or the life cycle of the battery.

 CAUTION
Applicability: Cameras with one or more batteries. The temperature range through which you can remove the electrical power from the battery is -15°C to +50°C (+5°F to +122°F), unless other information is specified in the user documentation or technical data. If you operate the battery out of this temperature range, it can decrease the performance or the life cycle of the battery.
 CAUTION
Applicability: Cameras with one or more batteries. When the battery is worn, apply insulation to the terminals with adhesive tape or equivalent materials before you discard it. Damage to the battery and injury to persons can occur if you do not do this.
 CAUTION
Applicability: Cameras with one or more batteries. Remove any water or moisture on the battery before you install it. Damage to the battery can occur if you do not do this.
 CAUTION
Do not apply solvents or equivalent liquids to the camera, the cables, or other items. Damage to the battery and injury to persons can occur.
 CAUTION
Be careful when you clean the infrared lens. The lens has an anti-reflective coating which is easily damaged. Damage to the infrared lens can occur.
 CAUTION
Do not use too much force to clean the infrared lens. This can cause damage to the anti-reflective coating.
Note The encapsulation rating is only applicable when all the openings on the camera are sealed with their correct covers, hatches, or caps. This includes the compartments for data storage, batteries, and connectors.
 CAUTION
Applicability: Cameras with a viewfinder. Make sure that the beams from the intensive energy sources do not go into the viewfinder. The beams can cause damage to the camera. This includes the devices that emit laser radiation, or the sun.

3.1 User-to-user forums

Exchange ideas, problems, and infrared solutions with fellow thermographers around the world in our user-to-user forums. To go to the forums, visit:

<http://forum.infraredtraining.com/>

3.2 Calibration

We recommend that you send in the camera for calibration once a year. Contact your local sales office for instructions on where to send the camera.

3.3 Accuracy

For very accurate results, we recommend that you wait 5 minutes after you have started the camera before measuring a temperature.

3.4 Disposal of electronic waste

Electrical and electronic equipment (EEE) contains materials, components and substances that may be hazardous and present a risk to human health and the environment when waste electrical and electronic equipment (WEEE) is not handled correctly.

Equipment marked with the below crossed-out wheeled bin is electrical and electronic equipment. The crossed-out wheeled bin symbol indicates that waste electrical and electronic equipment should not be discarded together with unseparated household waste, but must be collected separately.

For this purpose all local authorities have established collection schemes under which residents can dispose waste electrical and electronic equipment at a recycling centre or other collection points, or WEEE will be collected directly from households. More detailed information is available from the technical administration of the relevant local authority.



3.5 Training

To read about infrared training, visit:

- <http://www.infraredtraining.com>
- <http://www.irtraining.com>
- <http://www.irtraining.eu>

3.6 Documentation updates

Our manuals are updated several times per year, and we also issue product-critical notifications of changes on a regular basis.

To access the latest manuals, translations of manuals, and notifications, go to the Download tab at:

<http://support.flir.com>

It only takes a few minutes to register online. In the download area you will also find the latest releases of manuals for our other products, as well as manuals for our historical and obsolete products.

3.7 Important note about this manual

FLIR Systems issues generic manuals that cover several cameras within a model line.

This means that this manual may contain descriptions and explanations that do not apply to your particular camera model.

3.8 Note about authoritative versions

The authoritative version of this publication is English. In the event of divergences due to translation errors, the English text has precedence.

Any late changes are first implemented in English.

FLIR Thermography and Instruments Customer Support Center

Get support for thermography, fire fighting and instruments products

Welcome to the FLIR Instruments Customer Support Center. This portal will help you to get the most out of your FLIR Instruments products. The portal gives you access to:

- Instruments Knowledgebase
- Ask our support team (requires registration)
- Software and documentation (requires registration)
- Instruments service contacts

Find Answers
Search in our FAQ to find answers.

Search by Keyword

[Search All Answers](#)

[See All Popular Answers](#)

Click this link to find a manual for a current product.
To find a datasheet for a current product, click on a picture.
To find a datasheet for a legacy product, click here.

FLIR TSxx	FLIR A310f	FLIR A310pt	FLIR A3xx	FLIR A6xx	FLIR Aerial
FLIR AX	FLIR AxS	FLIR Cx	FLIR ETS3xx	FLIR Ex	More...
Product catalogs	Software	Accessories	Training		

Important legal disclaimer, dangers, warnings, and cautions

Register Your Products
You will gain access to special discounts and offers, downloads, and software upgrades.
[Register for free today](#)

FLIR Benefits Program
FLIR has decided to offer existing customers holding a valid license for certain software a free upgrade.
[Enter Now](#)

Infrared Training Center
Your premier educational and training resource for infrared camera use.
[Get training](#)
E-learning (English)
Get training in Europe, Middle East and Africa
E-learning (multiple languages)

4.1 General

For customer help, visit:

<http://support.flir.com>

4.2 Submitting a question

To submit a question to the customer help team, you must be a registered user. It only takes a few minutes to register online. If you only want to search the knowledgebase for existing questions and answers, you do not need to be a registered user.

When you want to submit a question, make sure that you have the following information to hand:

- The camera model
- The camera serial number
- The communication protocol, or method, between the camera and your device (for example, SD card reader, HDMI, Ethernet, USB, or FireWire)
- Device type (PC/Mac/iPhone/iPad/Android device, etc.)
- Version of any programs from FLIR Systems
- Full name, publication number, and revision number of the manual

4.3 Downloads

On the customer help site you can also download the following, when applicable for the product:

- Firmware updates for your infrared camera.
- Program updates for your PC/Mac software.
- Freeware and evaluation versions of PC/Mac software.
- User documentation for current, obsolete, and historical products.
- Mechanical drawings (in *.dxf and *.pdf format).
- Cad data models (in *.stp format).
- Application stories.
- Technical datasheets.
- Product catalogs.

5.1 Procedure

Follow this procedure:

1. Put a battery into the battery compartment.
2. Charge the battery for 4 hours before starting the camera for the first time.
3. Insert a memory card into the card slot.
4. Push the On/off button  to turn on the camera.
5. Aim the camera toward the object of interest.
6. Adjust the focus.

Note It is very important to adjust the focus correctly. Incorrect focus adjustment affects how the image modes work. It also affects the temperature measurement.

7. Push the Autofocus/save button fully down to save an image.
8. Go to <http://support.flir.com/tools> and download FLIR Tools.
9. Install FLIR Tools on your computer.
10. Start FLIR Tools.
11. Connect the camera to the computer using a USB cable.
12. Import the images into FLIR Tools.
13. Select one or more images.
14. Click *Generate report*.
15. Click *Export* to export the report as a PDF file.
16. Send the PDF report to your client.

Product name	Part number
Battery charger, incl. power supply with multi plugs T6xx	T198126
Bluetooth Headset	T197771ACC
Calibration including General maintenance T6xx series	T199838
Cigarette lighter adapter kit, 12 VDC, 1.2 m/3.9 ft.	T198509
Close-up IR lens, 1.5x (25 µm) with case	T198066
Close-up IR lens, 2.9x (50 µm) with case	T198059
Close-up IR lens, 5.8x (100 µm) with case	T198060
FLIR Reporter Professional (license only)	T198586
FLIR ResearchIR 3 (license only)	T198578
FLIR ResearchIR 3 Max (license only)	T198574
FLIR ResearchIR Max + HSDR 4	T198697
FLIR ResearchIR Max 4	T198696
FLIR ResearchIR Standard 4	T198731
FLIR Tools	T198584
FLIR Tools+ (license only)	T198583
Hard transport case for T6xx series	T198625ACC
HDMI type C to DVI cable 1.5 m	T910930ACC
HDMI type C to HDMI type A cable 1.5 m	T910891ACC
High temp option +300°C to 2000°C (+572°F to 3632°F) for FLIR A6xxsc and T6xx	T197896
IR lens, f=13.1 mm (45°) with case	T197915
IR lens, f=24.6 mm (25°) with case	T197922
IR lens, f=41.3 mm (15°) with case	T197914
IR lens, f=6.5 mm (80°) with case	T198065
IR lens, f=88.9 mm (7°) with case and support for T6xx	T198166
IR Window 2 in	19250-100
IR Window 3 in.	19251-100
IR Window 4 in.	19252-100
Large eyecup	T198497
Li-Ion Battery pack 3.7V 29Wh	T198506
Memory card SDHC 4 GB	T911230ACC
Neck strap	T198499
One year extended warranty for T6xx series	T199836
Pouch for FLIR T6xx and T4xx series	T198495
Power supply, incl. multi plugs	T910814
SS IR Window 2 in.	19250-200
SS IR Window 3 in.	19251-200
SS IR Window 4 in.	19252-200
Tool belt	T911093
Tripod Adapter	T198498
USB cable Std A <-> Mini-B	1910423

Note FLIR Systems reserves the right to discontinue models, parts or accessories, and other items, or to change specifications at any time without prior notice.

7.1 General

To prevent strain-related injuries, it is important that you hold the camera ergonomically correct. This section gives advice and examples on how to hold the camera.

Note Please note the following:

- Always tilt the touch-screen LCD to suit your work position.
- When you hold the camera, make sure that you support the optics housing with your left hand too. This decreases the strain on your right hand.

7.2 Figure

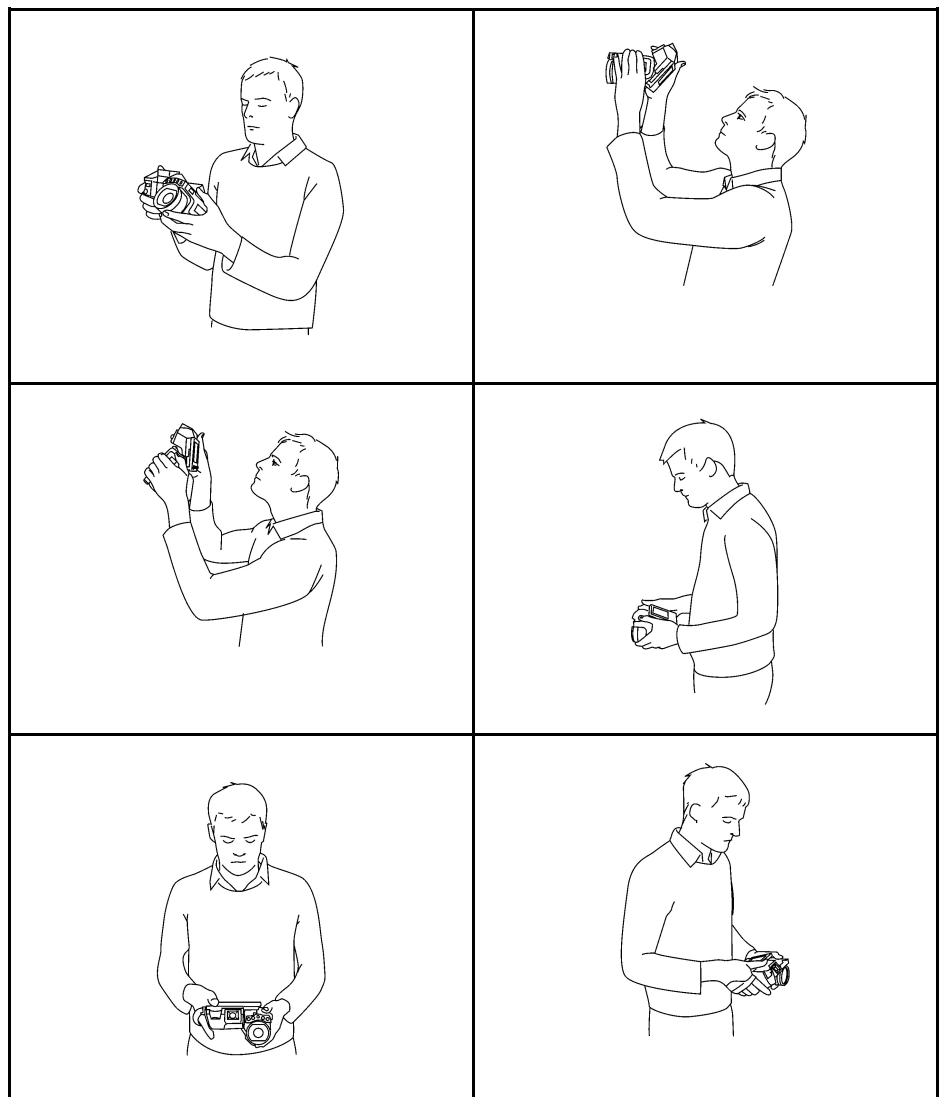

8.1 View from the right

8.1.1 Figure

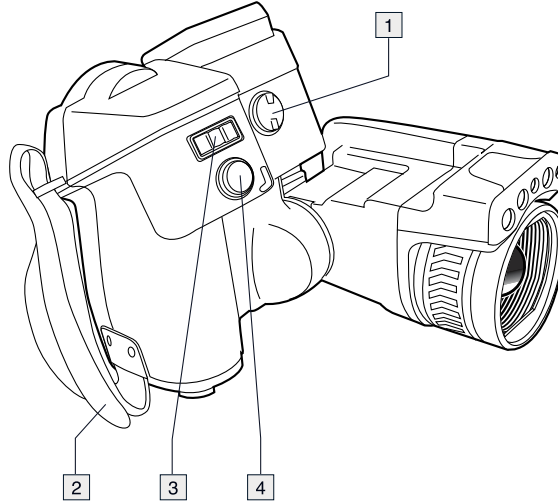

8.1.2 Explanation

1. Knob to change the dioptic correction for the viewfinder.

Note This item is dependent on the camera model.

2. Hand strap.
3. Digital zoom button.
4. Autofocus button (push half-way down)/Save button (push fully down).

8.2 View from the left

8.2.1 Figure

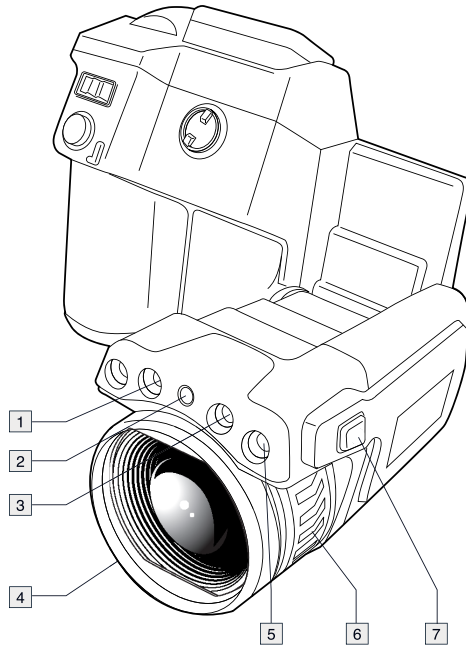

8.2.2 Explanation

1. Camera lamp.
2. Laser pointer.

Note The laser pointer may not be enabled in all markets.

3. Camera lamp.
4. Infrared lens.
5. Digital camera.
6. Focusing ring.
7. Button to operate the laser pointer.

8.3 View from the rear

8.3.1 Figure

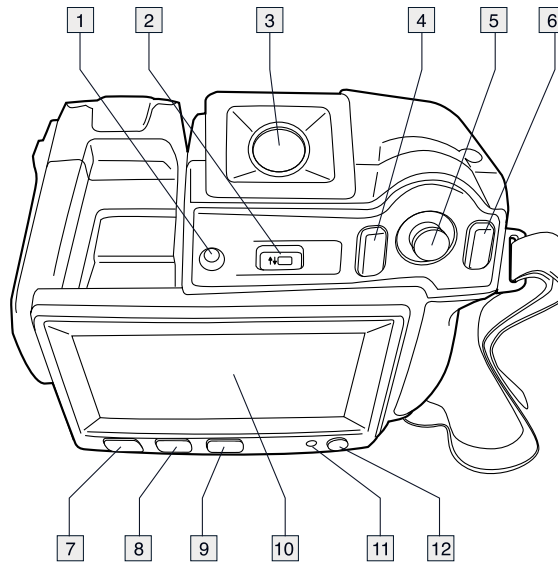

8.3.2 Explanation

1. Sensor that adjusts the touch-screen LCD intensity automatically.
2. Button to switch between touch-screen LCD mode and viewfinder mode.

Note This item is dependent on the camera model.

3. Viewfinder.

Note This item is dependent on the camera model.

4. Programmable button.
5. Joystick with push-button functionality.
6. Back button.
7. Camera lamp button.
8. Button to switch between automatic and manual image adjustment mode.
9. Image archive button.
10. Touch-screen LCD.
11. Power indicator.
12. On/off button.

8.4 View from the bottom

8.4.1 Figure

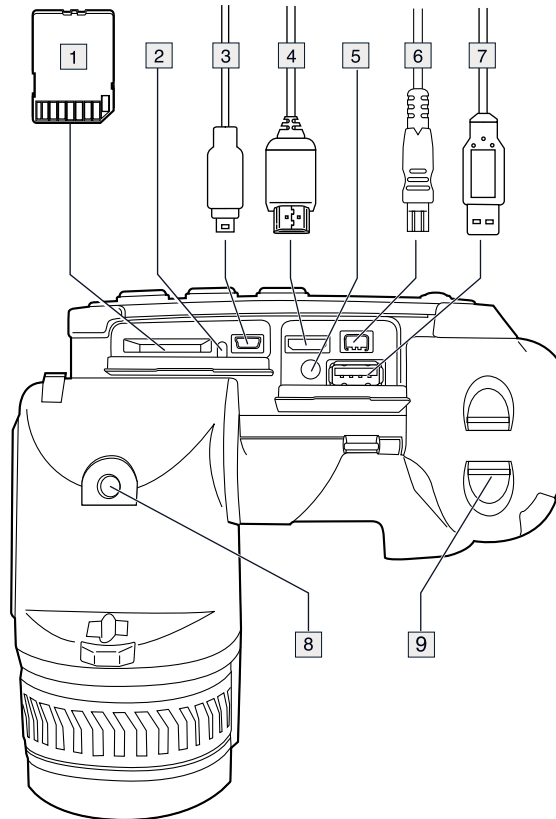

8.4.2 Explanation

1. Memory card.
2. Indicator showing that the memory card is busy.

Note

- Do not eject the memory card when this LED is flashing.
- Do not connect the camera to a computer when this LED is flashing.

3. USB Mini-B cable (to connect the camera to a computer).
4. HDMI cable (for digital video output).
5. Battery condition LED indicator.
6. Power cable (to power the camera and charge the battery).
7. USB-A cable (to connect an external USB device to the camera).
8. Tripod mount. Requires an adapter (included).
9. Latch to release the battery.

8.5 Battery condition LED indicator

8.5.1 Figure

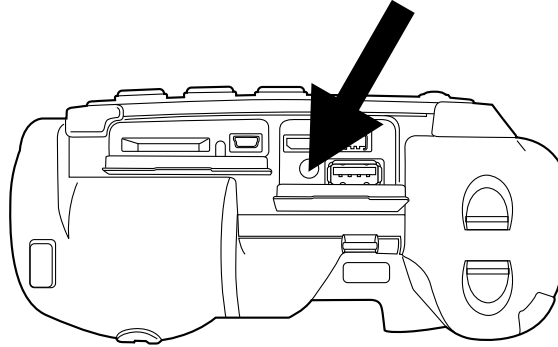

8.5.2 Explanation

Type of signal	Explanation
The green LED flashes twice per second.	The battery is being charged.
The green LED glows continuously.	The battery is fully charged.

8.6 Power LED indicator

8.6.1 Figure

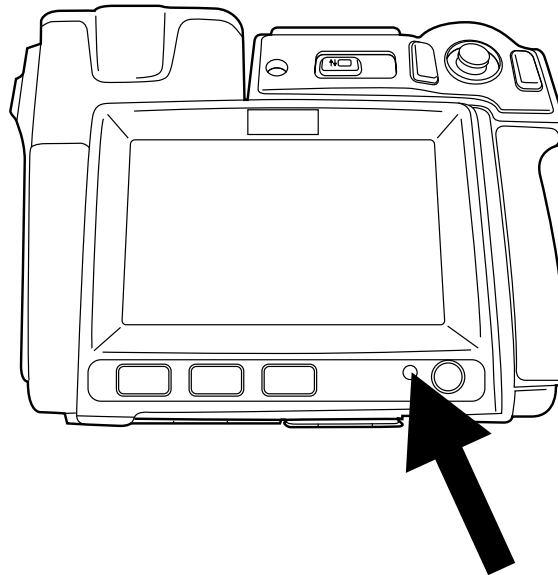

8.6.2 Explanation

Type of signal	Explanation
The LED is off.	The camera is off.
The LED is blue.	The camera is on.

8.7 Laser pointer

8.7.1 Figure

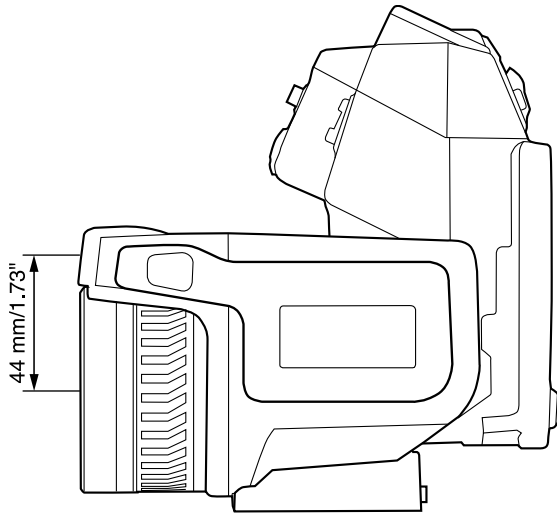





Figure 8.1 This figure shows the difference in position between the laser pointer and the optical center of the infrared lens.

	WARNING
Do not look directly into the laser beam. The laser beam can cause eye irritation.	

Note The symbol  is displayed on the screen when the laser pointer is on.

Note The laser pointer is enabled by a setting. Select  (*Settings*) > *Device settings* > *Set up camera* > *Lamp & laser* > *Enable lamp & laser*.

Note The laser pointer may not be enabled in all markets.

8.7.2 Laser warning label

A laser warning label with the following information is attached to the camera:

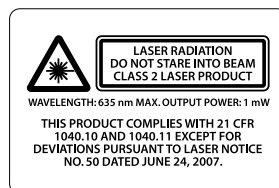

8.7.3 Laser rules and regulations

Wavelength: 635 nm. Maximum output power: 1 mW.

This product complies with 21 CFR 1040.10 and 1040.11 except for deviations pursuant to Laser Notice No. 50, dated June 24, 2007.

9.1 Figure

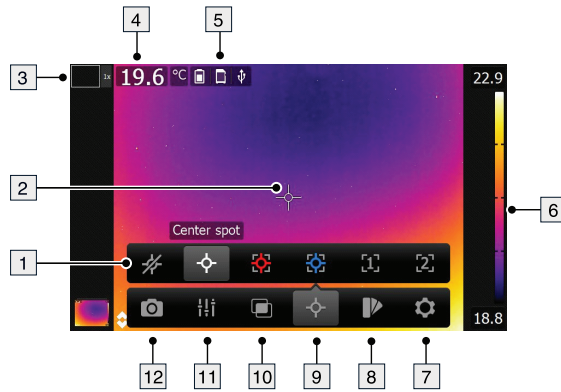

9.2 Explanation

1. Measurement toolbar.
2. Measurement tool (e.g., spotmeter).
3. Zoom factor.
4. Result table.
5. Status icons.
6. Temperature scale.
7. Settings toolbar button.
8. Color toolbar button.
9. Measurement toolbar button.
10. Image mode toolbar button.
11. Measurement parameters toolbar button.
12. Recording mode toolbar button.

10.1 Figure

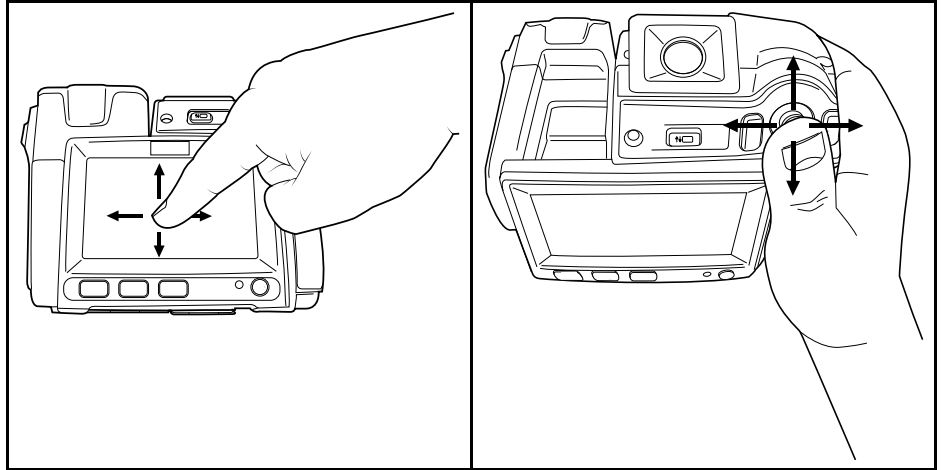

10.2 Explanation

The figure above shows the two ways to navigate the menu system in the camera:

- Using the index finger or a stylus pen specially designed for capacitive touch usage to navigate the menu system (left).
- Using the joystick to navigate the menu system (right).

You can also use a combination of the two.

In this manual it is assumed that the joystick is used, but most tasks can also be carried out using the index finger or a stylus pen.

11.1 General

Before you can use a Bluetooth device with the camera, you need to pair the devices.

11.2 Procedure

Follow this procedure:

1. Push the joystick to display the menu system.
2. Use the joystick to go to  (*Settings*).
3. Push the joystick to display the *Settings* menu.
4. Select *Device settings* and push the joystick.
5. Select *Bluetooth including METERLiNK* and push the joystick.
6. If the *Bluetooth* check box is unchecked, push the joystick to activate Bluetooth.
Note You also need to activate Bluetooth connectivity on the external device.
7. Select *Scan for Bluetooth devices* and push the joystick.
8. Wait until a list of available devices is displayed. This will take about 15 seconds.
9. When a Bluetooth device is found, select the device to add it, and begin the pairing procedure. The device is then ready to be used.

Note

- Only METERLiNK devices and Bluetooth-enabled headsets will appear in the list of available devices.
- You can add several devices.
- You can remove a device by selecting the device and then selecting *Unpair device*.
- After adding a METERLiNK device, such as the FLIR MR77 or FLIR DM93, the result from the meter will be visible in the result table and stored with the images. For more information, see section 17 *Fetching data from external FLIR meters*, page 51.
- After adding a Bluetooth-enabled headset, it is ready to be used for adding voice annotations.

12.1 General

Depending on your camera configuration, you can connect the camera to a wireless local area network (WLAN) using Wi-Fi, or let the camera provide Wi-Fi access to another device.

You can connect the camera in two different ways:

- *Most common use:* Setting up a peer-to-peer connection (also called an *ad hoc* or *P2P* connection). This method is primarily used with other devices, e.g., an iPhone or iPad.
- *Less common use:* Connecting the camera to a WLAN.

12.2 Setting up a peer-to-peer connection (most common use)

Follow this procedure:

1. Push the joystick to display the menu system.
2. Use the joystick to go to  (*Settings*).
3. Push the joystick to display the *Settings* menu.
4. Select *Device settings* and push the joystick.
5. Select *Wi-Fi* and push the joystick.
6. Select *Share* and push the joystick.
7. (Optional step.) To display and change the parameters, select *Settings* and push the joystick.
 - To change the channel (the channel that the camera is broadcasting on), select *Channel* and push the joystick.
 - To activate WEP (encryption algorithm), select *WEP* and push the joystick. This will check the *WEP* check box.
 - To change the WEP password, select *Password* and push the joystick.

Note These parameters are set for your camera's network. They will be used by the external device to connect that device to the network.

12.3 Connecting the camera to a wireless local area network (less common use)

Follow this procedure:

1. Push the joystick to display the menu system.
2. Use the joystick to go to  (*Settings*).
3. Push the joystick to display the *Settings* menu.
4. Select *Device settings* and push the joystick.
5. Select *Wi-Fi* and push the joystick.
6. Select *Connect to network* and push the joystick.
7. To display a list of the available networks, select *Networks* and push the joystick.
8. Select one of the available networks.

Password-protected networks are indicated with a padlock icon, and for these you will need to enter a password.

Note Some networks do not broadcast their existence. To connect to such a network, select *Settings* from the *Networks* list and push the joystick. Then select *Add network...* and set all parameters manually according to that network.

13.1 Charging the battery

Note You must charge the battery for 4 hours before you start using the camera for the first time.

13.1.1 Using the power supply to charge the battery

13.1.1.1 Procedure

Follow this procedure:

1. Connect the power supply cable plug to the power connector on the camera.
2. Connect the power supply mains-electricity plug to a mains socket.
3. Disconnect the power supply cable plug when the green light of the battery condition LED indicator is continuous.

13.1.2 Using the stand-alone battery charger to charge the battery

13.1.2.1 Explanation

Type of signal	Explanation
The blue LED flashes.	The battery is being charged.
The blue LED glows continuous.	The battery is fully charged.

13.1.2.2 Procedure

Follow this procedure:

1. Put the battery in the battery charger.
2. Connect the power supply cable plug to the connector on the battery charger.
3. Connect the power supply mains-electricity plug to a mains socket.
4. Disconnect the power supply cable plug when the blue LED on the battery charger is continuous.

13.2 Turning on the camera

13.2.1 Procedure

Follow this procedure:

1. To turn on the camera, push and release the  button.

13.3 Turning off the camera

13.3.1 Procedure

Follow this procedure:

1. To turn off the camera, push and hold the  button for more than 0.2 second.

13.4 Adjusting the viewfinder's dioptic correction

13.4.1 Figure

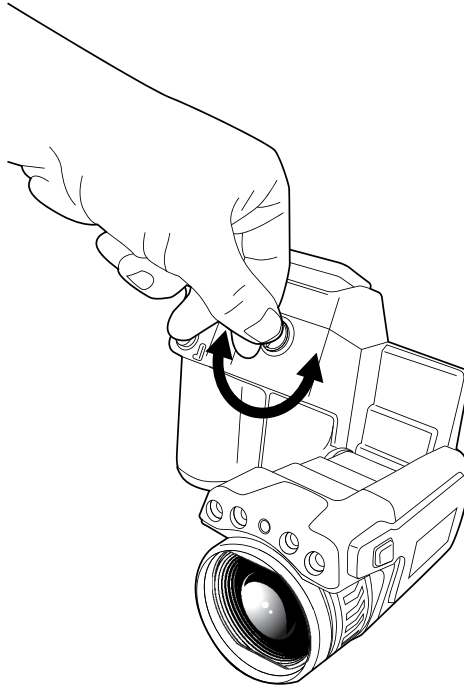
**CAUTION**

Applicability: Cameras with a viewfinder.

Make sure that the beams from the intensive energy sources do not go into the viewfinder. The beams can cause damage to the camera. This includes the devices that emit laser radiation, or the sun.

Note This item is dependent on the camera model.

13.4.2 Procedure

Follow this procedure:

1. To adjust the viewfinder's dioptic correction, look at the displayed text or graphics on the screen, and rotate the adjustment knob clockwise or counter-clockwise for best sharpness.

Note

- Maximum dioptic correction: +2.
- Minimum dioptic correction: -2.

13.5 Adjusting the angle of the lens

13.5.1 Figure

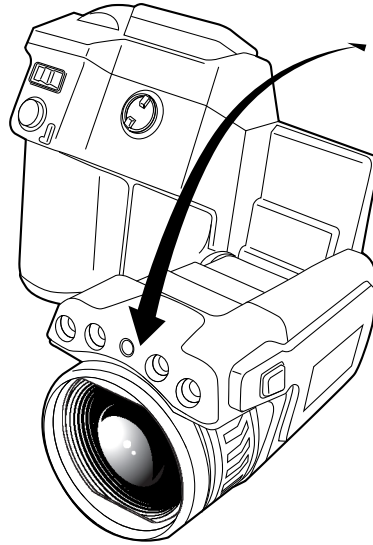

13.6 Adjusting the infrared camera focus manually

13.6.1 Figure

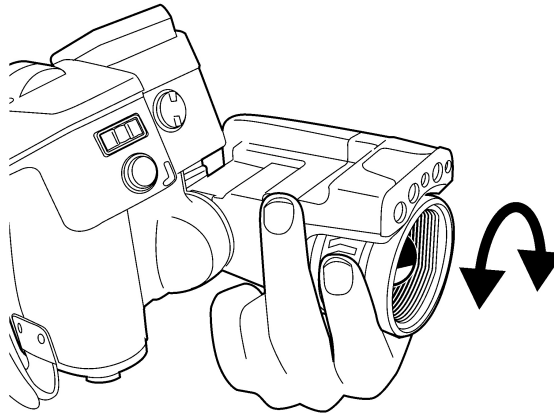

13.6.2 Procedure

Follow this procedure:

1. Do one of the following:
 - For far focus, rotate the focus ring clockwise (looking at the touch-screen LCD side).
 - For near focus, rotate the focus ring counter-clockwise (looking at the touch-screen LCD side).

Note

- Do not touch the lens surface when you adjust the infrared camera focus manually. If this happens, clean the lens according to the instructions in 27.2 *Infrared lens*, page 456.
- The focus ring can be rotated infinitely, but only a certain amount of rotation is needed when focusing.

13.7 Autofocusing the infrared camera

13.7.1 Figure

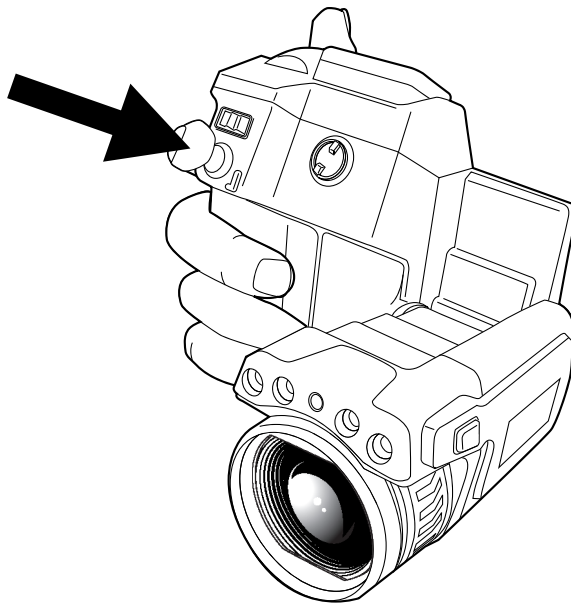

13.7.2 Procedure

Follow this procedure:

1. To autofocus the camera when continuous autofocus is disabled, push the Autofocus/Save button half-way down.

13.8 Continuous autofocus

13.8.1 General

The camera can be set up to perform continuous autofocusing.

Note

- In this mode, the digital camera is used, which means that continuous autofocus will not work in darkness.
- When continuous autofocus is enabled, it is not possible to manually adjust the focus by rotating the focus ring.

13.8.2 Procedure

Follow this procedure:

1. Push the joystick to display the menu system.
2. Use the joystick to go to  (*Settings*).
3. Push the joystick to display the *Settings* menu.

4. Select *Device settings* and push the joystick.
5. Select *Set up camera* and push the joystick.
6. Select *Continuous autofocus*. If the check box is unchecked, push the joystick to enable continuous autofocus.
7. Aim the camera toward the object of interest. The camera will now continuously autofocus.

Note To pause continuous autofocusing, push the Autofocus/Save button half-way down.

13.9 Operating the laser pointer

Note The laser pointer is enabled by a setting. Select  (*Settings*) > *Device settings* > *Set up camera* > *Lamp & laser* > *Enable lamp & laser*.

13.9.1 Figure

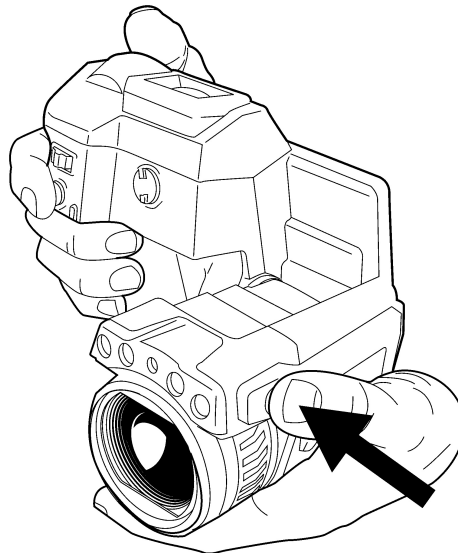

13.9.2 Procedure

Follow this procedure:

1. To turn on the laser pointer, push and hold the laser button.
2. To turn off the laser pointer, release the laser button.

Note

- A warning indicator is displayed on the screen when the laser pointer is turned on.
- The position of the laser dot is indicated on the infrared image (depending on the camera model).

13.10 Using the digital zoom function

13.10.1 Figure

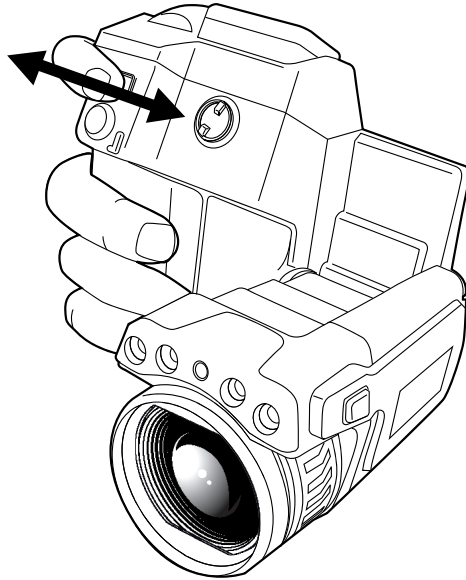

13.10.2 Procedure

Follow this procedure:

1. To zoom, push the zoom button left or right.

13.11 Changing lenses

Follow this procedure:

1. Take a firm grip around the outermost part of the lens.

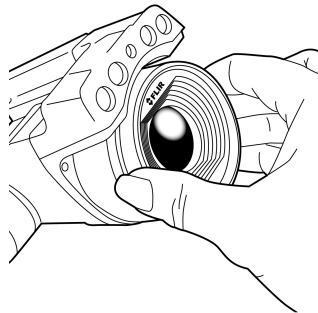

2. Rotate the lens 30° degrees counter-clockwise.

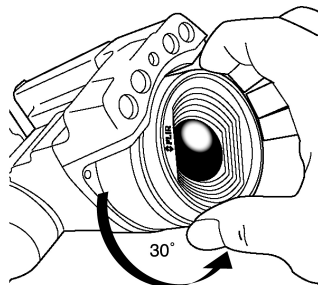

3. Carefully pull out the lens from the lens bayonet mount.

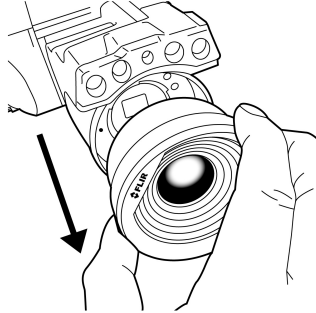

4. The infrared detector is now fully exposed. Do not touch this surface. If you see dust on the detector, follow the instructions in 27.3 *Infrared detector*, page 457.

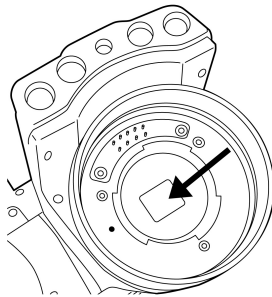

5. Note the index marks on the lens bayonet mount and on the lens.

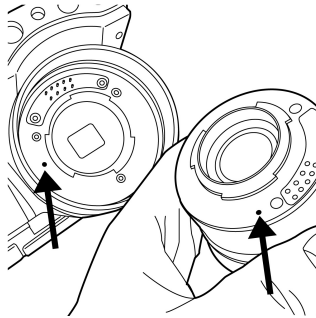

6. Align the lens correctly to the bayonet mount.

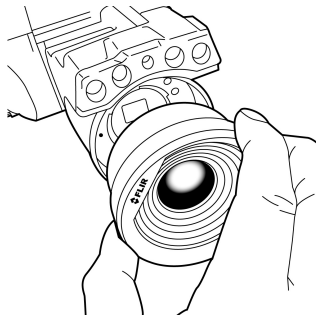

7. Carefully push the lens into position.

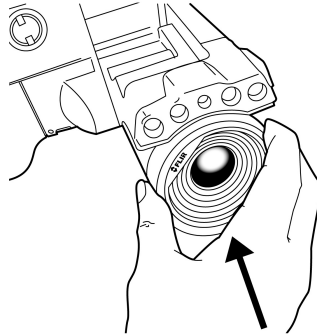

8. Rotate the lens 30° degrees clockwise.

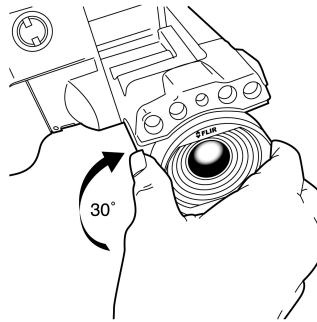

13.12 Calibrating the compass

13.12.1 Procedure

Follow this procedure:

1. Push the joystick to display the menu system.
2. Use the joystick to go to  (*Settings*).
3. Push the joystick to display the *Settings* menu.
4. Select *Device settings* and push the joystick.
5. Select *GPS & compass* and push the joystick.
6. Select *Compass*. If the *Compass* check box is unchecked, push the joystick to enable the compass.
7. Select *Calibrate compass* and push the joystick. Follow the on-screen instructions.

Note You have to rotate the camera slowly.

13.13 Changing the viewfinder eyecup



CAUTION

Applicability: Cameras with a viewfinder.

Make sure that the beams from the intensive energy sources do not go into the viewfinder. The beams can cause damage to the camera. This includes the devices that emit laser radiation, or the sun.

Note This item is dependent on the camera model.

Follow this procedure:

1. Put your thumbs at the lower part of the eyecup. Push the eyecup horizontally, away from the touch-screen LCD side, until the eyecup slides out from its mount.

Note To remove the eyecup, you must slide it out from its mount. Do not pull the eyecup straight up.

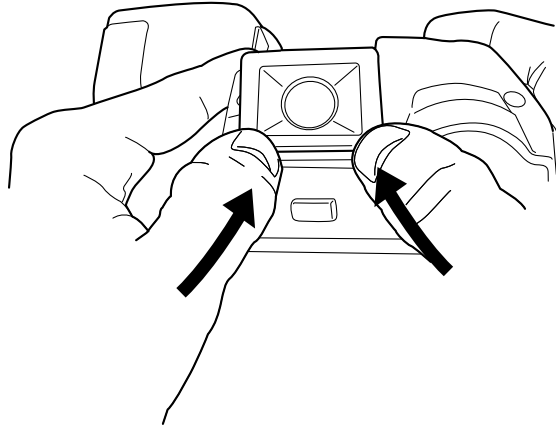

2. Note the grooves on the eyecup mount on the camera and on the new eyecup.

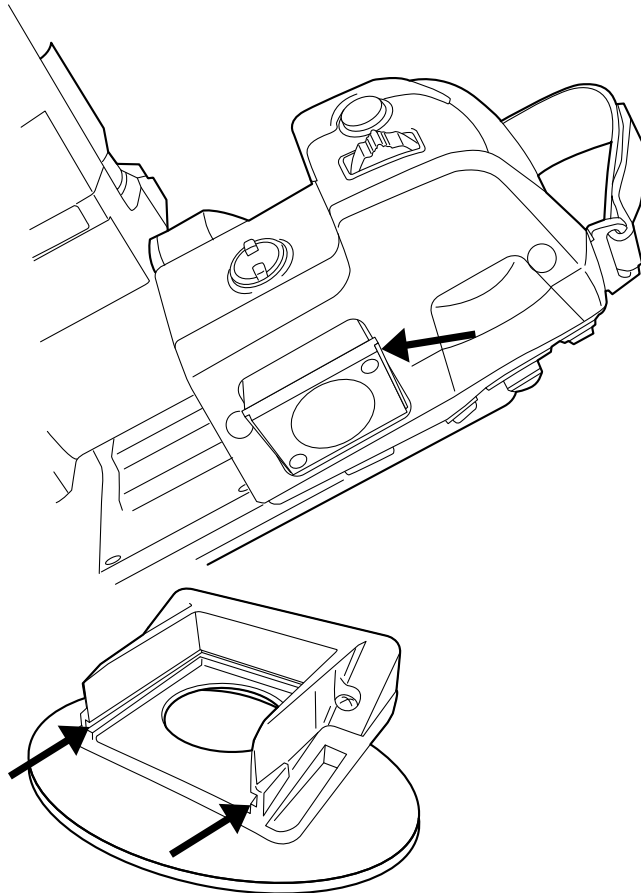

3. Align the new eyecup with the eyecup mount on the camera.

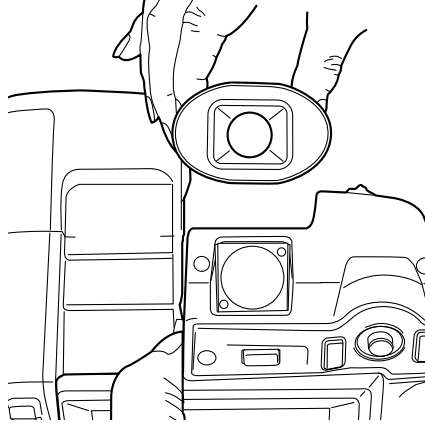

4. Carefully slide the eyecup into position.

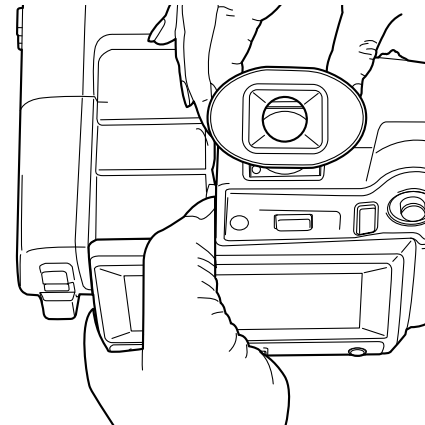

13.14 Using the camera lamp as a flash

13.14.1 General

The camera lamp can be used as a flash for the digital camera. When the flash function is activated, the camera lamp will flash when an image is saved by pushing the Autofocus/Save button fully down.

13.14.2 Procedure

Follow this procedure:

1. Push the joystick to display the menu system.
2. Use the joystick to go to  (*Settings*).
3. Push the joystick to display the *Settings* menu.
4. Select *Device settings* and push the joystick.
5. Select *Set up camera* and push the joystick.
6. Select *Lamp & laser* and push the joystick.
7. Select *Enable lamp & laser*. If the check box is unchecked, push the joystick to enable the camera lamp.
8. Select *Use lamp as flash*. If the check box is unchecked, push the joystick to activate the flash function.

14.1 Saving an image

14.1.1 General

You can save images to a memory card.

The camera saves an image file including all thermal and visual information. This means that you can open an image file at a later stage and, for example, select another image mode, apply color alarms, and add measurement tools.

The image jpg file is fully radiometric and saved lossless, which enables full post-processing in FLIR Tools. There is also a regular jpg part (lossy) for convenient viewing in non-FLIR Systems software (Explorer).

14.1.2 About UltraMax

UltraMax is an image enhancement feature that increases the image resolution and lowers the noise, making small objects easier to see and measure. An UltraMax image is twice as wide and high as an ordinary image.

When an UltraMax image is captured by the camera, several ordinary images are saved in the same file. Capturing all the images can take up to 1 second. To fully utilize UltraMax, the images need to be slightly different, which can be accomplished by a slight movement of the camera. You should hold the camera firmly in your hands (do not put it on a tripod), which will make these images vary just a little during the capture. Correct focus, a high-contrast scene, and a non-moving target are other conditions that help to achieve a good-quality UltraMax image.

At the moment, only FLIR Tools has the ability to process UltraMax images. Other FLIR software will treat the image as a regular image.

14.1.3 Image capacity

The capacity of a 4 GB memory card is theoretically 3600 images (with no annotations).

14.1.4 Naming convention



The naming convention for image files is FLIRxxxx.jpg, where xxxx is a unique counter.

14.1.5 Procedure

Follow this procedure:

1. To save an image, push the Autofocus/Save button fully down.

Note

- Depending on the settings in  (*Settings*) > *Save options*, the following may happen:
 - A preview image is displayed before the image is saved.
 - An annotation tool or the annotation menu is displayed when the image has been saved.
- To configure UltraMax, select  (*Settings*) > *Save options* > *Image resolution = UltraMax*.
- The camera can be configured to also save the visual image as a separate file. Select  (*Settings*) > *Save options* > *Photo as separate JPEG = On*.

14.2 Previewing an image



14.2.1 General

You can preview an image before you save it. This enables you to see if the image contains the information you want before you save it. You can also adjust and edit the image.

Note The camera must be configured to display a preview image before saving. Select  (Settings) > Save options > Preview image before saving = On.

14.2.2 Procedure

Follow this procedure:

1. To preview an image, push the Autofocus/Save button fully down. This displays the preview.
2. Manual image adjust mode is now active, and the status icon  is displayed. For image adjustment instructions, see 14.5 *Adjusting an infrared image*, page 36.
3. To edit the image, push the joystick. This displays a context menu. For editing instructions, see 14.4 *Editing a saved image*, page 35.
4. Do one of the following:
 - To save the image, push the Autofocus/Save button fully down.
 - To exit preview mode without saving, push the Back button .



14.3 Opening a saved image

14.3.1 General

When you save an image, the image file is stored on the memory card. To display the image again, open it from the image archive.

14.3.2 Procedure

Follow this procedure:

1. Push the Image archive button .
2. Move the joystick up/down or left/right to select the image you want to view.
3. Push the joystick. This will display the image at full size.
4. Do one or more of the following:
 - To switch between an infrared image and a visual image, move the joystick up/down.
 - To view the previous/next image, move the joystick left/right.
 - To edit the image, add annotations, display information, or delete the image, push the joystick. This displays a context menu.
 - To return to the image archive overview, push the Back button .

14.4 Editing a saved image

14.4.1 General

You can edit a saved image. You can also edit an image in preview mode.