

1.6 User Manual

UDI RC

LARK FPV

2.4Ghz High Performance Quadcopter // Live Streaming Video // Record Video or Still Images // 4.3 Inch LCD Display Screen



Notice:

1. RC drone is not a toy and it is only suitable for more than 14 years old people.
2. Please choose spacious field to use this drone and keep away from obstacle, crowd, power lines etc.
3. Never operate the drone in terrible weather, such as strong wind, thunder rainy, foggy etc.
4. Never disassemble or change the drone randomly. If you have any questions about use, operation, repair etc., please contact the local distributor.
5. The drone inside is consisted of precise electronic components. Humidity or water vapor may damage electronic components and cause accident.
6. The RC drone is made of metal, fiber, plastic, electronic components etc. Keep away from heat and sunshine to avoid distortion and damage.
7. Keep your finger and body away from rotating blades, which may cause serious injury and damage.
8. Please obey local laws and regulations when using this product and never use for illegal purpose.

Name of Parts

1. Drone

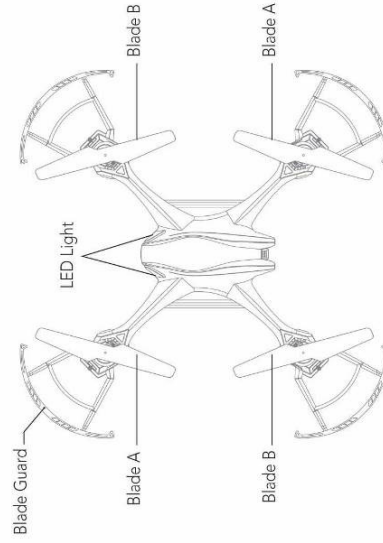
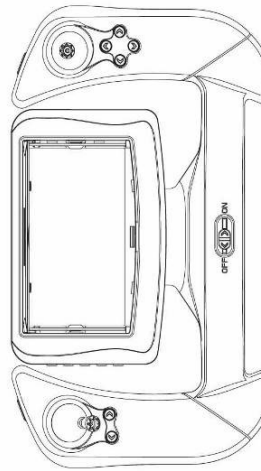

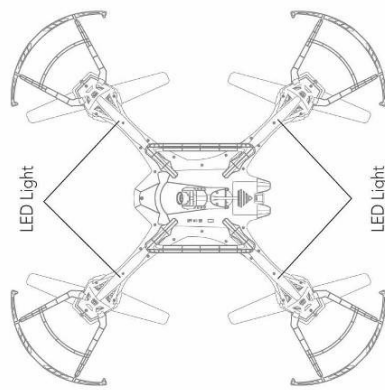

LED Light

LED Light

2. Transmitter

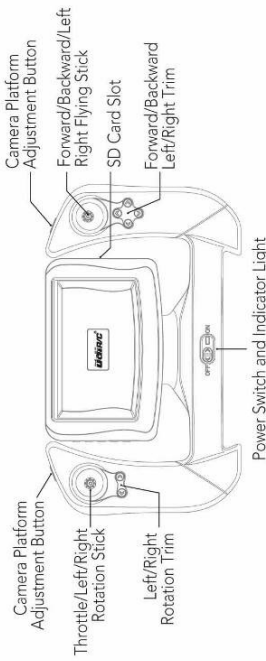

Note: Camera Platform Adjustment Button only available when the drone is equipped with camera platform equipment.

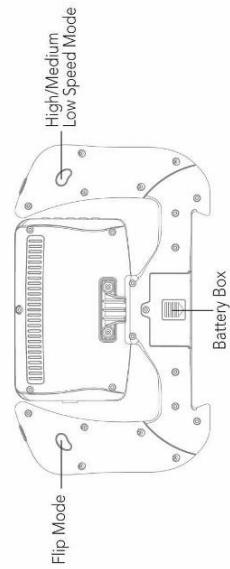

Picture for Base Leg Installation

Insert the base leg to the fuselage hold correctly in accordance with the picture.
 Note: The base leg must closely fitting with the fuselage, or the base leg may not stand firm on the ground, which may have an effect on the flight stability.

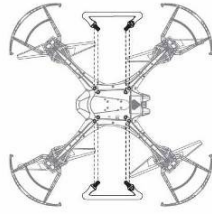

Blade Guard Installation

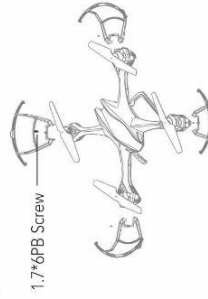

1.7*6PB Screw

1. Install the blade guards in the end of the drone arms and fix them by tighten the supplied screws.
2. Remove the blade guards for lighter weight to obtain additional motivation improvement and more flying time.

Flying Preparation

1. Charging Method for Battery

CHARGING METHODS — USB

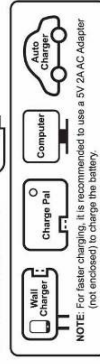

2. Battery Charging Instruction

- * When charging the drone battery, the USB indicator light is red and turns to green when fully charged.
- * When charging the transmitter battery, the USB indicator light is red and turns to green when fully charged.
- * The charging time of the drone battery is about 150minutes, while the charging time of the transmitter battery is about 70minutes.
- * If the transmitter battery is low when flying, the transmitter will issue constantly sound of "di---di" to alarm. At this time please land the drone as soon as possible and replace the battery, or the drone may out of control.
- * If the drone battery is low when flying, the drone LED light flashes and the transmitter will issue constantly sound of "di-di" to alarm. At this time please land the drone as soon as possible, or the drone may crash suddenly for low battery.

3. Notice for Battery

- * Turn off the drone switch first when finished flying and then take out the battery.
- * Charge the battery after the battery surface cooling down.
- * Keep away from heat and put the battery in dry place when the battery is not being used for a long time.
- * Never put the battery with metal product to avoid short circle.
- * Stop using the battery if the battery swell up, damaged or seriously heating etc.
- * Put the battery and charger on the ground and keep away from flammable when charging to avoid accident.

LiPo Battery Disposal & Recycling

 Wasted batteries must not be placed with household trash.
 Please contact local environmental or waste agency or the
 supplier of your model or your nearest Li-Po battery recycling center.

Flying Operation:

1. Turn on the transmitter switch and its indicator light starts to flash quickly. Push the left Throttle Stick to utmost and then to the lowest position (see Picture 1-2). The indicator light flashes slowly, which indicates the transmitter enters code pairing search.

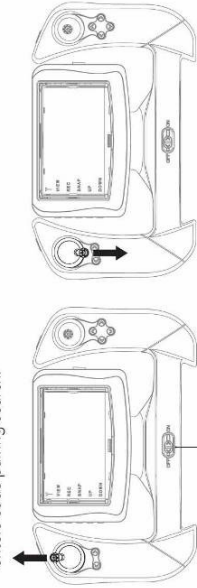

Power Switch

Picture 1

Picture 2

2. Press the battery box buckle at the tail of the drone and then pull it out.

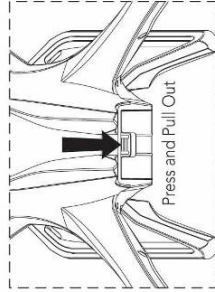

3. Connect the battery plug with the drone plug.

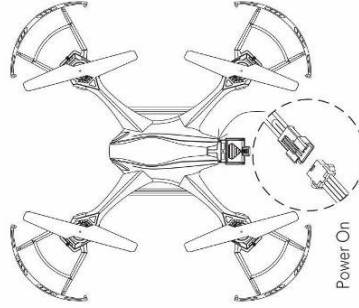

4. Insert the micro SD card to the camera slot of the drone bottom and then turn on the power switch and the LED light starts to flash. Put the drone on the horizontal position to calibrate the gyro. The transmitter issues sound of "di do di" about three seconds later, which indicates successful code pairing and the LED light keeps bright.

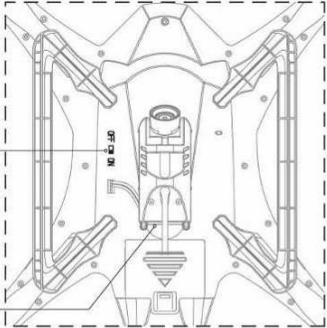

2. Turn on the power switch

1. Insert the card to the slot

5. Keep the throttle stick on the lowest position and push the right stick to bottom right (see Picture 3). The drone LED light flashes quickly and the drone is calibrating. Later the LED light keeps bright, which indicates successful calibration.

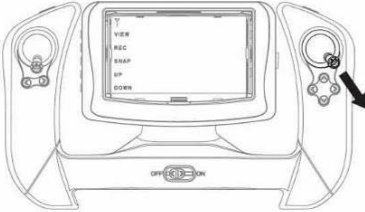

Picture 3

Operation Instruction of Camera

Pairing operation of camera and transmitter



Press "UP" button for 6 seconds

7

1. Press "UP" button for about 6 seconds till the pairing menu appears.

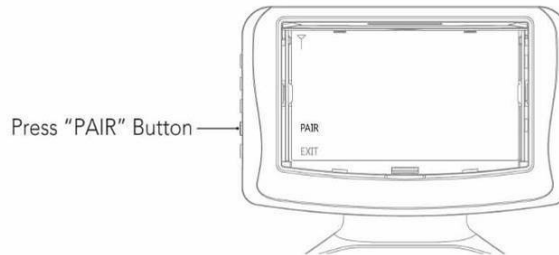

2. Press "PAIR" button and a 5 seconds countdown appears on the screen and then enters pairing search. The video menu will appear after successful pairing. Meanwhile, the transmitter will remember its paired camera automatically. Next time you need not to pair again unless you need to pair the transmitter with other camera. Restart the transmitter and repeat step 1 and step 2.

Notice: Never touch the throttle stick in the progress of pairing or screen adjustment to avoid the drone up flying suddenly and cause accident.

Operation of Video Recording

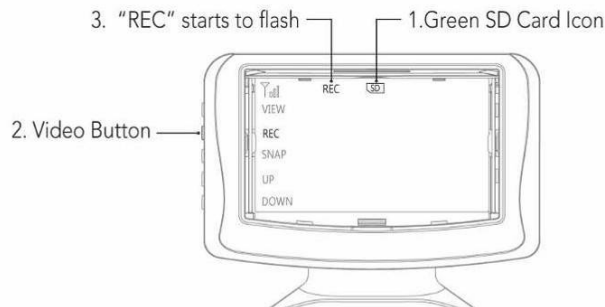

After successful pairing, the screen will enter video menu and show a green SD card icon at the top, which indicates the SD card had inserted to the camera (or the SD card icon will appear in red and flash if the card fail to insert to the camera). To record video, press the "REC" button on the side of the transmitter screen to start recording. At the same time, the "REC" icon will flash to show that video is being recorded. Press the "REC" button again to stop recording and the video will store in the SD card.

Tip: The screen will show a "FULL" icon if the card is full storage and no more video can be stored in the card.

Operation for Picture Taking

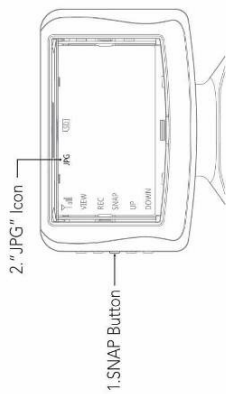

Press SNAP Button and the "JPG" Icon will flash briefly, and then the picture will be stored in the SD card automatically.

Adjust the Screen Brightness

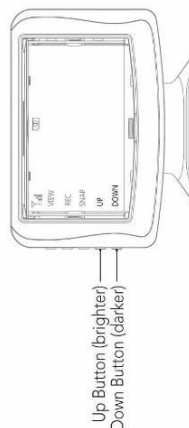

Press "UP" or "DOWN" button to adjust the screen brightness.

View Stored Video and Picture

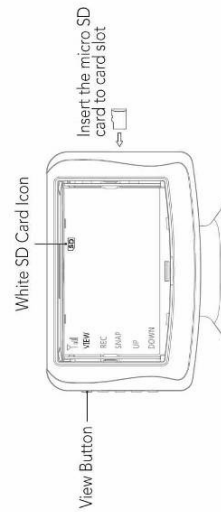

Take out the micro SD card from the camera and insert to the card slot in the right side of the display screen. A white SD card icon will show on the screen. Press "VIEW" Button to view the file.

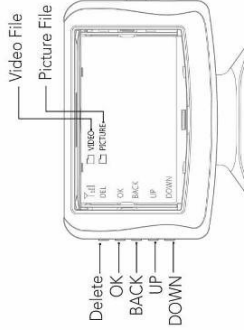

Press "UP" or "DOWN" button to choose a video file or picture file and then press "OK" button to select a file. Press "UP" or "DOWN" button to choose a video or picture, and then press "OK" button to play.
Note: Except above view method, you can insert the SD card to a card reader and then connect it with a computer USB port to play the video or picture.

Delete File

Press "DEL" button to delete file directly when viewing the video or picture. Or press "UP" or "Down" button to select a video or picture after entering the video or picture file, and the screen will appear DEL XXXXX ? . Choose "YES" by "Up" or "DOWN" button and then press "OK" button to delete the file. Or choose "NO" then press "OK" to return.

Flying Control

1. Up/Down Flying Control

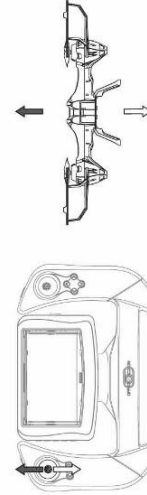

Push the Throttle Stick to up and the drone goes up as well; Push the throttle stick to down and the drone goes down as well.

Note: Push the throttle stick slowly at first time flying in case of suddenly rising of the drone and cause accident.

Warning: Never turn off the transmitter power when flying, which may cause the drone out of control and cause accident.

2. Left/Right Rotation Flying Control



Push the Left Stick to left or right and the drone rotates to corresponding rudder.

3. Left / Right Side Flying Control

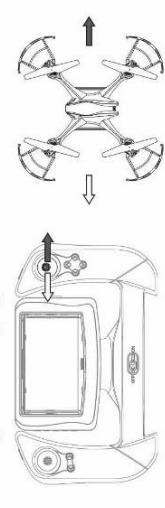

Push the Right Stick to left or right and the drone flies to corresponding rudder.

4. Forward / Backward Flying Control

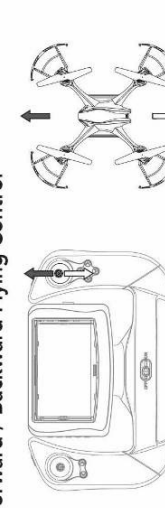

Push the Right Stick to forward or backward and the drone flies to corresponding rudder.

5. Left/Right Rotation Trim



Adjust Right Rotation Trim till balance if the drone rotates to left automatically, and adjust Left Rotation Trim if the drone rotates to right.

6. Left/Right Flying Trim

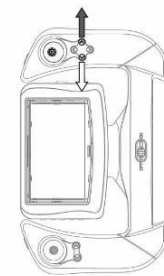

Adjust the Right Trim till balance if the drone drifts to left side automatically, and adjust the Left Trim till balance if the drone drifts to right side.

7. Forward/Backward Trim



Adjust the Backward Trim till balance if the drone drifts to forward automatically, and adjust Forward Trim if the drone drifts to backward.

High/Medium/Low Speed Mode and Flip Mode

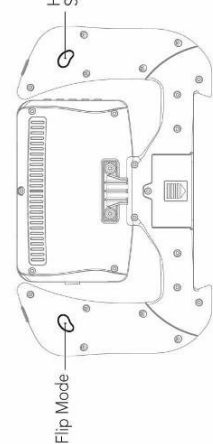

1. High/Medium/Low Speed Mode Operation
Press High/Medium/Low Speed Mode button of the transmitter. The transmitter will beep once for Low Speed Mode, twice for Medium Speed Mode, and three times for High Speed Mode.

2. Flip Mode Operation

Press Flip Mode button and the transmitter will issue constantly sounds of beep and enter flip mode. Push right stick to any direction of up/down/left/right and then release, and the drone will do 360° flip in corresponding direction.
 Tip: The drone LED light will flash and the transmitter will issue constantly sound of "di-di" low battery alarm. The flip mode will shut down automatically.

Warning: Flying field must spacious enough and the flying height must at least 5M when doing a flip, or danger may occur.

Installation and Replacement for Motor and Blade

1. Blade Replacement

Please replace the damaged blade with attached spare blades as below steps.

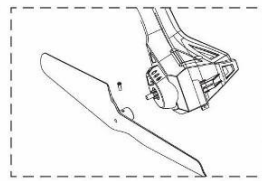

Remove the screw from the blade and replace with a new blade then fix the screw.

2. Motor Replacement

Replace the damaged or performance degradation motor as below steps.

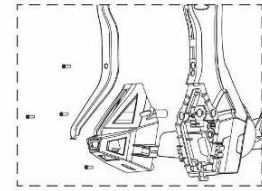

1. Remove the LED shade and four screws of the motor holder.

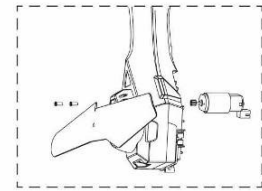

2. Remove two motor screws and replace it with new motor.

Spare Parts

For convenience, the spare parts are listed for you to choose, which can be purchased from the local distributor.

FCC Statement:

This device complies with part 15 of the FCC Rules. Operation is subject to the following two conditions:(1) This device may not cause harmful interference, and(2) this device must accept any interference received, including interference that may cause undesired operation.

Changes or modifications not expressly approved by the party responsible for compliance could void the user's authority to operate the equipment.

NOTE: This equipment has been tested and found to comply with the limits for a Class B digital device, pursuant to part 15 of the FCC Rules. These limits are designed to provide reasonable protection against harmful interference in a residential installation. This equipment generates, uses and can radiate radio frequency energy and, if not installed and used in accordance with the instructions, may cause harmful interference to radio communications. However, there is no guarantee that interference will not occur in a particular installation. If this equipment does cause harmful interference to radio or television reception, which can be determined by turning the equipment off and on, the user is encouraged to try to correct the interference by one or more of the following measures:

- Reorient or relocate the receiving antenna.
- Increase the separation between the equipment and receiver.
- Connect the equipment into an outlet on a circuit different from that to which the receiver is connected.
- Consult the dealer or an experienced radio/TV technician for help.