



TESTING LABORATORY
CERTIFICATE#4323.01



FCC PART 15B MEASUREMENT AND TEST REPORT

For

Micron Electronics LLC.

1001 Yamato Road, Suite 400, Boca Raton, Florida 33431 United States

FCC ID: ZKQ-AGPS4GA

Report Type: Original Report	Product Type: Tracker
Test Engineer: Lee Li	Lee Li
Report Number: RSHA190517002-00A	
Report Date: 2019-06-04 Ray Wang	Ray Wang
Reviewed By: EMC Leader	
Prepared By: Bay Area Compliance Laboratories Corp. (Kunshan) No.248 Chenghu Road, Kunshan, Jiangsu province, China Tel: +86-0512-86175000 Fax: +86-0512-88934268 www.baclcorp.com.cn	

Note: This test report is prepared for the customer shown above and for the device described herein. It may not be duplicated or used in part without prior written consent from Bay Area Compliance Laboratories Corp. This report is valid only with a valid digital signature. The digital signature may be available only under the Adobe software above version 7.0.

TABLE OF CONTENTS

GENERAL INFORMATION.....	3
PRODUCT DESCRIPTION FOR EQUIPMENT UNDER TEST (EUT)	3
OBJECTIVE	3
RELATED SUBMITTAL(S)/GRANT(S).....	3
TEST METHODOLOGY	3
TEST FACILITY	3
SYSTEM TEST CONFIGURATION.....	4
JUSTIFICATION	4
EUT EXERCISE SOFTWARE	4
SPECIAL ACCESSORIES.....	4
EQUIPMENT MODIFICATIONS	4
SUPPORT EQUIPMENT LIST AND DETAILS	4
BLOCK DIAGRAM OF RADIATED TEST SETUP.....	5
SUMMARY OF TEST RESULTS	6
FCC §15.107 –CONDUCTED EMISSIONS	7
APPLICABLE STANDARD	7
MEASUREMENT UNCERTAINTY.....	7
EUT SETUP.....	7
EMI TEST RECEIVER SETUP.....	8
TEST PROCEDURE	8
TEST EQUIPMENT LIST AND DETAILS.....	8
CORRECTED FACTOR & MARGIN CALCULATION	8
TEST DATA	9
FCC §15.109 - RADIATED EMISSIONS	11
APPLICABLE STANDARD	11
MEASUREMENT UNCERTAINTY.....	11
EUT SETUP	11
EMI TEST RECEIVER SETUP.....	12
TEST PROCEDURE	12
TEST EQUIPMENT LIST AND DETAILS.....	13
CORRECTED AMPLITUDE & MARGIN CALCULATION	13
TEST DATA	13

GENERAL INFORMATION

Product Description for Equipment under Test (EUT)

Applicant	Micron Electronics LLC.
Test Model	AGPS 1000
Product	Tracker
Rate Voltage	DC 3.8V by Battery and DC 5V charging by Adapter
Highest Operation Frequency	2480MHz
Dimension	78mm(L)*45mm(W)*22.5mm(H)

Adapter Information:

Model: JT-H050200

Input: AC100-240V 50/60Hz 0.5A

Output: 5V, 2A

**All measurement and test data in this report was gathered from production sample serial number: 20190517002. (Assigned by the BACL. The EUT supplied by the applicant was received on 2019-05-17)*

Objective

This report is prepared on behalf of *Micron Electronics LLC.* in accordance with Part 2-Subpart J, and Part 15-Subparts A and B of the Federal Communication Commission's rules.

The objective of the manufacturer is to determine the compliance of EUT with FCC Part 15, Class B device.

Related Submittal(s)/Grant(s)

FCC Part 15.247 DTS Submittal with FCC ID: ZKQ-AGPS4GA

Test Methodology

All measurements contained in this report were conducted with ANSI C63.4-2014, American National Standard for Methods of Measurement of Radio-Noise Emissions from Low-Voltage Electrical and Electronic Equipment in the range of 9 kHz to 40 GHz.

All radiated and conducted emissions measurement was performed at Bay Area Compliance Laboratories Corp. (Kunshan). The radiated testing was performed at an antenna-to-EUT distance of 3 meters.

Test Facility

The Test site used by Bay Area Compliance Laboratories Corp. (Kunshan) to collect test data is located on the No.248 Chenghu Road, Kunshan, Jiangsu province, China.

Bay Area Compliance Laboratories Corp. (Kunshan) Lab is accredited to ISO/IEC 17025 by A2LA (Lab code: 4323.01), the FCC designation No. CN1185 under the FCC KDB 974614 D01 and CAB identifier CN0004 under the ISED requirement. The facility also complies with the radiated and AC line conducted test site criteria set forth in ANSI C63.4-2014.

SYSTEM TEST CONFIGURATION

Justification

The system was configured for testing in a typical fashion (as normally used by a typical user).

Test mode: Charging & GPS on

EUT Exercise Software

No exercise software was used to test.

Special Accessories

No special accessory was used.

Equipment Modifications

No modification was made to the EUT tested.

Support Equipment List and Details

Manufacturer	Description	Model	Serial Number
/	SIM Card	/	/
Rohde & Schwarz	WIDEBAND RADIO COMMUNICATION TESTER	CMW500	116218

External I/O Cable

Cable Description	Length (m)	From/Port	To
Power Cable	1.0	EUT	Adapter

Block Diagram of Radiated Test Setup

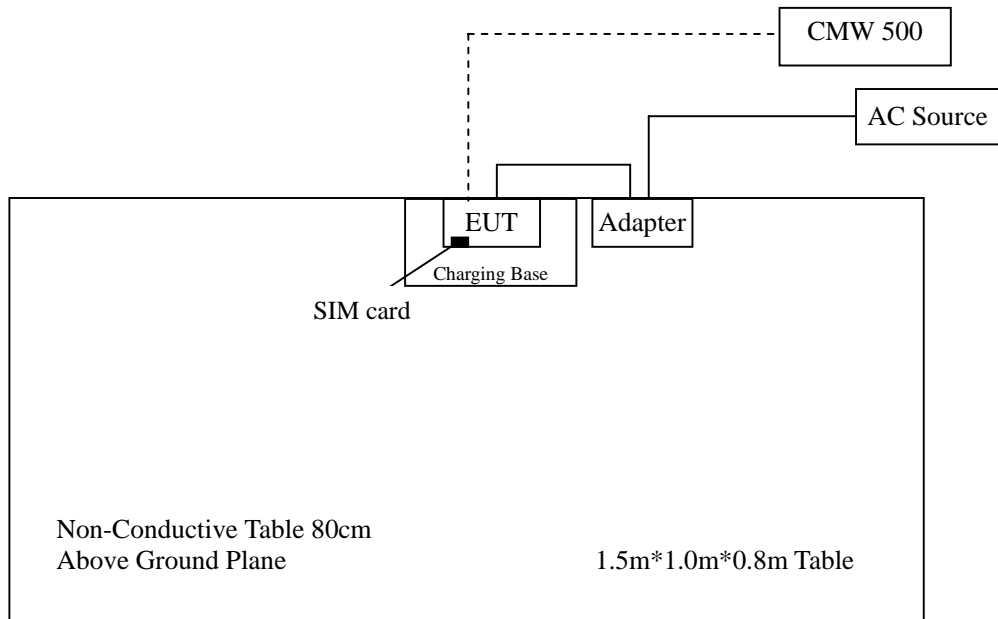

SUMMARY OF TEST RESULTS

FCC Rules	Description of Test	Results
§15.107	Conducted Emissions	Compliant
§15.109	Radiated Emissions	Compliant

FCC §15.107 –CONDUCTED EMISSIONS

Applicable Standard

According to FCC§15.107

Measurement Uncertainty

Input quantities to be considered for conducted disturbance measurements may be receiver reading, attenuation of the connection between LISN and receiver, LISN voltage division factor, LISN VDF frequency interpolation and receiver related input quantities, etc.

Item		Measurement Uncertainty	U_{cispr}
AMN	150kHz~30MHz	3.19 dB	3.4 dB

Otherwise required by the applicant or Product Regulations, Decision Rule in this report did not consider the uncertainty.

EUT Setup

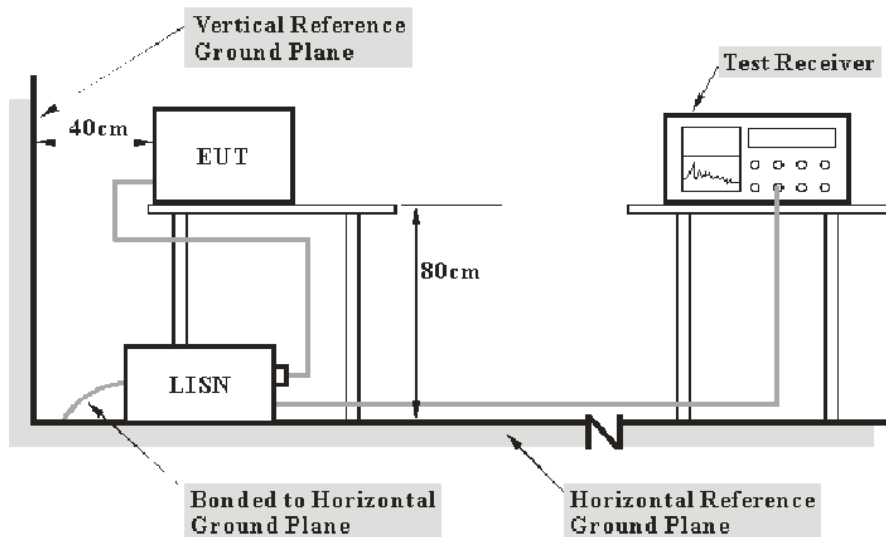

- Note: 1. Support units were connected to second LISN.
 2. Both of LISNs (AMN) 80 cm from EUT and at the least 80 cm from other units and other metal planes support units.

The measurement procedure of EUT setup is according with ANSI C63.4-2014. The related limit was specified in FCC Part 15.107 Class B.

The external I/O cables were draped along the test table and formed a bundle 30 to 40 cm long in the middle.

The spacing between the peripherals was 10 cm.

The test voltage is AC 120V/60Hz.

EMI Test Receiver Setup

The EMI test receiver was set to investigate the spectrum from 150 kHz to 30 MHz

During the conducted emission test, the EMI test receiver was set with the following configurations:

Frequency Range	IF B/W
150 kHz – 30 MHz	9 kHz

Test Procedure

During the conducted emission test, the EUT was connected to the outlet of the LISN.

Maximizing procedure was performed on the six (6) highest emissions of the EUT.

All final data was recorded in the Quasi-peak and average detection mode.

Test Equipment List and Details

Manufacturer	Description	Model	Serial Number	Calibration Date	Calibration Due Date
Rohde & Schwarz	EMI Test Receiver	ESCS30	834115/007	2018-11-12	2019-11-11
ROHDE&SCHWARZ	LISN	ENV216	3560655016	2018-11-12	2019-11-11
BACL	BACL-EMC	V1.0	CE001	--	--
MICRO-COAX	Coaxial Cable	Cable-6	006	2018-09-08	2019-09-07

* **Statement of Traceability:** Bay Area Compliance Laboratories Corp. (Kunshan) attests that all calibrations have been performed in accordance to requirements that traceable to National Primary Standards and International System of Units (SI).

Corrected Factor & Margin Calculation

The Corrected factor is calculated by adding LISN VDF (Voltage Division Factor), Cable Loss and Transient Limiter Attenuation. The basic equation is as follows:

$$\text{Correction Amplitude} = \text{Meter Reading} + \text{VDF} + \text{Cable Loss} + \text{Transient Limiter Attenuation}$$

The “**Margin**” column of the following data tables indicates the degree of compliance with the applicable limit. For example, a margin of 7dB means the emission is 7 dB below the limit. The equation for margin calculation is as follows:

$$\text{Margin} = \text{Limit} - \text{Corrected Amplitude}$$

Test Data

Environmental Conditions

Temperature:	24°C
Relative Humidity:	50 %
ATM Pressure:	101.0 kPa

The testing was performed by Lee Li on 2019-05-28.

Test mode: Charging & GPS on

1) Line:

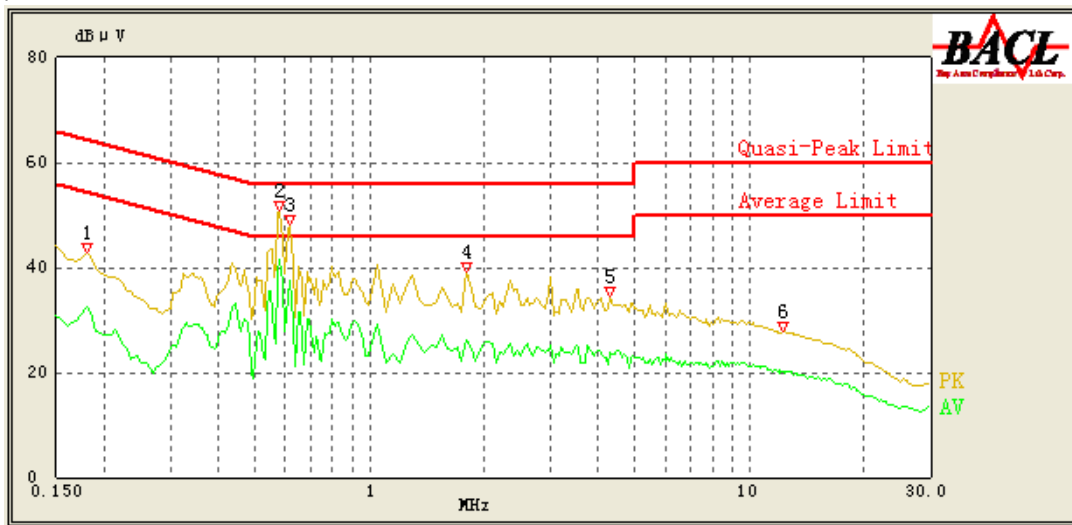

No.	Frequency (MHz)	Reading (dBμV)	Correction (dB)	Limit (dBμV)	Margin (dB)	Detector (PK/AV/QP)
1	0.180	42.70	16.03	64.47	21.77	QP
	0.180	32.58	16.03	54.47	21.89	AV
2	0.580	50.84	16.03	56.00	5.16	QP
	0.580	41.66	16.03	46.00	4.34	AV
3	0.615	48.13	16.01	56.00	7.87	QP
	0.615	37.54	16.01	46.00	8.46	AV
4	1.800	39.03	15.86	56.00	16.97	QP
	1.800	26.04	15.86	46.00	19.96	AV
5	4.300	34.63	15.85	56.00	21.37	QP
	4.300	23.99	15.85	46.00	22.01	AV
6	12.200	27.73	16.13	60.00	32.27	QP
	12.350	19.95	16.13	50.00	30.05	AV

Neutral:

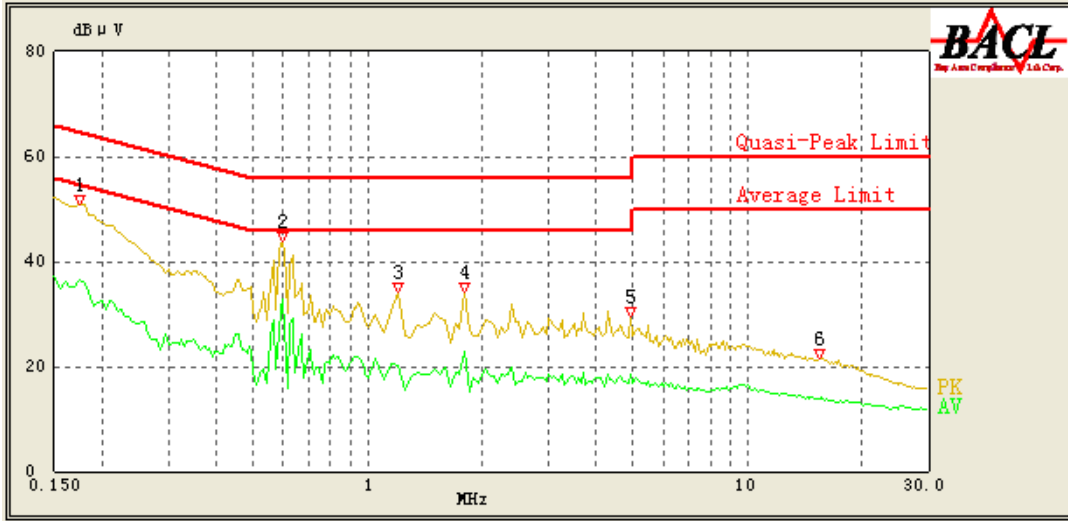

No.	Frequency (MHz)	Reading (dBμV)	Correction (dB)	Limit (dBμV)	Margin (dB)	Detector (PK/AV/QP)
1	0.175	50.70	16.03	64.71	14.01	QP
	0.175	36.54	16.03	54.71	18.17	AV
2	0.600	43.95	16.01	56.00	12.05	QP
	0.600	32.86	16.01	46.00	13.14	AV
3	1.200	34.22	15.87	56.00	21.78	QP
	1.200	20.20	15.87	46.00	25.80	AV
4	1.800	34.03	15.86	56.00	21.97	QP
	1.800	22.74	15.86	46.00	23.26	AV
5	4.900	29.36	15.85	56.00	26.64	QP
	4.900	18.39	15.85	46.00	27.61	AV
6	15.550	21.65	16.24	60.00	38.35	QP
	15.650	14.16	16.24	50.00	35.84	AV

FCC §15.109 - RADIATED EMISSIONS

Applicable Standard

FCC §15.109

Measurement Uncertainty

All measurements involve certain levels of uncertainties, especially in field of EMC. The factors contributing to uncertainties are spectrum analyzer, cable loss, antenna factor calibration, antenna directivity, antenna factor variation with height, antenna phase center variation, antenna factor frequency interpolation, measurement distance variation, site imperfections, mismatch (average), and system repeatability.

Item	Measurement Uncertainty	U_{cispr}
Radiated Emission	30MHz~1GHz	6.11dB
	1GHz~6GHz	4.45dB
	6 GHz ~18 GHz	5.23dB

Otherwise required by the applicant or Product Regulations, Decision Rule in this report did not consider the uncertainty.

EUT Setup

Below 1GHz:

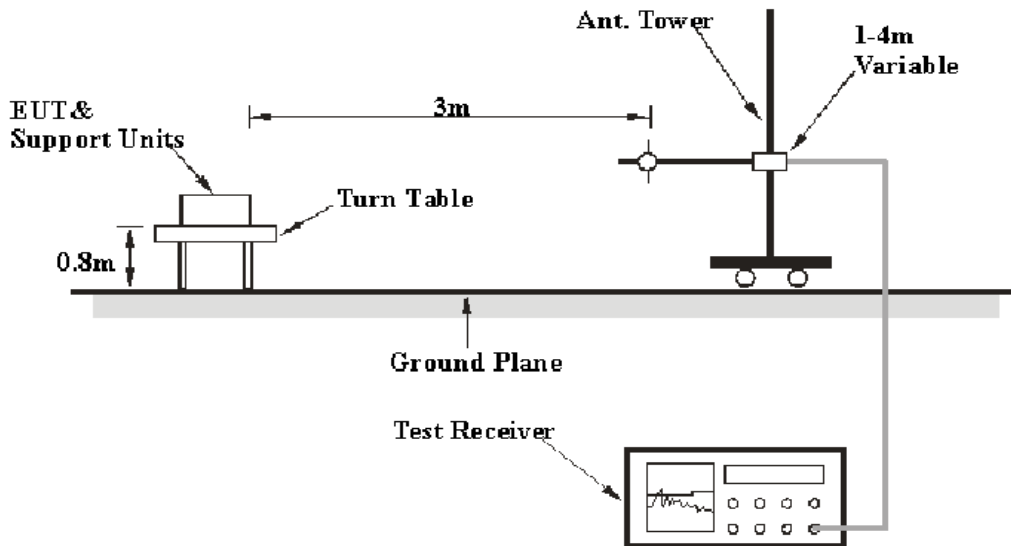

Above 1GHz:

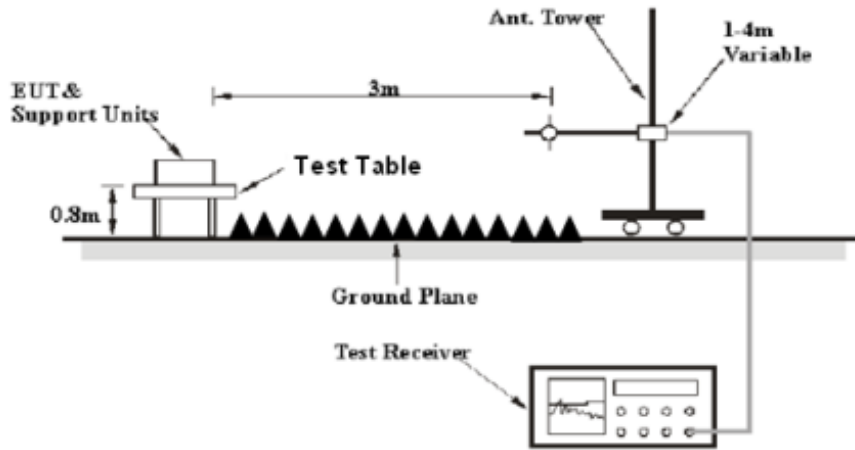

The radiated emission tests were performed in the 3 meters chamber test site, using the setup accordance with the ANSI C63.4-2014. The specification used was the FCC Part 15.109 Class B limits.

The external I/O cables were draped along the test table and formed a bundle 30 to 40 cm long in the middle.

The spacing between the peripherals was 10 cm.

EMI Test Receiver Setup

The system was investigated from 30 MHz to 18 GHz.

During the radiated emission test, the EMI test receiver was set with the following configurations:

Frequency Range	RBW	Video B/W	IF B/W	Detector
30MHz – 1000 MHz	120 kHz	300 kHz	120kHz	QP
Above 1 GHz	1MHz	3 MHz	/	Peak
	1MHz	3 MHz	1MHz	AVG

Test Procedure

Maximizing procedure was performed on the highest emissions to ensure that the EUT complied with all installation combinations.

All data was recorded in the Quasi-peak detector mode from 30 MHz to 1 GHz, Peak and average detection mode above 1 GHz.

Test Equipment List and Details

Manufacturer	Description	Model	Serial Number	Calibration Date	Calibration Due Date
Sonoma Instrument	Amplifier	310N	185700	2018-08-14	2019-08-13
Rohde & Schwarz	EMI Test Receiver	ESCI	100195	2018-11-12	2019-11-11
Sunol Sciences	Broadband Antenna	JB3	A060217	2016-12-26	2019-12-25
Champrotek	Chamber	Chamber A	T-KSEMC049	-	-
Champrotek	Chamber	Chamber B	T-KSEMC080	-	-
R&S	Auto test Software	EMC32	100361	-	-
ETS	Horn Antenna	3115	6229	2016-12-12	2019-12-11
Rohde & Schwarz	EMI Receiver	ESU40	100207	2018-08-27	2019-08-26
A.H.Systems, inc	Amplifier	2641-1	491	2019-02-20	2020-02-19
MICRO-COAX	Coaxial Cable	Cable-8	008	2018-08-15	2019-08-14
MICRO-COAX	Coaxial Cable	Cable-9	009	2018-08-15	2019-08-14
MICRO-COAX	Coaxial Cable	Cable-10	010	2018-08-15	2019-08-14
MICRO-COAX	Coaxial Cable	Cable-4	004	2018-08-15	2019-08-14
MICRO-COAX	Coaxial Cable	Cable-5	005	2018-08-15	2019-08-14

* **Statement of Traceability:** Bay Area Compliance Laboratories Corp. (Kunshan) attests that all calibrations have been performed in accordance to requirements that traceable to National Primary Standards and International System of Units (SI).

Corrected Amplitude & Margin Calculation

The Corrected Amplitude is calculated by adding the Antenna Factor and Cable Loss, and subtracting the Amplifier Gain from the Meter Reading. The basic equation is as follows:

$$\text{Corrected Amplitude} = \text{Meter Reading} + \text{Antenna Factor} + \text{Cable Loss} - \text{Amplifier Gain}$$

The “**Margin**” column of the following data tables indicates the degree of compliance with the applicable limit. For example, a margin of 7 dB means the emission is 7 dB below the limit. The equation for margin calculation is as follows:

$$\text{Margin} = \text{Limit} - \text{Corrected Amplitude}$$

Test Data

Environmental Conditions

Temperature:	24.2°C
Relative Humidity:	56 %
ATM Pressure:	101.0 kPa

The testing was performed by Lee Li on 2019-05-30.

Test mode: Charging & GPS on

1)30MHz ~ 1GHz

Full Spectrum

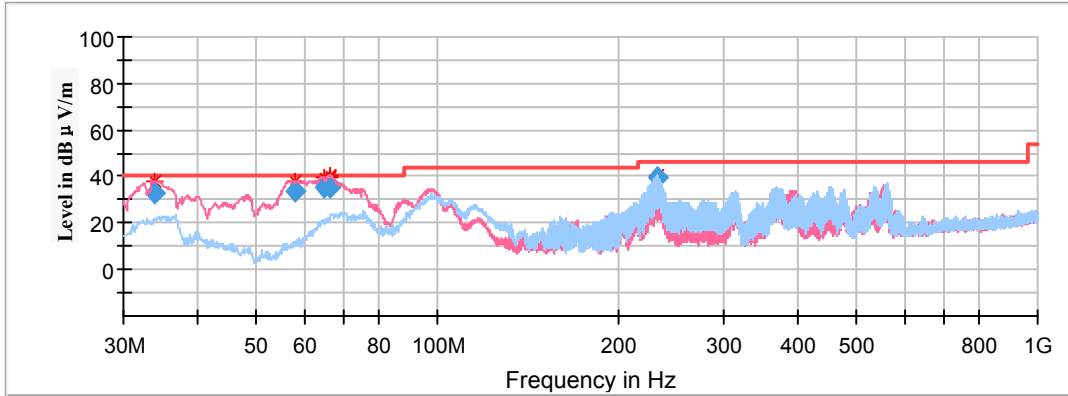

Frequency (MHz)	Quasi-Peak (dBμV/m)	Limit (dBμV/m)	Margin (dB)	Height (cm)	Pol	Azimuth (deg)	Corr. (dB/m)
33.823800	32.85	40.00	7.15	100.0	V	137.0	-13.6
57.725440	33.60	40.00	6.40	100.0	V	319.0	-23.2
64.815560	34.97	40.00	5.03	100.0	V	353.0	-23.3
66.188040	35.17	40.00	4.83	100.0	V	137.0	-23.3
66.268440	35.87	40.00	4.13	100.0	V	278.0	-23.3
233.360480	39.57	46.00	6.43	200.0	H	330.0	-17.9

Above 1 GHz:

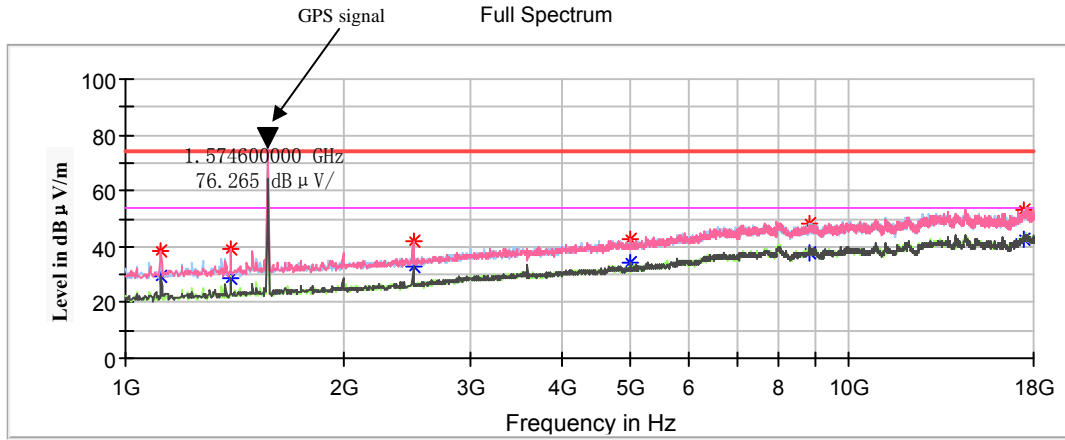

Frequency (MHz)	Max Peak (dBμV/m)	Average (dBμV/m)	Limit (dBμV/m)	Margin (dB)	Height (cm)	Pol	Azimuth (deg)	Corr. (dB/m)
1119.000000	---	29.49	54.00	24.51	100.0	V	207.0	-12.0
1119.000000	38.34	---	74.00	35.66	100.0	V	207.0	-12.0
1397.800000	---	28.94	54.00	25.06	200.0	V	214.0	-10.5
1397.800000	39.19	---	74.00	34.81	200.0	V	214.0	-10.5
2499.400000	---	32.77	54.00	21.23	100.0	V	339.0	-6.9
2499.400000	42.09	---	74.00	31.91	100.0	V	339.0	-6.9
4998.400000	---	34.22	54.00	19.78	100.0	H	252.0	-0.3
4998.400000	42.97	---	74.00	31.03	100.0	H	252.0	-0.3
8840.400000	---	37.88	54.00	16.12	200.0	H	180.0	7.2
8840.400000	48.05	---	74.00	25.95	200.0	H	180.0	7.2
17418.600000	---	42.44	54.00	11.56	200.0	H	264.0	13.9
17418.600000	53.32	---	74.00	20.68	200.0	H	264.0	13.9

*******END OF REPORT*******