

---

# Micro Keyboard

## User's Manual

2.4G wireless Micro keyboard with integrated touchpad



---

## Contents

<b>1.</b>	<b>WELCOME.....</b>	<b>3</b>
<b>2.</b>	<b>PRODUCT DESCRIPTION .....</b>	<b>3</b>
<b>3.</b>	<b>PRODUCT PACKAGE .....</b>	<b>3</b>
<b>4.</b>	<b>OVERVIEW .....</b>	<b>4</b>
<b>5.</b>	<b>HARDWARE INSTALLATION.....</b>	<b>5</b>
5.1.	Connecting your keyboard .....	5
5.2.	Recharging battery.....	6
<b>6.</b>	<b>USING YOUR KEYBOARD .....</b>	<b>7</b>
6.1.	Function overview .....	7
6.2.	LED indicator .....	7
6.3.	Power On /Off .....	8
6.4.	Using “Fn” key .....	8
6.5.	Using media control key.....	8
6.6.	Laser Pointer/flashlight function .....	9
6.7.	Backlight .....	9
6.8.	Sleeping and waking up .....	9
<b>7.</b>	<b>TIPS AND TROUBLESHOOTING .....</b>	<b>9</b>
<b>8.</b>	<b>IMPORTANT NOTES.....</b>	<b>10</b>
8.1.	FCC statement .....	10
8.2.	CE.....	10
<b>9.</b>	<b>APPENDIX SPECIFICATION .....</b>	<b>10</b>

---

## 1. Welcome

Thank you for purchasing the Mini wireless Keyboard!

This document contains instruction for installing and using the Keyboard.

## 2. Product description

The keyboard takes total control of your PC entertainments from the palm of your hands. Sit in sofa and enjoy movies and music, share photos, surf the web.

Convenient media controls make the perfect remote control for HTPC entertainment.

Backlight allows effortless text entry, even in low light.

Hi-grade Li-polymer battery recharge fast and last longer-----up to one month between charges.

While enjoying the movie in low light, the built-in flashlight will give you more convenience!

Style, comfort and portability, the keyboard will innovate your life.

## 3. Product package

The retail package contains:

Keyboard

User's manual

Power USB2.0 Cable

USB 2.4G receiver

Dummy USB receiver

If any items are damaged or missing, please contact your vendor.

## 4. Overview

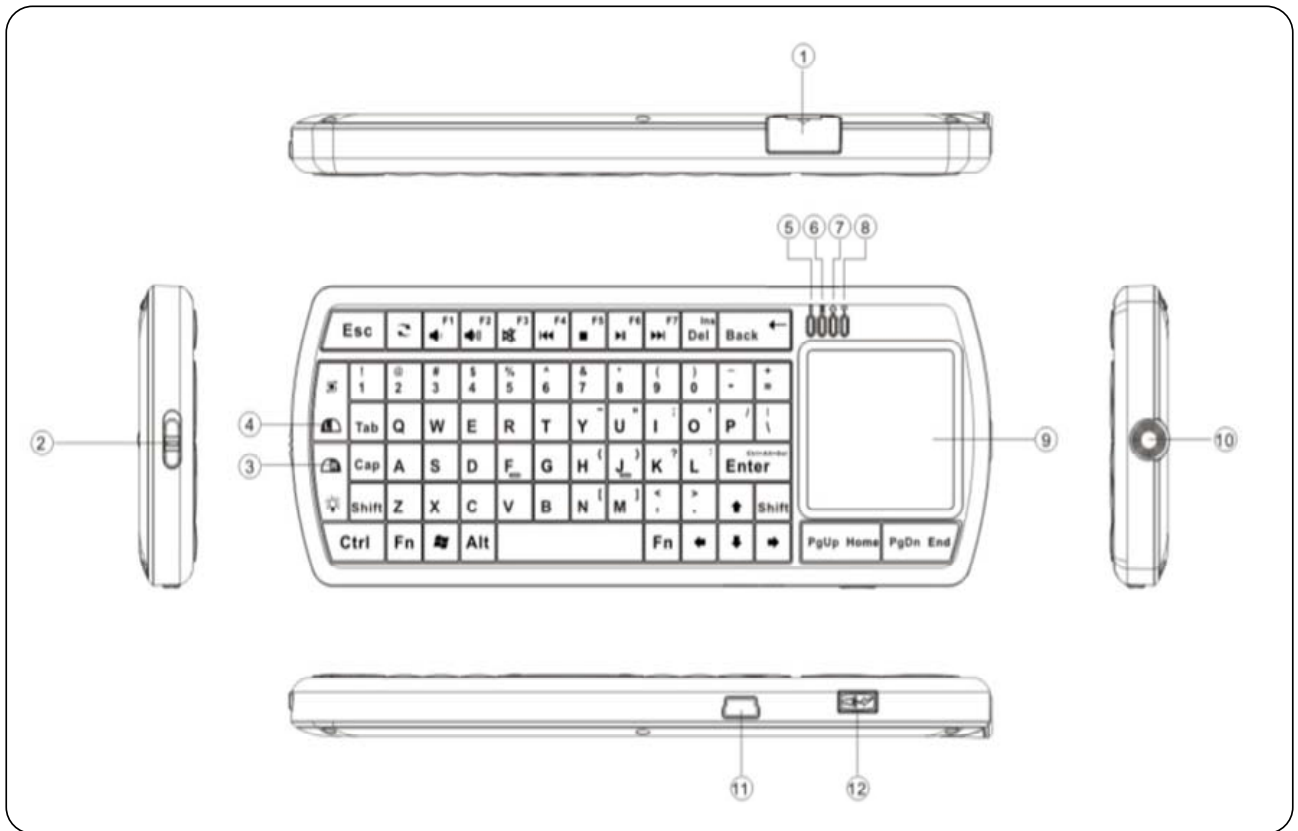

- ① RF receiver dongle
- ② Power Switch
- ③ Mouse right key
- ④ Mouse left key
- ⑤ Charging indicator
- ⑥ Battery low indicator
- ⑦ Caps Lock indicator
- ⑧ Wireless communication indicator
- ⑨ touchpad
- ⑩ Flashlight/laser pointer
- ⑪ Charging mini USB port
- ⑫ Switch of flashlight/laser pointer

---

## 5. Hardware Installation

### 5.1. Connecting your keyboard

5.1.1. Take out the USB dongle.

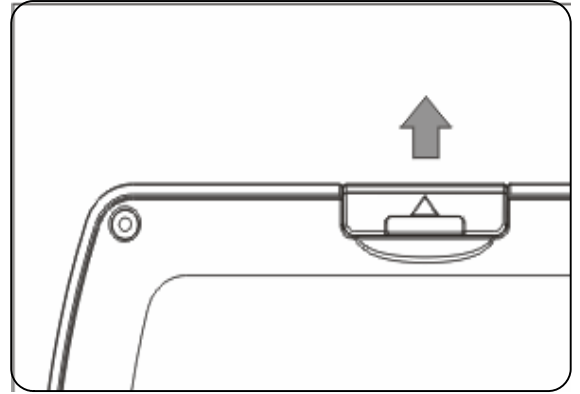

Figure. 1

5.1.2. Connect RF dongle

Plug the dongle into a USB port on your computer.

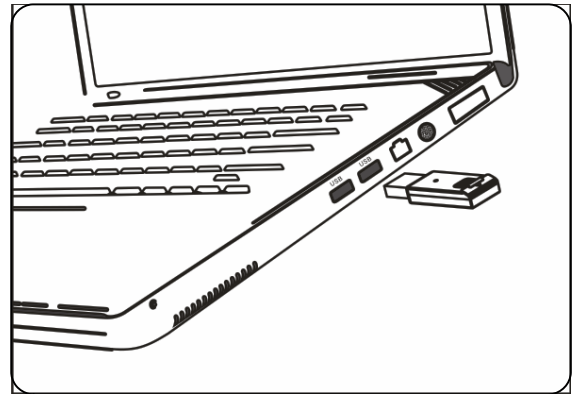

Figure. 2

5.1.3. Put the dummy RF receiver into the compartment inside the case.

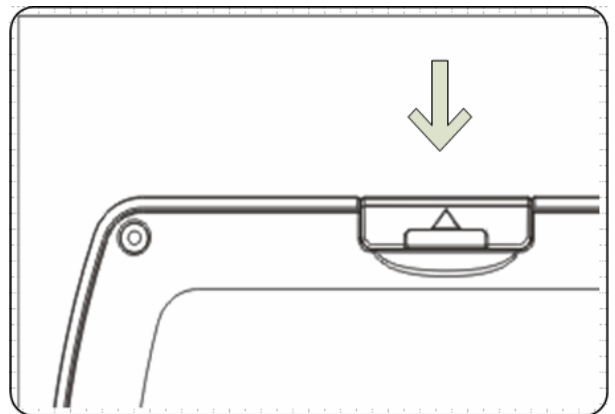

Figure. 3

---

#### 5.1.4. Move the power switch to ON.

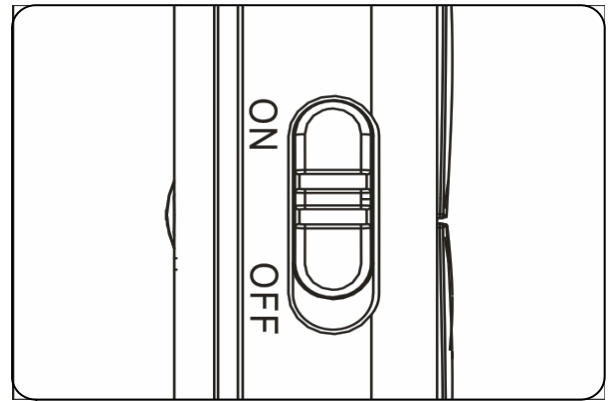

Figure. 4

#### 5.1.5. Congratulation

Congratulation! You have succeeded in installation the Keyboard, please enjoy your entertainment from anywhere!

### 5.2. Recharging battery

The device with Hi-grade Li-polymer battery, please use only approved data lines and chargers.

Plug the power USB cable into the power port on the side of the Keyboard.

Plug the power USB cable into the USB port on the side of PC to start charging the Hi-grade Li-polymer battery.

The red LED will turn on indicating charging status. A full charge is about four hours for up to one month of use. A ten-minute charge provides about one day of use.

When the charging is completed, the charging LED will turn off, please pull out the charging cable from AC power or computer, and then remove the charger cable form keyboard.

**Note:** Before the first time use of the keyboard, the battery must be fully charged.

When the capacity of battery is low, the low-voltage LED will flicker to warning till the battery exhausts.

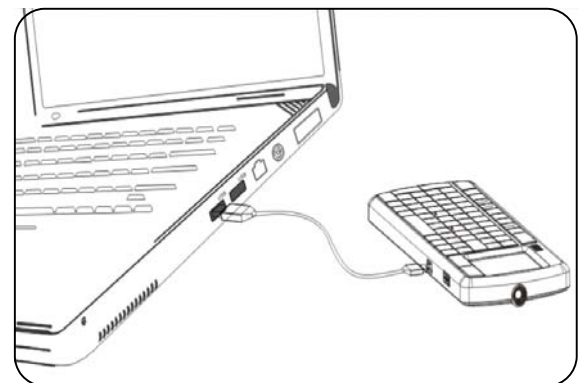
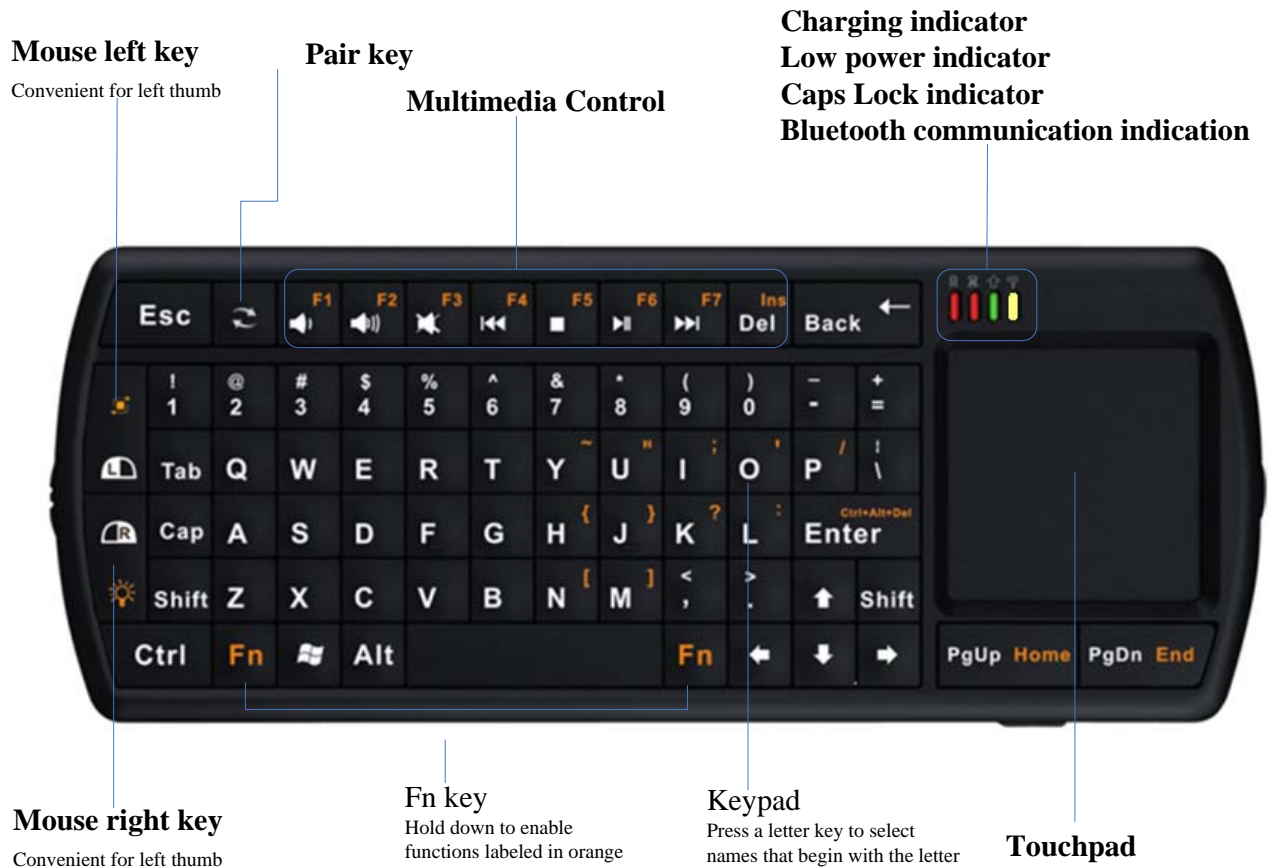

Figure. 5

---

## 6. Using your keyboard

### 6.1. Function overview



### 6.2. LED indicator

- Charging indicator



Red LED brights when charging get start, and the RED LED will turn off when the battery is full charged.

- Battery low indicator



Red Led will glint when the battery in low voltage, means the battery need to be recharged.

- Caps Lock indicator



When the LED is in green, it is in Capital status.

- Wireless communication indicator





When turn on the device, the yellow LED will bright for 5 seconds.

---



Press the pairing key, yellow LED glints, indicating the keyboard is in pairing status, yellow LED turn off when successfully pairing.

### 6.3. Power On /Off



Push the power switch  to the “ON” position, the yellow LED  will bright for 5 seconds, the backlight will bright as well. When the yellow LED turn off, you can use the key as a QWERTY keyboard, use the touchpad to control the cursor as a mouse. If you don't use the keyboard, please push the power switch to “OFF” position to save the energy.





### 6.4. Using “Fn” key

- Hold down the “Fn” key to enable the function labeled in orange.
- There are two special functional key on the mouse left and right key as below:

◆ Press  and , the direction of the touchpad will change to vertical as , if you're using the Keyboard as a presenter, it's very useful for your operating

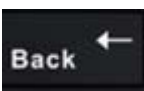
the keyboard with one hand, the original direction is .

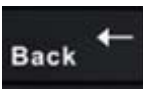
◆ Press  and , Backlighting will turn on or off. Backlighting allows effortless text entry, even in low light.

◆ Press  and , the speed of touchpad will be double than default, Press  and  again, the speed of touchpad will be back to default.

### 6.5. Using media control key

The media control key provide you good feeling and convenience when you're watching film through PC, adjust the volume, speed and so on just stay in Sofa, no need leave your seat to go to your PC.



---

## 6.6. Laser Pointer/flashlight function

This device provide optional version of Laser pointer for presenter and flashlight function for home use, the standard is with LED flashlight, if in dark environment, you can use the LED flashlight to get light. And if you want to use this device as a presenter, you can choose laser pointer before buy from the vendor.

## 6.7. Backlight

The device is with backlight, backlighting makes comfortable in typing, even in low light.

There're two ways to control the backlit – by software and by manual control mode.



When the connection is successful, backlight auto turn on, and will auto turn off after 5 seconds to save power and increase battery life. If you want to turn on the backlight, just need to press “Fn”+ “right mouse key”

## 6.8. Sleeping and waking up

If you don't operate the keyboard for one minute, the keyboard would go to sleep mode for saving power, after thirty minutes, the keyboard would go to deep sleep mode for more saving power, please press any key to wake up the keyboard except touchpad.

## 6.9. Pairing

The keyboard and dongle packed in the keyboard is paired completely in factory. The technology ensures different users use the keyboard on the same time and at the same place, however, if in special circumstances, the interference situation happened, you can change channels to avoid interference according to the following operation:

Press the PAIR/CONNECT  key for 2S, the communication indicator  will blink on 2S and off 1S, indicating the keyboard enter pairing status, if the dongle and keyboard match successfully, the yellow LED will turn off, you can use the keyboard and touchpad.

## 7. Tips and troubleshooting

If there's a problem should occur, you can quickly solve it following one of the way showed as below:

- Restart your computer or console
- Plug the USB mini-receiver into a different USB port.
- Restart your keyboard
- Recharge the keyboard
- Press the connect button  for 2S to pair again.

---

## 8. Important Notes

### 8.1. FCC statement

This equipment has been tested and found to comply with the limits for a Class B digital device, pursuant to Part 15 of the FCC Rules, These limits are designed to provide reasonable protection against harmful interference in a residential installation. This equipment generates, uses, and can radiate radio frequency energy and, if not installed and used in accordance with the instructions, may cause harmful interference to radio communications. However, there is no guarantee that interference will not occur in a particular installation. If this equipment does cause harmful interference to radio or television reception, which can be determined by turning the equipment off and on, the user is encouraged to try to correct the interference by one or more of the following measures:

- Reorient or relocate the receiving antenna.
- Increase the separation between the equipment and receiver.
- Connect the equipment into an outlet on a circuit different from that to which the receiver is connected.
- Consult and authorized dealer or service representative for help.

Changes or modifications not expressly approved by the party responsible for compliance could void the user's authority to operate the equipment.

RF warning statement:

The device has been evaluated to meet general RF exposure requirement. The device can be used in portable exposure condition without restriction.



### 8.2. CE

Europe – EU Declaration of Conformity for RF 2.4G wireless keyboard with integrated touchpad



Products intended for sale within the European Union are marked with the CE Marking, which indicates compliance with the applicable Directives and European Norms, and amendments, identified below.

Hereby, Hong Kong Tide technology Co., Ltd, declares that this RF 2.4G wireless keyboard is in compliance with the essential requirements and other relevant provisions of Directive 1999/5/EC.

## 9. Appendix Specification

- Backlit keys

Backlighting lets you see what you're typing—even in low light.

- Touch Pad
  - ◆ Dimension: 31\*31 mm
  - ◆ Resolution: 400 DPI
  - ◆ The touch pad can be used to point and click.
  - ◆ 90 degree rotated, you can use the touch pad vertically or horizontal.

---

- Laser Pointer/flashlight function

This device provide optional version of Laser pointer for presenter and flashlight function for home use, the standard is with LED flashlight.

While enjoying the movie in low light, the built-in flashlight will give you more convenience! When you're giving a lecture, the built-in laser pointer helps you easy to point the content on the projector

- Dimensions and Weight

Keyboard dimension: 155mm x 61mm x 12mm

Net weight: 102g (included wireless receiver)

Color box dimension:103\*192\*53mm

Gross weight: 280g

- Connectivity

RF 2.4G wireless technology

Point-to-point technology pre-paired with keyboard. (Does not act as a hub.)

As far as 10 meters control distance

- Power and Battery

30 days (battery standby time)

Full-charge: Takes about 4 hours.

Fast-charge: Takes about 10 minutes for 1 day of use

850 mAH lithium polymer battery

Power consumption (without backlit) : <10mA

Standby power consumption: <1.5mA

- Technical Specifications

- ◆ Control your PC entertainment from the palm of your hands!
- ◆ Palm-sized dimensions
- ◆ Nano dongle
- ◆ Rechargeable hi-grade Li-polymer battery
- ◆ Backlit keys for typing in the dark
- ◆ 71 back lighted keys
- ◆ Easy access of multi-media functions
- ◆ Integrated Touch Pad for accurate cursor control
- ◆ Support Windows, Mac and Linux based laptops, PC's, tablets and notebooks