

天线规格书

Antenna specification

1、天线类型：板载天线

Antenna type: On-board antenna

2、天线厂家：砚山欣高电子科技有限公司

Antenna manufacturer: Yanshan Xingao Electronic Technology Co., Ltd.

3、实物照片，图纸。

Antenna photo and drawings:

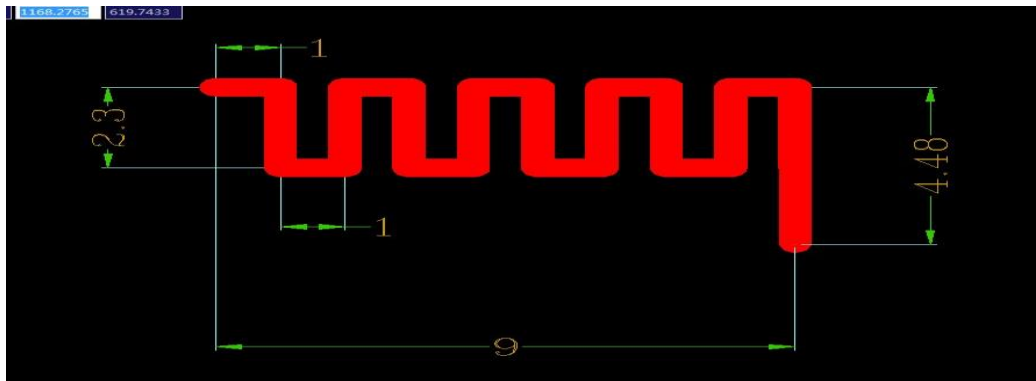

4、天线频率，效率，增益。

Antenna efficiency, frequency, and gain

Frequency	Efficiency / %	Gain/ dB
2400MHz	18.11	1.34
2410MHz	19.68	1.75
2420MHz	21.09	2.14
2430MHz	23.17	2.63
2440MHz	22.65	2.49
2450MHz	24.49	2.95
2460MHz	24.38	2.71
2470MHz	26.24	2.97
2480MHz	25	2.66
2490MHz	26.98	2.78
2500MHz	25.94	2.44

5、天线 2D 3D 图 Antenna 2D3D drawings

Phi 0 2D 图

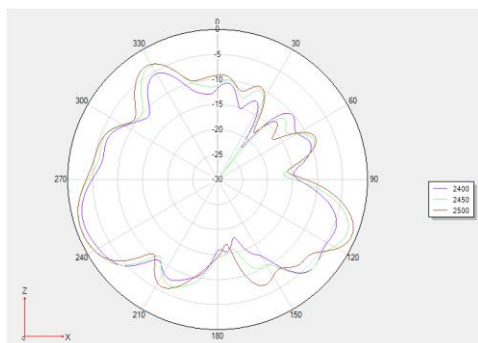

2400

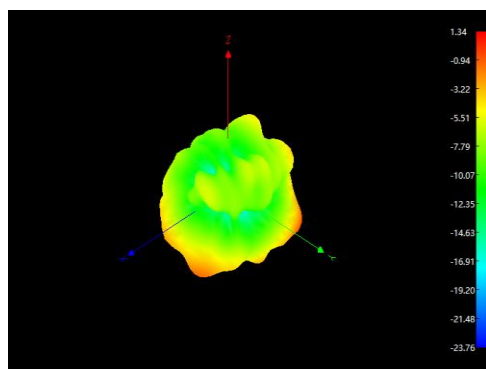

Phi 90 2D 图

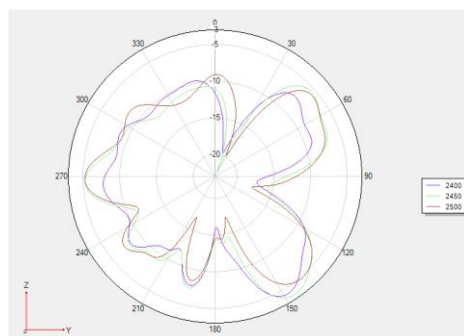

2450

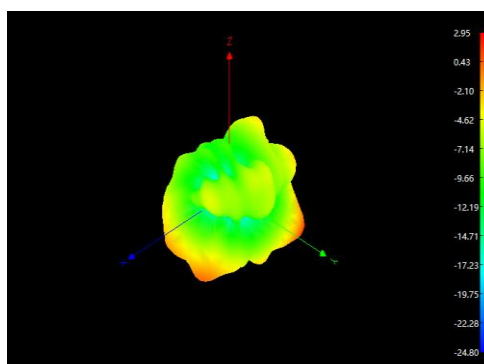

Theta 90 2D 图

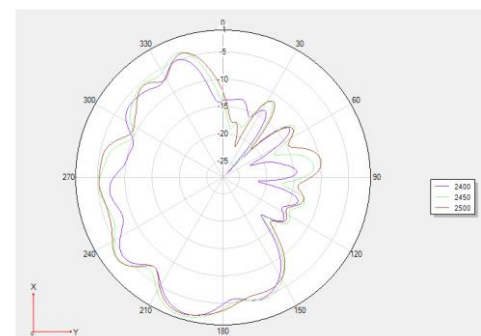

2500

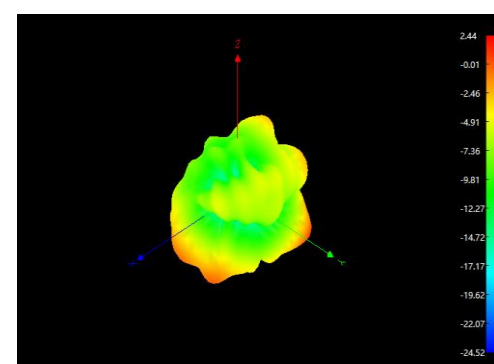

6、天线驻波比

antenna standing wave ratio



7、天线匹配电路

Corresponding circuit drawings

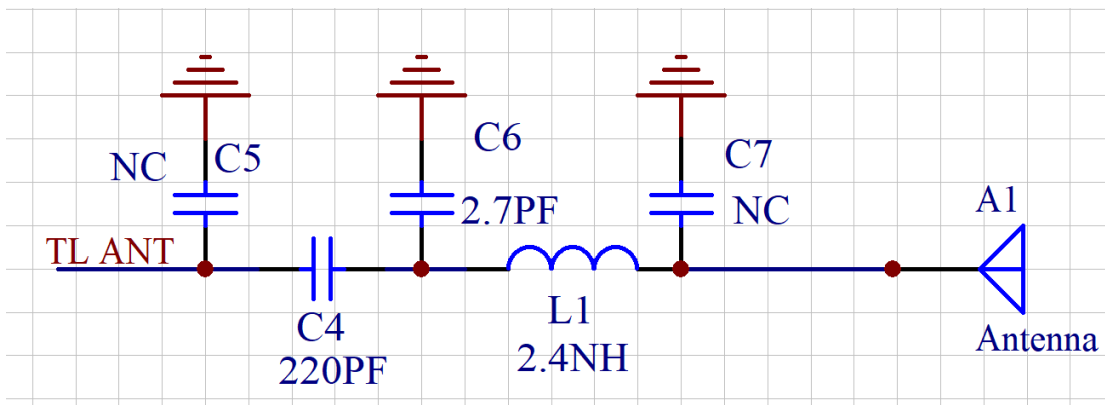

8、测试环境 Testing environment

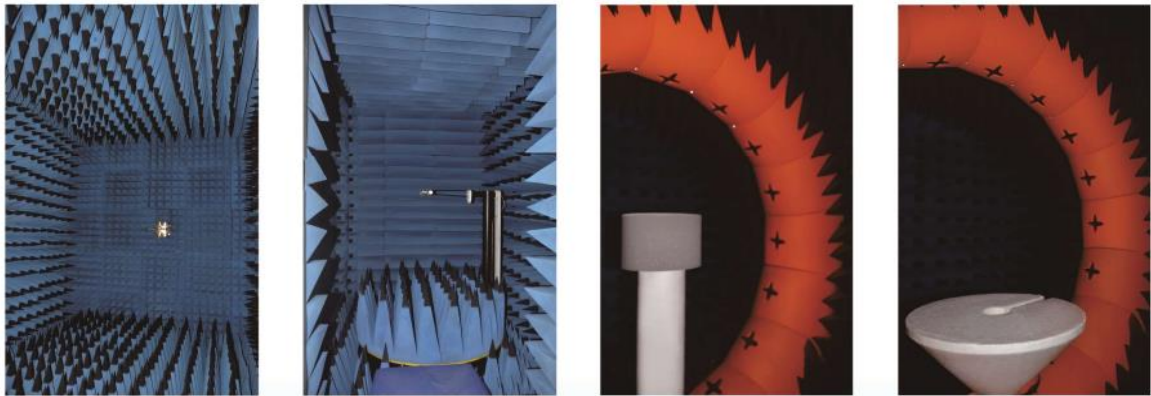

8. 测试实物



