

Hisense

5.1.4CH Soundbar with Wireless Subwoofer

Model: AX5140Q



 **Dolby Atmos**

 **Bluetooth®**

HDMI™
HIGH-DEFINITION MULTIMEDIA INTERFACE

dts X™

**Roku TV
Ready**

USER MANUAL



Before using the soundbar, please read this manual thoroughly and retain it for future reference.

Contents

1. Important Safety Instructions	3
1.1 Safety.....	3
1.2 Caution	4
1.3 Warning.....	4
2. What's in the Box	5
3. Identifying the Parts	6
3.1 Soundbar	6
3.2 Wireless Subwoofer.....	6
3.3 Surround Speakers.....	7
3.4 Remote Control	7
3.5 Prepare the Remote Control.....	7
3.6 Replace the Remote Control Battery	7
4. Placement and Mounting	8
4.1 Placement.....	8
4.2 Wall Mounting the Soundbar	8
4.3 Wall Mounting the Surround	9
5. Connections	9
5.1 Use the HDMI Socket	9
5.2 Use the OPTICAL Socket.....	11
5.3 Use the AUX Socket.....	11
5.4 Connect Power	11
6. Pair up with the Subwoofer and Rear Surround Speakers	12
7. Basic Operation	12
7.1 Standby/ON	12
7.2 Auto-Standby / Auto-Wake Feature.....	12
7.3 Select Modes	13
7.4 Adjust the Volume	13
7.5 Turn the Surround PURE/PRO/OFF.....	13
7.6 Adjust the Bass/Treble	13
7.7 Select Equalizer (EQ) Effect.....	13
7.8 Select a sound mode.....	13
7.9 Level (LVL) control	13
7.10 Setup Menu.....	13
7.11 Factory reset	14
8. AUX / OPTICAL / HDMI Operation	14
9. USB Operation	15
10. Bluetooth® Operation	15
11. Troubleshooting	16
12. Specifications	17

1. Important Safety Instructions



The lightning flash with arrowhead symbol, within an equilateral triangle, is intended to alert the user to the presence of uninsulated "dangerous voltage" within the product's enclosure that may be of sufficient magnitude as to constitute a risk of electric shock to persons.



The exclamation point within an equilateral triangle is intended to alert the user to the presence of important operating and maintenance (servicing) instructions in the literature accompanying the appliance.

1.1 Safety

- 1 Read these instructions** – All the safety and operating instructions should be read before this product is operated.
- 2 Keep these instructions** – The safety and operating instructions should be retained for future reference.
- 3 Heed all warnings** – All warnings on the appliance and in the operating instructions should be adhered to.
- 4 Follow all instructions** – All operating and usage instructions should be followed.
- 5 Do not use this apparatus near water** – The appliance should not be used near water or moisture – for example, in a wet basement or near a swimming pool and the like.
- 6 Clean only with a dry cloth.**
- 7 Do not block any ventilation openings.** Install in accordance with the manufacturer's instructions.
- Do not install near any heat sources such as radiators, heaters, stoves, or other apparatus (including amplifiers) that produce heat.
- Do not defeat the safety purpose of the polarized or grounding plug. A polarized plug has two blades with one wider than the other. A grounding plug has two blades and a third grounding prong. The wide blade or the third prong is provided for your safety. If the provided plug does not fit into your outlet, consult an electrician for replacement of the obsolete outlet.
- Protect the power cord from being walked on or pinched particularly at plugs, convenience receptacles, and the point where they exit from the apparatus.
- Only use attachments/accessories specified by the manufacturer.
-  Use only with the cart, stand, tripod, bracket or table specified by the manufacturer, or sold with the apparatus. When a cart or rack is used, use caution when moving the cart/apparatus combination to avoid injury from tip-over.
- Unplug the apparatus during lightning storms or when unused for long periods of time.
- Refer all servicing to qualified personnel. Servicing is required when the apparatus has been damaged in any way, such as power supply cord or plug is damaged, liquid has been spilled or objects have fallen into the apparatus, the unit has been exposed to rain or moisture, does not operate normally, or has been dropped.
- This equipment is a Class II or double insulated electrical appliance. It has been designed in such a way that it does not require a safety connection to electrical earth.
- The apparatus shall not be exposed to dripping or splashing. No objects filled with liquids, such as vases, shall be placed on the apparatus.
- Minimum distance around the apparatus for sufficient ventilation is 5cm.
- The ventilation should not be impeded by covering the ventilation openings with items, such as newspapers, table-cloths, curtains, etc.
- No naked flame sources, such as lighted candles, should be placed on the apparatus.
- Batteries should be recycled or disposed of as per state and local guidelines.
- The use of apparatus in moderate climates.

1.2 Caution

- Use of controls or adjustments or performance of procedures other than those described herein, may result in hazardous radiation exposure or other unsafe operation.
- To reduce the risk of fire or electric shock, do not expose this apparatus to rain or moisture. The apparatus must not be exposed to dripping or splashing and objects filled with liquids, such as vases, must not be placed on apparatus.
- The mains plug/appliance coupler is used as the disconnect device, the disconnect device must remain readily operable.
- Danger of explosion if battery is incorrectly replaced. Replace only with the same or equivalent type.

1.3 Warning

- The battery (batteries or battery pack) shall not be exposed to excessive heat such as sunshine, fire or the like.
- Before operating this system, check the voltage of this system to see if it is identical to the voltage of your local power supply.
- Do not place this unit close to strong magnetic fields.
- Do not place this unit on the amplifier or receiver.
- If any solid object or liquid falls into the system, unplug the system and have it checked by qualified personnel before operating it any further.
- Do not attempt to clean the unit with chemical solvents as this may damage the finish. Use a clean, dry or slightly damp cloth.
- When removing the power plug from the wall outlet, always pull directly on the plug, never yank on the cord.
- Changes or modifications to this unit not expressly approved by the party responsible for compliance will void the user's authority to operate the equipment.
- The rating label is pasted on the bottom or back of the equipment.

Battery usage CAUTION

To prevent battery leakage which may result in bodily injury, property damage, or damage to the apparatus:

- Install all batteries correctly, + and - as marked on the apparatus.
- Do not mix old and new batteries.
- Do not mix alkaline, standard (Carbon-Zinc) or rechargeable (Ni-Cd, Ni-MH, etc.) batteries.
- Remove batteries when the unit is not used for a long time.

WARNING:

- Replacement of a battery with an incorrect type may defeat a safeguard;
- Disposal of a battery into fire or a hot oven, or mechanically crushing or cutting of a battery, may result in an explosion;
- Leaving a battery in an extremely high temperature surrounding environment, such as sunshine, fire, or hot surface may result in an explosion or the leakage of flammable liquid or gas;
- A battery subjected to extremely low air pressure may result in an explosion or the leakage of flammable liquid or gas.

CAUTION: Risk of fire or explosion if the battery is replaced by an incorrect type!



Correct Disposal of this product. This marking indicates that this product should not be disposed with other household wastes throughout the EU.

To prevent possible harm to the environment or human health from uncontrolled waste disposal, recycle it responsibly to promote the sustainable reuse of material resources. To return your used device, please use the return and collection systems or contact the retailer where the product was purchased. They can take this product for environmental safe recycling.



We hereby declares that this product is in compliance with the essential requirements and other relevant provisions of RED Directive 2014/53/EU and UK Radio Equipment Regulations 2017.

2. What's in the Box



Soundbar

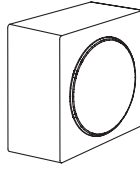

Wireless Subwoofer

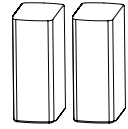

Surround Speakers x 2

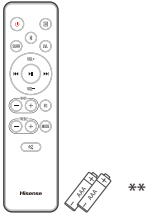

Remote Control /
AAA Batteries x 2

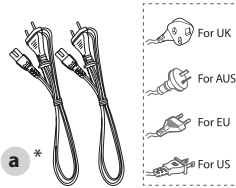

a *

AC Power Cord x 2

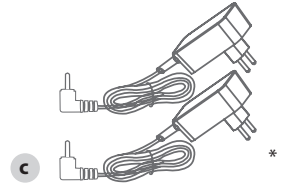

c *

AC Adapter x 2

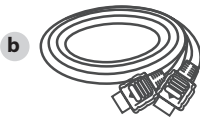

b

HDMI Cable

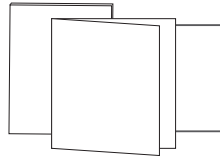

User Manual/Warranty card
/Quick start guide

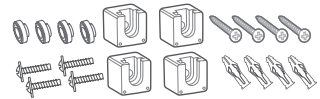

Wall mount kit

- Power cord quantity and plug type vary by regions. ** The accessories may be different from the list above due to different models, countries/ regions, please refer to the actual accessory bag.
- Images, illustrations and drawings shown on this User Manual are for reference only, actual product may vary in appearance.

3. Identifying the Parts

3.1 Soundbar

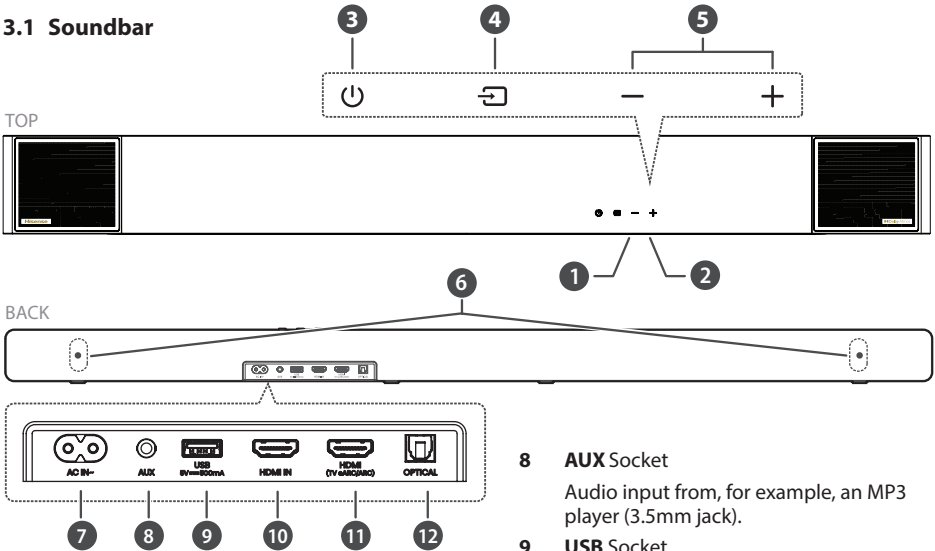

- 1 Remote Control Sensor**
Receive signal from the remote control.
- 2 Display Window**
Show the current status.
- 3 ⏻ (ON/OFF) button**
Switch the soundbar between ON and Standby mode.
- 4 [S] (SOURCE) button**
Select the input source.
- 5 +/- (VOL) buttons**
Increase/decrease the volume level.
- 6 Wall bracket screws**
- 7 AC IN ~ Socket**
Connect an AC power cord.

- 8 AUX Socket**
Audio input from, for example, an MP3 player (3.5mm jack).
- 9 USB Socket**
Insert the USB device to play music.
- 10 HDMI IN Socket**
Connect to the HDMI source devices, such as a DVD player, Blu-ray Disc™ player, or gaming console.
- 11 HDMI (TV eARC/ARC) Socket**
The port supports the eARC/ARC HDMI feature, connect to the HDMI (eARC/ARC) input on the TV.
- 12 OPTICAL Socket**
Connect to an optical audio output on the TV or a digital device.

3.2 Wireless Subwoofer

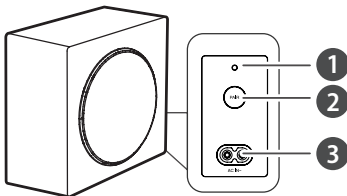

- 1 Pairing Indicator**
Light stops blinking once the subwoofer is paired with the soundbar.
- 2 PAIR button**
Press and hold to enter the pairing mode for the Subwoofer, which is used for Manual Pairing only. (Don't press PAIR button as Bar and Subwoofer and Surround would be paired automatically after the unit is switched ON.)
- 3 AC IN~ Socket**
Connect an AC power cord.

3.3 Surround Speakers

1 PAIR button	Activate the pairing function between the soundbar and the surround.
2 Indicator	<ul style="list-style-type: none"> • Fast blink Surround speaker in pairing mode • Constant on Connected / Paired successful • Slow blink Connection / Pairing Failed
3 L/R	Set to Left or Right Surround Speaker
4 DC IN	Connect to adapter
5 Screws	Remove the screws then install the wall screws here.

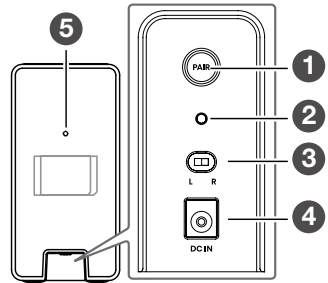

3.4 Remote Control

- Switch the soundbar between ON and STANDBY mode.
- SURR** Switch the surround PURE/PRO/OFF.
- VOL+ / VOL-** Increase/decrease the volume level.
- BASS +/-** Adjust bass level.
- TREBLE +/-** Adjust treble level.
- (SOURCE) Select the input source.
- Select the Bluetooth mode. Press and hold to activate the pairing function in Bluetooth mode or disconnect the existing paired Bluetooth device.
- LVL** Level (LVL) control.
- Skip to previous/next track in Bluetooth/USB mode.
- Play/pause/resume playback in Bluetooth / USB mode. Press and hold the button for 3s to enter setup menu.
- EQ** Select Equalizer (EQ) Effect. (MOVIE, NEWS, MUSIC, GAME PRO, SPORT)
- MODE** Select a sound mode. (SOUND MODE OFF, VOICE, NIGHT, AI)
- (MUTE) Mute or resume the sound.

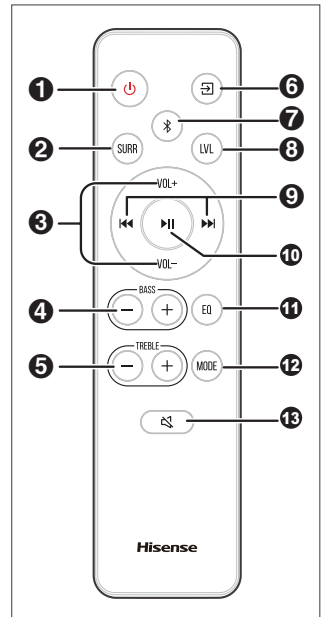

3.5 Prepare the Remote Control

IMPORTANT: The remote control will work within a 19.7 feet (6m) range, however this may be impossible if there are obstacles between the unit and the control.

3.6 Replace the Remote Control Battery

- Press and slide the back cover to open the battery compartment of the remote control.
- Insert two **AAA** size batteries. Make sure the (+) and (-) ends of the batteries match the (+) and (-) ends indicated in the battery compartment.
- Close the battery compartment cover.

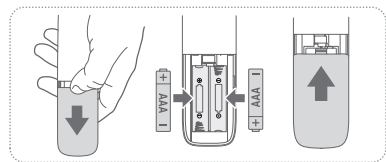

Precautions Concerning Batteries

- Be sure to insert the batteries with correct positive “+” and negative “-” polarities.
- Use batteries of the same type. Never use different types of batteries together.
- Either rechargeable or non-rechargeable batteries can be used. Refer to the precautions on their labels.

- Be aware of your fingernails when removing the battery cover and the battery.
- Do not drop the remote control.
- Do not allow anything to impact the remote control.
- Do not spill water or any liquid on the remote control.
- Do not place the remote control on a wet object.
- Do not place the remote control under direct sunlight or near sources of excessive heat.
- Remove the battery from the remote control when not in use for a long period of time, as corrosion or battery leakage may occur and result in physical injury, and/or property damage, and/or fire.
- Do not use any batteries other than those specified.
- Do not mix new batteries with old ones.
- Never recharge a battery unless it is confirmed to be a rechargeable type.

4. Placement and Mounting

4.1 Placement

- A If your TV is placed on a table, you can place the soundbar on the table directly in front of the TV stand, centered with the TV screen.

- B If your TV is attached to a wall, you can mount the soundbar on the wall directly below the TV screen.

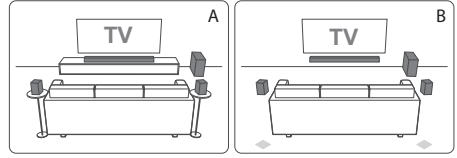

4.2 Wall Mounting the Soundbar

- **Caution:** If you are unfamiliar with power tools or layout of electrical wiring in the walls of your home, consult a professional installer. It is the installer's responsibility to verify that the wall will safely support the total load of the soundbar and wall brackets.
- Additional tools (not included) are required for the installation.
- Do not overtighten screws.
- Keep this instruction manual for future reference.
- Use an electronic stud finder to check the wall type before drilling and mounting.

WARNING

- To prevent injury, this apparatus must be securely attached to the floor/wall in accordance with the installation instructions.
- Suggested wall mounting height: ≤ 1.5 meters.

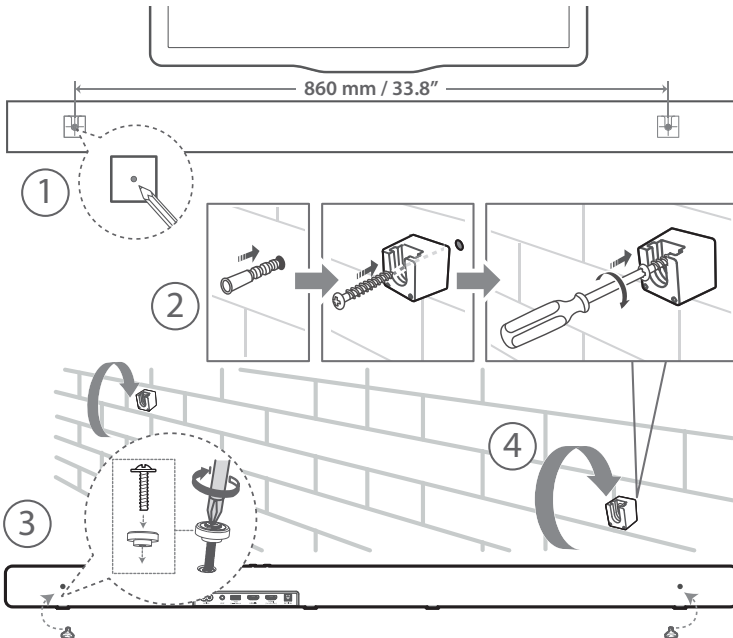

1. Drill 2 parallel holes (Ø 5.5-6 mm each according to wall type) in the wall. The distance between the holes should be 860mm/33.8".
2. Firmly fix 1 dowel into each hole in the wall if necessary. Tighten the wall mount brackets on the wall with screws and screwdriver. Make sure that they are securely installed.
3. Remove the screws at the back of the unit. Install the wall mounting screws into the back of the unit.
4. Lift the unit onto the wall mount brackets and slot into place.

4.3 Wall Mounting the Surround

1. Tighten the wall mount brackets on the wall with screws and screwdriver (not included). Make sure that they are securely installed.
2. Install the wall mounting screws into the back of the unit.
3. Hang the surround speaker by confirming the right/left of the surround speaker.

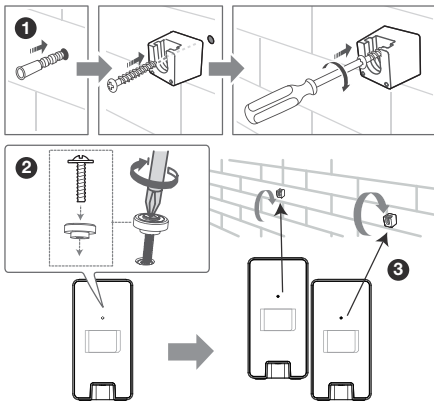

Note:

- Before installing the wall bracket, you need to connect the power/speaker cables of the (R/L) Surround Speakers.
- Check the **Surround L/R** on the rear of the rear speaker. "**Surround R**" is for the right, "**Surround L**" is for the left.

5. Connections

Dolby Atmos®

Dolby Atmos® gives you immersive listening experience by delivering sound in three dimensional space, and all the richness, clarity, and power of Dolby sound. For more information, please visit dolby.com/technologies/dolby-atmos

DTS: X

DTS: X, the border sound is no longer constrained by fixed-position speaker placement or specific channel signals.

5.1 Use the HDMI Socket

Method 1: Standard HDMI

- If your TV is not HDMI ARC-compliant, connect your soundbar to the TV through a standard HDMI connection.

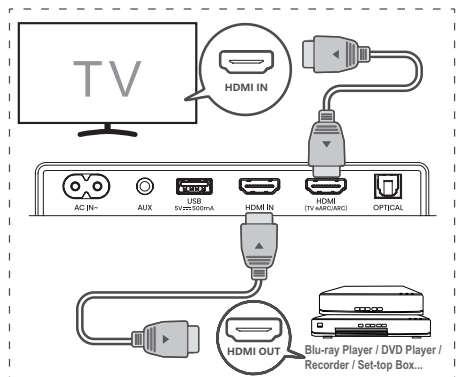

1. Use an HDMI cable to connect the soundbar's **HDMI OUT (eARC/ARC)** socket to the TV's HDMI IN socket.
2. Use an HDMI cable to connect the soundbar's **HDMI IN** socket to your external devices (e.g. game consoles, DVD players and blu-ray).

Method 2: Use the HDMI eARC/ARC Socket

The eARC/ARC (Enhance Audio Return Channel) function allows you to send audio from your ARC-compliant TV to your soundbar through a single HDMI connection. To enjoy the ARC function, please ensure your TV is both HDMI-CEC and ARC compliant and set up accordingly. When correctly set up, you can use your TV remote control to adjust the volume output (VOL +/- and MUTE) of the soundbar.

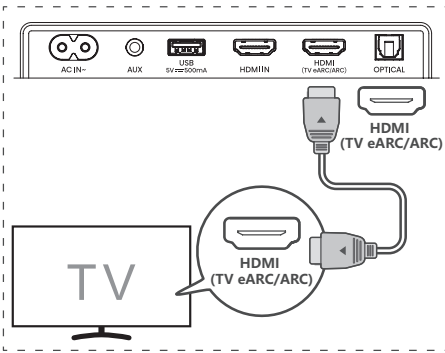

- Connect the HDMI cable from soundbar **HDMI (TV eARC/ARC)** socket to the HDMI eARC/ARC socket on your ARC compliant TV. Then press the remote control to select **HDMI eARC/ARC**.

Tips:

- Your TV must support the HDMI-CEC and ARC function. HDMI-CEC and ARC must be set to On.
- The setting method of HDMI-CEC and ARC may differ depending on the TV. For details about **eARC/ARC** function, please refer to the owner's manual.
- Only HDMI 1.4 or higher version cable can support the ARC function.

Hi-Concerto function

When connected to a Hisense TV that supports Hi-Concerto function, the soundbar plays audio in sync with the TV, enhancing your sound experience by providing a richer and more immersive auditory soundscape.

To use this function, when the soundbar is connected to the TV for the first time, simply select the "TV Speaker with Soundbar (Hi-Concerto)" option from the Audio Output menu of the TV.

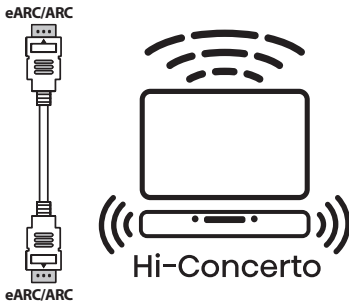

NOTE:

- This function is only supported in eARC mode, so please make sure TV's eARC function is enabled.
- The message displayed may differ with TV model.
- Ensure that TV and soundbar is connected with HDMI cable.
- This function is available in some Hisense TV and some soundbar models.

Use the Hisense EzPlay Function

For Hisense EzPlay, when the Soundbar connects with a Hisense TV via HDMI eARC/ARC, there will be a Soundbar Setting menu on the TV, and you can control this menu via your TV remote to control most of the Soundbar features.

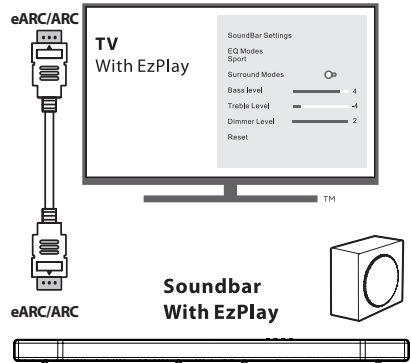

TV menu example (different models may have different menus) :

Setting--sound--Soundbar Setting.

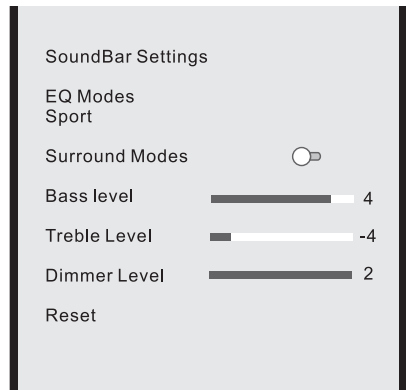

Note:

- This function is available only when both Soundbar and TV support Hisense Ezplay.

- This function requires Soundbar and TV connected via HDMI eARC/ARC, and the CEC of the TV must be turned ON.
- If everytime setting right, for the first time connect, there would be a tip on the TV screen to guide you find the Soundbar setting menu.

Use with Roku TV

- If you have a Roku TV™ model, setup is easy. Just use the included cable to connect your soundbar to the HDMI ARC port on your TV and follow the on-screen instructions.



5.2 Use the OPTICAL Socket

- Use the OPTICAL cable to connect the TV's OPTICAL OUT socket and the **OPTICAL** socket on the soundbar.

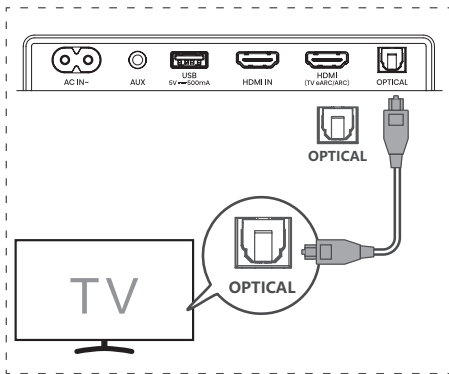

Tip:

The Soundbar may not be able to decode all digital audio formats from the input source. In this case, the Soundbar will mute. This is NOT a defect. Ensure that the audio setting of the input source (e.g. TV, game console, DVD player, etc.) is set to **PCM** or **Dolby Digital** (Refer to the user manual of the input source device for its audio setting details) with HDMI / eARC/ARC / OPTICAL input.

5.3 Use the AUX Socket

- A. Use a 3.5mm to 3.5mm audio cable to connect the TV's or external audio device headphone socket to the **AUX** socket on the soundbar.

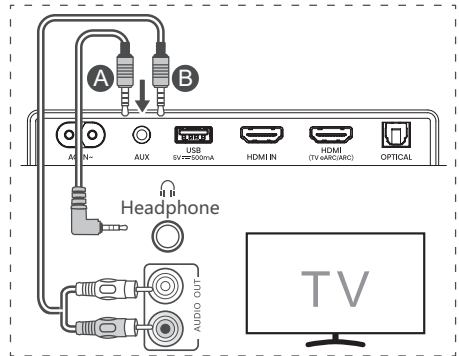

- B. Use a RCA to 3.5mm audio cable to connect the TV's audio output sockets to the **AUX** socket on the soundbar.

5.4 Connect Power

Risk of product damage!

- Risk of product damage! Ensure that the power supply voltage corresponds to the voltage printed on the back or the underside of the soundbar.
- Before connecting the AC power cord, ensure you have completed all other connections.
- **Soundbar:** Connect the mains cable to the AC~ socket of the soundbar and then into a mains socket.
- **Subwoofer:** Connect the mains cable to the AC~ socket of the subwoofer and then into a mains socket.
- **Surround:** Use the AC adapter, connect to the **DC IN** socket on the surround speakers and to a power outlet.

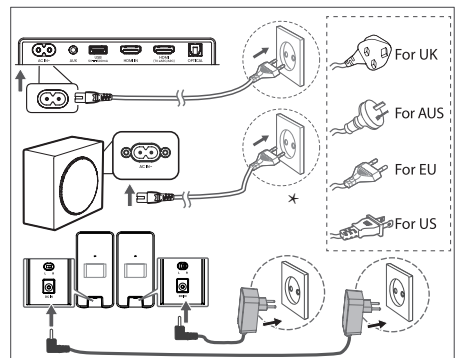

* Power cord quantity and plug vary by regions.

6. Pair up with the Subwoofer and Rear Surround Speakers

Automatic pairing

The subwoofer and surround will pair automatically with soundbar upon first use.



- Determine the status based on the wireless subwoofer and surround indicator.

LED State	Status
Fast blink	Subwoofer and Surround in pairing mode
Constant on	Connected / Pairing successful
Slow blink	Connection / Pairing Failed

NOTE:

- Do not press the **PAIR** button on the rear of the subwoofer and surround, except for manual pairing.
- If the automatic pairing fails, pair the subwoofer with the main unit manually.

Manual Pairing

1. Ensure that all cables are well connected and the main unit is in Standby mode.
2. Press the  button on the unit or remote control to switch the main unit on.
3. Press and hold the  button on the Soundbar or on the remote control for a few seconds to enter pairing mode. The display will scroll "**SW PAIRING**".
4. Press and hold the **PAIR** button on the Subwoofer or Surround for a few seconds. The Subwoofer or Surround enter the pairing state. The Pair indicator on the Subwoofer or Surround will blink quickly.
5. After the wireless connection succeeded, the Pair indicators will light up and the display on main unit will show "**SW IN**".
6. If the Pair indicator blinks, the wireless connection has failed. Unplug the cable of the Subwoofer or Surround and then reconnect the main cable after 3 minutes. Repeat step 1 ~ 4.

Tips

- If the wireless connection fails again, check if there is a conflict or strong interference (e. g. interference from an electronic device) around the location. Remove these conflicts or strong interferences and repeat the above procedures.

- The Subwoofer&Surround should be within 6 metres of the Soundbar in an open area.
- If the main unit is in On mode, and not connected with the subwoofer and the rear surround speakers, the indicators on the subwoofer and the rear surround speaker will flash slowly. Follow step 1~4 above to pair the subwoofer and the rear surround speakers to the main unit.

7. Basic Operation

7.1 Standby/ON

It will automatically turn on when the power cord is connected.





- Press the  button to switch the soundbar STANDBY mode.
- Disconnect the mains plug from the mains socket if you want to switch the soundbar OFF completely.

7.2 Auto-Standby / Auto-Wake Feature



[Auto-Standby] During Auto Standby On mode, the soundbar would standby automatically when no audio is detected for 15 minutes. For example, this would happen when pausing playback, or should the soundbar be left on accidentally.

[Auto-Wake] If a TV or an external device is connected (AUX / OPTICAL / HDMI eARC mode), the unit will switch on automatically when the TV or the external device is switched on.

To disable this feature, please follow the steps below:



1. During ON mode, press and hold the  button for 3 seconds to open the menu.
 - The unit's display will show "**MENU**".
 2. Press the  button 6 times in succession: the display shows: **Auto Wake [ON / OFF]**.
or Press the  button 7 times in succession: the display shows: **Auto Standby [ON / OFF]**.
 3. Select the content with **VOL+ / -** buttons on the remote control, and then press the  button to confirm your selection and exit the settings.
- Repeating these steps will toggle the feature "ON" and "OFF".

7.3 Select Modes

Press the  (SOURCE) button repeatedly on the soundbar or on the remote control to select the **HDMI eARC/ARC, HDMI IN, OPTICAL, AUX, USB** and  (Bluetooth) mode. The selected mode will show on the display.

Display	Mode
ARC eARC	HDMI ARC HDMI eARC
HDMI	HDMI IN
OPT	OPTICAL
AUX	AUX
USB NO USB NO FILE	USB • No USB connected • No Music Or No File Supported
BT BT_IN NO BT	Bluetooth • Connected • Not Connected

7.4 Adjust the Volume

- Press the **VOL+/-** buttons on the soundbar or on the remote control to adjust the volume.
- If you wish to turn the sound off, press the  (MUTE) button on the remote control. Press the  (MUTE) button again or press the **VOL+/-** buttons to resume normal listening.

7.5 Turn the Surround PURE/PRO/OFF

- Press the **SURR** button on the remote control to switch the surround PURE/PRO/OFF.

7.6 Adjust the Bass/Treble

- Press the **BASS +/-** buttons on the remote control to adjust bass level.
- Press the **TREBLE +/-** buttons on the remote control to adjust treble level.



7.7 Select Equalizer (EQ) Effect



- While playing, press the **EQ** button on the remote control to select desired preset equalizers: **MOVIE, NEWS, MUSIC, GAME PRO, SPORT.**

7.8 Select a sound mode

- While playing, press the **MODE** button on the remote control to select a sound mode: **SOUND MODE OFF, VOICE, NIGHT, AI.**

7.9 Level (LVL) control





1. Press the **LVL** button to select level (LVL) control menu.
 2. Select the content with the  /  buttons.
 3. Change the initial values for each of the settings with **VOL+/-** buttons.
 4. Press the  button to confirm your selection and exit the settings.
- If no button is pressed within 10 seconds, the system will automatically exit the menu.

Display  / 	Description VOL+/-
SUB+3	Switch Subwoofer sound level
C+3	Switch center channel level
FH+3	Switch front height effects level
RS+3	Switch rear surround sound effects level
RH+3	Switch rear height surround sound effects level
L+S / R+S	Switch Left and right balance sound effects level
DIM3	Adjust the Brightness DIM 0 / DIM 1 / DIM 2 / DIM 3

Restore the default sound effect and dimmer

- Sub LVL: 0
- Center LVL: 0
- Front Height LVL: 0
- Rear LVL: 0
- Rear Height LVL: 0
- L/R Balance: 0
- Dimmer LVL: 3

7.10 Setup Menu

1. During ON mode, press and hold the  button for 3 seconds to open the menu.
 2. Select the content with the  /  buttons.
 3. Change the initial values for each of the settings with **VOL+/-** buttons.
 4. Press the  button to confirm your selection and exit the settings.
- If no button is pressed within 10 seconds, the system will automatically exit the menu.

Display ◀◀/▶▶	Description VOL+/-
1 MOVIE	Select Equalizer (EQ) effect (MOVIE, NEWS, MUSIC, GAME PRO, SPORT)
2 SUR OFF	Switch Surround Sound (SUR OFF, PURE SUR, SUR PRO)
3 BASS 0	Adjust the Bass Level
4 TRE 0	Adjust the Treble Level
5 DIM 3	Adjust the Brightness (DIM 0 / DIM 1 / DIM 2 / DIM 3)
6 AUTOWAKE OFF	Switch Auto Wake (ON / OFF)
7 AUTO STANDBY ON	Switch Auto Standby (ON / OFF)
8 L T 00	Set the Audio Delay (AV SYNC)
9 DRC 0	Switch DRC Level 0/1/2
10 DCL 0	Switch Dialog Control Level 0/1/2/3/4/5/6
11 NEURAL X OFF	Switch Neural : X ON/OFF
12 VIRTUAL X OFF	Switch Virtual : X ON/OFF
13 SOUND MODE OFF	Switch Sound Mode (SOUND MODE OFF, NIGHT, VOICE, AI)

Note: DRC / Dialog Control/ Neural : X are mainly for DTS compliance requirement and only Virtual:X Setting is open for consumer.

7.11 Factory reset

Reset device to default setting.

- Switch the soundbar on the **OPTICAL** mode, press and hold the [⏻] button on the soundbar, the soundbar will enter factory reset mode and turn to standby state.

MODE	DEFAULT
SOURCE	eARC/ARC
Volume	30
Surround	OFF
Dimmer	DIM 3
Bass	0
Treble	0
EQ	MOVIE
Auto Wake	OFF
Auto Standby	ON (Except the USA/Canada/Mexico)
Hi-Concerto	OFF
Sound mode	OFF

- Level (LVL) control menu will enter reset and clear classic Bluetooth and LE audio TX.

8. AUX / OPTICAL / HDMI Operation

- Ensure that the soundbar is connected to the TV or audio device.
- Press the [SOURCE] button repeatedly on the soundbar or on the remote control to select the **AUX, OPTICAL, HDMI eARC/ARC, HDMI IN** mode. The selected mode will show on the display.
- Operate your audio device directly for playback features.
- Press the **VOL+/-** buttons to adjust the volume to your desired level.

Tip:

- The Soundbar may not be able to decode all digital audio formats from the input source. In this case, the Soundbar will mute. This is NOT a defect. Ensure that the audio setting of the input source (e.g. TV, game console, DVD player, etc.) is set to **PCM** or **Dolby Digital** (Refer to the user manual of the input source device for its audio setting details) with HDMI eARC/ARC / OPTICAL input.
- When selecting a different audio format, the unit will display the following as follows.

Audio (abbreviation)	Display
LPCM 2ch LPCM 5.1ch LPCM 7.1ch	PCM AUDIO
Dolby Digital Dolby TrueHD Dolby Digital Plus	DOLBY AUDIO
Dolby Atmos - Dolby TrueHD Dolby Atmos - Dolby Digital Plus	DOLBY ATMOS
DTS DTS Discrete Surround DTS-ES 6.1 Matrix DTS-ES 6.1 Discrete DTS 96/24 DTS 96/24 ES Matrix DTS Express DTS-ES 8-Channel Discrete	DTS
DTS-HD High Resolution DTS-HD Master Audio	DTS-HD
DTS:X DTS:X Master Audio	DTS-X

9. USB Operation

1. Insert the USB device.

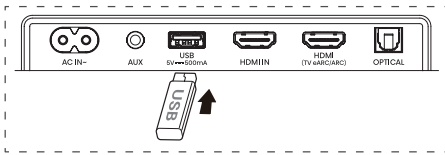

2. Press the (SOURCE) button repeatedly on the soundbar or on the remote control to select the **USB** mode.
3. During playback:

Start, pause or resume play

Skip to the previous or next track

Tips:

- The unit can support USB devices with up to 32 GB of memory.
- This unit can play WAV / WMA / MP3 / FLAC.
- This product may not be compatible with certain types of USB storage devices.
- If you use a USB extension cable, USB hub, or USB Multifunctional card reader, the USB storage device may not be recognized.
- Do not remove the USB storage device while reading files.

10. Bluetooth® Operation

Through Bluetooth, connect the Soundbar with your Bluetooth device (such as an iPad, iPhone, iPod touch, Android phone, or laptop), and then you can listen to the audio files stored on the device through your Soundbar speakers.

First time pairing

1. Press the (SOURCE) button on the soundbar or button on the remote control to select Bluetooth® mode.
- The display will show **NO BT**.
2. Activate your Bluetooth device and select the search mode.
3. Select “Hisense AX5140Q” in the pairing list. The system is successfully connected and the display will show **BT_IN**.

- If you want to connect your soundbar with another Bluetooth device, press and hold the button on the remote control to disconnect the currently connected Bluetooth device. Follow step 2-3 to pair your Bluetooth device.

To disconnect the Bluetooth function, you can :

- Switch to another function on the unit.
- Disable the function from your Bluetooth device.
- Press and hold the button on the remote control.

Listen to music from Bluetooth Device

- If the connected Bluetooth device supports Advanced Audio Distribution Profile (A2DP), you can listen to the music stored on the device through the player.
 - If the device also supports Audio Video Remote Control Profile (AVRCP), you can use the player's remote control to play music stored on the device.
1. Pair your device with the player.
 2. Play music via your device (if it supports A2DP).
 3. Use supplied remote control to control play (if it supports AVRCP).

Start, pause or resume play

Skip to the previous or next track

Tips:

- The operational range between the Soundbar and the device is approximately 8 metres.
- Before connecting a Bluetooth® device to the Sound Bar, ensure you know the device's capabilities.
- Compatibility with all Bluetooth® devices is not guaranteed.
- Any obstacle between the device and the Sound Bar can reduce operational range.
- Keep this player away from other electronic devices that may cause interference.
- The player will also be disconnected when your device is moved beyond the operational range.

11.Troubleshooting

To keep the warranty valid, never try to repair the system yourself. If you encounter problems when using this soundbar, check the following points before requesting service.

Problem	Solution
No power	<ul style="list-style-type: none"> • Ensure that the AC cord of the apparatus is properly connected . • Ensure that there is power at the AC outlet. • Press ⏻ (standby) button to turn the soundbar on.
Remote control does not work	<ul style="list-style-type: none"> • Before you press any playback control button, first select the correct source. • Reduce the distance between the remote control and the soundbar. • Insert the battery with its polarities (+/-) aligned as indicated. • Replace the battery. • Aim the remote control directly at the sensor on the front of the soundbar.
No sound	<ul style="list-style-type: none"> • Make sure that the soundbar is not muted. Press MUTE or +/- (VOL) button to resume normal listening. • Press ⏻ button on the soundbar or on the remote control to switch the soundbar to standby mode. Then press the ⏻ button again to switch the soundbar on. • Unplug both the soundbar and the subwoofer from the mains socket, then plug them again. Switch on the soundbar. • Ensure the audio setting of the input source (e.g. TV, game console, DVD player, etc.) is set to PCM or Dolby Digital mode while using digital (e.g. HDMI, OPTICAL) connection. • The subwoofer is out of range, please move the subwoofer closer to the soundbar. Make sure the subwoofer is within 5 m of the soundbar (the closer the better). • The soundbar may have lost connection with the subwoofer. Re-pair the units by following the steps on the section "Pair up with the Subwoofer and Rear Surround Speakers". • The soundbar may not be able to decode all digital audio formats from the input source.
TV has display problem while viewing HDR content from HDMI source.	<ul style="list-style-type: none"> • Some 4K HDR TVs require the HDMI input or picture settings to be set for HDR content reception. For further setup details on HDR display, please refer to the instruction manual of your TV.
I can't find the Bluetooth name of this soundbar on my Bluetooth device for Bluetooth pairing	<ul style="list-style-type: none"> • Ensure the Bluetooth function is activated on your Bluetooth device. • Ensure you have paired the soundbar with your Bluetooth device. • The soundbar has a Bluetooth® function that can receive a signal within 8 metres. Keep a distance within 8 metres between the soundbar and your Bluetooth® device.
This is a 15 mins power off function, one of the ERPII standard requirement for saving power	<ul style="list-style-type: none"> • When the unit's external input signal level is too low, the soundbar will be turned off automatically in 15 minutes. Please increase the volume level of your external device.

12. Specifications

Brand	Hisense
Model	AX5140Q

Soundbar

Power Supply	100-240V~ 50/60Hz
Power Consumption	40W < 0.5 W (StandBy)
USB	5V --- 500mA USB (2.0) / FAT32 / FAT16 32G (max), WAV / WMA / MP3 / FLAC.
Dimension (WxHxD)	1020 x 59 x 108 mm / 40.1" x 2.3" x 4.2"
Net weight	2.7 kg / 5.95 lbs
Audio input sensitivity	500mV
Frequency Response	120Hz - 20KHz
Operating Temperature	0°C - 45°C

Subwoofer

Power Supply	100-240V~ 50/60Hz
Power Consumption	40W < 0.5 W (StandBy)
Dimension (WxHxD)	163 x 338 x 335 mm / 6.4" x 13.3" x 13.1"
Net weight	5.6 kg / 12.3 lbs
Frequency Response	40Hz-150Hz

Surround Speaker

Adapter Mode	DK42C-240-1500
• Input	100-240V~ 50/60Hz 1.0A
• Output	24V --- 1.5A
Frequency Response	180Hz - 20KHz
Dimension (WxHxD)	100 x 202 x 119 mm / 3.9" x 7.9" x 4.7"
Net weight	1.4 kg (0.7 kg x 2) / 3.1 lbs (1.55 lbs x 2)

Wireless Specification (EU)

Bluetooth version / profiles	V 5.3 (A2DP, AVRCP)
Bluetooth frequency range	2400 MHz ~ 2483.5 MHz
Bluetooth Max. transmitting power	≤ 10 dBm
Wireless frequency range	5.8G: 5729-5848 MHz / ≤10 dBm
Max. transmitting power	
Modulation Type	GFSK, π/4 DQPSK, 8-DPSK

Remote Control

Distance/Angle	19.7 feet (6m) / 30°
Battery type	AAA (1.5V x 2)

- Design and specifications are subject to change without notice.

Trademarks



The Bluetooth® word mark and logos are registered trademarks owned by Bluetooth SIG, Inc. and any use of such marks by The HISENSE International Industries, Incorporated is under license. Other trademarks and trade names are those of their respective owners.



The terms HDMI, HDMI High-Definition Multimedia Interface, HDMI trade dress and the HDMI Logos are trademarks or registered trademarks of HDMI Licensing Administrator, Inc.



Dolby, Dolby Atmos, and the double-D symbol are registered trademarks of Dolby Laboratories Licensing Corporation. Manufactured under license from Dolby Laboratories. Confidential unpublished works. Copyright © 2012-2024 Dolby Laboratories. All rights reserved.



FOR DTS PATENTS, SEE [HTTP://XPERI.COM/DTS-PATENTS/](http://XPERI.COM/DTS-PATENTS/). MANUFACTURED UNDER LICENSE FROM DTS, INC. AND ITS AFFILIATES. DTS, DTS:X, THE DTS:X LOGO, VIRTUAL:X, AND THE DTS VIRTUAL:X LOGO ARE REGISTERED TRADEMARKS OR TRADEMARKS OF DTS, INC. AND ITS AFFILIATES IN THE UNITED STATES AND/OR OTHER COUNTRIES. © DTS, INC. AND ITS AFFILIATES. ALL RIGHTS RESERVED.



- EN** Roku, the Roku logo, Roku TV, Roku TV Ready, and the Roku TV Ready logo are trademarks and/or registered trademarks of Roku, Inc.
- FR** Roku, le logo Roku, Roku TV, Roku TV Ready et le logo Roku TV Ready sont des marques de commerce et/ou des marques déposées de Roku Inc.
- ES** Roku, el logotipo de Roku, Roku TV, Roku TV Ready y el logotipo de Roku TV Ready son marcas comerciales o marcas comerciales registradas de Roku, Inc.





WARNING: This product can expose you to chemicals including Lead, which is known to the State of California to cause cancer. For more information go to: www.P65Warnings.ca.gov.

EN



FR

Règlement de la FCC (pour les clients américains)

REMARQUE :

- Ce dispositif a été testé et déclaré conforme aux limites d'un dispositif numérique de classe B, conformément à la partie 15 des règles de la FCC.
Ces limites ont pour but d'assurer une protection raisonnable contre le brouillage nuisible dans une installation résidentielle. Cet équipement produit, utilise et peut émettre de l'énergie en radio fréquence et, s'il n'est pas installé et utilisé conformément aux directives, il peut causer un brouillage nuisible dans les communications radio.
- Cependant, il n'est pas garanti que des interférences ne se produiront pas dans une installation particulière. Si cet appareil provoque des interférences nuisibles à la réception radio ou de télévision, ce qui peut être déterminé en mettant l'appareil hors tension, l'utilisateur est encouragé à essayer de corriger l'interférence par une ou plusieurs des mesures suivantes :
 - Réorienter ou déplacer l'antenne de réception.
 - Augmenter la distance entre l'appareil et le récepteur.
 - Brancher l'appareil à une prise sur un circuit différent de celui sur lequel le récepteur est branché.
 - Consulter le revendeur ou un technicien radio/TV expérimenté.

Cet appareil est conforme à la partie 15 des règles de la FCC. Son fonctionnement est soumis aux deux conditions suivantes :

- (1) ce dispositif ne peut pas causer d'interférences nuisibles et
 - (2) cet appareil doit accepter toute interférence reçue, y compris les interférences qui peuvent causer un mauvais fonctionnement.
- Des câbles blindés doivent être utilisés avec cet appareil pour assurer la conformité avec les limites de la classe B de la FCC. fonctionnement de l'appareil.

Avis d'Industrie Canada: CAN ICES (B)/NMB (B)

L'émetteur/récepteur exempt de licence contenu dans le présent appareil est conforme aux CNR d'Innovation, Sciences et Développement économique Canada applicables aux appareils radio exempts de licence. L'exploitation est autorisée aux deux conditions suivantes :

1. L'appareil ne doit pas produire de brouillage;
2. L'appareil doit accepter tout brouillage radioélectrique subi, même si le brouillage est susceptible d'en compromettre le fonctionnement.

Avvertimento :

- Pour rester en conformité avec les consignes d'exposition aux RF, placez le produit à au moins 20 cm des personnes proches.
- Les changements ou modifications de cet appareil non expressément approuvées par la partie responsable de la conformité pourraient annuler l'autorisation de l'utilisateur à utiliser l'équipement.

FCC INFORMATION (for US customers)

NOTE:

- This equipment has been tested and found to comply with the limits for a Class B digital device, pursuant to Part 15 of the FCC Rules. These limits are designed to provide reasonable protection against harmful interference in a residential installation. This equipment generates, uses and can radiate radio frequency energy and, if not installed and used in accordance with the instructions, may cause harmful interference to radio communications.
- However, there is no guarantee that interference will not occur in a particular installation. If this equipment does cause harmful interference to radio or television reception, which can be determined by turning the equipment off and on, the user is encouraged to try to correct the interference by one or more of the following measures:
 - Reorient or relocate the receiving antenna.
 - Increase the separation between the equipment and receiver.
 - Connect the equipment into an outlet on a circuit different from that to which the receiver is connected.
 - Consult the dealer or an experienced radio / TV technician for help.

This device complies with Part 15 of the FCC Rules. Operation is subject to the following two conditions:

- (1) this device may not cause harmful interference, and
 - (2) this device must accept any interference received, including interference that may cause undesired operation.
- Shielded cables must be used with this unit to ensure compliance with the Class B FCC limits.

IC Notice: CAN ICES (B)/NMB (B)

This device contains licence-exempt transmitter(s)/receiver(s) that comply with Innovation, Science and Economic Development Canada's licence-exempt RSS(s). Operation is subject to the following two conditions:

1. This device may not cause interference.
2. This device must accept any interference, including interference that may cause undesired operation of the device.

Warning:

- This equipment should be installed and operated with minimum distance 20cm between the radiator & your body.
- Changes or modifications to this unit not expressly approved by the party responsible for compliance could void the user's authority to operate the equipment."

Hisense

AX5140Q

