



# Test Report

---

## Listen Before Talk (LBT)

**Test of Canopy PMP450b - 0a-00-3e-44-00-66, 3.6GHz MIMO OFDM  
11/27/2019**

The unrestricted contention based protocol for devices operating in the 3650 – 3700 MHz under Part 90Z of the FCC rules permit operation on a co-channel with like systems (similar systems) and unlike systems.

<b>This report was prepared by:</b>			
<b>First and Last Names</b>	<b>Title</b>	<b>Date</b>	<b>Signature</b>
Pavel Polyakov	Senior Staff Engineer, SIT	27 Nov 2019	<i>Pavel Polyakov</i>

## Table of Contents

1. Customer Information .....	4
2. Summary of Testing .....	5
2.1 General Information .....	5
2.2 Summary of Test Results.....	5
2.3 Methods and procedures.....	5
3. Equipment Under Test (EUT) .....	6
3.1 Identification of Equipment Under Test (EUT).....	6
3.2 Description of EUT .....	6
3.3 Modifications Incorporated in the EUT.....	6
3.4 Additional Information Related to Testing .....	6
3.5 Support Equipment.....	6
4. Operation and Monitoring of the EUT during Testing .....	8
4.1 Operating Modes .....	8
4.2 Configuration and Peripherals .....	8
5. Measurements, Examinations and Delivered Results.....	9
5.1 Test Results .....	9
Appendix 1: Test Equipment Used.....	14
Appendix 2: Monitoring Methods Diagrams .....	15

*This page has been left intentionally blank*

## 1. Customer Information

<b>Company name:</b>	Cambium Networks Ltd.
<b>Address:</b>	3800 Golf Road, Suite 360, Rolling Meadows, IL 60008 United States of America

## 2. Summary of Testing

### 2.1 General Information

<b>Specification Reference:</b>	Section 90.7 of Part 90Z of the US FCC rules
<b>Specification Description of Contention Based Protocol (CBP):</b>	A protocol that allows multiple users to share the same spectrum by defining the events that must occur when two or more transmitters attempt to simultaneously access the same channel and establishing rules by which a transmitter provides reasonable opportunities for other transmitters to operate. Such a protocol may consist of procedures for initiating new transmissions, procedures for determining the state of the channel (available or unavailable), and procedures for managing retransmissions in the event of a busy channel. The 'Listen Before Talk' (LBT) operational procedure is the most well-known Contention-based Protocol (CBP)
<b>Test Dates:</b>	27 November 2019

### 2.2 Summary of Test Results

Reference	Part	Measurement	Result
Section 90.7 of US FCC rules	Part 90Z	Verification of Unrestricted Contention Based Protocol operation	PASSED

Notes:

- 1) The Device Under Test (DUT) is operating in OFDM mode in the 3.65 – 3.70 GHz frequency band.
- 2) The DUT was operating in the following channel bandwidths: 5/7/10/15/20/30/40 MHz.

### 2.3 Methods and procedures

<b>Reference:</b>	Section 90.7 of Part 90 of the US FCC rules
<b>Title:</b>	Private land mobile radio services

### 3. Equipment Under Test (EUT)

#### 3.1 Identification of Equipment Under Test (EUT)

<b>Brand Name:</b>	Cambium Networks
<b>Model Name:</b>	PMP 450b
<b>MAC Address:</b>	0a-00-3e-44-00-66
<b>Software Version Number:</b>	CANOPY 16.1.1 (Build SIT-7)

#### 3.2 Description of EUT

The device can be configured in several different ways: Access Point or Subscriber Module in Point to Multipoint topology; or Backhaul - Timing Master or Timing Slave in Point to Point topology. This test is covering only Backhaul - Timing Master configuration.

#### 3.3 Modifications Incorporated in the EUT

No modifications were made to the EUT during testing.

#### 3.4 Additional Information Related to Testing

<b>Technology Tested:</b>	Unrestricted Contention Based Protocol operation: Listen Before Talk	
<b>Type of Unit:</b>	Backhaul - Timing Master	
<b>Modulation:</b>	OFDM	
<b>External Antenna Gain:</b>	2 dBi	
<b>Power Supply Requirement:</b>	Nominal	802.3af PoE Supply
<b>Transmit &amp; Receive Frequency Range:</b>	3675 MHz	
<b>Channel Bandwidth:</b>	5/7/10/15/20/30/40 MHz	
<b>Transmit &amp; Receive Channel Tested:</b>	Channel Frequency (MHz):	three per band

#### 3.5 Support Equipment

The following support equipment was used to exercise the EUT during testing:

<b>Description:</b>	PTP450 Backhaul - Timing Slave
<b>Brand Name:</b>	Cambium Networks
<b>Software Version Number:</b>	CANOPY 16.1.1 (Build SIT-7)
<b>MAC Address:</b>	0a-00-3e-44-00-23

<b>Description:</b>	450i Access Point
<b>Brand Name:</b>	Cambium Networks
<b>Software Version Number:</b>	CANOPY 16.1.1 (Build SIT-7)
<b>MAC Address:</b>	0a-00-3e-45-11-9e

<b>Description:</b>	AC/DC Power Supply Unit
<b>Brand Name:</b>	Phihong
<b>Model Name or Number:</b>	PSA 15R-295(MOT)
<b>Serial Number:</b>	P81000498A1

<b>Description:</b>	AC/DC Power Supply Unit
<b>Brand Name:</b>	Phihong
<b>Model Name or Number:</b>	PSA 15R-240(MOT)
<b>Serial Number:</b>	P74215491A1

<b>Description:</b>	I.T.E Power Supply
<b>Model Name or Number:</b>	NU60-R550111-I3
<b>Serial Number:</b>	11000571371411000476

<b>Description:</b>	Desktop Computer
<b>Operation System:</b>	Windows 7 Professional, Service Pack 1
<b>MAC Address:</b>	68:05:CA:2A:DD:1C

<b>Description:</b>	Desktop Computer
<b>Operation System:</b>	Windows 7 Professional, Service Pack 1
<b>MAC Address:</b>	68:05:CA:2A:DD:1A

<b>Description:</b>	Apple laptop
<b>Model Name or Number:</b>	MacBook Air
<b>Serial Number:</b>	C02PJJV3GFWM



## 4. Operation and Monitoring of the EUT during Testing

### 4.1 Operating Modes

The EUT was tested in the following operating modes, unless otherwise stated

- The EUT was tested as a Master unit connected to a Slave transmitting using OFDM modulation as the manufacturer declared that as a representative modulation mode for LBT testing and further declared that the modulation mode used would not impact the results.

- The EUT has two receive channels which normally connect to vertically and horizontally polarized antennas.

- The device is operating at 3675 MHz carrier frequency.

- LBT Detection Threshold (dBm) =  $-73 \text{ dBm/MHz} + 10 \cdot \log(BW) + 23 - P_T + A$ , where BW is the channel bandwidth value;

$P_T$  is the sum of the conducted transmit power  $P_c$  and the transmit antenna gain  $A$ ;

$A$  is the antenna gain.

- The device was tested with antenna gain of 2 dBi. Therefore, the target LBT Detection Threshold is following:

for BW = 40 MHz: Detection Threshold =  $-73 + 16 + 23 - 30 + 2 = -62 \text{ dBm}$ .

for BW = 30 MHz: Detection Threshold =  $-73 + 15 + 23 - 29 + 2 = -62 \text{ dBm}$ .

for BW = 20 MHz: Detection Threshold =  $-73 + 13 + 23 - 27 + 2 = -62 \text{ dBm}$ .

for BW = 15 MHz: Detection Threshold =  $-73 + 12 + 23 - 26 + 2 = -62 \text{ dBm}$ .

for BW = 10 MHz: Detection Threshold =  $-73 + 10 + 23 - 24 + 2 = -62 \text{ dBm}$ .

for BW = 7 MHz: Detection Threshold =  $-73 + 8 + 23 - 23 + 2 = -63 \text{ dBm}$ .

for BW = 5 MHz: Detection Threshold =  $-73 + 7 + 23 - 21 + 2 = -62 \text{ dBm}$ .

### 4.2 Configuration and Peripherals

The EUT was tested in the following configurations(s):

- All measurements were made using a conducted link. The antenna ports gave independent access to horizontal and vertical antenna connections;

- A laptop PC was used to configure the EUT parameters during the testing using a standard web browser and via SSH. The laptop was connected to the EUT via Ethernet to set EUT parameters;

- When the system required channel loading a UDP data stream with predefined parameters was generated with iperf network testing tool. This stream was transferred from the laptop, connected to the master device (AP) to the laptop, connected to the slave device (SM).

## 5. Measurements, Examinations and Delivered Results

### 5.1 Test Results

Test Summary: CW signal was used as an interferer for unlike systems

<b>Test Engineer:</b>	Pavel Polyakov	<b>Test Dates:</b>	27 November 2019
<b>Test Sample MAC Address:</b>	0a-00-3e-44-00-66		

Environmental Conditions:

<b>Temperature (°C):</b>	27.6
<b>Relative Humidity (%):</b>	32

Results: CW was used as an interferer

Bandwidth	TX Off at 3660 MHz	TX Off at 3675 MHz	TX Off at 3690 MHz
5 MHz	-71 dBm	-71 dBm	-71 dBm
7 MHz	-71 dBm	-71 dBm	-72 dBm
10 MHz	-71 dBm	-70 dBm	-71 dBm
15 MHz	-71 dBm	-71 dBm	-72 dBm
20 MHz	-70 dBm	-70 dBm	-71 dBm

Bandwidth	Tx Off at 3670 MHz	Tx Off at 3675 MHz	Tx Off at 3680 MHz
30 MHz	-71 dBm	-71 dBm	-72 dBm
40 MHz	-69 dBm	-70 dBm	-70 dBm

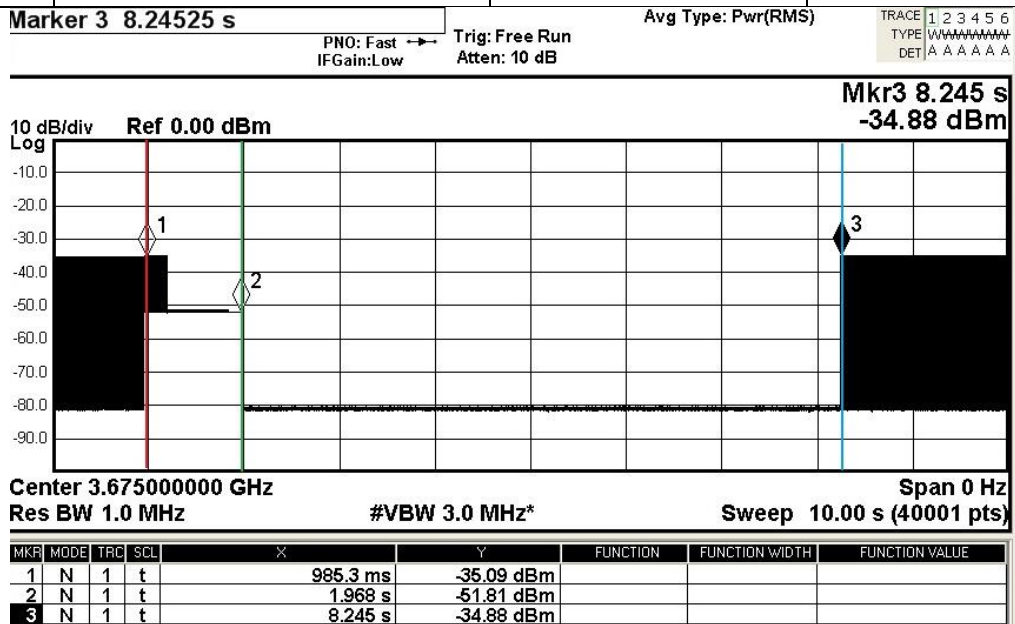

Red line – Interferer is on; Green line – Interferer is off; Blue line – TX is back on

Figure 1-1: TX of at 3675 MHz for 5 MHz channel

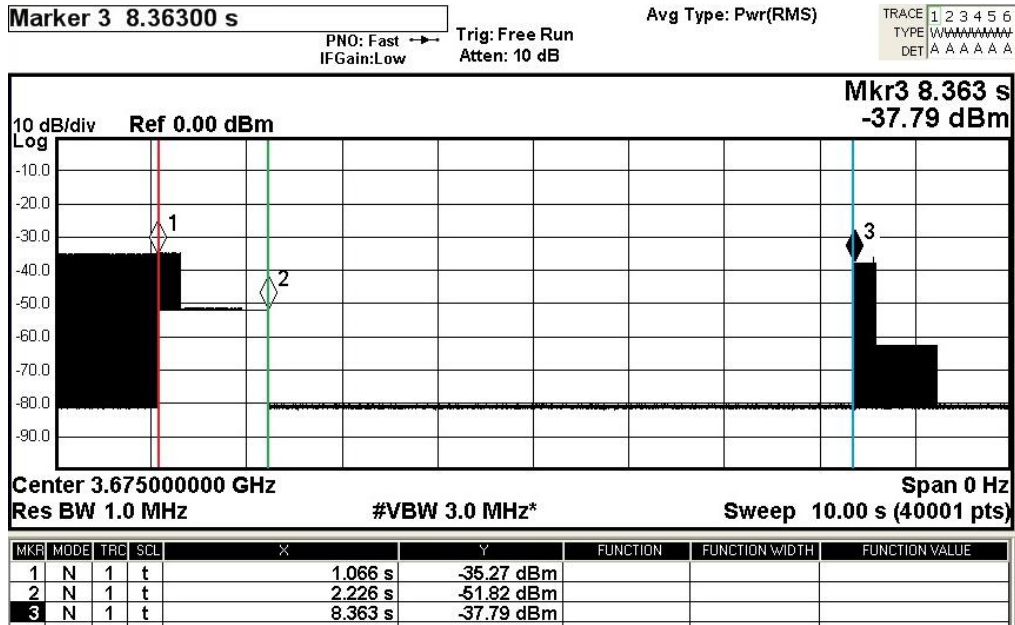

Red line – Interferer is on; Green line – Interferer is off; Blue line – TX is back on  
 Figure 1-2: TX of at 3675 MHz for 7 MHz channel

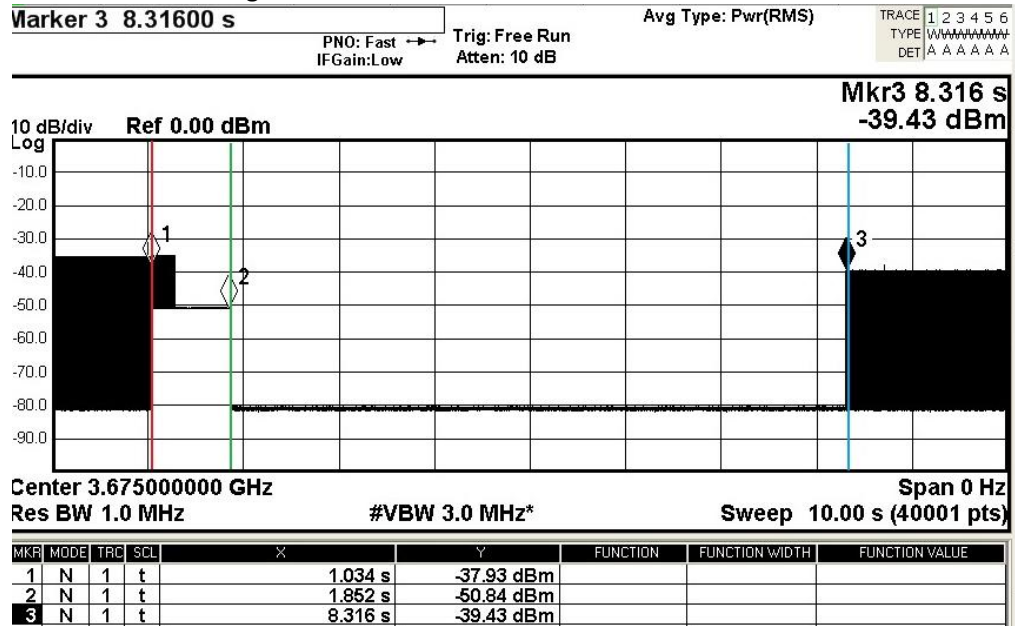

Red line – Interferer is on; Green line – Interferer is off; Blue line – TX is back on  
 Figure 1-3: TX of at 3675 MHz for 10 MHz channel

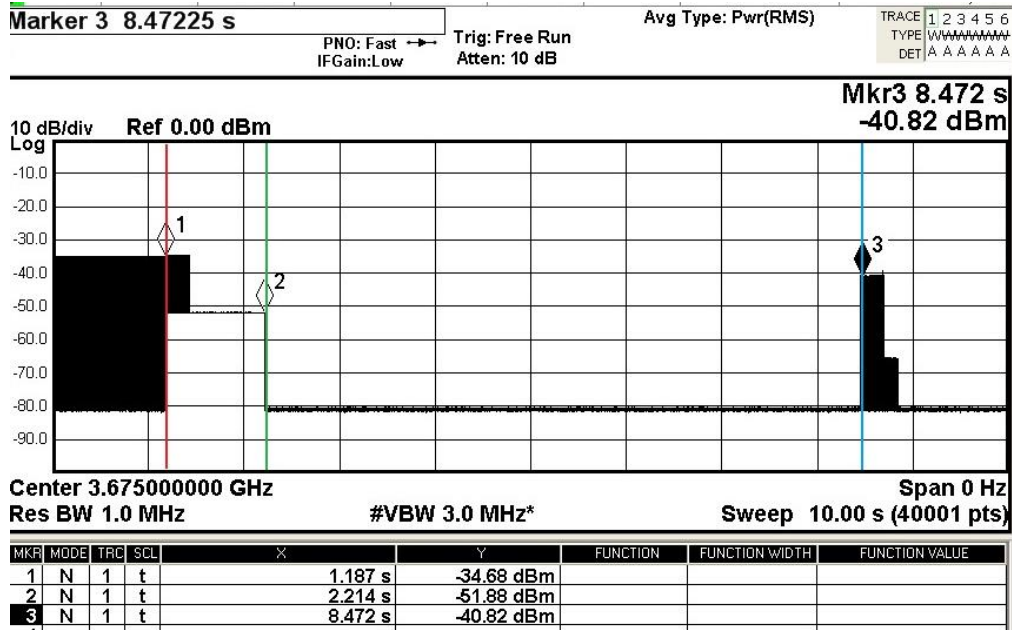

Red line – Interferer is on; Green line – Interferer is off; Blue line – TX is back on

Figure 1-4: TX of at 3675 MHz for 15 MHz channel



Red line – Interferer is on; Green line – Interferer is off; Blue line – TX is back on

Figure 1-5: TX of at 3675 MHz for 20 MHz channel

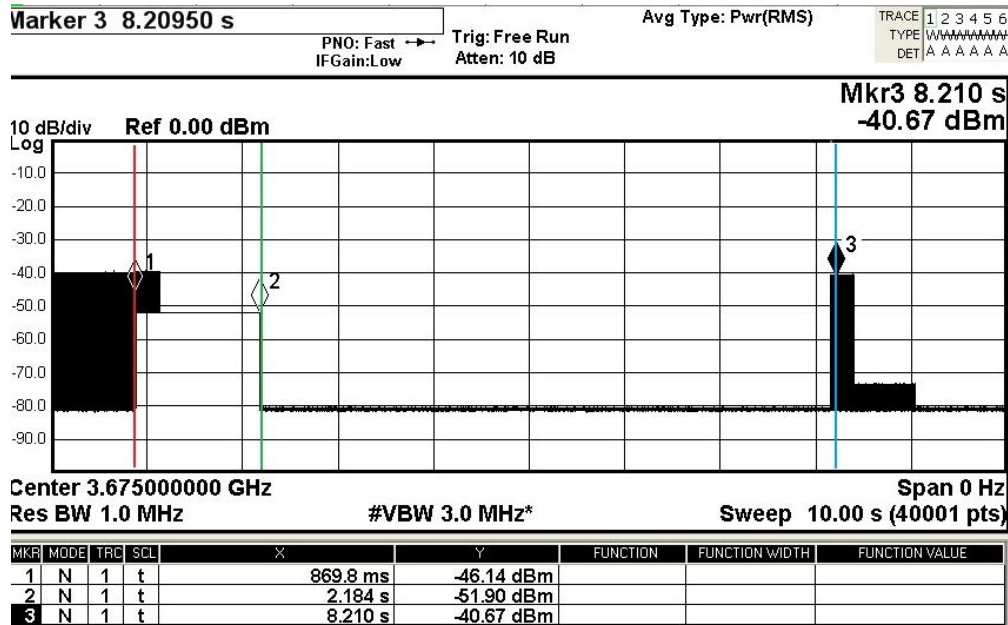

Red line – Interferer is on; Green line – Interferer is off; Blue line – TX is back on

Figure 1-6: TX of at 3675 MHz for 30 MHz channel

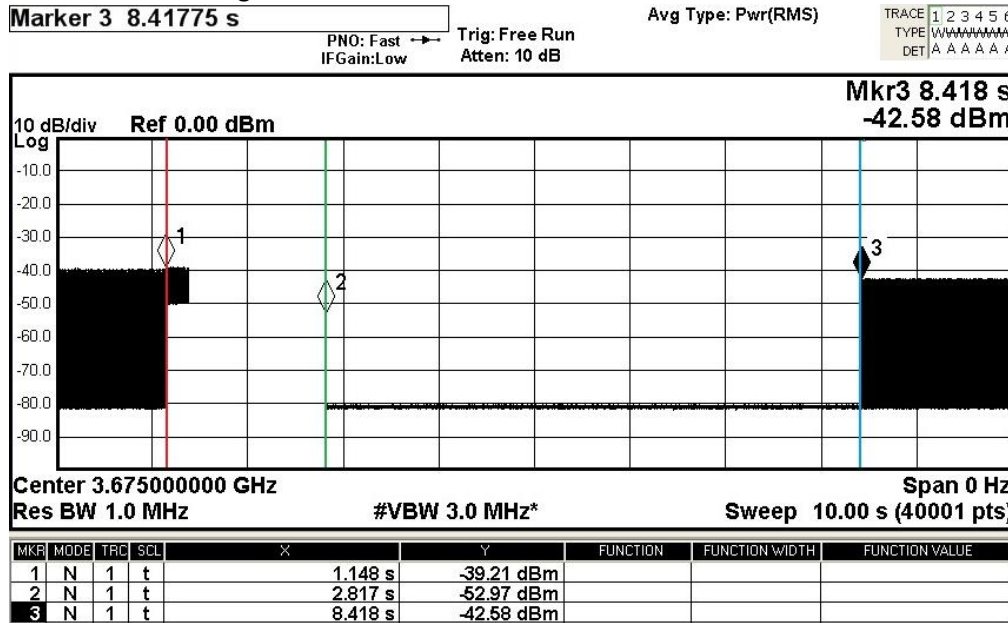

Red line – Interferer is on; Green line – Interferer is off; Blue line – TX is back on

Figure 1-7: TX of at 3675 MHz for 40 MHz channel

Test Summary: OFDM signal from the similar AP was used as an interferer

<b>Test Engineer:</b>	Pavel Polyakov	<b>Test Dates:</b>	27 November 2019
<b>Test Sample MAC Address:</b>	0a-00-3e-44-00-66		

Environmental Conditions:

<b>Temperature (°C):</b>	27.6
<b>Relative Humidity (%):</b>	32

450i Access Point that was used as a source of interference was configured to have 40 MHz channel bandwidth for each test case. With 2.5 ms frame the interfering signal is supposed to be turned on 100 % of the time, i.e. 2.5 ms. However, measurements showed that the actual 'on time' is less than that. Based on the calculations the time that the TX is open is 79.57 %. Please see the screenshot below:

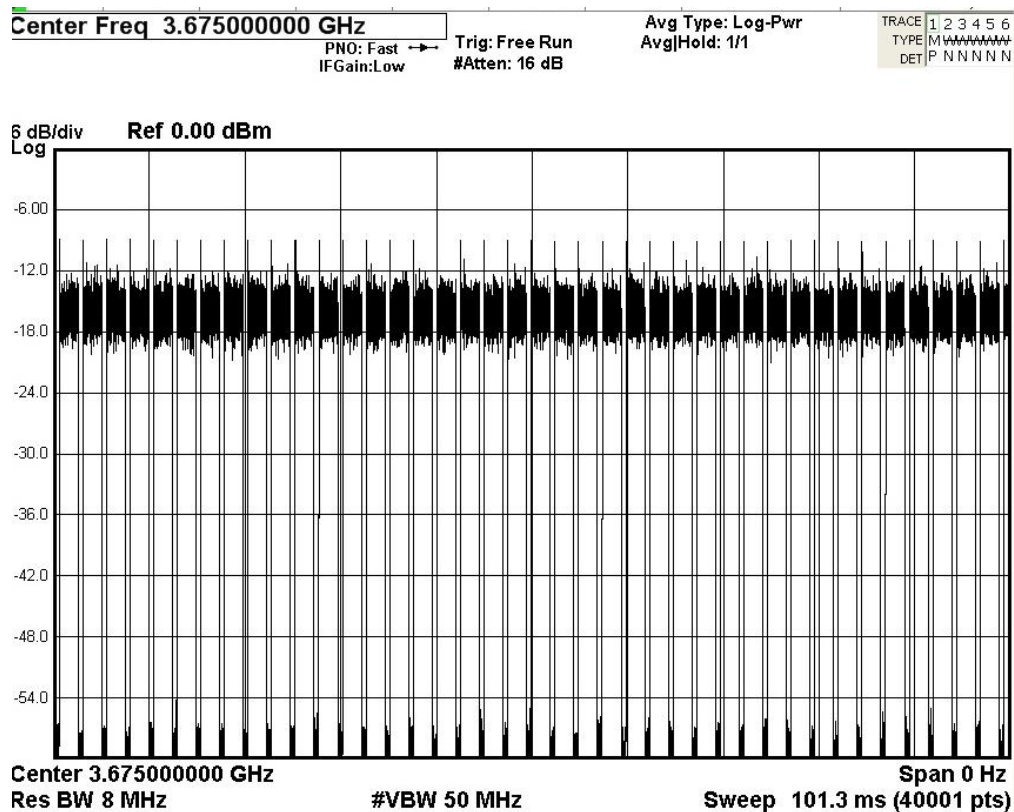

Taking in consideration the fact that the Access Point is not transmitting 100 % of the time the time domain correction factor should be taking into the account whilst calculating the detection threshold. This correction factor is calculated based on the following equation:  $Factor = 10 \cdot \log_{10}(Duty\ Cycle)$ , for this particular case the correction factor is  $10 \cdot \log_{10}(0.79) = -1.024\ dB$ . Therefore, all the thresholds calculated earlier goes up by 1.1 dB.

Results: at 3675 MHz carrier frequency

Bandwidth	TX Off without correction factor	TX Off with correction factor
5 MHz	-61 dBm	-62.1 dBm
7 MHz	-62 dBm	-63.1 dBm
10 MHz	-61 dBm	-62.1 dBm
15 MHz	-63 dBm	-64.1 dBm
20 MHz	-62 dBm	-63.1 dBm
30 MHz	-61 dBm	-62.1 dBm
40 MHz	-61 dBm	-62.1 dBm

## Appendix 1: Test Equipment Used

<b>Manufacturer</b>	<b>Description</b>	<b>Model</b>	<b>Date Calibration Due</b>
Agilent Technologies	MXA Signal Analyzer 20 Hz-8.4 GHz	N9020A	24 Jul 2020
Rohde & Schwarz	Vector Signal Generator	SMU200A	31 May 2020

Note: all cables, splitter and attenuators that were used for test setup were preliminary calibrated.

## Appendix 2: Monitoring Methods Diagrams

All tests were performed as conducted measurements using the setups as shown below.

Setup Diagram – EUT – Master, CW signal Injection at Master. Client Device acts as a Slave Device for this scenario.

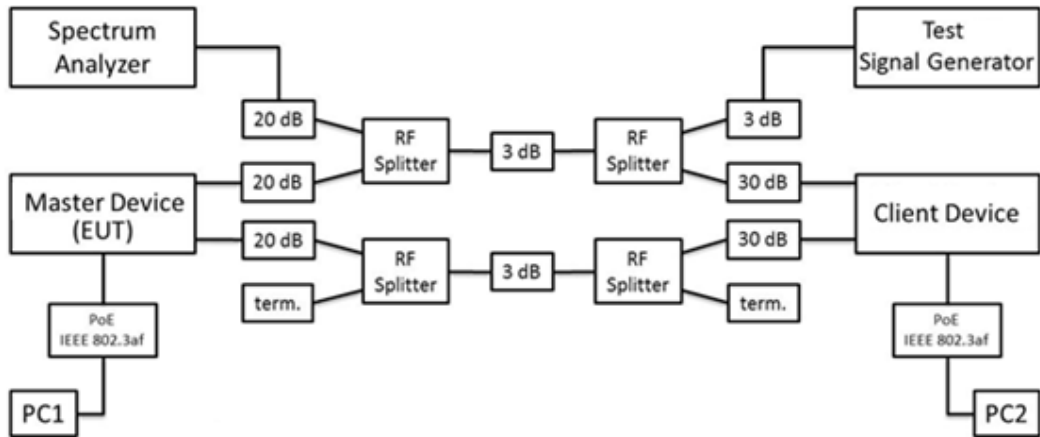

Note: for the test when a similar Canopy AP was used as an interferer, the CW Signal Generator was substituted for this AP for unlike system.