



# TEST REPORT

**Report No.** ..... : **CHEW22020044**      Report verification : 

**Project No.** ..... : **SHT2202013104EW**

**FCC ID**..... : **YY3-NX41P**

**Applicant's name**..... : **Handheld Group AB**

Address..... : Strandgatan 40 531 30 Lidköping Sweden

**Test item description** ..... : **Pistol grip**

Trade Mark ..... : handheld

Model/Type reference..... : NX41-P-PG

Listed Model(s) ..... : -

**Standard** ..... : **47 CFR FCC Part 15 Subpart B**

Date of receipt of test sample..... : Feb.22, 2022

Date of testing..... : Feb.23, 2022- Feb.27, 2022

Date of issue..... : Feb.28, 2022

**Result**..... : **Pass**

Compiled by  
 ( Position+Printed name+Signature): File administrator Fanghui Zhu

Supervised by  
 (Position+Printed name+Signature): Project Engineer Cheng Xiao

Approved by  
 (Position+Printed name+Signature): RF Manager Hans Hu

*Fanghui Zhu*

*Cheng Xiao*

*Hans Hu*

**Testing Laboratory Name** ..... : **Shenzhen Huatongwei International Inspection Co., Ltd.**

Address..... : 1/F, Bldg 3, Hongfa Hi-tech Industrial Park, Genyu Road, Tianliao, Gongming, Shenzhen, China

**Shenzhen Huatongwei International Inspection Co., Ltd. All rights reserved.**

This publication may be reproduced in whole or in part for non-commercial purposes as long as the Shenzhen Huatongwei International Inspection Co., Ltd. is acknowledged as copyright owner and source of the material. Shenzhen Huatongwei International Inspection Co., Ltd. takes no responsibility for and will not assume liability for damages resulting from the reader's interpretation of the reproduced material due to its placement and context.

*The test report merely corresponds to the test sample.*

## Contents

<b>1.</b>	<b><u>TEST STANDARDS AND REPORT VERSION .....</u></b>	<b><u>3</u></b>
1.1.	Test Standards	3
1.2.	Report version information	3
<b>2.</b>	<b><u>TEST DESCRIPTION .....</u></b>	<b><u>4</u></b>
<b>3.</b>	<b><u>SUMMARY.....</u></b>	<b><u>5</u></b>
3.1.	Client Information	5
3.2.	Product Description	5
3.3.	EUT operation mode	5
3.4.	Configuration of Tested System	5
<b>4.</b>	<b><u>TEST ENVIRONMENT .....</u></b>	<b><u>6</u></b>
4.1.	Testing Laboratory Information	6
4.2.	Environmental conditions	6
4.3.	Statement of the measurement uncertainty	6
4.4.	Equipments Used during the Test	7
<b>5.</b>	<b><u>TEST CONDITIONS AND RESULTS .....</u></b>	<b><u>8</u></b>
5.1.	Conducted Emissions Test	8
5.2.	Radiated Emissions Test	11
<b>6.</b>	<b><u>TEST SETUP PHOTOS OF THE EUT .....</u></b>	<b><u>15</u></b>
<b>7.</b>	<b><u>EXTERNAL AND INTERNAL PHOTOS OF THE EUT .....</u></b>	<b><u>16</u></b>

## 1. TEST STANDARDS AND REPORT VERSION

### 1.1. Test Standards

The tests were performed according to following standards:

[47 CFR FCC Part 15 Subpart B](#) - Unintentional Radiators

[ANSI C63.4: 2014](#) – American National Standard for Methods of Measurement of Radio-Noise Emissions from Low-Voltage Electrical and Electronic Equipment in the Range of 9 kHz to 40GHz

### 1.2. Report version information

Revision No.	Date of issue	Description
N/A	2022-02-28	Original

## 2. TEST DESCRIPTION

Test Item	Section in CFR 47	Result	Test Engineer
Conducted Emissions	15.107(a)	pass	Hongtao Meng
Radiated Emissions	15.109(a)	pass	Hongbin Zhong

Note: The measurement uncertainty is not included in the test result.

### 3. SUMMARY

#### 3.1. Client Information

Applicant:	Handheld Group AB
Address:	Strandgatan 40 531 30 Lidköping Sweden
Manufacturer:	Handheld Group AB
Address:	Strandgatan 40 531 30 Lidköping Sweden

#### 3.2. Product Description

Name of EUT:	Pistol grip
Trade Mark:	handheld
Model No.:	NX41-P-PG
Listed Model(s)	-
Power supply:	DC 3.6V from battery
Adapter Information:	Model: FJ-SW1260502000UN Input: 100-240Va.c., 50/60Hz 0.4A Max Output: 5.0Vd.c., 2.0A, 10.0W MFR:SHENZHEN FUJIA APPLIANCE CO.,LTD.
Hardware version:	V3.1
Software version:	URB7_V1.2.1

#### 3.3. EUT operation mode

Test mode	Describe
Charging mode	Keep the EUT in charging status

#### 3.4. Configuration of Tested System

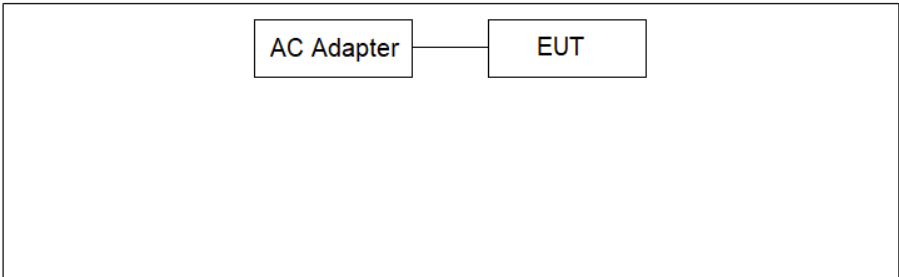
Test mode	Configuration
Charging mode	 <pre> graph LR     AC[AC Adapter] --- EUT[EUT]           </pre>

## 4. TEST ENVIRONMENT

### 4.1. Testing Laboratory Information

Laboratory Name	Shenzhen Huatongwei International Inspection Co., Ltd.	
Laboratory Location	1/F, Bldg 3, Hongfa Hi-tech Industrial Park, Genyu Road, Tianliao, Gongming, Shenzhen, China	
Connect information:	Tel: 86-755-26715499 E-mail: <a href="mailto:cs@szhtw.com.cn">cs@szhtw.com.cn</a> <a href="http://www.szhtw.com.cn">http://www.szhtw.com.cn</a>	
Qualifications	Type	Accreditation Number
	FCC	762235

### 4.2. Environmental conditions

During the measurement the environmental conditions were within the listed ranges:

Temperature:	15~35°C
Relative Humidity:	30~60 %
Air Pressure:	950~1050mba

### 4.3. Statement of the measurement uncertainty

The data and results referenced in this document are true and accurate. The reader is cautioned that there may be errors within the calibration limits of the equipment and facilities. The measurement uncertainty was calculated for all measurements listed in this test report acc. to CISPR 16 - 4 „Specification for radio disturbance and immunity measuring apparatus and methods – Part 4: Uncertainty in EMC Measurements“ and is documented in the Shenzhen Huatongwei International Inspection Co., Ltd quality system acc. to DIN EN ISO/IEC 17025. Furthermore, component and process variability of devices similar to that tested may result in additional deviation. The manufacturer has the sole responsibility of continued compliance of the device.

Hereafter the best measurement capability for Shenzhen Huatongwei laboratory is reported:

Test	Range	Measurement Uncertainty	Notes
Radiated Emissions	30~1000MHz	4.36 dB	(1)
Radiated Emissions	1~18GHz	5.10 dB	(1)
Conducted Disturbance	0.15~30MHz	3.00 dB	(1)

(1) This uncertainty represents an expanded uncertainty expressed at approximately the 95% confidence level using a coverage factor of k=1.96.

#### 4.4. Equipments Used during the Test

● Conducted Emission							
Used	Test Equipment	Manufacturer	Equipment No.	Model No.	Serial No.	Last Cal. Date (YY-MM-DD)	Next Cal. Date (YY-MM-DD)
●	Shielded Room	Albatross projects	HTWE0114	N/A	N/A	2018/09/28	2023/09/27
●	EMI Test Receiver	R&S	HTWE0111	ESCI	101247	2021/09/14	2022/09/13
●	Artificial Mains	SCHWARZBECK	HTWE0113	NNLK 8121	573	2021/09/17	2022/09/16
●	Pulse Limiter	R&S	HTWE0193	ESH3-Z2	101447	2021/09/16	2022/09/15
●	RF Connection Cable	HUBER+SUHNER	HTWE0113-02	ENVIROFLE X_142	EF-NM-BNCM-2M	2021/9/17	2022/9/16
●	Test Software	R&S	N/A	ES-K1	N/A	N/A	N/A

● Radiated emission-6th test site							
Used	Test Equipment	Manufacturer	Equipment No.	Model No.	Serial No.	Last Cal. Date (YY-MM-DD)	Next Cal. Date (YY-MM-DD)
●	Semi-Anechoic Chamber	Albatross projects	HTWE0127	SAC-3m-02	C11121	2018/09/30	2022/09/29
●	EMI Test Receiver	R&S	HTWE0099	ESCI	100900	2021/09/14	2022/09/13
●	Loop Antenna	R&S	HTWE0170	HFH2-Z2	100020	2021/04/06	2024/04/05
●	Ultra-Broadband Antenna	SCHWARZBECK	HTWE0123	VULB9163	538	2021/04/06	2024/04/05
●	Pre-Amplifier	SCHWARZBECK	HTWE0295	BBV 9742	N/A	2021/11/05	2022/11/04
●	RF Connection Cable	HUBER+SUHNER	HTWE0062-01	N/A	N/A	2021/02/26	2022/02/25
●	RF Connection Cable	HUBER+SUHNER	HTWE0062-02	SUCOFLEX104	501184/4	2021/02/26	2022/02/25
●	Test Software	R&S	N/A	ES-K1	N/A	N/A	N/A

● Radiated emission-7th test site							
Used	Test Equipment	Manufacturer	Equipment No.	Model No.	Serial No.	Last Cal. Date (YY-MM-DD)	Next Cal. Date (YY-MM-DD)
●	Semi-Anechoic Chamber	Albatross projects	HTWE0122	SAC-3m-01	C11121	2018/09/27	2022/09/26
●	Spectrum Analyzer	R&S	HTWE0098	FSP40	100597	2021/09/13	2022/09/12
●	Horn Antenna	SCHWARZBECK	HTWE0126	9120D	1011	2020/04/01	2023/03/31
●	Broadband Horn Antenna	SCHWARZBECK	HTWE0103	BBHA9170	BBHA9170472	2020/04/27	2023/04/26
●	Pre-amplifier	CD	HTWE0071	PAP-0102	12004	2021/11/05	2022/11/04
●	Broadband Pre-amplifier	SCHWARZBECK	HTWE0201	BBV 9718	9718-248	2021/03/05	2022/03/04
●	RF Connection Cable	HUBER+SUHNER	HTWE0120-01	6m 18GHz S Serisa	N/A	2021/02/26	2022/02/25
●	RF Connection Cable	HUBER+SUHNER	HTWE0120-02	6m 3GHz RG Serisa	N/A	2021/02/26	2022/02/25
●	RF Connection Cable	HUBER+SUHNER	HTWE0119-05	6m 3GHz RG Serisa	N/A	2021/02/26	2022/02/25
●	RF Connection Cable	HUBER+SUHNER	HTWE0120-04	6m 3GHz RG Serisa	N/A	2021/02/26	2022/02/25
●	Test Software	Audix	N/A	E3	N/A	N/A	N/A

## 5. TEST CONDITIONS AND RESULTS

### 5.1. Conducted Emissions Test

#### LIMIT

FCC CFR Title 47 Part 15 Subpart B Section 15.107:

Frequency range (MHz)	Limit (dBuV)	
	Quasi-peak	Average
0.15-0.5	66 to 56*	56 to 46*
0.5-5	56	46
5-30	60	50

\* Decreases with the logarithm of the frequency.

#### TEST CONFIGURATION

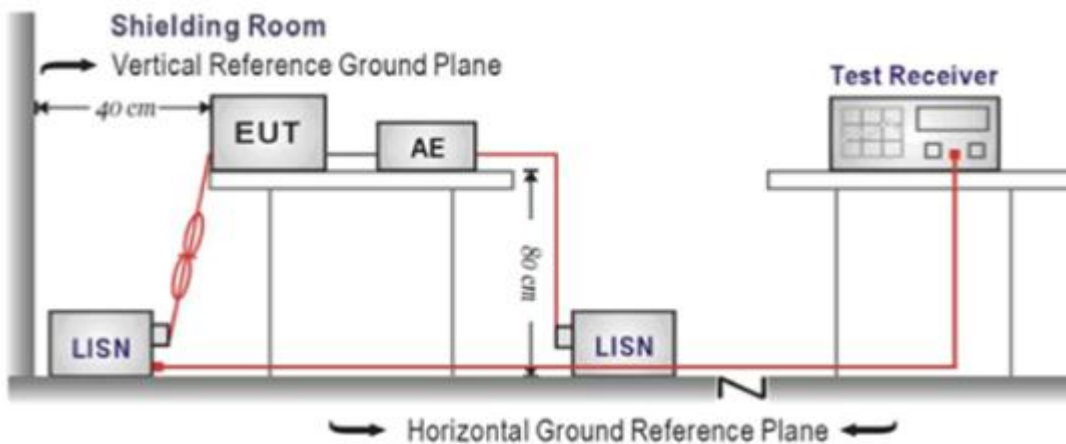

#### TEST PROCEDURE

1. The EUT was setup according to ANSI C63.4:2014
2. The EUT was placed on a plat form of nominal size, 1 m by 1.5 m, raised 80 cm above the conducting ground plane. The vertical conducting plane was located 40 cm to the rear of the EUT. All other surfaces of EUT were at least 80 cm from any other grounded conducting surface.
3. The EUT and simulators are connected to the main power through a line impedance stabilization network (LISN). The LISN provides a 50ohm / 50uH coupling impedance for the measuring equipment.
4. The peripheral devices are also connected to the main power through a LISN. (Please refer to the block diagram of the test setup and photographs)
5. Each current-carrying conductor of the EUT power cord, except the ground (safety) conductor, was individually connected through a LISN to the input power source.
6. The excess length of the power cord between the EUT and the LISN receptacle were folded back and forth at the center of the lead to form a bundle not exceeding 40 cm in length.
7. Conducted emissions were investigated over the frequency range from 0.15MHz to 30MHz using a receiver bandwidth of 9 kHz.
8. During the above scans, the emissions were maximized by cable manipulation.

#### TEST MODE:

Please refer to the clause 3.3

#### TEST RESULTS

Passed  Not Applicable



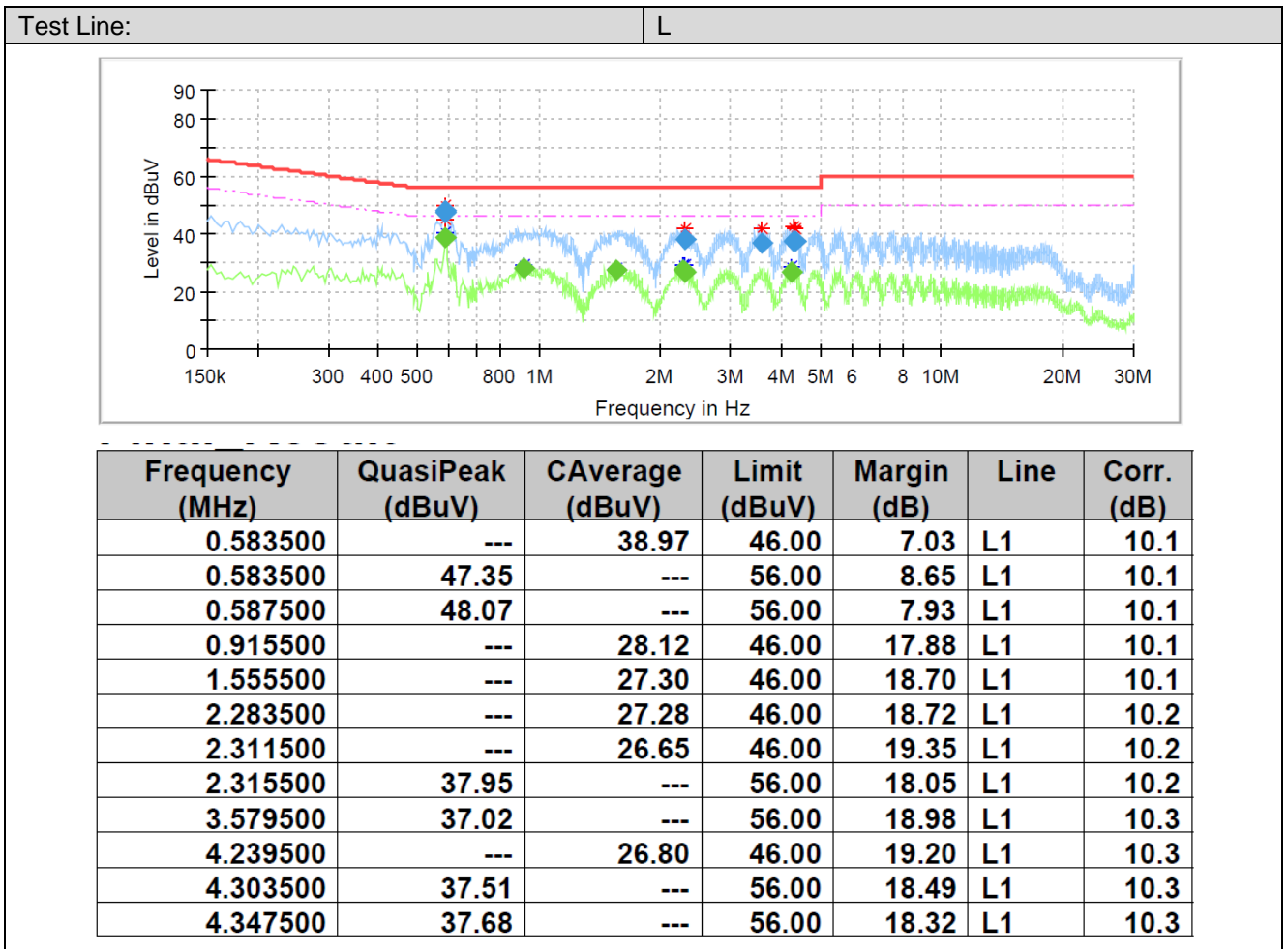

Test Line:

N

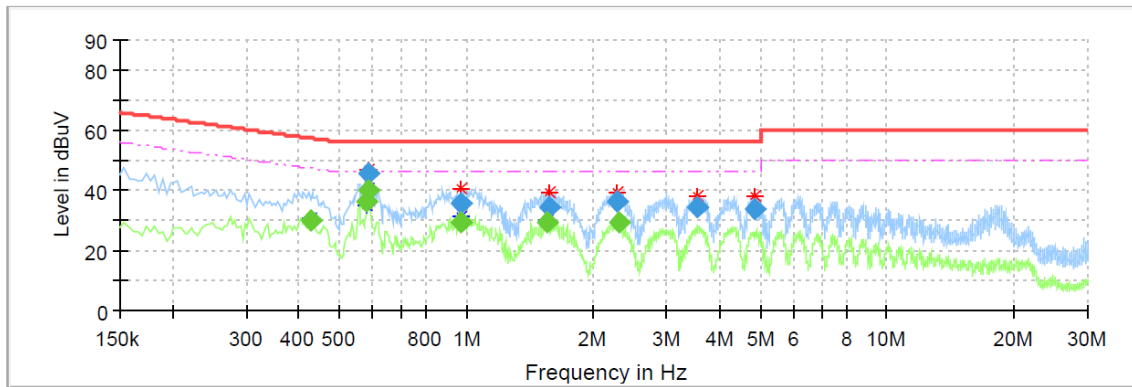

Frequency (MHz)	QuasiPeak (dBuV)	CAverage (dBuV)	Limit (dBuV)	Margin (dB)	Line	Corr. (dB)
0.427500	---	30.12	47.30	17.18	N	10.1
0.580500	---	36.18	46.00	9.82	N	10.1
0.587500	---	40.03	46.00	5.97	N	10.1
0.587500	45.49	---	56.00	10.51	N	10.1
0.967500	---	29.47	46.00	16.53	N	10.1
0.975500	35.55	---	56.00	20.45	N	10.1
1.555500	---	29.07	46.00	16.93	N	10.1
1.575500	34.57	---	56.00	21.43	N	10.1
2.287500	36.23	---	56.00	19.77	N	10.1
2.315500	---	29.31	46.00	16.69	N	10.1
3.555500	34.23	---	56.00	21.77	N	10.2
4.828500	33.52	---	56.00	22.48	N	10.3

## 5.2. Radiated Emissions Test

### LIMIT

#### FCC CFR Title 47 Part 15 Subpart B Section 15.109

Frequency	Limit (dBuV/m @3m)	Value
30MHz-88MHz	40.00	Quasi-peak
88MHz-216MHz	43.50	Quasi-peak
216MHz-960MHz	46.00	Quasi-peak
960MHz-1GHz	54.00	Quasi-peak
Above 1GHz	54.00	Average
	74.00	Peak

### TEST CONFIGURATION

#### ➤ 30MHz ~ 1GHz

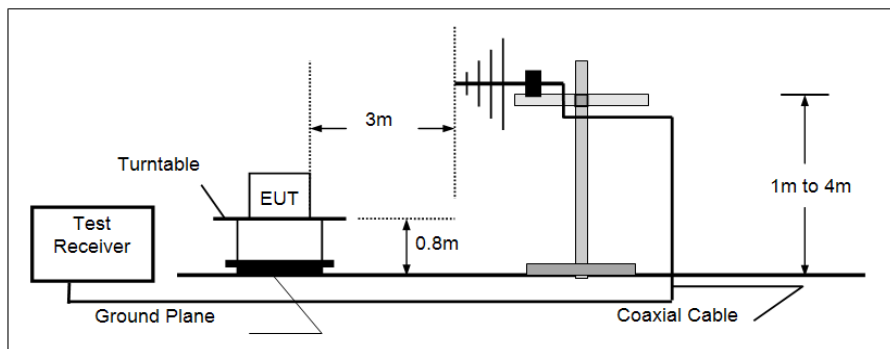

#### ➤ Above 1GHz

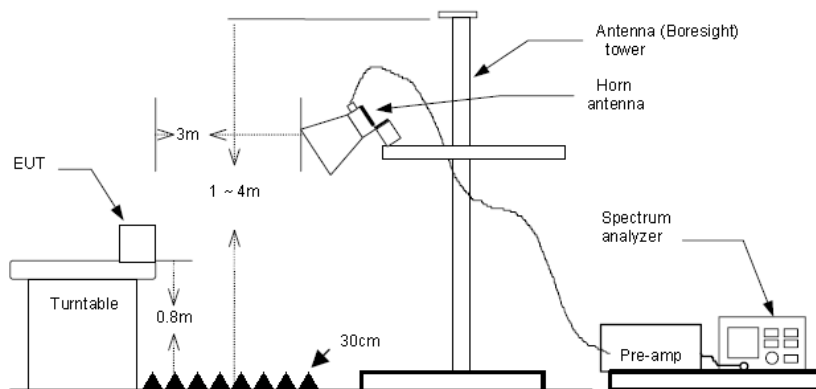

### TEST PROCEDURE

1. The EUT was tested according to ANSI C63.4:2014.
2. The EUT is placed on a turn table which is 0.8 meter above ground.
3. The turn table is rotated 360 degrees to determine the position of the maximum emission level.
4. The EUT was positioned such that the distance from antenna to the EUT was 3 meters.
5. The antenna is scanned from 1 meter to 4 meters to find out the maximum emission level. This is repeated for both horizontal and vertical polarization of the antenna.
6. Use the following spectrum analyzer settings
  - (1) Span shall wide enough to fully capture the emission being measured;
  - (2) Below 1GHz,  
 RBW=120KHz, VBW=300KHz, Sweep=auto, Detector function=peak, Trace=max hold;  
 If the emission level of the EUT measured by the peak detector is 3 dB lower than the applicable limit, the peak emission level will be reported. Otherwise, the emission measurement will be repeated using the quasi-peak detector and reported.
  - (3) From 1GHz to 5th harmonic, RBW=1MHz, VBW=3MHz

**TEST MODE:**

Please refer to the clause 3.3

**TEST RESULTS**

**Passed**       **Not Applicable**

Note: Final Level = Receiver Read level + Antenna Factor + Cable Loss – Preamplifier Factor  
The emission levels of frequency above 6GHz are very lower than limit and not show in test report.

Polarization: Horizontal

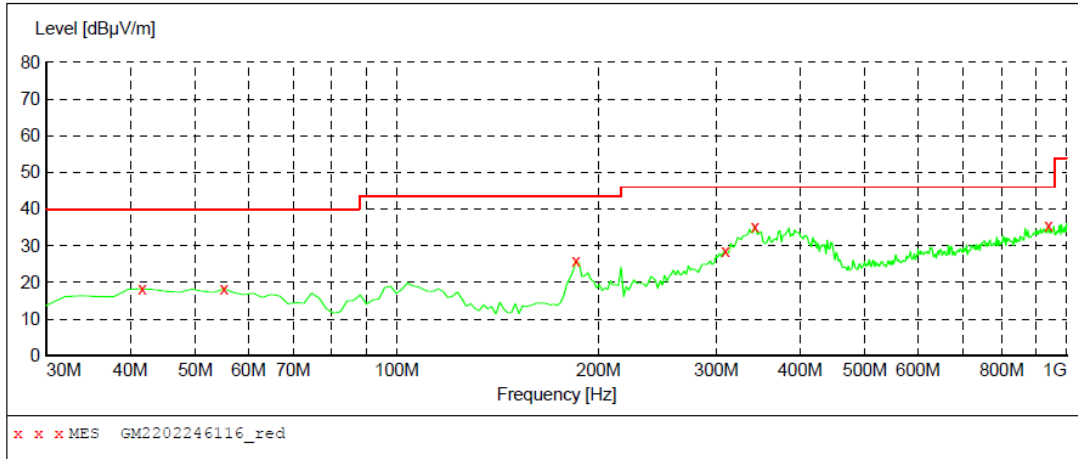

**MEASUREMENT RESULT: "GM2202246116\_red"**

2/24/2022 10:43PM

Frequency MHz	Level dBuV/m	Transd dB	Limit dBuV/m	Margin dB	Det.	Height cm	Azimuth deg	Polarization
41.640000	18.30	-9.5	40.0	21.7	QP	100.0	344.00	HORIZONTAL
55.220000	18.30	-9.2	40.0	21.7	QP	100.0	66.00	HORIZONTAL
185.200000	25.80	-11.8	43.5	17.7	QP	100.0	281.00	HORIZONTAL
309.360000	28.60	-7.1	46.0	17.4	QP	100.0	166.00	HORIZONTAL
342.340000	35.20	-5.7	46.0	10.8	QP	100.0	178.00	HORIZONTAL
939.860000	35.40	7.2	46.0	10.6	QP	100.0	305.00	HORIZONTAL

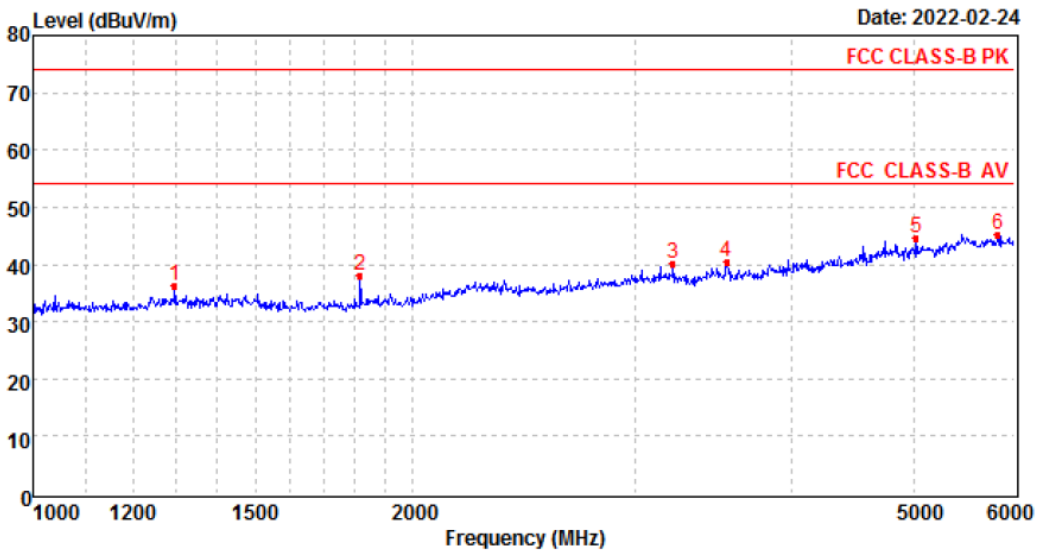

Mark	Frequency MHz	Reading dBuV/m	Antenna dB	Cable dB	Preamp dB	Level dBuV/m	Limit dBuV/m	Over limit	Remark
1	1294.36	42.93	25.99	4.02	36.76	36.18	74.00	-37.82	Peak
2	1816.04	44.87	25.46	4.78	37.08	38.03	74.00	-35.97	Peak
3	3216.29	42.09	28.83	6.48	37.14	40.26	74.00	-33.74	Peak
4	3549.38	41.25	29.30	6.85	36.99	40.41	74.00	-33.59	Peak
5	5015.75	38.61	31.99	8.83	34.84	44.59	74.00	-29.41	Peak
6	5820.00	36.87	32.08	9.59	33.33	45.21	74.00	-28.79	Peak

Polarization: Vertical

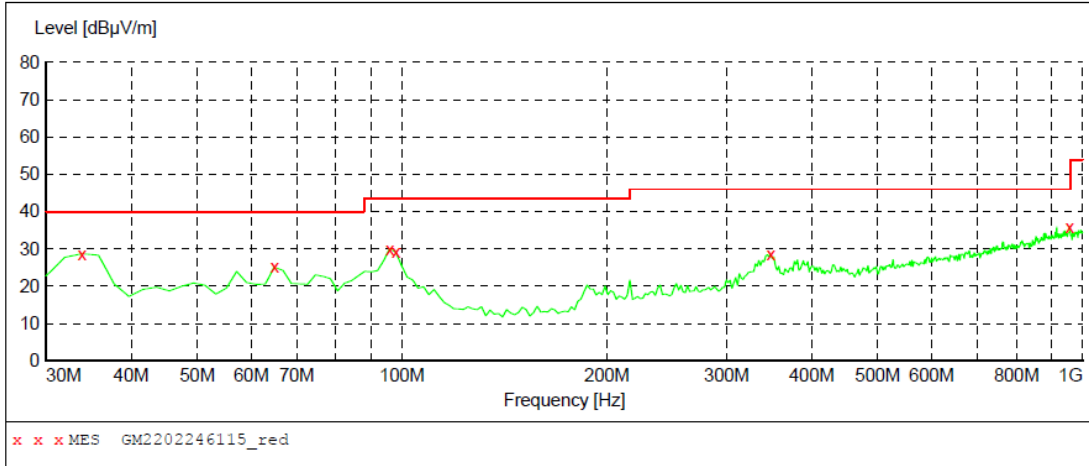

**MEASUREMENT RESULT: "GM2202246115\_red"**

2/24/2022 10:41PM

Frequency MHz	Level dBuV/m	Transd dB	Limit dBuV/m	Margin dB	Det.	Height cm	Azimuth deg	Polarization
33.880000	28.70	-12.0	40.0	11.3	QP	100.0	0.00	VERTICAL
64.920000	25.10	-11.2	40.0	14.9	QP	100.0	78.00	VERTICAL
95.960000	30.00	-11.3	43.5	13.5	QP	100.0	156.00	VERTICAL
97.900000	29.20	-11.1	43.5	14.3	QP	100.0	168.00	VERTICAL
348.160000	28.50	-5.4	46.0	17.5	QP	100.0	216.00	VERTICAL
957.320000	36.00	7.5	46.0	10.0	QP	100.0	204.00	VERTICAL

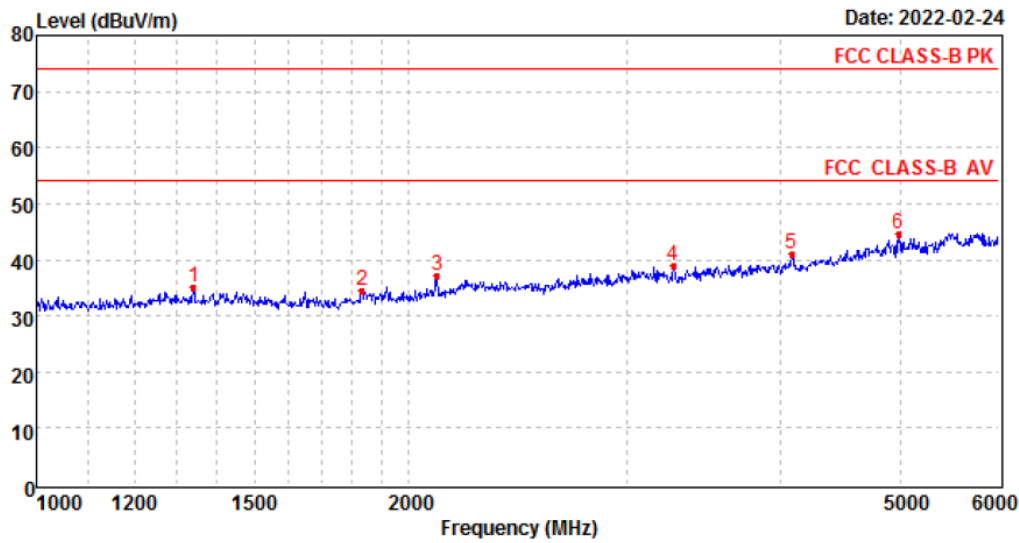

Mark	Frequency MHz	Reading dBuV/m	Antenna dB	Cable dB	Preamp dB	Level dBuV/m	Limit dBuV/m	Over limit	Remark
1	1339.18	40.93	26.24	4.09	36.27	34.99	74.00	-39.01	Peak
2	1832.38	41.42	25.53	4.80	37.11	34.64	74.00	-39.36	Peak
3	2107.23	42.38	27.19	5.17	37.47	37.27	74.00	-36.73	Peak
4	3274.43	40.52	28.60	6.55	36.81	38.86	74.00	-35.14	Peak
5	4081.77	39.80	30.00	7.46	36.29	40.97	74.00	-33.03	Peak
6	4979.93	38.77	31.74	8.80	34.78	44.53	74.00	-29.47	Peak

## 6. TEST SETUP PHOTOS OF THE EUT

### Conducted Emissions (AC Mains)

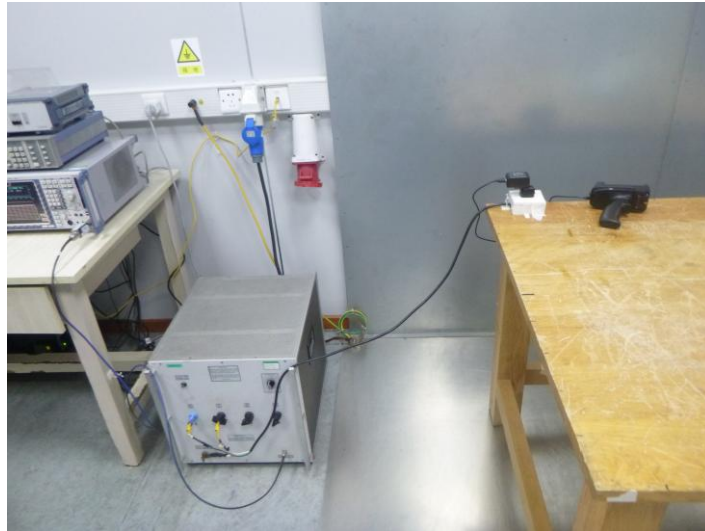

### Radiated Emissions (30MHz-1GHz)

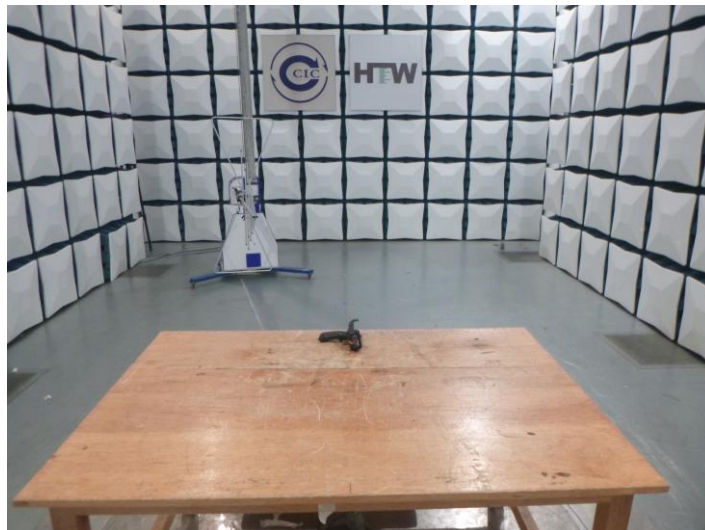

### Radiated Emissions (Above 1GHz)

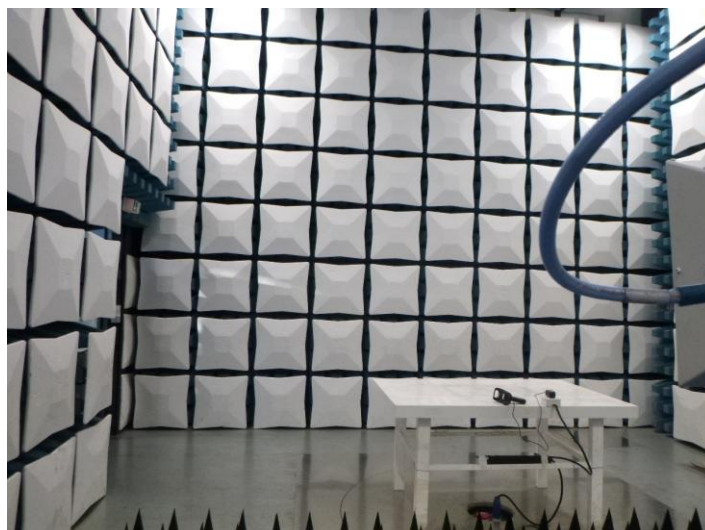

## **7. EXTERNAL AND INTERNAL PHOTOS OF THE EUT**

Reference to the test report No.: CHTEW22020043

-----End of Report-----