



SAR Test Report

Report No.: AGC01270131102FH01

FCC ID : YSEGO202

APPLICATION PURPOSE : Original Equipment

PRODUCT DESIGNATION : Mobile Phone

BRAND NAME : GOMOBILE

MODEL NAME : G0202

CLIENT : Nexus Telecom Inc.

DATE OF ISSUE : Nov.14, 2013

STANDARD(S) : IEEE Std. 1528:2003
47CFR § 2.1093
IEEE/ANSI C95.1

REPORT VERSION : V1.0

Attestation of Global Compliance(Shenzhen) Co., Ltd.



CAUTION:

This report shall not be reproduced except in full without the written permission of the test laboratory and shall not be quoted out of context.

Report Revise Record

Report Version	Revise Time	Issued Date	Valid Version	Notes
V1.0	/	Nov.14, 2013	Valid	Original Report

The test plans were performed in accordance with IEEE Std. 1528:2003; 47CFR § 2.1093; IEEE/ANSI C95.1 and the following specific FCC Test Procedures:

- KDB 447498 D01 General RF Exposure Guidance v05r01
- KDB 648474 D04 SAR Handsets Multi Xmitter and Ant v01
- KDB 865664 D01 SAR measurement 100 MHz to 6 GHz v01
- KDB 941225 D03 SAR Test Reduction GSM GPRS EDGE v01

Test Report Certification	
Applicant Name	Nexus Telecom Inc.
Applicant Address	PO Box 873, Venterpool Plaza 873 Road Town, Tortola Virgin Islands (British)
Manufacturer Name	ShenZhen Moses Intelligent Technology Co., LTD.
Manufacturer Address	613. B Building. Tao Hua Yuan Technology Innovation Park. Baoan. ShenZhen
Product Designation	Mobile Phone
Brand Name	GOMOBILE
Model Name	GO202
Different Description	All the same except for the color and SIM Card slot (the color in black has two SIM card slots, white has just one).
EUT Voltage	DC3.7V by battery
Applicable Standard	IEEE Std. 1528:2003 47CFR § 2.1093 IEEE/ANSI C95.1
Test Date	Nov.13, 2013
Performed Location	Attestation of Global Compliance(Shenzhen) Co., Ltd.
	2 F, Building 2, No.1-No.4, Chaxi Sanwei Technical Industrial Park, Gushu, Xixiang Street, Bao'an District, Shenzhen, China
Report Template	AGCRT-US-2.5G/SAR (2013-03-01)

Tested By 
Eric Zhou Nov.14, 2013

Checked By 
Angela Li Nov.14, 2013

Authorized By 
Solger Zhang Nov.14, 2013

TABLE OF CONTENTS

1. SUMMARY OF MAXIMUM SAR VALUE	5
2. GENERAL INFORMATION	6
2.1. EUT DESCRIPTION.....	6
2.2. TEST PROCEDURE	8
2.3. TEST ENVIRONMENT.....	8
2.4. TEST CONFIGURATION AND SETTING	9
3. SAR MEASUREMENT SYSTEM	10
3.1. SPECIFIC ABSORPTION RATE (SAR).....	10
3.2. SAR MEASUREMENT PROCEDURE	11
3.3. COMOSAR SYSTEM DESCRIPTION	12
3.4. COMOSAR E-FIELD PROBE.....	14
3.5. ISOTROPIC E-FIELD PROBE SPECIFICATION	14
3.6. ROBOT	14
3.7. VIDEO POSITIONING SYSTEM.....	15
3.8. DEVICE HOLDER	15
3.9. SAM TWIN PHANTOM	16
4. TISSUE SIMULATING LIQUID	17
4.1. THE COMPOSITION OF THE TISSUE SIMULATING LIQUID.....	17
4.2. TISSUE CALIBRATION RESULT	18
4.3. TISSUE DIELECTRIC PARAMETERS FOR HEAD AND BODY PHANTOMS	19
5. SAR MEASUREMENT PROCEDURE	20
5.1. SAR SYSTEM VALIDATION PROCEDURES	20
5.2. SAR SYSTEM VALIDATION	21
6. EUT TEST POSITION	23
6.1. DEFINE TWO IMAGINARY LINES ON THE HANDSET.....	23
6.2. CHEEK POSITION	24
6.3. TITLE POSITION	24
6.4. BODY WORN POSITION.....	25
7. SAR EXPOSURE LIMITS	26
8. TEST EQUIPMENT LIST	27
9. MEASUREMENT UNCERTAINTY	28
10. CONDUCTED POWER MEASUREMENT	29
11. TEST RESULTS	31
11.1. SAR TEST RESULTS SUMMARY	31
APPENDIX A. SAR SYSTEM VALIDATION DATA	38
APPENDIX B. SAR MEASUREMENT DATA	42
APPENDIX C. TEST SETUP PHOTOGRAPHS &EUT PHOTOGRAPHS	82
APPENDIX D. PROBE CALIBRATION DATA	94
APPENDIX E. DIPOLE CALIBRATION DATA	104

1. SUMMARY OF MAXIMUM SAR VALUE

The maximum results of Specific Absorption Rate (SAR) found during testing for EUT are as follows:

Highest Report standalone SAR Summary

Exposure Position	Frequency Band	Highest Reported 1g-SAR(W/Kg)	Highest Reported 1g-SAR(W/Kg)
Head	GSM 835	0.605	0.605
	PCS 1900	0.593	
Body- worn	GSM 835	1.103	1.103
	PCS 1900	0.725	

Maximum Scaling standalone SAR Summary

Exposure Position	Frequency Band	Frequency(MHz)	Maximum Scaling 1g-SAR(W/Kg)
Body Back	GSM 835	824.2	1.317

Highest Simultaneous transmission SAR Summary

Exposure Position	Frequency Band	Highest Reported 1g-SAR(W/Kg)	Highest Reported 1g-SAR(W/Kg)
Head	GSM 835+Bluetooth	0.665	0.665
	PCS 1900+Bluetooth	0.653	
Body- worn	GSM 835+Bluetooth	1.163	1.163
	PCS 1900+Bluetooth	0.785	

This device is compliance with Specific Absorption Rate (SAR) for general population/uncontrolled exposure limits (1.6W/Kg) specified in FCC 47 CFR part 2 (2.1093) and ANSI/IEEE C95.1, and had been tested in accordance with measurement methods and procedures specified in IEEE 1528-2003 and the relevant KDB files like KDB 941225 D01 , KDB 941225 D03 ,KDB 865664 D02....etc.

2. GENERAL INFORMATION

2.1. EUT Description

General Information	
Product Designation	Mobile Phone
Test Model	GO202
Hardware Version	A130-MB-V1.0
Software Version	N/A
Device Category	Portable
RF Exposure Environment	Uncontrolled
Antenna Type	Internal
GSM and GPRS	
Support Band	<input checked="" type="checkbox"/> GSM 850 <input checked="" type="checkbox"/> PCS 1900 (U.S. Bands) <input checked="" type="checkbox"/> GSM 900 <input checked="" type="checkbox"/> DCS 1800 (Non-U.S. Bands)
GPRS Type	Class B
GPRS Class	Class 12(1Tx+4Rx, 2Tx+3Rx, 3Tx+2Rx, 4Tx+1Rx)
TX Frequency Range	GSM 850 : 824.2~848.8MHz; PCS 1900: 1850.2~1909.8MHz;
RX Frequency Range	GSM 850 : 869~894MHz PCS 1900: 1930~1990MHz
Release Version	R99
Type of modulation	GMSK for GSM/GPRS
Antenna Gain	1.0dBi
Max. Average Power (Max. Peak Power)	GSM850: 31.46dBm(32.23dBm- Peak Power) PCS1900: 28.37dBm(29.28dBm-Peak Power)
Bluetooth	
Bluetooth Version	<input type="checkbox"/> V2.0 <input type="checkbox"/> V2.1 <input checked="" type="checkbox"/> V2.1+EDR <input type="checkbox"/> V3.0 <input type="checkbox"/> V3.0+HS <input type="checkbox"/> V4.0
Operation Frequency	2402~2480MHz
Type of modulation	<input checked="" type="checkbox"/> GFSK <input checked="" type="checkbox"/> II/4-DQPSK <input checked="" type="checkbox"/> 8-DPSK
Avg. Burst Power	1.55dBm

Antenna Gain	1.0dBi
Accessories	
Battery	Brand name: tianjin Model No. : BL-5C Voltage and Capacitance: 3.7 V & 600mAh
Adapter	Brand name: NAN BANG Model No. : GO202 Input: AC 100-240V, 50/60Hz, 100mA DC5.0V, 500mA
Earphone	Brand name: GOMOBILE Model No. : GO202

Note: The sample used for testing is end product.

2.2. Test Procedure

1	Setup the EUT and simulators as shown on above.
2	Turn on the power of all equipment.
3	EUT Communicate with 8960, and test them respectively at U.S. bands

2.3. Test Environment

Ambient conditions in the laboratory:

Items	Required	Actual
Temperature (°C)	18-25	21± 2
Humidity (%RH)	30-70	55±2

2.4. Test Configuration and setting

The EUT is a model of GSM Portable Mobile Station (MS). It supports GSM/GPRS, BT. For WWAN SAR testing, the device was controlled by using a base station emulator. Communication between The device and the emulator were established by air link. The distance between the EUT and the antenna is larger than 50cm, and the output power radiated from the emulator antenna is at least 30db smaller than the output power of EUT.

Antenna Location:

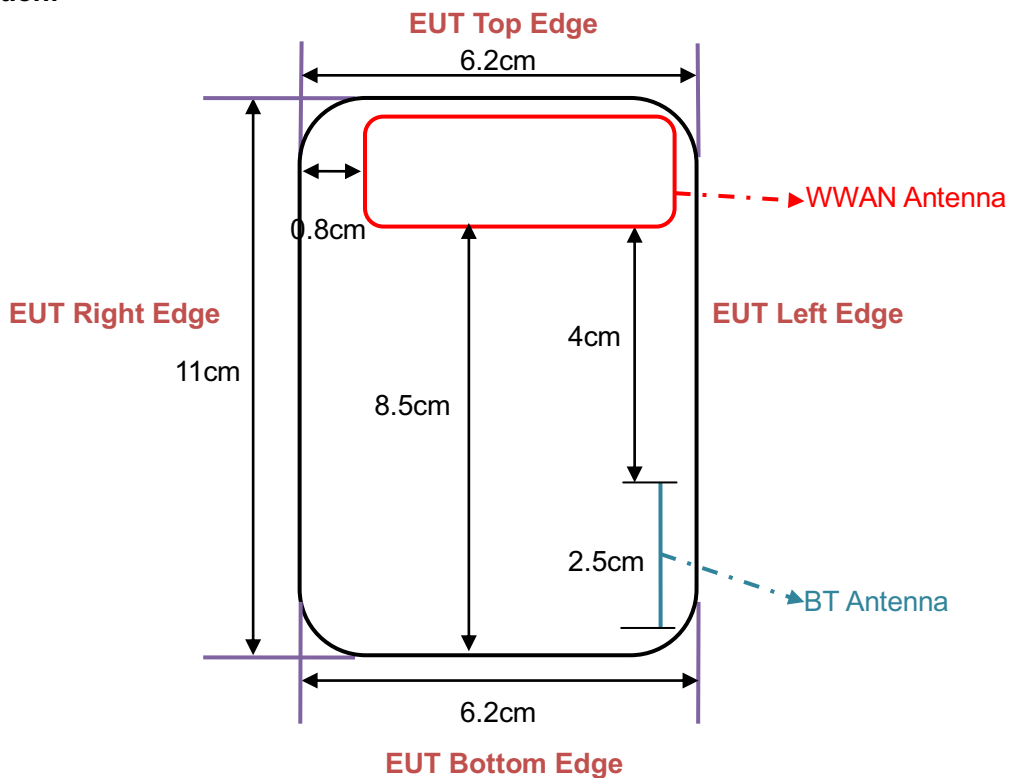

The separation distance for antenna to edge:

Antenna	To Top Side(cm)	To Bottom Side(cm)	To Left Side(cm)	To Right Side(cm)
WWAN	0.3	8.5	0.2	0.8
BT	7	1.5	0.2	6

The simultaneous transmission possibilities are listed as below:

Simultaneous TX Combination	Configuration	Head	Body	Hotspot
1	GSM835(Voice)+WLAN/BT	Yes	Yes	No
2	PCS 1900(Voice)+WLAN/BT	Yes	Yes	No

3. SAR MEASUREMENT SYSTEM

3.1. Specific Absorption Rate (SAR)

SAR is related to the rate at which energy is absorbed per unit mass in object exposed to a radio field. The SAR distribution in a biological body is complicated and is usually carried out by experimental techniques or numerical modeling. The standard recommends limits for two tiers of groups, occupational/controlled and occupational/uncontrolled, based on a person's awareness and ability to exercise control over his or her exposure. In general, occupational/controlled exposure limits are higher than the limits for general population/uncontrolled.

The SAR definition is the time derivative (rate) of the incremental energy (dW) absorbed by (dissipated in) an incremental mass (dm) contained in a volume (dv) of given mass density (ρ). The equation description is as below:

$$SAR = \frac{d}{dt} \left(\frac{dW}{dm} \right) = \frac{d}{dt} \left(\frac{dW}{\rho dV} \right)$$

SAR is expressed in units of Watts per kilogram (W/Kg)

SAR can be obtained using either of the following equations:

$$SAR = \frac{\sigma E^2}{\rho}$$

$$SAR = c_h \left. \frac{dT}{dt} \right|_{t=0}$$

Where

SAR	is the specific absorption rate in watts per kilogram;
E	is the r.m.s. value of the electric field strength in the tissue in volts per meter;
σ	is the conductivity of the tissue in siemens per metre;
ρ	is the density of the tissue in kilograms per cubic metre;
c_h	is the heat capacity of the tissue in joules per kilogram and Kelvin;

$\left. \frac{dT}{dt} \right|_{t=0}$ is the initial time derivative of temperature in the tissue in kelvins per second

3.2. SAR Measurement Procedure

The EUT is set to transmit at the required power in line with product specification, at each frequency relating to the LOW, MID, and HIGH channel settings.

Pre-scans are made on the device to establish the location for the transmitting antenna, using a large area scan in either air or tissue simulation fluid.

The EUT is placed against the Universal Phantom where the maximum area scan dimensions are larger than the physical size of the resonating antenna. When the scan size is not large enough to cover the peak SAR distribution, it is modified by either extending the area scan size in both the X and Y directions, or the device is shifted within the predefined area.

The area scan is then run to establish the peak SAR location (interpolated resolution set at 1mm^2) which is then used to orient the center of the zoom scan. The zoom scan is then executed and the 1g and 10g averages are derived from the zoom scan volume (interpolated resolution set at 1mm^3).

When multiple peak SAR location were found during the same configuration or test mode, Zoom scan shall performed on each peak SAR location, only the peak point with maximum SAR value will be reported for the configuration or test mode.

3.3. COMOSAR System Description

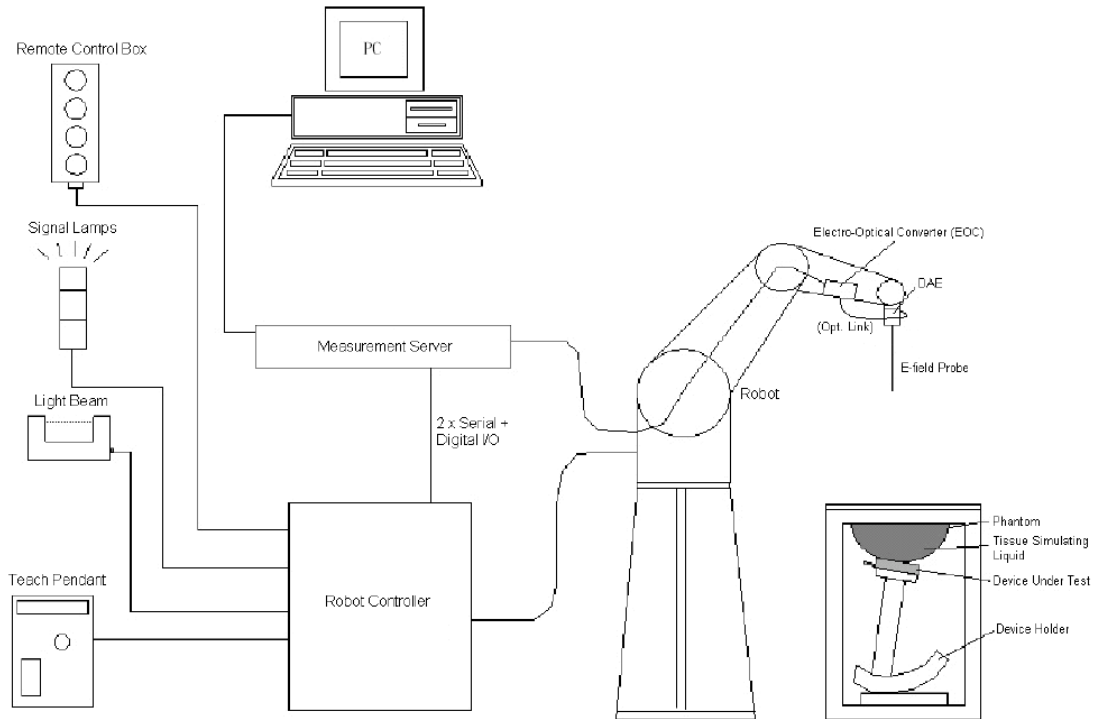

The COMOSAR system for performing compliance tests consists of the following items:

- A standard high precision 6-axis robot with controller, teach pendant and software. An arm extension for accommodating the data acquisition electronics (DAE).
- A data acquisition electronics (DAE) which performs the signal amplification, signal multiplexing, AD-conversion, offset measurements, mechanical surface detection, collision detection, etc. The unit is battery powered with standard or rechargeable batteries. The signal is optically transmitted to the EOC.
- The Electro-optical converter (EOC) performs the conversion from optical to electrical signals for the digital Communicate Mobile to the DAE. To use optical surface detection, a special version of the EOC is required. The EOC signal is transmitted to the measurement server.
- The Light Beam used is for probe alignment. This improves the (absolute) accuracy of the probe positioning.
- A computer running WinXP and the Opensar software.
- Remote control and teach pendant as well as additional circuitry for robot safety such as warning lamps, etc.
- The phantom, the device holder and other accessories according to the targeted measurement.

3.3.1. Applications

Predefined procedures and evaluations for automated compliance testing with all worldwide standards, e.g., IEEE 1528, OET 65, IEC 62209-1, IEC 62209-2, EN 50360, EN 50383 and others.

3.3.2. Area Scans

Area scans are defined prior to the measurement process being executed with a user defined variable spacing between each measurement point (integral) allowing low uncertainty measurements to be conducted. Scans defined for FCC applications utilize a 10mm² step integral, with 1mm interpolation used to locate the peak SAR area used for zoom scan assessments.

When an Area Scan has measured all reachable points, it computes the field maxima found in the scanned area, within a range of the global maximum. The range (in dB) is specified in the standards for compliance testing. For example, a 2 dB range is required in IEEE 1528-2003, EN 50361 and IEC 62209 standards, whereby 3 dB is a requirement when compliance is assessed in accordance with the ARIB standard (Japan).

3.3.3. Zoom Scan (Cube Scan Averaging)

Zoom Scans are used to assess the peak spatial SAR values within a cubic averaging volume containing 1 g and 10 g of simulated tissue. A density of 1000 kg/m³ is used to represent the head and body tissue density and not the phantom liquid density, in order to be consistent with the definition of the liquid dielectric properties, i.e. the side length of the 1 g cube is 10mm, with the side length of the 10 g cube 21,5mm.

The zoom scan integer steps can be user defined so as to reduce uncertainty, but normal practice for typical test applications utilize a physical step of 7x7x7 (5mmx5mmx5mm) providing a volume of 30mm in the X & Y axis, and 30mm in the Z axis.

3.3.4. Uncertainty of Inter-/Extrapolation and Averaging

In order to evaluate the uncertainty of the interpolation, extrapolation and averaged SAR calculation algorithms of the Post processor, COMOSAR allows the generation of measurement grids which are artificially predefined by analytically based test functions. Therefore, the grids of area scans and zoom scans can be filled with uncertainty test data, according to the SAR benchmark functions of IEEE 1528. The three analytical functions shown in equations as below are used to describe the possible range of the expected SAR distributions for the tested handsets. The field gradients are covered by the spatially flat distribution f1, the spatially steep distribution f3 and f2 accounts for H-field cancellation on the phantom/tissue surface.

$$f_1(x, y, z) = Ae^{-\frac{z}{2a}} \cos^2 \left(\frac{\pi \sqrt{x'^2 + y'^2}}{2 \cdot 5a} \right)$$

$$f_2(x, y, z) = Ae^{-\frac{z}{a}} \frac{a^2}{a^2 + x'^2} \left(3 - e^{-\frac{2z}{a}} \right) \cos^2 \left(\frac{\pi y'}{2 \cdot 3a} \right)$$

$$f_3(x, y, z) = A \frac{a^2}{\frac{a^2}{4} + x'^2 + y'^2} \left(e^{-\frac{2z}{a}} + \frac{a^2}{2(a + 2z)^2} \right)$$

3.4. COMOSAR E-Field Probe

The SAR measurement is conducted with the dissymmetric probe manufactured by SATIMO. The probe is specially designed and calibrated for use in liquid with high permittivity. The dissymmetric probe has special calibration in liquid at different frequency. SATIMO conducts the probe calibration in compliance with international and national standards (e.g. IEEE 1528, EN62209-1, IEC 62209, etc.) Under ISO17025. The calibration data are in Appendix D.

3.5. Isotropic E-Field Probe Specification

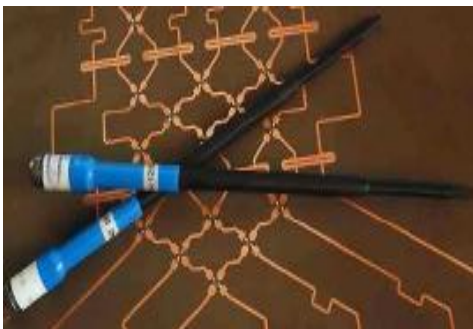
Model	EP165	
Manufacture	SATIMO	
Frequency	0.03GHz-3 GHz Linearity:±0.2dB(30 MHz-3 GHz)	
Dynamic Range	0.01W/Kg-100W/Kg Linearity:±0.2dB	
Dimensions	Overall length:330mm Length of individual dipoles:4.5mm Maximum external diameter:8mm Probe Tip external diameter:5mm Distance between dipoles/ probe extremity:2.7mm	
Application	High precision dosimetric measurements in any exposure scenario (e.g., very strong gradient fields). Only probe which enables compliance testing for frequencies up to 3 GHz with precision of better 30%.	

3.6. Robot

The COMOSAR system uses the KUKA robot from SATIMO SA (France).For the 6-axis controller COMOSAR system, the KUKA robot controller version from SATIMO is used.

The XL robot series have many features that are important for our application:

- High precision (repeatability 0.02 mm)
- High reliability (industrial design)
- Jerk-free straight movements
- Low ELF interference (the closed metallic construction shields against motor control fields)
- 6-axis controller



3.7. Video Positioning System

The video positioning system is used in OpenSAR to check the probe. Which is composed of a camera, LED, mirror and mechanical parts. The camera is piloted by the main computer with firewire link.

During the process, the actual position of the probe tip with respect to the robot arm is measured, as well as the probe length and the horizontal probe offset. The software then corrects all movements, such that the robot coordinates are valid for the probe tip.

The repeatability of this process is better than 0.1 mm. If a position has been taught with an aligned probe, the same position will be reached with another aligned probe within 0.1 mm, even if the other probe has different dimensions. During probe rotations, the probe tip will keep its actual position.

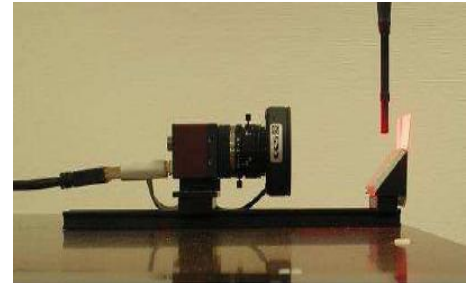

3.8. Device Holder

The COMOSAR device holder is designed to cope with different positions given in the standard. It has two scales for the device rotation (with respect to the body axis) and the device inclination (with respect to the line between the ear reference points). The rotation center for both scales is the ear reference point (EPR).

Thus the device needs no repositioning when changing the angles.

The COMOSAR device holder has been made out of low-loss POM material having the following dielectric parameters: relative permittivity $\epsilon_r = 3$ and loss tangent $\delta = 0.02$. The amount of dielectric material has been reduced in the closest vicinity of the device, since measurements have suggested that the influence of the clamp on the test results could thus be lowered.

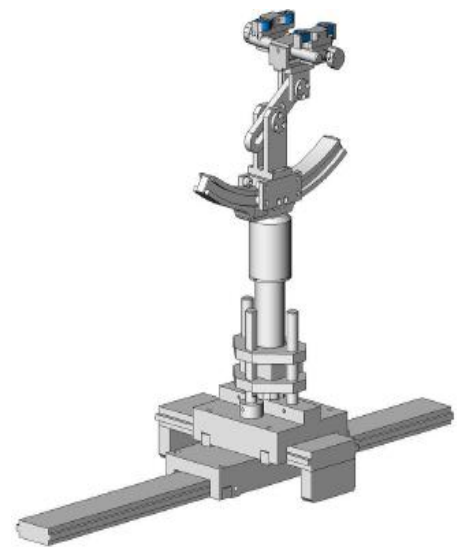

3.9. SAM Twin Phantom

The SAM twin phantom is a fiberglass shell phantom with 2mm shell thickness (except the ear region where shell thickness increases to 6mm). It has three measurement areas:

- Left head
- Right head
- Flat phantom



The bottom plate contains three pair of bolts for locking the device holder. The device holder positions are adjusted to the standard measurement positions in the three sections. A white cover is provided to tap the phantom during off-periods to prevent water evaporation and changes in the liquid parameters. On the phantom top, three reference markers are provided to identify the phantom position with respect to the robot.

4. TISSUE SIMULATING LIQUID

For SAR measurement of the field distribution inside the phantom, the phantom must be filled with homogeneous tissue simulating liquid to a depth of at least 15cm. For head SAR testing the liquid height from the ear reference point (ERP) of the phantom to the liquid top surface is larger than 15cm For body SAR testing, the liquid height from the center of the flat phantom to the liquid top surface is larger than 15cm. The nominal dielectric values of the tissue simulating liquids in the phantom and the tolerance of 5% are listed in 4.2

4.1. The composition of the tissue simulating liquid

Ingredient	835MHz	835MHz	1900MHz	1900MHz
(% Weight)	Head	Body	Head	Body
Water	40.45	52.4	54.90	40.5
Salt	1.42	1.40	0.18	0.50
Sugar	57.6	45.0	0.00	58.0
HEC	0.40	1.00	0.00	0.50
Preventol	0.10	0.20	0.00	0.50
DGBE	0.00	0.00	44.92	0.00

4.2. Tissue Calibration Result

The dielectric parameters of the liquids were verified prior to the SAR evaluation using COMOSAR Dielectric Probe Kit and R&S Network Analyzer ZVL6.

Tissue Stimulant Measurement for GSM 835					
Frequency (MHz)	Parts	Description	Dielectric Parameters		Tissue Temp [°C]
835MHz	Head	Reference result ±5% window	ϵ_r 41.50 39.425-43.575	δ [s/m] 0.90 0.855-0.945	N/A
		Nov.13, 2013	40.16	0.87	21
835MHz	Body	Reference result ±5% window	ϵ_r 55.20 52.44-57.96	δ [s/m] 0.97 0.9215-1.0185	N/A
		Nov.13, 2013	53.26	0.95	21

Tissue Stimulant Measurement for PCS 1900					
Frequency (MHz)	Parts	Description	Dielectric Parameters		Tissue Temp [°C]
1900MHz	Head	Reference result ±5% window	ϵ_r 40.00 38.00-42.00	δ [s/m] 1.40 1.33-1.47	N/A
		Nov.13, 2013	41.31	1.38	21
1900MHz	Body	Reference result ±5% window	ϵ_r 53.30 50.635-55.965	δ [s/m] 1.52 1.444-1.596	N/A
		Nov.13, 2013	62.64	1.49	21

4.3. Tissue Dielectric Parameters for Head and Body Phantoms

The head tissue dielectric parameters recommended by the IEEE SCC-34/SC-2 in P1528 have been incorporated in the following table. These head parameters are derived from planar layer models simulating the highest expected SAR for the dielectric properties and tissue thickness variations in a human head. Other head and body tissue parameters that have not been specified in P1528 are derived from the tissue dielectric parameters computed from the 4-Cole-Cole equations described in Reference [12] and extrapolated according to the head parameters specified in P1528.

Target Frequency (MHz)	head		body	
	ϵ_r	σ (S/m)	ϵ_r	σ (S/m)
300	45.3	0.87	58.2	0.92
450	43.5	0.87	56.7	0.94
835	41.5	0.90	55.2	0.97
900	41.5	0.97	55.0	1.05
915	41.5	1.01	55.0	1.06
1450	40.5	1.20	54.0	1.30
1610	40.3	1.29	53.8	1.40
1800 – 2000	40.0	1.40	53.3	1.52
2450	39.2	1.80	52.7	1.95
3000	38.5	2.40	52.0	2.73
5800	35.3	5.27	48.2	6.00

(ϵ_r = relative permittivity, σ = conductivity and $\rho = 1000$ kg/m³)

5. SAR MEASUREMENT PROCEDURE

5.1. SAR System Validation Procedures

Each SATIMO system is equipped with one or more system validation kits. These units, together with the predefined measurement procedures within the SATIMO software, enable the user to conduct the system performance check and system validation. System kit includes a dipole, and dipole device holder.

The system check verifies that the system operates within its specifications. It's performed daily or before every SAR measurement. The system check uses normal SAR measurement in the flat section of the phantom with a matched dipole at a specified distance. The system validation setup is shown as below.

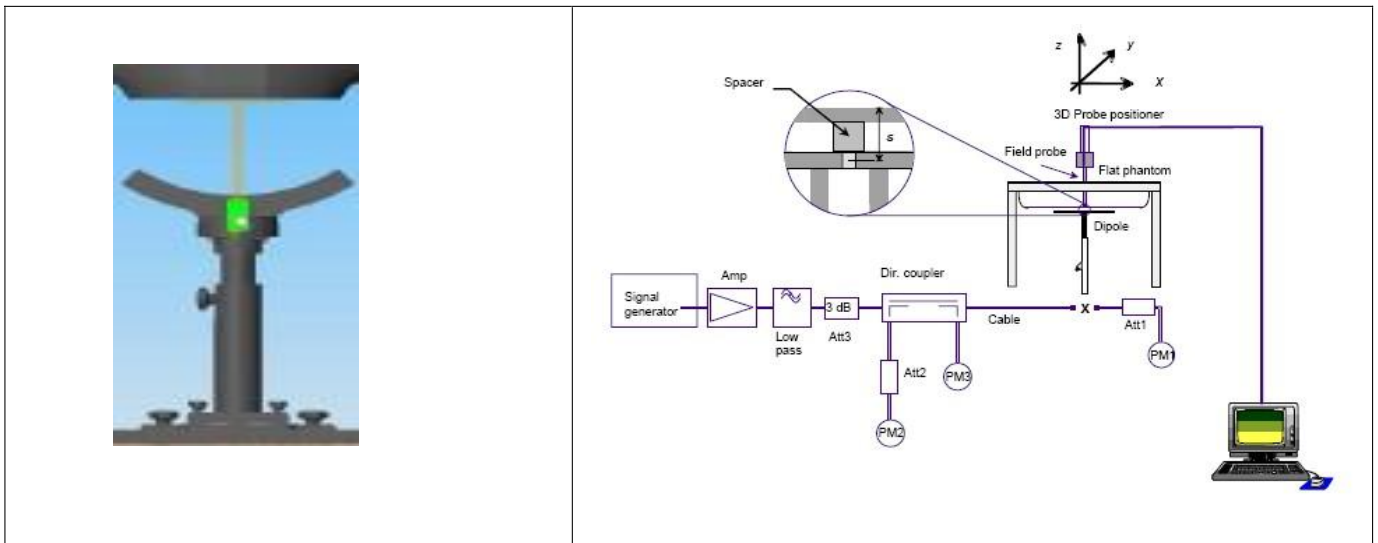

5.2. SAR System Validation
5.2.1. Validation Dipoles

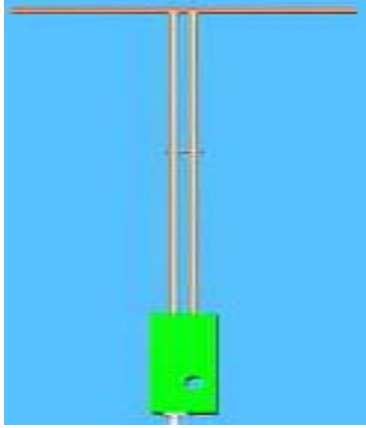
	<p>The dipoles used is based on the IEEE-1528 standard, and is complied with mechanical and electrical specifications in line with the requirements of both IEEE and FCC Supplement C. the table below provides details for the mechanical and electrical Specifications for the dipoles.</p>
---	---

Frequency	L (mm)	h (mm)	d (mm)
900 MHz	149.0	83.3	3.6
1900MHz	68	39.5	3.6

5.2.2. Validation Result

System Performance Check at 835 MHz &1900MHz for Head				
Validation Kit: SN 46/11DIP 0G900-185				
Frequency [MHz]	Description	SAR [w/kg] 1g	SAR [w/kg] 10g	Tissue Temp.[°C]
835 MHz	Reference result ± 10% window	10.9 9.81 to 11.99	6.99 6.29 to 7.69	N/A
	Nov.13, 2013	10.86	6.58	21.0
Validation Kit: SN 46/11DIP 1G900-187				
Frequency [MHz]	Description	SAR [w/kg] 1g	SAR [w/kg] 10g	Tissue Temp.[°C]
1900 MHz	Reference result ± 10% window	39.7 35.73 to 43.67	20.5 18.45 to 22.55	N/A
	Nov.13, 2013	42.30	21.67	21.0
Note: All SAR values are normalized to 1W forward power.				

6. EUT TEST POSITION

This EUT was tested in **Right Cheek, Right Titled, Left Cheek, Left Titled, Front Face and Rear Face.**

6.1. Define Two Imaginary Lines on the Handset

(1)The vertical centerline passes through two points on the front side of the handset the midpoint of the width w_t of the handset at the level of the acoustic output, and the midpoint of the width w_b of the handset.

(2)The horizontal line is perpendicular to the vertical centerline and passes through the center of the acoustic output. The horizontal line is also tangential to the face of the handset at point A.

(3)The two lines intersect at point A. Note that for many handsets, point A coincides with the center of the acoustic output; however, the acoustic output may be located elsewhere on the horizontal line. Also note that the vertical centerline is not necessarily to the front face of the handset, especially for clamshell handsets, handsets with flip covers, and other irregularly shaped handsets.

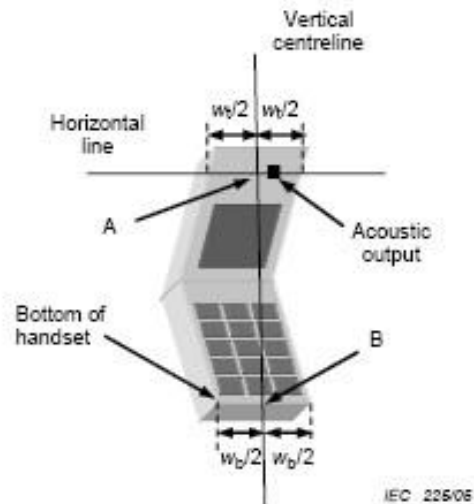
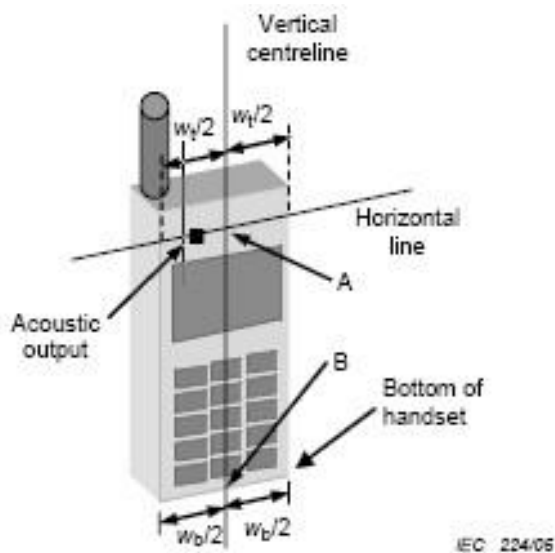

6.2. Cheek Position

- (1) To position the device with the vertical center line of the body of the device and the horizontal line crossing the center piece in a plane parallel to the sagittal plane of the phantom. While maintaining the device in this plane, align the vertical center line with the reference plane containing the ear and mouth reference point (M: Mouth, RE: Right Ear, and LE: Left Ear) and align the center of the ear piece with the line RE-LE.
- (2) To move the device towards the phantom with the ear piece aligned with the the line LE-RE until the phone touched the ear. While maintaining the device in the reference plane and maintaining the phone contact with ear, move the bottom of the phone until any point on the front side is in contact with the cheek of the phantom or until contact with the ear is lost



6.3. Title Position

- (1) To position the device in the “cheek” position described above.
- (2) While maintaining the device in the reference plane described above and pivoting against the ear, moves it outward away from the mouth by an angle of 15 degrees or until with the ear is lost.



6.4. Body Worn Position

- (1) To position the EUT parallel to the phantom surface.
- (2) To adjust the EUT parallel to the flat phantom.
- (3) To adjust the distance between the EUT surface and the flat phantom to **5mm**.

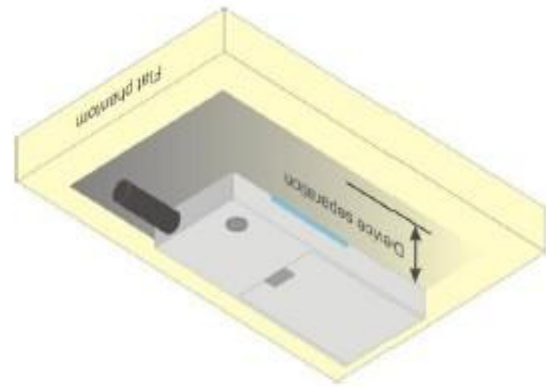
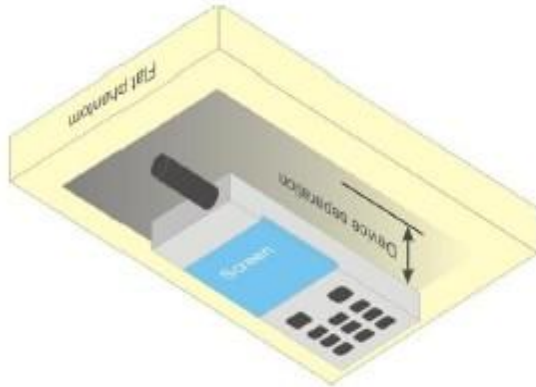

7. SAR EXPOSURE LIMITS

SAR assessments have been made in line with the requirements of IEEE-1528, FCC Supplement C, and comply with ANSI/IEEE C95.1-1992 “Uncontrolled Environments” limits. These limits apply to a location which is deemed as “Uncontrolled Environment” which can be described as a situation where the general public may be exposed to an RF source with no prior knowledge or control over their exposure.

Limits for General Population/Uncontrolled Exposure (W/kg)

Type Exposure	Uncontrolled Environment Limit
Spatial Peak SAR (1g cube tissue for brain or body)	1.60 W/kg

8. TEST EQUIPMENT LIST

Equipment description	Manufacturer/ Model	Identification No.	Current calibration date	Next calibration date
SAR Probe	SATIMO	SN 04/13 EP165	01/31/2013	01/30/2014
Phantom	SATIMO	SN_4511_SAM90	Validated. No cal required.	Validated. No cal required.
Liquid	SATIMO	-	Validated. No cal required.	Validated. No cal required.
Comm Tester	R&S - CMU200	069Y7-158-13-712	02/28/2013	02/27/2014
Comm Tester	Agilent-8960	GB46310822	10/22/2013	10/21/2014
Multimeter	Keithley 2000	1188656	02/28/2013	02/27/2014
Dipole	SATIMO SID900	SN46/11 DIP 0G900-185	12/09/2011	12/08/2013
Dipole	SATIMO SID1900	SN46/11 DIP 1G900-187	12/09/2011	12/08/2013
Amplifier	Aethercomm	SN 046	12/08/2012	12/07/2013
Signal Generator	Agilent-E4421B	MY43351603	05/13/2013	05/12/2014
Power Probe	HP E4418A	US38261498	02/28/2013	02/27/2014
SPECTRUM ANALYZER	Agilent/E4440A	MY44303916	10/22/2013	10/21/2014
Power Attenuator	BED	DLA-5W	07/30/2013	07/29/2014
Network Analyzer	Rhode & Schwarz ZVA	SN100132	02/28/2013	02/27/2014

Note: Per KDB 50824 Dipole SAR Validation Verification, AGC Lab has adopted 3 years calibration intervals. On annual basis, every measurement dipole has been evaluated and is in compliance with the following criteria:

1. There is no physical damage on the dipole;
2. System validation with specific dipole is within 10% of calibrated value;
3. Return-loss is within 20% of calibrated measurement;
4. Impedance is within 5Ω of calibrated measurement.

9. MEASUREMENT UNCERTAINTY

SATIMO Uncertainty									
Measurement uncertainty for 30 MHz to 3 GHz averaged over 1 gram / 10 gram.									
Error Description	Sec	Tol (±%)	Prob. Dist.	Div.	(Ci) 1g	(Ci) 10g	Std. Unc. (1g) (±%)	Std. Unc. (10g)(±%)	(Vi) Veff
Measurement System									
Probe Calibration	E.2.1	6	N	1	1	1	6	6	∞
Axial Isotropy	E.2.2	3	R	$\sqrt{3}$	$(1-c_p)^{1/2}$	$(1-c_p)^{1/2}$	1.22474	1.22474	∞
Hemispherical Isotropy	E.2.2	5	R	$\sqrt{3}$	$\sqrt{c_p}$	$\sqrt{c_p}$	2.04124	2.04124	∞
Boundary Effects	E.2.3	1	R	$\sqrt{3}$	1	1	0.57735	0.57735	∞
Linearity	E.2.4	5	R	$\sqrt{3}$	1	1	2.88675	2.88675	∞
System Detection Limits	E.2.5	1	R	$\sqrt{3}$	1	1	0.57735	0.57735	∞
Readout Electronics	E.2.6	0.5	N	1	1	1	0.5	0.5	∞
Response Time	E.2.7	0.2	R	$\sqrt{3}$	1	1	0.11547	0.11547	∞
Integration Time	E.2.8	2	R	$\sqrt{3}$	1	1	1.1547	1.1547	∞
RF Ambient Noise	E.6.1	3	R	$\sqrt{3}$	1	1	1.73205	1.73205	∞
Probe Positioner Mechanical Tolerance	E.6.2	2	R	$\sqrt{3}$	1	1	1.1547	1.1547	∞
Probe Positioning with Respect to Phantom Shell	E.6..3	1	R	$\sqrt{3}$	1	1	0.57735	0.57735	∞
Extrapolation, interpolation and Integration Algorithms for Max. SAR Evaluation	E.5.2	1.5	R	$\sqrt{3}$	1	1	0.86603	0.86603	∞
Dipole									
Device Positioning	8,E.4.2	1	N	$\sqrt{3}$	1	1	0.57735	0.57735	N-1
Power Drift	8.6.6.2	2	R	$\sqrt{3}$	1	1	1.1547	1.1547	∞
Phantom and Tissue Parameters									
Phantom Uncertainty	E.3.1	4	R	$\sqrt{3}$	1	1	2.3094	2.3094	∞
Liquid Conductivity (target)	E.3.2	5	R	$\sqrt{3}$	0.64	0.43	1.84752	1.2413	∞
Liquid Conductivity (meas.)	E.3.3	2.5	N	1	0.64	0.43	1.6	1.075	∞
Liquid Permittivity (target)	E.3.2	3	R	$\sqrt{3}$	0.6	0.49	1.03923	0.8487	∞
Liquid Permittivity (meas.)	E.3.3	2.5	N	1	0.6	0.49	1.5	1.225	M
Combined Standard Uncertainty			RSS				8.09272	7.9296	
Expanded Uncertainty (95%CONFIDENCE INTERVAL)			k				16.18544	15.8592	

10. CONDUCTED POWER MEASUREMENT

GSM BAND

Mode	Frequency(MHz)	Avg. Burst Power(dBm)	Duty cycle Factor(dBm)	Frame Power(dBm)
Maximum Power <1>				
GSM 835	824.2	31.28	-9	22.28
	836.6	31.46	-9	22.46
	848.8	31.34	-9	22.34
GPRS 835 (1 Slot)	824.2	31.35	-9	22.35
	836.6	31.27	-9	22.27
	848.8	31.24	-9	22.24
GPRS 835 (2 Slot)	824.2	28.36	-6	22.36
	836.6	28.45	-6	22.45
	848.8	28.36	-6	22.36
GPRS 835 (3 Slot)	824.2	26.57	-4.26	22.31
	836.6	26.39	-4.26	22.13
	848.8	26.42	-4.26	22.16
GPRS 835 (4 Slot)	824.2	25.35	-3	22.35
	836.6	25.27	-3	22.27
	848.8	25.53	-3	22.53
PCS1900	1850.2	28.37	-9	19.37
	1880	28.26	-9	19.26
	1909.8	28.29	-9	19.29
GPRS1900 (1 Slot)	1850.2	28.28	-9	19.28
	1880	28.24	-9	19.24
	1909.8	28.14	-9	19.14
GPRS1900 (2 Slot)	1850.2	25.37	-6	19.37
	1880	25.58	-6	19.58
	1909.8	25.43	-6	19.43
GPRS1900 (3 Slot)	1850.2	24.26	-4.26	20
	1880	24.11	-4.26	19.85
	1909.8	24.12	-4.26	19.86
GPRS1900 (4 Slot)	1850.2	22.63	-3	19.63
	1880	22.55	-3	19.55
	1909.8	22.52	-3	19.52
Maximum Power <2>				
GSM 835	836.6	31.35	-9	22.35
PCS1900	1850.2	28.24	-9	19.24

Note 1:

The Frame Power (Source-based time-averaged Power) is scaled the maximum burst average power based on time slots. The calculated methods are show as following:

Frame Power = Max burst power (1 Up Slot) – 9 dB

Frame Power = Max burst power (2 Up Slot) – 6 dB

Frame Power = Max burst power (3 Up Slot) -4.26dB

Frame Power = Max burst power (4 Up Slot) – 3 dB

Bluetooth

Modulation	Channel	Frequency(MHz)	Average Power (dBm)
GFSK	0	2402	0.40
	39	2441	1.41
	78	2480	1.55
π /4-DQPSK	0	2402	-0.17
	39	2441	0.59
	78	2480	0.74
8-DPSK	0	2402	-0.06
	39	2441	0.84
	78	2480	0.98

11. TEST RESULTS

11.1. SAR Test Results Summary

11.1.1. Test position and configuration

Head SAR was performed with the device configured in the positions according to IEEE1528, and Body SAR was performed with the device 5mm from the phantom; Body SAR was also performed with the headset attached and without.

11.1.2. Operation Mode

- According to KDB 447498 D01 v05r01 ,for each exposure position, if the highest 1-g SAR is ≤ 0.8 W/kg, testing for low and high channel is optional.
- Per KDB 865664 D01 v01r01,for each frequency band, if the measured SAR is ≥ 0.8 W/Kg, testing for repeated SAR measurement is required , that the highest measured SAR is only to be tested. When the SAR results are near the limit, the following procedures are required for each device to verify these types of SAR measurement related variation concerns by repeating the highest measured SAR configuration in each frequency band.
 - (1) When the original highest measured SAR is ≥ 0.8 W/Kg, repeat that measurement once.
 - (2) Perform a second repeated measurement only if the ratio of largest to smallest SAR for the original and first repeated measurements is > 1.20 or when the original or repeated measurement is ≥ 1.45 W/Kg.
 - (3) Perform a third repeated measurement only if the original, first and second repeated measurement is ≥ 1.5 W/Kg and ratio of largest to smallest SAR for the original, first and second measurement is ≥ 1.20 .
- Body-worn exposure conditions are intended to voice call operations, therefore GSM voice call mode is selected to be test.
- According to KDB 648474 D04 v01r01,when the reported SAR for a body-worn accessory measured without a headset connected to the handset is ≤ 1.2 W/Kg, SAR testing with a headset connected is not required.
- Maximum Scaling SAR in order to calculate the Maximum SAR values to test under the standard Peak Power, Calculation method is as follows:
Maximum Scaling SAR =tested SAR (Max.) \times [GSM standard Peak Power (mw)/ tested Max. Peak Power (mw)]

11.1.3. Test Result

SAR MEASUREMENT								
Ambient Temperature (°C) : 21 ± 2						Relative Humidity (%): 55		
Liquid Temperature (°C) : 21 ± 2						Depth of Liquid (cm):>15		
Product: Mobile Phone								
Test Mode: GSM835 with GMSK modulation								
Configuration			Antenna Position	Frequency		Power Drift (<±5%)	SAR (1g) (W/kg)	Limit (W/kg)
SIM	Position	Status		channel	MHz			
<1>	Left Head	Cheek	Fixed	128	824.2	--	--	--
				190	836.6	-2.11	0.605	1.6
				251	848.8	--	--	--
		Tilted	Fixed	128	824.2	--	--	--
				190	836.6	2.07	0.376	1.6
				251	848.8	--	--	--
	Right Head	Cheek	Fixed	128	824.2	--	--	--
				190	836.6	1.82	0.468	1.6
				251	848.8	--	--	--
		Tilted	Fixed	128	824.2	--	--	--
				190	836.6	-3.07	0.352	1.6
				251	848.8	--	--	--
<2>	Left	Cheek	Fixed	190	836.6	1.74	0.563	1.6

Note: when the 1-g SAR is ≤ 0.8 W/kg, testing for low and high channel is optional. refer to KDB 941225.

SAR MEASUREMENT								
Ambient Temperature (°C) : 21 ± 2						Relative Humidity (%): 55		
Liquid Temperature (°C) : 21 ± 2						Depth of Liquid (cm):>15		
Product: Mobile Phone								
Test Mode: GSM835 with GMSK modulation								
Configuration			Antenna Position	Frequency		Power Drift (<±5%)	SAR (1g) (W/kg)	Limit (W/kg)
SIM	Position	Status		channel	MHz			
<1>	Body back	MS	Fixed	128	824.2	0.64	1.103	1.6
				190	836.6	1.07	0.943	1.6
				251	848.8	-0.07	0.988	1.6
	Body Front	MS	Fixed	128	824.2	1.27	0.444	1.6
				190	836.6	--	--	--
				251	848.8	--	--	--

Note: when the 1-g SAR is ≤ 0.8 W/kg, testing for low and high channel is optional. refer to KDB 941225.

SAR MEASUREMENT								
Ambient Temperature (°C) : 21 ± 2						Relative Humidity (%): 55		
Liquid Temperature (°C) : 21 ± 2						Depth of Liquid (cm):>15		
Product: Mobile Phone								
Test Mode: PCS1900 with GMSK modulation								
Configuration			Antenna Position	Frequency		Power Drift (<±5%)	SAR (1g) (W/kg)	Limit (W/kg)
SIM	Position	Status		channel	MHz			
<1>	Left Head	Cheek	Fixed	512	1850.2	--	--	--
				661	1880.0	1.34	0.490	1.6
				810	1909.8	--	--	--
		Tilted	Fixed	512	1850.2	--	--	--
				661	1880.0	2.24	0.414	1.6
				810	1909.8	--	--	--
	Right Head	Cheek	Fixed	512	1850.2	--	--	--
				661	1880.0	-1.73	0.593	1.6
				810	1909.8	--	--	--
		Tilted	Fixed	512	1850.2	--	--	--
				661	1880.0	1.42	0.412	1.6
				810	1909.8	--	--	--
<2>	Right	Cheek	Fixed	661	1880.0	-2.62	0.578	1.6

Note: when the 1-g SAR is ≤ 0.8 W/kg, testing for low and high channel is optional. refer to KDB 941225.

SAR MEASUREMENT								
Ambient Temperature (°C) : 21 ± 2						Relative Humidity (%): 55		
Liquid Temperature (°C) : 21 ± 2						Depth of Liquid (cm):>15		
Product: Mobile Phone								
Test Mode: PCS 1900 with GMSK modulation								
Configuration			Antenna Position	Frequency		Power Drift (<±5%)	SAR (1g) (W/kg)	Limit (W/kg)
SIM	Position	Status		channel	MHz			
<1>	Body Back	MS	Fixed	512	1850.2	--	--	--
				661	1880.0	1.27	0.725	1.6
				810	1909.8	--	--	--
	Body front	MS	Fixed	512	1850.2	--	--	--
				661	1880.0	-2.40	0.271	1.6
				810	1909.8	--	--	--

Note: when the 1-g SAR is ≤ 0.8 W/kg, testing for low and high channel is optional. refer to KDB 941225.

Repeated SAR								
Ambient Temperature (°C) : 21 ± 2						Relative Humidity (%): 55		
Liquid Temperature (°C) : 21 ± 2						Depth of Liquid (cm):>15		
Product: Mobile Phone								
Test Mode: GSM835 with GMSK modulation								
Configuration			Antenna Position	Frequency		Power Drift (<±5%)	SAR (1g) (W/kg)	Limit (W/kg)
SIM	Position	Status		channel	MHz			
<1>	Body back	MS	Fixed	128	824.2	0.31	0.982	1.6
				190	836.6	0.28	0.899	1.6
				251	848.8	-0.44	0.977	1.6

Repeated SAR								
Ambient Temperature (°C) : 21 ± 2						Relative Humidity (%): 55		
Liquid Temperature (°C) : 21 ± 2						Depth of Liquid (cm):>15		
Product: Mobile Phone								
Test Mode: PCS 1900 with GMSK modulation								
Configuration			Antenna Position	Frequency		Power Drift (<±5%)	SAR (1g) (W/kg)	Limit (W/kg)
SIM	Position	Status		channel	MHz			
<1>	Body Back	MS	Fixed	512	1850.2	--	--	--
				661	1880.0	1.02	0.694	1.6
				810	1909.8	--	--	--

**Simultaneous Multi-band Transmission Evaluation:
Application Simultaneous Transmission information:**

Position	Simultaneous state
Head	1.WWAN(voice)+Bluetooth
Body	2. WWAN(voice)+Bluetooth

NOTE:

- For simultaneous transmission at head and body exposure position, 2 transmitters simultaneous transmission was the worst state.
- Based upon KDB 447498 D01 v05, BT SAR is excluded as below table.
- Based upon KDB 447498 D01 v05, for handsets the test separation distance is determined by the smallest distance between the outer surface of the device and the user; which is 0mm for head SAR AND 5mm for body-worn SAR.
- If the test separation distance is <5mm, 5mm is used for excluded SAR calculation.
- For minimum test separation distance $\leq 50\text{mm}$, Bluetooth standalone SAR is excluded according to $[(\text{max. power of channel, including tune-up tolerance, mW}) / (\text{min. test separation distance, mm}) \cdot \sqrt{f \text{ (GHz)}} / x] \leq 3.0$ for 1-g SAR and ≤ 7.5 for 10-g extremity SAR
- KDB 447498 / 4.3.2 (2) when standalone SAR test exclusion applies to an antenna that transmits simultaneously with other antennas, the standalone SAR must be estimated according to following to determine simultaneous transmission SAR test exclusion:
 - $(\text{max. power of channel, including tune-up tolerance, mW}) / (\text{min. test separation distance, mm}) \cdot \sqrt{f \text{ (GHz)}} / x$ W/kg for test separation distances ≤ 50 mm; Where $x = 7.5$ for 1-g SAR, and $x = 18.75$ for 10-g SAR.
 - 0.4W/Kg for 1-g SAR and 1.0W/Kg for 10-g SAR, when the separation distance is >50mm.

		Maximum Average Power		Antenna to user (mm)	SAR exclusion threshold (mW)	SAR testing required (Yes/No)	Head (0mm gap)	Body (5mm gap)
		dBm	mW					
BT	Head	1.55	1.429	5	10	NO	0.0600 W/kg	0.0600 W/kg
	Body			5	10	NO		

Maximum test results (WWAN) with BT SAR:

BT: Head (0 cm gap): 0.0600 W/kg and Body (0.5 cm gap): 0.0600 W/kg

APPENDIX A. SAR SYSTEM VALIDATION DATA

Test Laboratory: AGC Lab

Date: Nov.13, 2013

System Check Head 835 MHz

DUT: Dipole 900 MHz Type: SID 900

Communication System CW; Communication System Band: D835 (835.0 MHz); Duty Cycle: 1:1; Conv.F=5.30

Frequency: 835 MHz; Medium parameters used: $f = 835$ MHz; $\sigma=0.87$ mho/m; $\epsilon_r=40.16$; $\rho= 1000$ kg/m³ ;

Phantom section: Flat Section; Input Power=10dBm

Ambient temperature (°C): 21, Liquid temperature (°C): 21

SATIMO Configuration:

Probe: EP165; Calibrated: 01/31/2013

- Sensor-Surface: 4mm (Mechanical Surface Detection)
- Phantom: Flat Phantom; Type: Elliptical Phantom
- Measurement SW: OpenSAR V4_02_01

Configuration/System Check GSM 835 Head/Area Scan: Measurement grid: dx=8mm,dy=8mm

Configuration/System Check GSM 835 Head/Zoom Scan: Measurement grid: dx=8mm, dy=8mm, dz=5mm

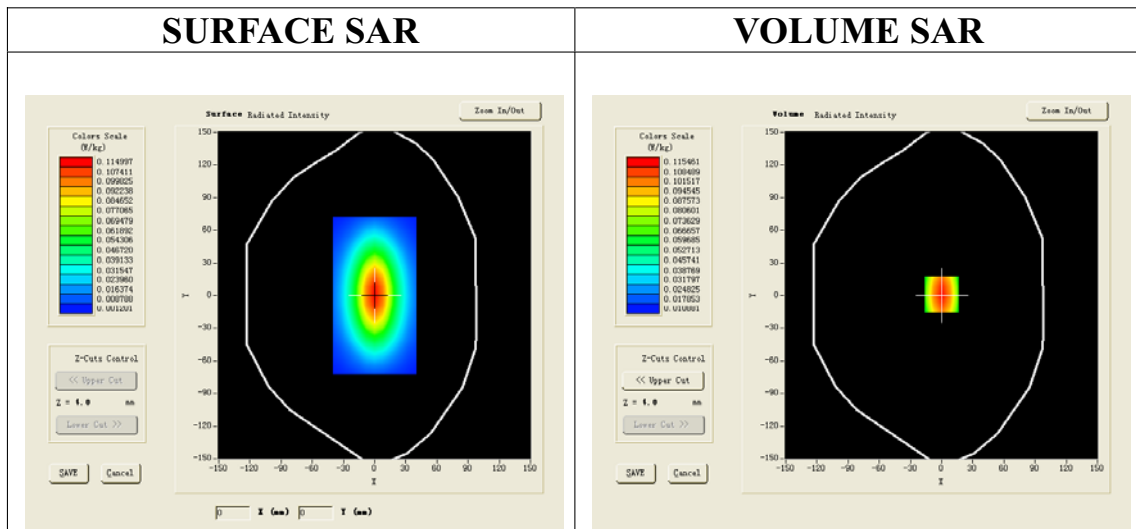

Maximum location: X=0.00, Y=1.00

SAR 10g (W/Kg)	0.065841
SAR 1g (W/Kg)	0.108623

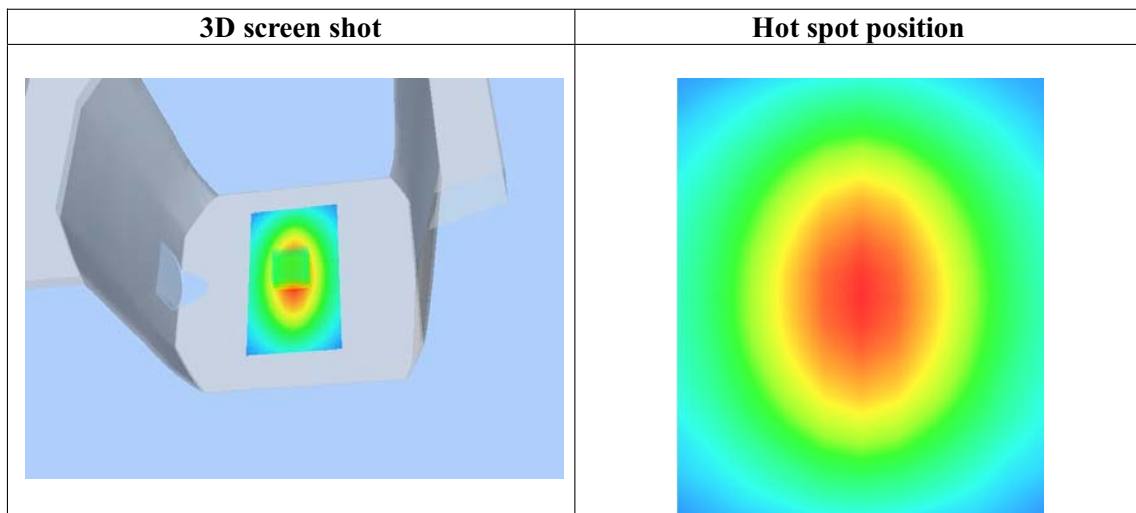
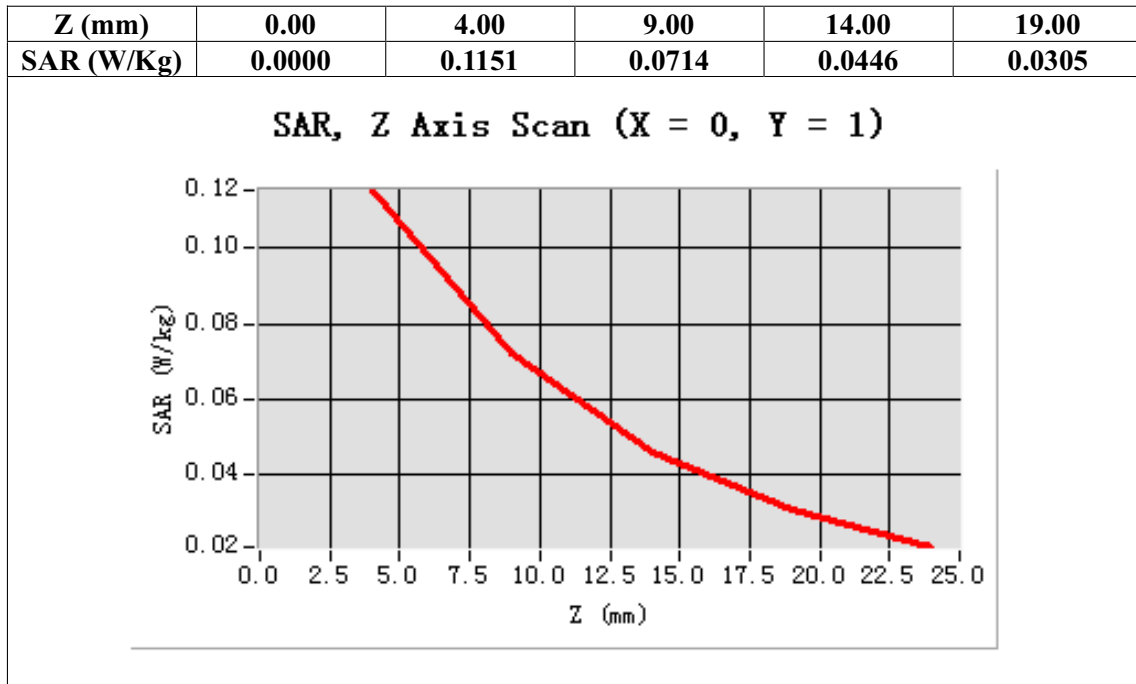

Test Laboratory: AGC Lab

Date: Nov.13, 2013

System Check Head 1900MHz

DUT: Dipole 1900 MHz; Type: SID 1900

Communication System: CW; Communication System Band: D1900 (1900.0 MHz); Duty Cycle:1:1; Conv.F=4.72

Frequency: 1900 MHz; Medium parameters used: $f = 1900$ MHz; $\sigma=1.38$ mho/m; $\epsilon_r=41.31$; $\rho= 1000$ kg/m³ ;

Phantom section: Flat Section; Input Power=10dBm

Ambient temperature (°C): 21, Liquid temperature (°C): 21

SATIMO Configuration:

Probe: EP165; Calibrated: 01/31/2013

- Sensor-Surface: 4mm (Mechanical Surface Detection)
- Phantom: Flat Phantom; Type: Elliptical Phantom
- Measurement SW: OpenSAR V4_02_01

Configuration/System Check PCS1900 Head/Area Scan: Measurement grid: dx=8mm, dy=8mm

Configuration/System Check PCS1900 Head/Zoom Scan: Measurement grid: dx=8mm, dy=8mm, dz=5mm

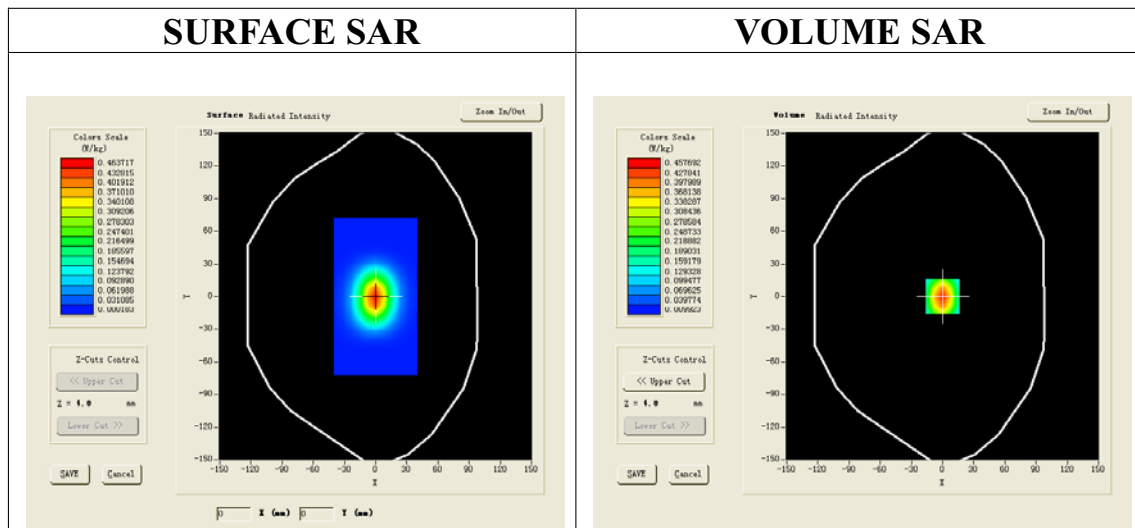

Maximum location: X=0.00, Y=0.00

SAR 10g (W/Kg)	0.216745
SAR 1g (W/Kg)	0.422957

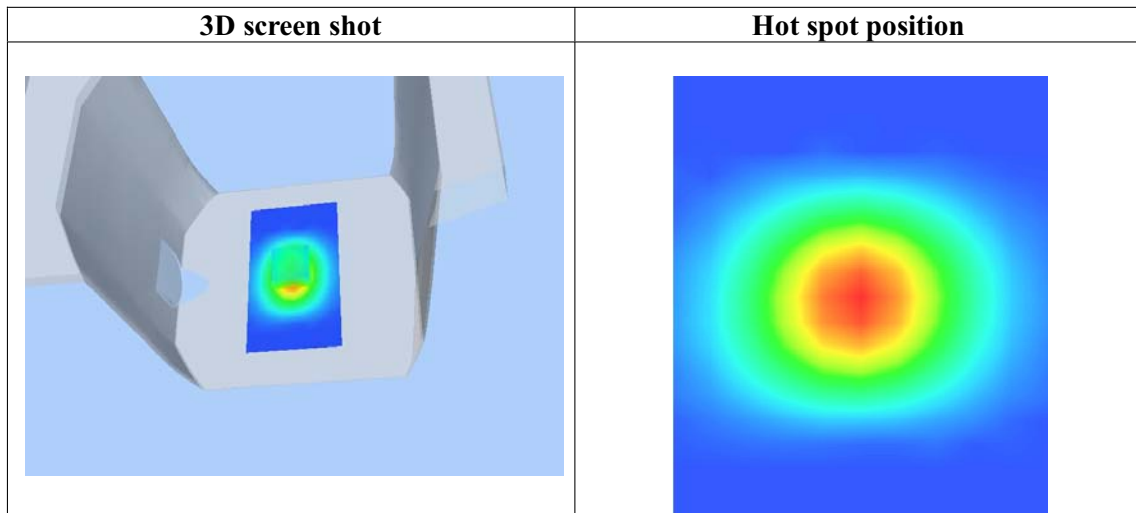
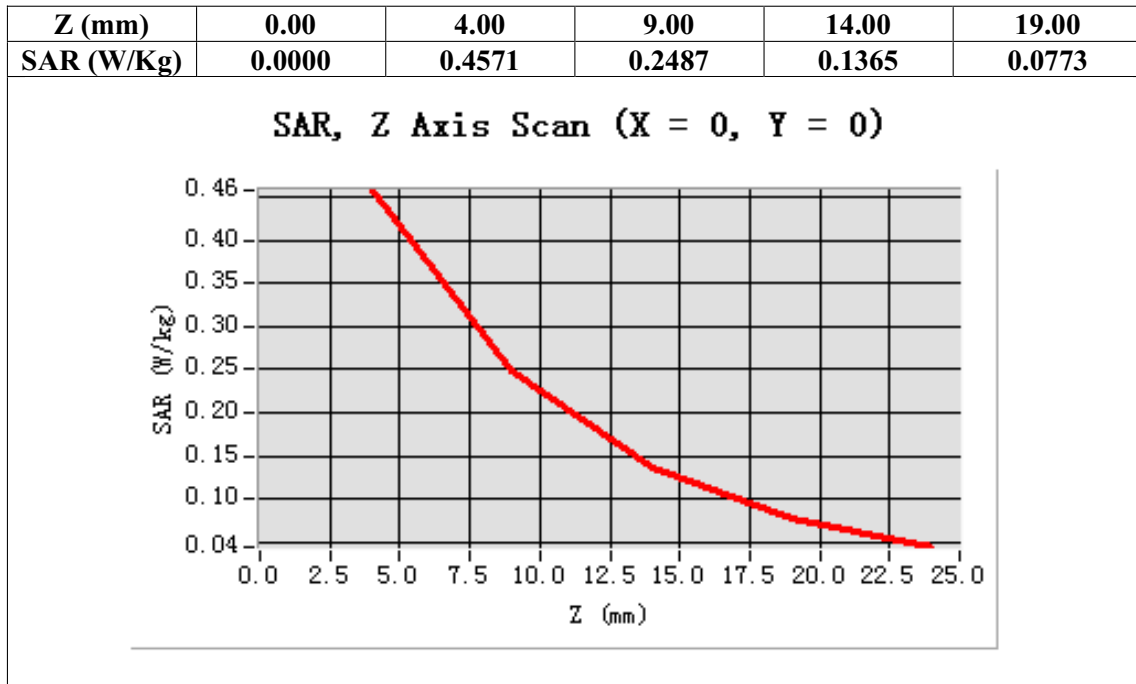

APPENDIX B. SAR MEASUREMENT DATA

Test Laboratory: AGC Lab

Date: Nov.13, 2013

GSM 835 Mid-Touch-Left <SIM 1>

DUT: Mobile Phone; Type: GO202

Communication System: Generic GSM; Communication System Band: GSM 835; Duty Cycle: 1:8.3; Conv.F=5.30
Frequency: 836.6 MHz; Medium parameters used: $f = 835$ MHz; $\sigma=0.87$ mho/m; $\epsilon_r = 40.16$; $\rho = 1000$ kg/m³ ;
Phantom section: Left Section
Ambient temperature (°C): 21.0, Liquid temperature (°C): 21.0

SATIMO Configuration:

Probe: EP165; Calibrated: 01/31/2013

- Sensor-Surface: 4mm (Mechanical Surface Detection)
- Phantom: Flat Phantom; Type: Elliptical Phantom
- Measurement SW: OpenSAR V4_02_01

Configuration/GSM 835 Mid-Touch-Left/Area Scan (6x8x1): Measurement grid: dx=8mm, dy=8mm

Configuration/GSM 835 Mid-Touch-Left/Zoom Scan (5x5x7)/Cube 0: Measurement grid: dx=8mm, dy=8mm, dz=5mm

Area Scan	sam_direct_droit2_surf8mm.txt
ZoomScan	5x5x7,dx=8mm dy=8mm dz=5mm,Very fast
Phantom	Left head
Device Position	Cheek
Band	GSM 835
Channels	Middle
Signal	TDMA (Crest factor: 8.0)

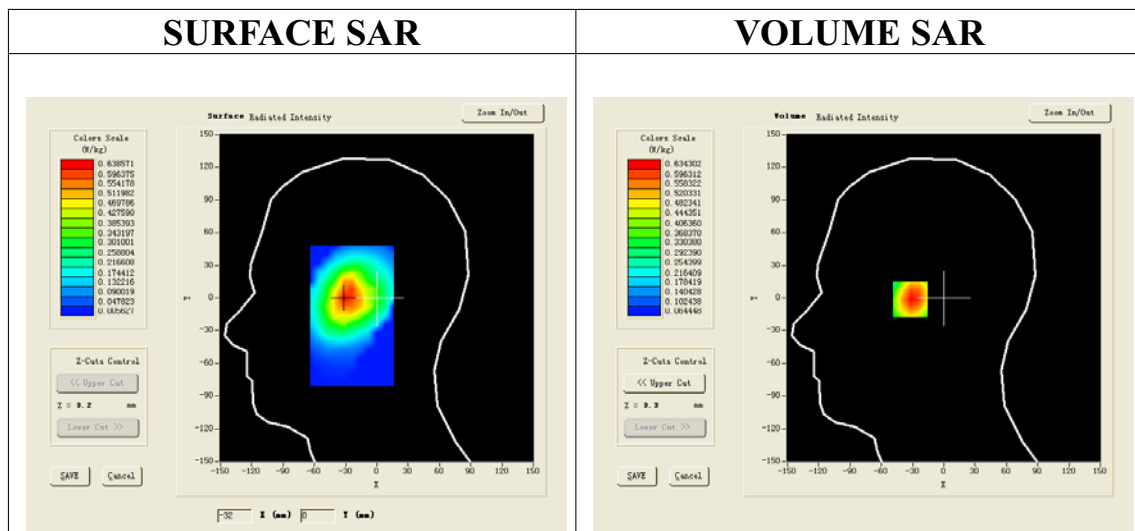

Maximum location: X=-31.00, Y=0.00

SAR 10g (W/Kg)	0.393051
SAR 1g (W/Kg)	0.605367

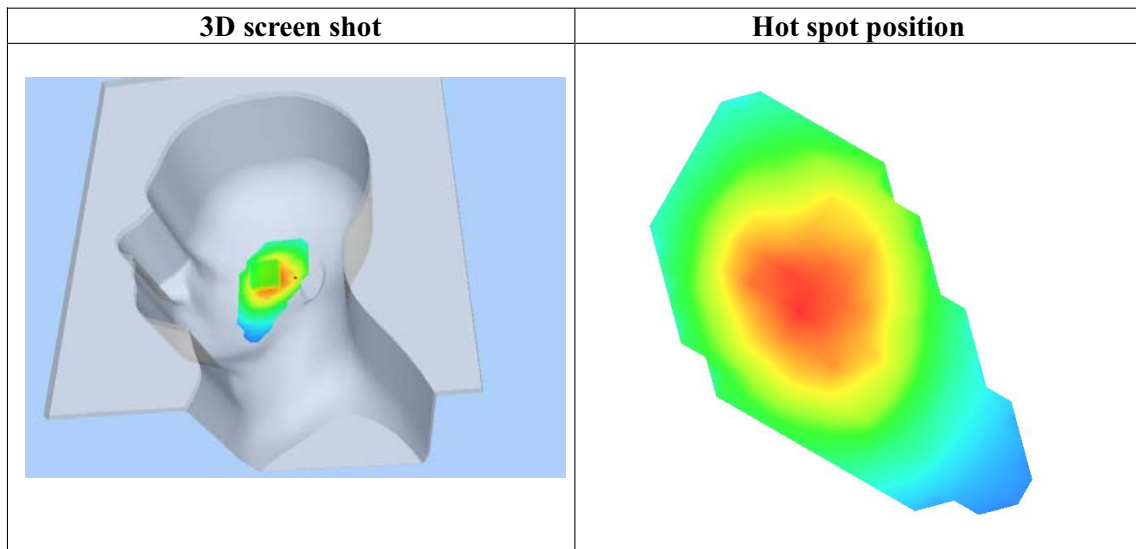
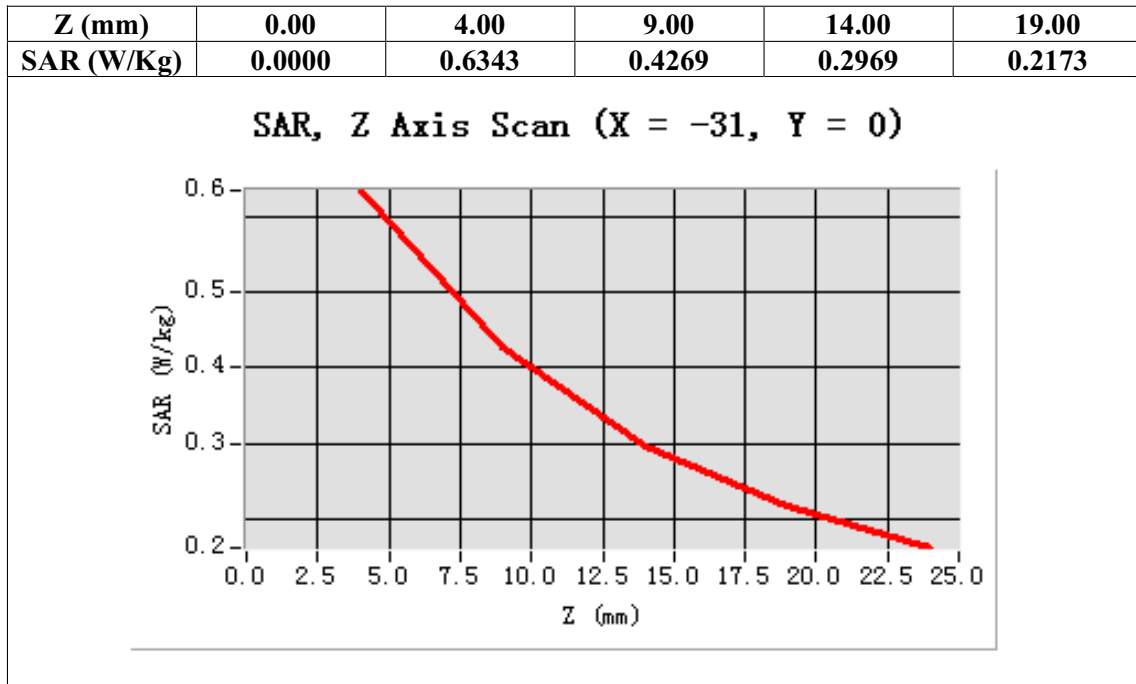

Test Laboratory: AGC Lab
GSM 835 Mid-Tilt-Left <SIM 1>
DUT: Mobile Phone; Type: GO202

Date: Nov.13, 2013

Communication System: Generic GSM; Communication System Band: GSM 835; Duty Cycle: 1:8.3; Conv.F=5.30;
Frequency: 836.6 MHz; Medium parameters used: $f = 835$ MHz; $\sigma = 0.87$ mho/m; $\epsilon_r = 40.16$; $\rho = 1000$ kg/m³ ;
Phantom section: Left Section
Ambient temperature (°C): 21.0, Liquid temperature(°C): 21.0

SATIMO Configuration:

Probe: EP165; Calibrated: 01/31/2013

- Sensor-Surface: 4mm (Mechanical Surface Detection)
- Phantom: Flat Phantom; Type: Elliptical Phantom
- Measurement SW: OpenSAR V4_02_01

Configuration/GSM 835 Mid-Tilt-Left/Area Scan (6x8x1): Measurement grid: dx=8mm, dy=8mm
Configuration/GSM 835 Mid-Tilt-Left/Zoom Scan (5x5x7)/Cube 0: Measurement grid: dx=8mm, dy=8mm,dz=5mm;

Area Scan	sam_direct_droit2_surf8mm.txt
ZoomScan	5x5x7,dx=8mm dy=8mm dz=5mm,Very fast
Phantom	Left head
Device Position	Tilt
Band	GSM 835
Channels	Middle
Signal	TDMA (Crest factor: 8.0)

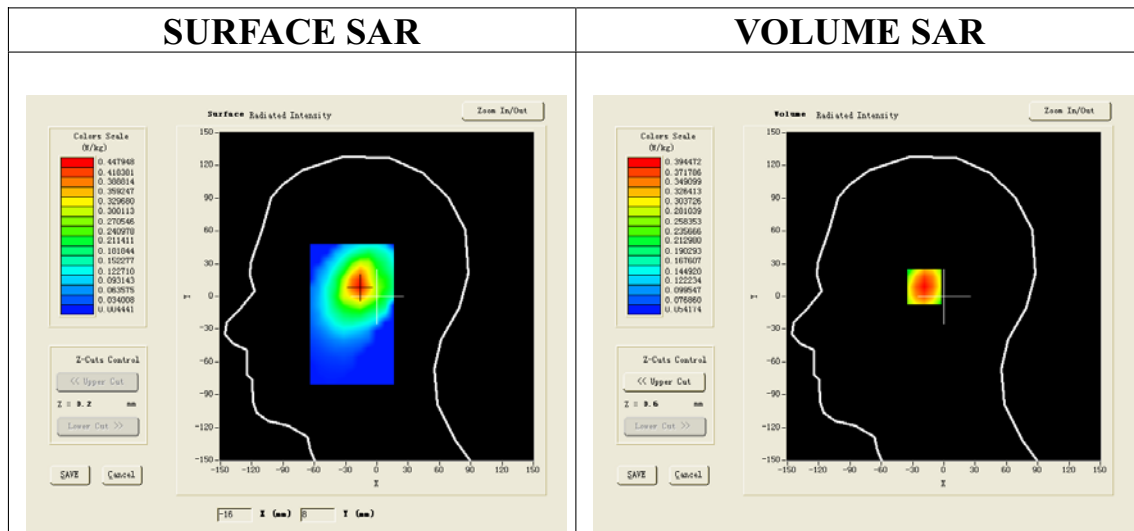

Maximum location: X=-17.00, Y=10.00

SAR 10g (W/Kg)	0.260491
SAR 1g (W/Kg)	0.375740

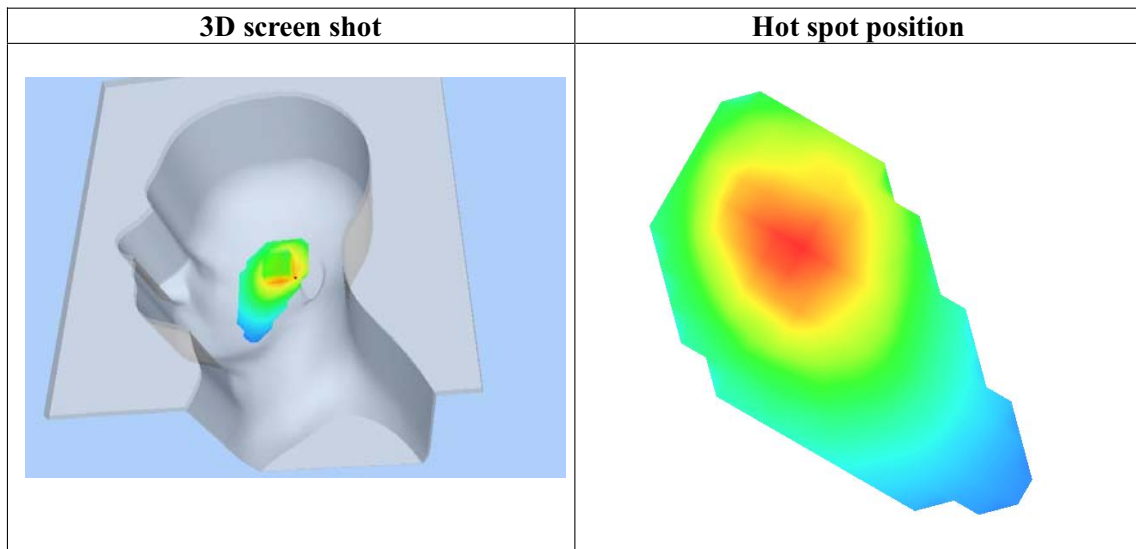
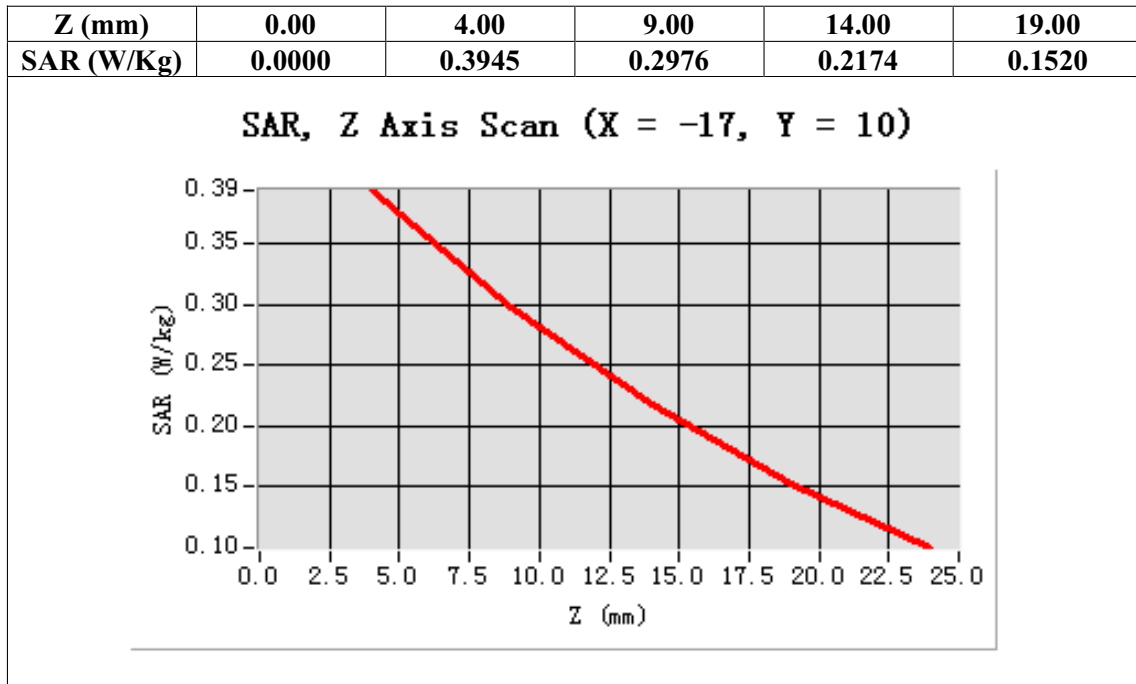

Test Laboratory: AGC Lab
GSM 835 Mid- Touch-Right <SIM 1>
DUT: Mobile Phone; Type: GO202

Date: Nov.13, 2013

Communication System: Generic GSM; Communication System Band: GSM 835; Duty Cycle: 1:8.3; Conv.F=5.30;
Frequency: 836.6 MHz; Medium parameters used: $f = 835$ MHz; $\sigma = 0.87$ mho/m; $\epsilon_r = 40.16$; $\rho = 1000$ kg/m³ ;
Phantom section: Right Section
Ambient temperature (°C): 21.0, Liquid temperature (°C): 21.0

SATIMO Configuration:

- Probe: EP165; Calibrated: 01/31/2013
- Sensor-Surface: 4mm (Mechanical Surface Detection)
- Phantom: Flat Phantom; Type: Elliptical Phantom
- Measurement SW: OpenSAR V4_02_01

Configuration/GSM 835 Mid-Touch-Right/Area Scan: Measurement grid: dx=8mm, dy=8mm

Configuration/GSM 835 Mid-Touch-Right/Zoom Scan: Measurement grid: dx=8mm, dy=8mm, dz=5mm;

Area Scan	sam_direct_droit2_surf8mm.txt
ZoomScan	5x5x7,dx=8mm dy=8mm dz=5mm,Very fast
Phantom	Right head
Device Position	Cheek
Band	GSM 835
Channels	Middle
Signal	TDMA (Crest factor: 8.0)

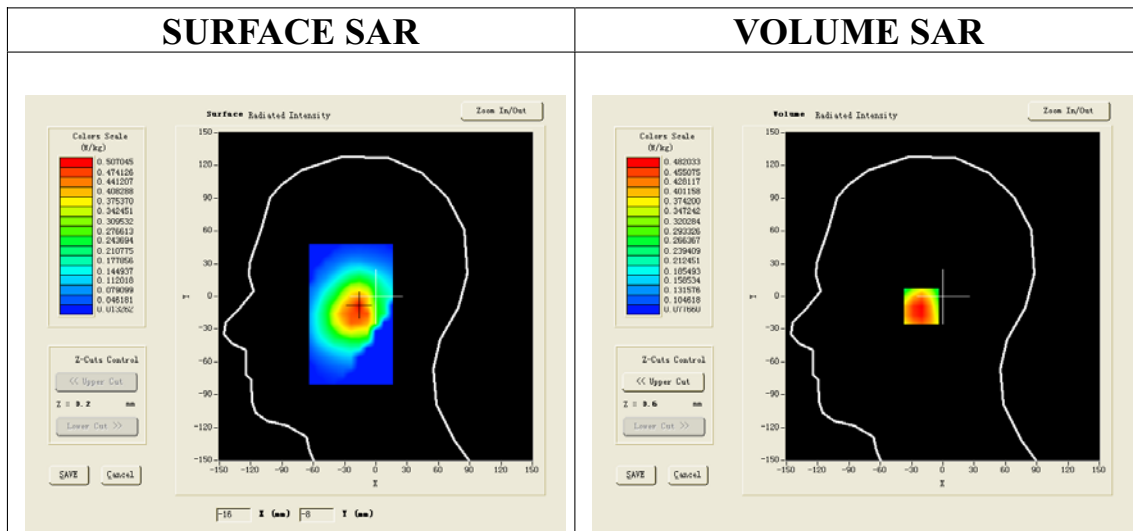

Maximum location: X=-17.00, Y=-9.00

SAR 10g (W/Kg)	0.332472
SAR 1g (W/Kg)	0.467712

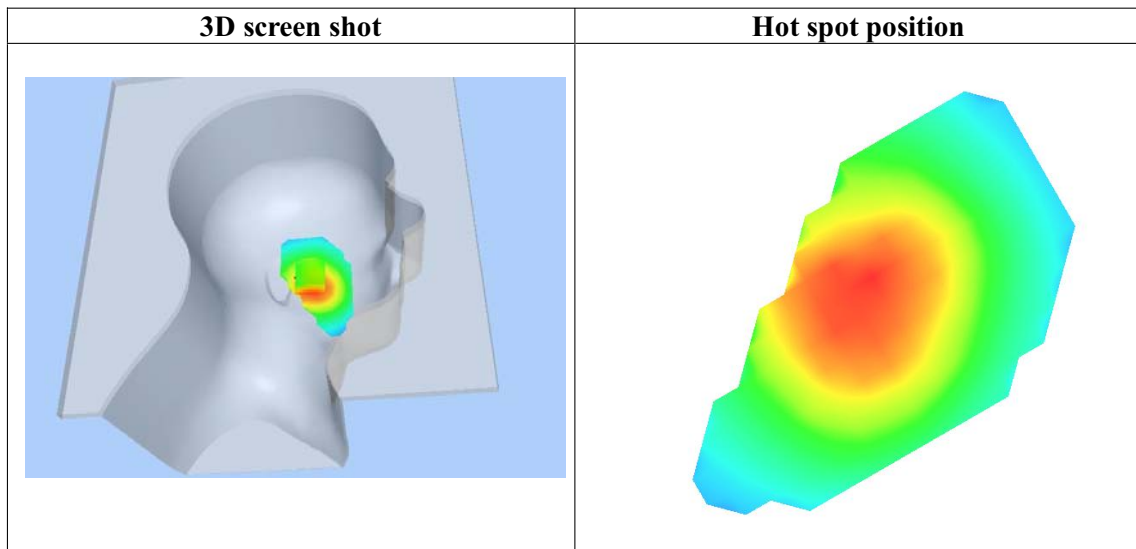
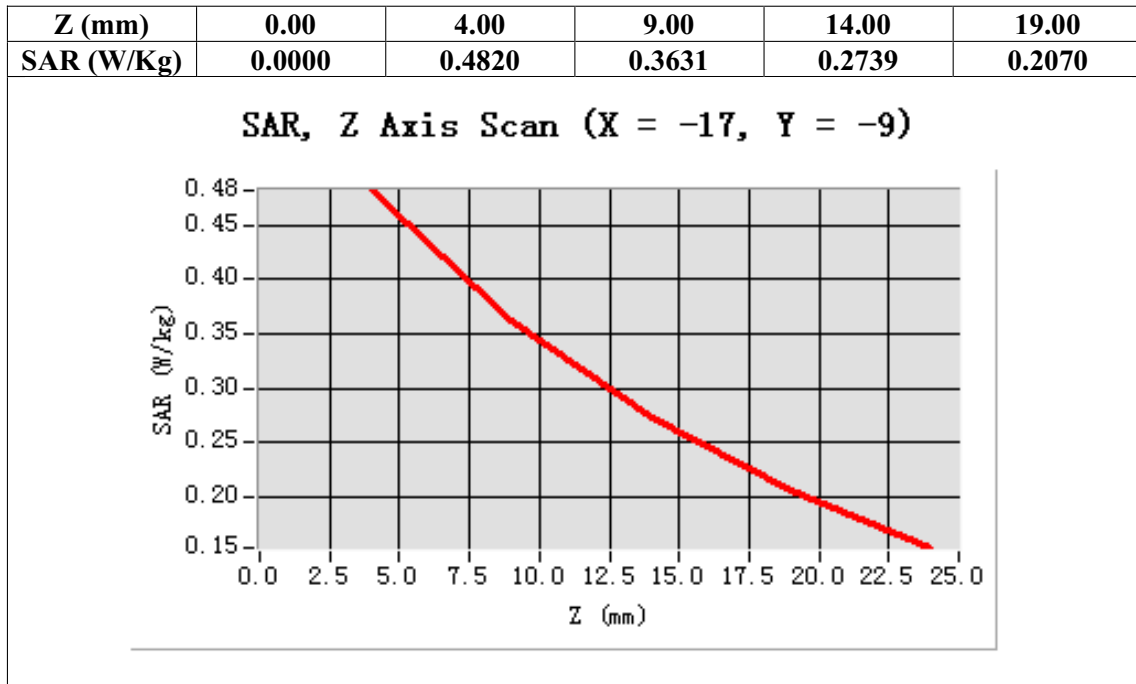

Test Laboratory: AGC Lab
GSM 835 Mid-Tilt-Right <SIM 1>
DUT: Mobile Phone; Type: GO202

Date: Nov.13, 2013

Communication System: Generic GSM; Communication System Band: GSM 835; Duty Cycle: 1:8.3; Conv.F=5.30;
Frequency: 836.6 MHz; Medium parameters used: $f = 835$ MHz; $\sigma = 0.87$ mho/m; $\epsilon_r = 40.16$; $\rho = 1000$ kg/m³ ;
Phantom section: Right Section
Ambient temperature (°C): 21.0, Liquid temperature (°C): 21.0

SATIMO Configuration:

Probe: EP165; Calibrated: 01/31/2013

- Sensor-Surface: 4mm (Mechanical Surface Detection)
- Phantom: Flat Phantom; Type: Elliptical Phantom
- Measurement SW: OpenSAR V4_02_01

Configuration/GSM 835 Mid-Tilt-Right/Area Scan: Measurement grid: dx=8mm, dy=8mm

Configuration/GSM 835 Mid-Tilt-Right/Zoom Scan: Measurement grid: dx=8mm, dy=8mm, dz=5mm;

Area Scan	sam_direct droit2_surf8mm.txt
Zoom Scan	5x5x7,dx=8mm dy=8mm dz=5mm,Very fast
Phantom	Right head
Device Position	Tilt
Band	GSM 835
Channels	Middle
Signal	TDMA (Crest factor: 8.0)

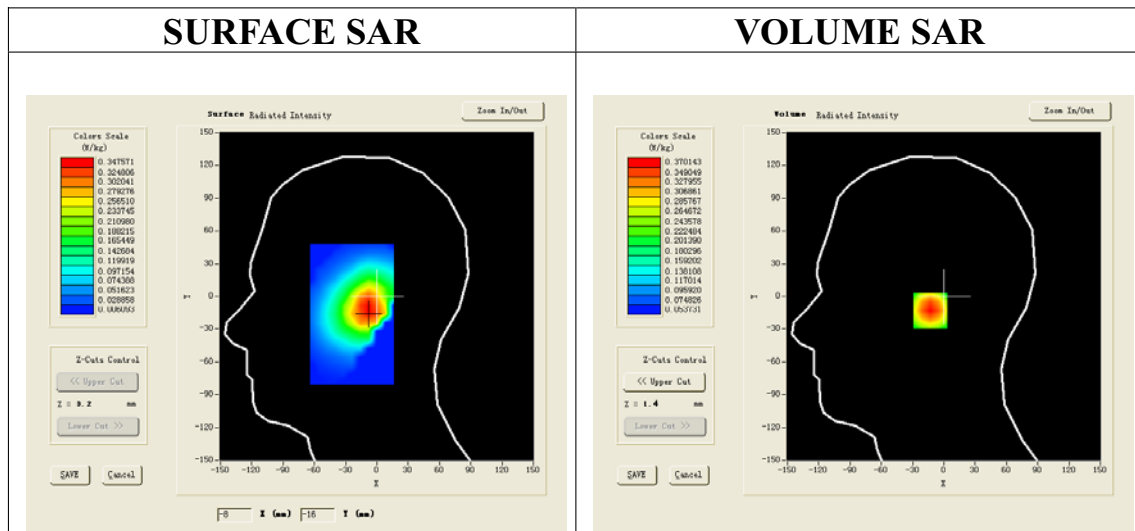

Maximum location: X=-8.00, Y=-13.00

SAR 10g (W/Kg)	0.232100
SAR 1g (W/Kg)	0.352403

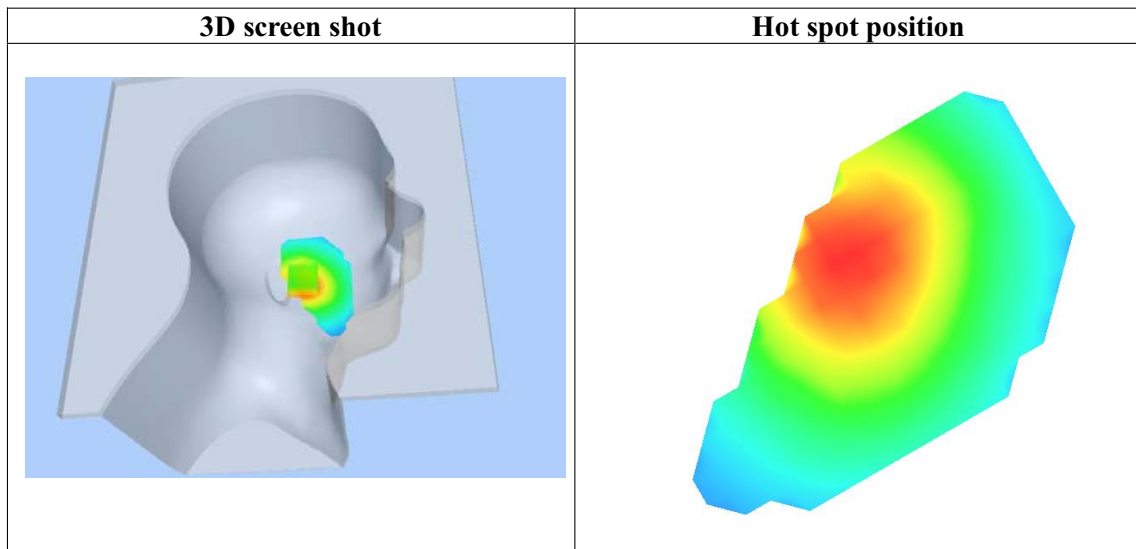
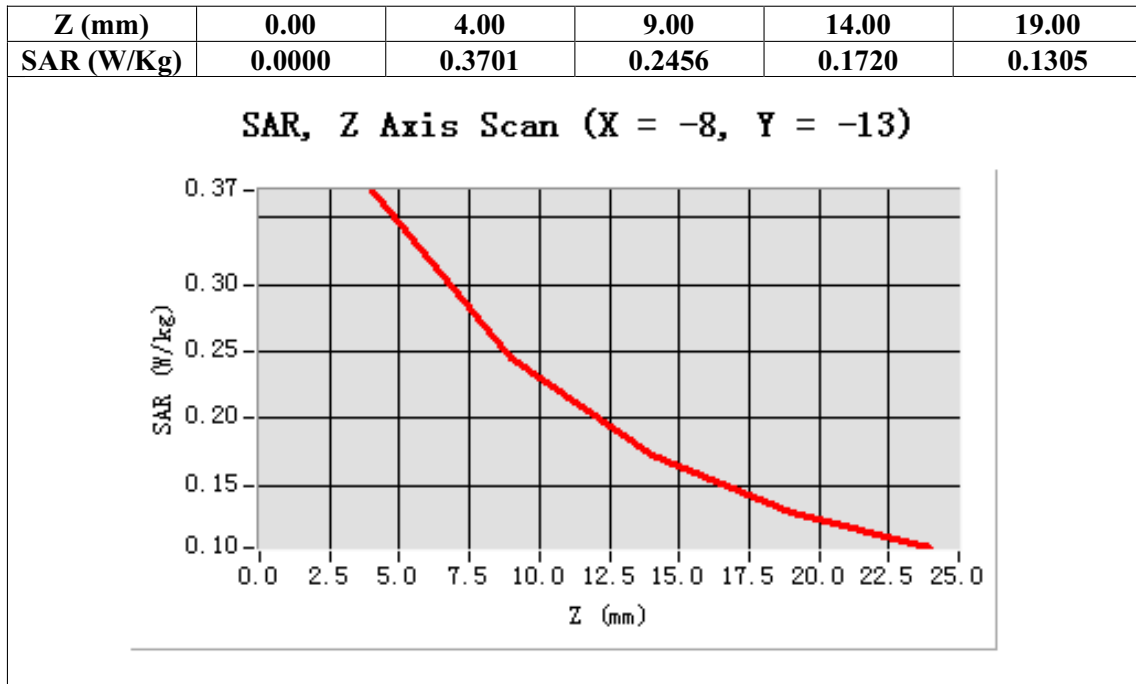

Test Laboratory: AGC Lab
GSM 835 Mid-Touch-Left <SIM 2>
DUT: Mobile Phone; Type: GO202

Date: Nov.13, 2013

Communication System: Generic GSM; Communication System Band: GSM 835; Duty Cycle: 1:8.3; Conv.F=5.30
Frequency: 836.6 MHz; Medium parameters used: $f = 835$ MHz; $\sigma=0.87$ mho/m; $\epsilon_r = 40.16$; $\rho = 1000$ kg/m³ ;
Phantom section: Left Section
Ambient temperature (°C): 21.0, Liquid temperature (°C): 21.0

SATIMO Configuration:

Probe: EP165; Calibrated: 01/31/2013

- Sensor-Surface: 4mm (Mechanical Surface Detection)
- Phantom: Flat Phantom; Type: Elliptical Phantom
- Measurement SW: OpenSAR V4_02_01

Configuration/GSM 835 Mid-Touch-Left/Area Scan (6x8x1): Measurement grid: dx=8mm, dy=8mm
Configuration/GSM 835 Mid-Touch-Left/Zoom Scan (5x5x7)/Cube 0: Measurement grid: dx=8mm, dy=8mm, dz=5mm

Area Scan	sam_direct droit2_surf8mm.txt
ZoomScan	5x5x7,dx=8mm dy=8mm dz=5mm,Very fast
Phantom	Left head
Device Position	Cheek
Band	GSM 835
Channels	Middle
Signal	TDMA (Crest factor: 8.0)

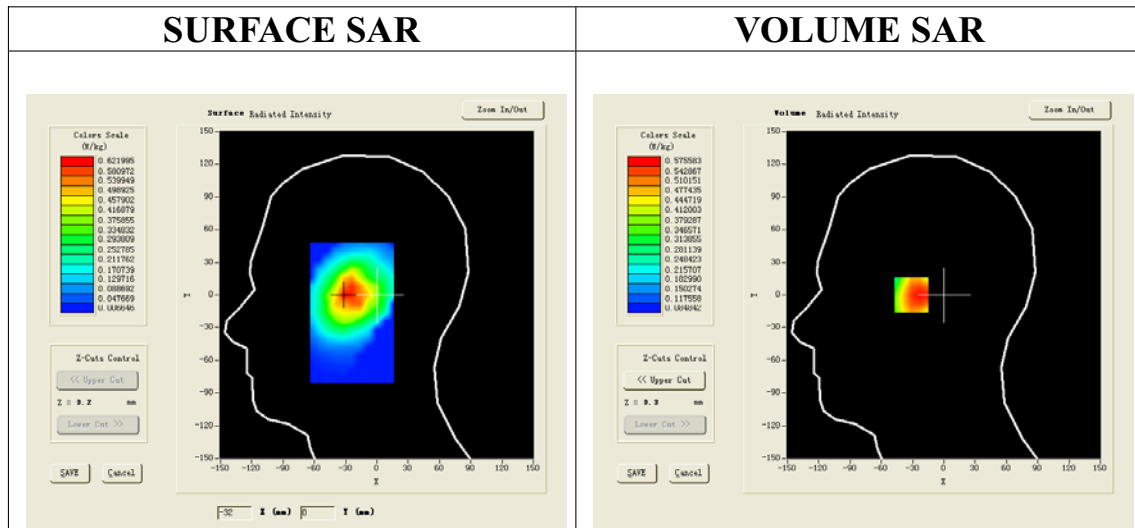

Maximum location: X=-30.00, Y=1.00

SAR 10g (W/Kg)	0.401690
SAR 1g (W/Kg)	0.562718

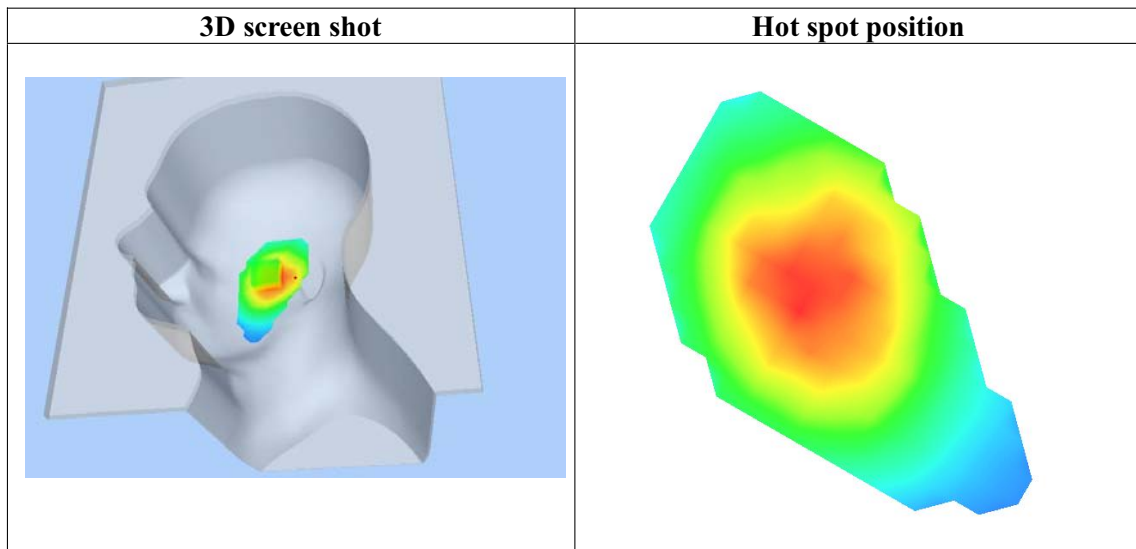
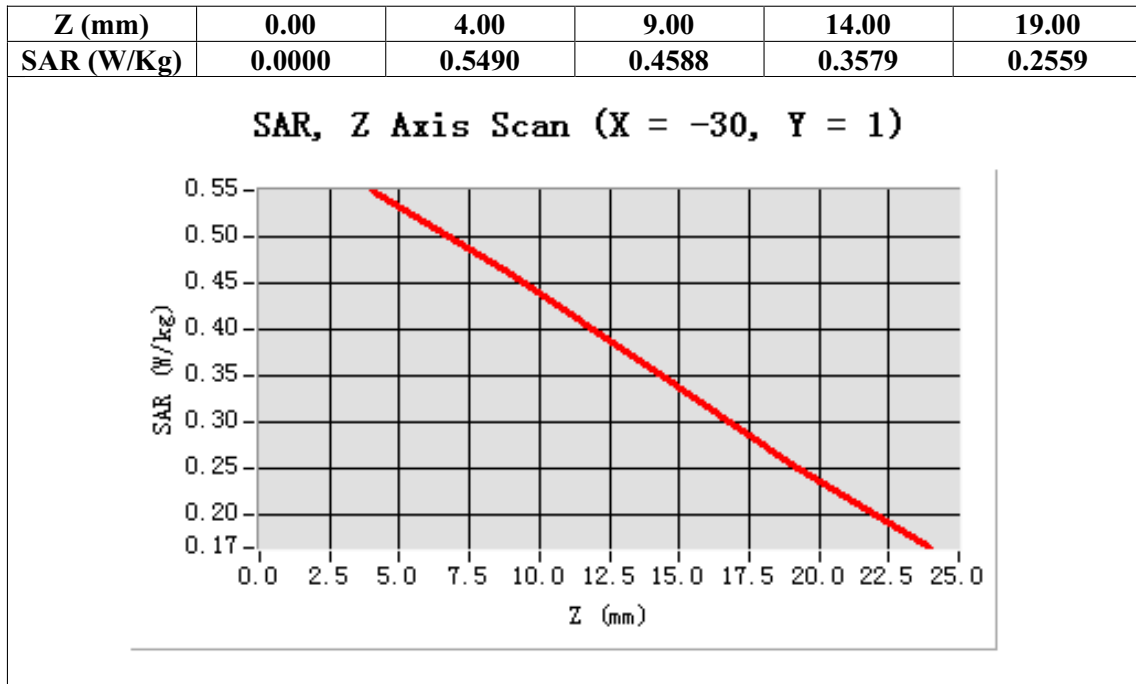

Test Laboratory: AGC Lab
GSM 835 Low- Body- Back <SIM 1>
DUT: Mobile Phone; Type: GO202

Date: Nov.13, 2013

Communication System: Generic GSM; Communication System Band: GSM 835; Duty Cycle: 1:8.3; Conv.F=5.46;
Frequency: 824.2 MHz; Medium parameters used: $f = 835$ MHz; $\sigma = 0.95$ mho/m; $\epsilon_r = 53.26$; $\rho = 1000$ kg/m³ ;
Phantom section: Flat Section
Ambient temperature (°C): 21.0, Liquid temperature (°C): 21.0

SATIMO Configuration:

- Probe: EP165; Calibrated: 01/31/2013
- Sensor-Surface: 4mm (Mechanical Surface Detection)
- Phantom: Flat Phantom; Type: Elliptical Phantom
- Measurement SW: OpenSAR V4_02_01

Configuration/GSM 835 Low-Body-Back/Area Scan (6x8x1): Measurement grid: dx=8mm, dy=8mm
Configuration/GSM 835 Low-Body-Back/Zoom Scan (5x5x7)/Cube 0: Measurement grid: dx=8mm, dy=8mm, dz=5mm;

Area Scan	surf_sam_plan.txt
ZoomScan	5x5x7,dx=8mm dy=8mm dz=5mm,Very fast
Phantom	Validation plane
Device Position	Body Back
Band	GSM 835
Channels	Low
Signal	TDMA (Crest factor: 8.0)

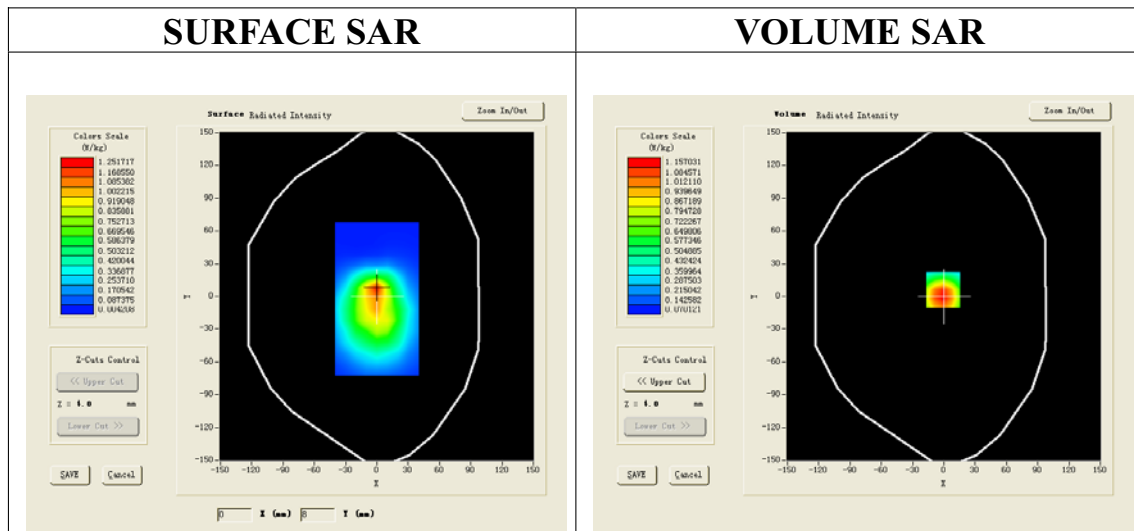

Maximum location: X=-1.00, Y=6.00

SAR 10g (W/Kg)	0.698685
SAR 1g (W/Kg)	1.103383

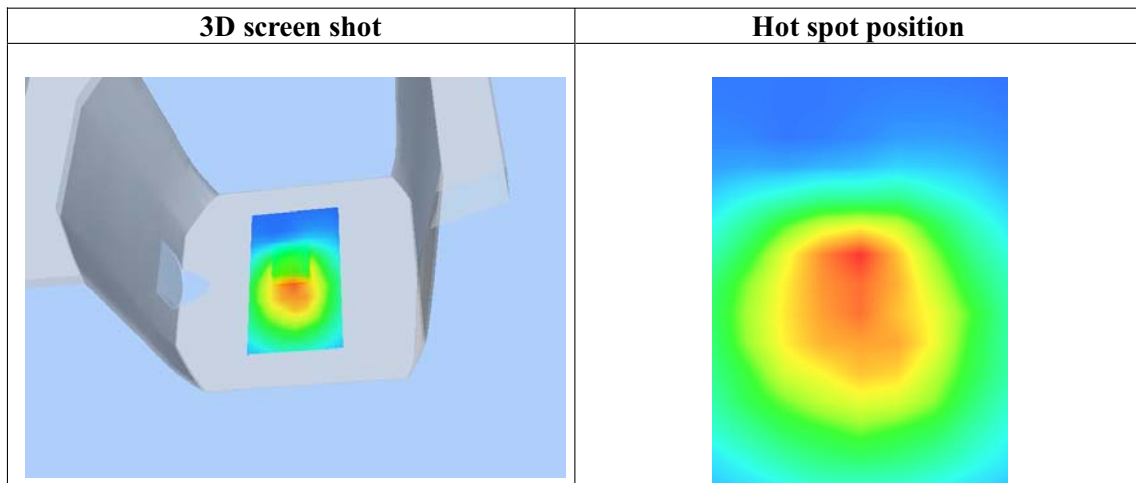
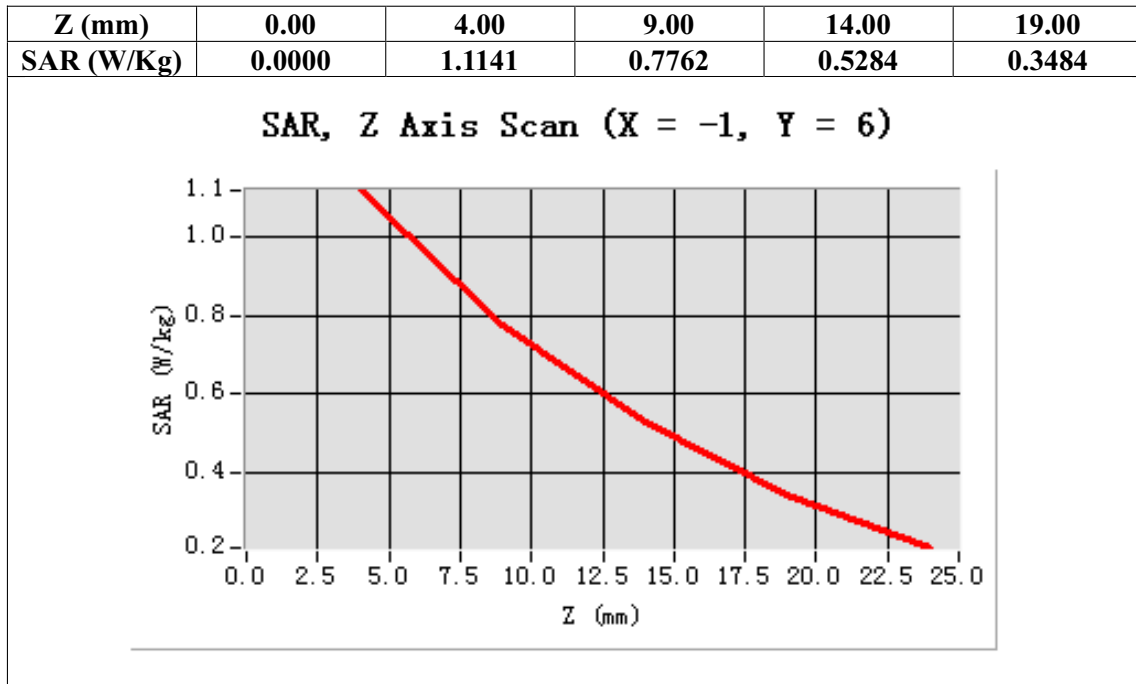

Test Laboratory: AGC Lab
GSM 835 Mid- Body- Back <SIM 1>
DUT: Mobile Phone; Type: GO202

Date: Nov.13, 2013

Communication System: Generic GSM; Communication System Band: GSM 835; Duty Cycle: 1:8.3; Conv.F=5.46;
Frequency: 836.6 MHz; Medium parameters used: $f = 835$ MHz; $\sigma = 0.95$ mho/m; $\epsilon_r = 53.26$; $\rho = 1000$ kg/m³ ;
Phantom section: Flat Section
Ambient temperature (°C): 21.0, Liquid temperature (°C): 21.0

SATIMO Configuration:

- Probe: EP165; Calibrated: 01/31/2013
- Sensor-Surface: 4mm (Mechanical Surface Detection)
- Phantom: Flat Phantom; Type: Elliptical Phantom
- Measurement SW: OpenSAR V4_02_01

Configuration/GSM 835 Mid-Body-Back/Area Scan (6x8x1): Measurement grid: dx=8mm, dy=8mm
Configuration/GSM 835 Mid-Body-Back/Zoom Scan (5x5x7)/Cube 0: Measurement grid: dx=8mm, dy=8mm, dz=5mm;

Area Scan	surf_sam_plan.txt
ZoomScan	5x5x7,dx=8mm dy=8mm dz=5mm,Very fast
Phantom	Validation plane
Device Position	Body Back
Band	GSM 835
Channels	Middle
Signal	TDMA (Crest factor: 8.0)

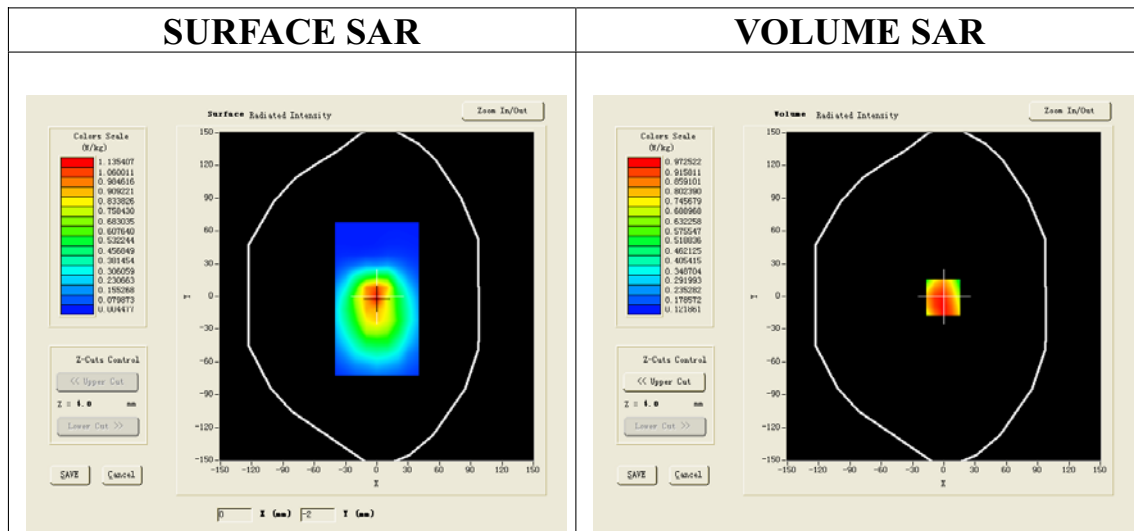

Maximum location: X=-1.00, Y=-1.00

SAR 10g (W/Kg)	0.648289
SAR 1g (W/Kg)	0.943217

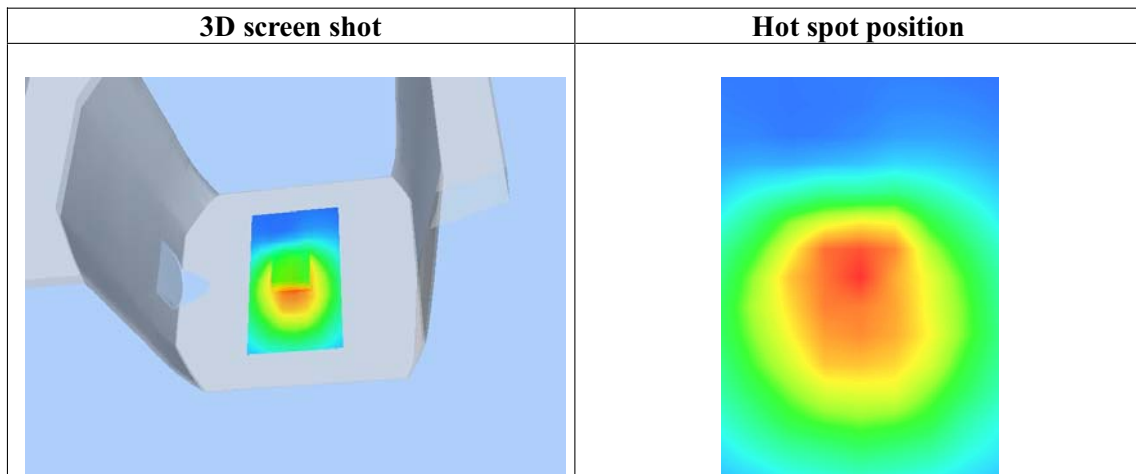
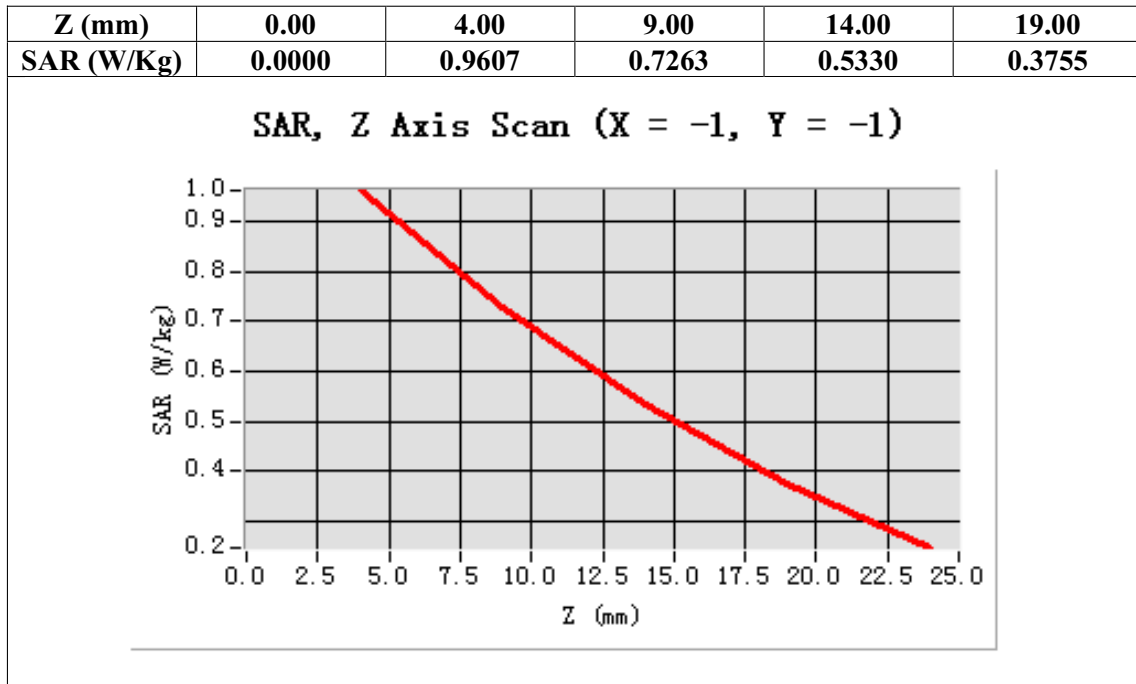

Test Laboratory: AGC Lab
GSM 835 High- Body- Back <SIM 1>
DUT: Mobile Phone; Type: GO202

Date: Nov.13, 2013

Communication System: Generic GSM; Communication System Band: GSM 835; Duty Cycle: 1:8.3; Conv.F=5.46;
Frequency: 848.8 MHz; Medium parameters used: $f = 835$ MHz; $\sigma = 0.95$ mho/m; $\epsilon_r = 53.26$; $\rho = 1000$ kg/m³ ;
Phantom section: Flat Section
Ambient temperature (°C): 21.0, Liquid temperature (°C): 21.0

SATIMO Configuration:

- Probe: EP165; Calibrated: 01/31/2013
- Sensor-Surface: 4mm (Mechanical Surface Detection)
- Phantom: Flat Phantom; Type: Elliptical Phantom
- Measurement SW: OpenSAR V4_02_01

Configuration/GSM 835 High-Body-Back/Area Scan (6x8x1): Measurement grid: dx=8mm, dy=8mm
Configuration/GSM 835 High-Body-Back/Zoom Scan (5x5x7)/Cube 0: Measurement grid: dx=8mm, dy=8mm, dz=5mm;

Area Scan	surf_sam_plan.txt
ZoomScan	5x5x7,dx=8mm dy=8mm dz=5mm,Very fast
Phantom	Validation plane
Device Position	Body Back
Band	GSM 835
Channels	High
Signal	TDMA (Crest factor: 8.0)

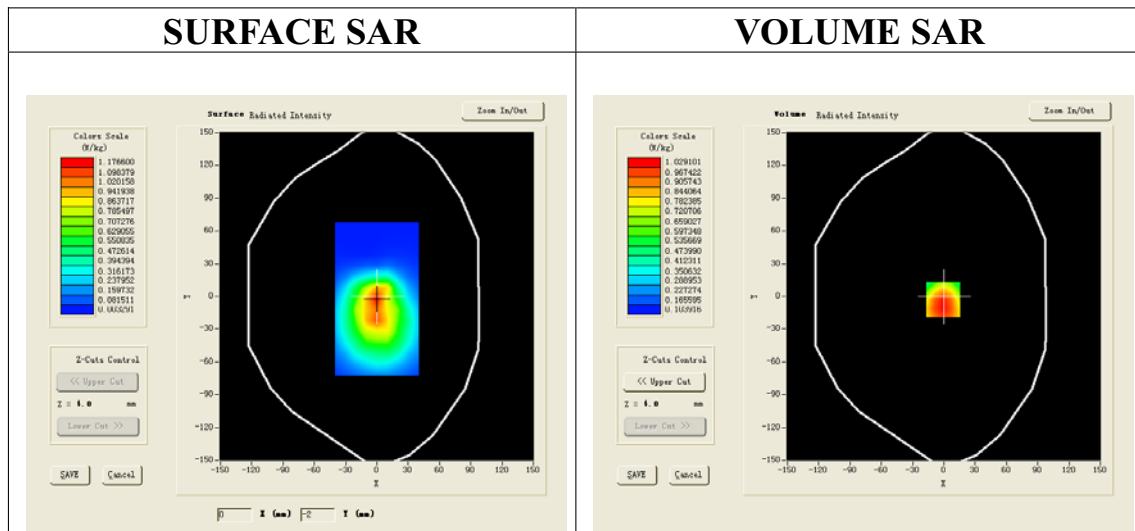

Maximum location: X=-1.00, Y=-3.00

SAR 10g (W/Kg)	0.682428
SAR 1g (W/Kg)	0.987880

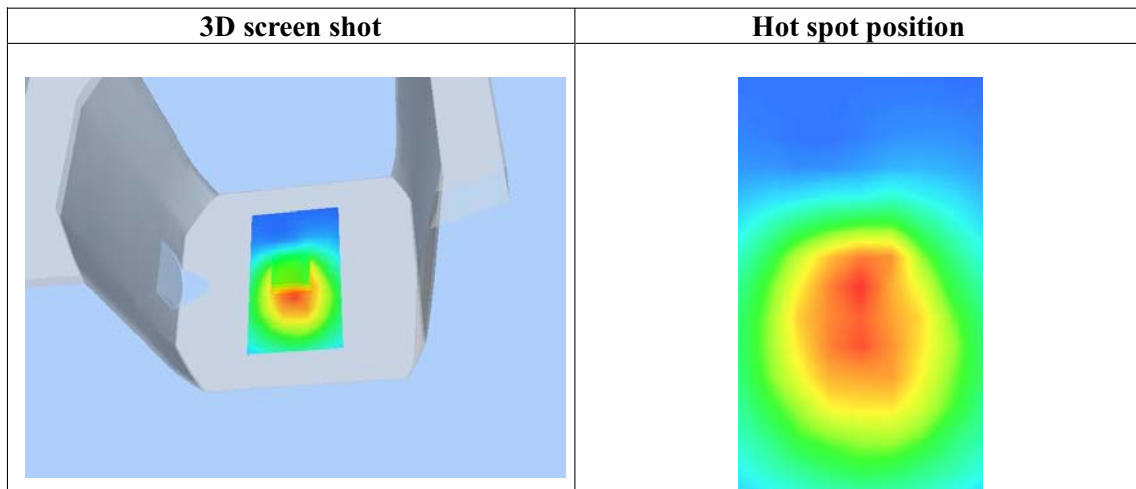
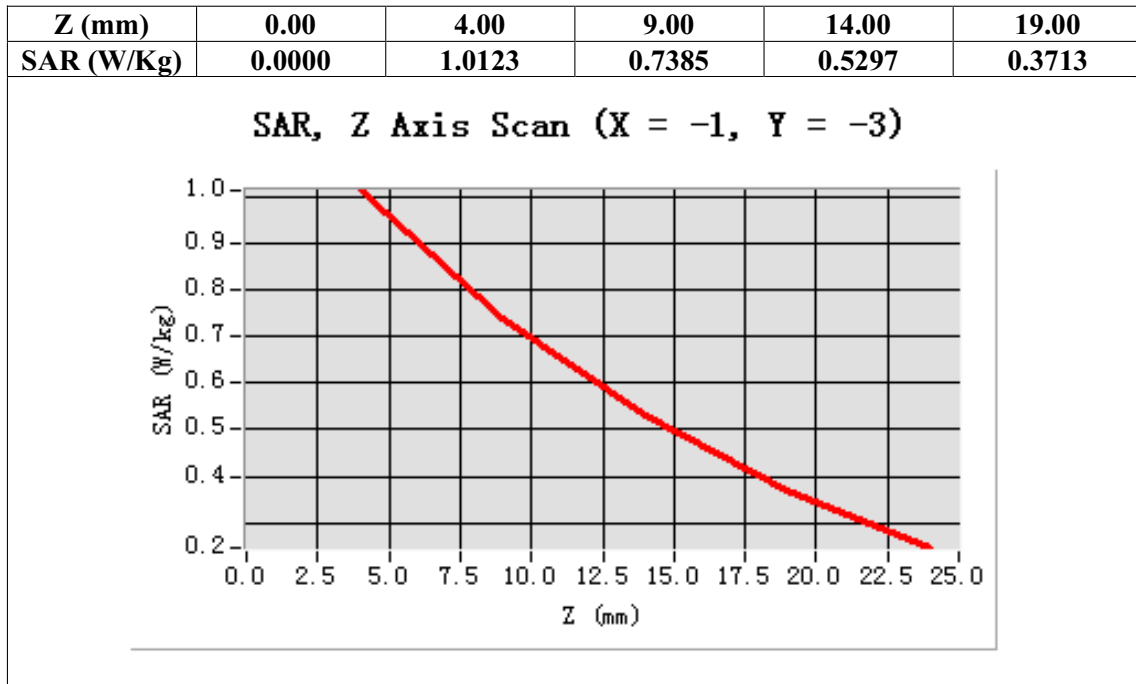

Test Laboratory: AGC Lab
GSM 835 Low- Body- Front (MS) <SIM 1>
DUT: Mobile Phone; Type: GO202

Date: Nov.13, 2013

Communication System: Generic GSM; Communication System Band: GSM 835; Duty Cycle: 1:8.3; Conv.F=5.46;
Frequency: 824.2 MHz; Medium parameters used: $f = 835$ MHz; $\sigma = 0.95$ mho/m; $\epsilon_r = 53.26$; $\rho = 1000$ kg/m³ ;
Phantom section: Flat Section
Ambient temperature (°C): 21.0, Liquid temperature (°C): 21.0

SATIMO Configuration:

- Probe: EP165; Calibrated: 01/31/2013
- Sensor-Surface: 4mm (Mechanical Surface Detection)
- Phantom: Flat Phantom; Type: Elliptical Phantom
- Measurement SW: OpenSAR V4_02_01

Configuration/GSM 835 Low-Body- Front /Area Scan (6x8x1): Measurement grid: dx=8mm, dy=8mm
Configuration/GSM 835 Low-Body- Front Zoom Scan (5x5x7)/Cube 0: Measurement grid: dx=8mm, dy=8mm, dz=5mm;

Area Scan	surf_sam_plan.txt
ZoomScan	5x5x7,dx=8mm dy=8mm dz=5mm,Very fast
Phantom	Validation plane
Device Position	Body Front
Band	GSM 835
Channels	Low
Signal	TDMA (Crest factor: 8.0)

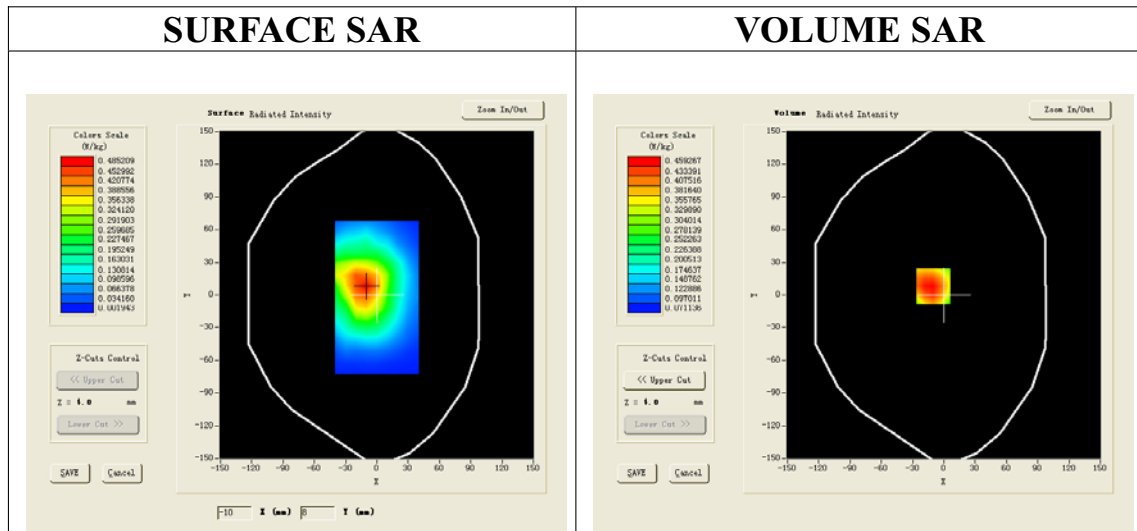

Maximum location: X=-10.00, Y=8.00

SAR 10g (W/Kg)	0.305755
SAR 1g (W/Kg)	0.443946

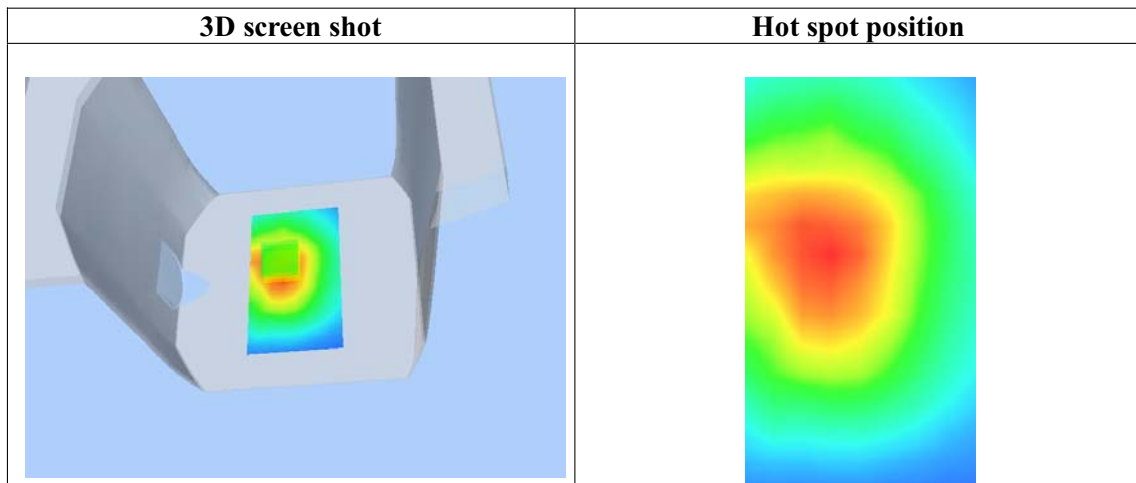
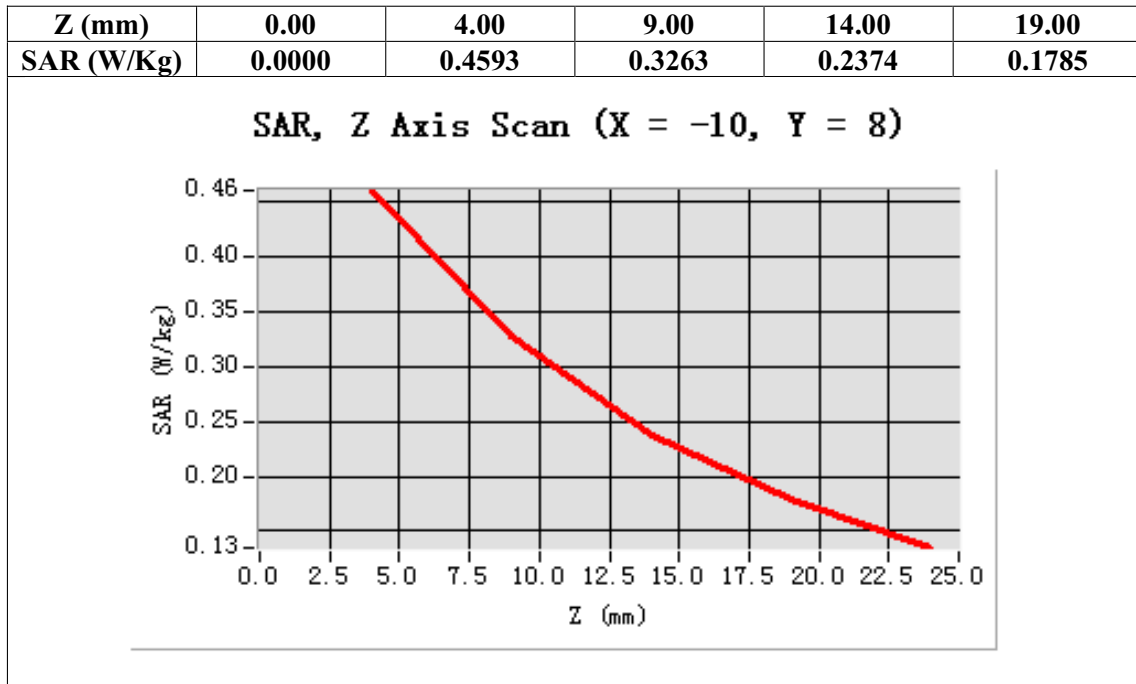

Test Laboratory: AGC Lab
PCS 1900 Mid-Touch- Left <SIM 1>
DUT: Mobile Phone; Type: GO202

Date: Nov.13, 2013

Communication System: Generic GSM; Communication System Band: PCS 1900; Duty Cycle: 1:8.3; Conv.F=4.72;
Frequency: 1880 MHz; Medium parameters used: $f = 1900$ MHz; $\sigma = 1.38$ mho/m; $\epsilon_r = 41.31$; $\rho = 1000$ kg/m³ ;
Phantom section: Left Section
Ambient temperature (°C): 21.0, Liquid temperature (°C): 21.0

SATIMO Configuration:

Probe: EP165; Calibrated: 01/31/2013

- Sensor-Surface: 4mm (Mechanical Surface Detection)
- Phantom: Flat Phantom; Type: Elliptical Phantom
- Measurement SW: OpenSAR V4_02_01

Configuration/PCS1900 Mid-Touch-Left/Area Scan: Measurement grid: dx=8mm, dy=8mm
Configuration/PCS1900 Mid-Touch-Left/Zoom Scan: Measurement grid: dx=8mm, dy=8mm, dz=5mm;

Area Scan	sam_direct_droit2_surf8mm.txt
ZoomScan	5x5x7,dx=8mm dy=8mm dz=5mm,Very fast
Phantom	Left head
Device Position	Cheek
Band	PCS 1900
Channels	Middle
Signal	TDMA (Crest factor: 8.0)

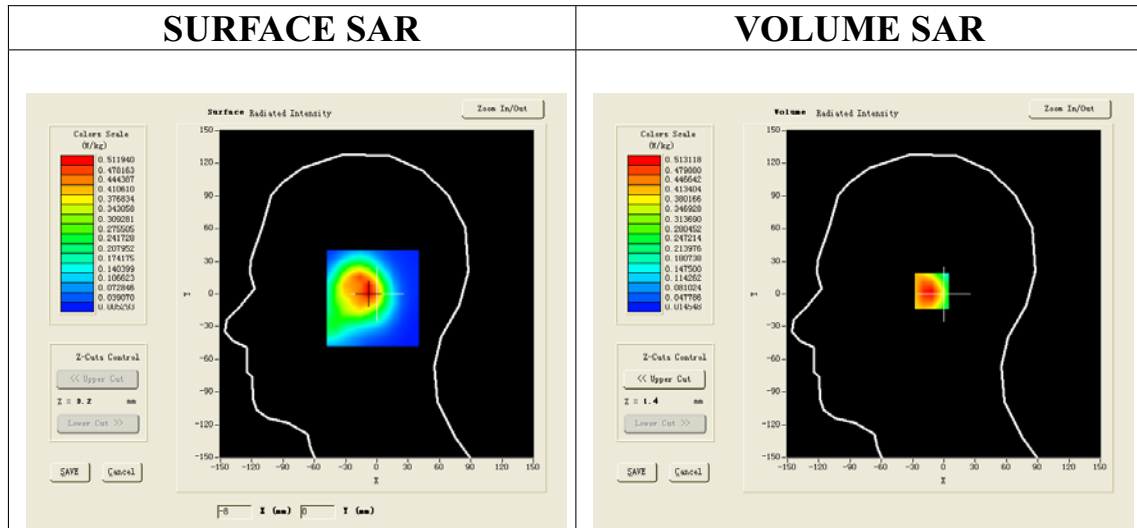

Maximum location: X=-8.00, Y=3.00

SAR 10g (W/Kg)	0.280629
SAR 1g (W/Kg)	0.490031

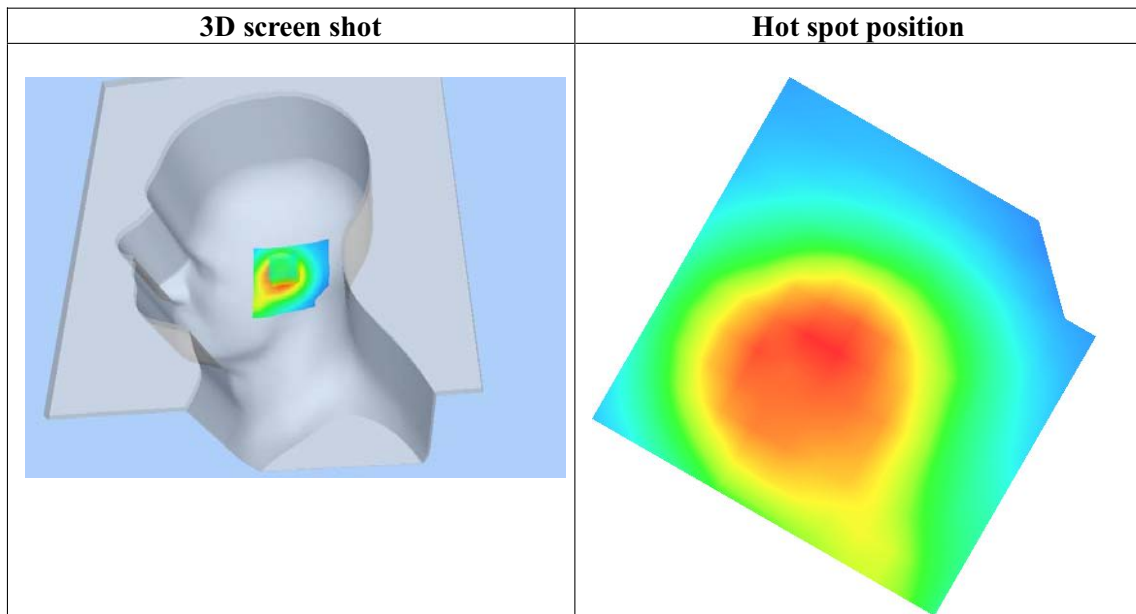
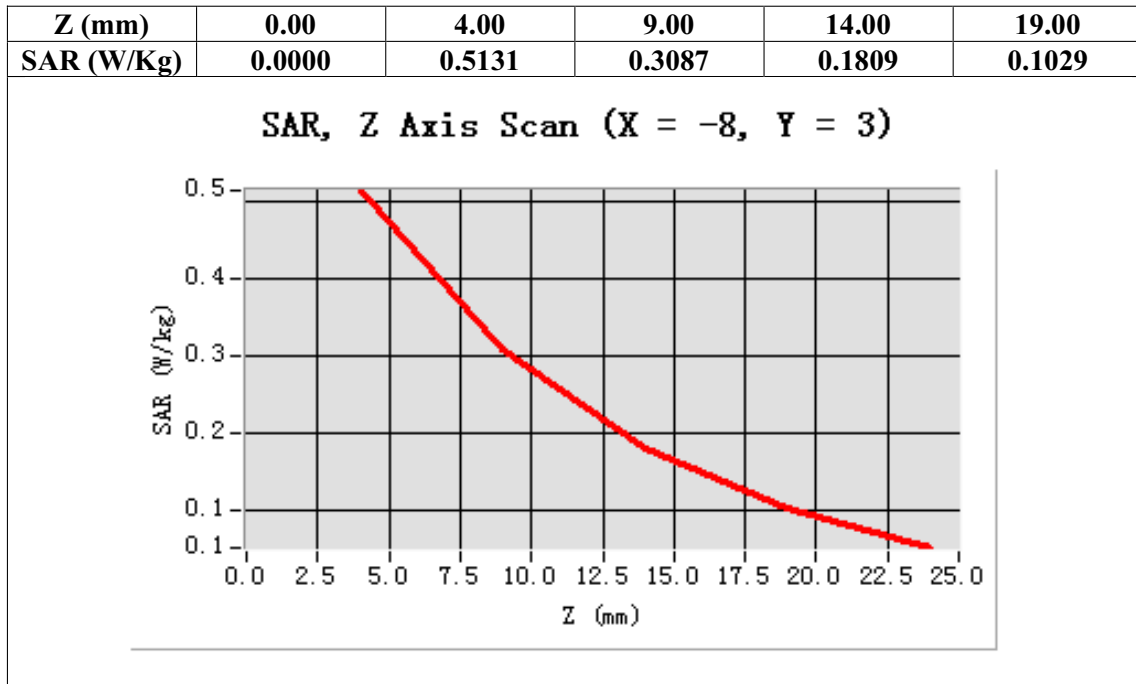

Test Laboratory: AGC Lab
PCS 1900 Mid-Tilt-Left <SIM 1>
DUT: Mobile Phone; Type: GO202

Date: Nov.13, 2013

Communication System: Generic GSM; Communication System Band: PCS 1900; Duty Cycle: 1:8.3; Conv.F=4.72;
Frequency: 1880 MHz; Medium parameters used: $f = 1900$ MHz; $\sigma = 1.38$ mho/m; $\epsilon_r = 41.31$; $\rho = 1000$ kg/m³ ;
Phantom section: Left Section
Ambient temperature (°C): 21.0, Liquid temperature (°C): 21.0

SATIMO Configuration:

Probe: EP165; Calibrated: 01/31/2013

- Sensor-Surface: 4mm (Mechanical Surface Detection)
- Phantom: Flat Phantom; Type: Elliptical Phantom
- Measurement SW: OpenSAR V4_02_01

Configuration/PCS1900 Mid-Tilt-Left/Area Scan: Measurement grid: dx=8mm, dy=8mm

Configuration/PCS1900 Mid-Tilt-Left/Zoom Scan: Measurement grid: dx=8mm, dy=8mm,dz=5mm;

Area Scan	sam_direct_droit2_surf8mm.txt
ZoomScan	5x5x7,dx=8mm dy=8mm dz=5mm,Very fast
Phantom	Left head
Device Position	Tilt
Band	PCS 1900
Channels	Middle
Signal	TDMA (Crest factor: 8.0)

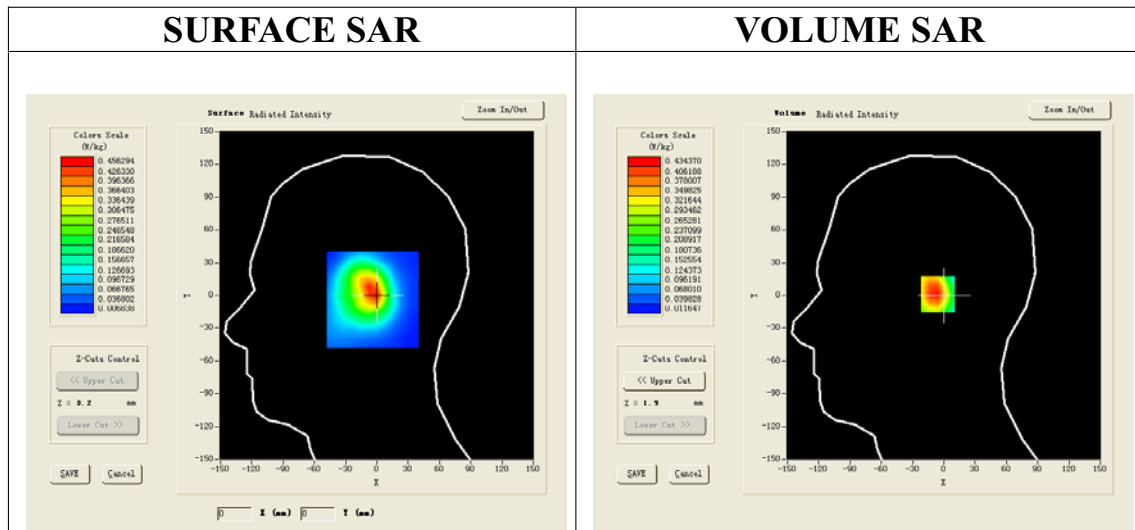

Maximum location: X=-2.00, Y=1.00

SAR 10g (W/Kg)	0.230123
SAR 1g (W/Kg)	0.414086

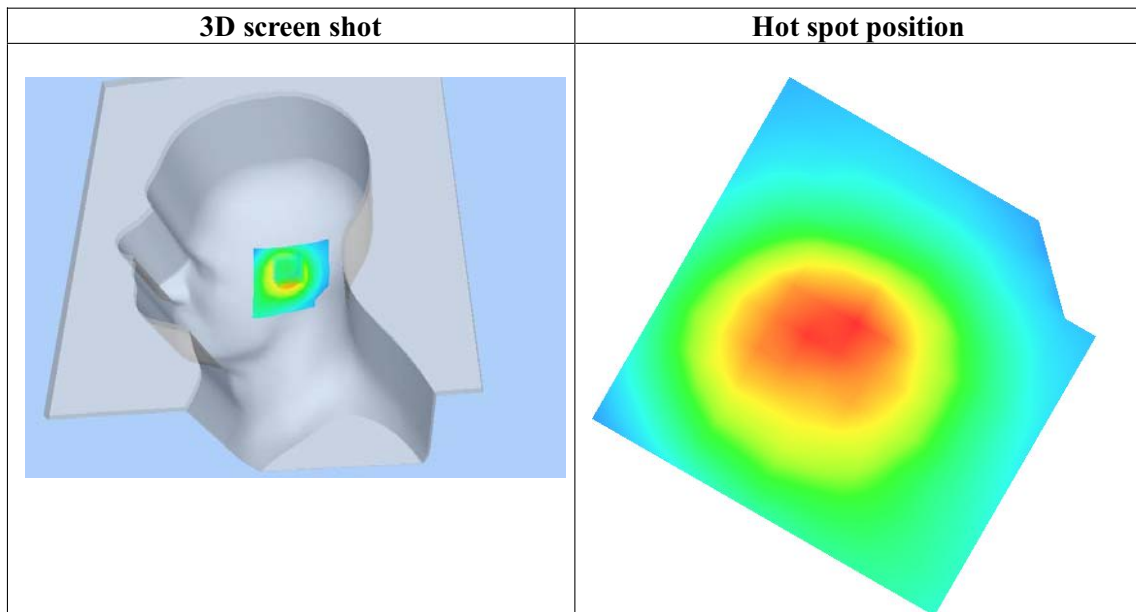
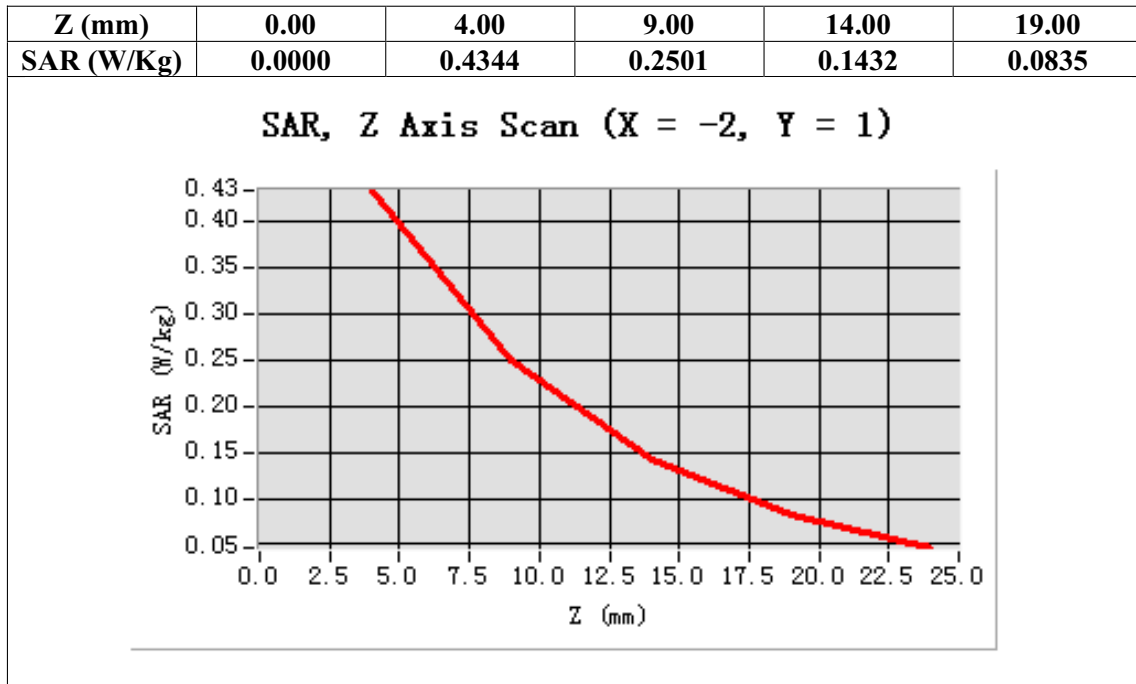

Test Laboratory: AGC Lab
PCS 1900 Mid-Touch-Right <SIM 1>
DUT: Mobile Phone; Type: GO202

Date: Nov.13, 2013

Communication System: Generic GSM; Communication System Band: PCS 1900; Duty Cycle: 1:8.3; Conv.F=4.72;
Frequency: 1880 MHz; Medium parameters used: $f = 1900$ MHz; $\sigma = 1.38$ mho/m; $\epsilon_r = 41.31$; $\rho = 1000$ kg/m³ ;
Phantom section: Right Section
Ambient temperature (°C): 21.0, Liquid temperature (°C): 21.0

SATIMO Configuration:

Probe: EP165; Calibrated: 01/31/2013

- Sensor-Surface: 4mm (Mechanical Surface Detection)
- Phantom: Flat Phantom; Type: Elliptical Phantom
- Measurement SW: OpenSAR V4_02_01

Configuration/PCS1900 Mid-Touch-Right/Area Scan: Measurement grid: dx=8mm, dy=8mm

Configuration/PCS1900 Mid-Touch-Right/Zoom Scan: Measurement grid: dx=8mm, dy=8mm, dz=5mm;

Area Scan	sam_direct_droit2_surf8mm.txt
ZoomScan	5x5x7,dx=8mm dy=8mm dz=5mm,Very fast
Phantom	Right head
Device Position	Cheek
Band	PCS 1900
Channels	Middle
Signal	TDMA (Crest factor: 8.0)

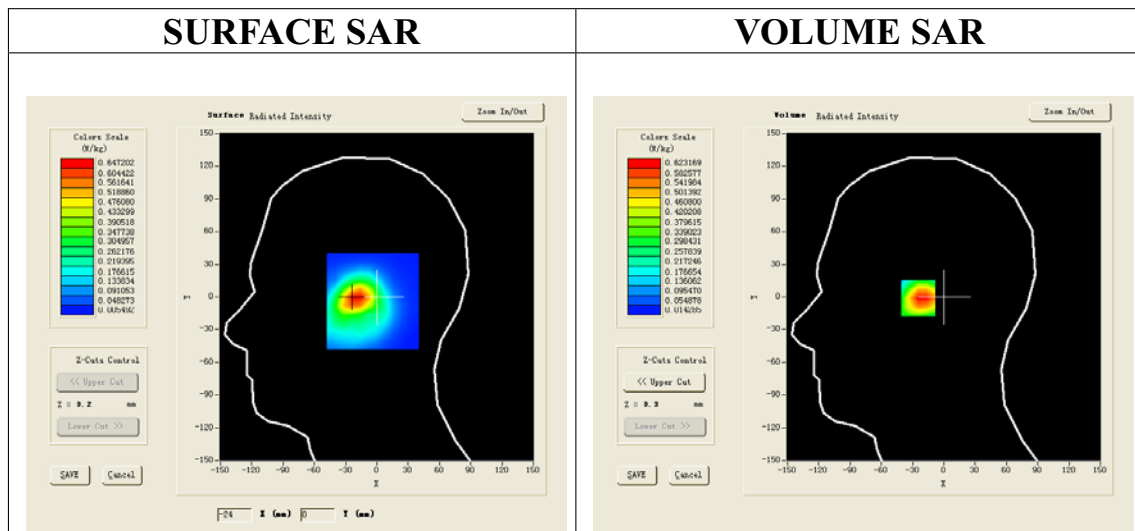

Maximum location: X=-22.00, Y=-1.00

SAR 10g (W/Kg)	0.337117
SAR 1g (W/Kg)	0.593352

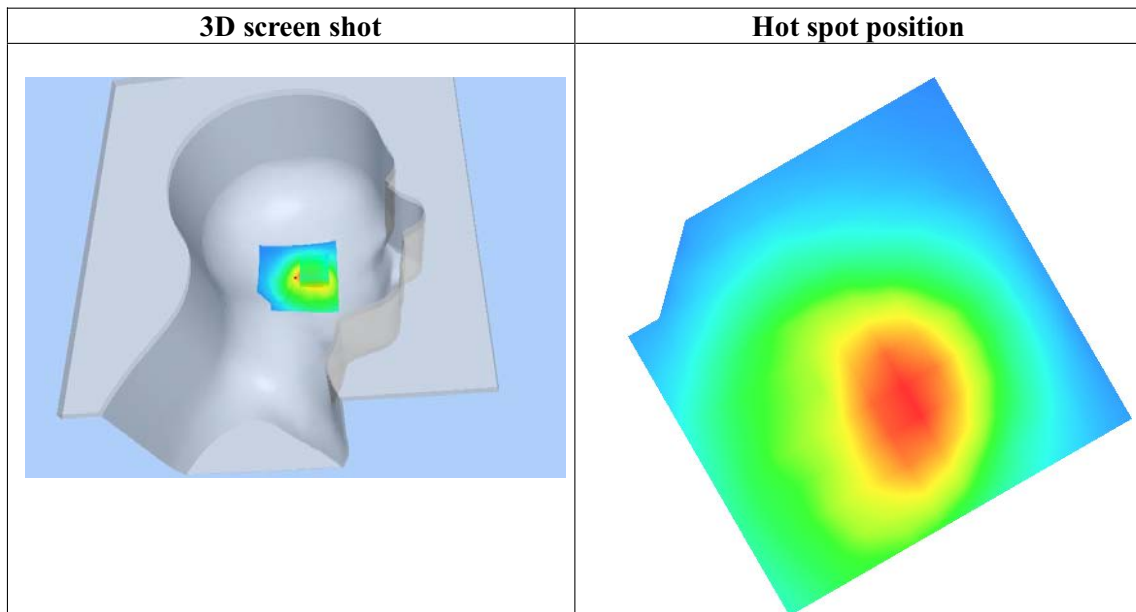
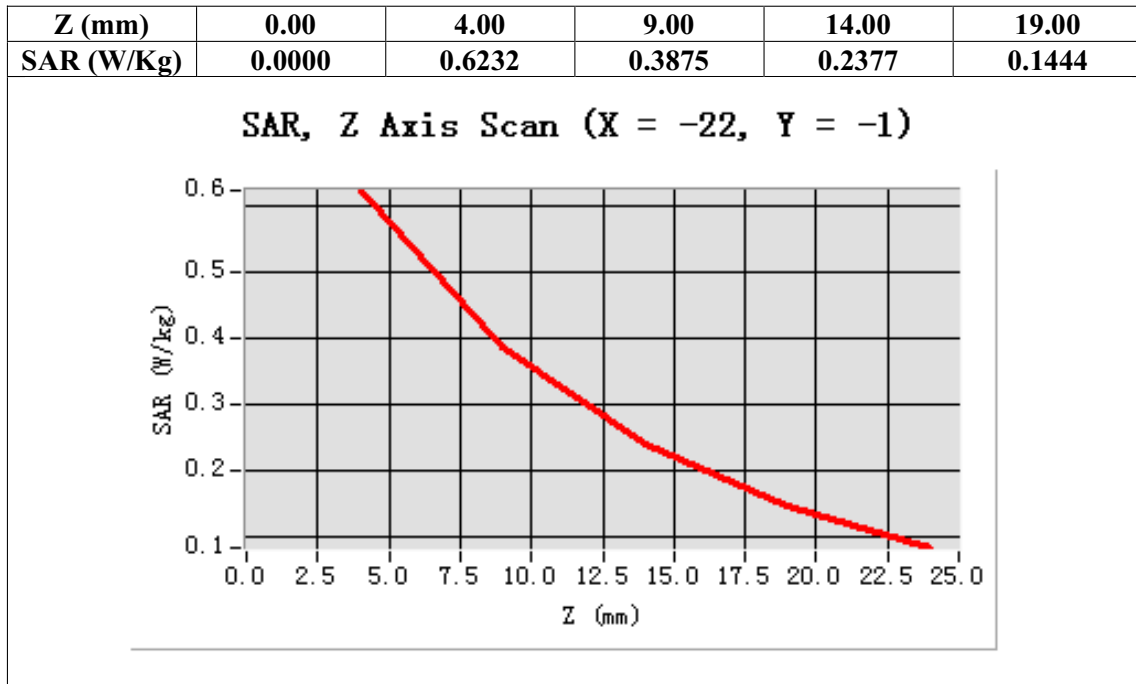

Test Laboratory: AGC Lab
PCS 1900 Mid-Tilt-Right <SIM 1>
DUT: Mobile Phone; Type: GO202

Date: Nov.13, 2013

Communication System: Generic GSM; Communication System Band: PCS 1900; Duty Cycle: 1:8.3; Conv.F=4.72;
Frequency: 1880 MHz; Medium parameters used: $f = 1900$ MHz; $\sigma = 1.38$ mho/m; $\epsilon_r = 41.31$; $\rho = 1000$ kg/m³ ;
Phantom section: Right Section
Ambient temperature (°C): 21.0, Liquid temperature (°C): 21.0

SATIMO Configuration:

Probe: EP165; Calibrated: 01/31/2013

- Sensor-Surface: 4mm (Mechanical Surface Detection)
- Phantom: Flat Phantom; Type: Elliptical Phantom
- Measurement SW: OpenSAR V4_02_01

Configuration/PCS1900 Mid-Tilt-Right/Area Scan: Measurement grid: dx=8mm, dy=8mm

Configuration/PCS1900 Mid-Tilt-Right/Zoom Scan: Measurement grid: dx=8mm, dy=8mm, dz=5mm;

Area Scan	sam_direct_droit2_surf8mm.txt
ZoomScan	5x5x7,dx=8mm dy=8mm dz=5mm,Very fast
Phantom	Right head
Device Position	Tilt
Band	PCS 1900
Channels	Middle
Signal	TDMA (Crest factor: 8.0)

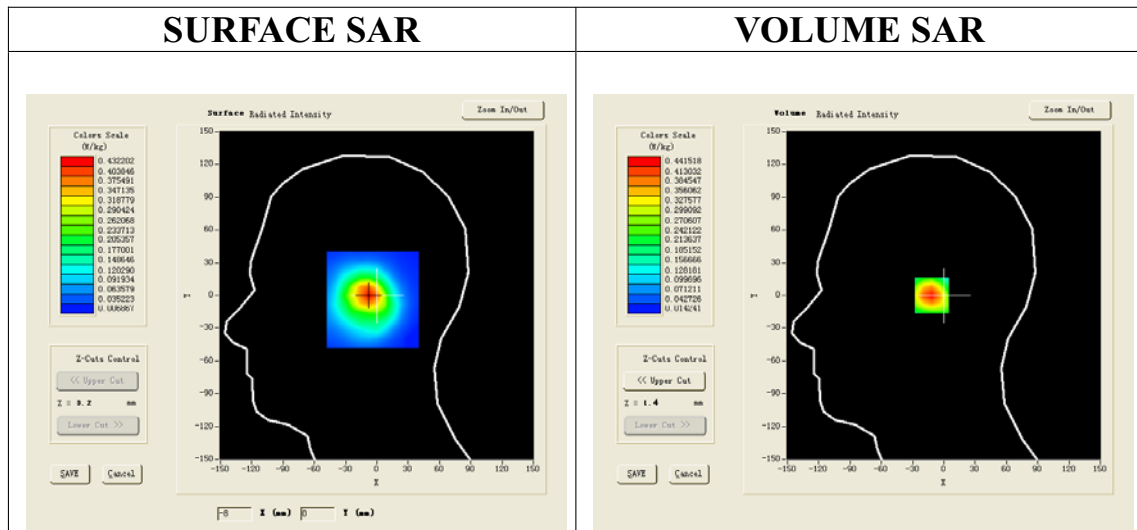

Maximum location: X=-8.00, Y=0.00

SAR 10g (W/Kg)	0.230479
SAR 1g (W/Kg)	0.412165

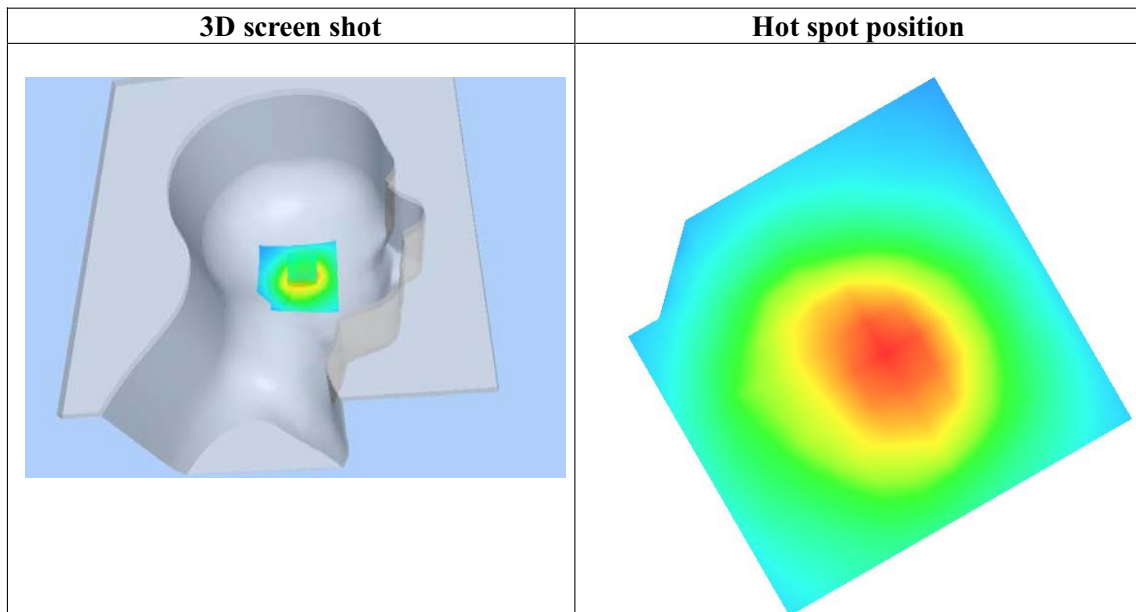
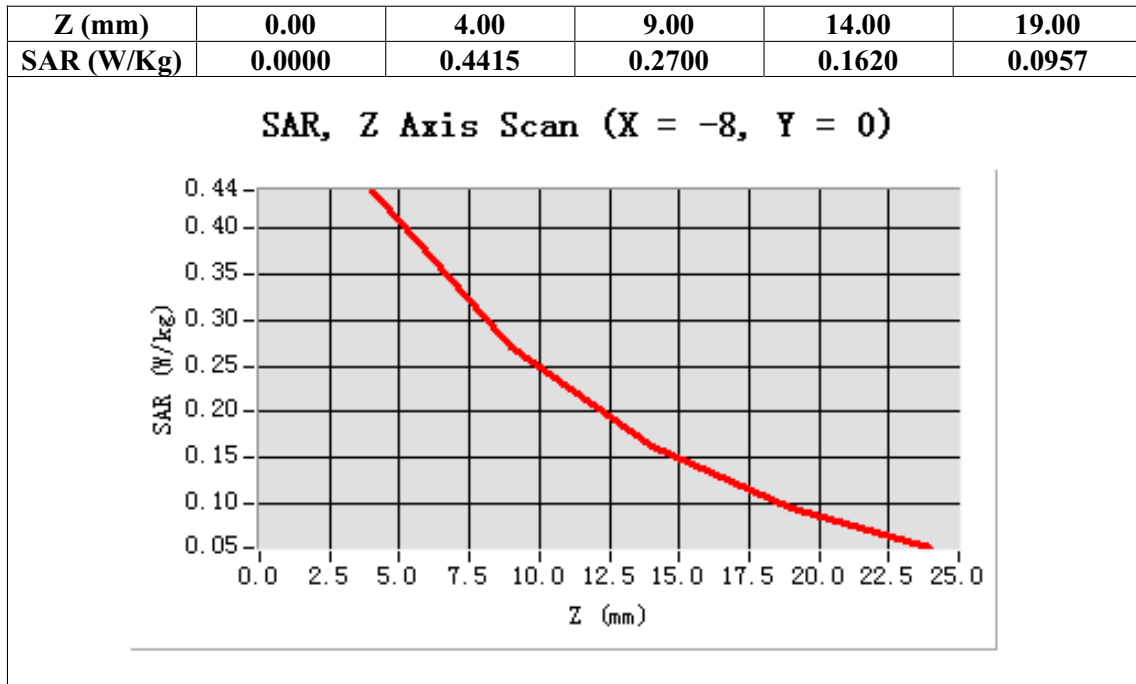

Test Laboratory: AGC Lab
PCS 1900 Mid-Touch-Right <SIM 2>
DUT: Mobile Phone; Type: GO202

Date: Nov.13, 2013

Communication System: Generic GSM; Communication System Band: PCS 1900; Duty Cycle: 1:8.3; Conv.F=4.72;
Frequency: 1880 MHz; Medium parameters used: $f = 1900$ MHz; $\sigma = 1.38$ mho/m; $\epsilon_r = 41.31$; $\rho = 1000$ kg/m³ ;
Phantom section: Right Section
Ambient temperature (°C): 21.0, Liquid temperature (°C): 21.0

SATIMO Configuration:

- Probe: EP165; Calibrated: 01/31/2013
- Sensor-Surface: 4mm (Mechanical Surface Detection)
- Phantom: Flat Phantom; Type: Elliptical Phantom
- Measurement SW: OpenSAR V4_02_01

Configuration/PCS1900 Mid-Touch-Right/Area Scan: Measurement grid: dx=8mm, dy=8mm
Configuration/PCS1900 Mid-Touch-Right/Zoom Scan: Measurement grid: dx=8mm, dy=8mm, dz=5mm;

Area Scan	sam_direct_droit2_surf8mm.txt
ZoomScan	5x5x7,dx=8mm dy=8mm dz=5mm,Very fast
Phantom	Right head
Device Position	Cheek
Band	PCS 1900
Channels	Middle
Signal	TDMA (Crest factor: 8.0)

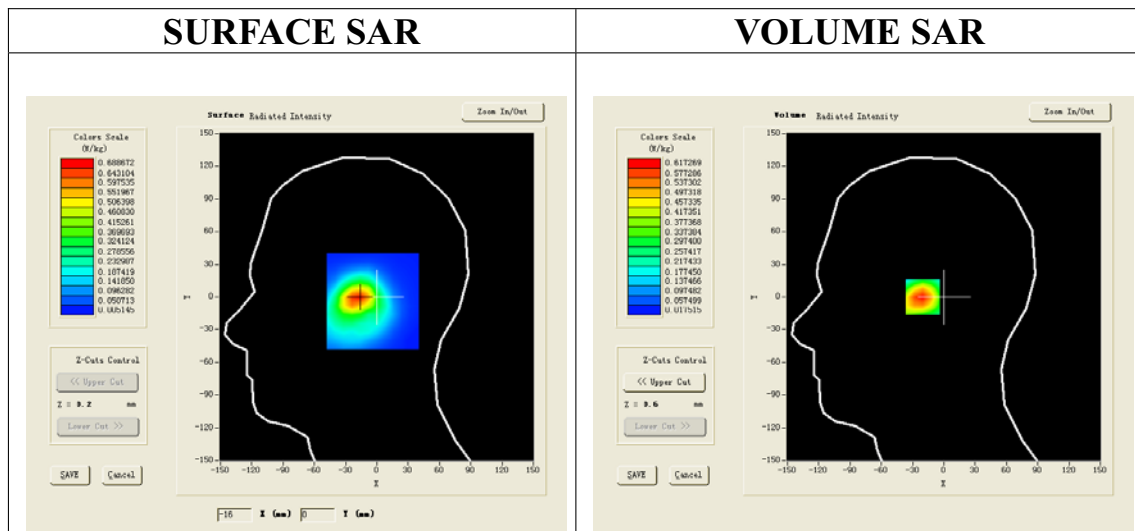

Maximum location: X=-17.00, Y=0.00

SAR 10g (W/Kg)	0.316670
SAR 1g (W/Kg)	0.578498

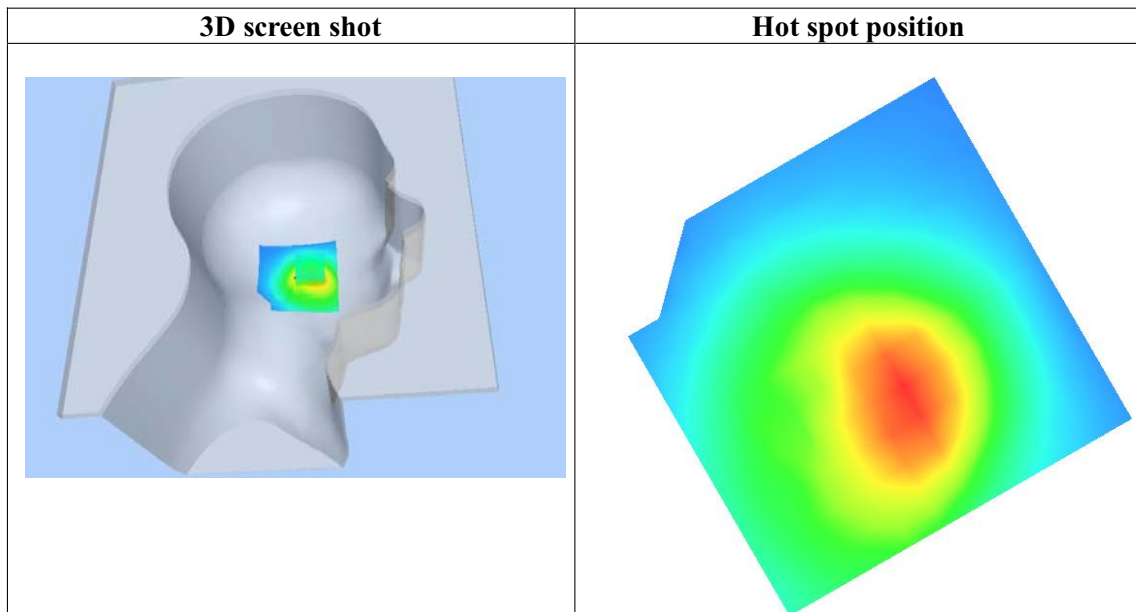
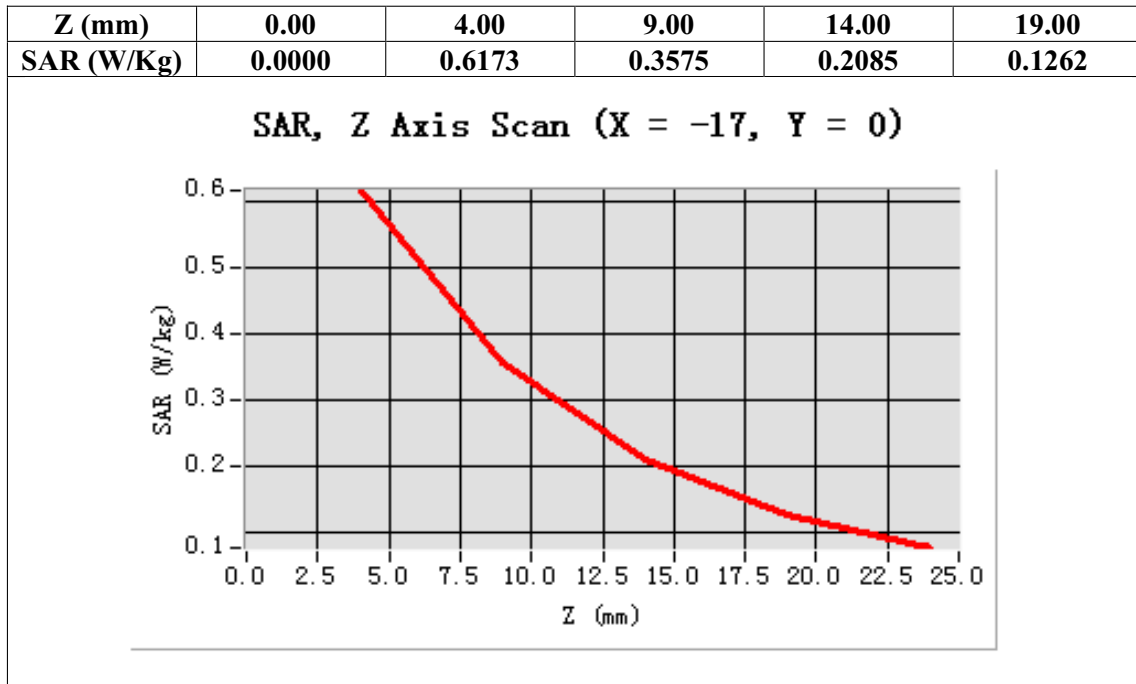

Test Laboratory: AGC Lab
PCS 1900 Mid-Body-Back <SIM 1>
DUT: Mobile Phone; Type: GO202

Date: Nov.13, 2013

Communication System: Generic GSM; Communication System Band: PCS 1900; Duty Cycle: 1:8.3; Conv.F=4.84;
Frequency: 1880 MHz; Medium parameters used: $f = 1900$ MHz; $\sigma = 1.49$ mho/m; $\epsilon_r = 62.64$; $\rho = 1000$ kg/m³ ;
Phantom section: Flat Section
Ambient temperature (°C): 21.0, Liquid temperature (°C): 21.0

SATIMO Configuration:

Probe: EP165; Calibrated: 01/31/2013

- Sensor-Surface: 4mm (Mechanical Surface Detection)
- Phantom: Flat Phantom; Type: Elliptical Phantom
- Measurement SW: OpenSAR V4_02_01

Configuration/PCS1900 Mid-Body-Back/Area Scan: Measurement grid: dx=8mm, dy=8mm

Configuration/PCS1900 Mid-Body-Back/Zoom Scan: Measurement grid: dx=8mm, dy=8mm, dz=5mm;

Area Scan	surf_sam_plan.txt
ZoomScan	5x5x7,dx=8mm dy=8mm dz=5mm,Very fast
Phantom	Validation plane
Device Position	Body Back
Band	PCS 1900
Channels	Middle
Signal	TDMA (Crest factor: 8.0)

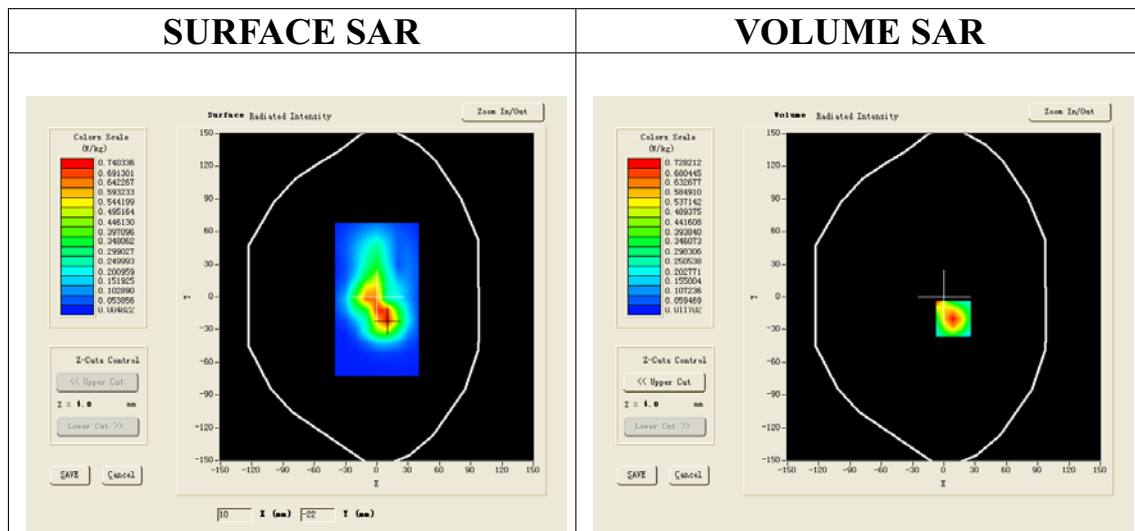

Maximum location: X=9.00, Y=-20.00

SAR 10g (W/Kg)	0.366863
SAR 1g (W/Kg)	0.725492

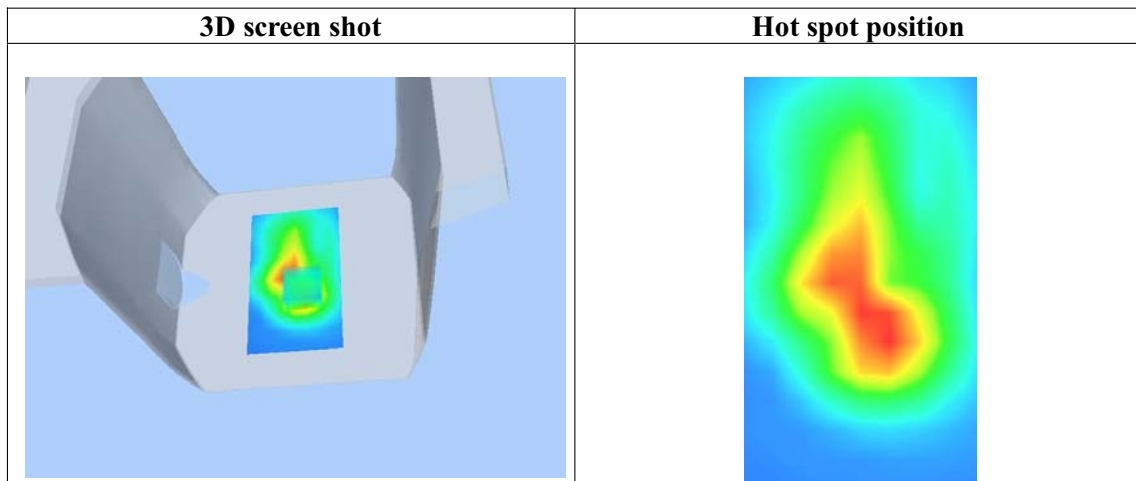
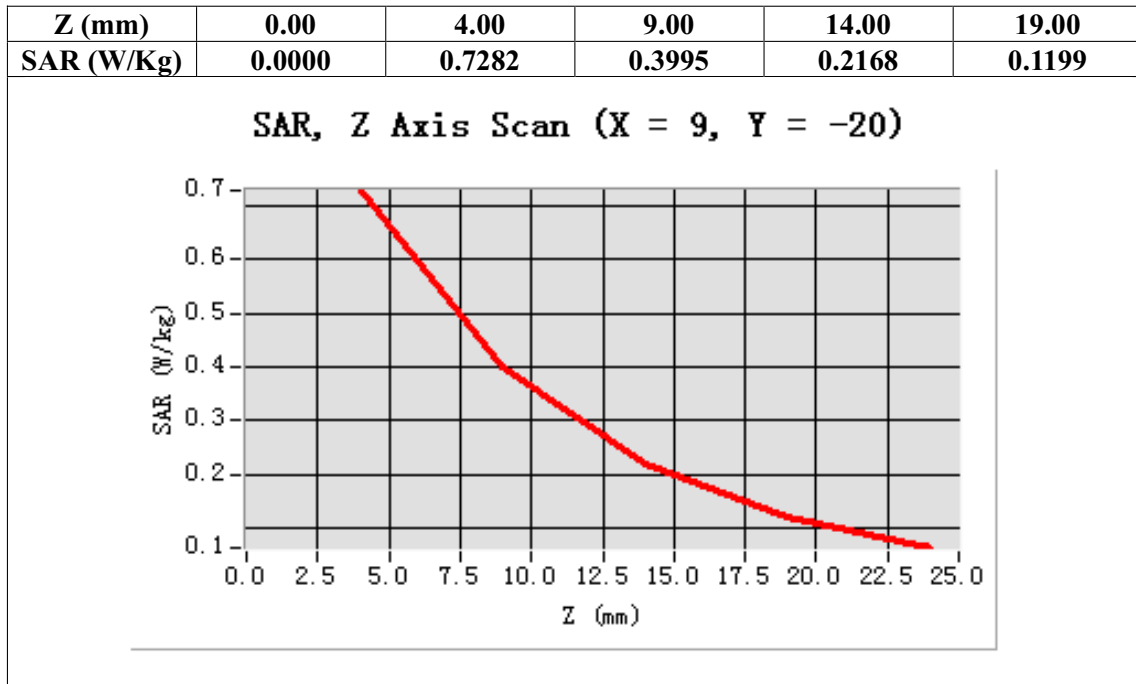

Test Laboratory: AGC Lab
PCS 1900 Mid-Body -Front (MS) <SIM 1>
DUT: Mobile Phone; Type: GO202

Date: Nov.13, 2013

Communication System: Generic GSM; Communication System Band: PCS 1900; Duty Cycle: 1:8.3; Conv.F=4.84;
Frequency: 1880 MHz; Medium parameters used: $f = 1900$ MHz; $\sigma = 1.49$ mho/m; $\epsilon_r = 62.64$; $\rho = 1000$ kg/m³ ;
Phantom section: Flat Section
Ambient temperature (°C): 21.0, Liquid temperature (°C): 21.0

SATIMO Configuration:

- Probe: EP165; Calibrated: 01/31/2013
- Sensor-Surface: 4mm (Mechanical Surface Detection)
- Phantom: Flat Phantom; Type: Elliptical Phantom
- Measurement SW: OpenSAR V4_02_01

Configuration/PCS1900 Mid-Body- Front /Area Scan: Measurement grid: dx=8mm, dy=8mm
Configuration/PCS1900 Mid-Body- Front /Zoom Scan: Measurement grid: dx=8mm, dy=8mm, dz=5mm;

Area Scan	surf_sam_plan.txt
ZoomScan	5x5x7,dx=8mm dy=8mm dz=5mm,Very fast
Phantom	Validation plane
Device Position	Body Front
Band	PCS 1900
Channels	Middle
Signal	TDMA (Crest factor: 8.0)

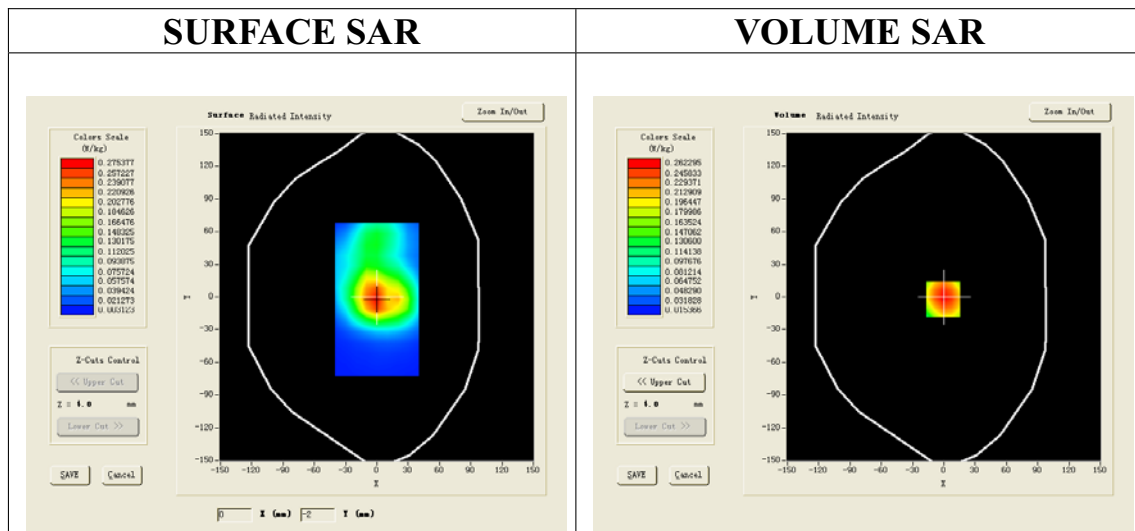

Maximum location: X=-1.00, Y=-2.00

SAR 10g (W/Kg)	0.163674
SAR 1g (W/Kg)	0.270880

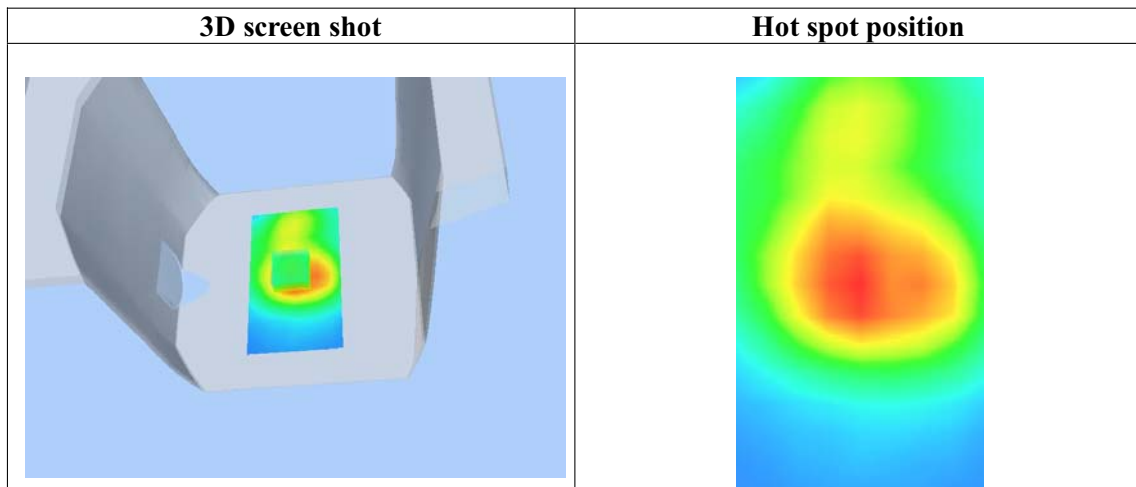
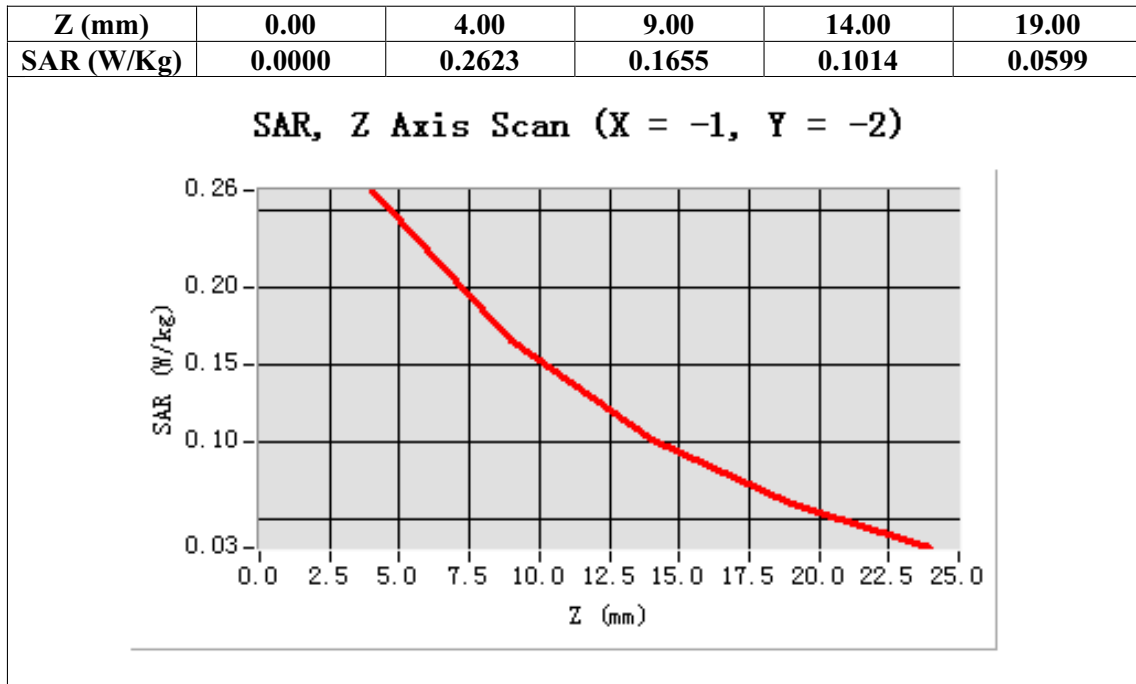

Repeated SAR

Test Laboratory: AGC Lab
GSM 835 Low- Body- Back <SIM 1>
DUT: Mobile Phone; Type: GO202

Date: Nov.13, 2013

Communication System: Generic GSM; Communication System Band: GSM 835; Duty Cycle: 1:8.3; Conv.F=5.46;
Frequency: 824.2 MHz; Medium parameters used: $f = 835$ MHz; $\sigma = 0.95$ mho/m; $\epsilon_r = 53.26$; $\rho = 1000$ kg/m³ ;
Phantom section: Flat Section
Ambient temperature (°C): 21.0, Liquid temperature (°C): 21.0

SATIMO Configuration:

- Probe: EP165; Calibrated: 01/31/2013
- Sensor-Surface: 4mm (Mechanical Surface Detection)
- Phantom: Flat Phantom; Type: Elliptical Phantom
- Measurement SW: OpenSAR V4_02_01

Configuration/GSM 835 Low-Body-Back/Area Scan (6x8x1): Measurement grid: dx=8mm, dy=8mm
Configuration/GSM 835 Low-Body-Back/Zoom Scan (5x5x7)/Cube 0: Measurement grid: dx=8mm, dy=8mm, dz=5mm;

Area Scan	surf_sam_plan.txt
ZoomScan	5x5x7,dx=8mm dy=8mm dz=5mm,Very fast
Phantom	Validation plane
Device Position	Body Back
Band	GSM 835
Channels	Low
Signal	TDMA (Crest factor: 8.0)

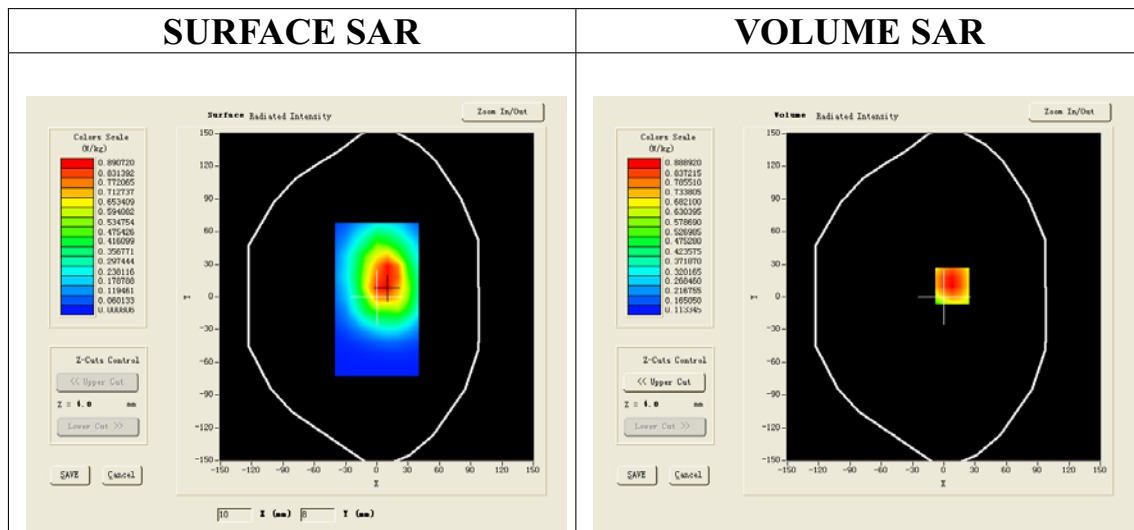

Maximum location: X=8.00, Y=10.00

SAR 10g (W/Kg)	0.613681
SAR 1g (W/Kg)	0.981584

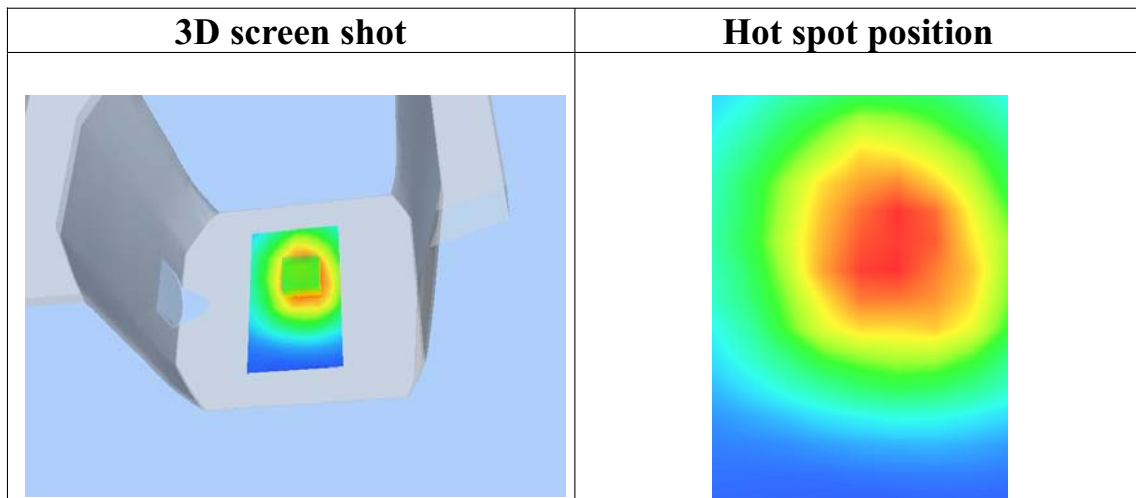
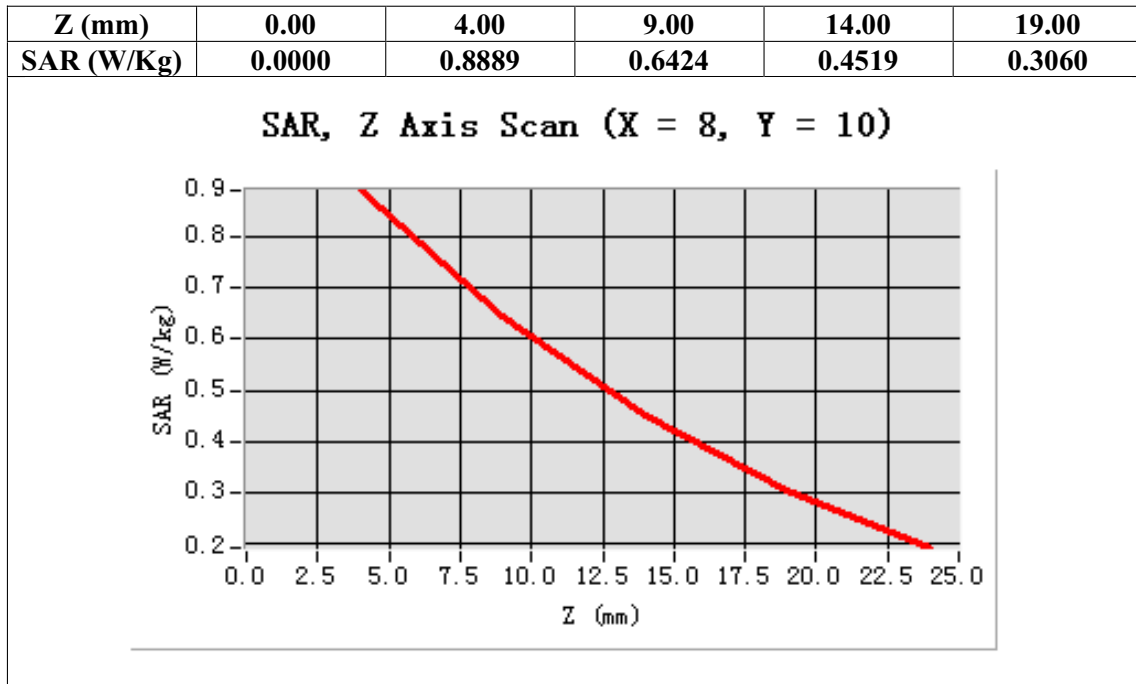

Test Laboratory: AGC Lab
GSM 835 Mid- Body- Back <SIM 1>
DUT: Mobile Phone; Type: GO202

Date: Nov.13, 2013

Communication System: Generic GSM; Communication System Band: GSM 835; Duty Cycle: 1:8.3; Conv.F=5.46;
Frequency: 836.6 MHz; Medium parameters used: $f = 835$ MHz; $\sigma = 0.95$ mho/m; $\epsilon_r = 53.26$; $\rho = 1000$ kg/m³ ;
Phantom section: Flat Section
Ambient temperature (°C): 21.0, Liquid temperature (°C): 21.0

SATIMO Configuration:

Probe: EP165; Calibrated: 01/31/2013

- Sensor-Surface: 4mm (Mechanical Surface Detection)
- Phantom: Flat Phantom; Type: Elliptical Phantom
- Measurement SW: OpenSAR V4_02_01

Configuration/GSM 835 Mid-Body-Back/Area Scan (6x8x1): Measurement grid: dx=8mm, dy=8mm
Configuration/GSM 835 Mid-Body-Back/Zoom Scan (5x5x7)/Cube 0: Measurement grid: dx=8mm, dy=8mm, dz=5mm;

Area Scan	surf_sam_plan.txt
ZoomScan	5x5x7,dx=8mm dy=8mm dz=5mm,Very fast
Phantom	Validation plane
Device Position	Body Back
Band	GSM 835
Channels	Middle
Signal	TDMA (Crest factor: 8.0)

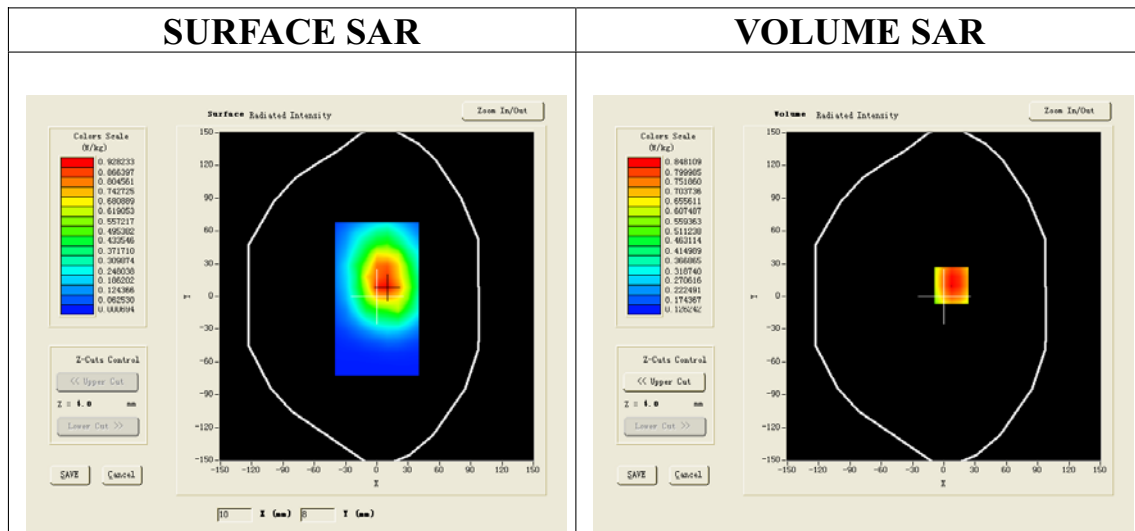

Maximum location: X=7.00, Y=10.00

SAR 10g (W/Kg)	0.626286
SAR 1g (W/Kg)	0.898724

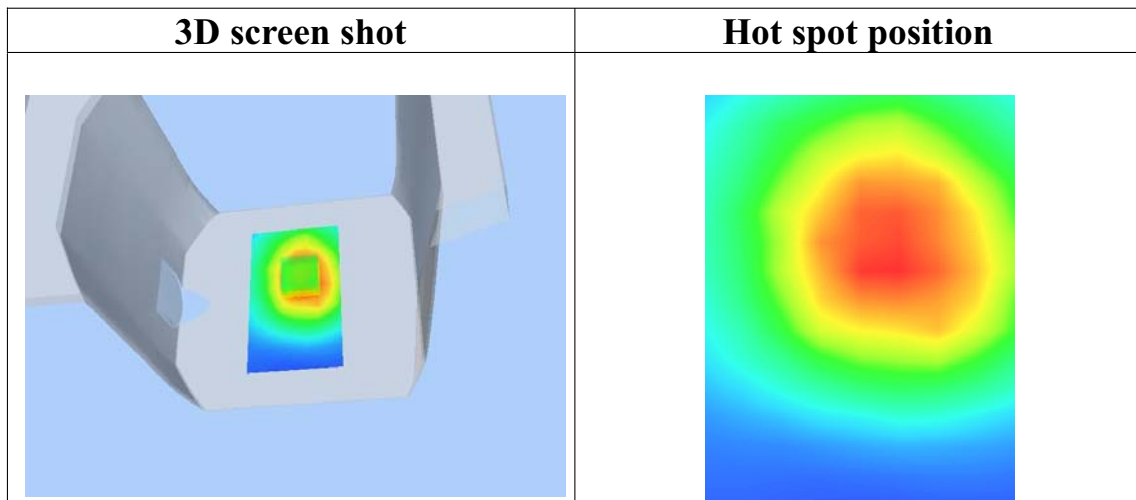
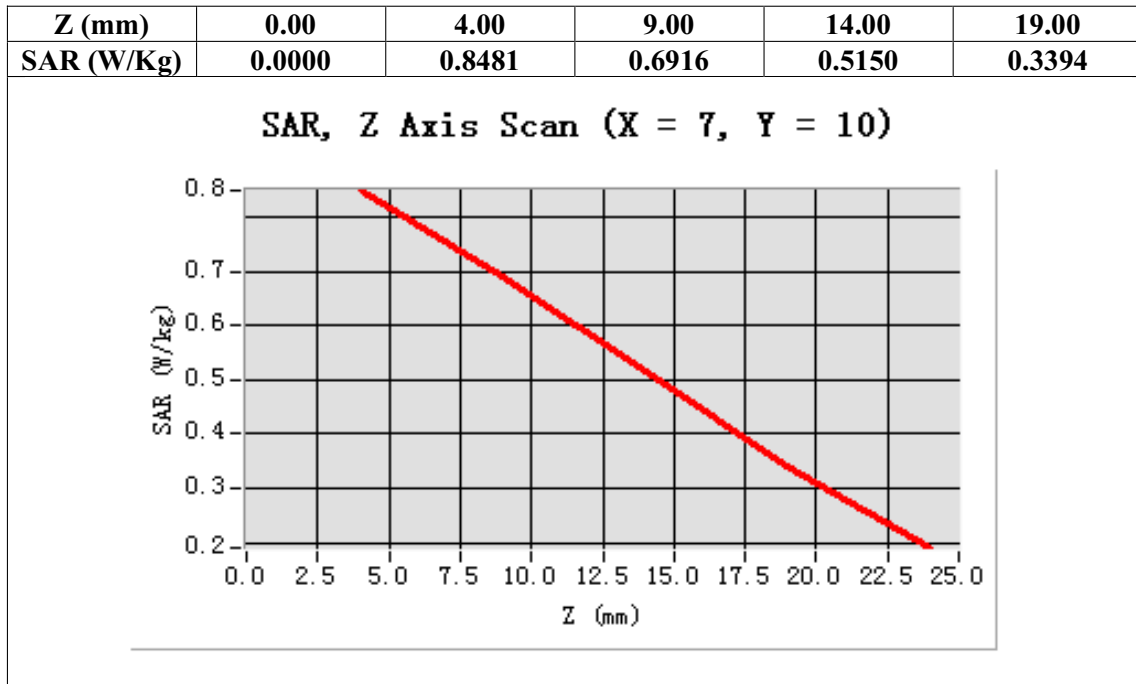

Test Laboratory: AGC Lab
GSM 835 High- Body- Back <SIM 1>
DUT: Mobile Phone; Type: GO202

Date: Nov.13, 2013

Communication System: Generic GSM; Communication System Band: GSM 835; Duty Cycle: 1:8.3; Conv.F=5.46;
Frequency: 848.8 MHz; Medium parameters used: $f = 835$ MHz; $\sigma = 0.95$ mho/m; $\epsilon_r = 53.26$; $\rho = 1000$ kg/m³ ;
Phantom section: Flat Section
Ambient temperature (°C): 21.0, Liquid temperature (°C): 21.0

SATIMO Configuration:

Probe: EP165; Calibrated: 01/31/2013

- Sensor-Surface: 4mm (Mechanical Surface Detection)
- Phantom: Flat Phantom; Type: Elliptical Phantom
- Measurement SW: OpenSAR V4_02_01

Configuration/GSM 835 High-Body-Back/Area Scan (6x8x1): Measurement grid: dx=8mm, dy=8mm
Configuration/GSM 835 High-Body-Back/Zoom Scan (5x5x7)/Cube 0: Measurement grid: dx=8mm, dy=8mm, dz=5mm;

Area Scan	surf_sam_plan.txt
ZoomScan	5x5x7,dx=8mm dy=8mm dz=5mm,Very fast
Phantom	Validation plane
Device Position	Body Back
Band	GSM 835
Channels	High
Signal	TDMA (Crest factor: 8.0)

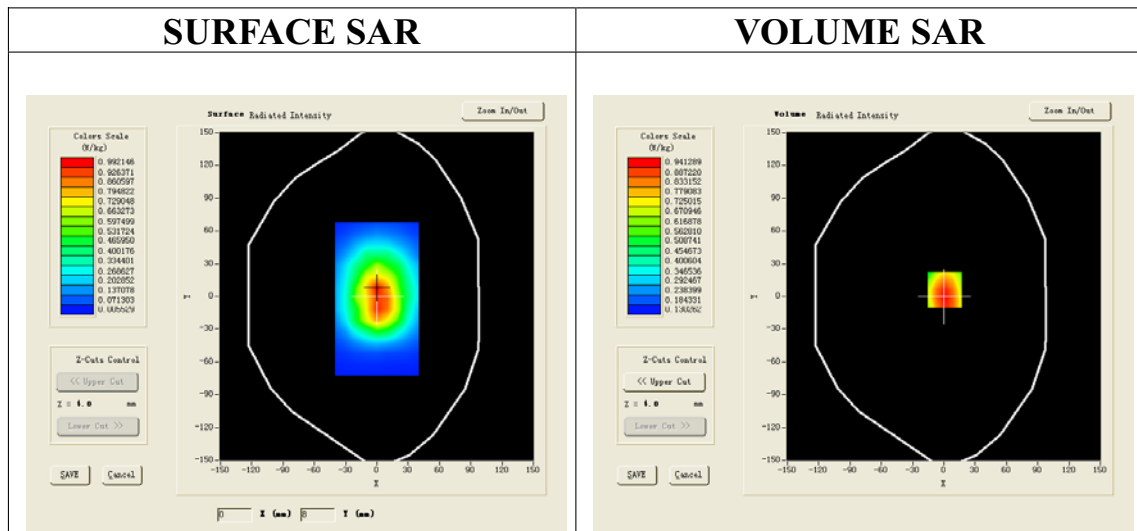

Maximum location: X=1.00, Y=6.00

SAR 10g (W/Kg)	0.657268
SAR 1g (W/Kg)	0.977216

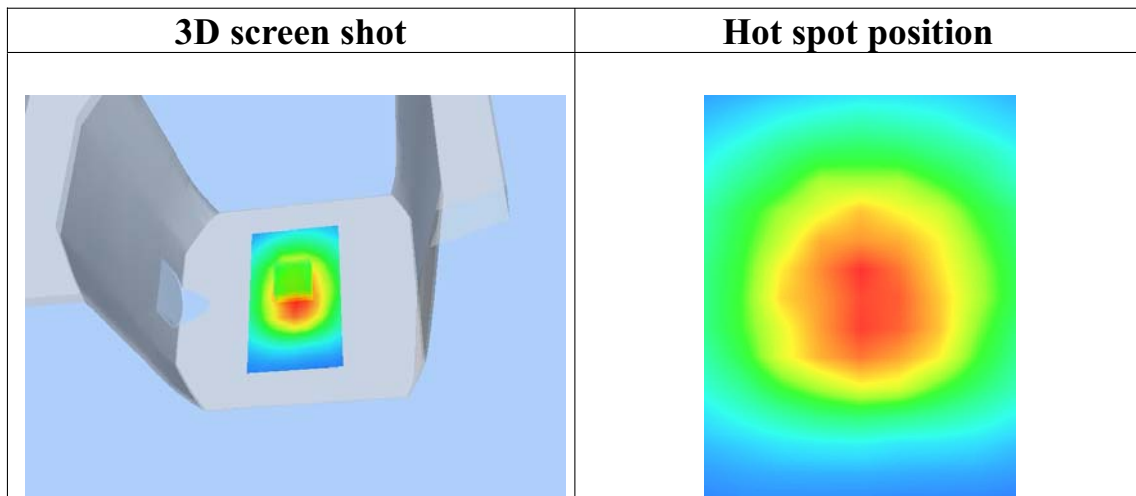
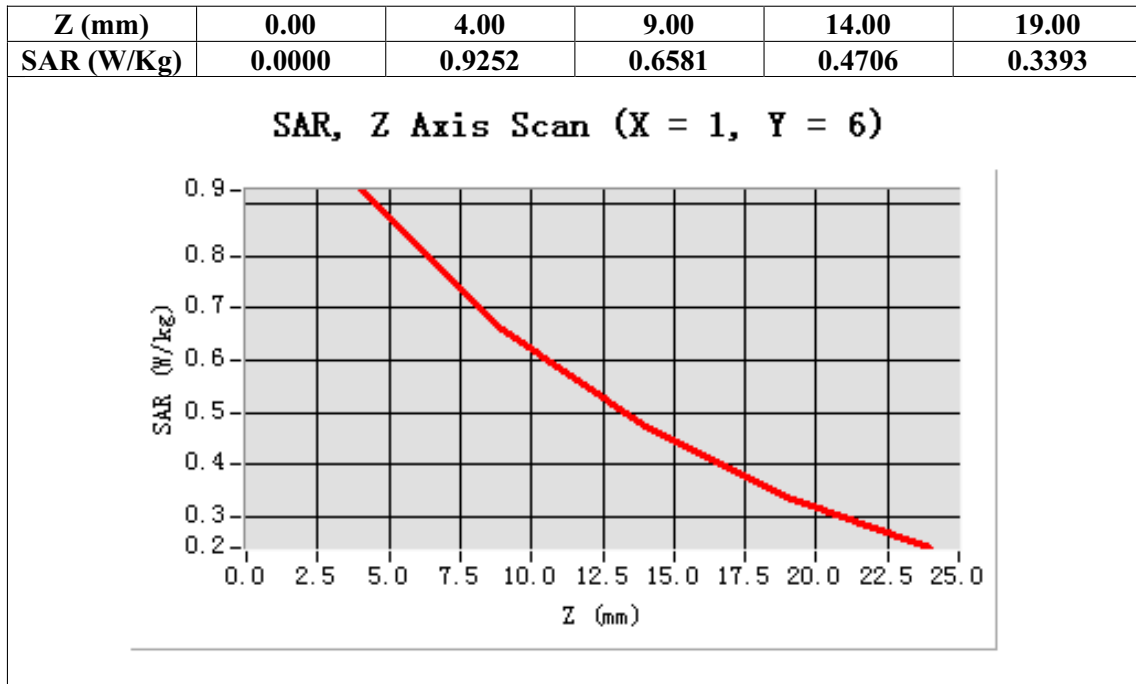

Test Laboratory: AGC Lab
PCS 1900 Mid-Body-Back <SIM 1>
DUT: Mobile Phone; Type: GO202

Date: Nov.13, 2013

Communication System: Generic GSM; Communication System Band: PCS 1900; Duty Cycle: 1:8.3; Conv.F=4.84;
Frequency: 1880 MHz; Medium parameters used: $f = 1900$ MHz; $\sigma = 1.49$ mho/m; $\epsilon_r = 62.64$; $\rho = 1000$ kg/m³ ;
Phantom section: Flat Section
Ambient temperature (°C): 21.0, Liquid temperature (°C): 21.0

SATIMO Configuration:

Probe: EP165; Calibrated: 01/31/2013

- Sensor-Surface: 4mm (Mechanical Surface Detection)
- Phantom: Flat Phantom; Type: Elliptical Phantom
- Measurement SW: OpenSAR V4_02_01

Configuration/PCS1900 Mid-Body-Back/Area Scan: Measurement grid: dx=8mm, dy=8mm

Configuration/PCS1900 Mid-Body-Back/Zoom Scan: Measurement grid: dx=8mm, dy=8mm, dz=5mm;

Area Scan	surf_sam_plan.txt
ZoomScan	5x5x7,dx=8mm dy=8mm dz=5mm,Very fast
Phantom	Validation plane
Device Position	Body Back
Band	PCS 1900
Channels	Middle
Signal	TDMA (Crest factor: 8.0)

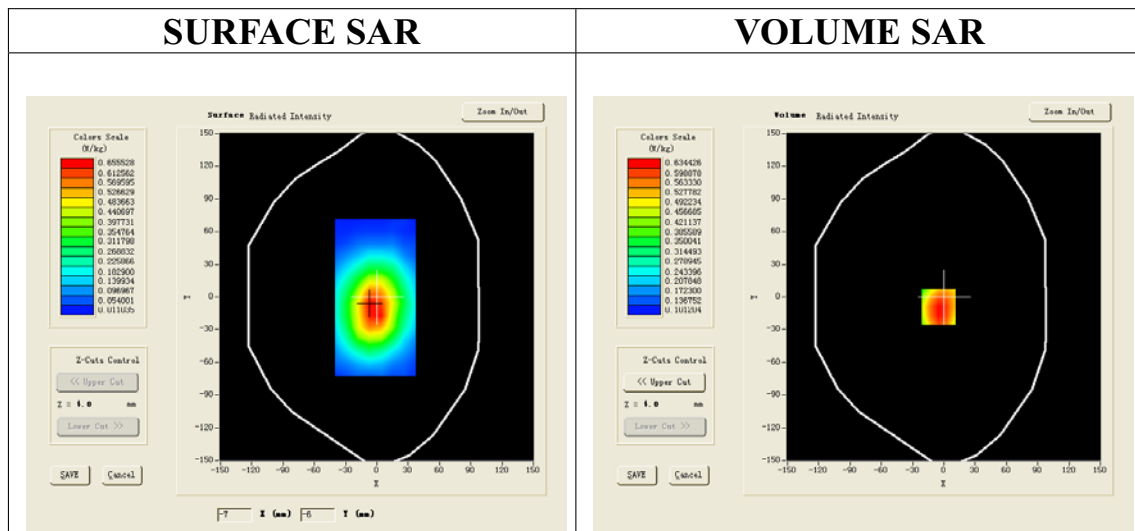

Maximum location: X=-5.00, Y=-9.00

SAR 10g (W/Kg)	0.455418
SAR 1g (W/Kg)	0.693876

