Infotainment System User's Manual

[Style of each level]

**Level 1 : Arial Bold
16**

Level 2 : Arial Bold 14

Level 3 : Arial Bold 12

Level 4 : Arial Bold 10

Main text (Item title) : Arial Bold 9

Main text (Description) : Arial Normal 9

- Notes : Arial Normal 8

1 Infotainment System

Infotainment System [Level 1]

Introduction	1
Radio	18
Audio Players	27
Personalization	42
Phone	48

Introduction [Level 2]

Introduction [Level 3]

General Information [Level 4]

The Infotainment system provides Infotainment in your car, using the latest technology.

The radio can be easily used by registering up to 36 FM or AM radio stations with the PRESET buttons [1~6] per every six pages.

The integrated CD player can play audio CD and MP3 (WMA) discs, and the USB player can play connected USB storage devices or iPod products.

The Bluetooth phone connection function allows for the use of wireless hands-free phone calls, as well as a phone music player.

Connect a portable music player to the exterior sound input to and enjoy the rich sound of the Infotainment system.

The digital sound processor provides a number of preset equalizer modes for sound optimization.

The system can be easily adjusted with the carefully designed adjusting device, smart displayer, and multifunctional menu dial regulator.

- The "Overview" section provides a simple overview of Infotainment system's functions and summary of all regulatory devices.
- The "Operation" section explains the basic controls for the Infotainment system.

Screen Display [Level 4]

[Start-up screen]

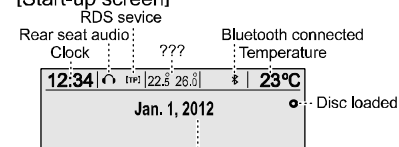

[Radio screen]

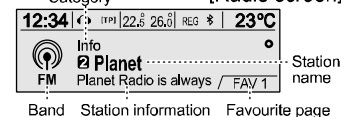

[CD/MP3 screen]

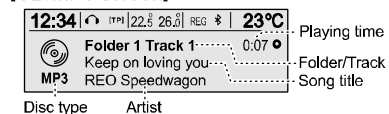

[Settings screen]

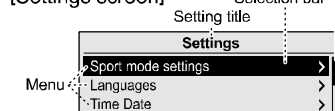

The screen display may differ from the manual display since most screen displays differ according to the device's setup and vehicle specification.

Theft-Deterrent Feature [Level 3]

The Infotainment system has an electronic security system installed to prevent theft.

The Infotainment system only works in the vehicle in which it was first installed, and cannot be used by the people that have stolen it.

3 Infotainment System

FCC Information to User

This equipment has been tested and found to comply with the limits for a Class B digital device, pursuant to Part 15 of the FCC Rules. These limits are designed to provide reasonable protection against harmful interference in a residential installation. This equipment generates, uses and can radiate radio frequency energy and, if not installed and used in accordance with the instructions, may cause harmful interference to radio communications. However, there is no guarantee that interference will not occur in a particular installation. If this equipment does cause harmful interference to radio or television reception, which can be determined by turning the equipment off and on, the user is encouraged to try to correct the interference by one of the following

measures:

- Reorient or relocate the receiving antenna.
- Increase the separation between the equipment and receiver.
- Connect the equipment into an outlet on a circuit different from that to which the receiver is connected.
- Consult the dealer or an experienced radio/TV technician for help.

Caution

Modifications not expressly approved by the party responsible for compliance could void the user's authority to operate the equipment.

FCC Compliance Information : This device complies with Part 15 of the FCC Rules. Operation is subject to the following two conditions: (1) This device may not cause harmful interference, and (2) this device must accept any interference received, including

interference that may cause undesired operation

WARNING:

TO REDUCE THE RISK OF FIRE OR ELECTRIC SHOCK, DO NOT EXPOSE THIS PRODUCT TO RAIN OR MOISTURE.

TO REDUCE THE RISK OF FIRE OR ELECTRIC SHOCK, AND ANNOYING INTERFERENCE, USE ONLY THE INCLUDED COMPONENTS.

CAUTION:

THIS PRODUCT IS A CLASS 1 LASER PRODUCT.

USE OF CONTROLS OR ADJUSTMENTS OR PERFORMANCE OF PROCEDURES OTHER THAN

THOSE SPECIFIED HEREIN MAY RESULT IN HAZARDOUS RADIATION EXPOSURE. DO NOT OPEN COVERS AND DO NOT REPAIR BY YOURSELF. REFER SERVICING TO QUALIFIED PERSONNEL.

When Driving

Keep the volume level low enough to be aware of road and traffic conditions.

When Washing Your Car

Do not expose the product, including the speakers and CDs, to water or excessive moisture. This could cause electrical shorts, fire, or other damage.

When Parked

Parking in direct sunlight can produce

very high temperatures inside your car. Give the interior a chance to cool down before switching the unit on.

Use the Proper Power Supply

This product is designed to operate with a 14 V DC, negative-ground battery system.

Disc Mechanism

Do not insert coins or other small objects.

Keep screwdrivers and other metallic objects away from the disc mechanism and disc.

Use Authorized Service Centres

This product is made of precision parts. Do not attempt to disassemble or adjust any parts. Please refer to the Service Centre list included with this product for service assistance.

For Installation

This product should be installed in a horizontal position with the front end up at a convenient angle, but not more than 30°.

Note:

- The preset memory is cleared to return to the original factory setting when the power connector or battery is disconnected.

5 Infotainment System

Overview [Level 3]

Type 1 [Level 4]

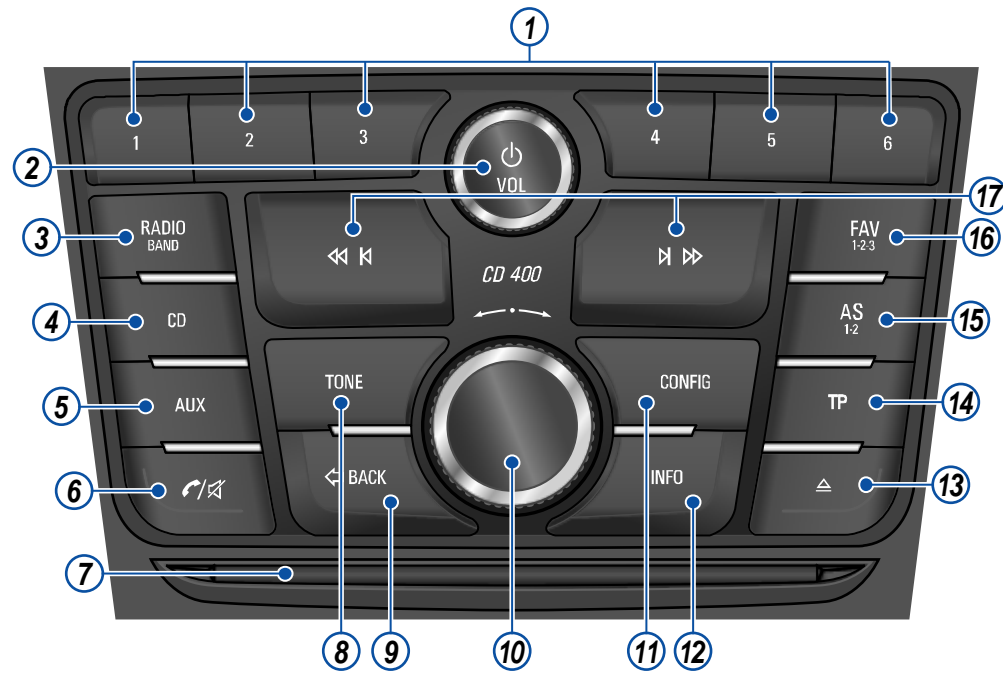

(1) PRESET [1 ~ 6] buttons

- Hold down any these buttons to add the current radio station to the current Favourites page.
- Press any of these buttons to select the channel linked to that button.

(2) POWER button with VOLUME dial

- Turn the power on/off by pressing this button.
- Turn the dial to adjust the overall volume.

(3) RADIO/BAND button

Toggle between FM or AM band radio.

(4) CD button

Press button to select CD/MP3 disc play function.

(5) AUX button

Press button to select AUX/USB/iPod or Bluetooth audio function

(6) PHONE/MUTE button

- Press this button to activate Bluetooth mode.
- Hold down the button to turn the mute function on or off.

(5) Disc slot

This is the slot in which compact disc is inserted or taken out.

(8) TONE button

Press this button to adjust/select the sound setup mode.

(9) ↵BACK button

Cancel input content or return to the previous menu.

(10) MENU button with TUNE dial

- Press this button to display the currently functioning menu or select/practice setup content and setup values.
- Turn the dial to move/change setup content or setup values.
- In the Bluetooth hands-free mode, take a call by pressing the button. You can turn the dial to answer or reject the call, and then press the button to confirm.

(11) CONFIG button

Press this button to enter the system setup menu.

(12) INFO button

- Press this button to view file information when using the CD/MP3/USB/iPod play modes.
- View information about a radio station and the currently playing song when using the radio function.

(13) EJECT button

Press this button and take out the disc.

(14) TP button

While using the FM RDS function, turn the TP (Traffic Programme) function on or off.

(15) AS 1-2 button

- Hold down this button to store the radio stations automatically to the AS-Station page 1/2.
- Press this button to select the AS-Station page 1 or 2.

(16) FAV1-2-3 button

Press this button to select the page of saved favourite channels.

(17) I◀/◀◀SEEK▶▶/▶I buttons

- Press these buttons while using the radio to automatically seek stations with clear reception. You can manually set the broadcasting frequency by holding down these buttons.
- Press these buttons while using the CD/MP3/USB/iPod play modes to instantly play the previous or next track.
- You can hold down these buttons to quickly rewind/forward through the currently playing songs.

7 Infotainment System

Steering wheel audio control Type

1 : option [Level 4]

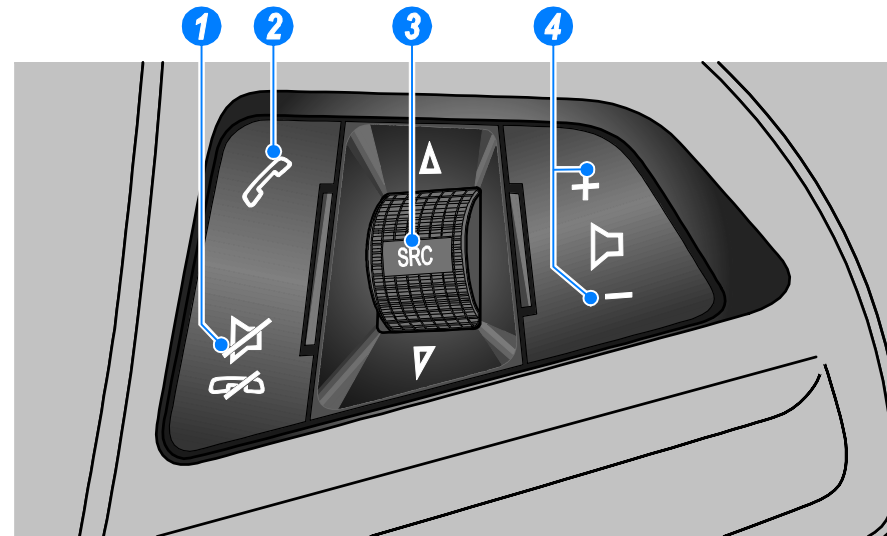

(1) Mute/Hang up button

- Press the button in any music play mode to turn the mute function on and off. In engaged mode, you can press this button to reject calls to finish the call.

(2) Call button

- Press the button to answer the call or enter the re-dial selection mode.
- Hold down the button to enter the dialled call log or to move back and forth from hands-free mode and private call mode during a call.

(3) SRC button with Δ/∇ dial

- Press the button to select a sound play mode.
- Turn the dial to change the registered radio stations or change the music being played.

(4) Volume +/- buttons

- Press the + button to increase the volume.
- Press the - button to decrease the volume.

9 Infotainment System

Steering wheel audio control Type 2 : option [Level 4]

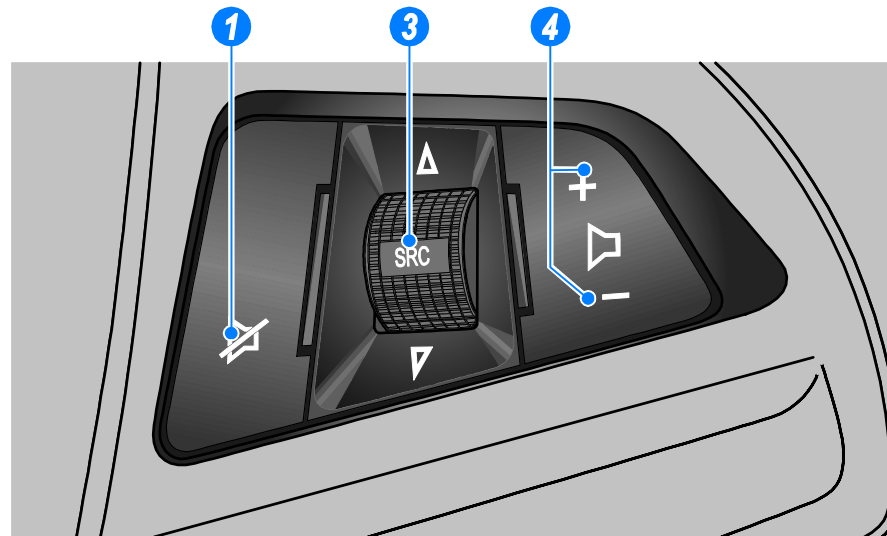

(1) Mute/Hang up button

Press the button to turn the mute function on and off

(3) SRC button with Δ/∇ dial

- Press the button to select a sound play mode.
- Turn the dial to change the registered radio stations or change the music being played.

(4) Volume +/- buttons

- Press the + button to increase the volume.
- Press the - button to decrease the volume.

11 Infotainment System

Operation [Level 3]

Buttons and controlling device [Level 4]

The Infotainment system is operated by using the function buttons, multifunctional dial, and the menu indicated on the screen display.

The buttons and control devices used in the system are as follows.

- The Infotainment system buttons and dial
- Steering wheel remote control buttons

System on/off [Level 4]

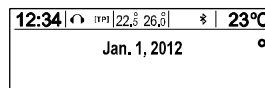

Press the **POWER** button to turn the power on.

- Once the power is turned on, the previously used function will be executed after the time, date, temperature, and the function are ready.

Press the **POWER** button to turn the power off.

Turning off automatically [Level 4]

When the ignition switch (car ignition key) is in the off position, turning on the Infotainment system by using the **POWER** button will automatically turn the Infotainment system off after ten minutes from the user's last operation.

Volume control [Level 4]

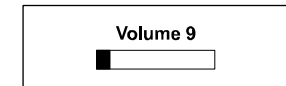

Turn the **VOLUME** dial to adjust the volume.

- Using the steering wheel remote control, press the **VOLUME +/-** buttons to adjust the volume.
- The current sound volume is indicated.
- Turning on the Infotainment system power will set the volume level to its previous selection (when it is less than the maximum starting volume)
- When turning the power on, the maximum starting volume value can be separately set (when the previous volume level is less than the maximum starting volume).

Auto volume control [Level 4]

Once the speed-compensating sound volume setup starts operating, the volume will automatically be controlled according to the vehicle's speed to offset the noise from the engine and tires. (Refer to Settings → Radio settings → Auto volume control)

Volume limit by high temperature [Level 4]

If the inside temperature of the radio is very high, the Infotainment system will limit the controllable maximum volume. If necessary, the volume will automatically decrease.

Tone settings [Level 4]

From tone setup menu, sound features can be setup differently according to the FM/AM/DAB tuner and each audio player's functions.

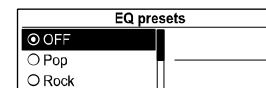
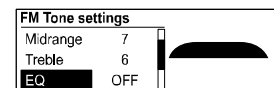
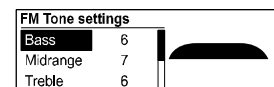

Press the **TONE** button when using the relevant functioning mode.

Turn the **TUNE** dial to select desired tone control mode, and then press the **MENU** button.

Turn the **TUNE** dial to select the desired tone control value, and then press the **MENU** button.

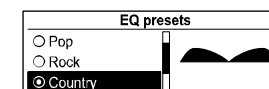
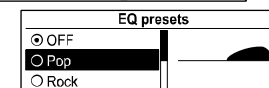
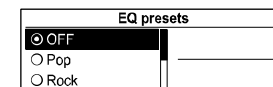

Tone setting menu

- Bass: Adjust the bass level from -12 to +12.
- Midrange: Adjust the midrange level from -12 to +12.
- Treble: Adjust the treble level from -12 to +12.
- EQ (Equalizer): Select or turn off the sound style (OFF ↔Pop ↔Rock ↔Country ↔Talk ↔Classical)
- Fader: Adjust the front/rear speaker balance from front 15 to rear 15 in the six speaker system model.
- Balance: Adjust the left/right speaker balance from left 15 to right 15.

13 Infotainment System

Select function

FM /DAB/AM radio

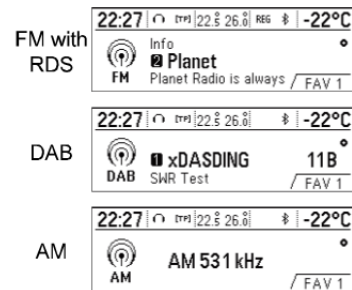

Press the **RADIO/BAND** button to select FM, AM or DAB radio.

- Press the **MENU** button to open the FM/AM/DAB menu that includes options for selecting broadcast stations.

CD/MP3 disc player

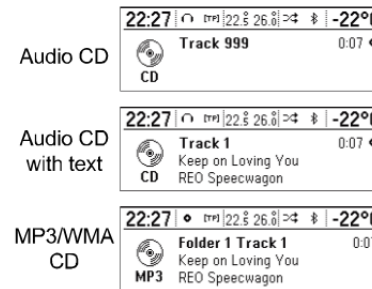

Insert an Audio CD or MP3/WMA disc to be played with printed surfacing upward in the disc slot.

When a disc is already inserted, press the **CD** button to select CD/MP3 player.

- From the steering wheel remote control, press **SRC** button to select the CD/MP3 player.

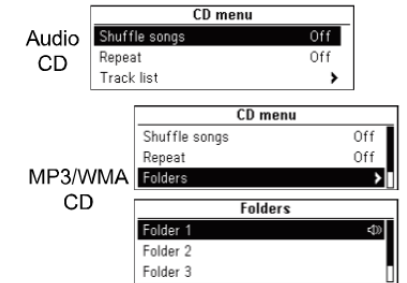

- Press the **MENU** button to open the menu with options for the relevant function or the menu of the relevant device.

• **USB/iPod/Bluetooth audio play or exterior sound (AUX) input**

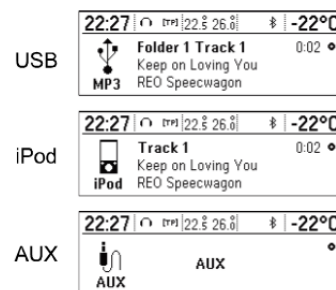

Connect the USB/ iPod with music files to be played to the USB connecting terminal. Or connect the audio output of the external audio equipment to be listened to AUX input terminal.

When the USB, iPod or AUX device are already inserted, repeatedly press the **AUX** button to select the desired function. (AUX → USB or iPod → Bluetooth audio → AUX →....)

- From the steering wheel remote control, press **SRC** button to select the desired mode.

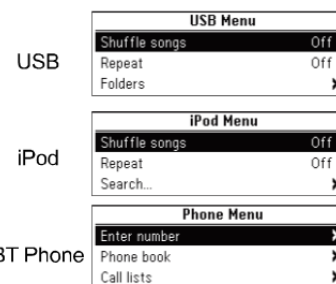

- Press the **MENU** button to open the menu with options for the relevant function or the menu of the relevant device.

Bluetooth hands-free phone device

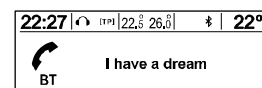

Press the **PHONE/MUTE** button to select the Bluetooth hands-free phone function.

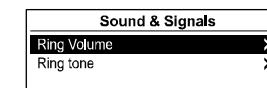
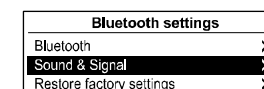
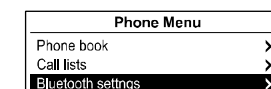

- Press the **MENU** button to open the Bluetooth with options for the relevant function.

15 Infotainment System

Radio [Level 2]

FM/DAB/AM Radio [Level 3]

Before using AM-FM Radio [Level 4]

Main buttons/dial

(3) RADIO/BAND button

Toggle between FM, DAB or AM band radio.

(10) MENU button with TUNE dial

- Turn this dial to manually find a broadcasting frequency.
- Press this button to access the menu screen from the current mode.

(9) ↵BACK button

Cancel the input item or return to the previous screen/menu.

(17) I◀/◀◀SEEK▶▶/▶I buttons

- Press this button to automatically search for available radio stations.
- Hold down this button to change the radio frequency as desired, and then let the button go to stop at the current frequency.

(16) FAV1-2-3 button

Press this button to move through the pages of saved favourite radio stations.

(1) PRESET [1 ~ 6] buttons

- Hold down any of these PRESET buttons to register the current radio station to that button.
- Press this button to select the station registered to the PRESET button.
-

(15) AS 1-2 button

- Hold down this button to store the radio stations automatically to the AS-Station page 1/2.
- Press this button to select the AS-Station page 1 or 2.

(14) TP button

While using the FM RDS function, turn the TP (Traffic Programme) function on or off.

(12) INFO button

View the information for broadcast radio stations.

Listening to radio station [Level 4]

Radio band selecting

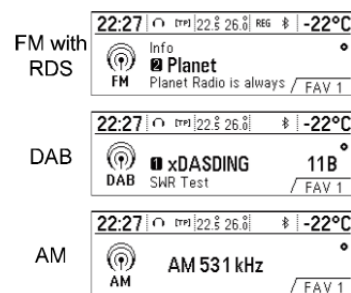

Repeatedly press the **RADIO/BAND** button to toggle between FM, DAB or AM broadcasting

- The previously chosen broadcasting station will be received.

Automatic station search

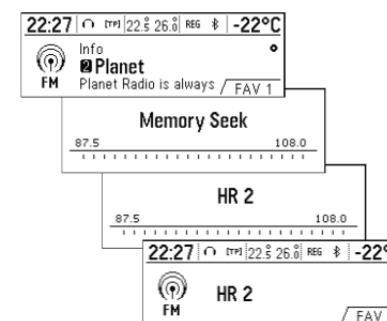

Press the **SEEK** buttons to automatically search for available radio stations with good reception.

Seeking

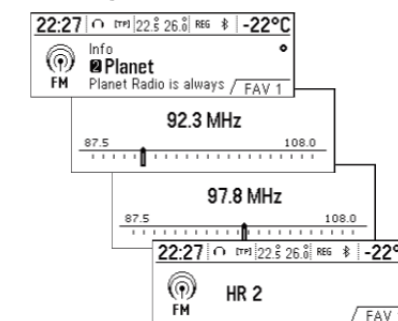

Hold down the **SEEK** buttons to quickly change the frequency, and then release the button at the desired frequency.

17 Infotainment System

Searching for broadcasting manually

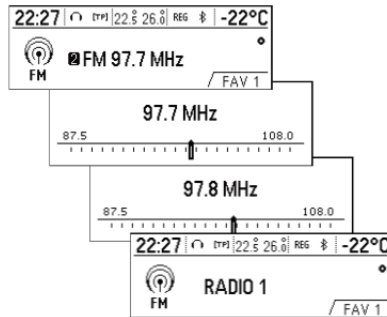

Turn the **TUNE** dial to manually find the desired broadcasting frequency.

Using the PRESET buttons [Level 4]

Registering PRESET button

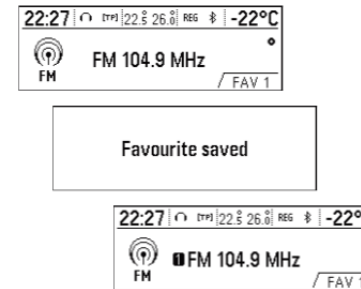

Press the **FAV1-2-3** button to select the desired page of saved favourites.

Hold down any of **PRESET [1 ~ 6]** buttons to register the current radio station to that button of the selected Favourites page.

- Up to Favourites pages can be saved, and each page can store up to six radio stations.
- It is possible to setup the number of the Favourites pages being used in "System setup → Radio Setup → Radio favourites (Max. number of favourite page)".
- If a new radio station is registered to a **PRESET [1 ~ 6]** previously registered button, its previous content will be deleted

and be replaced with the new radio station that is saved.

Listening to PRESET button directly

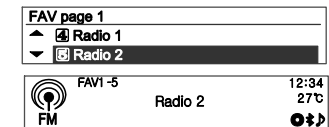

Repeatedly press the **FAV1-2-3** button to select the desired FAV (Favourites) preset page.

- The number 1 broadcasting information of the selected FAV (Favourites) preset page will be displayed.

Press a **PRESET [1 ~ 6]** buttons to directly listen to the radio station saved to that button.

Using the FM/DAB/AM radio menu

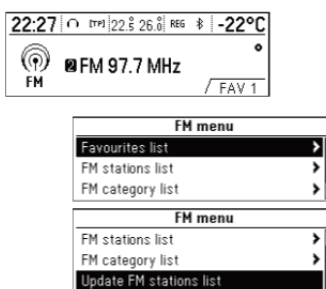

Press the **MENU** button to display the FM/DAB/AM radio menu.

Turn the **TUNE** dial to move to the desired menu item, and then press **MENU** button to select the relevant item or to display the item's detailed menu.

FM/DAB/AM menu → FM/DAB/AM Favourites list

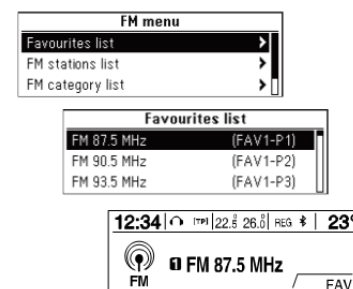

From FM/DAB/AM menu item, turn the **TUNE** dial to move to the Favourites list, and then press **MENU** button.

- The Favourites list information will be displayed.

Turn the **TUNE** dial to move to the desired Favourites list, and then press **MENU** button to receive relevant broadcasting channel.

FM/AM menu → FM/AM station list

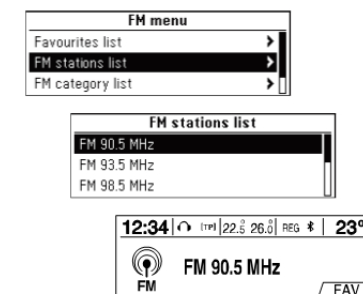

From the FM/AM menu, turn the **TUNE** dial to move to the FM/AM stations list, and then press the **MENU** button.

- The Station list information will be displayed.

Turn the **TUNE** dial to move to the desired list, and then press the **MENU** button to receive the relevant broadcasting channel.

19 Infotainment System

DAB menu → DAB manual tuning

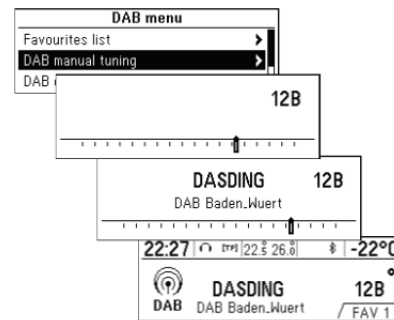

From the DAB menu, turn the **TUNE** dial to move to the DAB manual tuning, and then press the **MENU** button.

Turn the **TUNE** dial to move to the desired station, and then press the **MENU** button to receive the relevant broadcasting.

FM/DAB menu → FM/DAB category list

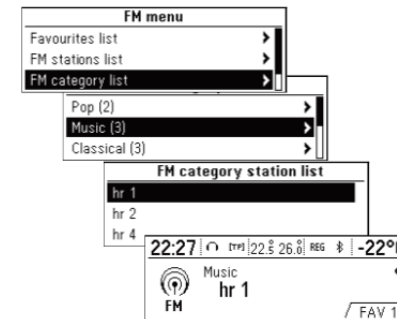

From the FM/DAB menu, turn the **TUNE** dial to move to the FM/DAB category list, and then press the **MENU** button.

- The FM/DAB category list will be displayed. Turn the **TUNE** dial to move to the desired list, and then press the **MENU** button to receive the relevant broadcasting frequency.

FM/DAB/AM menu → Update FM/DAB/AM stations list

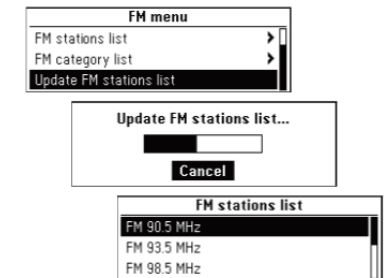

From the FM/DAB/AM menu, turn the **TUNE** dial and move to the Update FM/DAB/AM stations list, and then press **MENU** button.

- The FM/DAB/AM broadcasting list update will proceed.
- During the FM/DAB/AM broadcasting list update, press the **MENU** button or the previous **BACK** button to stop it from saving changes.

RDS (Radio Data System) [Level 3]

- The Radio Data System (RDS) is a service by FM stations that considerably makes it easier to find radio stations with fault-free reception.



- RDS stations are indicated by the programme name instead of the broadcasting frequency.

View RDS broadcasting information [Level 4]

While receiving RDS broadcasting, press the **INFO** button to check RDS broadcasting information that is being received.

Configuring RDS [Level 4]

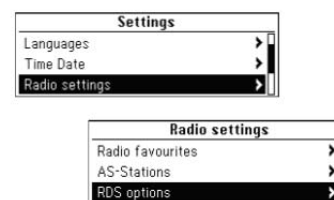

Press the **CONFIG** button to enter the Setting menu.

Turn the **TUNE** dial to move to the Radio settings, and then press the **MENU** button.

Turn the **TUNE** dial to move to RDS options, and then press the **MENU** button.

Switching RDS on and off [Level 4]

Set the option RDS to On or Off.

The following advantages result through activating RDS:

- On the display the programme name of the set station appears instead of its frequency.
- The Infotainment system always tunes into the best receivable broadcasting frequency of the set station by means of AF. (Alternative Frequency)

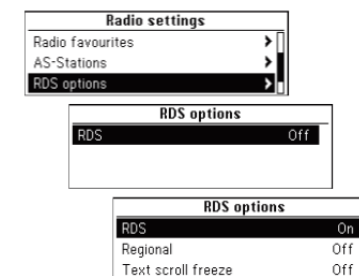

From Settings → Radio settings → RDS options menu, turn the **TUNE** dial to move to RDS: Off, and then press the **MENU** button to turn on the RDS function.

21 Infotainment System

Switching regionalization on and off [Level 4]

RDS must be activated for regionalization.

At certain times some RDS stations broadcast regionally different programmes on different frequencies.

Set the option Regional (REG) to On or Off.

Only alternative frequencies (AF) with the same regional programmes are selected.

If regionalization is switched off, alternative frequencies of the stations are selected without regard to regional programmes.

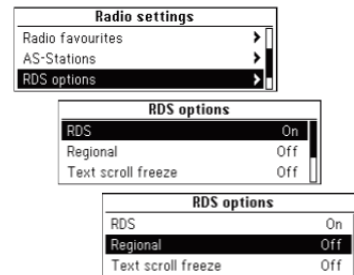

From Settings → Radio settings → RDS options menu, turn the **TUNE** dial to move to Regional: Off, and then press the **MENU** button to turn on the Regional function.

Switching the Text scroll freeze on and off [Level 4]

To switch the text scroll freeze function (for displaying the information of programme service) on or off.

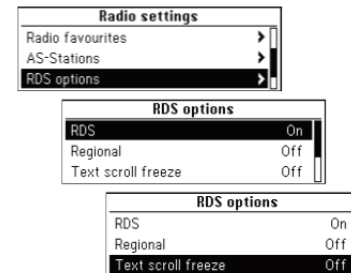

From Settings → Radio settings → RDS options menu, turn the **TUNE** dial to move to Text scroll freeze: Off, and then press the **MENU** button to turn on the Text scroll freeze function.

Switching the Radio text function on and off [Level 4]

To switch the radio text function (for displaying the information of programme service) on or off.

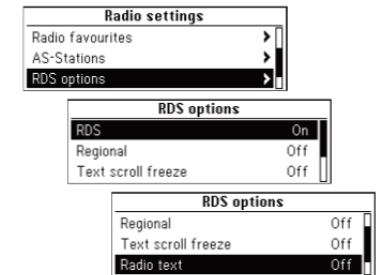

From Settings → Radio settings → RDS options menu, turn the **TUNE** dial to move to Radio text : Off, and then press the **MENU** button to turn on the Radio text function.

Volume of the traffic announcements (TA) [Level 4]

The minimum volume of the traffic announcements (TA) can be preset.

The minimum volume of the traffic announcements can be increased or reduced in comparison to the normal audio volume.

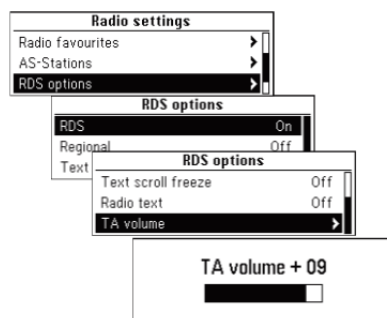

From the RDS settings menu, turn the **TUNE** dial to move to TA volume, and then press the **MENU** button.

Turn the **TUNE dial** to adjust the TA volume level, and then press the **MENU** button.

Radio traffic service [Level 4]

(TP = Traffic Programme)

Radio traffic service stations are RDS stations that broadcast traffic news.

Switching the Traffic Announcement Standby Facility of the Infotainment System On and Off:

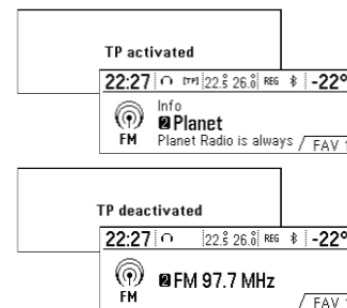

Outside of Phone mode, press the **TP** button to turn the Traffic programme service function on or off.

- If the radio traffic service is switched on, then [] is displayed in the radio main menu.

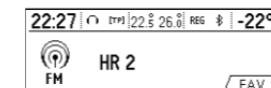
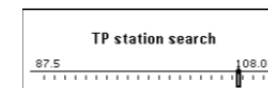
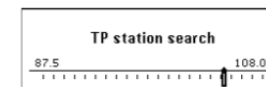

- If the current station is not a radio traffic service station, then a search is automatically started for the next radio traffic service station.
- Once a radio traffic service station has been found, [TP] is displayed in the radio main menu.
- If the radio traffic service is switched on, then CD/MP3/USB/iPod/Bluetooth music or AUX replay is interrupted for the duration of the traffic announcement.

23 Infotainment System

Blocking out Traffic Announcements [Level 4]

To block out a traffic announcement, e.g. during CD/MP3 replay or radio reception:

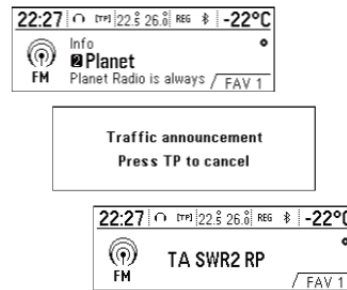

Outside of Phone mode, press the **TP** button.

Switch on the radio traffic service and fully turn down the volume of the Infotainment system.

- The traffic announcement is aborted, but the radio traffic service remains switched on.

Blocking out current Traffic Announcements [Level 4]

To block out a current traffic announcement e.g. during TA radio reception:

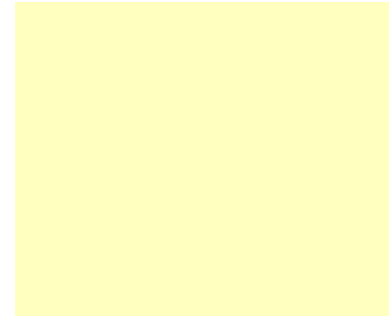

Outside of Phone mode, press the **TP** button.

Audio Players [Level 2]

CD Player [Level 3]

The CD/MP3 player of this system can play audio CD and MP3 (WMA) disc.

Before using CD player [Level 4]

Important information about audio CD and MP3(WMA) disc

CAUTION

In any case, do not insert any DVDs, mini discs with a diameter of 8cm, or discs with abnormal surfaces in this CD/MP3 (WMA) player.

Do not put any stickers on the disc surface. Such discs may be stuck in the CD player and damage the drive device. If this occurs, then the device will need to be replaced at high cost.

- An audio CD disc with an anti-piracy function with no compatibility with the audio CD standard may not work properly or at all.
- CD-R and CD-RW discs that are manually recorded are easier to be handled with carelessness than the original CD discs. Manually recorded CD-R and CD-RW discs should especially be handled with care. Please refer to the following.
- Manually recorded CD-R and CD-RW discs may not play properly or at all.
 - In such cases, this is not a problem with the device.
- When changing discs, take care to not smear any fingerprints on the playing side.
- After removing the disc from the CD/MP3 player, make sure to immediately put the disc into a disc sleeve to prevent it from being damaged or smeared with dust.
- If the disc is smeared with dust or liquid, then this may cause problems by contaminating the lens of the CD/MP3 player inside the device.
- Protect the disc from heat and exposure to direct light.

Usable disc type

- This product can play Audio CD/MP3 (WMA) discs.
 - CD-DA : CD-R/CD-RW
 - MP3(WMA) : CD-R/CD-RW/CD-ROM
- MP3 (WMA) files below cannot be played.
 - File encoded in MP3i (MP3 interactive) or MP3 PRO standards
 - MP3 (WMA) file encoded in non-standards
 - MP3 files that are not in MPEG1 Layer3 format

Caution for using disc

- Do not use any of the discs described below. Excessive use of these discs in the player may cause problems.
 - Discs with stickers, labels, or a protective cell attached.
 - Discs affixed with a label printed with an inkjet printer
 - Discs that are made by over-burning, thus holding data exceeding the standard capacity
 - Discs with cracks or scratches or are bent will not be played properly.
 - An 8 cm disc or a non-circular disc (quadrangle, pentagon, oval)

25 Infotainment System

- Do not put anything other than discs in the disc slot since this may cause trouble or damage.
- The disc player may not work properly if the heater is turned on in cold weather due to moisture created inside the device. If this is a concern, keep the product off for about one hour before use.
- Play may be stopped due to the vehicle shaking while driving on rugged roads.
- Do not forcefully take out or insert the disc or block it with your hand while it is being ejected.
- Insert the disc with the printed side facing up. It cannot be played if it is inserted upside down.
- Do not touch the recording side with your hand while handling the disc (the side without any print or decoration).
- Place discs that are not being used in cases, and keep them in a place not exposed to direct light or high temperature.
- Do not smear any chemical substances on the disc. Clean discs of dirt with a moist, soft cloth, wiping from the centre to the edge.

Caution for using CD-R/RW disc

- When using CD-R/CD-RW discs, only the discs that has been "finalized" can be used.
- Discs that are created with a PC may not play according to the application program setup and environment.
- CD-R/CD-RW discs, especially bulk discs, may not work if they are directly exposed to direct light or high temperature, or if they are kept inside your car for a long time.
- The title and other text information recorded on CD-R/CD-RW discs may not be displayed on this device.
- CD-RW discs may have longer loading times than CDs or CD-R discs.
- Damaged music files may not be played or will be cut off while playing
- Folders and music files are displayed in the order of: symbol → number → Korean → English
- Some anti-piracy discs may not be played.
- An MP3 (WMA) disc can have maximum of 512 files for each of the 10 folder levels, and a maximum number of 999 files can be played.
- The folder and file names are not arranged, and are indicated in the order in which they are recorded on the disc.

- This system can only recognize MP3 (WMA) discs made in ISO-9660 level 1/2 or in the Joliet file system. (It does not support the UDF file system.)
- MP3/WMA files are not compatible with packet writing data transmission.
- The disc on which MP3/WMA files and audio data (CDDA) are written may not be played if it is a CD-Extra or Mixed-Mode CD.
- The file/folder names that can be used per disc storage type are as follows, including the four-digit file name extensions (.mp3).
 - ISO 9660 Level 1: Maximum of 12 characters
 - ISO 9660 Level 2: Maximum of 31 characters
 - Joliet: Maximum of 64 characters (1 byte)
 - Windows long file name: Maximum of 28 Characters (1 byte)

Caution for using MP3/WMA music files

- This product can play MP3 (WMA) files with .mp3, .wma (lower case letters) or .MP3 and .WMA (capital letters) file name extensions.
- MP3 files that can be played by this product are as follows.
 - Bit rate: 8 kbps ~ 320 kbps
 - Sampling frequency: 48 kHz, 44.1 kHz, 32 kHz (for MPEG-1), 24 kHz, 22.05 kHz, 16 kHz (for MPEG-2)
- While this product can play files with a 8kbps ~ 320kbps bit rate, files with a bit rate above 128kbps will result in high quality sound.
- This product can display ID3 Tag (Version 1.0, 1.1, 2.2, 2.3 or 2.4) information for MP3 files, such as the album name and the artist.
- To display album (disc title), track (track title), and artist (track artist) information, the file should be compatible with the ID3 Tag V1 and V2 formats.
- This product can play MP3 files using VBR. When playing an MP3 file of this VBR type, the remaining time displayed may be different from the real time.

Order of playing music files

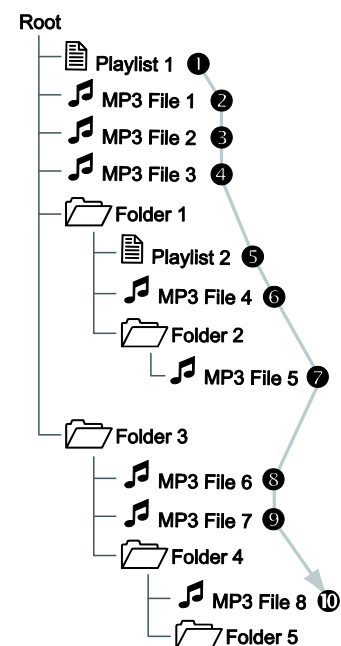

27 Infotainment System

Playing CD/MP3 [Level 4]

Main buttons/Control

(4) CD button

Select the CD/MP3 disc player.

(10) MENU button with TUNE dial

- Turn the button/dial to move to the track list, menu, or MP3 (WMA) track information item.
- Press the button/dial to display the menu screen for the current item or current mode.

(8) I</<<SEEK>>>I buttons

- Press these buttons to play the previous or next track.
- Hold down these buttons to rewind or fast forward through the track, and release the button to resume playing at normal speed.

(13) EJECT button

Eject the disc.

(12) INFO button

Display the information for the track being played.

Insert/Eject disc



Insert the disc to be played with printed surface facing upward in the disc inserting slot.

- Once the reading of disc information is completed, it will automatically play from track 1.
- When a non-readable disc is inserted, the disc will automatically be ejected with the display of a disc error message, and then the system will switch to the previously used function or the FM radio.

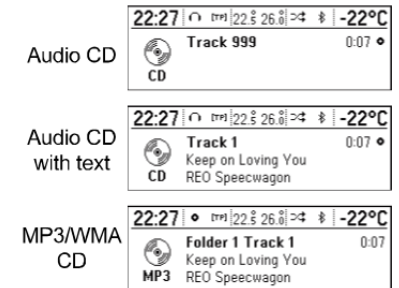

When a disc to be played is already inserted, repeatedly press **CD** button to select CD/MP3 disc play.

- If there is no disc to be played, "no disc" will be displayed on the screen and the function will not be selected.
- The track that was previously played will automatically play.

Ending CD/MP3 play



To end play, press the **EJECT** button to take out the disc.

- When the disc comes out, it automatically switches to the previously used function or the FM radio.
- The disc will automatically be inserted back again if it is not taken out for some time.

Changing playing track

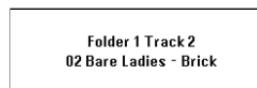

Press the **SEEK** buttons in play mode to play the previous or next track.

- Using the steering wheel remote dial, tracks can be easily changed by turning the **Source** [**△SRC▽**] dial.

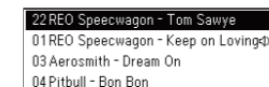
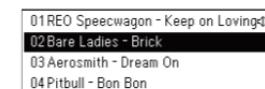

For MP3 (WMA) tracks, turn the **TUNE** dial to move to the play track list, and then press **MENU** button to instantly change it.

Using CD menu [Level 4]
Changing the playback mode

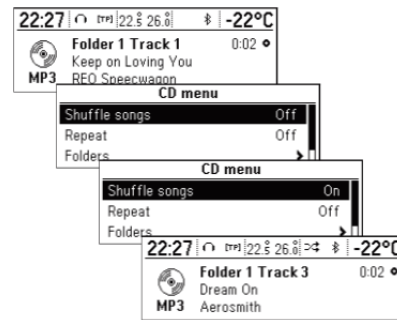

From the play mode, press the **MENU** button to display the CD menu.

Turn the **TUNE** control to select the shuffle or repeat playback functions, and then press the **MENU** button to turn the relevant functions on or off.

CD menu → Track list

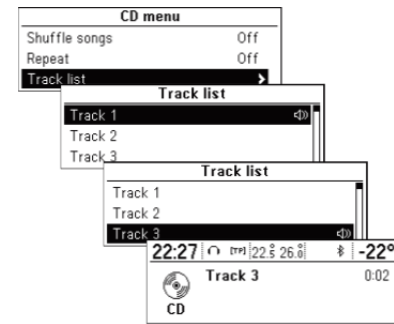

For Audio CD discs, turn the **TUNE dial** from the CD menu to move to the track list, and then press the **MENU** button.

Turn the **TUNE dial** to find the desired track list, and then press the **MENU** button to play the selected track.

CD menu → Searching Folders

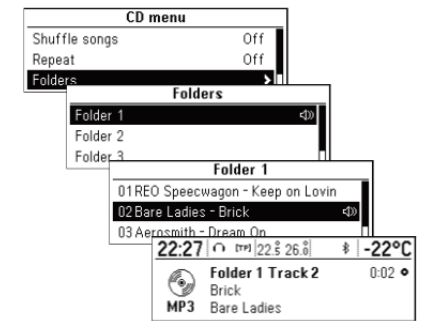

For MP3 (WMA) discs, turn the **TUNE dial** from the CD menu to move to the desired folder, and then press **MENU** button.

Turn the **TUNE dial** to move to the desired folder, and then press **MENU** button.

Turn the **TUNE dial** to find the desired track, and then press **MENU** button to play the selected track from the selected folder.

31 Infotainment System

CD menu → Search ...

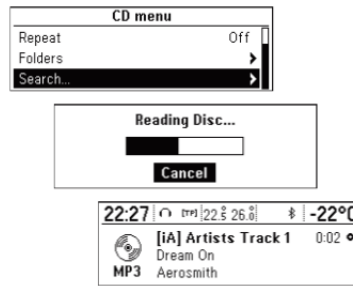

For MP3 [WMA] discs, turn the **TUNE** dial from the CD menu, move to the desired item, and then press the **MENU** button.

- After the system reads the disc information, the first song of the playlist [iP] will be displayed.
- If there are no music files in the playlist [iP], the first song for each artist [iA] will be displayed.

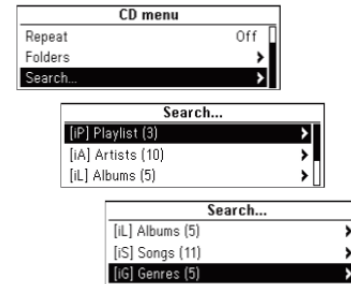

Press the **MENU** button again, and from the displayed search item, turn the **TUNE** dial to select the desired play mode.

- The number of relevant songs will be displayed by Playlist [iP]/Artist [iA]/Album [iL]/Title [iS]/Genre [iG].

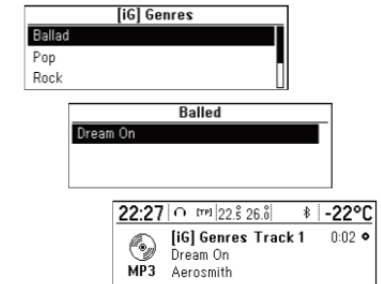

Turn the **TUNE** dial to move to the detailed classification item, and then press the **MENU** button.

Turn the **TUNE** dial to find the desired track/title, and then press the **MENU** button to play the selected track.

Auxiliary Devices [Level 3]

USB player [Level 4]

Cautions for using USB devices

- Operation cannot be guaranteed if the HDD built-in USB mass storage device or CF or SD memory card is connected by using a USB adaptor. Use a USB or flash memory type storage device.
- Take caution to avoid static electricity discharge when connecting or disconnecting the USB. If connection and disconnection are repeated many times in a short time, this may cause a problem in using the device.
- Operation is not guaranteed if the connecting terminal of the USB device is not metal.
- Connection with i-Stick Type USB storage devices may be faulty due to vehicle vibration, so their operation cannot be guaranteed.
- Be careful not to touch the USB connecting terminal with an object or any part of your body.
- The USB storage device can only be recognized when it is formatted in FAT16/32 file format. Only devices with an allocated unit size of 512Byte/Sector or 2,048 Byte/Sector can be used. NTFS and other file systems cannot be recognized.
- According to the type and capacity of the USB storage device and the type of the stored file, the time it takes to recognize the files may differ. This is not a problem with the product in this case, so please wait for the files to be processed.
- Files in some USB storage devices may not be recognized due to compatibility problems, and connections with a memory reader or a USB hub are not supported. Please check the device's operation in the vehicle before use.
- When devices such as an MP3 player, mobile phone, or digital camera are connected through a mobile disc, it may not operate normally.
- Do not disconnect the USB storage device while it is being played.
This may cause damage to the product or the performance of the USB device.
- Disconnect the connected USB storage device when the vehicle ignition turned off. If the ignition is turned on while the USB storage device is connected, the USB storage device may be damaged or may not operate normally in some cases.
- USB storage devices can only be connected to this product for the purpose of playing music files.
The product's USB terminal should not be used to charge USB accessory equipment since the heat generation using the USB terminal may cause performance issues or damage to the product.
- When the logical drive is separated from a mass USB storage device, only the files from the top-level logical drive can be played for USB music files. This is the reason that the music files to be played should be stored in the top-level drive of the device. Music files in particular USB storage devices may also not be normally played if an application is loaded by partitioning a separate drive inside the USB device.
- Music files to which DRM (Digital Right Management) is applied cannot be played.
- This product can support USB storage devices that are up to 16 Gigabytes in capacity with a limit of 999 files, 512 folders, and 10 stages of folder structure. Normal usage cannot be guaranteed for storage devices that exceed this limit.

33 Infotainment System

Caution for using USB music files

- Damaged music files may be cut-off during playback or may not be played at all.
- Folders and music files are displayed in the order of Symbol → Number → Korean →
- A maximum of 64 Korean/English characters can be recognized for folder or file names written in the Joliet file system.

About MP3 (WMA) music files

- The MP3 files that can be played are as follows.
 - Bit rate : 8 kbps ~ 320 kbps
 - Sampling frequency :
48 kHz, 44.1 kHz, 32 kHz (for MPEG-1)
24 kHz, 22.05 kHz, 16 kHz (for MPEG-2)
- This product displays MP3 (WMA) files with the mp3, .wma (lower case letters) or .MP3 or .WMA (capital letters) file name extensions.
- This product can display ID3 tag (Version 1.0, 1.1, 2.2, 2.3, 2.4) information about album, artist, etc. for MP3 files.
- The file/folder names that can be used according to storage type are as follows, including the four character file name

extensions (.mp3).

- ISO 9660 Level 1: Maximum of 12 characters
- ISO 9660 Level 2: Maximum of 31 characters
- Joliet: Maximum of 64 characters (1 byte)
- Windows long file name: maximum of 28 characters (1 byte)
- This product can play MP3 files which use VBR. When a VBR type MP3 file is being played, the remaining time displayed may be different from the actual time remaining.

Main buttons/Dial

The following main buttons and controls are used to play USB music files.

(9) CD/AUX button

Press the button repeatedly when the USB device is connected to select the USB play mode.

(14) MENU button with control

- Turn the dial to move to the track list, menu or MP3 (WMA) track information.

- Press the button to display the menu screen provided by the current item or current mode.

(8) I<SEEK>I buttons

- Press these buttons to play the previous or next track.
- Hold down these buttons to rewind or fast forward, and then release to play at normal speed.

(7) INFO button

Display the information of the track being played.

(16) ⇐BACK button

Cancel the input item or return to the previous menu.

Connecting the USB storage device



Connect the USB storage device in which music files are stored to the USB connection terminal located inside the glove box of the passenger seat.

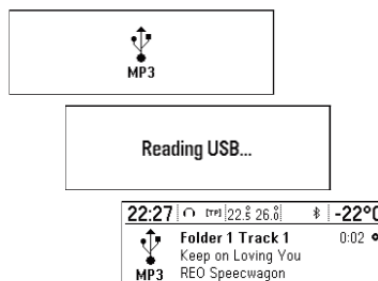

- Once the product finishes reading the information on the USB storage device, it will automatically play from Track 1.
- If a non-readable USB storage device is connected, then an error message will appear and the product will automatically switch to the previously used function or the FM radio function.

If the USB storage device to be played is already connected, repeatedly press the **AUX** button to select the USB player.

- It will automatically play from the previous playing point. Afterwards, the functions of the USB player are operated similarly to CD/MP3 playback.

Afterwards, the functions of the USB player are operated similarly to CD/MP3 playback.

Ending USB music files playback

Press the **RADIO/BAND** or **CD** button to select other functions.

- To end play and disconnect the USB storage device, use the USB menu → USB removal function to safely remove the USB storage device.

Using the USB menu

The instructions for "random/repeat/folder/MP3 music box" from the USB menu are similar to the CD/MP3 player's CD menu; only the "USB removal item" has been added.

Refer to the CD/MP3 player functions from the CD menu.

35 Infotainment System

USB menu → Remove USB

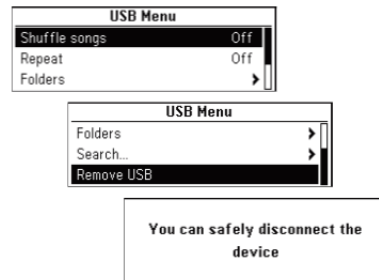

Press the **MENU button** from play mode to display the USB menu.

Turn the **TUNE dial** to move to the Remove USB, and then press the **MENU button** to display the message notifying you that it is safe to remove the USB device.

Disconnect the USB device from the USB connection terminal.

- Return to the previously used function.

iPod player [Level 4]

Limited to models supporting the iPod connection

Main buttons/Dial

The following main buttons and controls are used to play the iPod music files.

(9) CD/AUX button

Press this button repeatedly when the iPod is connected to select the iPod play mode.

(14) MENU button with control

- Turn the button/dial to move and display the track list that is playing.
- Press the button/dial to display the menu screen provided by the current item or current mode.

(8) I</><<SEEK>>/>I buttons

- Press these buttons to play the previous or next track.
- Hold down these buttons to rewind or fast forward, and then release to play at normal speed.

(7) INFO button

Display the track being played.

(16) ←BACK button

- Cancel the previous item or return to the previous menu.

Connecting iPod player

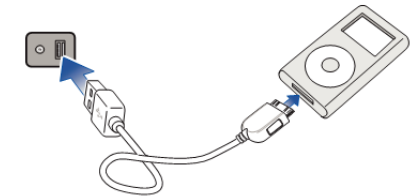

Connect the iPod device in which the music files are stored to the USB connection terminal located inside the glove box of the passenger seat.

- The iPod product models that are connected/supported by this product are as follows.
 - iPod 2G Nano/iPod 3G Nano/iPod 4G & 5G Nano
 - iPod 120GB & 160GB Classic
 - iPod 1G, 2G, & 3G Touch
 - iPhone 3G & 3GS

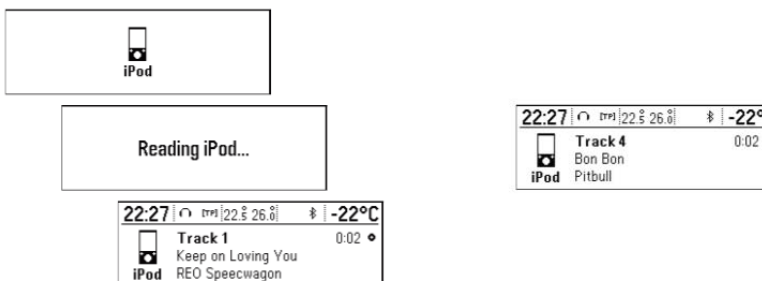

- Only connect the iPod to this product with connection cables supported by iPod products. Other connection cables cannot be used.
- In some cases, the iPod product may be damaged if the ignition is turned off when it is connected to the product.
When the iPod product is not being used, keep it separately from this product with the car ignition turned off.
- Once the product finishes reading the information on the iPod device, it will play automatically from Track 1 or previously played track.
- If a non-readable iPod device is connected, then the relevant error message will appear and the product will automatically switch to the previously used function or the FM radio function.

If the iPod device to be played is already connected, repeatedly press **AUX** button to select the iPod player.

- It will automatically play from the previously played point.
- The playback functions and the information display items of the iPod player used with this product may be different from the iPod in terms of play order, method, and the information displayed.
- Refer to the following table for the classification items related to the search function provided by the iPod product.

	Step 1	Step 2	Step 3	Step4
Playlist	Playlist	Song		
Genre	Genre	Artist	Album	Song
Artist	Artist	Album	Song	
Composer	Composer	Album	Song	
Album	Album	Song		
Audiobooks	Song			
Songs	Song			
Podcasts	Program	Episode		

Afterwards, the functions to play the iPod are operated similarly to CD/MP3 playback.

Log-off iPod playback

To end playback, press the **RADIO/BAND** or **CD/AUX** button to select other functions.

37 Infotainment System

Using the iPod menu

From the iPod menu, the instructions for "Shuffle songs/Repeat/Search..." (including Audio books and Composers)" are similar to CD/MP3 player's CD menu; only the "iPod removal item" has been added.

Refer to each item of CD/MP3 for use.

iPod menu → Eject iPod

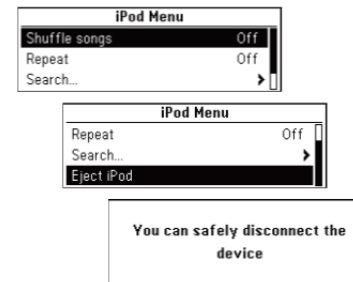

Press the **MENU** button from play mode to display the iPod menu.

Turn the **TUNE** dial to move to the Eject iPod function, and then press the **MENU** button to display the message notifying you that it is safe to remove the device.

Separate the iPod device from the USB connection terminal.

- Return to the previously used function.

Exterior Sound (AUX) Input [Level 4]

Limited to models supporting external sound connection

Main buttons/Dial

The following main buttons and controls are used to enjoy the rich sound of the Infotainment system from the sound output of a connected exterior sound device.

(9) CD/AUX button

When an exterior sound device connected, press the button repeatedly to select the exterior sound (AUX) input mode.

(2) POWER/VOLUME dial

Turn the dial to adjust the volume.

(17) PHONE/MUTE button

Hold down this button to turn the mute function On or Off.

Connecting an exterior sound

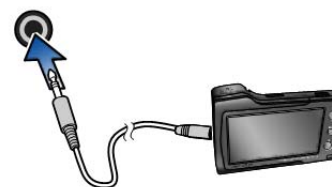

Connect the audio output of the external audio equipment to AUX input terminal.



- The Infotainment system will automatically switch to the exterior sound (AUX) input mode when the exterior sound device is connected.

Press the **AUX** button to switch to the exterior sound input mode if the exterior sound system has already been connected.

Turn the **VOLUME** dial clockwise to adjust the volume.

- AUX input terminal is positioned inside the glove box of the passenger seat

39 Infotainment System

Personalization [Level 3]

Personalization [Level 4]

Main buttons/dial

- The buttons and dial used in the system setup are as follows.

(11) CONFIG button

Press this button to enter the system setup menu.

(10) MENU button with TUNE dial

- Turn the dial to move to the menu or setup item.
- Press the button to select/enter the detailed control screen provided by the current menu or setup item.

(9) ↵BACK button

Cancel the input item or return to the previous screen/menu.

How to use the setup menu for personalization

Access the Infotainment system setup with the car ignition turned off.

- Setup menus and functions may differ according to car model.
- Reference: Table of formation for setup menu on the next page

[Example] System Setup → Setup Time and date → Time Setup: January 25th 2012

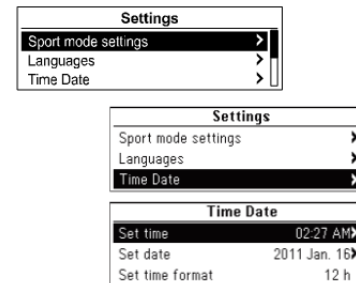

Press the **CONFIG** button for the system setup menu.

After referring to the table of formation for setup menu on the next page, turn the **TUNE** dial to move to the desired

setup menu, and then press **MENU** button.

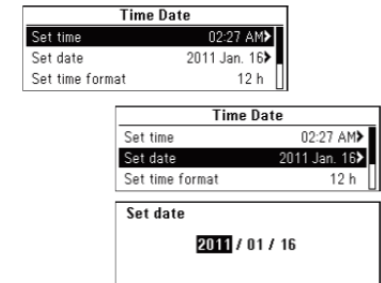

- Indicates the detailed list for the relevant setup menu or functioning state
- If there is another detailed list from the relevant detailed list, you can repeat this action.

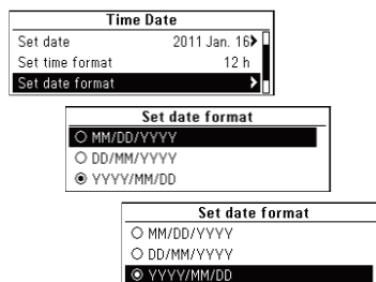

Turn the **TUNE** dial to attain the desired setup value or functioning state, and then press **MENU** button.

- If the relevant detailed list is made of several items, then repeat this action.
- Set/enter the relevant setup value or the functioning state will change.

Table of formation for settings
[Sport mode settings]

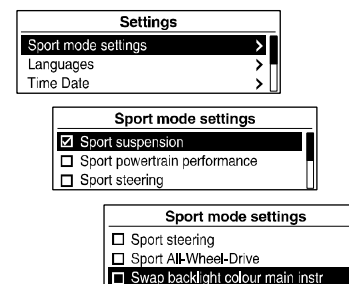

Select the desired Sport mode as below;

- ▼ **Sport suspension**
- ‡ **Sport powertrain performance**
- ‡ **Sport steering**
- ‡ **Sport All-Wheel-Drive**
- ▲ **Swap backlight colour main inst**

[Language]

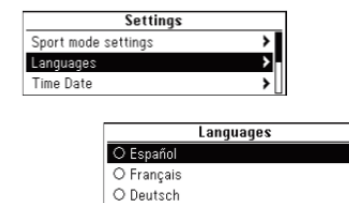

Select the desired Language for displaying.

41 Infotainment System

[Time Date]

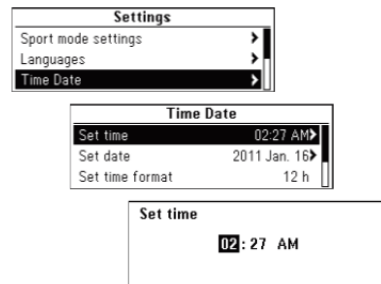

- ▼ **Set time:** Manually set the hours and minutes for the current time.
- ‡ **Set date:** Manually set the current year/month/date.
- ‡ **Set time format:** Select 12h or 24h time display.
- ‡ **Set date format:** Set the date is display format.
MM/DD/YYYY: Jan. 23, 2012
DD/MM/YYYY: 23 Jan. 2012
YYYY/MM/DD: 2012 Jan. 23
- ▲ **RDS clock synchronization:** Select On or Off

[Radio settings]

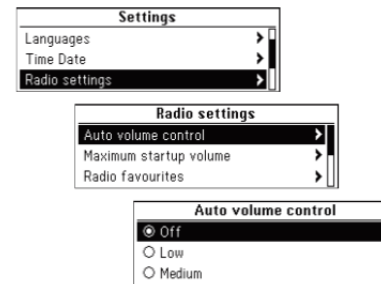

- ▼ **Auto volume control:** Set Off/Low/Medium/High
- ‡ **Maximum startup volume:** Manually set maximum limit for the start-up volume.
- ‡ **Radio favourites:** Manually set your favourites page numbers.
- ‡ **AS-Stations:** Set the AS-Stations for each band.
 - ▼ **AM:** Select On or Off.
 - ‡ **FM:** Select On or Off.
 - ▲ **DAB:** Select On or Off.
- ‡ **RDS options:** Set the RDS options.
 - ▼ **RDS:** Select On or Off.
 - ‡ **Regional:** Select On or Off.

- ‡ **Text scroll freeze:** Select On or Off.
- ‡ **Radio text:** Select On or Off.
- ▲ **TA volume:** Set the TA volume.
- ▲ **DAB settings:** Manually set DAB options.
 - ▼ **Auto ensemble linking:** Select On or Off.
 - ‡ **Auto linking DAB-FM:** Select On or Off.
 - ‡ **Dynamic audio adaption:** Select On or Off.
 - ▲ **Band selection:** Set Both/L-Band/Band III.

[Bluetooth settings]

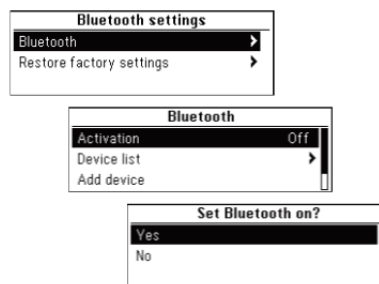

- ▼ **Bluetooth:** Enter the Bluetooth menu.
- ▼ **Activation:** Select On or Off.
- ↑ **Device list:** Select the desired device and select/connect/separate or delete.
- ↑ **Add device:** Try pairing a new Bluetooth device.
- ▲ **Change bluetooth code:** Manually change/set the Bluetooth code.
- ▲ **Restore factory settings:** Restore the initial setup values back to the default settings.

[Vehicle settings]

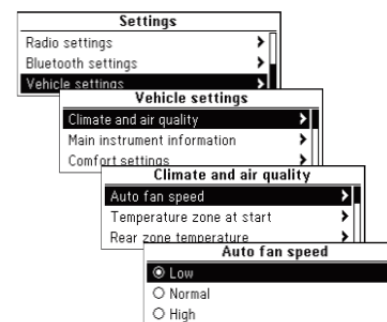

- ▼ **Climate and air quality:** Enter the Climate and air setting menu.
- ▼ **Auto fan speed:** Select Low, Normal or High.
- ↑ **Temperature zone at start:** Select Single zone, Dual zone or Last setting.
- ↑ **Rear zone temperature:** Select Rear zone off, Rear mimic front or Rear last known.
- ↑ **Automatic air recirculation:** Select Off, Low sensitivity or High sensitivity.
- ↑ **Climate control mode:** Select On or Off.
- ↑ **Auto demist:** Select On or Off.

- ↑ **Auto rear demist:** Select On or Off.
- ↑ **Auto cooled/vented seats:** Select On or Off.
- ↑ **Auto heated seats:** Select On or Off.
- ▲ **Warm seats at remote start:** Select On or Off.
- ↑ **Main instrument informations:** Enter the Main instrument information setting menu.
- Indication **Hybrid eco mode:** Select On or Off.
- ↑ **Comfort settings**
 - ▼ **Chime volume:** Select Normal or High.
 - ↑ **Easy exit steering column:** Select Off, Column in, Column up or Column in & up.
 - ↑ **Easy exit driver seat:** Select Off or On.
 - ↑ **Auto mirror tilt in reverse:** Select Off or On.
 - ↑ **Comf. closing mirror fold:** Select Off or On.
 - ↑ **Personalization by driver:** Select Off or On.
 - ▲ **Rear auto wipe in reverse :** Select On or Off.
- ↑ **Park assist/Collision detection**
 - ▼ **Park assist:** Select On or Off.

43 Infotainment System

- ▲ **Sider blind zone alert:** Select On or Off.
- ‡ **Exterior ambient lighting**
 - ▼ **Exterior lighting by unlocking :** Select On or Off.
 - ▲ **Duration upon exit of vehicle :** Select Off/30 Seconds/1 Minute/2 Minute.
- ‡ **Power door locks**
 - ▼ **Auto door unlock :** Select All Doors/Driver Door /Off
 - ‡ **Auto door lock :** Select On or Off
 - ‡ **Stop door lock if door open :** Select On or Off.
 - ▲ **Delayed door lock :** Select On or Off.
- ‡ **Remote locking, unlocking, starting**
 - ▼ **Passive door unlock:** Select All doors or Driver door only.
 - ‡ **Passive door lock:** Select Horn on passive door lock, On or Off.
 - ‡ **Unlock sliding door:** Select Unlock all doors with sliding door or Security.
 - ‡ **Remote unlock feedback:** Select On or Off.
- ‡ **Remote lock feedback:** Select Lights & Horn/Lights only/Horn only/Off.
- ‡ **Remote door unlock:** Select Driver Door or All Doors
- ‡ **Auto relock doors:** Select On or Off.
- ‡ **Vehicle remote start:** Select On or Off.
- ▲ **Remote left in vehicle alarm:** Select On or Off.
- ▲ **Restore factory settings:** Select No or Yes.

Phone [Level 2]

Bluetooth [Level 3]

Main buttons/dial [Level 4]

The following main buttons and controls are used to play music files or use the call functions via a Bluetooth device.

(5) AUX button

When a Bluetooth device with a music player function is connected, press this button repeatedly to select Bluetooth audio play mode.

(10) MENU button with TUNE dial

- Press this button from Bluetooth phone mode to display the menu screen.
- Turn this dial to move to the menu or setup value.

(8) I</><<SEEK>>/>I buttons

- Press these buttons in Bluetooth audio play mode to play the previous or next track.
- Hold down these buttons to rewind or fast forward, and release to play at normal speed.

Connecting Bluetooth [Level 4]

Registering the Bluetooth device

Register the Bluetooth device to be connected to the Infotainment system with the car ignition turned off.

- Firstly, set up the Bluetooth device to be connected from the Bluetooth setup menu to enable other devices to search for the Bluetooth device.

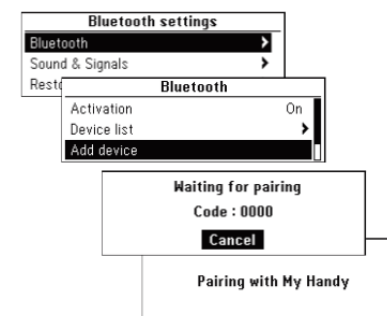

Press the **CONFIG** button, and use the **MENU** button with **TUNE** dial to move to Settings → Bluetooth settings → Bluetooth → Add device, and then press the **MENU** button.

- Bluetooth devices can be registered not only by using **CONFIG** button, but also by using Phone menu → Bluetooth settings →

Bluetooth → Add device.

- If there already is a Bluetooth device connected to the Infotainment system, the "Bluetooth in use" message will appear.
- Connection standby will be displayed with a message and a security code. (The initial value is 0000, and can be changed from Settings → Bluetooth settings → Bluetooth → Changing Bluetooth code.)

The Infotainment system can be found by searching the to-be-connected Bluetooth device.

Enter the security code for the Infotainment system through the Bluetooth device

If the registration of device to be connected to the Infotainment system is successful, then the screen will display the information of the Bluetooth device

45 Infotainment System

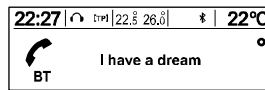

- The Infotainment system can register up to five Bluetooth devices.

Connecting/Deleting/Separating the Bluetooth Devices

Firstly, set up the Bluetooth device to be connected from the Bluetooth setup menu to enable other devices to search for the Bluetooth device.

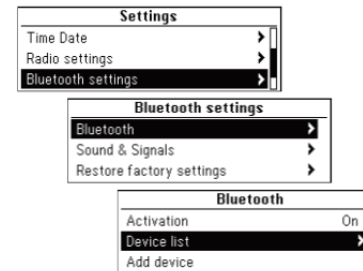

Press the **CONFIG** button, and use the **MENU** button with **TUNE** dial, to move to Settings → Bluetooth settings → Bluetooth → Device list, and then press the **MENU** button.

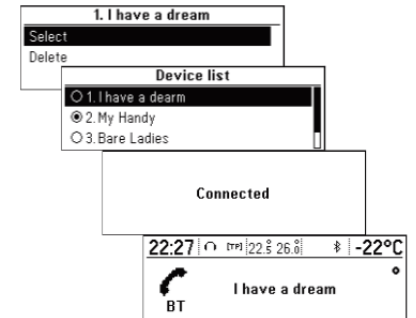

Use the **MENU** button with **TUNE** dial to move from the registered Bluetooth device to the device to be connected, and then press the **MENU** button.

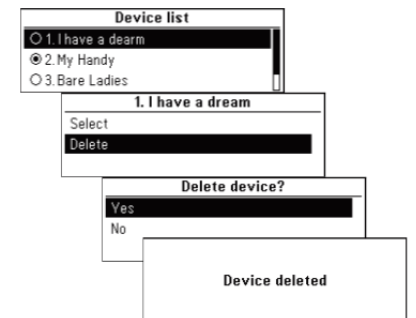

You can delete by using the **MENU** button with **TUNE** dial, moving to select the item, moving to delete the item to delete, and then pressing the **MENU** button.

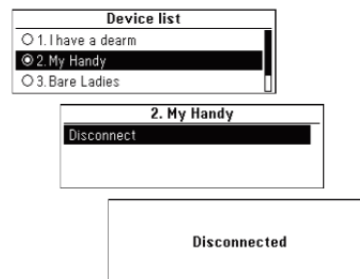

- Disconnecting the Currently Connected Bluetooth Device, From the device list screen, select the connected device, which will display Disconnect item, and then press the **MENU** button.

Cautions for registering/connecting Bluetooth

- When it is not possible to connect to Bluetooth, delete the entire device list from the Bluetooth to be connected, and try again. If deleting the entire device list does not work, then remove the battery and reconnect.
- If there is a problem after the Bluetooth device is connected, use the **MENU** button with **TUNE** dial to carry out Settings → Bluetooth Settings → Restore factory settings.
Initialize the device with the problem caused by an error that occurred with the connection of the Bluetooth device and the Infotainment system.
- Sometimes, Bluetooth can only be connected through hands-free or the Bluetooth audio play functions despite a stereo headset being connected. In this case, try and reconnect the Infotainment system using the Bluetooth device.
- For Bluetooth devices that do not support stereo headsets, the Bluetooth audio play function cannot be used.

Cautions for playing Bluetooth audio

- Do not change the track too quickly when playing Bluetooth audio.

It takes some time to transmit data from the mobile phone to the Infotainment system.

- The Infotainment system transmits the order to play from the mobile phone in the Bluetooth audio play mode. If this is done in a different mode, then the device transmits the order to stop. Depending on the mobile phone's options, this order to play/stop may some take time to activate.

- If the mobile phone or Bluetooth device is not in the waiting screen mode, it may not automatically play despite being carried out from the Bluetooth audio play mode.

If Bluetooth audio playback is not functioning, then check to see if the mobile phone is in the waiting screen mode.

- Sometimes, sounds may be cut off during the Bluetooth audio playback.

The Infotainment system outputs the audio from the mobile phone or Bluetooth device as it is transmitted.

Bluetooth error messages and measures**● Bluetooth deactivated**

Check if Bluetooth activation is setup as ON. The Bluetooth function can be used upon turning on Bluetooth activation.

● Bluetooth is busy

Check if there are any Bluetooth devices connected. To connect another device, disconnect any other connected devices first, and then reconnect.

● Device list is full.

Check if there are less than 5 registered devices. No more than 5 devices can be registered.

● No phone book available

This message will be displayed if the mobile phone does not support contacts transmission. If this message appears after several attempts, then the device does not support contacts transmission.

Caution: The message will be displayed when the transmission of contacts is supported while information with a device error is also transmitted. Update the device again if this occurs.

● Phone book is empty

This message is displayed if no phone numbers are stored in the mobile phone.

This will also be displayed if the phone log transmission is supported, but in a way

that is not supported by the Infotainment system.

49 Infotainment System

Hands-free phone [Level 3]

Taking calls [Level 4]

When a phone call comes through the connected Bluetooth mobile phone, the playing track will be cut off and the phone will ring with the relevant information displayed.

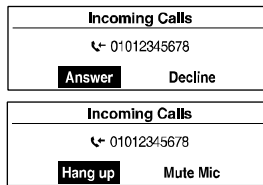

To talk on the phone, press **Call** button on the steering wheel remote control or turn the **TUNE** dial to move to the Answer function, and then press the **MENU** button.

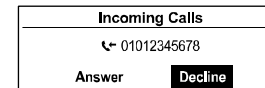

- To reject the call, press the **Mute/Hang up** button on the steering wheel remote control or use the **MENU** button with **TUNE** dial and select Decline.

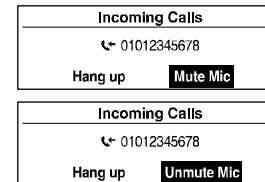

- While conversing, it is possible to block the

transmitted sound by selecting the Mute Microphone item by using the **MENU** button with **TUNE** dial.

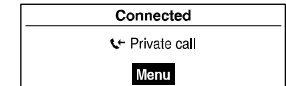

- While conversing, hold down the **Call** button from the steering wheel remote control to switch to the Private call mode (some phones may not support the private call mode depending on the phone's options).
- When a call is received with the Infotainment System and Bluetooth is being connected, there are mobile phones that do not automatically change to the private call mode. This depends on the original specifications of each mobile phone.

Calling by Re-dial [Level 4]

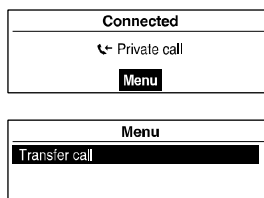

- When it is possible to use services related to a third-party conversation supported by the communications service provider through an application, it is possible to make calls during a call through the Infotainment system.
- While third or more-party conversing, displaying contents may differ from practical information.

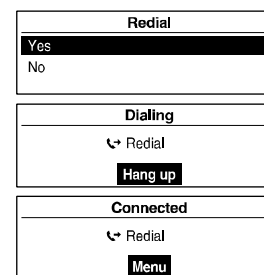

From the steering wheel remote controller, press the **Call** button to display the redial guidance screen, or hold down the button to display the caller log screen.

Turn the **TUNE** dial to select Yes, and then press the **MENU** button to make a call.

- If the mobile phone is not in waiting mode, your phone might not support the redial function. This depends on the mobile phone's options.
- When making redialing a number, the connected phone number will not be displayed.
- Depending on the mobile phone, there are

cases in which the call is made through the call history of the received or missed calls instead of the redial mode. This depends on the mobile phone's options.

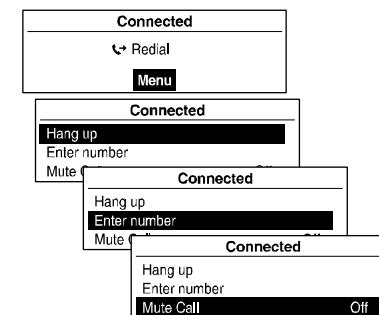

Press the **MENU** button while the phone is connected to display the connecting functions as shown below. Use **MENU** button with **TUNE** dial to use the functions in the menu that appears.

51 Infotainment System

Calling by Outgoing call log [Level 4]

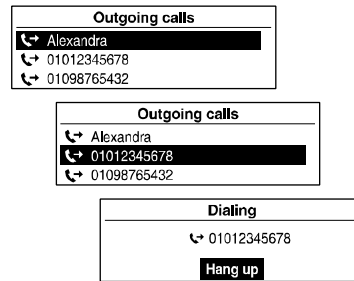

To make a call by the Outgoing call log, hold down the **Call** button on the steering wheel remote control and turn the **TUNE** dial to select the desired call list, then press the **MENU** button.

Calling by Entering numbers [Level 4]

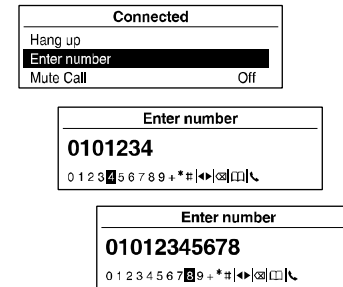

To make a call by entering the phone number, press the **MENU** button and turn the **TUNE** dial to select Enter number, and then press the **MENU** button.

Turn the **TUNE** dial to select the desired numbers, and then press the **MENU** button to enter the number.

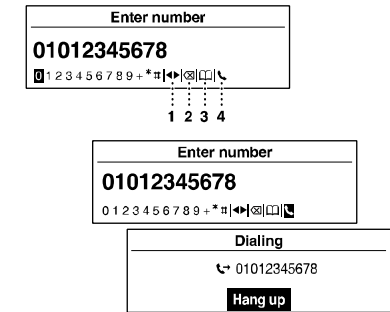

- Repeat this item to enter all telephone numbers.
- Press the ◀**BACK** button to delete a letter one by one, or hold down the button to delete all content that has been entered.
- Refer to the following contents to edit the input contents.
 - 1 Move: Move input position
 - 2 Delete: Delete input character
 - 3 Phone book: Search contacts (usable after updating the phone numbers)
 - 4 Dial: Start dialing

After the telephone number has been fully entered, turn the **TUNE** dial to select begin dial, and then press the **MENU** button to make a call.

- To cancel the dialing during the dial, press

the **MENU** button.

Note : How to use the Phone book for entering the phone number

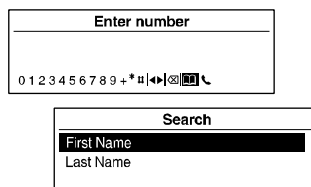

Turn the **TUNE** dial to select the Phone book icon, then press the **MENU** button to enter the Search function. (refer to next section: Phone menu→Phone book)

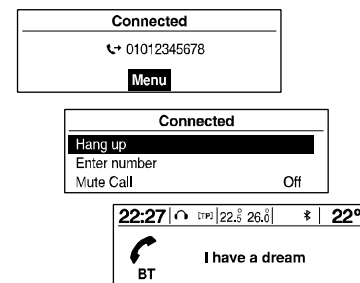

To end a call, turn the **TUNE** dial to choose the Hang up, and then press the **MENU** button.

Using the Phone menu [Level 4]

Phone Menu → Phone book → Search

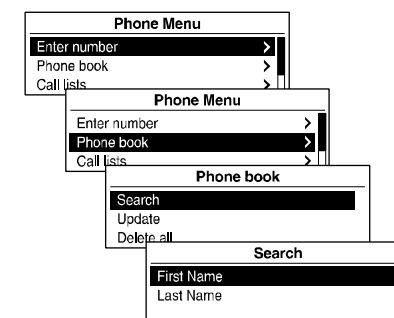

Press the **MENU** button, turn the **TUNE** dial to select Phone book, and then press the **MENU** button.

- A notification will appear on screen, with no contacts to use, and you will be returned to the previous menu.

Turn the **TUNE** dial to select Search, and then press the **MENU** button.

Turn the **TUNE** dial to select First or Last Name, and then press **MENU** button.

53 Infotainment System

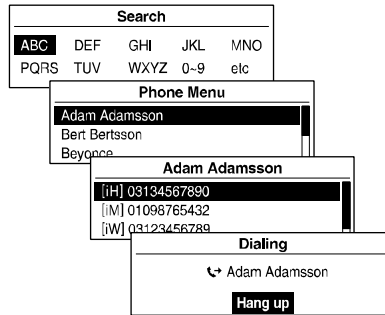

Turn the **TUNE** dial to select search terms/range, and then press the **MENU** button.

Turn the **TUNE** dial from the search results screen to select the desired item, and then press the **MENU** button to view the details for that item.

- Display number types

[iH] Home	[iM] : Mobile
[iW] : Work	[iO] : Other

To call the relevant number, press the **MENU** button.

- For more directions, refer to the making phone calls item.

Phone Menu → Phone book → Update

Update the contacts of the connected mobile phone to the system's contacts.

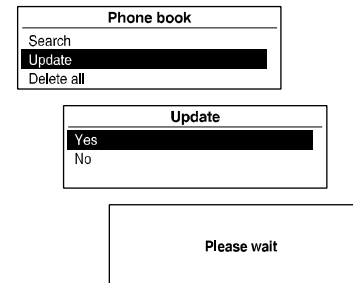

Using the **MENU** button with **TUNE** dial, select the Phone Menu → Phone book → Update, and then press the **MENU** button.

Turn the **TUNE** dial to select Yes or No, and then press the **MENU** button to activate or cancel the update.

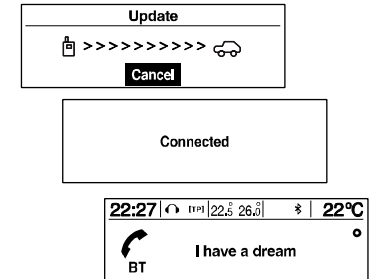

Notice for updating contacts

- This function can be used with mobile phones that support contacts update and the call history transmission function. (If the product is connected to a mobile phone that does not support these functions, the call history can be displayed through the Infotainment system.)
- Update is not supported for more than 1,000 contact numbers.
- Be aware that hands-free and Bluetooth audio playback will be cut-off while proceeding with updates for contacts. (Other functions except for hands-free and Bluetooth audio playback can be used.)
- To update your contacts, it is possible to

request for the transmission certification for contacts. If the waiting screen does not change for a long time, you can check whether the mobile is requesting for certification. When requesting for certification of the mobile phone, all Bluetooth connections will be cut off if it is not accepted, and then the device will be reconnected.

- When receiving the call history, it is possible to request for the transmission certification for the call history from the mobile phone. If the waiting screen does not change for a long time, check whether the mobile is requesting for certification.

When requesting for the certification of the mobile phone, all Bluetooth connections will be cut off if it is not accepted, and then the device will be reconnected.

- If there is a problem in the stored information of the mobile phone, the contacts may not be updated.
- The Infotainment system only uses information coded in UTF-8 format.
- If other operations (game, map search, navigation, etc.) are activated during the contacts update or call history transmission progress, the update/ transmission process may not work.

This is because other operations running

on the mobile phone are affecting the data transmission.

- When the contacts update or call history transmission is completed, all hands-free and Bluetooth audio play modes will be automatically disconnected and then reconnected.
- If the Infotainment system gets turned off while conversing on the phone, the call will be transmitted to the mobile phone. Some phones may need to setup a call transmission function beforehand, depending on the type of the phone.
- If the user disconnects the connection directly (using the Infotainment or mobile phone), the auto connection function does not take place. Auto-connection: This function automatically finds and connects the device that was last connected.
- The contacts may not always display all the lists on the phone when selected. The Infotainment system only displays what has been transmitted from the mobile phone.
- The contacts update can only receive four numbers per contacts directory (Mobile Phone, Office, Home, and Other).
- Changing the language setup during the contacts update will delete all previous updates.
- If the mobile phone is not set with a waiting

screen, calls may not be made to this Infotainment system

- If the OS of the mobile phone gets updated, it may change how the phone's Bluetooth function works.
- Special characters and unsupported languages will be displayed as "_____".
- Calls registered in the contacts without any name will be indicated as "No number in contact."
- The Infotainment system will display contacts, call history, and redial information as it is transmitted from the mobile phone.

55 Infotainment System

Phone Menu → Phone book → Delete all

Every single phone number that has been stored in the system contacts will be deleted.

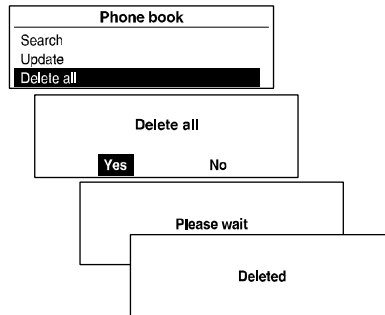

Use the **MENU** button with **TUNE** dial to select Phone Menu → Phone book → Delete All, and then press the **MENU** button.

Turn the **TUNE** dial to select Yes or No, and then press the **MENU** button to delete all contacts or to cancel.

Phone Menu → Call lists

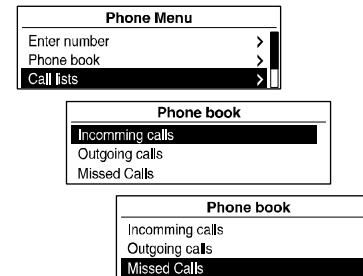

Use the **MENU** button with **TUNE** dial to select Phone Menu → Call lists, and then press the **MENU** button.

Use the **MENU** button with **TUNE** dial to select the detailed call history, and then press the **MENU** button.

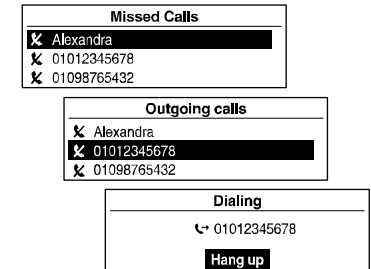

Turn the **TUNE** dial to check the call history and to make a call.

Press the **MENU** button to call the selected number from the call history.

Phone Menu → Bluetooth settings

Setup Bluetooth function.

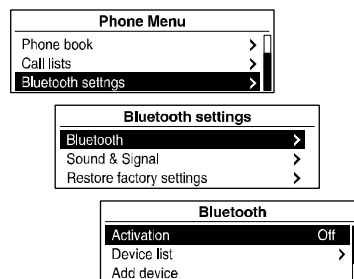

Using the **MENU** button with **TUNE** dial, select the Phone Menu → Bluetooth Settings, and then press the **MENU** button.

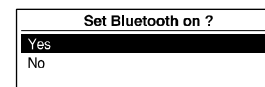

To activate the Bluetooth function, register/connect/delete the Bluetooth device or change the Bluetooth code, choose Bluetooth by using the **MENU** button with **TUNE** dial, and then use the **MENU** button with **TUNE** dial to set up the desired item.

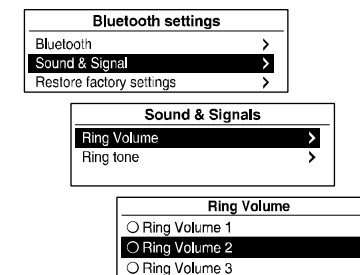

To set up the ring tone and its volume used by the Bluetooth function, use the **MENU** button with **TUNE** dial to select Sound & Signal, and then set up the desired items with the **MENU** button with **TUNE** dial.

57 Infotainment System

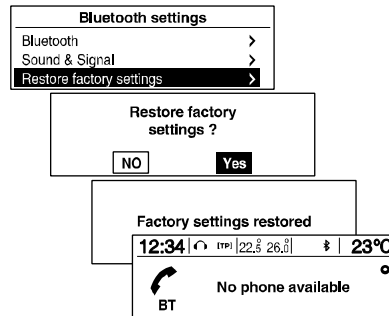

To reinitialize the Bluetooth settings to their default values, use the **MENU** button with **TUNE** dial to select the initial setup restoration item, and then select Yes with the **MENU** button.