



TEST REPORT

Report Reference No...... : **CHEW19070079** Report verification: 

Project No...... : **SHT1906076101EW**

FCC ID..... : **YPVITALCOMGUMBO**

Applicant's name..... : **ITALCOM GROUP**

Address..... : 1728 Coral Way, Coral Gables, Miami,Florida, United States

Manufacturer..... : Emocom Technology Co., Limited

Address..... : Unit 17,9/F., Tower A, New Mandarin Plaza, No.14 Science Museum Road, Tsimshatsui, Kowloon, Hong Kong.

Test item description : **Smart watch**

Trade Mark : NYX Mobile

Model/Type reference..... : GUMBO

Listed Model(s) : -

Standard : **FCC CFR Title 47 Part 15 Subpart C Section 15.247**

Date of receipt of test sample..... : Jun 28, 2019

Date of testing..... : Jun 29, 2019- Jul 17, 2019

Date of issue..... : Jul 18, 2019

Result..... : **PASS**

Compiled by
 (Position+Printed name+Signature): File administrators Silvia Li 

Supervised by
 (Position+Printed name+Signature): Project Engineer Aaron Fang 

Approved by
 (Position+Printed name+Signature): RF Manager Hans Hu 

Testing Laboratory Name : **Shenzhen Huatongwei International Inspection Co., Ltd.**

Address..... : 1/F, Bldg 3, Hongfa Hi-tech Industrial Park, Genyu Road, Tianliao, Gongming, Shenzhen, China

Shenzhen Huatongwei International Inspection Co., Ltd. All rights reserved.

This publication may be reproduced in whole or in part for non-commercial purposes as long as the Shenzhen Huatongwei International Inspection Co., Ltd. is acknowledged as copyright owner and source of the material. Shenzhen Huatongwei International Inspection Co., Ltd. takes no responsibility for and will not assume liability for damages resulting from the reader's interpretation of the reproduced material due to its placement and context.

The test report merely correspond to the test sample.

Contents

1.	<u>TEST STANDARDS AND REPORT VERSION</u>	3
1.1.	Test Standards	3
1.2.	Report version	3
2.	<u>TEST DESCRIPTION</u>	4
3.	<u>SUMMARY</u>	5
3.1.	Client Information	5
3.2.	Product Description	5
3.3.	Operation state	6
3.4.	EUT configuration	6
3.5.	Modifications	6
4.	<u>TEST ENVIRONMENT</u>	7
4.1.	Address of the test laboratory	7
4.2.	Test Facility	7
4.3.	Environmental conditions	8
4.4.	Statement of the measurement uncertainty	8
4.5.	Equipments Used during the Test	9
5.	<u>TEST CONDITIONS AND RESULTS</u>	11
5.1.	Antenna requirement	11
5.2.	Conducted Emissions (AC Main)	12
5.3.	Conducted Peak Output Power	15
5.4.	20 dB Bandwidth	19
5.5.	Carrier Frequencies Separation	23
5.6.	Hopping Channel Number	25
5.7.	Dwell Time	27
5.8.	Pseudorandom Frequency Hopping Sequence	34
5.9.	Restricted band (radiated)	35
5.10.	Band edge and Spurious Emissions (conducted)	37
5.11.	Spurious Emissions (radiated)	53
6.	<u>TEST SETUP PHOTOS</u>	57
7.	<u>EXTERANAL AND INTERNAL PHOTOS</u>	58

1. TEST STANDARDS AND REPORT VERSION

1.1. Test Standards

The tests were performed according to following standards:

[FCC Rules Part 15.247](#): Frequency Hopping, Direct Spread Spectrum and Hybrid Systems that are in operation within the bands of 902-928 MHz, 2400-2483.5 MHz, and 5725-5850 MHz

[ANSI C63.10-2013](#): American National Standard for Testing Unlicensed Wireless Devices

[KDB 558074 D01 15.247 Meas Guidance v05r01](#): Guidance for Compliance Measurements on Digital Transmission System, Frequency Hopping Spread Spectrum System, and Hybrid System Devices Operating under Section 15.247 of The FCC Rules

1.2. Report version

Revision No.	Date of issue	Description
N/A	2019-07-18	Original

2. TEST DESCRIPTION

Test Item	Section in CFR 47	Result	Test Engineer
Antenna Requirement	15.203/15.247 (c)	PASS	Jeremy Zhang
AC Power Line Conducted Emissions	15.207	PASS	Jeremy Zhang
Conducted Peak Output Power	15.247 (b)(1)	PASS	JiongSheng.Feng
20 dB Bandwidth	15.247 (a)(1)	PASS	JiongSheng.Feng
Carrier Frequencies Separation	15.247 (a)(1)	PASS	JiongSheng.Feng
Hopping Channel Number	15.247 (a)(1)	PASS	JiongSheng.Feng
Dwell Time	15.247 (a)(1)	PASS	JiongSheng.Feng
Pseudorandom Frequency Hopping Sequence	15.247(b)(4)	PASS	JiongSheng.Feng
Restricted band	15.247(d)/15.205	PASS	Tony Duan
Radiated Emissions	15.247(d)/15.209	PASS	Tony Duan

Note: The measurement uncertainty is not included in the test result.

3. SUMMARY

3.1. Client Information

Applicant:	ITALCOM GROUP
Address:	1728 Coral Way, Coral Gables, Miami, Florida, United States
Manufacturer:	Emocom Technology Co., Limited
Address:	Unit 17,9/F., Tower A, New Mandarin Plaza, No.14 Science Museum Road, Tsimshatsui, Kowloon, Hong Kong.

3.2. Product Description

Name of EUT:	Smart watch
Trade Mark:	NYX Mobile
Model No.:	GUMBO
Listed Model(s):	-
Power supply:	DC 3.7V
Adapter information:	Input:100-240Va.c., 50/60Hz, 0.15A Output:5.0Vd.c., 500mA
Hardware version:	NYX_GUMBO_001
Software version:	GUMBO_AMXNYX_V001R
Bluetooth	
Version:	Supported BT4.0+EDR
Modulation:	GFSK, $\pi/4$ DQPSK, 8DPSK
Operation frequency:	2402MHz~2480MHz
Channel number:	79
Channel separation:	1MHz
Antenna type:	PIFA Antenna
Antenna gain:	1.3dBi

3.3. Operation state

➤ **Test frequency list**

According to section 15.31(m), regards to the operating frequency range over 10 MHz, must select three channel which were tested. the Lowest frequency, the middle frequency, and the highest frequency of channel were selected to perform the test, please see the above gray bottom.

Channel	Frequency (MHz)
00	2402
01	2403
⋮	⋮
39	2441
⋮	⋮
77	2479
78	2480

➤ **TEST MODE**

For RF test items:
The engineering test program was provided and enabled to make EUT continuous transmit
For AC power line conducted emissions:
The EUT was set to connect with the Bluetooth instrument under large package sizes transmission.
For Radiated suprious emissions test item:
The engineering test program was provided and enabled to make EUT continuous transmit. The EUT in each of three orthogonal axis emissions had been tested ,but only the worst case (X axis) data recorded in the report.

3.4. EUT configuration

The following peripheral devices and interface cables were connected during the measurement:

- - supplied by the manufacturer
- - supplied by the lab

/	Manufacturer:	/
	Model No.:	/
/	Manufacturer:	/
	Model No.:	/

3.5. Modifications

No modifications were implemented to meet testing criteria.

4. TEST ENVIRONMENT

4.1. Address of the test laboratory

Laboratory: Shenzhen Huatongwei International Inspection Co., Ltd.

Address: 1/F, Bldg 3, Hongfa Hi-tech Industrial Park, Genyu Road, Tianliao, Gongming, Shenzhen, China

4.2. Test Facility

CNAS-Lab Code: L1225

Shenzhen Huatongwei International Inspection Co., Ltd. has been assessed and proved to be in compliance with CNAS-CL01 Accreditation Criteria for Testing and Calibration Laboratories (identical to ISO/IEC17025: 2005 General Requirements) for the Competence of Testing and Calibration Laboratories.

A2LA-Lab Cert. No.: 3902.01

Shenzhen Huatongwei International Inspection Co., Ltd. EMC Laboratory has been accredited by A2LA for technical competence in the field of electrical testing, and proved to be in compliance with ISO/IEC 17025: 2005 General Requirements for the Competence of Testing and Calibration Laboratories and any additional program requirements in the identified field of testing.

FCC-Registration No.: 762235

Shenzhen Huatongwei International Inspection Co., Ltd. EMC Laboratory has been registered and fully described in a report filed with the FCC (Federal Communications Commission). The acceptance letter from the FCC is maintained in our files.

IC-Registration No.:5377A

Two 3m Alternate Test Site of Shenzhen Huatongwei International Inspection Co., Ltd. has been registered by Certification and Engineering Bureau of Industry Canada for the performance of radiated measurements with Registration No.: 5377A.

ACA

Shenzhen Huatongwei International Inspection Co., Ltd. EMC Laboratory can also perform testing for the Australian C-Tick mark as a result of our A2LA accreditation.

4.3. Environmental conditions

During the measurement the environmental conditions were within the listed ranges:

Temperature:	15~35°C
Relative Humidity:	30~60 %
Air Pressure:	950~1050mba

4.4. Statement of the measurement uncertainty

The data and results referenced in this document are true and accurate. The reader is cautioned that there may be errors in calibration limits of the equipment and facilities. The measurement uncertainty was calculated for all measurements listed in this test report according to TR-100028-01 "Electromagnetic compatibility and Radio spectrum Matters (ERM); Uncertainties in the measurement of mobile radio equipment characteristics; Part 1" and TR-100028-02 "Electromagnetic compatibility and Radio spectrum Matters (ERM); Uncertainties in the measurement of mobile radio equipment characteristics; Part 2" and is documented in the Shenzhen Huatongwei International Inspection Co., Ltd. quality system according to ISO/IEC 17025. Furthermore, component and process variability of devices similar to that tested may result in additional deviation. The manufacturer has the sole responsibility of continued compliance of the device.

Here after the best measurement capability for Shenzhen Huatongwei International Inspection Co., Ltd. is reported:

Test Items	Measurement Uncertainty	Notes
Transmitter power conducted	0.51 dB	(1)
Conducted spurious emissions 9kHz~40GHz	0.51 dB	(1)
Conducted Disturbance 150kHz~30MHz	3.02 dB	(1)
Radiated Emissions below 1GHz	4.90 dB	(1)
Radiated Emissions above 1GHz	4.96 dB	(1)
Occupied Bandwidth	70 Hz	(1)

(1) This uncertainty represents an expanded uncertainty expressed at approximately the 95% confidence level using a coverage factor of $k=1.96$

4.5. Equipments Used during the Test

● Conducted Emission						
Used	Test Equipment	Manufacturer	Model No.	Serial No.	Last Cal. Date (YY-MM-DD)	Next Cal. Date (YY-MM-DD)
●	Shielded Room	Albatross projects	N/A	N/A	2018/09/28	2023/09/27
●	EMI Test Receiver	R&S	ESCI	101247	2018/10/27	2019/10/26
●	Artificial Mains	SCHWARZBECK	NNLK 8121	573	2018/10/27	2019/10/26
●	Pulse Limiter	R&S	ESH3-Z2	100499	2018/10/27	2019/10/26
●	RF Connection Cable	HUBER+SUHNER	EF400	N/A	2018/11/15	2019/11/14
●	Test Software	R&S	ES-K1	N/A	N/A	N/A
○	Single Balanced Telecom Pair ISN	FCC	FCC-TLISN-T2-02	20371	2018/10/28	2019/10/27
○	Two Balanced Telecom Pairs ISN	FCC	FCC-TLISN-T4-02	20373	2018/10/28	2019/10/27
○	Four Balanced Telecom Pairs ISN	FCC	FCC-TLISN-T8-02	20375	2018/10/28	2019/10/27
○	V-Network	R&S	ESH3-Z6	100211	2018/10/27	2019/10/26
○	V-Network	R&S	ESH3-Z6	100210	2018/10/27	2019/10/26
○	2-Line V-Network	R&S	ESH3-Z5	100049	2018/10/27	2019/10/26

● Radiated Emission-6th test site						
Used	Test Equipment	Manufacturer	Model No.	Serial No.	Last Cal. Date (YY-MM-DD)	Next Cal. Date (YY-MM-DD)
●	Semi-Anechoic Chamber	Albatross projects	SAC-3m-02	N/A	2018/09/30	2021/09/29
●	EMI Test Receiver	R&S	ESCI	100900	2018/10/28	2019/10/27
●	Loop Antenna	R&S	HFH2-Z2	100020	2017/11/20	2020/11/19
●	Ultra-Broadband Antenna	SCHWARZBECK	VULB9163	546	2017/04/05	2020/04/04
●	Pre-Amplifier	SCHWARZBECK	BBV 9742	N/A	2018/11/15	2019/11/14
●	RF Connection Cable	HUBER+SUHNER	N/A	N/A	2018/09/28	2019/09/27
●	RF Connection Cable	HUBER+SUHNER	SUCOFLEX104	501184/4	2018/09/28	2019/09/27
●	Test Software	R&S	ES-K1	N/A	N/A	N/A
●	Turntable	Maturo Germany	TT2.0-1T	N/A	N/A	N/A
●	Antenna Mast	Maturo Germany	CAM-4.0-P-12	N/A	N/A	N/A

● Radiated emission-7th test site						
Used	Test Equipment	Manufacturer	Model No.	Serial No.	Last Cal. Date (YY-MM-DD)	Next Cal. Date (YY-MM-DD)
●	Semi-Anechoic Chamber	Albatross projects	SAC-3m-01	N/A	2018/09/30	2021/09/29
●	Spectrum Analyzer	R&S	FSP40	100597	2018/10/27	2019/10/26
●	Horn Antenna	SCHWARZBECK	9120D	1011	2017/03/27	2020/03/26
●	Pre-amplifier	BONN	BLWA0160-2M	1811887	2018/11/14	2019/11/13
●	Pre-amplifier	CD	PAP-0102	12004	2018/11/14	2019/11/13
●	Broadband Pre-amplifier	SCHWARZBECK	BBV 9718	9718-248	2019/04/26	2020/04/25
●	RF Connection Cable	HUBER+SUHNER	RE-7-FH	N/A	2018/11/15	2019/11/14
●	RF Connection Cable	HUBER+SUHNER	RE-7-FL	N/A	2018/11/15	2019/11/14
●	Test Software	Audix	E3	N/A	N/A	N/A

●	Turntable	Maturo Germany	TT2.0-1T	N/A	N/A	N/A
●	Antenna Mast	Maturo Germany	CAM-4.0-P-12	N/A	N/A	N/A

● RF Conducted Method

Used	Test Equipment	Manufacturer	Model No.	Serial No.	Last Cal. Date (YY-MM-DD)	Next Cal. Date (YY-MM-DD)
●	Signal and spectrum Analyzer	R&S	FSV40	100048	2018/10/28	2019/10/27
●	Spectrum Analyzer	Agilent	N9020A	MY50510187	2018/09/29	2019/09/28
○	Radio communication tester	R&S	CMW500	137688-Lv	2018/09/29	2019/09/28
○	Test software	Tonscend	JS1120-1(LTE)	N/A	N/A	N/A
○	Test software	Tonscend	JS1120-2(WIFI)	N/A	N/A	N/A
○	Test software	Tonscend	JS1120-3(WCDMA)	N/A	N/A	N/A
○	Test software	Tonscend	JS1120-4(GSM)	N/A	N/A	N/A

5. TEST CONDITIONS AND RESULTS

5.1. Antenna requirement

Requirement

FCC CFR Title 47 Part 15 Subpart C Section 15.203:

An intentional radiator shall be designed to ensure that no antenna other than that furnished by the responsible party shall be used with the device. The use of a permanently attached antenna or of an antenna that uses a unique coupling to the intentional radiator, the manufacturer may design the unit so that a broken antenna can be replaced by the user, but the use of a standard antenna jack or electrical connector is prohibited.

FCC CFR Title 47 Part 15 Subpart C Section 15.247(c) (1)(i):

(i) Systems operating in the 2400~2483.5 MHz band that is used exclusively for fixed. Point-to-point operations may employ transmitting antennas with directional gain greater than 6 dBi provided the maximum conducted output power of the intentional radiator is reduced by 1 dB for every 3 dB that the directional gain of the antenna exceeds 6 dBi.

Test Result:

Passed **Not Applicable**

The directional gain of the antenna less than 6 dBi, please refer to the below antenna photo.

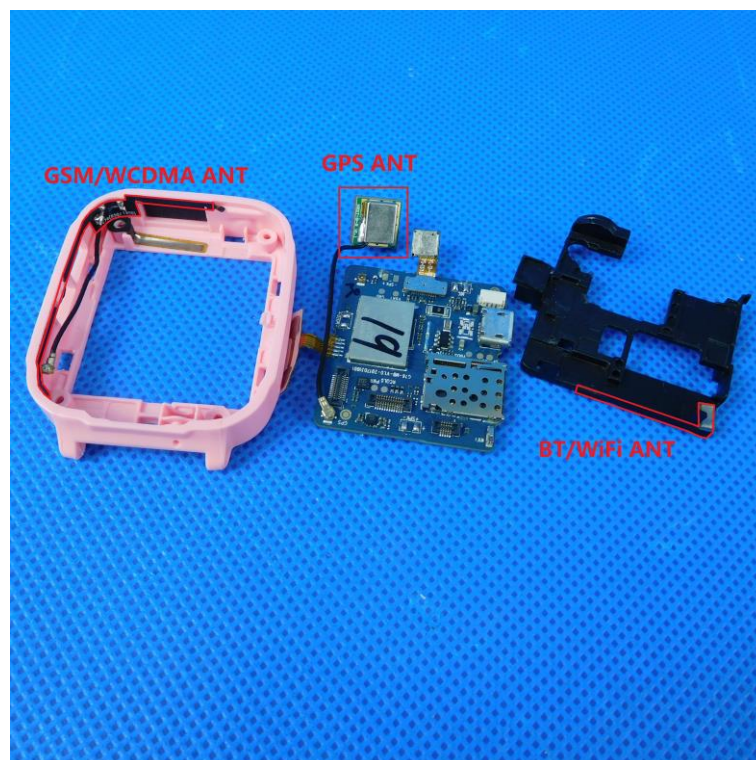

5.2. Conducted Emissions (AC Main)

LIMIT

FCC CFR Title 47 Part 15 Subpart C Section 15.207

Frequency range (MHz)	Limit (dBuV)	
	Quasi-peak	Average
0.15-0.5	66 to 56*	56 to 46*
0.5-5	56	46
5-30	60	50

* Decreases with the logarithm of the frequency.

TEST CONFIGURATION

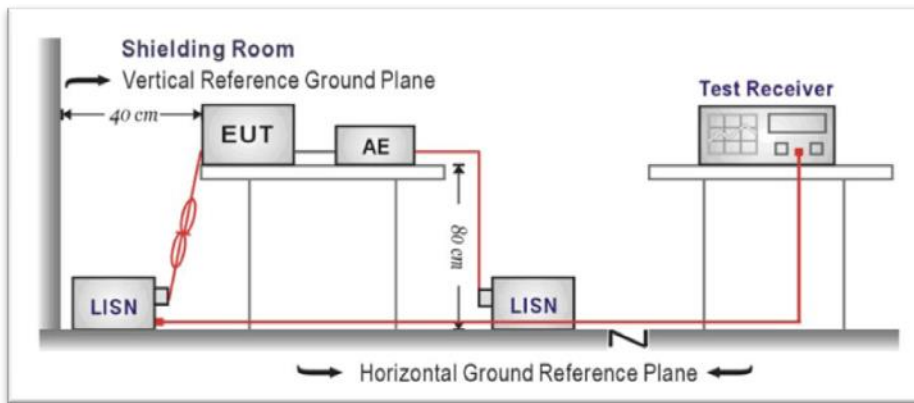

TEST PROCEDURE

1. The EUT was setup according to ANSI C63.10:2013 requirements.
2. The EUT was placed on a platform of nominal size, 1 m by 1.5 m, raised 80 cm above the conducting ground plane. The vertical conducting plane was located 40 cm to the rear of the EUT. All other surfaces of EUT were at least 80 cm from any other grounded conducting surface.
3. The EUT and simulators are connected to the main power through a line impedances stabilization network (LISN). The LISN provides a 50 ohm /50uH coupling impedance for the measuring equipment.
4. The peripheral devices are also connected to the main power through a LISN. (Please refer to the block diagram of the test setup and photographs)
5. Each current-carrying conductor of the EUT power cord, except the ground (safety) conductor, was individually connected through a LISN to the input power source.
6. The excess length of the power cord between the EUT and the LISN receptacle were folded back and forth at the center of the lead to form a bundle not exceeding 40 cm in length.
7. Conducted emissions were investigated over the frequency range from 0.15MHz to 30MHz using a receiver bandwidth of 9 kHz.
8. During the above scans, the emissions were maximized by cable manipulation.

TEST RESULTS

Passed Not Applicable

Note:

- 1) Transd= Cable lose + Pulse Limiter Factor + Artificial Mains Factor
- 2) Margin= Limit - Level

Test Line:

L

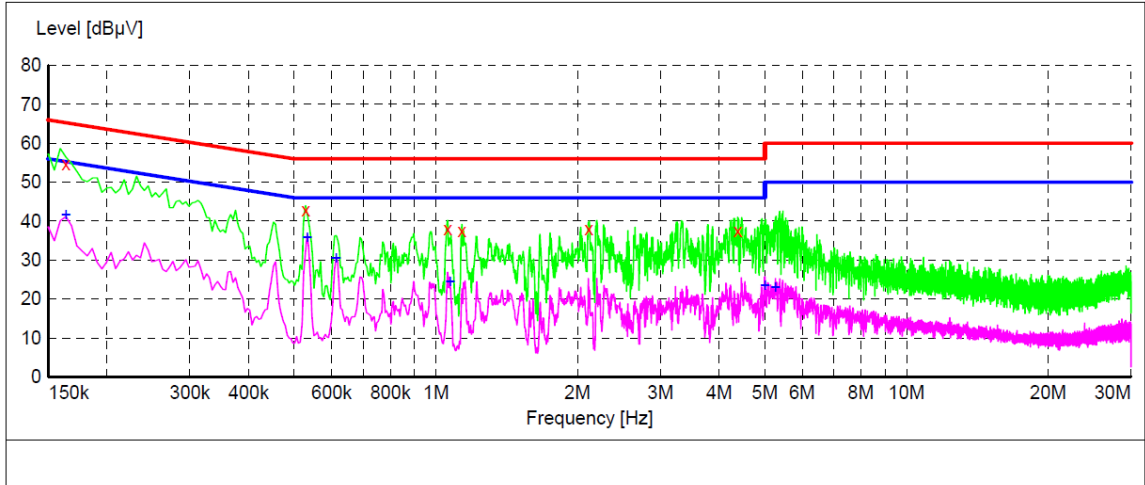

Frequency MHz	Level dBµV	Transd dB	Limit dBµV	Margin dB	Detector	Line	PE
0.163500	54.70	10.1	65	10.6	QP	L1	GND
0.528000	42.80	10.0	56	13.2	QP	L1	GND
1.059000	38.00	10.0	56	18.0	QP	L1	GND
1.135500	37.50	10.0	56	18.5	QP	L1	GND
2.112000	37.90	10.0	56	18.1	QP	L1	GND
4.375500	37.60	10.0	56	18.4	QP	L1	GND

Frequency MHz	Level dBµV	Transd dB	Limit dBµV	Margin dB	Detector	Line	PE
0.163500	41.60	10.1	55	13.7	AV	L1	GND
0.532500	35.90	10.0	46	10.1	AV	L1	GND
0.613500	30.50	10.0	46	15.5	AV	L1	GND
1.072500	24.50	10.0	46	21.5	AV	L1	GND
4.996500	23.50	10.0	46	22.5	AV	L1	GND
5.257500	23.10	10.0	50	26.9	AV	L1	GND

Test Line:

N

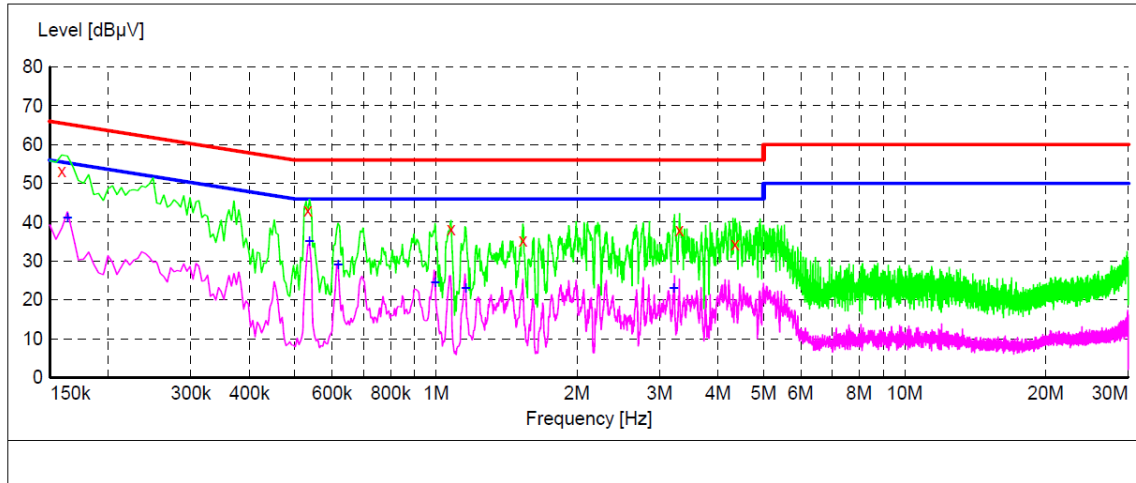

Frequency MHz	Level dBµV	Transd dB	Limit dBµV	Margin dB	Detector	Line	PE
0.159000	53.30	10.1	66	12.2	QP	N	GND
0.532500	43.20	10.0	56	12.8	QP	N	GND
1.077000	38.30	10.0	56	17.7	QP	N	GND
1.531500	35.30	10.0	56	20.7	QP	N	GND
3.304500	38.00	10.0	56	18.0	QP	N	GND
4.339500	34.40	10.0	56	21.6	QP	N	GND

Frequency MHz	Level dBµV	Transd dB	Limit dBµV	Margin dB	Detector	Line	PE
0.163500	41.00	10.1	55	14.3	AV	N	GND
0.537000	35.10	10.0	46	10.9	AV	N	GND
0.618000	28.90	10.0	46	17.1	AV	N	GND
0.996000	24.50	9.9	46	21.5	AV	N	GND
1.158000	22.90	10.0	46	23.1	AV	N	GND
3.219000	23.10	10.0	46	22.9	AV	N	GND

5.3. Conducted Peak Output Power

LIMIT

FCC CFR Title 47 Part 15 Subpart C Section 15.247 (b)(1):

For frequency hopping systems operating in the 2400-2483.5 MHz band employing at least 75 non-overlapping hopping channels, and all frequency hopping systems in the 5725-5850 MHz band: 1 watt.
 For all other frequency hopping systems in the 2400-2483.5 MHz band: 0.125 watts.

TEST CONFIGURATION

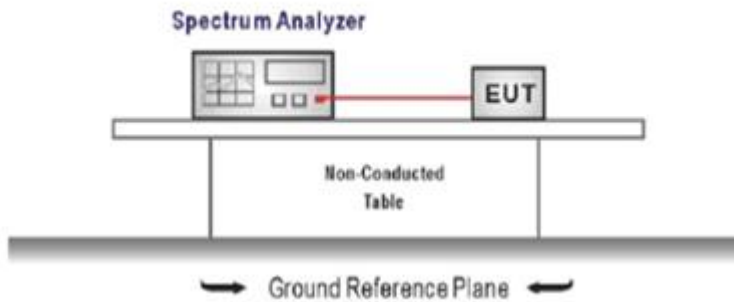

TEST PROCEDURE

1. The transmitter output was connected to the spectrum analyzer through an attenuator, the pathloss was compensated to the results for each measurement.
2. Set to the maximum power setting and enable the EUT transmit continuously
3. Use the following spectrum analyzer settings:
 Span = approximately 5 times the 20 dB bandwidth, centered on a hopping channel
 RBW ≥ the 20 dB bandwidth of the emission being measured, VBW ≥ RBW
 Sweep = auto, Detector function = peak, Trace = max hold
4. Measure and record the results in the test report.

TEST MODE:

Please refer to the clause 3.3

TEST RESULTS

Passed Not Applicable

Modulation type	Channel	Peak Output power (dBm)	Average Output power (dBm)	Limit (dBm)	Result
GFSK	00	-1.81	-1.83	≤ 30.00	Pass
	39	-2.21	-2.24		
	78	-2.38	-2.40		
π/4DQPSK	00	-1.98	-2.63	≤ 21.00	Pass
	39	-2.35	-2.89		
	78	-2.48	-3.01		
8DPSK	00	-1.96	-2.65	≤ 21.00	Pass
	39	-2.28	-2.89		
	78	-2.38	-3.04		

Modulation Type: GFSK	
CH00	<p>The spectrum plot for CH00 shows a GFSK signal centered at 2.402 GHz. The y-axis represents power in dBm, ranging from -70 to 10. The x-axis represents frequency in MHz, with a span of 5.0 MHz. The signal is a smooth curve peaking at -1.81 dBm. The plot includes parameters: Ref Level 20.00 dBm, Att 30 dB, Offset 1.00 dB, RBW 1 MHz, Mode Auto Sweep, Count 500/500, and Span 5.0 MHz. A peak marker M1[1] is visible at 2.40213020 GHz.</p>
CH39	<p>The spectrum plot for CH39 shows a GFSK signal centered at 2.441 GHz. The y-axis represents power in dBm, ranging from -70 to 10. The x-axis represents frequency in MHz, with a span of 5.0 MHz. The signal is a smooth curve peaking at -2.21 dBm. The plot includes parameters: Ref Level 20.00 dBm, Att 30 dB, Offset 1.00 dB, RBW 1 MHz, Mode Auto Sweep, Count 500/500, and Span 5.0 MHz. A peak marker M1[1] is visible at 2.44110850 GHz.</p>
CH78	<p>The spectrum plot for CH78 shows a GFSK signal centered at 2.48 GHz. The y-axis represents power in dBm, ranging from -70 to 10. The x-axis represents frequency in MHz, with a span of 5.0 MHz. The signal is a smooth curve peaking at -2.38 dBm. The plot includes parameters: Ref Level 20.00 dBm, Att 30 dB, Offset 1.00 dB, RBW 1 MHz, Mode Auto Sweep, Count 500/500, and Span 5.0 MHz. A peak marker M1[1] is visible at 2.47985530 GHz.</p>

Modulation Type: $\pi/4$ DQPSK	
CH00	<p>Spectrum</p> <p>Ref Level 20.00 dBm Offset 1.00 dB RBW 2 MHz Att 30 dB SWT 1 ms VBW 5 MHz Mode Auto Sweep Count 500/500 IPK View</p> <p>M1[1] -1.98 dBm 2.40213020 GHz</p> <p>CF 2.402 GHz 691 pts Span 5.0 MHz</p> <p>Date: 11 JUL 2019 19:46:06</p>
CH39	<p>Spectrum</p> <p>Ref Level 20.00 dBm Offset 1.00 dB RBW 2 MHz Att 30 dB SWT 1 ms VBW 5 MHz Mode Auto Sweep Count 500/500 IPK View</p> <p>M1[1] -2.35 dBm 2.44115920 GHz</p> <p>CF 2.441 GHz 691 pts Span 5.0 MHz</p> <p>Date: 11 JUL 2019 19:47:05</p>
CH78	<p>Spectrum</p> <p>Ref Level 20.00 dBm Offset 1.00 dB RBW 2 MHz Att 30 dB SWT 1 ms VBW 5 MHz Mode Auto Sweep Count 500/500 IPK View</p> <p>M1[1] -2.48 dBm 2.48015200 GHz</p> <p>CF 2.48 GHz 691 pts Span 5.0 MHz</p> <p>Date: 11 JUL 2019 19:49:00</p>

Modulation Type: 8DPSK	
CH00	<p>Spectrum</p> <p>Ref Level 20.00 dBm Offset 1.00 dB RBW 2 MHz Att 30 dB SWT 1 ms VBW 5 MHz Mode Auto Sweep Count 500/500</p> <p>IPK View</p> <p>M1[1] -1.96 dBm 2.40197110 GHz</p> <p>CF 2.402 GHz 691 pts Span 5.0 MHz</p> <p>Date: 11 JUL 2019 19:50:49</p>
CH39	<p>Spectrum</p> <p>Ref Level 20.00 dBm Offset 1.00 dB RBW 2 MHz Att 30 dB SWT 1 ms VBW 5 MHz Mode Auto Sweep Count 500/500</p> <p>IPK View</p> <p>M1[1] -2.28 dBm 2.44099280 GHz</p> <p>CF 2.441 GHz 691 pts Span 5.0 MHz</p> <p>Date: 11 JUL 2019 19:52:16</p>
CH78	<p>Spectrum</p> <p>Ref Level 20.00 dBm Offset 1.00 dB RBW 2 MHz Att 30 dB SWT 1 ms VBW 5 MHz Mode Auto Sweep Count 500/500</p> <p>IPK View</p> <p>M1[1] -2.38 dBm 2.48002890 GHz</p> <p>CF 2.48 GHz 691 pts Span 5.0 MHz</p> <p>Date: 11 JUL 2019 19:53:27</p>

5.4. 20 dB Bandwidth

LIMIT

N/A

TEST CONFIGURATION

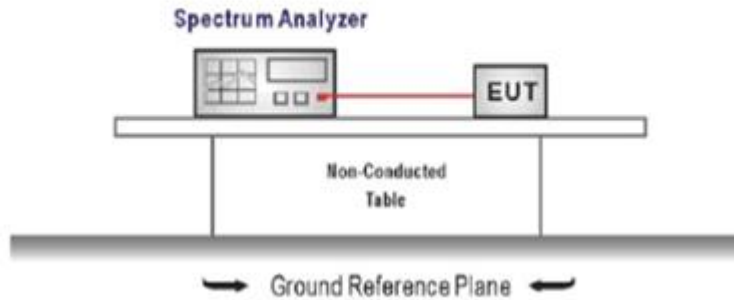

TEST PROCEDURE

1. The transmitter output was connected to the spectrum analyzer through an attenuator, the path loss was compensated to the results for each measurement.
2. Set to the maximum power setting and enable the EUT transmit continuously
3. Use the following spectrum analyzer settings:
Span = approximately 2 to 3 times the 20 dB bandwidth, centered on a hopping channel
RBW \geq 1% of the 20 dB bandwidth, VBW \geq RBW
Sweep = auto, Detector function = peak, Trace = max hold
4. Measure and record the results in the test report.

TEST MODE:

Please refer to the clause 3.3

TEST RESULTS

 Passed Not Applicable

Modulation type	Channel	20 dB Bandwidth (MHz)	Limit (MHz)	Result
GFSK	00	0.93	-	Pass
	39	0.93		
	78	0.93		
$\pi/4$ DQPSK	00	1.27	-	Pass
	39	1.28		
	78	1.28		
8DPSK	00	1.26	-	Pass
	39	1.27		
	78	1.27		

Modulation Type:		GFSK																												
CH00	<p>CF 2.402 GHz 1001 pts Span 2.5 MHz</p> <table border="1"> <thead> <tr> <th>Type</th> <th>Ref</th> <th>Trc</th> <th>X-value</th> <th>Y-value</th> <th>Function</th> <th>Function Result</th> </tr> </thead> <tbody> <tr> <td>M1</td> <td></td> <td>1</td> <td>2.4015475 GHz</td> <td>-28.18 dBm</td> <td></td> <td></td> </tr> <tr> <td>M2</td> <td></td> <td>1</td> <td>2.4020575 GHz</td> <td>-7.60 dBm</td> <td></td> <td></td> </tr> <tr> <td>D3</td> <td>M1</td> <td>1</td> <td>927.5 kHz</td> <td>-0.48 dB</td> <td></td> <td></td> </tr> </tbody> </table> <p>Date: 11 JUL 2019 19:41:00</p>		Type	Ref	Trc	X-value	Y-value	Function	Function Result	M1		1	2.4015475 GHz	-28.18 dBm			M2		1	2.4020575 GHz	-7.60 dBm			D3	M1	1	927.5 kHz	-0.48 dB		
Type	Ref	Trc	X-value	Y-value	Function	Function Result																								
M1		1	2.4015475 GHz	-28.18 dBm																										
M2		1	2.4020575 GHz	-7.60 dBm																										
D3	M1	1	927.5 kHz	-0.48 dB																										
CH39	<p>CF 2.441 GHz 1001 pts Span 2.5 MHz</p> <table border="1"> <thead> <tr> <th>Type</th> <th>Ref</th> <th>Trc</th> <th>X-value</th> <th>Y-value</th> <th>Function</th> <th>Function Result</th> </tr> </thead> <tbody> <tr> <td>M1</td> <td></td> <td>1</td> <td>2.4405475 GHz</td> <td>-28.71 dBm</td> <td></td> <td></td> </tr> <tr> <td>M2</td> <td></td> <td>1</td> <td>2.4410575 GHz</td> <td>-7.96 dBm</td> <td></td> <td></td> </tr> <tr> <td>D3</td> <td>M1</td> <td>1</td> <td>927.5 kHz</td> <td>-0.29 dB</td> <td></td> <td></td> </tr> </tbody> </table> <p>Date: 11 JUL 2019 19:43:24</p>		Type	Ref	Trc	X-value	Y-value	Function	Function Result	M1		1	2.4405475 GHz	-28.71 dBm			M2		1	2.4410575 GHz	-7.96 dBm			D3	M1	1	927.5 kHz	-0.29 dB		
Type	Ref	Trc	X-value	Y-value	Function	Function Result																								
M1		1	2.4405475 GHz	-28.71 dBm																										
M2		1	2.4410575 GHz	-7.96 dBm																										
D3	M1	1	927.5 kHz	-0.29 dB																										
CH78	<p>CF 2.48 GHz 1001 pts Span 2.5 MHz</p> <table border="1"> <thead> <tr> <th>Type</th> <th>Ref</th> <th>Trc</th> <th>X-value</th> <th>Y-value</th> <th>Function</th> <th>Function Result</th> </tr> </thead> <tbody> <tr> <td>M1</td> <td></td> <td>1</td> <td>2.4795475 GHz</td> <td>-28.89 dBm</td> <td></td> <td></td> </tr> <tr> <td>M2</td> <td></td> <td>1</td> <td>2.4800575 GHz</td> <td>-8.09 dBm</td> <td></td> <td></td> </tr> <tr> <td>D3</td> <td>M1</td> <td>1</td> <td>927.5 kHz</td> <td>-0.20 dB</td> <td></td> <td></td> </tr> </tbody> </table> <p>Date: 11 JUL 2019 19:44:05</p>		Type	Ref	Trc	X-value	Y-value	Function	Function Result	M1		1	2.4795475 GHz	-28.89 dBm			M2		1	2.4800575 GHz	-8.09 dBm			D3	M1	1	927.5 kHz	-0.20 dB		
Type	Ref	Trc	X-value	Y-value	Function	Function Result																								
M1		1	2.4795475 GHz	-28.89 dBm																										
M2		1	2.4800575 GHz	-8.09 dBm																										
D3	M1	1	927.5 kHz	-0.20 dB																										

Modulation Type:		$\pi/4$ DQPSK																																
CH00	<p>Spectrum Ref Level 20.00 dBm Offset 1.00 dB RBW 30 kHz Att 30 dB SWT 63.1 μs VBW 100 kHz Mode Auto FFT Count 500/500 IPK View</p> <p>CF 2.402 GHz 1001 pts Span 2.5 MHz</p> <table border="1"> <thead> <tr> <th>Marker</th> <th>Type</th> <th>Ref</th> <th>Trc</th> <th>X-value</th> <th>Y-value</th> <th>Function</th> <th>Function Result</th> </tr> </thead> <tbody> <tr> <td>M1</td> <td>M1</td> <td>1</td> <td>1</td> <td>2.4013725 GHz</td> <td>-24.66 dBm</td> <td></td> <td></td> </tr> <tr> <td>M2</td> <td>M1</td> <td>1</td> <td>1</td> <td>2.4021625 GHz</td> <td>-4.60 dBm</td> <td></td> <td></td> </tr> <tr> <td>D3</td> <td>M1</td> <td>1</td> <td>1</td> <td>1.2725 MHz</td> <td>-0.02 dB</td> <td></td> <td></td> </tr> </tbody> </table> <p>Date: 11 JUL 2019 19:46:06</p>		Marker	Type	Ref	Trc	X-value	Y-value	Function	Function Result	M1	M1	1	1	2.4013725 GHz	-24.66 dBm			M2	M1	1	1	2.4021625 GHz	-4.60 dBm			D3	M1	1	1	1.2725 MHz	-0.02 dB		
Marker	Type	Ref	Trc	X-value	Y-value	Function	Function Result																											
M1	M1	1	1	2.4013725 GHz	-24.66 dBm																													
M2	M1	1	1	2.4021625 GHz	-4.60 dBm																													
D3	M1	1	1	1.2725 MHz	-0.02 dB																													
CH39	<p>Spectrum Ref Level 20.00 dBm Offset 1.00 dB RBW 30 kHz Att 30 dB SWT 63.1 μs VBW 100 kHz Mode Auto FFT Count 500/500 IPK View</p> <p>CF 2.441 GHz 1001 pts Span 2.5 MHz</p> <table border="1"> <thead> <tr> <th>Marker</th> <th>Type</th> <th>Ref</th> <th>Trc</th> <th>X-value</th> <th>Y-value</th> <th>Function</th> <th>Function Result</th> </tr> </thead> <tbody> <tr> <td>M1</td> <td>M1</td> <td>1</td> <td>1</td> <td>2.4403700 GHz</td> <td>-25.45 dBm</td> <td></td> <td></td> </tr> <tr> <td>M2</td> <td>M1</td> <td>1</td> <td>1</td> <td>2.4411625 GHz</td> <td>-4.82 dBm</td> <td></td> <td></td> </tr> <tr> <td>D3</td> <td>M1</td> <td>1</td> <td>1</td> <td>1.2775 MHz</td> <td>0.46 dB</td> <td></td> <td></td> </tr> </tbody> </table> <p>Date: 11 JUL 2019 19:47:06</p>		Marker	Type	Ref	Trc	X-value	Y-value	Function	Function Result	M1	M1	1	1	2.4403700 GHz	-25.45 dBm			M2	M1	1	1	2.4411625 GHz	-4.82 dBm			D3	M1	1	1	1.2775 MHz	0.46 dB		
Marker	Type	Ref	Trc	X-value	Y-value	Function	Function Result																											
M1	M1	1	1	2.4403700 GHz	-25.45 dBm																													
M2	M1	1	1	2.4411625 GHz	-4.82 dBm																													
D3	M1	1	1	1.2775 MHz	0.46 dB																													
CH78	<p>Spectrum Ref Level 20.00 dBm Offset 1.00 dB RBW 30 kHz Att 30 dB SWT 63.1 μs VBW 100 kHz Mode Auto FFT Count 500/500 IPK View</p> <p>CF 2.48 GHz 1001 pts Span 2.5 MHz</p> <table border="1"> <thead> <tr> <th>Marker</th> <th>Type</th> <th>Ref</th> <th>Trc</th> <th>X-value</th> <th>Y-value</th> <th>Function</th> <th>Function Result</th> </tr> </thead> <tbody> <tr> <td>M1</td> <td>M1</td> <td>1</td> <td>1</td> <td>2.4793700 GHz</td> <td>-25.67 dBm</td> <td></td> <td></td> </tr> <tr> <td>M2</td> <td>M1</td> <td>1</td> <td>1</td> <td>2.4801625 GHz</td> <td>-4.97 dBm</td> <td></td> <td></td> </tr> <tr> <td>D3</td> <td>M1</td> <td>1</td> <td>1</td> <td>1.2775 MHz</td> <td>0.52 dB</td> <td></td> <td></td> </tr> </tbody> </table> <p>Date: 11 JUL 2019 19:49:00</p>		Marker	Type	Ref	Trc	X-value	Y-value	Function	Function Result	M1	M1	1	1	2.4793700 GHz	-25.67 dBm			M2	M1	1	1	2.4801625 GHz	-4.97 dBm			D3	M1	1	1	1.2775 MHz	0.52 dB		
Marker	Type	Ref	Trc	X-value	Y-value	Function	Function Result																											
M1	M1	1	1	2.4793700 GHz	-25.67 dBm																													
M2	M1	1	1	2.4801625 GHz	-4.97 dBm																													
D3	M1	1	1	1.2775 MHz	0.52 dB																													

Modulation Type:		8DPSK																												
CH00	<p>Ref Level 20.00 dBm Offset 1.00 dB RBW 30 kHz Att 30 dB SWT 63.1 μs VBW 100 kHz Mode Auto FFT Count 500/500 IPK View</p> <p>CF 2.402 GHz 1001 pts Span 2.5 MHz</p> <table border="1"> <thead> <tr> <th>Types</th> <th>Ref</th> <th>Trc</th> <th>X-value</th> <th>Y-value</th> <th>Function</th> <th>Function Result</th> </tr> </thead> <tbody> <tr> <td>M1</td> <td></td> <td>1</td> <td>2.40136 GHz</td> <td>-24.26 dBm</td> <td></td> <td></td> </tr> <tr> <td>M2</td> <td></td> <td>1</td> <td>2.40216 GHz</td> <td>-3.90 dBm</td> <td></td> <td></td> </tr> <tr> <td>D3</td> <td>M1</td> <td>1</td> <td>1.265 MHz</td> <td>0.28 dB</td> <td></td> <td></td> </tr> </tbody> </table> <p>Date: 11 JUL 2019 19:50:40</p>		Types	Ref	Trc	X-value	Y-value	Function	Function Result	M1		1	2.40136 GHz	-24.26 dBm			M2		1	2.40216 GHz	-3.90 dBm			D3	M1	1	1.265 MHz	0.28 dB		
Types	Ref	Trc	X-value	Y-value	Function	Function Result																								
M1		1	2.40136 GHz	-24.26 dBm																										
M2		1	2.40216 GHz	-3.90 dBm																										
D3	M1	1	1.265 MHz	0.28 dB																										
CH39	<p>Ref Level 20.00 dBm Offset 1.00 dB RBW 30 kHz Att 30 dB SWT 63.1 μs VBW 100 kHz Mode Auto FFT Count 500/500 IPK View</p> <p>CF 2.441 GHz 1001 pts Span 2.5 MHz</p> <table border="1"> <thead> <tr> <th>Types</th> <th>Ref</th> <th>Trc</th> <th>X-value</th> <th>Y-value</th> <th>Function</th> <th>Function Result</th> </tr> </thead> <tbody> <tr> <td>M1</td> <td></td> <td>1</td> <td>2.44036 GHz</td> <td>-24.25 dBm</td> <td></td> <td></td> </tr> <tr> <td>M2</td> <td></td> <td>1</td> <td>2.4411625 GHz</td> <td>-4.13 dBm</td> <td></td> <td></td> </tr> <tr> <td>D3</td> <td>M1</td> <td>1</td> <td>1.27 MHz</td> <td>0.03 dB</td> <td></td> <td></td> </tr> </tbody> </table> <p>Date: 11 JUL 2019 19:52:07</p>		Types	Ref	Trc	X-value	Y-value	Function	Function Result	M1		1	2.44036 GHz	-24.25 dBm			M2		1	2.4411625 GHz	-4.13 dBm			D3	M1	1	1.27 MHz	0.03 dB		
Types	Ref	Trc	X-value	Y-value	Function	Function Result																								
M1		1	2.44036 GHz	-24.25 dBm																										
M2		1	2.4411625 GHz	-4.13 dBm																										
D3	M1	1	1.27 MHz	0.03 dB																										
CH78	<p>Ref Level 20.00 dBm Offset 1.00 dB RBW 30 kHz Att 30 dB SWT 63.1 μs VBW 100 kHz Mode Auto FFT Count 500/500 IPK View</p> <p>CF 2.48 GHz 1001 pts Span 2.5 MHz</p> <table border="1"> <thead> <tr> <th>Types</th> <th>Ref</th> <th>Trc</th> <th>X-value</th> <th>Y-value</th> <th>Function</th> <th>Function Result</th> </tr> </thead> <tbody> <tr> <td>M1</td> <td></td> <td>1</td> <td>2.47836 GHz</td> <td>-24.37 dBm</td> <td></td> <td></td> </tr> <tr> <td>M2</td> <td></td> <td>1</td> <td>2.48016 GHz</td> <td>-4.22 dBm</td> <td></td> <td></td> </tr> <tr> <td>D3</td> <td>M1</td> <td>1</td> <td>1.27 MHz</td> <td>0.10 dB</td> <td></td> <td></td> </tr> </tbody> </table> <p>Date: 11 JUL 2019 19:53:17</p>		Types	Ref	Trc	X-value	Y-value	Function	Function Result	M1		1	2.47836 GHz	-24.37 dBm			M2		1	2.48016 GHz	-4.22 dBm			D3	M1	1	1.27 MHz	0.10 dB		
Types	Ref	Trc	X-value	Y-value	Function	Function Result																								
M1		1	2.47836 GHz	-24.37 dBm																										
M2		1	2.48016 GHz	-4.22 dBm																										
D3	M1	1	1.27 MHz	0.10 dB																										

5.5. Carrier Frequencies Separation

LIMIT

FCC CFR Title 47 Part 15 Subpart C Section 15.247 (a)(1):
 Frequency hopping systems shall have hopping channel carrier frequencies separated by a minimum of 25 kHz or the 20 dB bandwidth of the hopping channel, whichever is greater. Alternatively, Frequency hopping systems operating in the 2400-2483.5 MHz band may have hopping channel carrier frequencies that are separated by 25 kHz or two-thirds of the 20 dB bandwidth of the hopping channel, whichever is greater, provided the systems operate with an output power no greater than 125 mW.

TEST CONFIGURATION

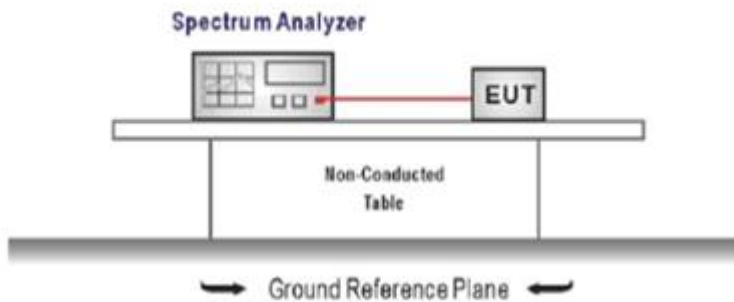

TEST PROCEDURE

1. The transmitter output was connected to the spectrum analyzer through an attenuator, the path loss was compensated to the results for each measurement.
2. Set to the maximum power setting and enable the EUT transmit continuously
3. Use the following spectrum analyzer settings:
 Span = wide enough to capture the peaks of two adjacent channels
 RBW ≥ 1% of the span, VBW ≥ RBW
 Sweep = auto, Detector function = peak, Trace = max hold
4. Measure and record the results in the test report.

TEST MODE:

Please refer to the clause 3.3

TEST RESULTS

Passed Not Applicable

Modulation type	Channel	Carrier Frequencies Separation (MHz)	Limit (MHz) *	Result
GFSK	39	1.00	≥0.93	Pass
π/4DQPSK	39	1.00	≥0.85	Pass
8DPSK	39	1.00	≥0.85	Pass

Note:

- *: GFSK limit = The maximum 20 dB Bandwidth for GFSK modulation on the section 5.4.
- π/4DQPSK limit = 2/3 * The maximum 20 dB Bandwidth for π/4DQPSK modulation on the section 5.4.
- 8DPSK limit = 2/3 * The maximum 20 dB Bandwidth for 8DPSK modulation on the section 5.4

GFSK

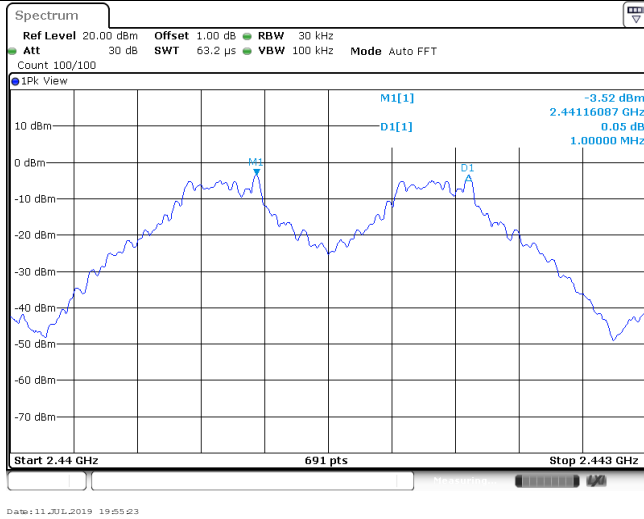

$\pi/4$ DQPSK

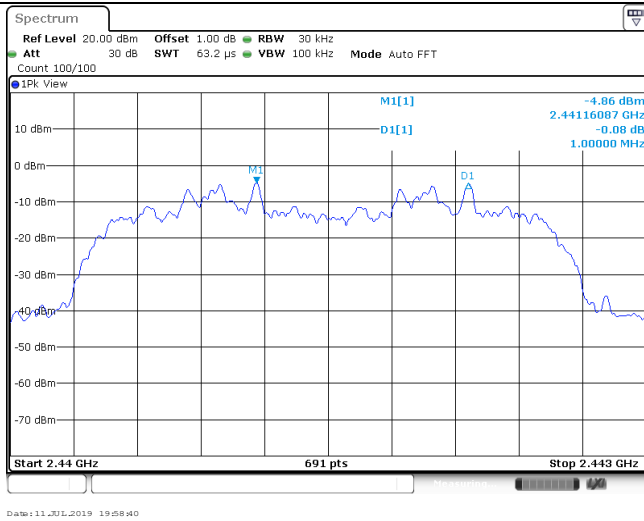

8DPSK

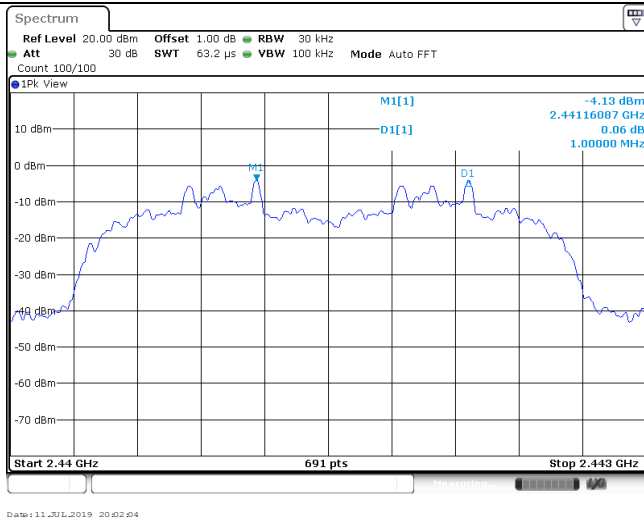

5.6. Hopping Channel Number

LIMIT

FCC CFR Title 47 Part 15 Subpart C Section 15.247 (a)(1):Frequency hopping systems in the 2400–2483.5 MHz band shall use at least **15** channels.

TEST CONFIGURATION

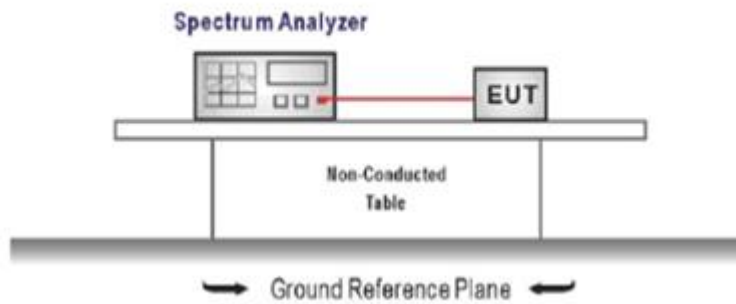

TEST PROCEDURE

1. The transmitter output was connected to the spectrum analyzer through an attenuator, the path loss was compensated to the results for each measurement.
2. Set to the maximum power setting and enable the EUT transmit continuously
3. Use the following spectrum analyzer settings:
 Span = the frequency band of operation
 RBW ≥ 1% of the span, VBW ≥ RBW
 Sweep = auto, Detector function = peak, Trace = max hold
4. Measure and record the results in the test report.

TEST MODE:

Please refer to the clause 3.3

TEST RESULTS

Passed Not Applicable

Modulation type	Channel number	Limit	Result
GFSK	79	≥15.00	Pass
π/4DQPSK	79		
8DPSK	79		

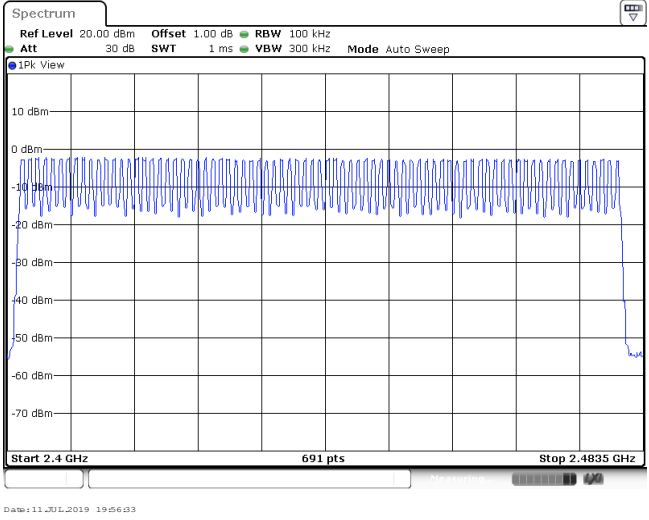
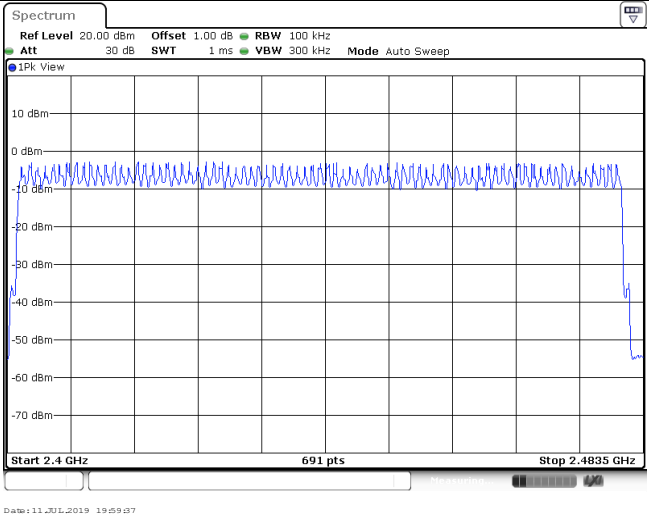
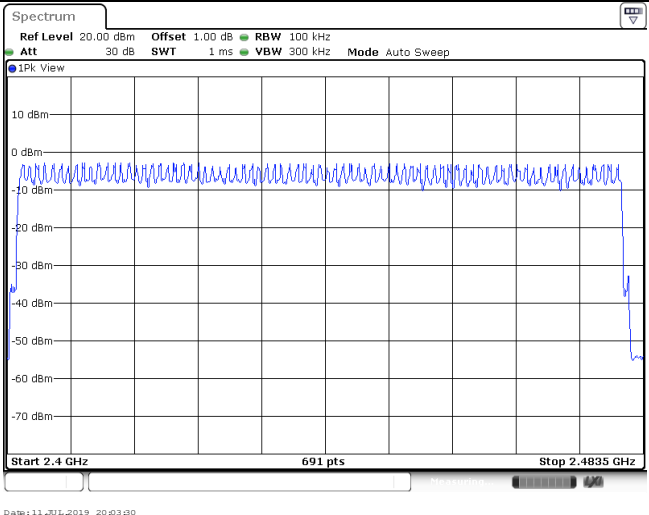
<p>GFSK</p>	
<p>$\pi/4$DQPSK</p>	
<p>8DPSK</p>	

5.7. Dwell Time

LIMIT

FCC CFR Title 47 Part 15 Subpart C Section 15.247 (a)(1):The average time of occupancy on any channel shall not be greater than 0.4 seconds within a pe-riod of 0.4 seconds multiplied by the number of hopping channels employed.

TEST CONFIGURATION

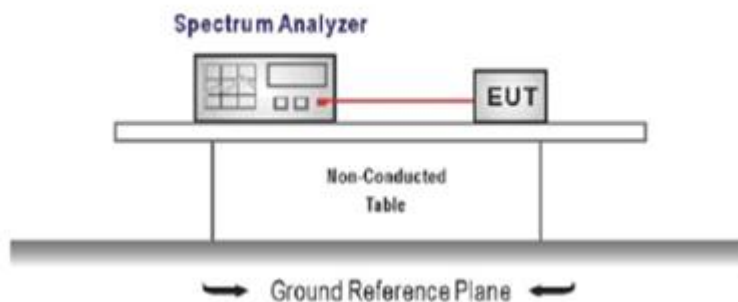

TEST PROCEDURE

1. The transmitter output was connected to the spectrum analyzer through an attenuator, the path loss was compensated to the results for each measurement.
2. Set to the maximum power setting and enable the EUT transmit continuously
3. Use the following spectrum analyzer settings:
 Span = zero span, centered on a hopping channel, RBW= 1 MHz, VBW ≥ RBW
 Sweep = as necessary to capture the entire dwell time per hopping channel,
 Detector function = peak, Trace = max hold
4. Measure and record the results in the test report.

TEST MODE:

Please refer to the clause 3.3

TEST RESULTS

Passed Not Applicable

Modulation type	Channel	Burst Width [ms/hop/ch]	Total Hops[hop*ch]	Dwell time (Second)	Limit (Second)	Result
GFSK	DH1	0.37	317.00	0.12	≤ 0.40	Pass
	DH3	1.63	108.00	0.18		
	DH5	2.87	61.00	0.18		
π/4DQPSK	2DH1	0.38	316.00	0.12	≤ 0.40	Pass
	2DH3	1.63	113.00	0.18		
	2DH5	2.88	67.00	0.19		
8DPSK	3DH1	0.38	319.00	0.12	≤ 0.40	Pass
	3DH3	1.63	99.00	0.16		
	3DH5	2.88	72.00	0.21		

Modulation Type: GFSK	
DH1 Burst width	
DH1 Burst number	
DH3 Burst width	

DH3
Burst number

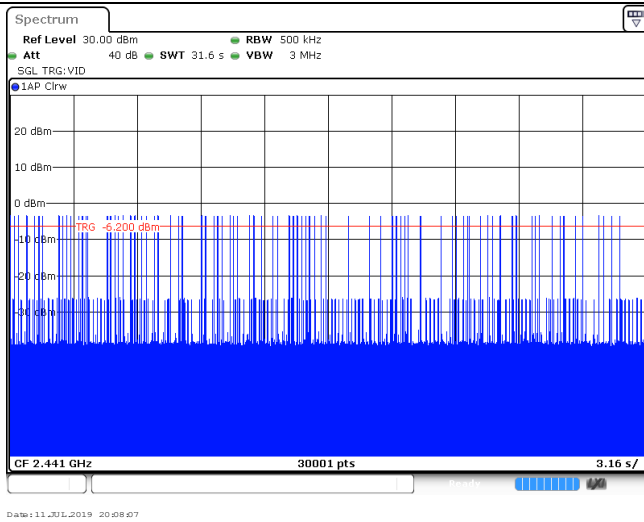

DH5
Burst width

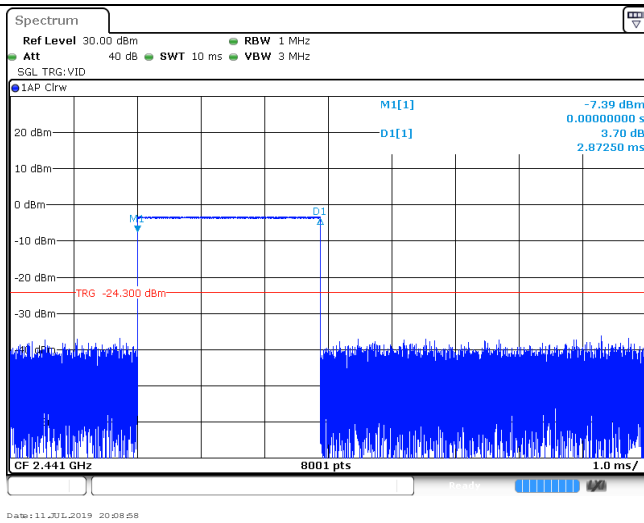

DH5
Burst number

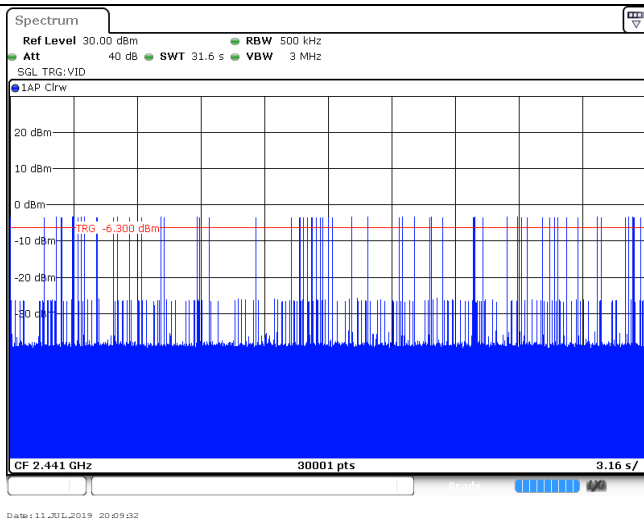

Modulation Type:		$\pi/4$ DQPSK
2DH1 Burst width	<p> Spectrum Ref Level 30.00 dBm RBW 1 MHz Att 40 dB SWT 10 ms VBW 3 MHz SGL TRG:VID IAP Cirw M1[1] -17.03 dBm D1[1] 0.0000000 s TRG -24.800 dBm -2.62 dB 376.25 ps CF 2.441 GHz 8001 pts 1.0 ms/ </p> <p>Date: 11 JUL 2019 20:00:09</p>	
2DH1 Burst number	<p> Spectrum Ref Level 30.00 dBm RBW 500 kHz Att 40 dB SWT 31.6 s VBW 3 MHz SGL TRG:VID IAP Cirw TRG -6.900 dBm CF 2.441 GHz 30001 pts 3.16 s/ </p> <p>Date: 11 JUL 2019 20:00:43</p>	
2DH3 Burst width	<p> Spectrum Ref Level 30.00 dBm RBW 1 MHz Att 40 dB SWT 10 ms VBW 3 MHz SGL TRG:VID IAP Cirw M1[1] -24.32 dBm D1[1] 0.0000000 s TRG -24.800 dBm 10.31 dB 1.62875 ms CF 2.441 GHz 8001 pts 1.0 ms/ </p> <p>Date: 11 JUL 2019 20:01:08</p>	

2DH3
Burst number

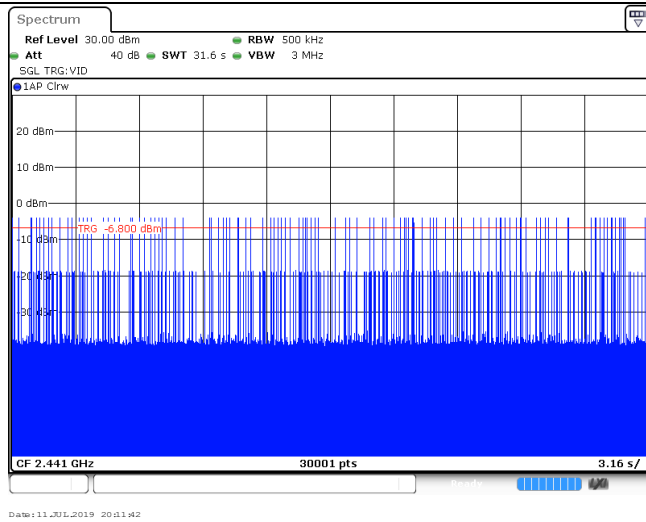

2DH5
Burst width

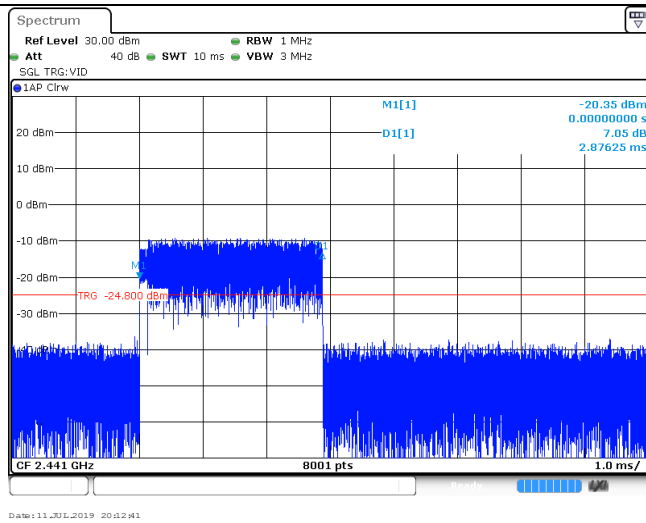

2DH5
Burst number

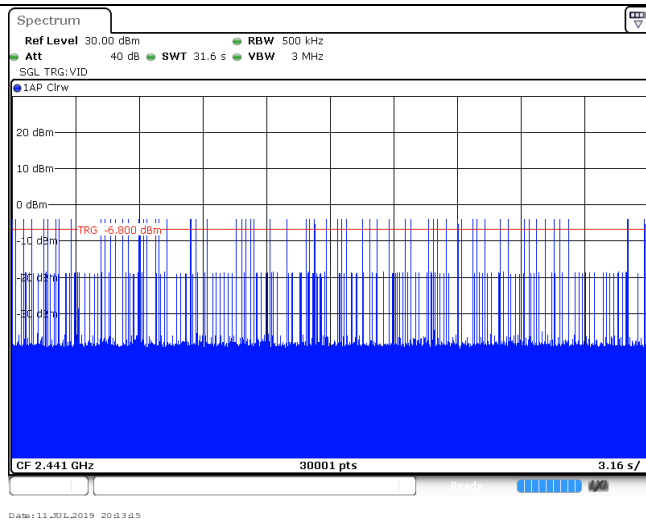

Modulation Type: $\pi/4$ DQPSK	
3DH1 Burst width	<p>Spectrum Ref Level 30.00 dBm Att 40 dB RBW 1 MHz SWT 10 ms VBW 3 MHz SGL TRG:VID IAP Cirw M1[1] -9.95 dBm D1[1] 0.0000000 s 5.17 dB 377.50 ps TRG -21.600 dBm CF 2.441 GHz 8001 pts 1.0 ms/ Date: 11 JUL 2019 20:03:53</p>
3DH1 Burst number	<p>Spectrum Ref Level 30.00 dBm Att 40 dB RBW 500 kHz SWT 31.6 s VBW 3 MHz SGL TRG:VID IAP Cirw TRG -5.600 dBm CF 2.441 GHz 30001 pts 3.16 s/ Date: 11 JUL 2019 20:04:27</p>
3DH3 Burst width	<p>Spectrum Ref Level 30.00 dBm Att 40 dB RBW 1 MHz SWT 10 ms VBW 3 MHz SGL TRG:VID IAP Cirw M1[1] -19.07 dBm D1[1] 0.0000000 s 5.37 dB 1.62750 ms TRG -24.600 dBm CF 2.441 GHz 8001 pts 1.0 ms/ Date: 11 JUL 2019 20:05:05</p>

3DH3
Burst number

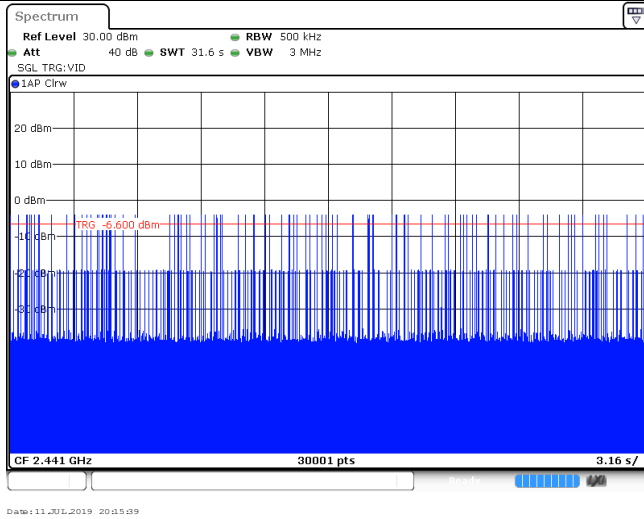

Date: 11 JUL 2019 20:15:59

3DH5
Burst width

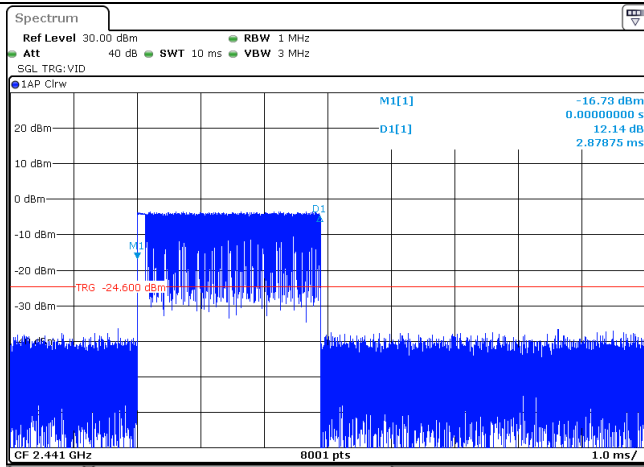

Date: 11 JUL 2019 20:26:31

3DH5
Burst number

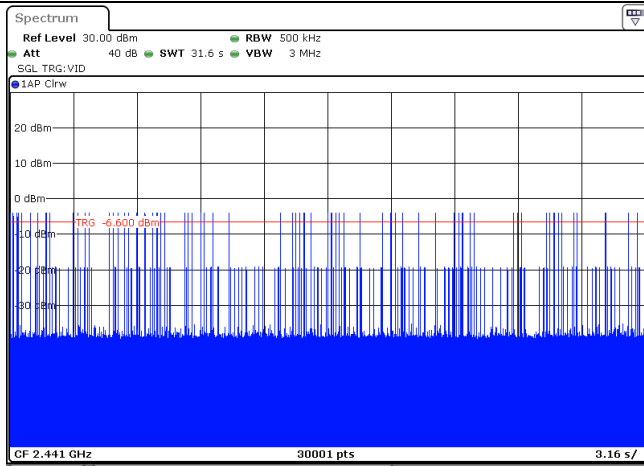

Date: 11 JUL 2019 20:27:06

5.8. Pseudorandom Frequency Hopping Sequence

LIMIT

FCC CFR Title 47 Part 15 Subpart C Section 15.247 (a)(1):Frequency hopping systems shall have hopping channel carrier frequencies separated by a minimum of 25 kHz or the 20 dB bandwidth of the hopping channel, whichever is greater. Alternatively, frequency hopping systems operating in the 2400–2483.5 MHz band may have hopping channel carrier frequencies that are separated by 25 kHz or two-thirds of the 20 dB bandwidth of the hopping channel, whichever is greater, provided the systems operate with an output power no greater than 125 mW. The system shall hop to channel frequencies that are selected at the system hopping rate from a pseudo-randomly ordered list of hopping frequencies. Each frequency must be used equally on the average by each transmitter. The system receivers shall have input bandwidths that match the hopping channel bandwidths of their corresponding transmitters and shall shift frequencies in synchronization with the transmitted signals.

TEST RESULTS

The pseudorandom frequency hopping sequence may be generated in a nine-stage shift register whose 5th and 9th stage outputs are added in a modulo-two addition stage. And the result is fed back to the input of the first stage. The sequence begins with the first one of 9 consecutive ones, for example: the shift register is initialized with nine ones.

- Number of shift register stages: 9
- Length of pseudo-random sequence: $2^9 - 1 = 511$ bits
- Longest sequence of zeros: 8 (non-inverted signal)

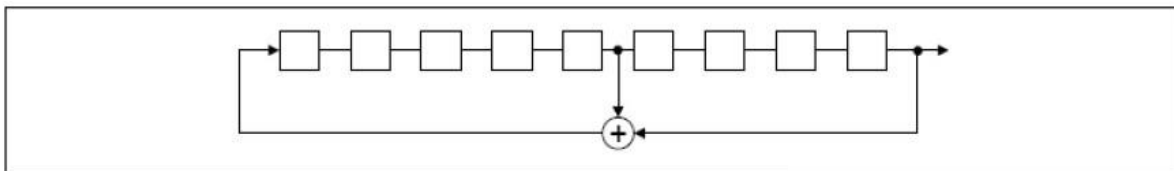

Linear Feedback Shift Register for Generation of the PRBS sequence

An example of pseudorandom frequency hopping sequence as follows:

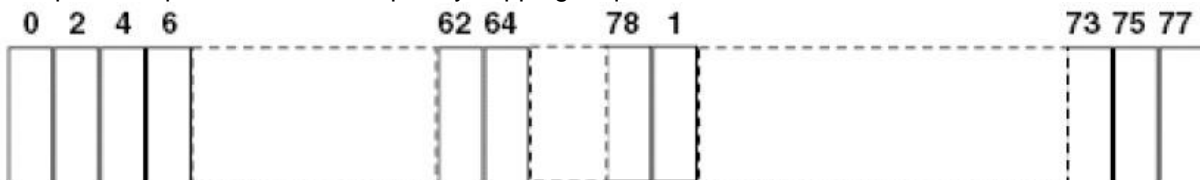

Each frequency used equally on the average by each transmitter. The system receiver has input bandwidths that match the hopping channel bandwidths of their corresponding transmitter and shift frequencies in synchronization with the transmitted signals.

5.9. Restricted band (radiated)

LIMIT

FCC CFR Title 47 Part 15 Subpart C Section 15.247 (d):

In any 100 kHz bandwidth outside the frequency band in which the spread spectrum or digitally modulated intentional radiator is operating, Radiated Emissions which fall in the restricted bands, as defined in §15.205(a), must also comply with the Radiated Emissions limits specified in §15.209(a) (see §15.205(c)).

TEST CONFIGURATION

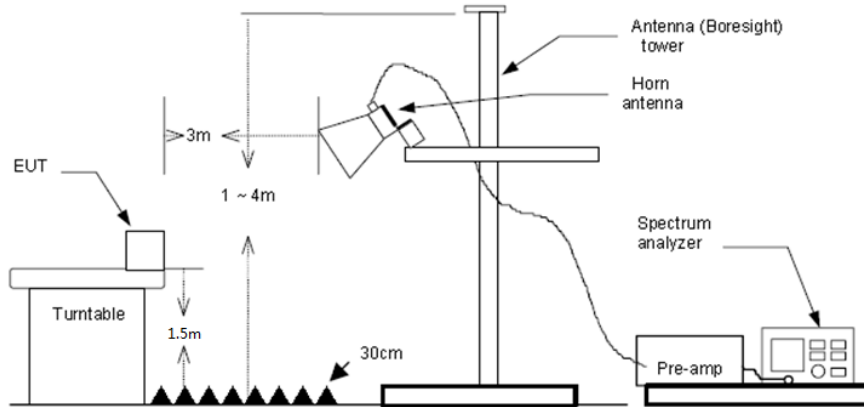

TEST PROCEDURE

1. The EUT was setup and tested according to ANSI C63.10:2013 for compliance to FCC 47CFR 15.247 requirements.
2. The EUT is placed on a turn table which is 1.5 meter above ground. The turn table is rotated 360 degrees to determine the position of the maximum emission level.
3. The EUT was positioned such that the distance from antenna to the EUT was 3 meters.
4. The antenna is scanned from 1 meter to 4 meters to find out the maximum emission level. This is repeated for both horizontal and vertical polarization of the antenna. In order to find the maximum emission, all of the interface cables were manipulated according to ANSI C63.10:2013 on radiated measurement.
5. The receiver set as follow:
 RBW=1 MHz, VBW=3 MHz Peak detector for Peak value
 RBW=1 MHz, VBW=10 Hz Peak detector for Average value.

TEST MODE:

Please refer to the clause 3.3

TEST RESULTS

Passed Not Applicable

Note:

- 1) Final level= Read level + Factor
- 2) Have pre-scan all modulation mode, found the GFSK modulation which it was worst case, so only the worst case's data on the test report.
- 3) The peak level is lower than average limit(54 dBuV/m), this data is the too weak instrument of signal is unable to test.

Test channel:				CH00			
Frequency (MHz)	Read Level (dBuV)	Factor (dB/m)	Level (dBuV/m)	Limit Line (dBuV/m)	Margin (dB)	Polarization	Test value
2310.00	52.43	-2.34	50.09	74.00	23.91	Horizontal	Peak
2390.00	51.87	-2.41	49.46	74.00	24.54	Horizontal	Peak
2310.00	52.46	-2.34	50.12	74.00	23.88	Vertical	Peak
2390.00	53.72	-2.41	51.31	74.00	22.69	Vertical	Peak
2310.00	42.29	-2.34	39.95	54.00	14.05	Horizontal	Average
2390.00	41.85	-2.41	39.44	54.00	14.56	Horizontal	Average
2310.00	42.28	-2.34	39.94	54.00	14.06	Vertical	Average
2390.00	41.86	-2.41	39.45	54.00	14.55	Vertical	Average

Test channel:				CH78			
Frequency (MHz)	Read Level (dBuV)	Factor (dB/m)	Level (dBuV/m)	Limit Line (dBuV/m)	Margin (dB)	Polarization	Test value
2483.50	54.04	-2.15	51.89	74.00	22.11	Horizontal	Peak
2500.00	53.31	-2.10	51.21	74.00	22.79	Horizontal	Peak
2483.50	52.52	-2.15	50.37	74.00	23.63	Vertical	Peak
2500.00	52.21	-2.10	50.11	74.00	23.89	Vertical	Peak
2483.50	42.74	-2.15	40.59	54.00	13.41	Horizontal	Average
2500.00	42.21	-2.10	40.11	54.00	13.89	Horizontal	Average
2483.50	43.54	-2.15	41.39	54.00	12.61	Vertical	Average
2500.00	42.15	-2.10	40.05	54.00	13.95	Vertical	Average

5.10. Band edge and Spurious Emissions (conducted)

LIMIT

FCC CFR Title 47 Part 15 Subpart C Section 15.247 (d): In any 100 kHz bandwidth outside the frequency band in which the spread spectrum intentional radiator is operating, the radio frequency power that is produced by the intentional radiator shall be at least 20 dB below that in the 100 kHz bandwidth within the band that contains the highest level of the desired power, based on either an RF conducted or a radiated measurement.

TEST CONFIGURATION

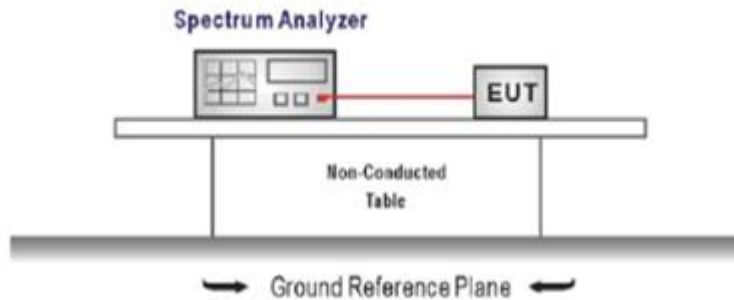

TEST PROCEDURE

1. The transmitter output was connected to the spectrum analyzer through an attenuator, the path loss was compensated to the results for each measurement.
2. Set to the maximum power setting and enable the EUT transmit continuously
3. Use the following spectrum analyzer settings:
RBW = 100 kHz, VBW \geq RBW, scan up through 10th harmonic.
Sweep = auto, Detector function = peak, Trace = max hold
4. Measure and record the results in the test report.

TEST MODE:

Please refer to the clause 3.3

TEST RESULTS

Passed Not Applicable

Test Item:	Band edge	Modulation type:	GFSK																																																
<p>CH00 No hopping mode</p>			<table border="1"> <thead> <tr> <th>Marker</th> <th>Type</th> <th>Ref</th> <th>Trc</th> <th>X-value</th> <th>Y-value</th> <th>Function</th> <th>Function Result</th> </tr> </thead> <tbody> <tr> <td>M1</td> <td>1</td> <td></td> <td></td> <td>2.40218 GHz</td> <td>-2.30 dBm</td> <td></td> <td></td> </tr> <tr> <td>M2</td> <td>1</td> <td></td> <td></td> <td>2.4 GHz</td> <td>-56.03 dBm</td> <td></td> <td></td> </tr> <tr> <td>M3</td> <td>1</td> <td></td> <td></td> <td>2.39 GHz</td> <td>-55.71 dBm</td> <td></td> <td></td> </tr> <tr> <td>M4</td> <td>1</td> <td></td> <td></td> <td>2.31 GHz</td> <td>-54.92 dBm</td> <td></td> <td></td> </tr> <tr> <td>M5</td> <td>1</td> <td></td> <td></td> <td>2.395225 GHz</td> <td>-53.52 dBm</td> <td></td> <td></td> </tr> </tbody> </table>	Marker	Type	Ref	Trc	X-value	Y-value	Function	Function Result	M1	1			2.40218 GHz	-2.30 dBm			M2	1			2.4 GHz	-56.03 dBm			M3	1			2.39 GHz	-55.71 dBm			M4	1			2.31 GHz	-54.92 dBm			M5	1			2.395225 GHz	-53.52 dBm		
Marker	Type	Ref	Trc	X-value	Y-value	Function	Function Result																																												
M1	1			2.40218 GHz	-2.30 dBm																																														
M2	1			2.4 GHz	-56.03 dBm																																														
M3	1			2.39 GHz	-55.71 dBm																																														
M4	1			2.31 GHz	-54.92 dBm																																														
M5	1			2.395225 GHz	-53.52 dBm																																														
<p>CH00 Hopping mode</p>			<table border="1"> <thead> <tr> <th>Marker</th> <th>Type</th> <th>Ref</th> <th>Trc</th> <th>X-value</th> <th>Y-value</th> <th>Function</th> <th>Function Result</th> </tr> </thead> <tbody> <tr> <td>M1</td> <td>1</td> <td></td> <td></td> <td>2.40204 GHz</td> <td>-2.85 dBm</td> <td></td> <td></td> </tr> <tr> <td>M2</td> <td>1</td> <td></td> <td></td> <td>2.4 GHz</td> <td>-55.84 dBm</td> <td></td> <td></td> </tr> <tr> <td>M3</td> <td>1</td> <td></td> <td></td> <td>2.39 GHz</td> <td>-55.71 dBm</td> <td></td> <td></td> </tr> <tr> <td>M4</td> <td>1</td> <td></td> <td></td> <td>2.31 GHz</td> <td>-55.60 dBm</td> <td></td> <td></td> </tr> <tr> <td>M5</td> <td>1</td> <td></td> <td></td> <td>2.325007 GHz</td> <td>-53.71 dBm</td> <td></td> <td></td> </tr> </tbody> </table>	Marker	Type	Ref	Trc	X-value	Y-value	Function	Function Result	M1	1			2.40204 GHz	-2.85 dBm			M2	1			2.4 GHz	-55.84 dBm			M3	1			2.39 GHz	-55.71 dBm			M4	1			2.31 GHz	-55.60 dBm			M5	1			2.325007 GHz	-53.71 dBm		
Marker	Type	Ref	Trc	X-value	Y-value	Function	Function Result																																												
M1	1			2.40204 GHz	-2.85 dBm																																														
M2	1			2.4 GHz	-55.84 dBm																																														
M3	1			2.39 GHz	-55.71 dBm																																														
M4	1			2.31 GHz	-55.60 dBm																																														
M5	1			2.325007 GHz	-53.71 dBm																																														
<p>CH78 No hopping mode</p>			<table border="1"> <thead> <tr> <th>Marker</th> <th>Type</th> <th>Ref</th> <th>Trc</th> <th>X-value</th> <th>Y-value</th> <th>Function</th> <th>Function Result</th> </tr> </thead> <tbody> <tr> <td>M1</td> <td>1</td> <td></td> <td></td> <td>2.479631 GHz</td> <td>-2.50 dBm</td> <td></td> <td></td> </tr> <tr> <td>M2</td> <td>1</td> <td></td> <td></td> <td>2.4835 GHz</td> <td>-58.39 dBm</td> <td></td> <td></td> </tr> <tr> <td>M3</td> <td>1</td> <td></td> <td></td> <td>2.5 GHz</td> <td>-60.02 dBm</td> <td></td> <td></td> </tr> <tr> <td>M4</td> <td>1</td> <td></td> <td></td> <td>2.4963971 GHz</td> <td>-57.83 dBm</td> <td></td> <td></td> </tr> </tbody> </table>	Marker	Type	Ref	Trc	X-value	Y-value	Function	Function Result	M1	1			2.479631 GHz	-2.50 dBm			M2	1			2.4835 GHz	-58.39 dBm			M3	1			2.5 GHz	-60.02 dBm			M4	1			2.4963971 GHz	-57.83 dBm										
Marker	Type	Ref	Trc	X-value	Y-value	Function	Function Result																																												
M1	1			2.479631 GHz	-2.50 dBm																																														
M2	1			2.4835 GHz	-58.39 dBm																																														
M3	1			2.5 GHz	-60.02 dBm																																														
M4	1			2.4963971 GHz	-57.83 dBm																																														

CH78
Hopping mode

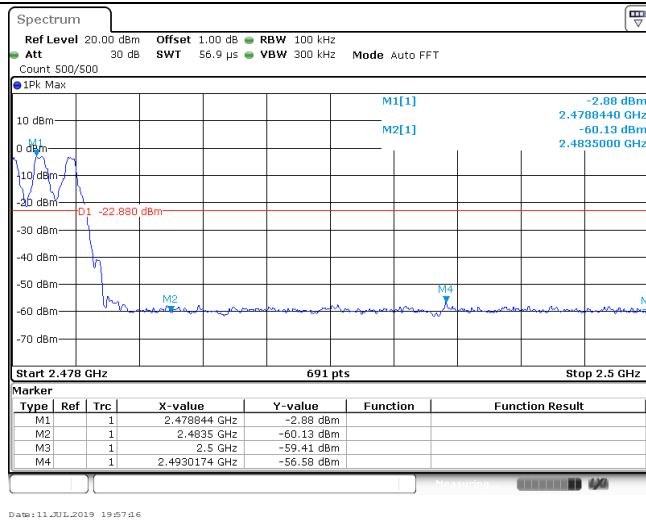

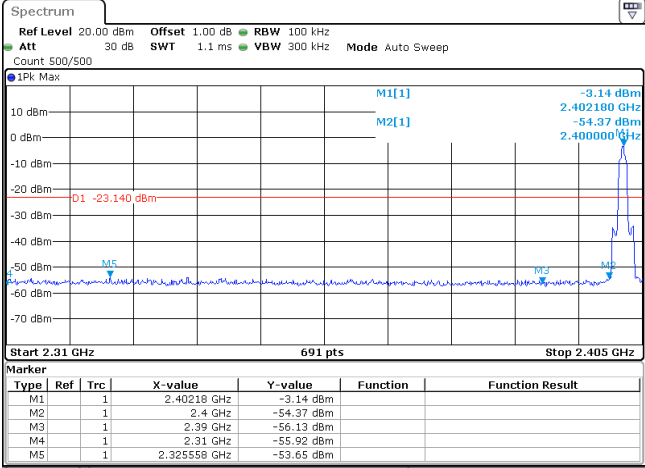
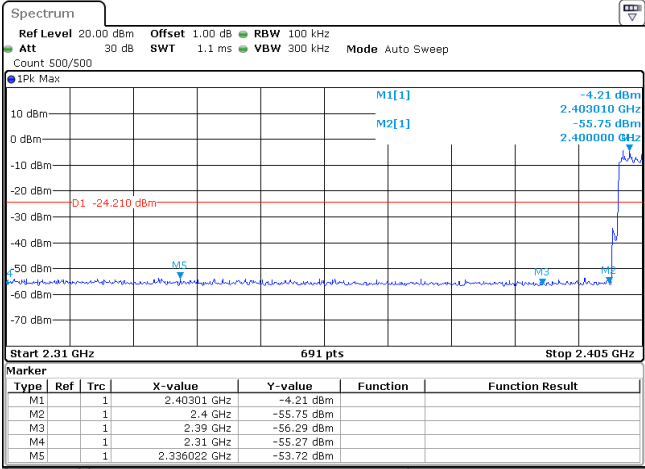
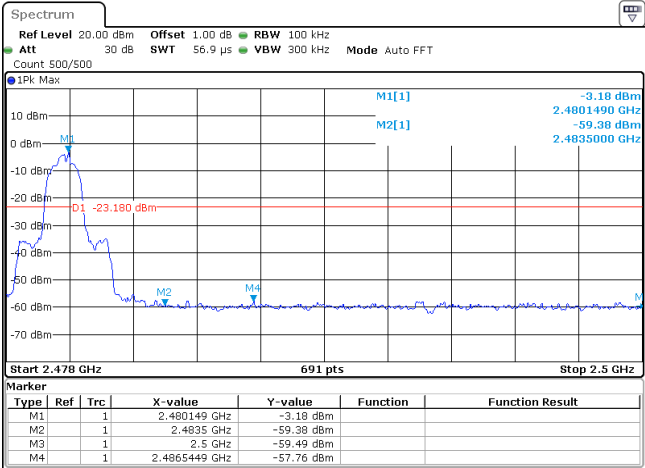
Test Item:	Band edge	Modulation type:	$\pi/4$ DQPSK																																																
<p>CH00 No hopping mode</p>	 <table border="1" data-bbox="687 593 1334 696"> <thead> <tr> <th>Marker</th> <th>Type</th> <th>Ref</th> <th>Trc</th> <th>X-value</th> <th>Y-value</th> <th>Function</th> <th>Function Result</th> </tr> </thead> <tbody> <tr> <td>M1</td> <td>1</td> <td></td> <td></td> <td>2.40218 GHz</td> <td>-3.14 dBm</td> <td></td> <td></td> </tr> <tr> <td>M2</td> <td>1</td> <td></td> <td></td> <td>2.4 GHz</td> <td>-54.37 dBm</td> <td></td> <td></td> </tr> <tr> <td>M3</td> <td>1</td> <td></td> <td></td> <td>2.39 GHz</td> <td>-55.13 dBm</td> <td></td> <td></td> </tr> <tr> <td>M4</td> <td>1</td> <td></td> <td></td> <td>2.31 GHz</td> <td>-55.92 dBm</td> <td></td> <td></td> </tr> <tr> <td>M5</td> <td>1</td> <td></td> <td></td> <td>2.325558 GHz</td> <td>-53.65 dBm</td> <td></td> <td></td> </tr> </tbody> </table> <p>Date: 11 JUL 2019 19:46:00</p>			Marker	Type	Ref	Trc	X-value	Y-value	Function	Function Result	M1	1			2.40218 GHz	-3.14 dBm			M2	1			2.4 GHz	-54.37 dBm			M3	1			2.39 GHz	-55.13 dBm			M4	1			2.31 GHz	-55.92 dBm			M5	1			2.325558 GHz	-53.65 dBm		
Marker	Type	Ref	Trc	X-value	Y-value	Function	Function Result																																												
M1	1			2.40218 GHz	-3.14 dBm																																														
M2	1			2.4 GHz	-54.37 dBm																																														
M3	1			2.39 GHz	-55.13 dBm																																														
M4	1			2.31 GHz	-55.92 dBm																																														
M5	1			2.325558 GHz	-53.65 dBm																																														
<p>CH00 Hopping mode</p>	 <table border="1" data-bbox="687 1120 1334 1223"> <thead> <tr> <th>Marker</th> <th>Type</th> <th>Ref</th> <th>Trc</th> <th>X-value</th> <th>Y-value</th> <th>Function</th> <th>Function Result</th> </tr> </thead> <tbody> <tr> <td>M1</td> <td>1</td> <td></td> <td></td> <td>2.40301 GHz</td> <td>-4.21 dBm</td> <td></td> <td></td> </tr> <tr> <td>M2</td> <td>1</td> <td></td> <td></td> <td>2.4 GHz</td> <td>-55.75 dBm</td> <td></td> <td></td> </tr> <tr> <td>M3</td> <td>1</td> <td></td> <td></td> <td>2.39 GHz</td> <td>-55.29 dBm</td> <td></td> <td></td> </tr> <tr> <td>M4</td> <td>1</td> <td></td> <td></td> <td>2.31 GHz</td> <td>-55.27 dBm</td> <td></td> <td></td> </tr> <tr> <td>M5</td> <td>1</td> <td></td> <td></td> <td>2.336022 GHz</td> <td>-53.72 dBm</td> <td></td> <td></td> </tr> </tbody> </table> <p>Date: 11 JUL 2019 20:00:08</p>			Marker	Type	Ref	Trc	X-value	Y-value	Function	Function Result	M1	1			2.40301 GHz	-4.21 dBm			M2	1			2.4 GHz	-55.75 dBm			M3	1			2.39 GHz	-55.29 dBm			M4	1			2.31 GHz	-55.27 dBm			M5	1			2.336022 GHz	-53.72 dBm		
Marker	Type	Ref	Trc	X-value	Y-value	Function	Function Result																																												
M1	1			2.40301 GHz	-4.21 dBm																																														
M2	1			2.4 GHz	-55.75 dBm																																														
M3	1			2.39 GHz	-55.29 dBm																																														
M4	1			2.31 GHz	-55.27 dBm																																														
M5	1			2.336022 GHz	-53.72 dBm																																														
<p>CH78 No hopping mode</p>	 <table border="1" data-bbox="687 1657 1334 1760"> <thead> <tr> <th>Marker</th> <th>Type</th> <th>Ref</th> <th>Trc</th> <th>X-value</th> <th>Y-value</th> <th>Function</th> <th>Function Result</th> </tr> </thead> <tbody> <tr> <td>M1</td> <td>1</td> <td></td> <td></td> <td>2.480149 GHz</td> <td>-3.18 dBm</td> <td></td> <td></td> </tr> <tr> <td>M2</td> <td>1</td> <td></td> <td></td> <td>2.4835 GHz</td> <td>-59.38 dBm</td> <td></td> <td></td> </tr> <tr> <td>M3</td> <td>1</td> <td></td> <td></td> <td>2.5 GHz</td> <td>-59.49 dBm</td> <td></td> <td></td> </tr> <tr> <td>M4</td> <td>1</td> <td></td> <td></td> <td>2.4865449 GHz</td> <td>-57.76 dBm</td> <td></td> <td></td> </tr> </tbody> </table> <p>Date: 11 JUL 2019 19:49:23</p>			Marker	Type	Ref	Trc	X-value	Y-value	Function	Function Result	M1	1			2.480149 GHz	-3.18 dBm			M2	1			2.4835 GHz	-59.38 dBm			M3	1			2.5 GHz	-59.49 dBm			M4	1			2.4865449 GHz	-57.76 dBm										
Marker	Type	Ref	Trc	X-value	Y-value	Function	Function Result																																												
M1	1			2.480149 GHz	-3.18 dBm																																														
M2	1			2.4835 GHz	-59.38 dBm																																														
M3	1			2.5 GHz	-59.49 dBm																																														
M4	1			2.4865449 GHz	-57.76 dBm																																														

CH78
Hopping mode

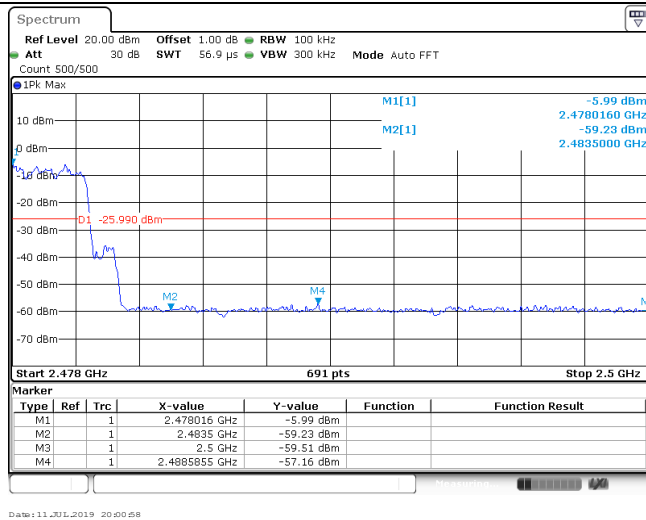

Date: 11 JUL 2019 20:00:58

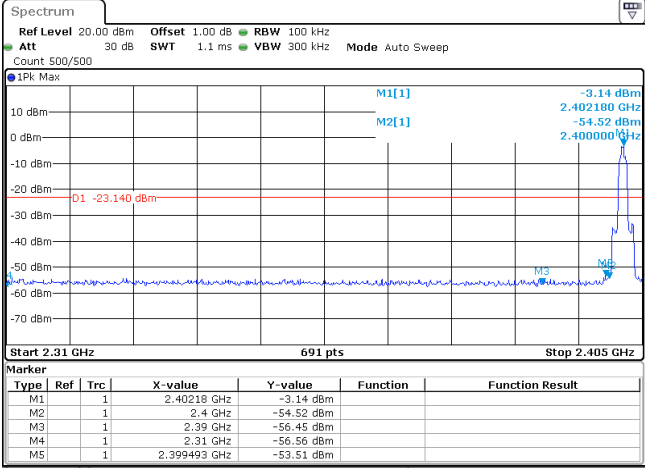
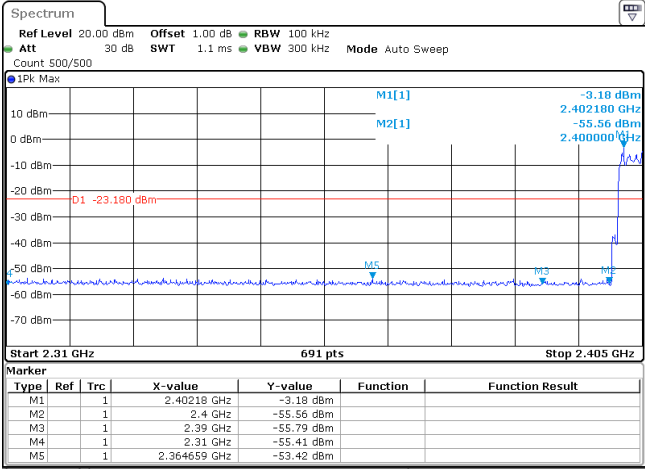
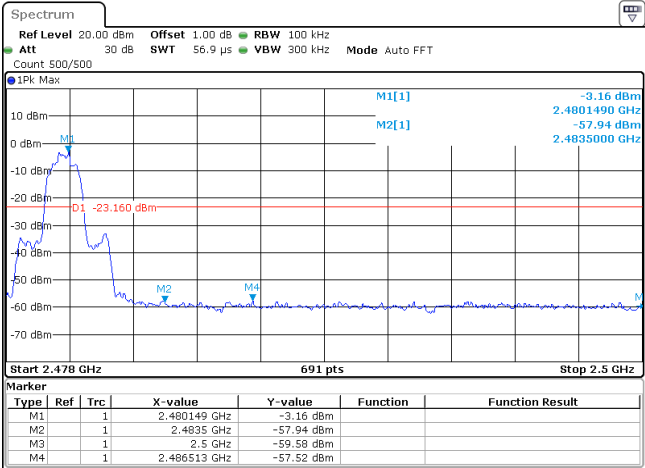
Test Item:	Band edge	Modulation type:	8DPSK																																										
<p>CH00 No hopping mode</p>		 <p>Ref Level 20.00 dBm Offset 1.00 dB RBW 100 kHz Att 30 dB SWT 1.1 ms VBW 300 kHz Mode Auto Sweep Count 500/500</p> <p>Start 2.31 GHz 691 pts Stop 2.405 GHz</p> <table border="1"> <thead> <tr> <th>Type</th> <th>Ref</th> <th>Trc</th> <th>X-value</th> <th>Y-value</th> <th>Function</th> <th>Function Result</th> </tr> </thead> <tbody> <tr> <td>M1</td> <td>1</td> <td></td> <td>2.40218 GHz</td> <td>-3.14 dBm</td> <td></td> <td></td> </tr> <tr> <td>M2</td> <td>1</td> <td></td> <td>2.4 GHz</td> <td>-54.52 dBm</td> <td></td> <td></td> </tr> <tr> <td>M3</td> <td>1</td> <td></td> <td>2.39 GHz</td> <td>-56.45 dBm</td> <td></td> <td></td> </tr> <tr> <td>M4</td> <td>1</td> <td></td> <td>2.31 GHz</td> <td>-56.56 dBm</td> <td></td> <td></td> </tr> <tr> <td>M5</td> <td>1</td> <td></td> <td>2.399493 GHz</td> <td>-53.51 dBm</td> <td></td> <td></td> </tr> </tbody> </table> <p>Date: 11 JUL 2019 19:51:03</p>	Type	Ref	Trc	X-value	Y-value	Function	Function Result	M1	1		2.40218 GHz	-3.14 dBm			M2	1		2.4 GHz	-54.52 dBm			M3	1		2.39 GHz	-56.45 dBm			M4	1		2.31 GHz	-56.56 dBm			M5	1		2.399493 GHz	-53.51 dBm			
Type	Ref	Trc	X-value	Y-value	Function	Function Result																																							
M1	1		2.40218 GHz	-3.14 dBm																																									
M2	1		2.4 GHz	-54.52 dBm																																									
M3	1		2.39 GHz	-56.45 dBm																																									
M4	1		2.31 GHz	-56.56 dBm																																									
M5	1		2.399493 GHz	-53.51 dBm																																									
<p>CH00 Hopping mode</p>		 <p>Ref Level 20.00 dBm Offset 1.00 dB RBW 100 kHz Att 30 dB SWT 1.1 ms VBW 300 kHz Mode Auto Sweep Count 500/500</p> <p>Start 2.31 GHz 691 pts Stop 2.405 GHz</p> <table border="1"> <thead> <tr> <th>Type</th> <th>Ref</th> <th>Trc</th> <th>X-value</th> <th>Y-value</th> <th>Function</th> <th>Function Result</th> </tr> </thead> <tbody> <tr> <td>M1</td> <td>1</td> <td></td> <td>2.40218 GHz</td> <td>-3.18 dBm</td> <td></td> <td></td> </tr> <tr> <td>M2</td> <td>1</td> <td></td> <td>2.4 GHz</td> <td>-55.56 dBm</td> <td></td> <td></td> </tr> <tr> <td>M3</td> <td>1</td> <td></td> <td>2.39 GHz</td> <td>-55.79 dBm</td> <td></td> <td></td> </tr> <tr> <td>M4</td> <td>1</td> <td></td> <td>2.31 GHz</td> <td>-55.41 dBm</td> <td></td> <td></td> </tr> <tr> <td>M5</td> <td>1</td> <td></td> <td>2.364659 GHz</td> <td>-53.42 dBm</td> <td></td> <td></td> </tr> </tbody> </table> <p>Date: 11 JUL 2019 20:04:05</p>	Type	Ref	Trc	X-value	Y-value	Function	Function Result	M1	1		2.40218 GHz	-3.18 dBm			M2	1		2.4 GHz	-55.56 dBm			M3	1		2.39 GHz	-55.79 dBm			M4	1		2.31 GHz	-55.41 dBm			M5	1		2.364659 GHz	-53.42 dBm			
Type	Ref	Trc	X-value	Y-value	Function	Function Result																																							
M1	1		2.40218 GHz	-3.18 dBm																																									
M2	1		2.4 GHz	-55.56 dBm																																									
M3	1		2.39 GHz	-55.79 dBm																																									
M4	1		2.31 GHz	-55.41 dBm																																									
M5	1		2.364659 GHz	-53.42 dBm																																									
<p>CH78 No hopping mode</p>		 <p>Ref Level 20.00 dBm Offset 1.00 dB RBW 100 kHz Att 30 dB SWT 56.9 μs VBW 300 kHz Mode Auto FFT Count 500/500</p> <p>Start 2.478 GHz 691 pts Stop 2.5 GHz</p> <table border="1"> <thead> <tr> <th>Type</th> <th>Ref</th> <th>Trc</th> <th>X-value</th> <th>Y-value</th> <th>Function</th> <th>Function Result</th> </tr> </thead> <tbody> <tr> <td>M1</td> <td>1</td> <td></td> <td>2.480149 GHz</td> <td>-3.16 dBm</td> <td></td> <td></td> </tr> <tr> <td>M2</td> <td>1</td> <td></td> <td>2.4835 GHz</td> <td>-57.94 dBm</td> <td></td> <td></td> </tr> <tr> <td>M3</td> <td>1</td> <td></td> <td>2.5 GHz</td> <td>-59.58 dBm</td> <td></td> <td></td> </tr> <tr> <td>M4</td> <td>1</td> <td></td> <td>2.486513 GHz</td> <td>-57.52 dBm</td> <td></td> <td></td> </tr> </tbody> </table> <p>Date: 11 JUL 2019 19:53:41</p>	Type	Ref	Trc	X-value	Y-value	Function	Function Result	M1	1		2.480149 GHz	-3.16 dBm			M2	1		2.4835 GHz	-57.94 dBm			M3	1		2.5 GHz	-59.58 dBm			M4	1		2.486513 GHz	-57.52 dBm										
Type	Ref	Trc	X-value	Y-value	Function	Function Result																																							
M1	1		2.480149 GHz	-3.16 dBm																																									
M2	1		2.4835 GHz	-57.94 dBm																																									
M3	1		2.5 GHz	-59.58 dBm																																									
M4	1		2.486513 GHz	-57.52 dBm																																									

CH78
Hoppig mode

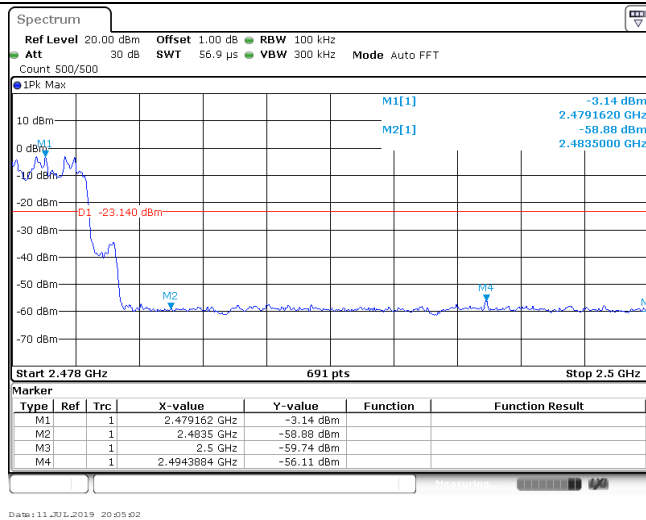

Date: 11 JUL 2019 20:05:02

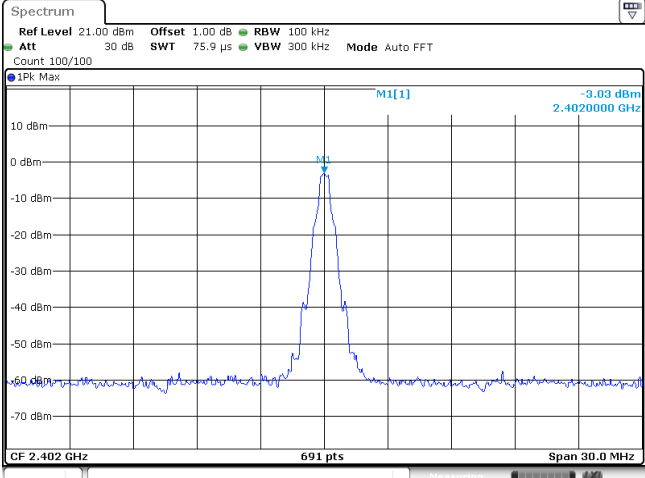
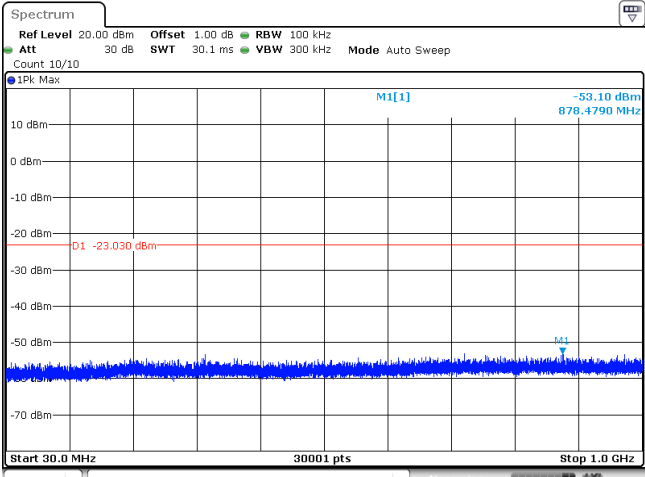
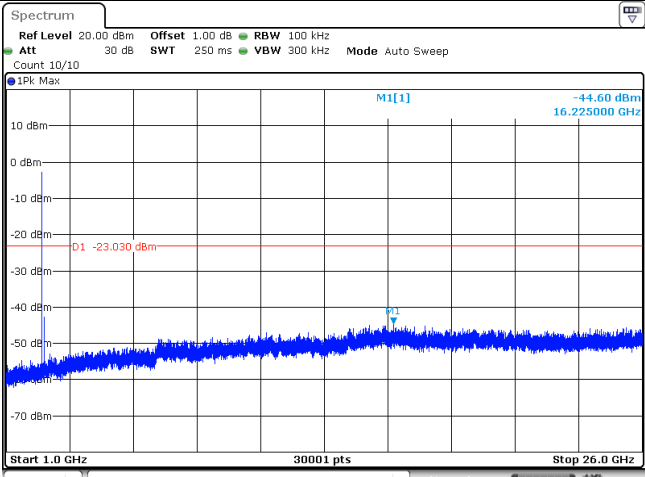
Test Item:	SE	Modulation type:	GFSK
CH00 Reference level		 <p>Ref Level 21.00 dBm Offset 1.00 dB RBW 100 kHz Att 30 dB SWT 75.9 μs VBW 300 kHz Mode Auto FFT Count 100/100 CF 2.402 GHz 691 pts Span 30.0 MHz Date: 11 JUL 2019 19:41:51</p>	
CH00 30MHz~1000MHz		 <p>Ref Level 20.00 dBm Offset 1.00 dB RBW 100 kHz Att 30 dB SWT 30.1 ms VBW 300 kHz Mode Auto Sweep Count 10/10 Start 30.0 MHz 30001 pts Stop 1.0 GHz Date: 11 JUL 2019 19:41:46</p>	
CH00 1GHz~26GHz		 <p>Ref Level 20.00 dBm Offset 1.00 dB RBW 100 kHz Att 30 dB SWT 250 ms VBW 300 kHz Mode Auto Sweep Count 10/10 Start 1.0 GHz 30001 pts Stop 26.0 GHz Date: 11 JUL 2019 19:42:03</p>	

CH39
Reference level

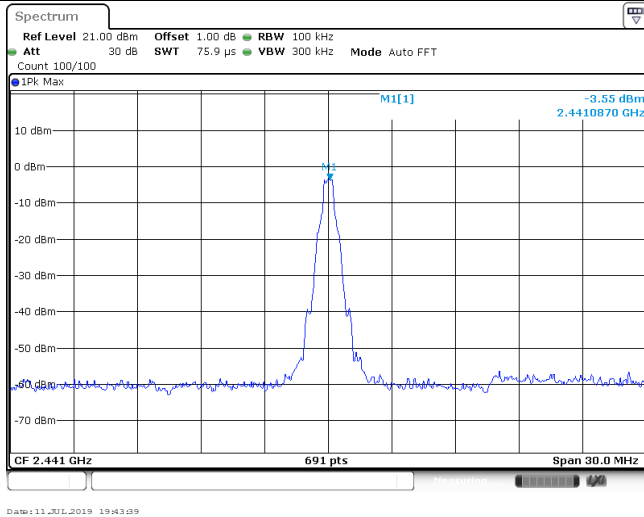

CH39
30MHz~1000MHz

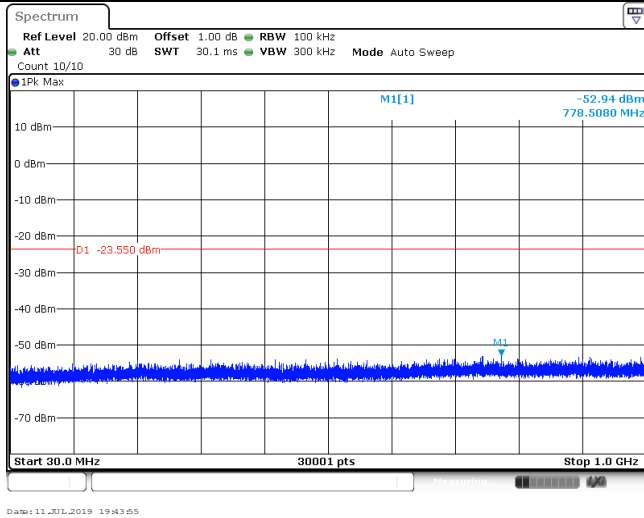

CH39
1GHz~26GHz

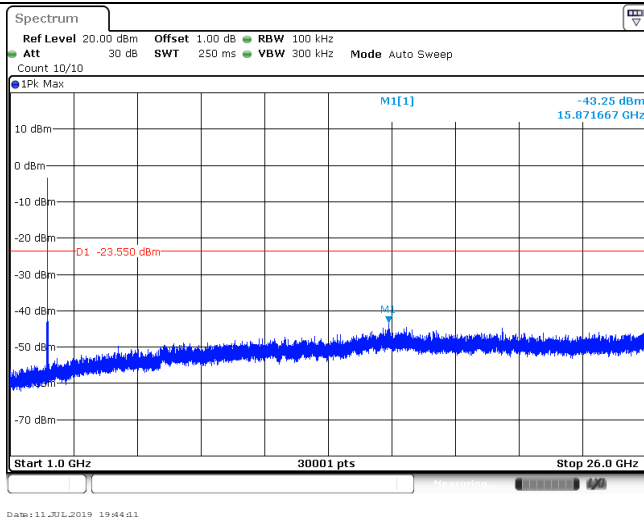

CH78
Reference level

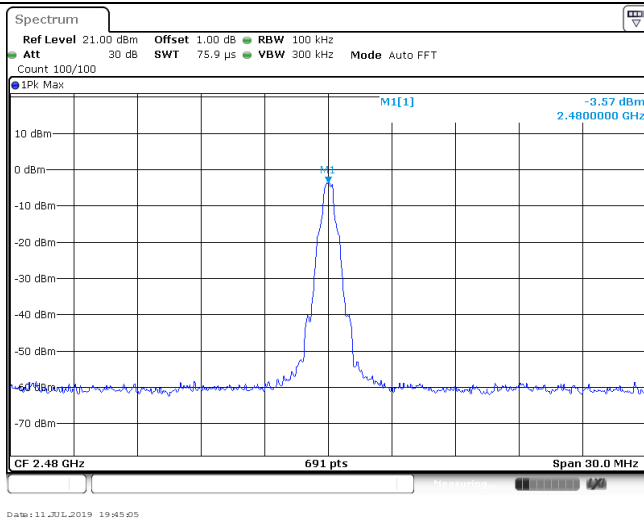

CH78
30MHz~1000MHz

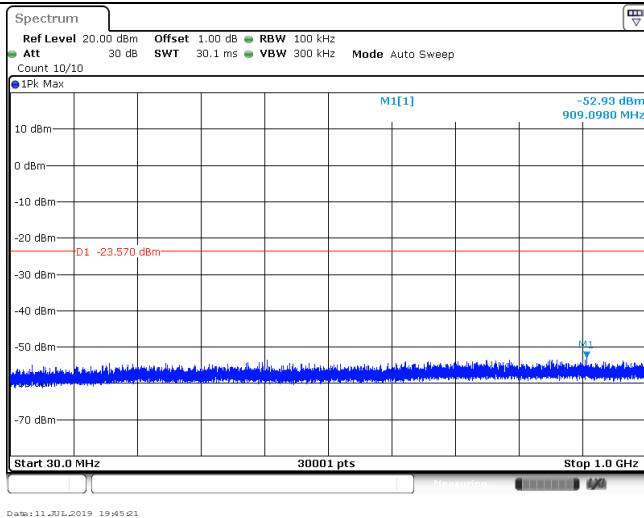

CH78
1GHz~26GHz

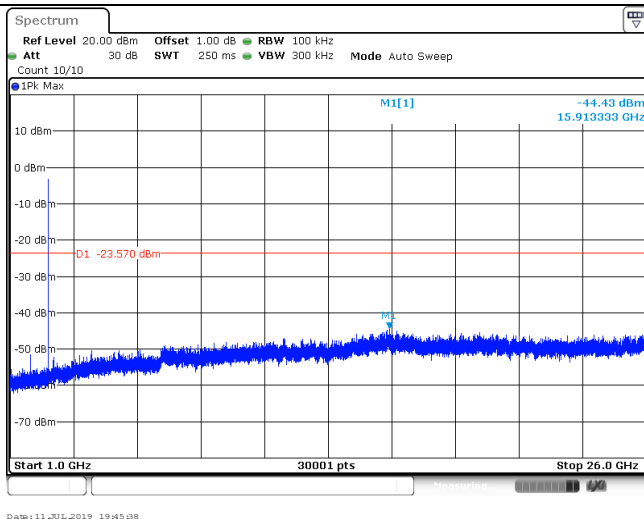

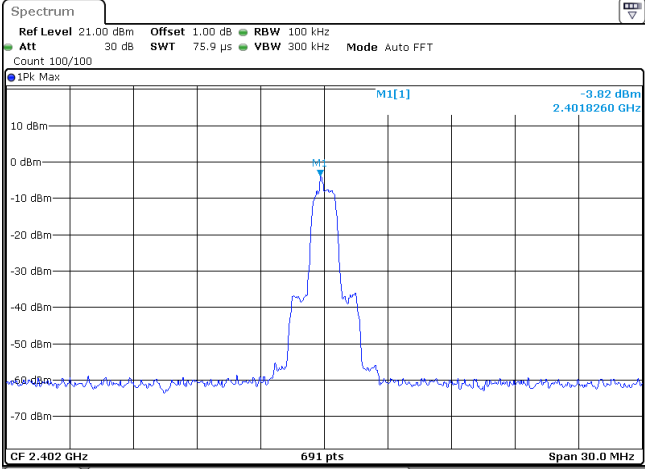
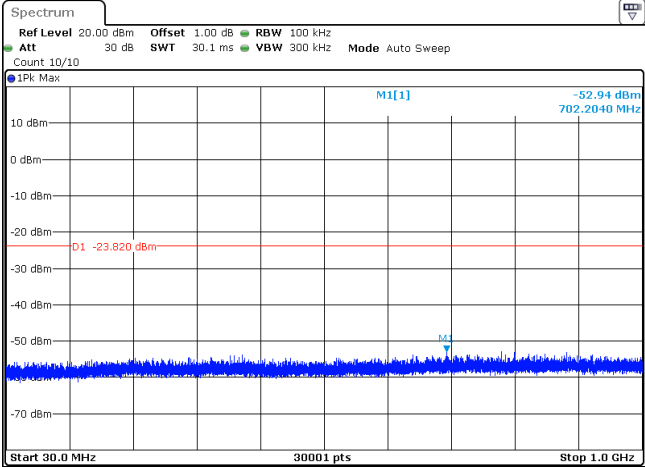
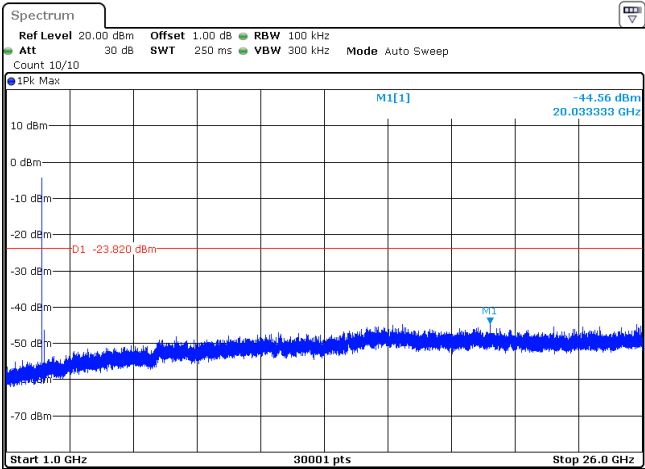
Test Item:	SE	Modulation type:	$\pi/4$ DQPSK
CH00 Reference level	 <p>Spectrum</p> <p>Ref Level 21.00 dBm Offset 1.00 dB RBW 100 kHz Att 30 dB SWT 75.9 μs VBW 300 kHz Mode Auto FFT Count 100/100</p> <p>IPK Max</p> <p>M1[1] -3.82 dBm 2.4018260 GHz</p> <p>CF 2.402 GHz 691 pts Span 30.0 MHz</p> <p>Date: 11 JUL 2019 19:46:06</p>		
CH00 30MHz~1000MHz	 <p>Spectrum</p> <p>Ref Level 20.00 dBm Offset 1.00 dB RBW 100 kHz Att 30 dB SWT 30.1 ms VBW 300 kHz Mode Auto Sweep Count 10/10</p> <p>IPK Max</p> <p>M1[1] -52.94 dBm 702.2040 MHz</p> <p>D1 -23.820 dBm</p> <p>Start 30.0 MHz 30001 pts Stop 1.0 GHz</p> <p>Date: 11 JUL 2019 19:46:52</p>		
CH00 1GHz~26GHz	 <p>Spectrum</p> <p>Ref Level 20.00 dBm Offset 1.00 dB RBW 100 kHz Att 30 dB SWT 250 ms VBW 300 kHz Mode Auto Sweep Count 10/10</p> <p>IPK Max</p> <p>M1[1] -44.56 dBm 20.033333 GHz</p> <p>D1 -23.820 dBm</p> <p>Start 1.0 GHz 30001 pts Stop 26.0 GHz</p> <p>Date: 11 JUL 2019 19:47:09</p>		

CH39
Reference level

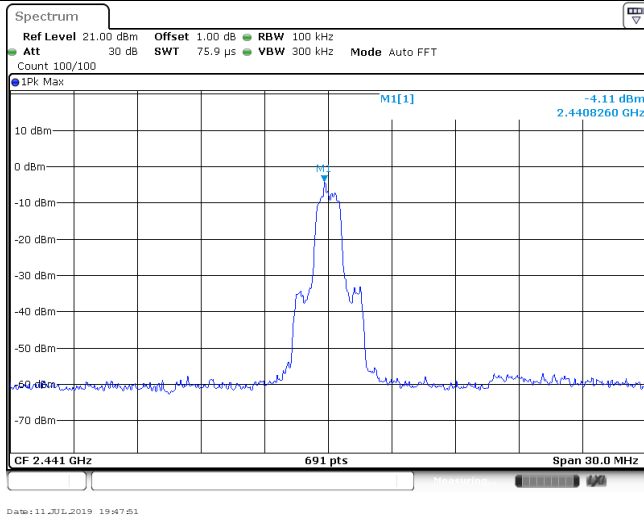

CH39
30MHz~1000MHz

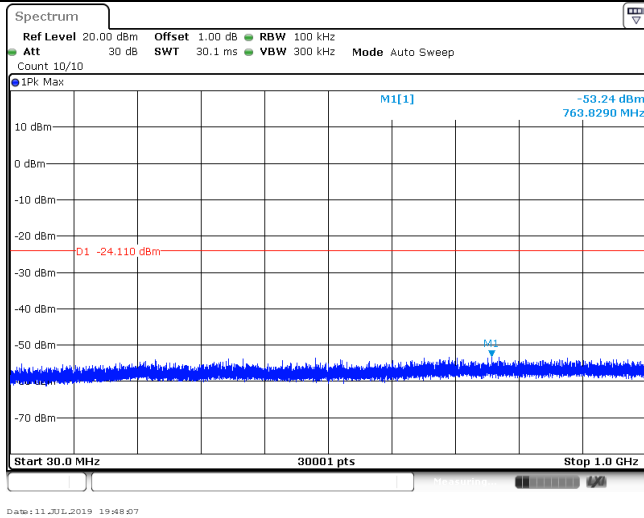

CH39
1GHz~26GHz

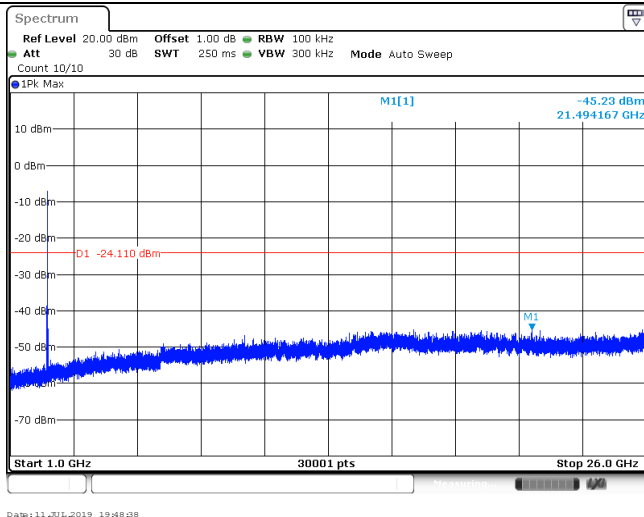

CH78
Reference level

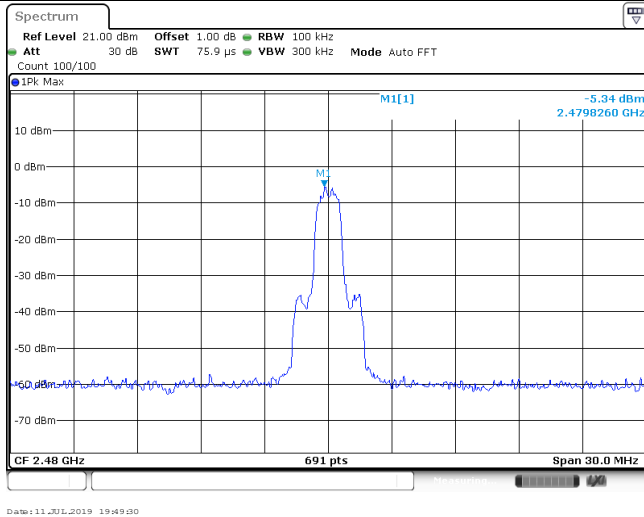

CH78
30MHz~1000MHz

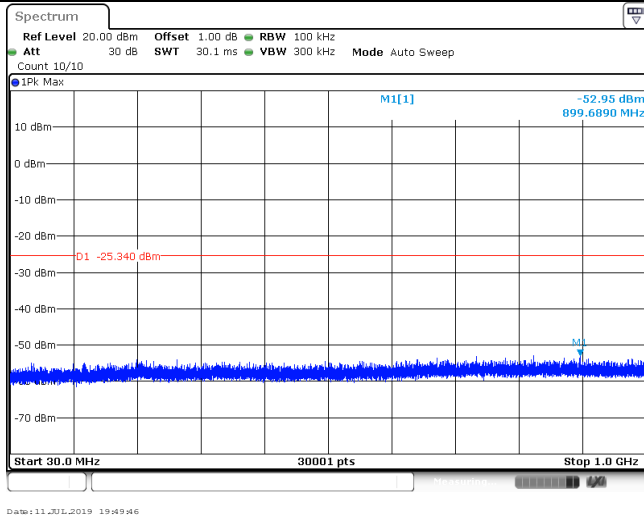

CH78
1GHz~26GHz

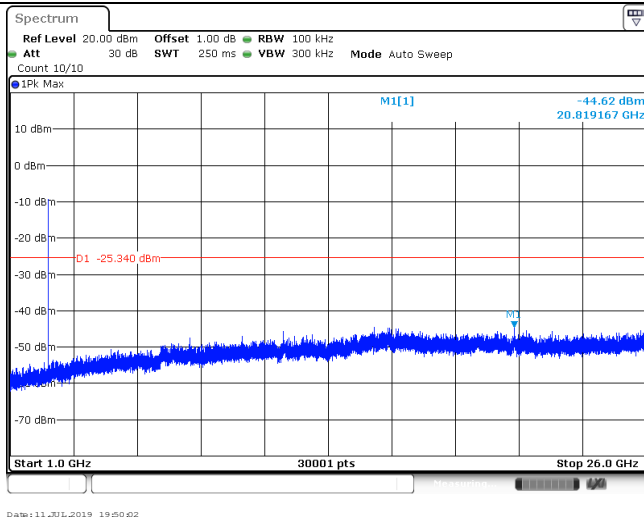

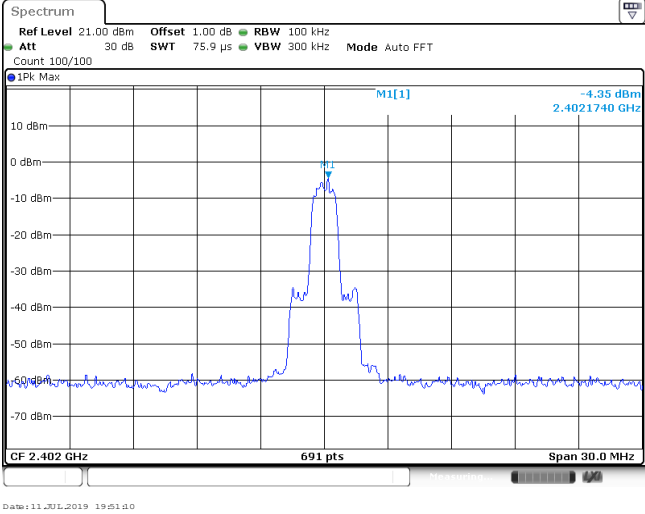
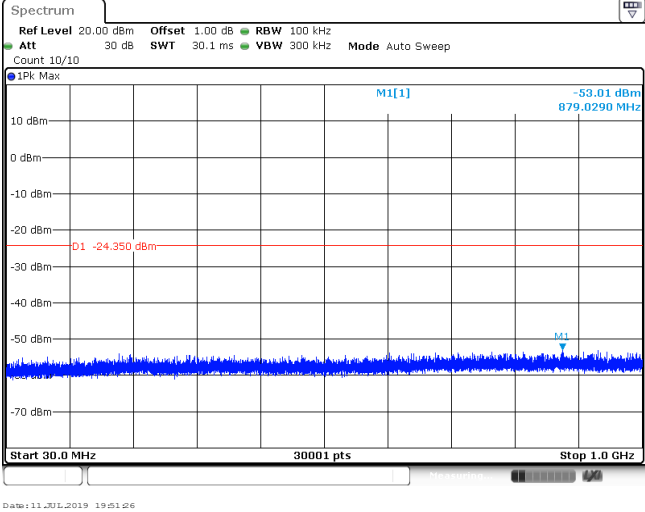
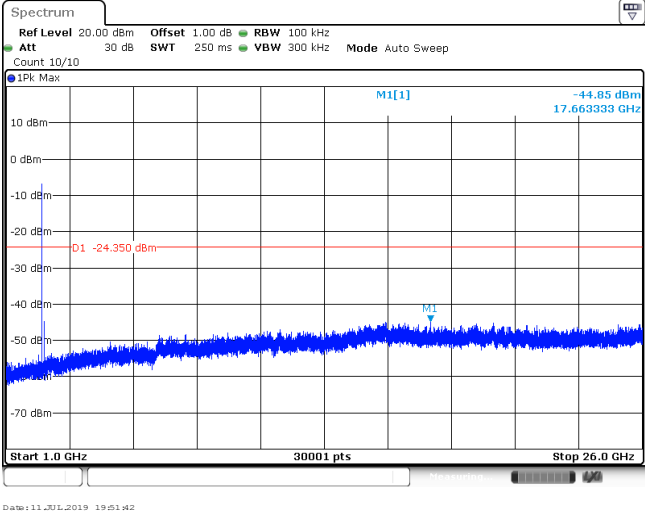
Test Item:	SE	Modulation type:	8DPSK
CH00 Reference level		 <p>Spectrum</p> <p>Ref Level 21.00 dBm Offset 1.00 dB RBW 100 kHz Att 30 dB SWT 75.9 μs VBW 300 kHz Mode Auto FFT Count 100/100</p> <p>1Pk Max</p> <p>M1[1] -4.35 dBm 2.4021740 GHz</p> <p>CF 2.402 GHz 691 pts Span 30.0 MHz</p> <p>Date: 11 JUL 2019 19:51:00</p>	
CH00 30MHz~1000MHz		 <p>Spectrum</p> <p>Ref Level 20.00 dBm Offset 1.00 dB RBW 100 kHz Att 30 dB SWT 30.1 ms VBW 300 kHz Mode Auto Sweep Count 10/10</p> <p>1Pk Max</p> <p>M1[1] -53.01 dBm 879.0290 MHz</p> <p>D1 -24.350 dBm</p> <p>Start 30.0 MHz 30001 pts Stop 1.0 GHz</p> <p>Date: 11 JUL 2019 19:51:26</p>	
CH00 1GHz~26GHz		 <p>Spectrum</p> <p>Ref Level 20.00 dBm Offset 1.00 dB RBW 100 kHz Att 30 dB SWT 250 ms VBW 300 kHz Mode Auto Sweep Count 10/10</p> <p>1Pk Max</p> <p>M1[1] -44.85 dBm 17.663333 GHz</p> <p>D1 -24.350 dBm</p> <p>Start 1.0 GHz 30001 pts Stop 26.0 GHz</p> <p>Date: 11 JUL 2019 19:51:42</p>	

CH39
Reference level

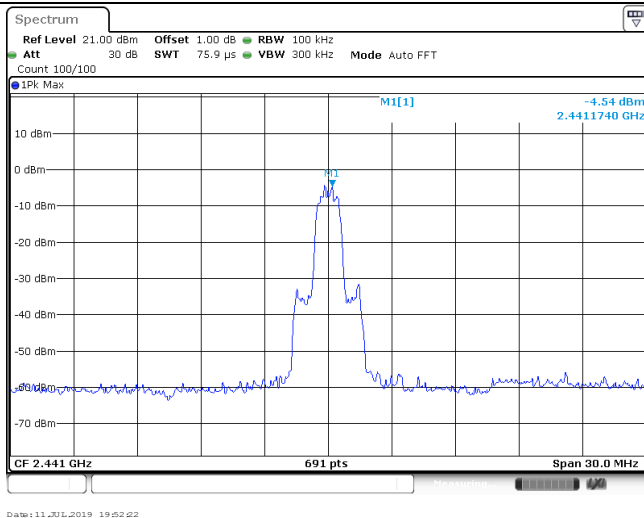

CH39
30MHz~1000MHz

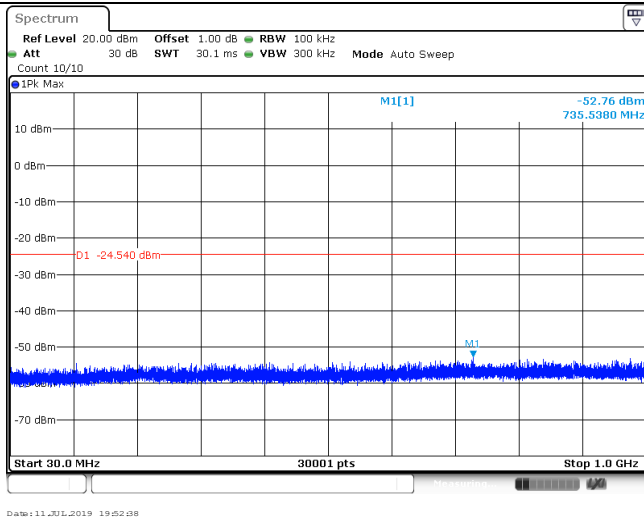

CH39
1GHz~26GHz

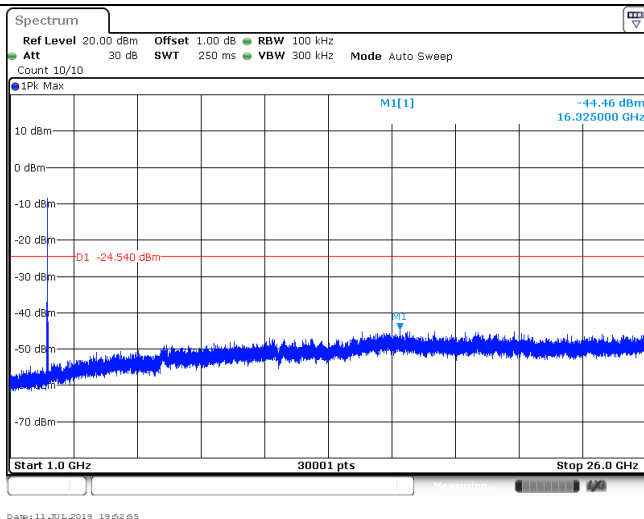

CH78
Reference level

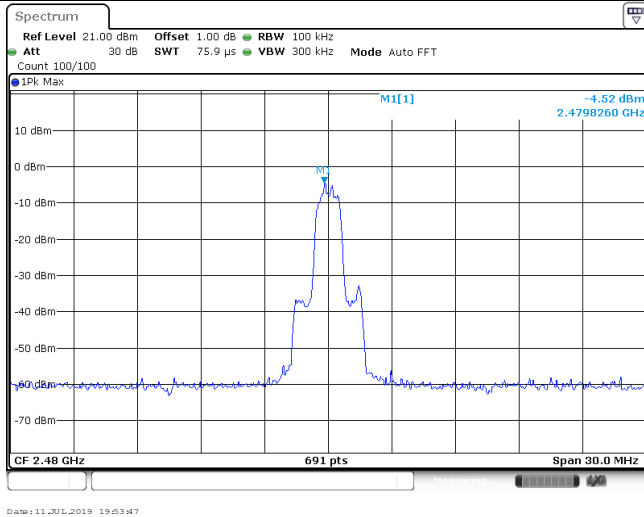

CH78
30MHz~1000MHz

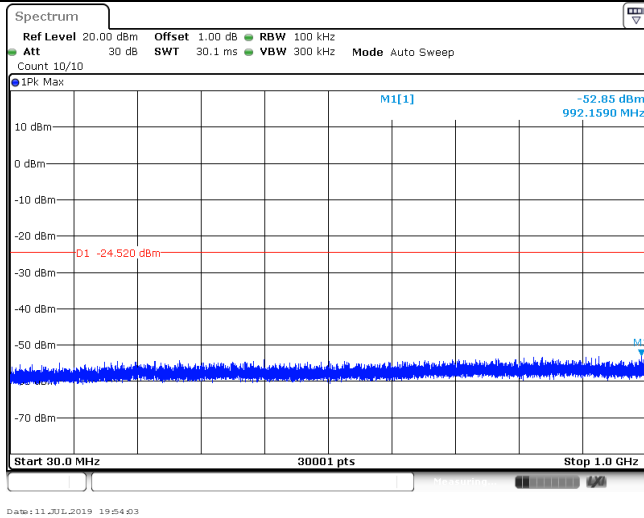

CH78
1GHz~26GHz

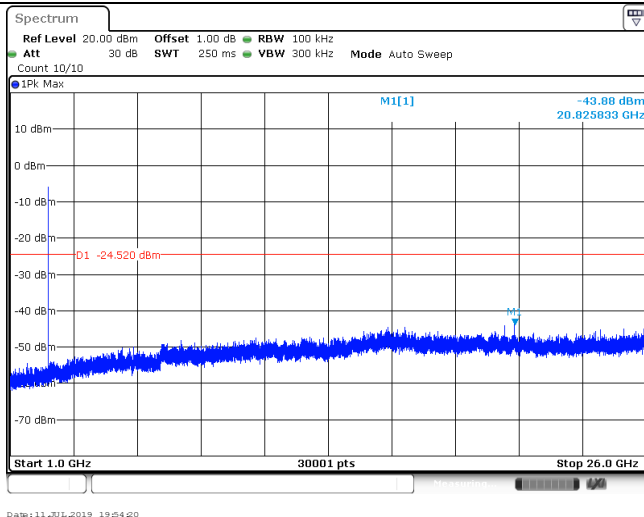

5.11. Spurious Emissions (radiated)

LIMIT

FCC CFR Title 47 Part 15 Subpart C Section 15.209

Frequency	Limit (dBuV/m @3m)	Value
30 MHz ~ 88 MHz	40.00	Quasi-peak
88 MHz ~ 216 MHz	43.50	Quasi-peak
216 MHz ~ 960 MHz	46.00	Quasi-peak
960 MHz ~ 1 GHz	54.00	Quasi-peak
Above 1 GHz	54.00	Average
	74.00	Peak

TEST CONFIGURATION

- Below 30 MHz

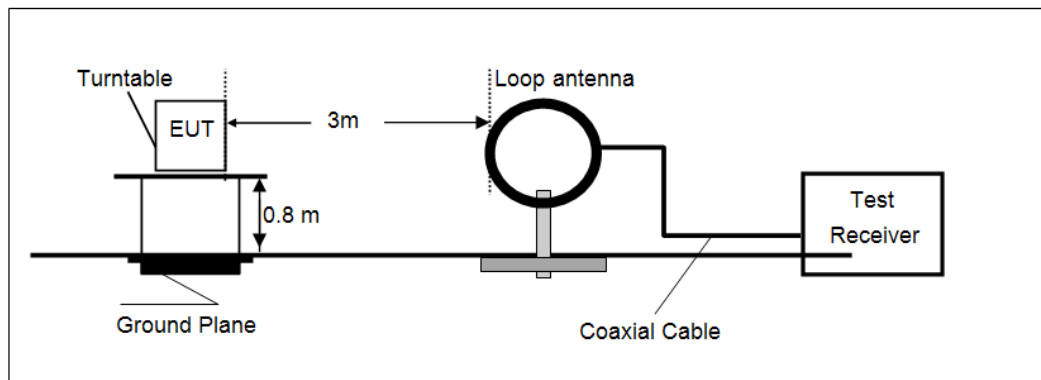

- 30 MHz ~1000 MHz

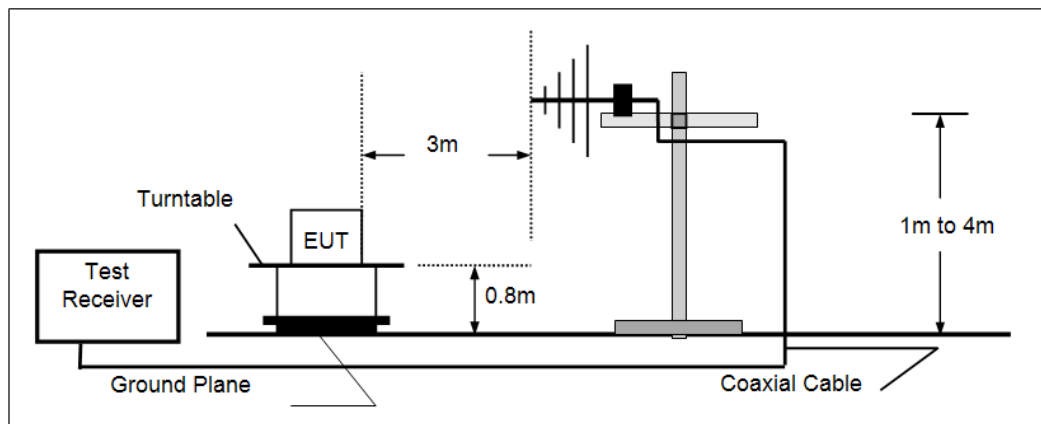

- Above 1 GHz

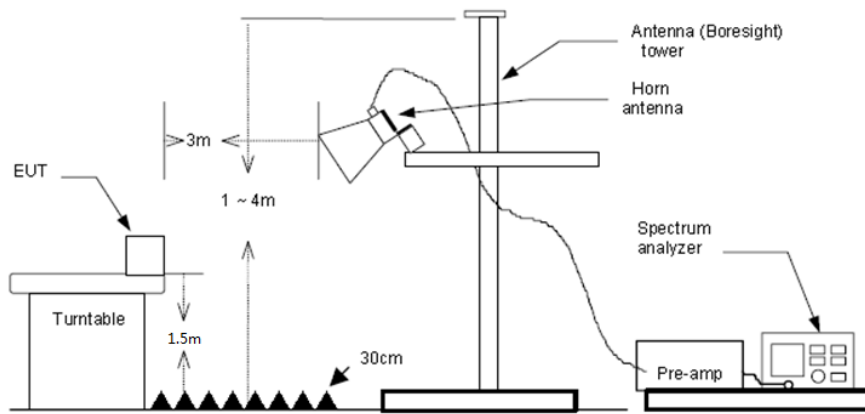

TEST PROCEDURE

1. The EUT was tested according to ANSI C63.10:2013.
2. The EUT is placed on a turn table with 0.8 meter above ground for below 1GHz, 1.5 meter above ground for above 1GHz.
3. The EUT was set 3 meters from the receiving antenna, which was mounted on the top of a variable height antenna tower.
4. For each suspected emission, the EUT was arranged to its worst case and then tune the Antenna tower (from 1 m to 4 m) and turntable (from 0 degree to 360 degrees) to find the maximum reading. A pre-amp and a high pass filter are used for the test in order to get better signal level to comply with the guidelines.
5. Set to the maximum power setting and enable the EUT transmit continuously.
6. Use the following spectrum analyzer settings
 - (1) Span shall wide enough to fully capture the emission being measured;
 - (2) Below 1 GHz:
 - RBW=120 kHz, VBW=300 kHz, Sweep=auto, Detector function=peak, Trace=max hold;
 - If the emission level of the EUT measured by the peak detector is 3 dB lower than the applicable limit, the peak emission level will be reported. Otherwise, the emission measurement will be repeated using the quasi-peak detector and reported.
 - (3) From 1 GHz to 10th harmonic:
 - RBW=1 MHz, VBW=3 MHz Peak detector for Peak value
 - RBW=1 MHz, VBW=10 Hz Peak detector for Average value.

TEST MODE:

Please refer to the clause 3.3

TEST RESULTS

Passed Not Applicable

Note:

- 1) Final Level = Receiver Read level + Factor
- 2) The emission levels of other frequencies are very lower than the limit and not show in test report.
- 3) Below 1 GHz, Have pre-scan all modulation mode, found the GFSK modulation High channel which it was worst case, so only the worst case's data on the test report.
- 4) Above 1 GHz, Have pre-scan all modulation mode, found the GFSK modulation which it was worst case, so only the worst case's data on the test report
- 5) The peak level is lower than average limit(54 dBuV/m), this data is the too weak instrument of signal is unable to test.

➤ 9 kHz ~ 30 MHz

The low frequency, which started from 9 kHz to 30 MHz, was pre-scanned and the result which was 20 dB lower than the limit line per 15.31(o) was not reported.

➤ 30 MHz ~ 1 GHz

Polarization: Vertical

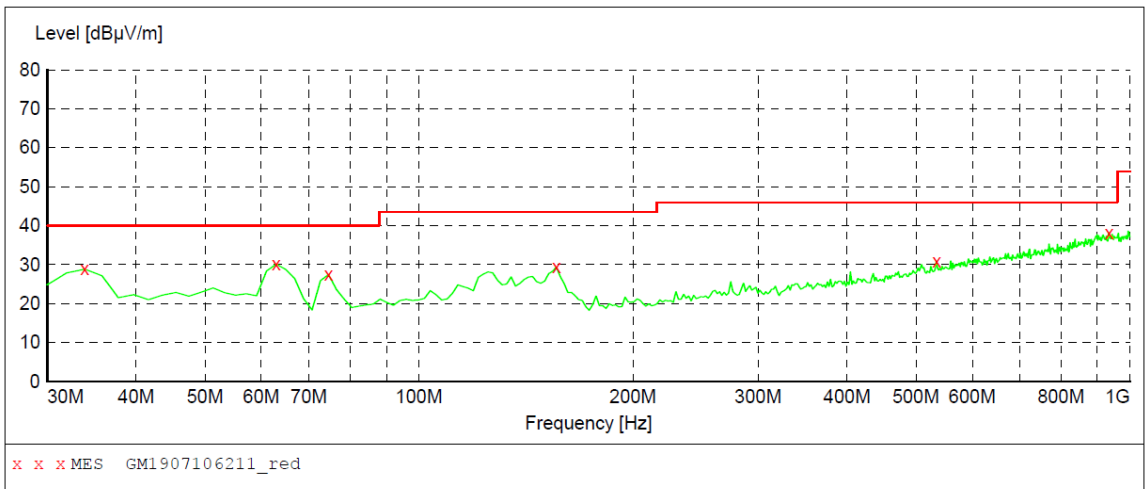

MEASUREMENT RESULT: "GM1907106211_red"

7/10/2019 9:50PM

Frequency MHz	Level dBµV/m	Transd dB	Limit dBµV/m	Margin dB	Det.	Height cm	Azimuth deg	Polarization
33.880000	28.80	-8.7	40.0	11.2	QP	100.0	223.00	VERTICAL
62.980000	30.10	-6.9	40.0	9.9	QP	100.0	0.00	VERTICAL
74.620000	27.40	-10.9	40.0	12.6	QP	100.0	327.00	VERTICAL
156.100000	29.40	-9.8	43.5	14.1	QP	100.0	315.00	VERTICAL
534.400000	30.80	2.6	46.0	15.2	QP	100.0	206.00	VERTICAL
934.040000	38.20	10.8	46.0	7.8	QP	100.0	359.00	VERTICAL

Polarization: Horizontal

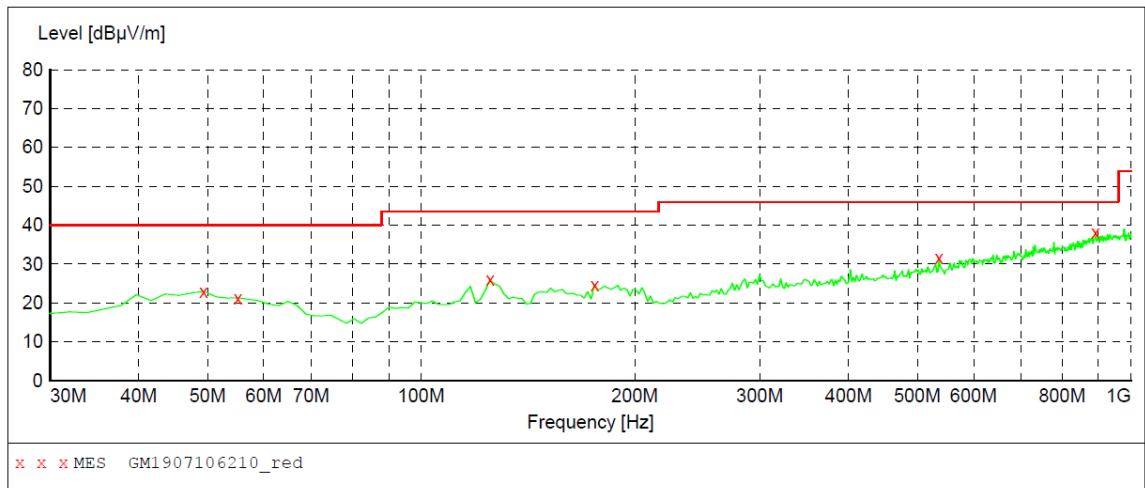

MEASUREMENT RESULT: "GM1907106210_red"

7/10/2019 9:48PM

Frequency MHz	Level dBµV/m	Transd dB	Limit dBµV/m	Margin dB	Det.	Height cm	Azimuth deg	Polarization
49.400000	23.00	-4.8	40.0	17.0	QP	100.0	127.00	HORIZONTAL
55.220000	21.30	-5.3	40.0	18.7	QP	100.0	0.00	HORIZONTAL
125.060000	25.90	-9.1	43.5	17.6	QP	100.0	184.00	HORIZONTAL
175.500000	24.70	-8.9	43.5	18.8	QP	100.0	7.00	HORIZONTAL
536.340000	31.50	2.7	46.0	14.5	QP	100.0	23.00	HORIZONTAL
891.360000	38.20	10.3	46.0	7.8	QP	100.0	355.00	HORIZONTAL

➤ 1 GHz ~ 25 GHz

CH00							
Frequency (MHz)	Read Level (dBuV/m)	Factor (dB/m)	Level (dBuV/m)	Limit Line (dBuV/m)	Margin (dB)	Polarization	Test value
1239.4063	37.30	-5.73	31.57	74.00	42.43	Vertical	Peak
1499.3750	44.45	-5.63	38.82	74.00	35.18	Vertical	Peak
5146.2813	31.56	8.88	40.44	74.00	33.56	Vertical	Peak
6720.7813	31.04	13.41	44.45	74.00	29.55	Vertical	Peak
1333.4063	34.89	-5.57	29.32	74.00	44.68	Horizontal	Peak
3148.7813	33.97	0.57	34.54	74.00	39.46	Horizontal	Peak
5113.9688	32.47	8.83	41.30	74.00	32.70	Horizontal	Peak
6952.8438	29.70	14.67	44.37	74.00	29.63	Horizontal	Peak

CH39							
Frequency (MHz)	Read Level (dBuV/m)	Factor (dB/m)	Level (dBuV/m)	Limit Line (dBuV/m)	Margin (dB)	Polarization	Test value
1499.3750	45.13	-5.63	39.50	74.00	34.50	Vertical	Peak
1624.2188	37.49	-6.24	31.25	74.00	42.75	Vertical	Peak
5625.0938	31.40	8.83	40.23	74.00	33.77	Vertical	Peak
7938.3750	31.96	17.65	49.61	74.00	24.39	Vertical	Peak
1749.0625	37.54	-5.95	31.59	74.00	42.41	Horizontal	Peak
3128.2188	34.58	0.47	35.05	74.00	38.95	Horizontal	Peak
4671.8750	31.16	6.21	37.37	74.00	36.63	Horizontal	Peak
6830.9375	30.57	13.48	44.05	74.00	29.95	Horizontal	Peak

CH78							
Frequency (MHz)	Read Level (dBuV/m)	Factor (dB/m)	Level (dBuV/m)	Limit Line (dBuV/m)	Margin (dB)	Polarization	Test value
1499.3750	45.76	-5.63	40.13	74.00	33.87	Vertical	Peak
1750.5313	40.67	-5.95	34.72	74.00	39.28	Vertical	Peak
4999.4063	31.98	7.85	39.83	74.00	34.17	Vertical	Peak
7007.1875	31.02	15.19	46.21	74.00	27.79	Vertical	Peak
1301.0938	35.01	-5.57	29.44	74.00	44.56	Horizontal	Peak
1750.5313	36.87	-5.95	30.92	74.00	43.08	Horizontal	Peak
4435.4063	31.51	5.07	36.58	74.00	37.42	Horizontal	Peak
5263.7813	31.29	8.64	39.93	74.00	34.07	Horizontal	Peak

Remark:

1. Final Level = Receiver Read level + Antenna Factor + Cable Loss – Preamplifier Factor
2. The peak level is lower than average limit(54 dBuV/m), this data is the too weak instrument of signal is unable to test.
3. The emission levels of other frequencies are very lower than the limit and not show in test report.

6. TEST SETUP PHOTOS

Conducted Emissions (AC Mains)

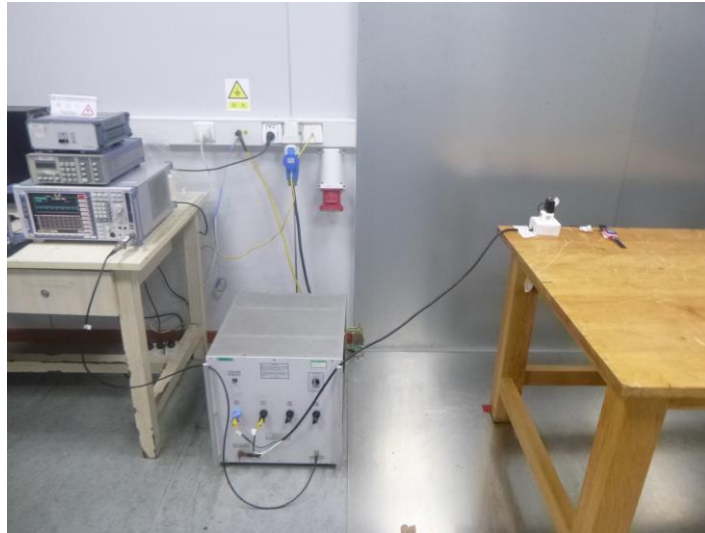

Radiated Emissions

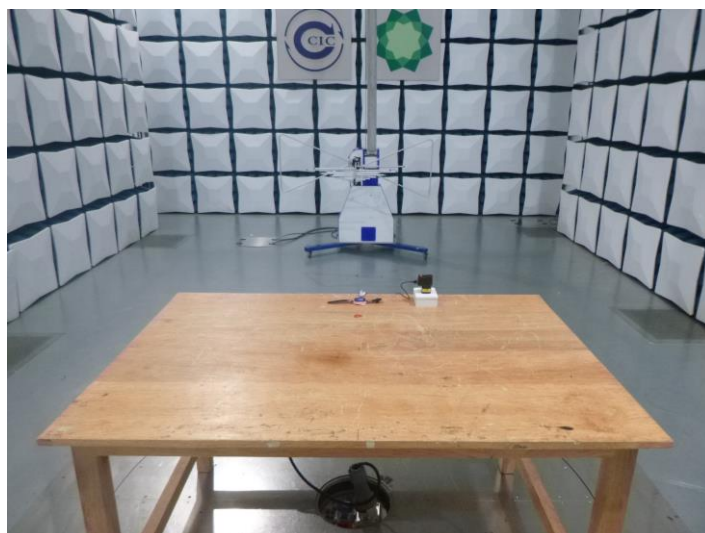

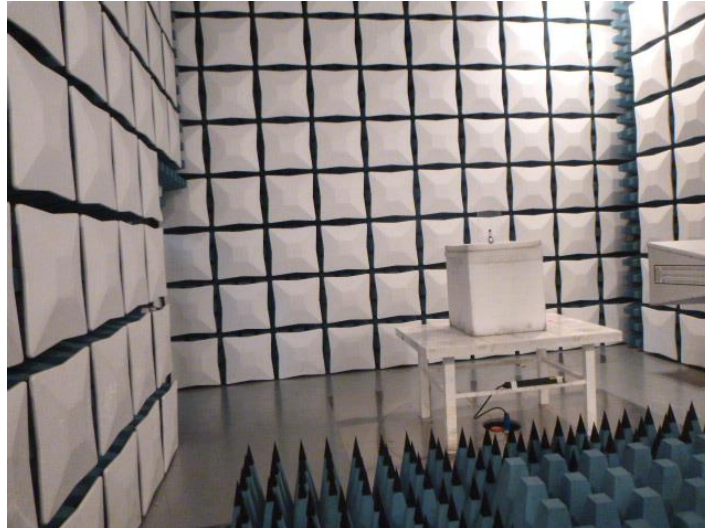

7. EXTERANAL AND INTERNAL PHOTOS

Reference to the test report No. CHTEW19070077

-----End of Report-----