



# FCC 47 CFR PART 15 SUBPART C

## TEST REPORT

*For*

**Applicant :** Dongguan Yuanfeng Technology Co., Ltd.

**Address :** No.62, South Fumin Road, Fumin Industrial Park, Dalang Town,  
Dongguan City, Guangdong, P.R. China

**Product Name :** GPS Portable Navigation Device

**Model Name :** PF86-5001

**Brand Name :** N/A

**FCC ID :** YNG-GPF08600D

**Report No. :** MOST101013F2B

**Date of Issue :** October. 22, 2010

**Issued by :** Most Technology Service Co., Ltd.

**Address :** No.5, 2nd Langshan Road, North District, Hi-tech Industrial  
Park, Nanshan, Shenzhen, Guangdong, China

**Tel :** 86-755-8617 0306

**Fax :** 86-755-8617 0310

*The report consists 32 pages in total. It may be duplicated completely for legal use with the approval of the applicant. It should not be reproduced except in full, without the written approval of our laboratory. The client should not use it to claim product endorsement by MOST. The test results in the report only apply to the tested sample. The test report shall be invalid without all the signatures of testing engineers, reviewer and approver.*

**TABLE OF CONTENTS**

**1. VERIFICATION OF CONFORMITY ..... 3**

**2. GENERAL INFORMATION ..... 4**

2.1 Product Information ..... 4

2.2 Objective ..... 5

2.3 Test Standards and Results ..... 5

2.4 Environmental Conditions..... 5

**3. TEST FACILITY ..... 6**

3.1 TEST FACILITY..... 6

3.2 GENERAL TEST PROCEDURES ..... 6

3.3 FCC PART 15.205 RESTRICTED BANDS OF OPERATIONS..... 7

**4. SETUP OF EQUIPMENT UNDER TEST ..... 8**

4.1 SUPPORT EQUIPMENT ..... 8

4.2 TEST EQUIPMENT LIST ..... 9

**5. 47 CFR Part 15C 15.249 Requirements..... 10**

5.1 Spurious Emission Test ..... 10

5.1.1 Requirement..... 10

5.1.2 Test Description ..... 11

5.1.3 Test Description ..... 12

5.1.4 Test Result..... 13

**5.2 Band Edge..... 18**

5.2.1 Requirement..... 18

5.2.2 Test Description ..... 18

5.2.3 Test Result..... 18

**APPENDIX 1 ..... 20**

**PHOTOGRAPHS OF TEST SETUP ..... 20**

**APPENDIX 2 ..... 22**

**PHOTOGRAPHS OF EUT ..... 22**

1. VERIFICATION OF CONFORMITY

**Equipment Under Test:** GPS Portable Navigation Device

**Brand Name:** N/A

**Model Number:** PF86-5001

**FCC ID:** YNG-GPF8600D

**Applicant:** Dongguan Yuanfeng Technology Co., Ltd.  
No.62, South Fumin Road, Fumin Industrial Park, Dalang Town, Dongguan City, Guangdong, P.R. China

**Manufacturer:** Dongguan Yuanfeng Technology Co., Ltd.  
No.62, South Fumin Road, Fumin Industrial Park, Dalang Town, Dongguan City, Guangdong, P.R. China

**Technical Standards:** 47 CFR Part 15 Subpart C

**File Number:** MOST101013F2B

**Date of test:** October. 16, 2010 – October. 22, 2010

**Deviation:** None

**Condition of Test Sample:** Normal

**Test Result:** PASS

The above equipment was tested by MOST for compliance with the requirements set forth in FCC rules and the Technical Standards mentioned above. This said equipment in the configuration described in this report shows the maximum emission levels emanating from equipment and the level of the immunity endurance of the equipment are within the compliance requirements.

The test results of this report relate only to the tested sample identified in this report.

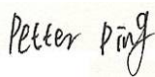
Tested by (+ signature):   
Petter Ping    October. 22, 2010

Review by (+ signature):   
July Wen    October. 22, 2010

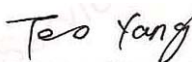
Approved by (+ signature):   
Terry Yang    October. 22, 2010

**2. GENERAL INFORMATION**

**2.1 Product Information**

<b>Product</b>	GPS Portable Navigation Device
<b>Trade Name</b>	N/A
<b>Model Number</b>	PF86-5001
<b>Series Number:</b>	PF86-5001HD, PF86-5002, PF86-5002HD, PF86-5003, PF86-5003HD, PF86-5004, PF86-5004HD, PF86-5005, PF86-5005HD, PF86-5006, PF86-5006HD, PF86-5007, PF86-5007HD, PF86-5008, PF86-5008HD, PF86-5009, PF86-5009HD
<b>Description of Differences:</b>	The series models are different in appearance and color with the same functions.
<b>Power Supply</b>	DC 5V by car adapter DC 12/24V; DC 5V by AC/DC adapter 100~240V 50/60Hz DC 3.7V by battery;
<b>Frequency Range</b>	2402 MHz -2480MHz
<b>Modulation Type</b>	FHSS
<b>Antenna Type:</b>	Internal Fixed
<b>Channel Number</b>	79
<b>Temperature Range</b>	-20°C ~ 50°C

**NOTE:**

1. Please refer to Appendix I for the photographs of the EUT. For a more detailed features description about the EUT, please refer to User’s Manual.

## 2.2 Objective

The objective of the report is to perform tests according to 47 CFR Part 15 Subpart C for the EUT FCC ID Certification:

No.	Identity	Document Title
1	47 CFR Part 15 (10-1-05 Edition)	Radio Frequency Devices

## 2.3 Test Standards and Results

Test items and the results are as bellow:

No.	Section	Description	Result	Date of Test
1	15.249(a)	Spurious Emission	PASS	2010-10-22
2	15.249(a)	Band Edge	PASS	2010-10-21

Note: 1. The test result judgment is decided by the limit of measurement standard  
 2. The information of measurement uncertainty is available upon the customer's request.

## 2.4 Environmental Conditions

During the measurement the environmental conditions were within the listed ranges:

- Temperature: 15-35°C
- Humidity: 30-60 %
- Atmospheric pressure: 86-106 kPa

### 3. TEST FACILITY

#### 3.1 TEST FACILITY

Test Site:	Most Technology Service Co., Ltd.
Location:	No.5, Langshan 2nd Rd., North Hi-Tech Industrial park, Nanshan, Shenzhen, Guangdong, China
Description:	<p>There is one 3m semi-anechoic an area test sites and two line conducted labs for final test. The Open Area Test Sites and the Line Conducted labs are constructed and calibrated to meet the FCC requirements in documents ANSI C63.4:2003 and CISPR 16 requirements.</p> <p>The FCC Registration Number is <b>490827</b>.</p> <p>The <b>IC</b> Registration Number is <b>46405-7103</b>.</p> <p>The <b>CNAS</b> Registration Number is <b>CNAS L3573</b>.</p>
Site Filing:	The site description is on file with the Federal Communications Commission, 7435 Oakland Mills Road, Columbia, MD 21046.
Instrument Tolerance:	All measuring equipment is in accord with ANSI C63.4:2003 and CISPR 16 requirements that meet industry regulatory agency and accreditation agency requirement.
Ground Plane:	Two conductive reference ground planes were used during the Line Conducted Emission, one in vertical and the other in horizontal. The dimensions of these ground planes are as below. The vertical ground plane was placed distancing 40 cm to the rear of the wooden test table on where the EUT and the support equipment were placed during test. The horizontal ground plane projected 50 cm beyond the footprint of the EUT system and distanced 80 cm to the wooden test table. For Radiated Emission Test, one horizontal conductive ground plane extended at least 1m beyond the periphery of the EUT and the largest measuring antenna, and covered the entire area between the EUT and the antenna.

#### 3.2 GENERAL TEST PROCEDURES

##### EUT Function and Test Mode

The EUT has been tested under normal operating (TX) and standby (RX) condition.

The field strength of radiation emission was measured in the following position: EUT stand-up position (Y axis), lie-down position (X, Z axis).

The following data show only with the worst case setup.

The worst case of Y axis was reported.

Based on client request, all normal using modes of the normal function were tested but only the worst test data of the worst mode is reported by this report.

Radiated Emissions

The EUT is placed on a turn table, which is 0.8 m above ground plane. The turntable shall rotate 360 degrees to determine the position of maximum emission level. EUT is set 3m away from the receiving antenna, which varied from 1m to 4m to find out the highest emission. And also, each emission was to be maximized by changing the polarization of receiving antenna both horizontal and vertical. In order to find out the maximum emissions, exploratory radiated emission measurements were made according to the requirements in Section 13.1.4.1 of ANSI C63.4:2003.

**3.3 FCC PART 15.205 RESTRICTED BANDS OF OPERATIONS**

(a) Except as shown in paragraph (d) of this section, only spurious emissions are permitted in any of the frequency bands listed below:

MHz	MHz	MHz	GHz
0.090 - 0.110	16.42 - 16.423	399.9 - 410	4.5 - 5.15
<sup>1</sup> 0.495 - 0.505	16.69475 - 16.69525	608 - 614	5.35 - 5.46
2.1735 - 2.1905	16.80425 - 16.80475	960 - 1240	7.25 - 7.75
4.125 - 4.128	25.5 - 25.67	1300 - 1427	8.025 - 8.5
4.17725 - 4.17775	37.5 - 38.25	1435 - 1626.5	9.0 - 9.2
4.20725 - 4.20775	73 - 74.6	1645.5 - 1646.5	9.3 - 9.5
6.215 - 6.218	74.8 - 75.2	1660 - 1710	10.6 - 12.7
6.26775 - 6.26825	108 - 121.94	1718.8 - 1722.2	13.25 - 13.4
6.31175 - 6.31225	123 - 138	2200 - 2300	14.47 - 14.5
8.291 - 8.294	149.9 - 150.05	2310 - 2390	15.35 - 16.2
8.362 - 8.366	156.52475 - 156.52525	2483.5 - 2500	17.7 - 21.4
8.37625 - 8.38675	156.7 - 156.9	2655 - 2900	22.01 - 23.12
8.41425 - 8.41475	162.0125 - 167.17	3260 - 3267	23.6 - 24.0
12.29 - 12.293	167.72 - 173.2	3332 - 3339	31.2 - 31.8
12.51975 - 12.52025	240 - 285	3345.8 - 3358	36.43 - 36.5
12.57675 - 12.57725	322 - 335.4	3600 - 4400	( <sup>2</sup> )
13.36 - 13.41			

<sup>1</sup> Until February 1, 1999, this restricted band shall be 0.490-0.510 MHz.

<sup>2</sup> Above 38.6

(b) Except as provided in paragraphs (d) and (e), the field strength of emissions appearing within these frequency bands shall not exceed the limits shown in Section 15.209. At frequencies equal to or less than 1000 MHz, compliance with the limits in Section 15.209 shall be demonstrated using measurement instrumentation employing a CISPR quasi-peak detector. Above 1000 MHz, compliance with the emission limits in Section 15.209 shall be demonstrated based on the average value of the measured emissions. The provisions in Section 15.35 apply to these measurements.

#### 4. SETUP OF EQUIPMENT UNDER TEST

##### 4.1 SUPPORT EQUIPMENT

Device Type	Brand	Model	Series No.	Data Cable	Power Cord
SD Card	Transcend	1.0G	N/A		N/A

*Remark:*

*All the equipment/cables were placed in the worst-case configuration to maximize the emission during the test. Grounding was established in accordance with the manufacturer's requirements and conditions for the intended use.*



## 4.2 TEST EQUIPMENT LIST

**Instrumentation:** The following list contains equipment used at Most for testing. The equipment conforms to the CISPR 16-1 / ANSI C63.2 Specifications for Electromagnetic Interference and Field Strength Instrumentation from 10 kHz to 1.0 GHz or above.

No.	Equipment	Manufacturer	Model No.	S/N	Calculator due date
1	Test Receiver	Rohde & Schwarz	ESCI	100492	2011/03/14
2	L.I.S.N.	Rohde & Schwarz	ENV216	100093	2011/03/14
3	Coaxial Switch	Anritsu Corp	MP59B	6200283933	2011/03/14
4	Terminator	Hubersuhner	50Ω	No.1	2011/03/14
5	RF Cable	SchwarzBeck	N/A	No.1	2011/03/14
6	Test Receiver	Rohde & Schwarz	ESPI	101202	2011/03/14
7	Bilog Antenna	SCHWARZBECK	BBHA9120D	D69250	2011/03/14
8	Cable	Resenberger	N/A	NO.1	2011/03/14
9	Cable	SchwarzBeck	N/A	NO.2	2011/03/14
10	Cable	SchwarzBeck	N/A	NO.3	2011/03/14
11	DC Power Filter	DuoJi	DL2×30B	N/A	2011/03/14
12	Single Phase Power Line Filter	DuoJi	FNF 202B30	N/A	2011/03/14
13	3 Phase Power Line Filter	DuoJi	FNF 402B30	N/A	2011/03/14
14	Test Receiver	Rohde & Schwarz	ESCI	100492	2011/03/14
15	Absorbing Clamp	Luthi	MDS21	3635	2011/03/14
16	Coaxial Switch	Anritsu Corp	MP59B	6200283933	2011/03/14
17	AC Power Source	Kikusui	AC40MA	LM003232	2011/03/14
18	Test Analyzer	Kikusui	KHA1000	LM003720	2011/03/14
19	Line Impedance Network	Kikusui	LIN40MA-PCR-L	LM002352	2011/03/14
20	ESD Tester	Kikusui	KES4021	LM003537	2011/03/14
21	EMC PRO System	EM Test	UCS-500-M4	V0648102026	2011/03/14
22	Signal Generator	IFR	2032	203002/100	2011/03/14
23	Amplifier	A&R	150W1000	301584	2011/03/14
24	CDN	FCC	FCC-801-M2-25	47	2011/03/14
25	CDN	FCC	FCC-801-M3-25	107	2011/03/14
26	EM Injection Clamp	FCC	F-203I-23mm	403	2011/03/14
27	RF Cable	MIYAZAKI	N/A	No.1/No.2	2011/03/14
28	Universal Radio Communication Tester	ROHDE&SCHWARZ	CMU200	0304789	2011/03/14
29	Telecommunication Antenna	European Antennas	PSA 75301R/170	0304213	2011/03/14
30	Telecommunication Test Equipment	R&S	CMU200	N/A	2011/03/14
31	Loop Antenna	SCHWARZBECK	BBHA9120D	D69250	2011/03/14

**NOTE:** Equipments listed above have been calibrated and are in the period of validation.

## 5. 47 CFR Part 15C 15.249 Requirements

### 5.1 Spurious Emission Test

#### 5.1.1 Requirement

According to FCC section 15.249(a):

Except as provided in paragraph (a) of this section, the field strength of emissions from intentional radiators operated within these frequency bands shall comply with the following:

Fundamental Frequency (MHz)	Field Strength of Fundamental (mV/m)	Field Strength of Harmonics (µV/m)
902-928	50	500
2400-2483.5	50	500
5725-5875	50	500
24000-24250	250	2500

According to FCC section 15.209 (a), except as provided elsewhere in this subpart, the emissions from an intentional radiator shall not exceed the field strength levels specified in the following table:

Frequency (MHz)	Field Strength (µV/m)	Measurement Distance (m)
1.705 - 30.0	30	30
30 - 88	100	3
88 - 216	150	3
216 - 960	200	3
Above 960	500	3

**Remark:** Except as provided in paragraph (g), fundamental emissions from intentional radiators operating under this Section shall not be located in the frequency bands 54-72 MHz, 76-88 MHz, 174-216 MHz or 470-806 MHz. However, operation within these frequency bands is permitted under other sections of this Part, e.g., Sections 15.231 and 15.241.

In the above emission table, the tighter limit applies at the band edges.

Frequency (MHz)	Field Strength (µV/m)	Measurement Distance (m)
30 - 88	100	3
88 - 216	150	3
216 - 960	200	3
Above 960	500	3

### 5.1.2 Test Description

#### Test Setup:

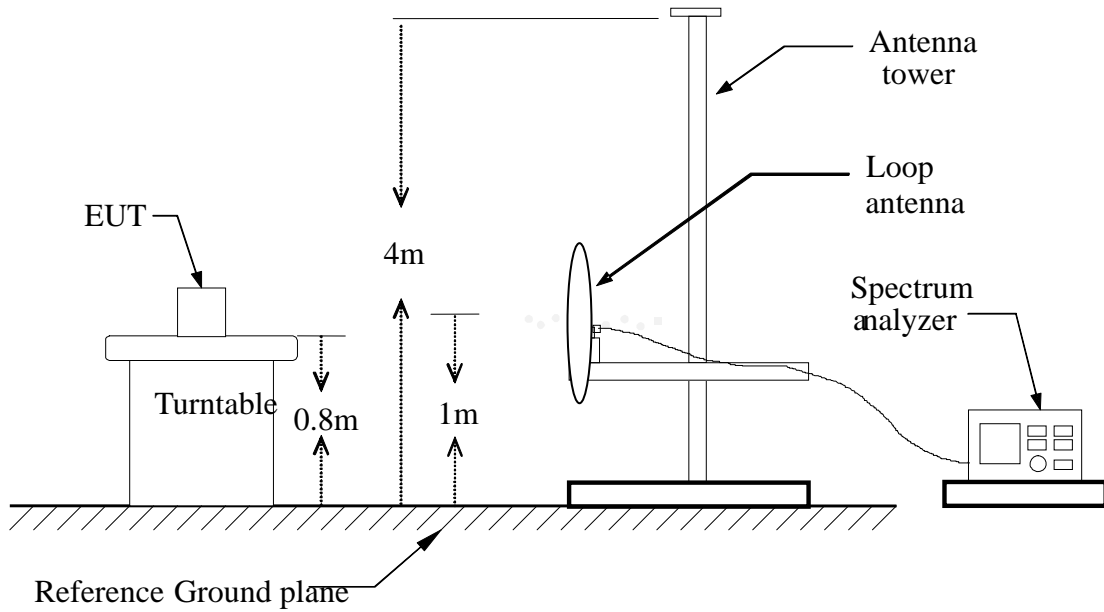

#### Blow 1GHz:

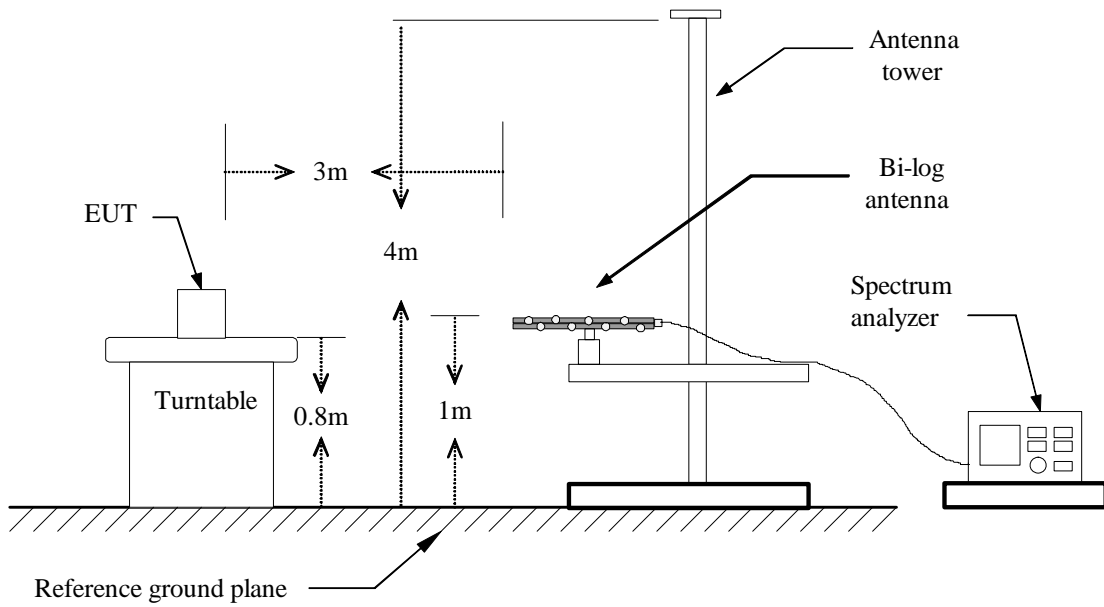

**Above 1GHz:**

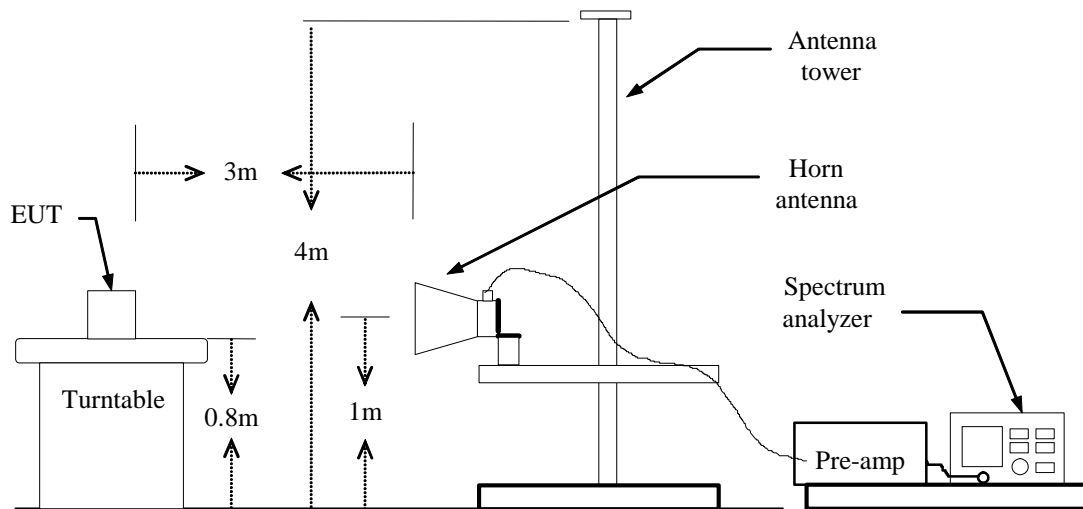

**5.1.3 Test Description**

1. The EUT is placed on a turntable, which is 0.8m above ground plane.
2. The turntable shall be rotated for 360 degrees to determine the position of maximum emission level.
3. EUT is set 3m away from the receiving antenna, which is varied from 1m to 4m to find out the highest emissions.
4. Maximum procedure was performed on the six highest emissions to ensure EUT compliance.
5. And also, each emission was to be maximized by changing the polarization of receiving antenna both horizontal and vertical.
6. Set the spectrum analyzer in the following setting as:  
 Below 1GHz: RBW=100 kHz / VBW=300 kHz / Sweep=AUTO  
 Above 1GHz : (a) PEAK: RBW=VBW=1MHz / Sweep=AUTO  
 (b) AVERAGE: RBW=1MHz / VBW=10Hz / Sweep=AUTO
7. Repeat above procedures until the measurements for all frequencies are complete.

5.1.4 Test Result



Address: No.5, Langshan 2nd Rd., North Hi-Tech Industrial park  
 Guangdong, China  
 Tel: 0755-86170306 Fax: 0755-86170310

Radiated Emission Measurement



Site: site MOST 3M  
 Limit: FCC Part15 B 3M Radiation  
 EUT: GPS Portable Navigation Device  
 M/N: PF86-5001  
 Mode: Bluetooth  
 Note:

Polarization: *Horizontal*  
 Power: AC 120V/60Hz  
 Temperature: 26  
 Humidity: 60 %  
 Distance:

No.	Mk.	Freq. MHz	Reading Level dBuV	Correct Factor dB	Measure- ment dBuV/m	Limit dBuV/m	Over dB	Antenna Height cm	Table Degree	Comment
1		71.7100	16.18	11.68	27.86	40.00	-12.14	peak		
2		127.0000	13.93	17.70	31.63	43.50	-11.87	peak		
3	*	139.6100	14.42	17.22	31.64	43.50	-11.86	peak		
4		238.5500	8.22	17.10	25.32	46.00	-20.68	peak		
5		544.1000	5.47	22.28	27.75	46.00	-18.25	peak		
6		753.6200	6.06	25.73	31.79	46.00	-14.21	peak		

\*:Maximum data    x:Over limit    !:over margin



Address: No.5, Langshan 2nd Rd., North Hi-Tech Industrial park  
 Guangdong, China  
 Tel: 0755-86170306 Fax: 0755-86170310

**Radiated Emission Measurement**



Site: site MOST 3M      Polarization: **Vertical**      Temperature: 26  
 Limit: FCC Part15 B 3M Radiation      Power: AC 120V/60Hz      Humidity: 60 %  
 EUT: GPS Portable Navigation Device      Distance:  
 MN: PF86-5001  
 Mode: Bluetooth  
 Note:

No. Mk.	Freq. MHz	Reading Level dBuV	Correct Factor dB	Measurement dBuV/m	Limit dBuV/m	Over dB	Detector	Antenna Height cm	Table Degree	Comment
1 *	43.5800	23.26	14.51	37.77	40.00	-2.23	peak			
2 !	140.5800	22.36	17.17	39.53	43.50	-3.97	peak			
3	371.4400	5.76	18.21	23.97	46.00	-22.03	peak			
4	565.4400	4.08	22.76	26.84	46.00	-19.16	peak			
5	745.8600	5.46	25.80	31.26	46.00	-14.74	peak			
6	850.6200	6.59	27.10	33.69	46.00	-12.31	peak			

\*:Maximum data    x:Over limit    !:over margin

**Above 1 GHz**

**Operation Mode:** CH Low  
**Temperature:** 20°C  
**Humidity:** 70 % RH

**Test Date:** October. 22, 2010  
**Tested by:** Petter Ping  
**Polarity:** Ver. / Hor.

Freq. (MHz)	Ant. Pol H/V	Peak Reading (dBuV)	AV Reading (dBuV)	Ant. / CL CF (dB)	Actual Fs		Peak Limit (dBuV/m)	AV Limit (dBuV/m)	AV Margin (dB)
					Peak (dBuV/m)	AV (dBuV/m)			
2402.05	H	87.81	78.79	9.08	96.89	87.87	114.00	94.00	-6.13
1420.50	H	55.67	29.73	5.58	61.25	35.31	74.00	54.00	-18.69
4805.00	H	48.69	29.12	16.54	67.85	45.66	74.00	54.00	-8.34
N/A									>20
2402.05	V	77.55	80.26	9.08	99.48	89.34	114.00	94.00	-4.66
2450.00	V	50.72	25.15	9.12	59.84	34.27	74.00	54.00	-19.73
4805.00	V	51.81	31.34	16.54	68.35	47.88	74.00	54.00	-6.12
N/A									>20

**Notes:**

1. Measuring frequencies from 1 GHz to the 10th harmonic of highest fundamental frequency.
2. Measurements above show only up to 6 maximum emissions noted, or would be lesser if no specific emissions from the EUT are recorded (ie: margin>20dB from the applicable limit) and considered that's already beyond the background noise floor.
3. Radiated emissions measured in frequency above 1000MHz were made with an instrument using Peak detector mode and average detector mode of the emission shown in Actual FS column.
4. Spectrum setting:
  - a. Peak Setting 1GHz - 26GHz, RBW = 1MHz, VBW = 1MHz, Sweep time = 200 ms.
  - b. AV Setting 1GH z- 26GHz, RBW = 1MHz, VBW = 10Hz, Sweep time = 200 ms.
5. No additional spurious emissions found between lowest internal generated and 30 MHz

**Operation Mode:** CH Mid  
**Temperature:** 20°C  
**Humidity:** 70 % RH

**Test Date:** October. 22, 2010  
**Tested by:** Petter Ping  
**Polarity:** Ver. / Hor.

Freq. (MHz)	Ant. Pol H/V	Peak Reading (dBuV)	AV Reading (dBuV)	Ant. / CL CF (dB)	Actual Fs		Peak Limit (dBuV/m)	AV Limit (dBuV/m)	AV Margin (dB)
					Peak	AV			
					(dBuV/m)	(dBuV/m)			
2442.00	H	90.66	81.13	9.12	99.78	90.25	114.00	94.00	-3.75
3492.50	H	53.65	22.69	12.73	66.38	35.42	74.00	54.00	-18.58
4884.50	H	53.54	28.31	17.04	70.58	45.35	74.00	54.00	-8.65
N/A									>20
2442.00	V	94.17	81.62	9.12	103.29	90.74	114.00	94.00	-3.26
1820.00	V	59.46	28.37	7.88	67.34	36.25	74.00	54.00	-17.75
4884.50	V	54.12	30.18	17.04	71.16	47.22	74.00	54.00	-6.78
N/A									>20

**Notes:**

1. Measuring frequencies from 1 GHz to the 10th harmonic of highest fundamental frequency.
2. Measurements above show only up to 6 maximum emissions noted, or would be lesser if no specific emissions from the EUT are recorded (ie: margin>20dB from the applicable limit) and considered that's already beyond the background noise floor.
3. Radiated emissions measured in frequency above 1000MHz were made with an instrument using Peak detector mode and average detector mode of the emission shown in Actual FS column.
4. Spectrum setting:
  - a. Peak Setting 1GHz - 26GHz, RBW = 1MHz, VBW = 1MHz, Sweep time = 200 ms.
  - b. AV Setting 1GH z- 26GHz, RBW = 1MHz, VBW = 10Hz, Sweep time = 200 ms.
5. No additional spurious emissions found between lowest internal generated and 30 MHz



**Operation Mode:** CH High  
**Temperature:** 20°C  
**Humidity:** 70 % RH

**Test Date:** October. 22, 2010  
**Tested by:** Petter Ping  
**Polarity:** Ver. / Hor.

Freq. (MHz)	Ant. Pol H/V	Peak Reading (dBuV)	AV Reading (dBuV)	Ant. / CL CF (dB)	Actual Fs		Peak Limit (dBuV/m)	AV Limit (dBuV/m)	AV Margin (dB)
					Peak (dBuV/m)	AV (dBuV/m)			
2480.00	H	86.22	81.95	9.15	95.37	91.10	114.00	94.00	-2.90
4960.50	H	54.72	31.24	17.59	72.31	48.83	74.00	54.00	-5.17
N/A									>20
2480.00	V	87.10	82.63	9.15	96.25	91.78	114.00	94.00	-2.22
4960.50	V	55.14	31.96	17.59	72.73	49.55	74.00	54.00	-4.45
N/A									>20

**Notes:**

1. Measuring frequencies from 1 GHz to the 10th harmonic of highest fundamental frequency.
2. Measurements above show only up to 6 maximum emissions noted, or would be lesser if no specific emissions from the EUT are recorded (ie: margin>20dB from the applicable limit) and considered that's already beyond the background noise floor.
3. Radiated emissions measured in frequency above 1000MHz were made with an instrument using Peak detector mode and average detector mode of the emission shown in Actual FS column.
4. Spectrum setting:
  - a. Peak Setting 1GHz - 26GHz, RBW = 1MHz, VBW = 1MHz, Sweep time = 200 ms.
  - b. AV Setting 1GH z- 26GHz, RBW = 1MHz, VBW = 10Hz, Sweep time = 200 ms.
5. No additional spurious emissions found between lowest internal generated and 30 MHz

## 5.2 Band Edge

### 5.2.1 Requirement

According to FCC section 15.249(a), in any 100kHz bandwidth outside the frequency band in which the spread spectrum or digitally modulated intentional radiator is operating, the radio frequency power that is produced by the intentional radiator shall be at least 20dB below that in the 100kHz bandwidth within the band that contains the highest level of the desired power, based on either an RF conducted or a radiated measurement.

### 5.2.2 Test Description

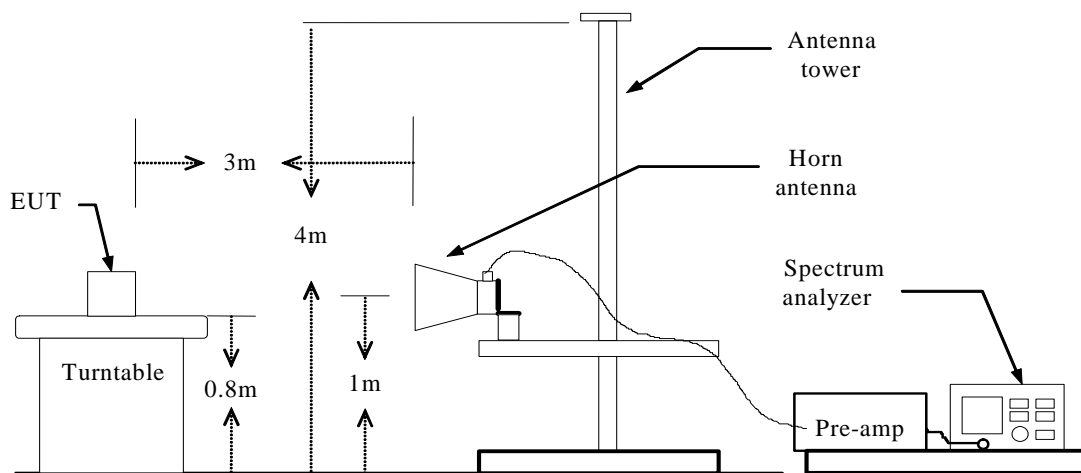

### 5.2.3 Test Result

The EUT operates at hopping-off test mode. The lowest and highest channels are tested to verify the band edge emissions.

Test Plot:

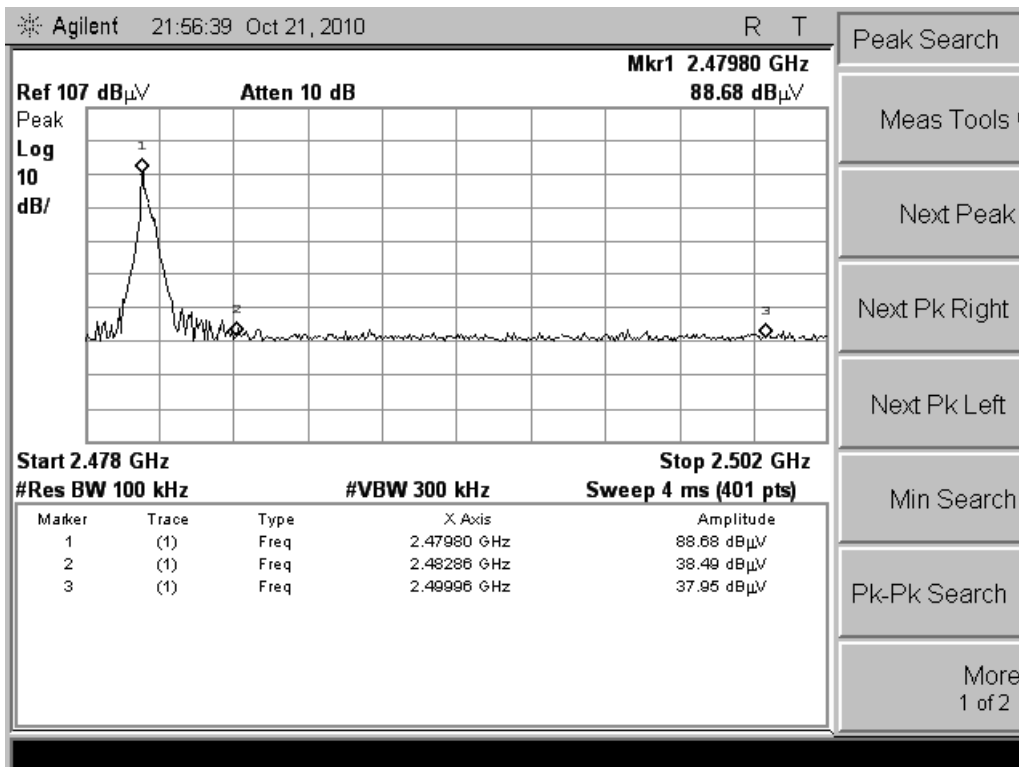
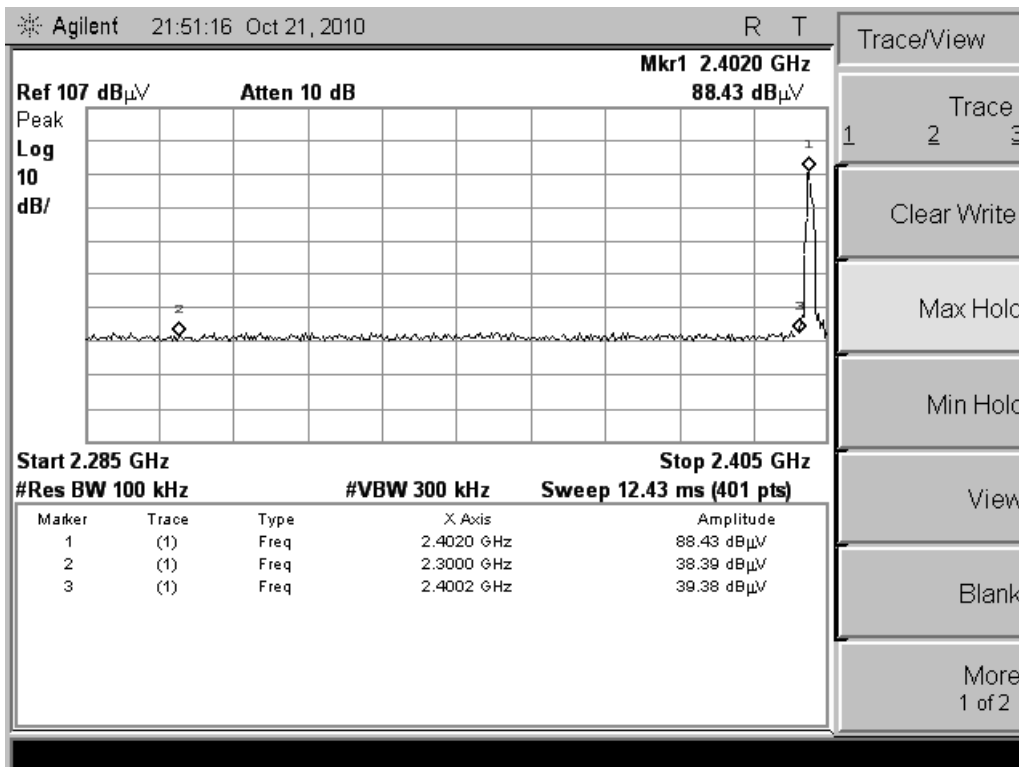

**APPENDIX 1**  
**PHOTOGRAPHS OF TEST SETUP**

Radiated Emission Test Setup

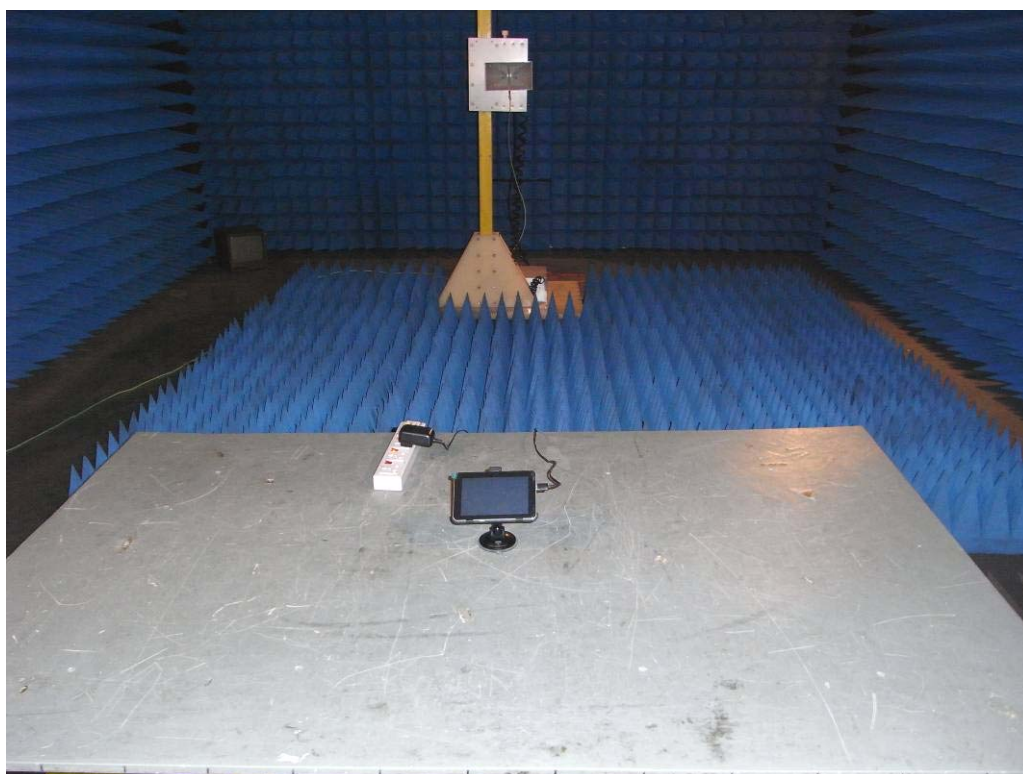
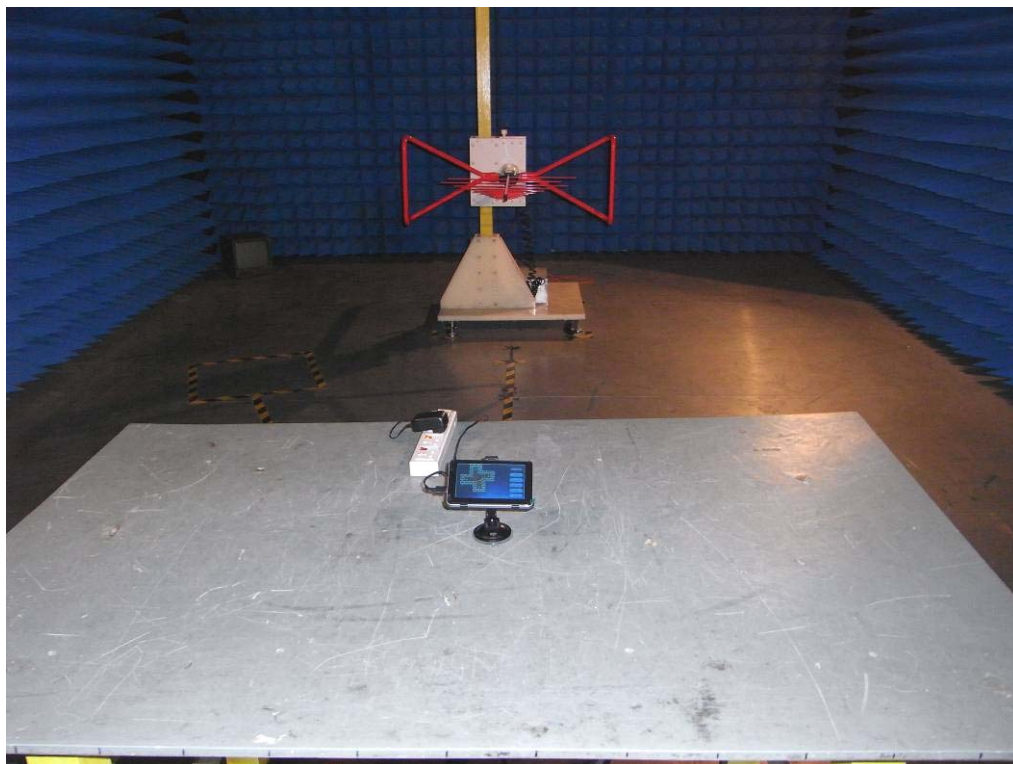

**APPENDIX 2  
PHOTOGRAPHS OF EUT**

FRONT VIEW OF SAMPLE



BACK VIEW OF SAMPLE



LEFT VIEW OF SAMPLE



RIGHT VIEW OF SAMPLE





TOP VIEW OF SAMPLE



BOTTOM VIEW OF SAMPLE



PHOTO OF POWER SUPPLY



PHOTO OF USB LINE



PHOTO OF CAR ADAPTOR



PHOTO OF TRESTLE TABLE



PHOTO OF THE ENTIRE SAMPLE



PHOTO OF THE BATTERY



INTERNAL PHOTO OF SAMPLE - 1

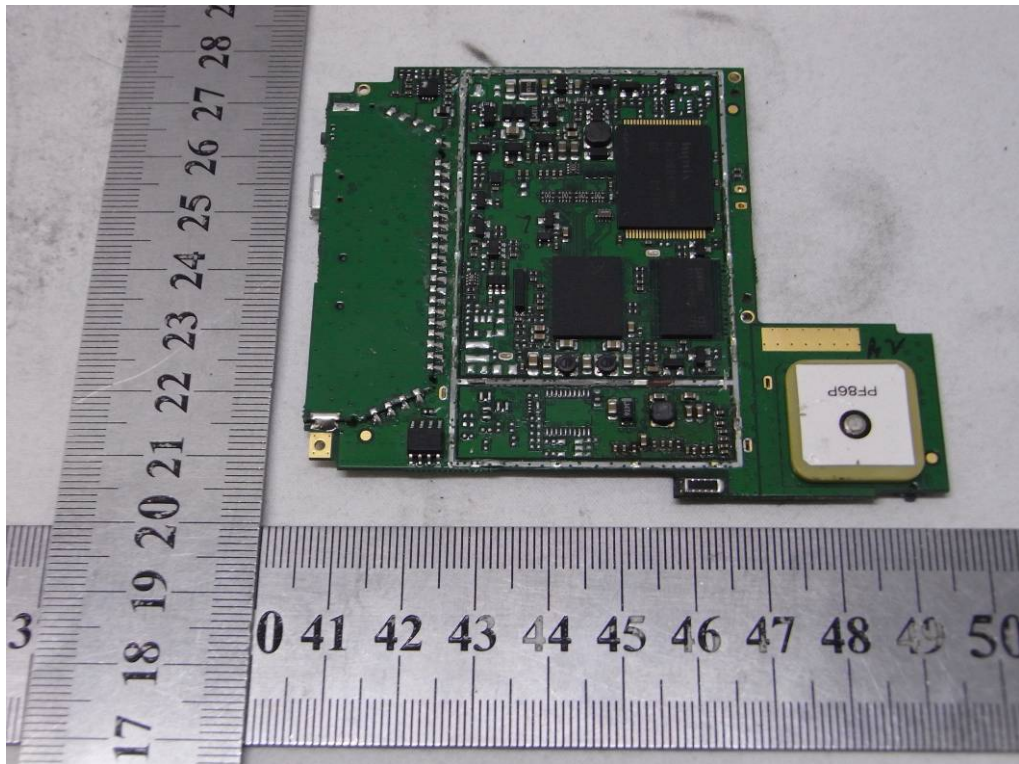

INTERNAL PHOTO OF SAMPLE - 2

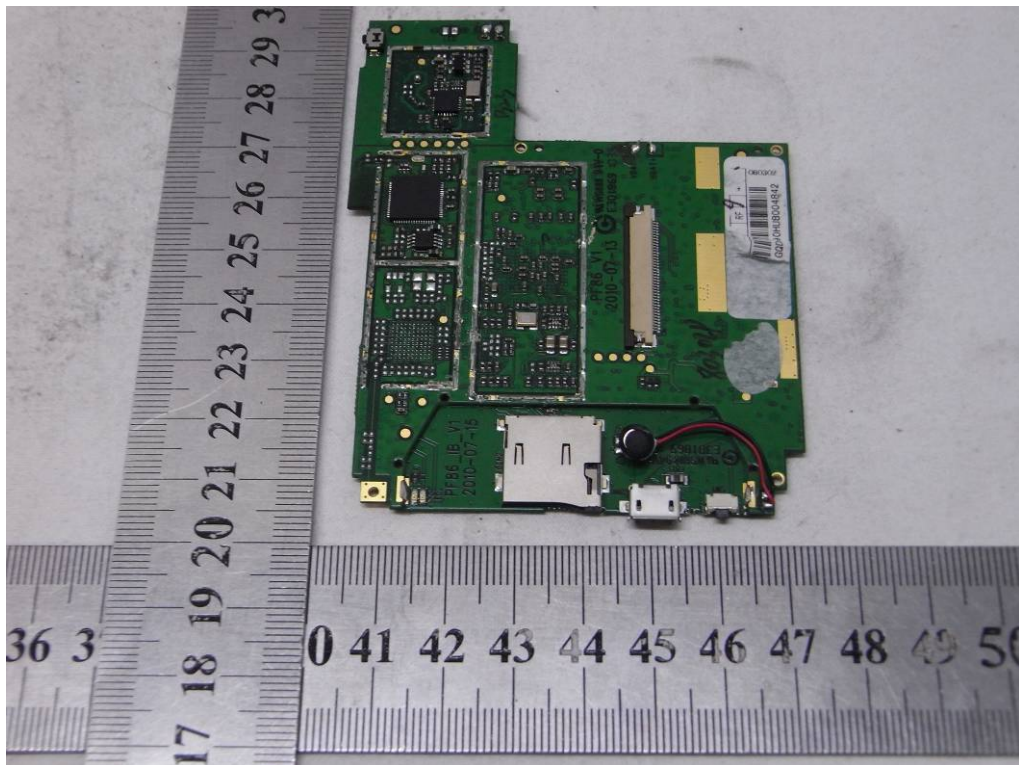

INTERNAL PHOTO OF SAMPLE - 3

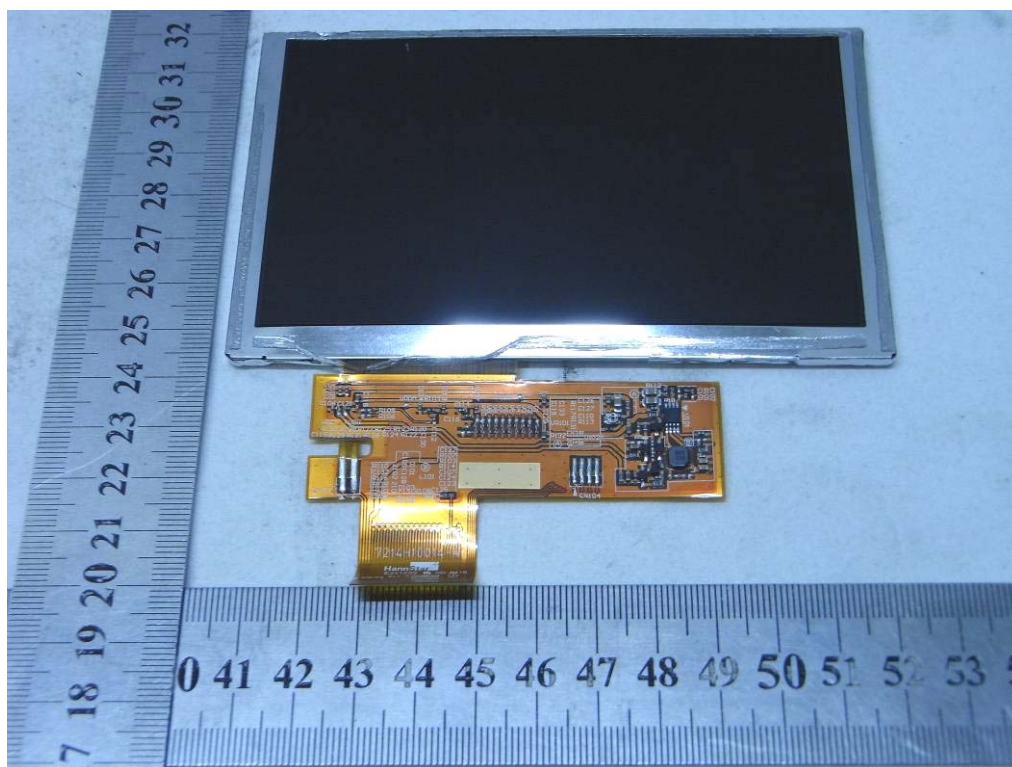

INTERNAL PHOTO OF SAMPLE - 4

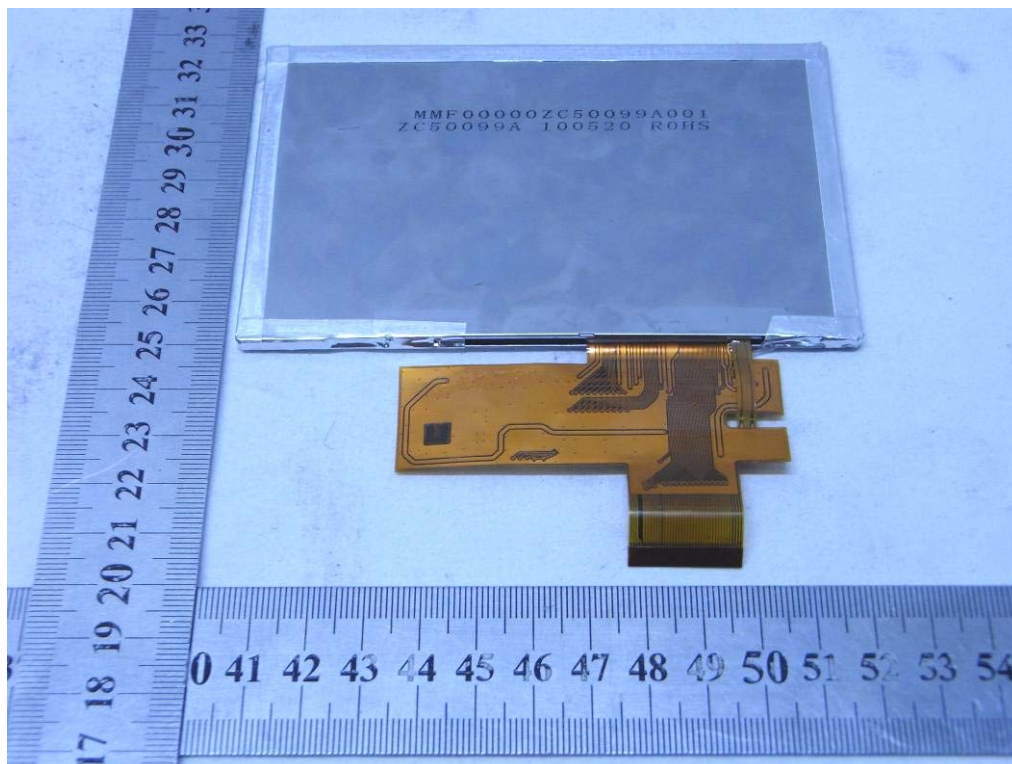

INTERNAL PHOTO OF POWER SUPPLY

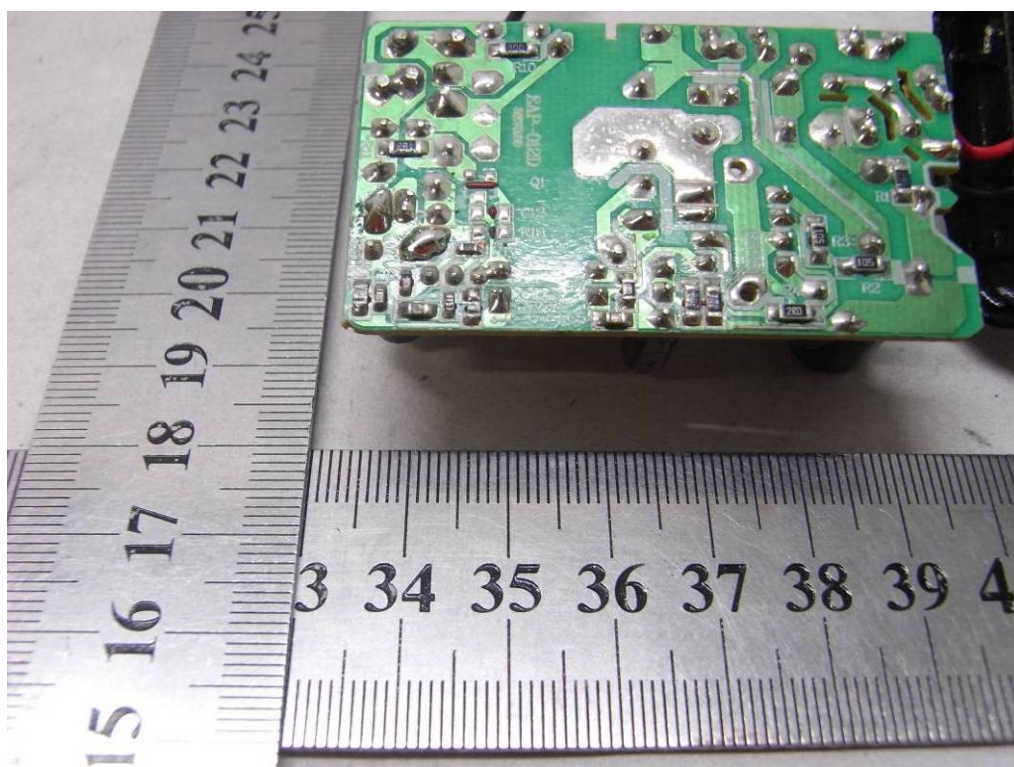
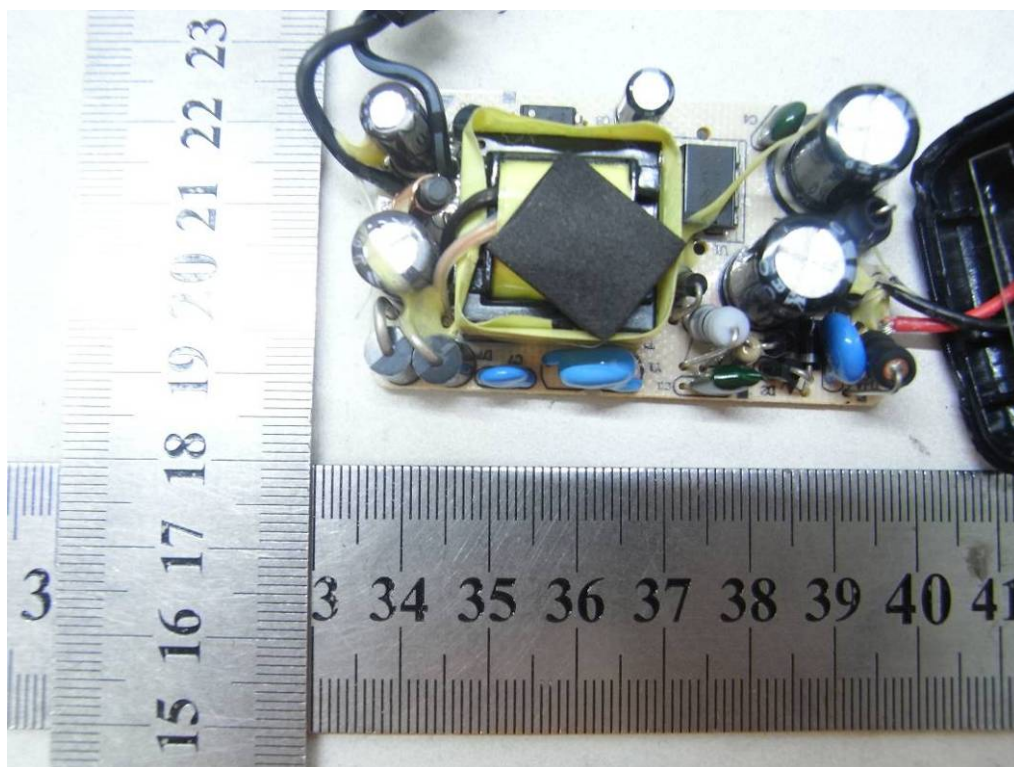

INTERNAL PHOTO OF CAR SUPPLY

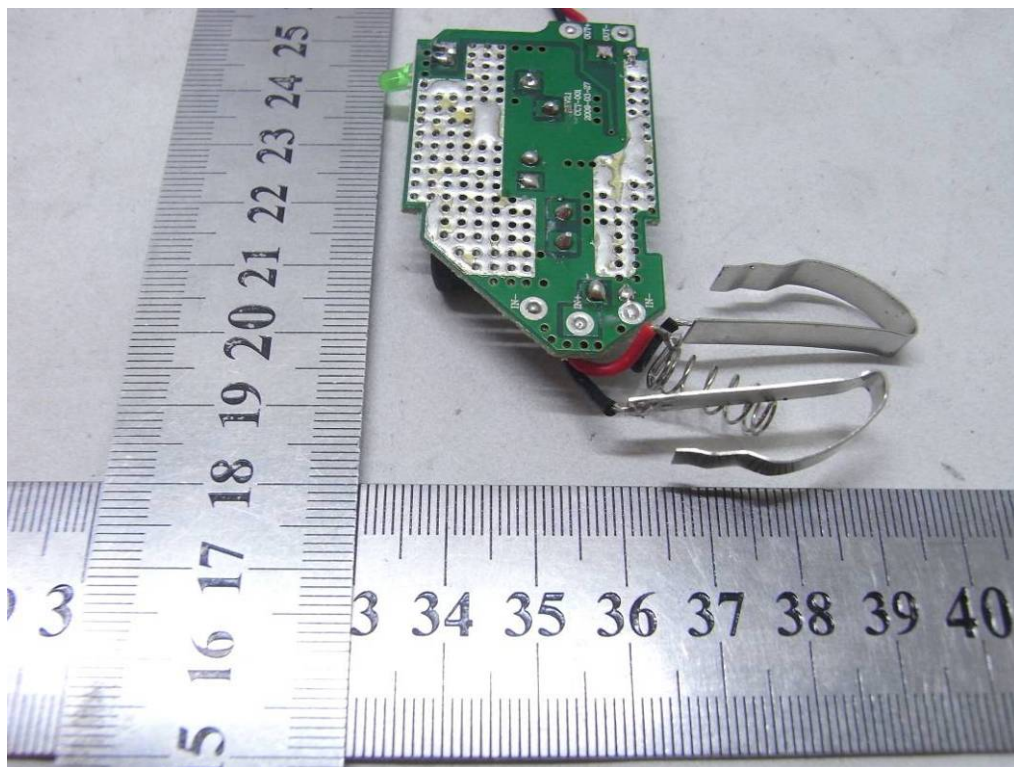
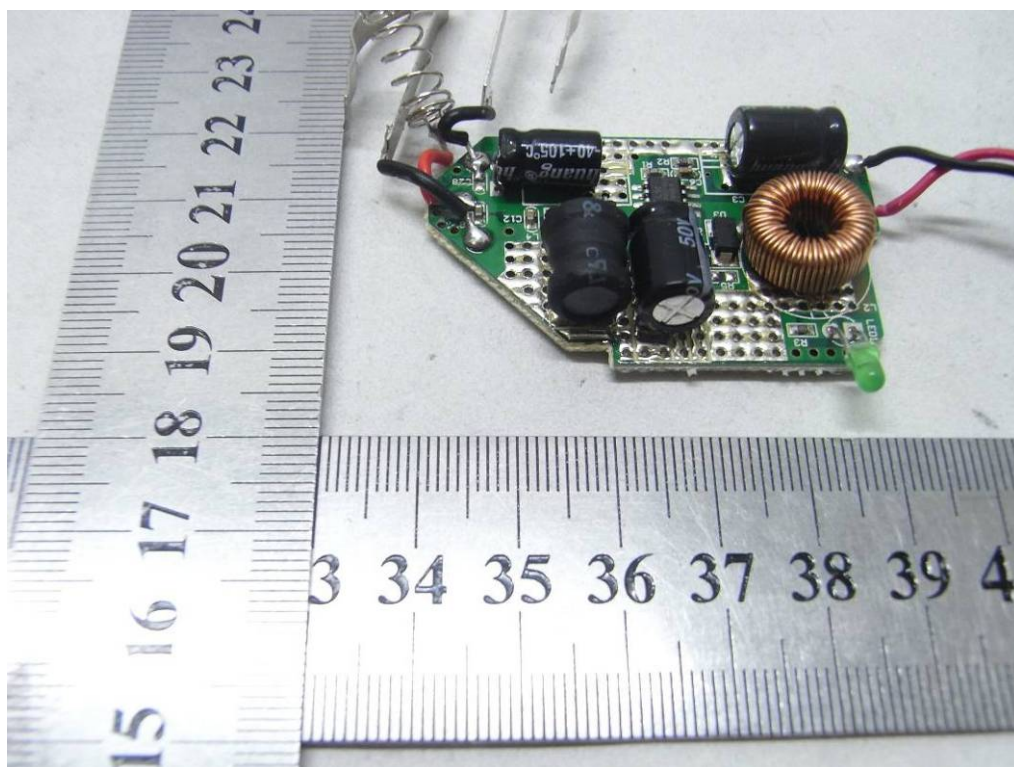

-----END OF REPORT-----