

Mobile phone

GRAND 5.5HD II

Use manual

Content

Get Started	4
Insert SIM card.....	4
Charge the Battery or Connect to PC	5
Keys and Parts	7
Back Touch.....	9
Lock and Unlock the Screen.....	10
Make it yours	11
Add Widgets and more icons to Home Screen.....	12
Add widgets and icons to home screen	12
Rearrange or remove widgets and icons on your Home screen	12

Add Folders on your Screen	13
Adjust Brightness	14
Make a Call	15
Call Log	16
Reject a Call by Sending a Busy Message .	17
Add a Contact	17
Messaging	18
Receive a New Message	19
Edit SMS and MMS.....	19
Message conversations.....	19
Browse the Web	20
Enjoy Music	21
Download Applications on Google Play ...	22
Manage Applications	23
System Updates	24

System Settings	25
Wireless & networks	25
Device	25
Personal	26
System	27
Maintenance & Safety	28
FCC warning:	31

Get Started

Insert SIM card

The phone is a Dual SIM mobile phone allowing you to use the facility of two networks.

1. Switch off the mobile phone.
2. Insert the SIM card correctly in the card slot(s) (See figure below)

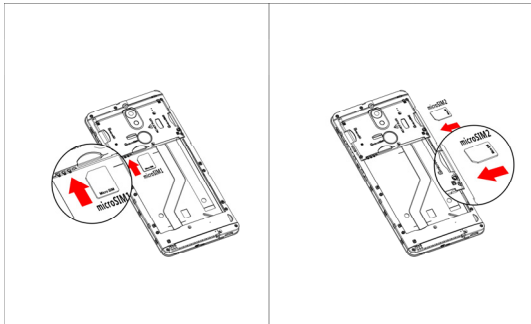

Charge the Battery or Connect to PC

You can charge your battery using the charger or connect the USB cable (supplied with this phone) to the computer.

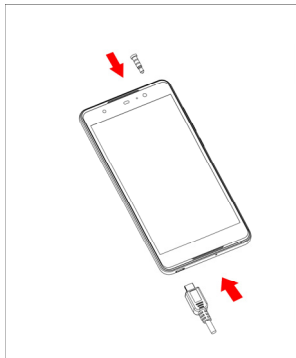

Keys and Parts

The smart phone gives you marvelous feelings to experience on Camera, Video recorder, FM radio, Music and Sound recorder. Let you install various APPs, games, and more (supports APK format) by downloading from Google Play Store.



1.Volume Up/Down Key	To adjust the ringer volume, adjust the voice volume during a call and adjust media volume.
2.Headsetport	To connect an earphone so you can listen to music or radio, etc.
3.Receiver	To hear the voice of the other side when calling.
4.Front Camera	Allow you to take pictures while facing the screen.
5.Power Key	Switch the phone on or off. Press and hold to open phone options menu.
6.BackKey	Go back to the previous screen. Close the on-screen keypad, a dialog box, an options menu, or the notification panel.
7.HomeKey	Go to home screen; Press and hold to open a window showing you most recently used applications.
8. MenuKey	Open a list of options available in the current screen or application.
9.USBjack	To connect charger or USB data cable for data exchange.
10.Back Camera lens	For taking photos.
11.Flashlight	To take photos in low-light conditions.
12.Back Touch	Single tap to take photos,long tap to switch the camera,and double tap to answer the call.

Back Touch

Back touch function includes three parts. During single tap image will be capture. For double tap, it will be answer the call. And on long tap camera screen will be switch. Enter Settings->back touch,turn on the function.

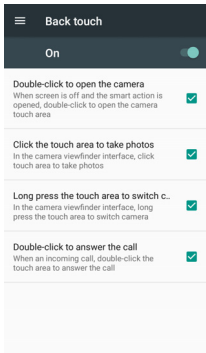

Lock and Unlock the Screen

Press power button to enter Sleep mode and meanwhile the screen will be locked; press power button again to wake up and then drag the lock to upwards to unlock.

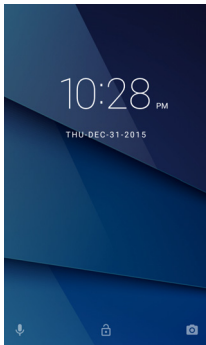

Make it yours

a) Home screen: It is your starting point to access all the features on your phone. It displays application icons, widgets, shortcuts, and other features. b) Notification Bar: At the top of the screen, the Status bar displays the time, status, and notifications. If there is a new message, missed call or something in the notification bar, you can drag it down to open notification panel and click the desired one to have a view. When you finished, you can close it by dragging the panel up or pressing "Back". c) Launcher: Touch the Launcher icon at the bottom of the screen to view all installed applications.

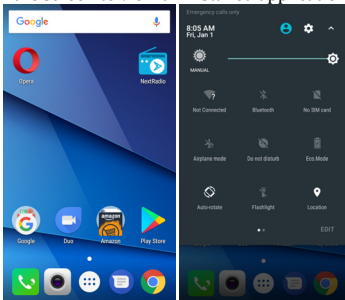

Add Widgets and more icons to Home Screen

Add widgets and icons to home screen

Enter Launcher and long press and hold an application till the app displays on the home screen, and then release your finger hold.

Rearrange or remove widgets and icons on your Home screen

Long press and hold the widget or icon you want to move. Once "Remove" appears, don't release your hold on the icon and drag the widget or icon to a new location on the screen.

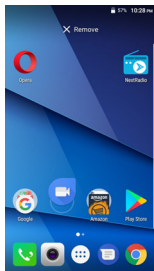

Add Folders on your Screen

Use folders to group related applications and other shortcuts to keep your Home screen tidy and organized.

Adding folder on your screen

Press and hold an application icon or a widget that you want to move. The phone then vibrates. Don't release your finger. Drag the application icon or widget and drop it on top of another application icon or widget.

Deleting folder

Drag out all the applications from the folder, then the folder will be deleted automatically.

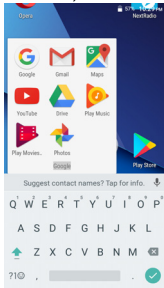

Adjust Brightness

Drag the notification panel down and adjust brightness. Or enter Settings->Display->Brightness level, and adjust the brightness level here (by dragging the brightness slider to the left to decrease or to the right to increase the screen Brightness).

Note: Lower the brightness of the screen to prolong the battery life.

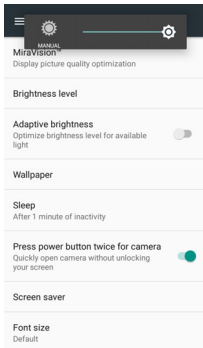

Make a Call

On the start screen choose , open dial pad then enter a complete phone number to make a call.

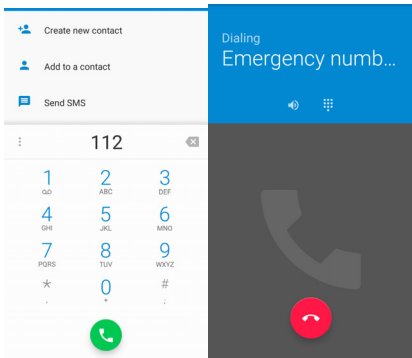

Call Log

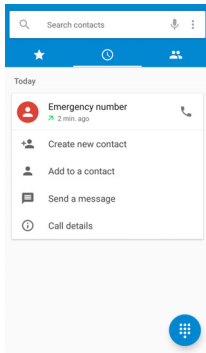

Enter Phone interface, then slide your screen right to , you can check the call logs. In call log options, you can Make calls, add createnew contact and send message etc.



Reject a Call by Sending a Busy Message

While there is an incoming call, you are inconvenient to accept the call, and then you can send a busy message for rejecting the call. Drag the circle up to , some busy messages will show on the screen, short tap any of them to send out.

Add a Contact

Tap  and enter Contacts and then add a contact (see figure below). Tap  to add a new contact to Phone or SIM card.

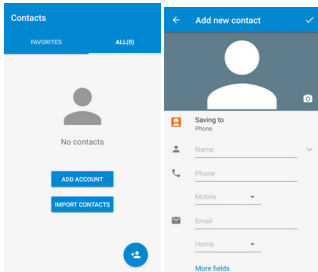

Messaging

Enter Messaging, and then compose new message. You touch a text field where you want to enter text, to open the keyboard.

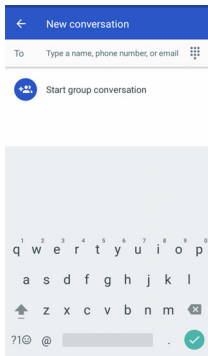

Receive a New Message

When there is a new message comes, a new message icon will appears in the notifications area of the status bar to notify you of a new text or multimedia message.

To open the message, press and hold the status bar, and then slide the status bar down to open the Notifications panel. Or go to Messaging, read the message directly.

Edit SMS and MMS

When you are composing a new text message, you can select text for cutting or copying. Touch the text field or portion that contains text. You can select all contexts, copy, cut and paste. The selected text is highlighted in Blue.

A multimedia message may contain video, pictures, audio, sideshow, etc. Thus, when you are supposed to edit a MMS, you can just add videos, pictures and more to SMS and change to MMS.

Message conversations

Text and multimedia messages that are sent to and received from acontact (or a number) are grouped into conversations or message threads in the All messages screen. Threaded SMS or MMS let you see exchanged messages (similar to a chat program) with a contact on the screen.

Browse the Web

Open the Chrome; click the URL on the screen to search or tap website address.

The browser is fully optimized and comes with advanced features that let you enjoy Internet browsing on your phone.

You must have an active data connection or Wi-Fi connection to access the Internet.

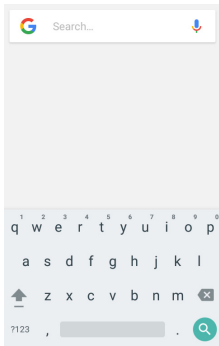

Enjoy Music

When you copy music to your Micro SD card, the Music player searches the device for music files and builds a catalog of your music, based on information about each file that is stored in the file itself.

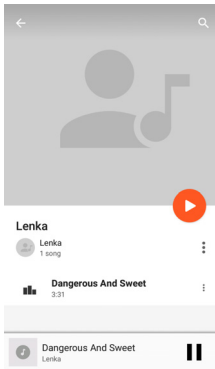

Download Applications on Google Play

Add a Google™ account and then Enter Google Play Store and download apps.

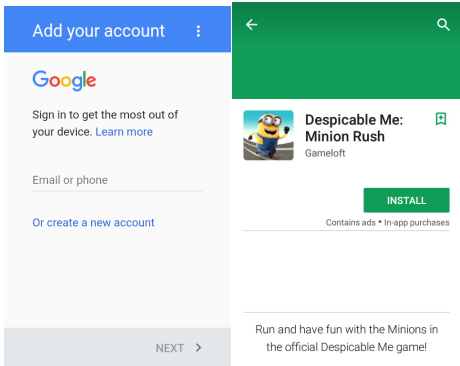

Manage Applications

Enter Setting >Apps, then manage the applications. Tap any app to view the information of the applications, and you can also force the apps to stop or uninstall the apps. To install Apps, you need switch on “Unknown sources” in Security settings.

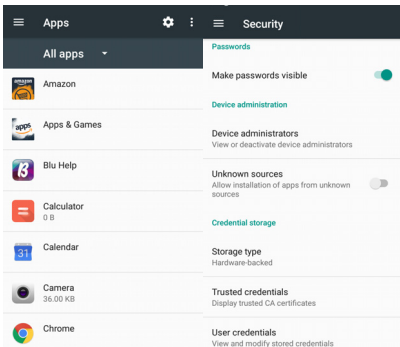

System Updates

Enter System Settings->About device and access SystemUpdates, the device will automatically search and check new version of software.

To update your current software, you must download new software online. The device will be in Recovery mode and will start to update the system after successfully downloading the new software. Then the device will reboot once system updating is complete, a pop-up message will appear to notify that the device has been successfully updated.

Note: Ensure you switch on Wi-Fi or Data connection.

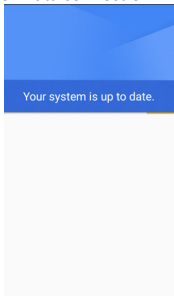

System Settings

Wireless & networks

You can customize wireless & network settings here, including:

1. WLAN

Turn on or turn off WLAN here. Set up and manage wireless access points here.

2. Bluetooth

Turn on or turn off Bluetooth here. Scan for devices and then it will show the scanned devices. Choose a device to pair and then you can send or receive information via Bluetooth.

3. SIM cards

4. Data usage

5. More...

◆ Airplane mode

◆ Tethering & portable hotspot

◆ VPN

Share your phone's mobile data connection via USB or as a portable Wi-Fi hotspot.

◆ Cellular networks

Set options for Data connection, 3G services, preferred networks, APN, etc.

Device

1. Display

You can define your wallpaper and set, brightness level, sleep, etc.

2. Sound & notification

Access this sub-menu to change volumes, phone ringtone, vibrate when ringing, default notification sound, touch sounds, dial pad touch tones, etc.

3. Apps

You can manage installed application here.

4. Storage

You can check out the space of your phone or SD card here.

5. Battery

You can see the use of the battery.

6. Memory

You can check out the performance of your memory used

7.Users

Personal

1.Back touch

2.Location

Let apps use Google location service to estimate your location faster. Anonymous location data will be collected and sent to Google.

3. Security

◆ Device security

◆ Encryption

◆ SIM card lock

- ◆ Passwords
- ◆ Device administration
- ◆ Credential storage
- ◆ Advanced
- 4. Accounts
- 5. Language & input
Select language and input method.
- 6. backup and reset
 - ◆ Backup my data
 - ◆ Backup account
 - ◆ Automatic restore
 - ◆ Network settings reset
 - ◆ Factory data reset:
- 7. Google

System

1. Date & time
2. Scheduled power on and off
3. Accessibility
4. Printing
5. About device

Maintenance & Safety

Please read and observe the following information for safe and proper use of your phone and to prevent damage. Also, keep the user guide in an accessible place at all the times after reading it.

1. After sales service

Kindly refer to the Warranty Card provided in the sales package box.

2. Charger and Adapter Safety

Charger and adapter are designed for indoor use only.

3. Battery Information and Care

- Please use the specific battery, otherwise it will cause explosion.
- Please dispose of your battery properly.
- Do not disassemble or short-circuit the battery.
- Keep the battery's metal contacts clean.
- Recharge the battery after long periods of non-use to maximize battery life.
- Battery life will vary due to usage patterns and environmental conditions.
- The self-protection function of the battery cuts the power of the phone when its operation is in an abnormal status. In this case, remove the battery from the phone, reinsert it, and turn the phone on.

4. General Notice

- Using a damaged battery or placing a battery in your mouth may cause serious injury.
- The suitable temperature for the phone and accessories is $-10^{\circ}\text{C}\sim 45^{\circ}\text{C}$.
- When charging, please place the phone in an environment that has a normal room temperature and good ventilation. It is recommended to charge the phone in an environment with a temperature under 40°C . Please ensure to use only the charger offered by the manufacturer. Using unauthorized charger may cause danger and violate the authorization of the phone and the guarantee article.
- Do not place items containing magnetic components such as a credit card, phone card, bank book, or subway ticket near your phone. The magnetism of the phone may damage the data stored in the magnetic strip.
- Talking on your phone for long period of time may reduce call quality due to heat generated during use.
- When the phone is not used for a long period time, store it in a safe place with the power cord unplugged.
- Using the phone in proximity to receiving equipment (i.e. TV or Radio) may cause interference to the phone.
- Do not immerse your phone in water. If this happens, remove the battery and take it to an Authorized Service Center.
- Do not paint your phone.

- The data saved in your phone might be deleted due to careless use, repair of the phone, or upgrade of the software. Please backup your important phone numbers. (Ring tones, text messages, voice messages, picture, and videos could also be deleted.) The manufacturer is not liable for damage due to the loss of data.
- Do not turn your phone on or off when the phone is close to your ear.

Warning: Company will not bear any responsibility for any incompliance with the above guidelines or improper use of the mobile phone. Our company keeps the right to make modifications to any of the content here in this user guide without public announcement in advance. The content of this manual may vary from the actual content displayed in the device. In such case, the latter shall govern.

Google, Android and Google Play are trademarks of Google Inc.

FCC warning:

Any Changes or modifications not expressly approved by the party responsible for compliance could void the user's authority to operate the equipment.

This device complies with part 15 of the FCC Rules. Operation is subject to the following two conditions: (1) This device may not cause harmful interference, and (2) this device must accept any interference received, including interference that may cause undesired operation.

Specific Absorption Rate (SAR) information

SAR tests are conducted using standard operating positions accepted by the FCC with the phone transmitting at its highest certified power level in all tested frequency bands, although the SAR is determined at the highest certified power level, the actual SAR level of the phone while operating can be well below the maximum value, in general, the closer you are to a wireless base station antenna, the lower the power output.

Before a new model phone is available for sale to the public, it must be tested and certified to the FCC that it does not exceed the exposure limit established by the FCC, Tests for each phone are performed in positions and locations (e.g. at the ear and worn on the body) as required by the FCC.

For body worn operation, this model phone has been tested and meets the FCC RF exposure guidelines when used with an accessory designated for this product or when used with an accessory that contains no metal and that positions the handset a minimum of 1.0 cm from the body.

Non-compliance with the above restrictions may result in violation of RF exposure guidelines.

Note: This equipment has been tested and found to comply with the limits for a Class B digital device, pursuant to part 15 of the FCC Rules. These limits are designed to provide reasonable protection against harmful interference in a residential installation.

This equipment generates, uses and can radiate radio frequency energy and, if not installed and used in accordance with the instructions, may cause harmful interference to radio communications. However, there is no guarantee that interference will not occur in a particular installation. If this equipment does cause harmful interference to radio or television reception, which can be determined by turning the equipment off and on, the user is encouraged to try to correct the interference by one or more of the following measures:

- Reorient or relocate the receiving antenna.
- Increase the separation between the equipment and receiver.
- Connect the equipment into an outlet on a circuit different from that to which the receiver is connected.
- Consult the dealer or an experienced radio/TV technician for help.