



# FCC RADIO TEST REPORT

Applicant : AOPEN Inc.  
Address : 5F., No.15, Ln. 128, Sinhu 1st Rd., Neihu District,  
Taipei City 114, Taiwan(R.O.C.)  
Equipment : AOPEN Chromebox Mini Commercial  
Model No. : ME4100  
Trade Name : AOPEN  
FCC ID. : YEW-ME4100CM389

**I HEREBY CERTIFY THAT :**

The sample was received on Feb. 11, 2017 and the testing was carried out on Feb. 22, 2017 at CerpPASS Technology Corp. The test result refers exclusively to the test presented test model / sample. Without written approval of CerpPASS Technology Corp., the test report shall not be reproduced except in full.

Approved by:

Mark Liao / Assistant Manager

Tested by:

Spree Yei / Engineer

Laboratory Accreditation:

CerpPASS Technology Corporation Test Laboratory





Contents

- 1. **Summary of Test Procedure and Test Results.....5**
  - 1.1 Applicable Standards ..... 5
- 2. **Test Configuration of Equipment under Test.....6**
  - 2.1 Feature of Equipment under Test..... 6
  - 2.2 Carrier Frequency of Channels .....7
  - 2.3 Test Mode and Test Software ..... 7
  - 2.4 Description of Test System.....7
  - 2.5 General Information of Test..... 8
- 3. **Test Equipment and Ancillaries Used for Tests .....9**
- 4. **Antenna Requirements.....9**
  - 4.1 Standard Applicable ..... 10
  - 4.2 Antenna Construction and Directional Gain.....10
- 5. **Test of AC Power Line Conducted Emission .....11**
  - 5.1 Test Limit ..... 11
  - 5.2 Test Procedures ..... 11
  - 5.3 Typical Test Setup ..... 12
  - 5.4 Test Result and Data ..... 13
  - 5.5 Test Photographs ..... 15
- 6. **Test of Spurious Emission (Radiated) .....16**
  - 6.1 Test Limit ..... 16
  - 6.2 Test Procedures ..... 16
  - 6.3 Typical Test Setup ..... 17
  - 6.4 Test Result and Data (9kHz ~ 30MHz)..... 18
  - 6.5 Test Result and Data (30MHz ~ 1GHz)..... 18
  - 6.6 Test Result and Data (1GHz ~ 25GHz)..... 20
  - 6.7 Restricted Bands of Operation ..... 26
  - 6.8 Test Photographs (30MHz ~ 1GHz) ..... 27
  - 6.9 Test Photographs (1GHz ~ 25GHz) ..... 28
- 7. **Test of Spurious Emission (Conducted).....29**
  - 7.1 Test Limit ..... 29
  - 7.2 Test Procedure ..... 29
  - 7.3 Test Setup Layout ..... 29
  - 7.4 Test Result and Data ..... 29
- 8. **6dB Bandwidth Measurement Data .....32**
  - 8.1 Test Limit ..... 32
  - 8.2 Test Procedures ..... 32
  - 8.3 Test Setup Layout ..... 32
  - 8.4 Test Result and Data ..... 32
- 9. **Maximum Peak and Average Output Power .....34**
  - 9.1 Test Limit ..... 34
  - 9.2 Test Procedures ..... 34
  - 9.3 Test Setup Layout ..... 34
  - 9.4 Test Result and Data ..... 34



10. Power Spectral Density ..... 35

10.1 Test Limit ..... 35

10.2 Test Procedures ..... 35

10.3 Test Setup Layout ..... 35

10.4 Test Result and Data ..... 35



### History of this test report

Attachment No.	Issue Date	Description
TEFQ1701084	Mar. 09, 2017	Original



# 1. Summary of Test Procedure and Test Results

## 1.1 Applicable Standards

ANSI C63.4:2014

ANSI C63.10:2013

FCC Rules and Regulations Part 15 Subpart C §15.247

FCC Rule	Description of Test	Result
15.203	. Antenna Requirement	Pass
15.207	. AC Power Line Conducted Emission	Pass
15.209 15.205	. Radiated Spurious Emission	Pass
15.247(d)	. Conducted Spurious Emission	Pass
15.247(a)(2)	. 6dB Bandwidth	Pass
15.247(b)	. Maximum Peak Output Power	Pass
15.247(e)	. Power Spectral Density	Pass

This EUT has been also tested and compiled with the requirement of FCC Part 15, Subpart B, recorded in a separate test report.



## 2. Test Configuration of Equipment under Test

### 2.1 Feature of Equipment under Test

WLAN Module	AzureWave / AW-CM389NF	
Frequency Range	2.4 GHz ISM radio band / 5 GHz Unlicensed National Information Infrastructure (U-NII) band	
Number of Channels	802.11ac: USA-4 802.11a: USA, Taiwan – 12/4 Most European Countries –19 Japan – 4 802.11b: USA, Canada and Taiwan – 11 Most European Countries – 13 France – 4 802.11g: USA, Canada and Taiwan – 11 Most European Countries – 13 Japan – 13 802.11n(HT20): Channel 1~13(2412~2472) 802.11n(HT40): Channel 1~7(2422~2452)	
Modulation	DSSS, OFDM, DBPSK, DQPSK, CCK, 16-QAM, 64-QAM and 256-QAM for WLAN GFSK (1Mbps), $\pi/4$ DQPSK (2Mbps) and 8DPSK (3Mbps) for Bluetooth	
Data Rates	WLAN 802.11b: 1, 2, 5.5, 11Mbps 802.11a/g: 6, 9, 12, 18, 24, 36, 48, 54Mbps 802.11n: up to 150Mbps-single 802.11n: up to 300Mbps-2x2 MIMO 802.11ac:up to 192.6Mbps (20MHz channel) 802.11ac:up to 400Mbps (40MHz channel) 802.11ac:up to 866.7Mbps (80MHz channel) Bluetooth Bluetooth 2.1+EDR data rates of 1,2, and 3Mbps NFC NFC data rates up to 848Kbps	
Antenna Type/ gain	Dipole antenna / 1.92dBi	
Adapter	Model No.	ADP-40KD BB
	INPUT	100-240V~1.2A, 50-60Hz
	OUTPUT	19V, 2.1A

Note: for more details, please refer to the User's manual of the EUT.



### 2.2 Carrier Frequency of Channels

Channel	Frequency (MHz)	Channel	Frequency (MHz)	Channel	Frequency (MHz)
<b>*00</b>	<b>2402</b>	14	2430	28	2458
01	2404	15	2432	29	2460
02	2406	16	2434	30	2462
03	2408	17	2436	31	2464
04	2410	18	2438	32	2466
05	2412	<b>*19</b>	<b>2440</b>	33	2468
06	2414	20	2442	34	2470
07	2416	21	2444	35	2472
08	2418	22	2446	36	2474
09	2420	23	2448	37	2476
10	2422	24	2450	38	2478
11	2424	25	2452	<b>*39</b>	<b>2480</b>
12	2426	26	2454	--	--
13	2428	27	2456	--	--

Note: Channels remarked \* are selected to perform test.

### 2.3 Test Mode and Test Software

- a. During testing, the interface cables and equipment positions were varied according to ANSI C63.4.
- b. The complete test system included EUT for RF test.
- c. An executive program, "Dut labtool V2.0.0.44" under Chrome was executed to transmit and receive data via Bluetooth.
- d. The following test mode was performed for the test:  
Test Mode 1. GFSK (1Mbps)

### 2.4 Description of Test System

The EUT was tested alone. No support devices is needed for testing.



### 2.5 General Information of Test

Test Site	<b>Cerpass Technology Corporation Test Laboratory</b> Address: No.10, Ln. 2, Lianfu St., Luzhu Dist., Taoyuan City 33848, Taiwan (R.O.C.) Tel:+886-3-3226-888 Fax:+886-3-3226-881 Address: No.68-1, Shihbachongsi, Shihding Township, New Taipei City 223, Taiwan, R.O.C. Tel: +886-2-2663-8582	
	FCC	TW1079, TW1061, 390316, 228391, 641184
	IC	4934E-1, 4934E-2
	VCCI	T-2205 for Telecommunication Test C-4663 for Conducted emission test R-4218, R-4399 for Radiated emission test G-812, G-813 for radiated disturbance above 1GHz
Frequency Range Investigated:	Conducted: from 150kHz to 30 MHz Radiation: from 30 MHz to 25,000MHz	
Test Distance:	The test distance of radiated emission from antenna to EUT is 3 M.	





### 3. Test Equipment and Ancillaries Used for Tests

Instrument	Manufacturer	Model No.	Serial No.	Calibration Date	Valid Date
EMI Receiver	R&S	ESCI3	100443	2016/03/28	2017/03/27
LISN	Schwarzbeck	NSLK 8127	8127-740	2016/08/30	2017/08/29
LISN	Schwarzbeck	NSLK 8127	8127-516	2016/09/06	2017/09/05
Pulse Limiter	R&S	ESH3-Z2	101934	2017/02/14	2018/02/13
Bilog Antenna	Schwarzbeck	VULB9168	369	2016/03/22	2017/03/21
Active Loop Antenna	EMCO	6507	40855	2016/05/11	2017/05/10
Horn Antenna	EMCO	3115	31601	2016/09/05	2017/09/04
Horn Antenna	EMCO	3116	31970	2016/03/18	2017/03/17
EXA Signal Analyzer	KEYSIGHT	N9010A	MY54200207	2016/03/16	2017/03/15
Preamplifier	EM	EM330	660	2016/03/16	2017/03/15
Preamplifier	EMC INSTRUMENTS	EMC051845SE	980333	2016/09/13	2017/09/12
Preamplifier	Agilent	8449B	3008A01954	2017/02/09	2018/02/08
Preamplifier	MITEQ	AMF-7D-00101 00-30-10P	1860212	2016/03/16	2017/03/15
Preamplifier	EMC INSTRUMENTS	EMC184045	980065	2016/11/04	2017/11/03
MXG MW Analog Signal Generator	KEYSIGHT	N5183A	MY50142931	2016/03/18	2017/03/17
Spectrum Analyzer	R&S	FSP40	100219	2016/09/01	2017/08/31
Bluetooth Tester	R&S	CBT	101133	2016/03/18	2017/03/17
Attenuator	KEYSIGHT	8491B	MY39250703	2016/03/07	2017/03/06
Rotary Attenuator	Agilent	8494B	MY42154466	2016/03/08	2017/03/07
Rotary Attenuator	Agilent	8495B	MY42146680	2016/03/08	2017/03/07
Temp & Humi chamber	T-MACHINE	TMJ-9712	T-12-040111	2016/09/05	2017/09/04
Series Power Meter	Anritsu	ML2495A	1224005	2016/03/03	2017/03/02
Power Sensor	Anritsu	MA2411B	1207295	2016/03/03	2017/03/02
Cable	HUBER SUHNER	SUCOFLEX 102	28422/2	2016/03/15	2017/03/14
Cable	HUBER SUHNER	SUCOFLEX 102	28418/2	2016/03/16	2017/03/15
Cable	HUBER SUHNER	SUCOFLEX 102	28417/2	2016/03/04	2017/03/03
Software	Farad	Ez-EMC	ver.ct3a1	N/A	N/A
Software	AUDIX	E3	V8.2014-8-6	N/A	N/A
Software	Keysight	N7607B Signal Studio	v2.0.0.1	N/A	N/A
Software	Keysight	Inservice MonitorUtility	N/A	N/A	N/A



## 4. Antenna Requirements

### 4.1 Standard Applicable

For intentional device, according to FCC 47 CFR Section 15.203, an intentional radiator shall be designed to ensure that no antenna other than that furnished by the responsible party shall be used with the device.

And according to FCC 47 CFR Section 15.247 (b), if transmitting antennas of directional gain greater than 6dBi are used, the power shall be reduced by the amount in dB that the directional gain of the antenna exceeds 6dBi.

### 4.2 Antenna Construction and Directional Gain

Antenna Type	Antenna Gain
Dipole Antenna	1.92 dBi



## 5. Test of AC Power Line Conducted Emission

### 5.1 Test Limit

Conducted Emissions were measured from 150 kHz to 30 MHz with a bandwidth of 9 KHz, according to the methods defined in ANSI C63.4-2014. The EUT was placed on a nonmetallic stand in a shielded room 0.8 meters above the ground plane. The interface cables and equipment positioning were varied within limits of reasonable applications to determine the position produced maximum conducted emissions.

Frequency (MHz)	Quasi Peak (dB $\mu$ V)	Average (dB $\mu$ V)
0.15 – 0.5	66-56*	56-46*
0.5 – 5.0	56	46
5.0 – 30.0	60	50

\*Decreases with the logarithm of the frequency.

### 5.2 Test Procedures

- a. The EUT was placed 0.4 meter from the conducting wall of the shielding room was kept at least 80 centimeters from any other grounded conducting surface.
- b. Connect EUT to the power mains through a line impedance stabilization network (LISN).
- c. All the support units are connecting to the other LISN.
- d. The LISN provides 50 ohm coupling impedance for the measuring instrument.
- e. The FCC states that a 50 ohm, 50 micro-Henry LISN should be used.
- f. Both sides of AC line were checked for maximum conducted interference.
- g. The frequency range from 150 kHz to 30 MHz was searched.
- h. Set the test-receiver system to Peak Detect Function and Specified Bandwidth with Maximum Hold Mode.



### 5.3 Typical Test Setup

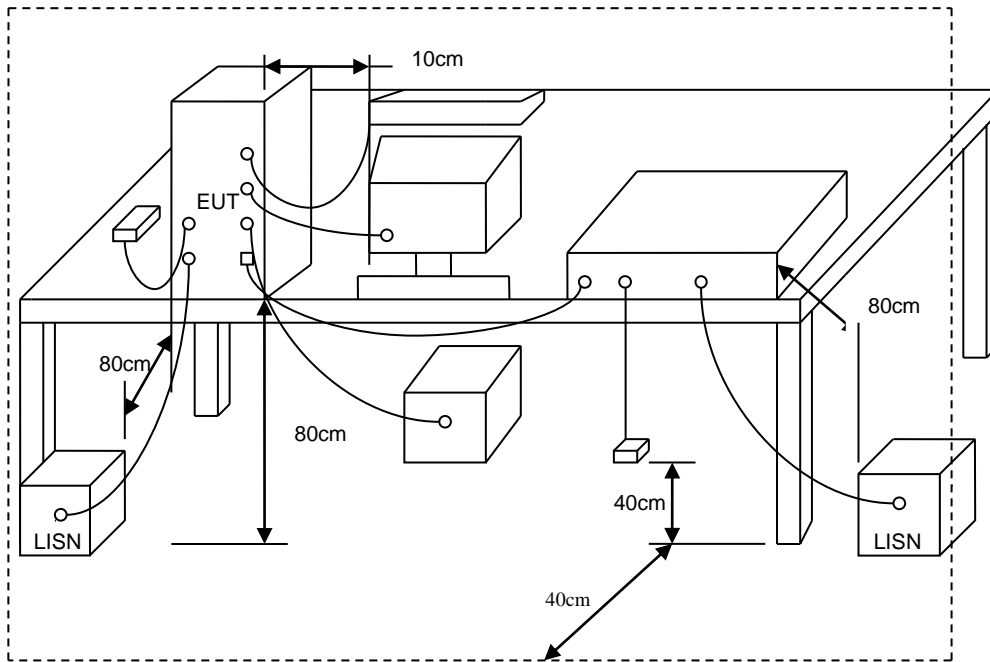



5.4 Test Result and Data

Power	: AC 120V	Pol/Phase	: LINE
Test Mode	: Mode 1	Temperature	: 22 °C
Test date	: Feb. 21, 2017	Humidity	: 52 %



No.	Frequency (MHz)	Factor (dB)	Reading (dBuV)	Level (dBuV)	Limit (dBuV)	Margin (dB)	Detector	P/F
1	0.1580	9.98	38.17	48.15	65.56	-17.41	QP	P
2	0.1580	9.98	17.38	27.36	55.56	-28.20	AVG	P
3	0.1660	9.98	35.46	45.44	65.15	-19.71	QP	P
4	0.1660	9.98	15.89	25.87	55.15	-29.28	AVG	P
5	0.1740	9.98	37.59	47.57	64.76	-17.19	QP	P
6	0.1740	9.98	19.05	29.03	54.76	-25.73	AVG	P
7	0.4700	9.97	22.47	32.44	56.51	-24.07	QP	P
8	0.4700	9.97	16.34	26.31	46.51	-20.20	AVG	P
9	3.7260	10.13	35.09	45.22	56.00	-10.78	QP	P
10	3.7260	10.13	21.46	31.59	46.00	-14.41	AVG	P
11	26.7660	10.65	19.96	30.61	60.00	-29.39	QP	P
12	26.7660	10.65	12.42	23.07	50.00	-26.93	AVG	P

Note: Level = Reading + Factor  
 Margin = Level – Limit  
 Factor = (LISN, ISN, PLC or current probe) Factor + Cable Loss+ Attenuator



Power	: AC 120V	Pol/Phase	: NEUTRAL
Test Mode	: Mode 1	Temperature	: 22 °C
Test date	: Feb. 21, 2017	Humidity	: 52 %



No.	Frequency (MHz)	Factor (dB)	Reading (dBUV)	Level (dBUV)	Limit (dBUV)	Margin (dB)	Detector	P/F
1	0.1620	9.98	36.73	46.71	65.36	-18.65	QP	P
2	0.1620	9.98	16.82	26.80	55.36	-28.56	AVG	P
3	0.1780	9.98	36.63	46.61	64.57	-17.96	QP	P
4	0.1780	9.98	18.52	28.50	54.57	-26.07	AVG	P
5	0.2060	9.98	31.94	41.92	63.36	-21.44	QP	P
6	0.2060	9.98	13.02	23.00	53.36	-30.36	AVG	P
7	0.4660	9.94	21.54	31.48	56.58	-25.10	QP	P
8	0.4660	9.94	14.48	24.42	46.58	-22.16	AVG	P
9	3.7100	10.12	28.05	38.17	56.00	-17.83	QP	P
10	3.7100	10.12	17.95	28.07	46.00	-17.93	AVG	P
11	27.2820	10.67	18.30	28.97	60.00	-31.03	QP	P
12	27.2820	10.67	11.46	22.13	50.00	-27.87	AVG	P

Note: Level = Reading + Factor

Margin = Level – Limit

Factor = (LISN, ISN, PLC or current probe) Factor + Cable Loss+ Attenuator



## 6. Test of Spurious Emission (Radiated)

### 6.1 Test Limit

In any 100kHz bandwidth outside the frequency band in which the spread spectrum or digitally modulated intentional radiator is operating, the radio frequency power that is produced by the intentional radiator shall be at least 20dB below that in the 100kHz bandwidth within the band that contains the highest level of the desired power, based on either an RF conducted or a radiated measurement. If the transmitter measurement is based on the maximum conducted output power, the attenuation required under this paragraph shall be 30dB instead of 20dB. In addition, radiated emissions which fall in section 15.205(a) the restricted bands must also comply with the radiated emission limit specified in section 15.209(a).

Frequency (MHz)	Field Strength (microvolt/meter)	Measurement Distance (meters)
0.009 ~ 0.490	2400/F(kHz)	300
0.490 ~ 1.705	24000/F(kHz)	30
1.705 ~ 30.0	30	30
30 ~ 88	100	3
88 ~ 216	150	3
216 ~ 960	200	3
Above 960	500	3

### 6.2 Test Procedures

- The EUT was placed on a rotatable table top 0.8 meter above ground.
- The EUT was set 3 meters from the interference receiving antenna which was mounted on the top of a variable height antenna tower.
- The table was rotated 360 degrees to determine the position of the highest radiation.
- The antenna is a broadband antenna and its height is varied between one meter and four meters above ground to find the maximum value of the field strength both horizontal polarization and vertical polarization of the antenna are set to make the measurement.
- For each suspected emission the EUT was arranged to its worst case and then tune the antenna tower (from 1 M to 4 M) and turn table (from 0 degree to 360 degrees) to find the maximum reading.
- Set the test-receiver system to Peak or CISPR quasi-peak Detect Function and specified bandwidth with Maximum Hold Mode.
- If the emission level of the EUT in peak mode was 3 dB lower than the limit specified, then testing will be stopped and peak values of EUT will be reported, otherwise, the emissions which do not have 3 dB margin will be repeated one by one using the quasi-peak method and reported.
- For testing above 1GHz, the emission level of the EUT in peak mode was 20dB lower than average limit (that means the emission level in peak mode also complies with the limit in average mode), then testing will be stopped and peak values of EUT will be reported, otherwise, the emissions will be measured in average mode again and reported.
- "Cone of radiation" has been considered to be 3dB bandwidth of the measurement antenna.



### 6.3 Typical Test Setup

Below 30MHz test setup

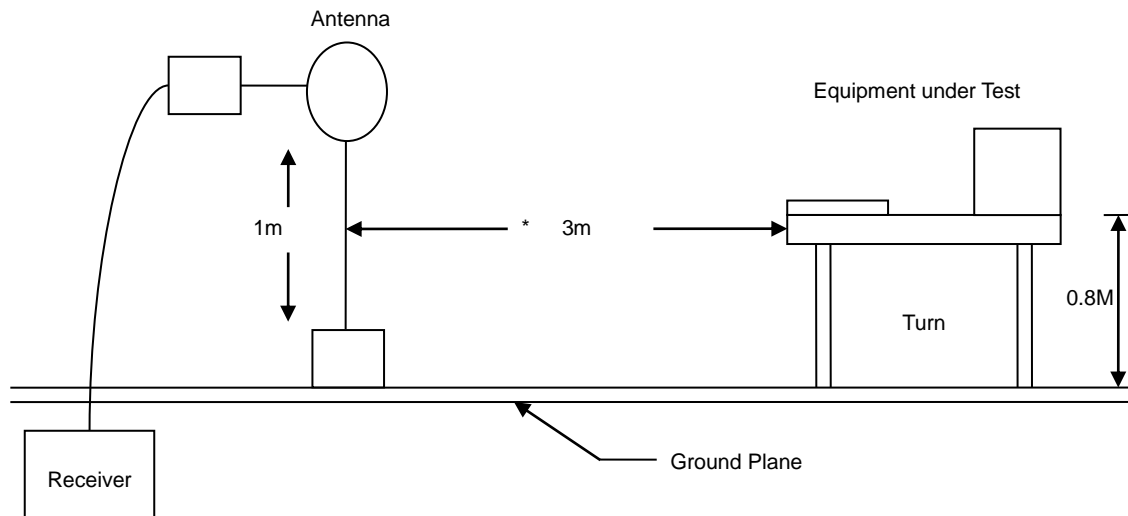

30MHz- 1GHz Test Setup

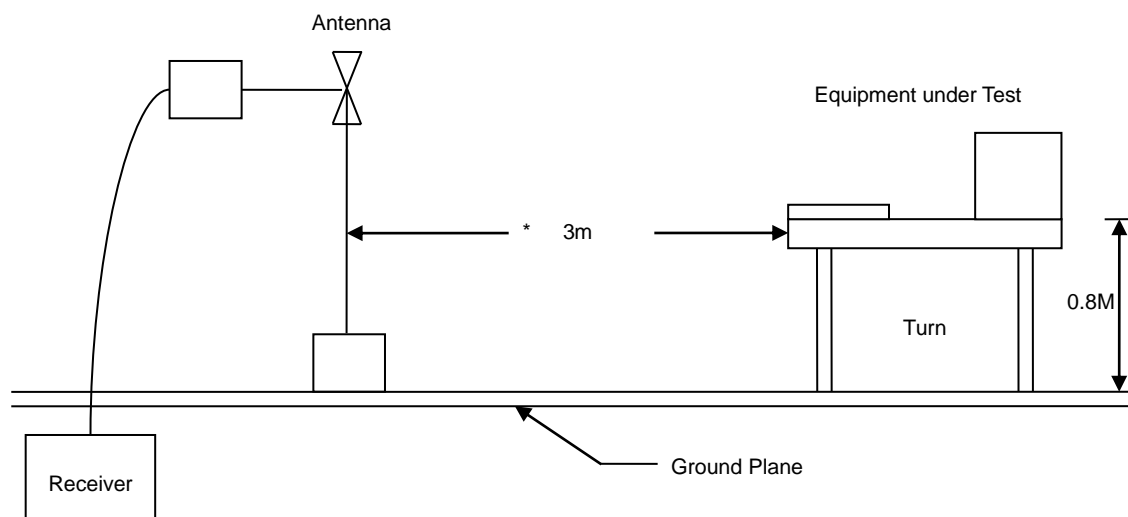

Above 1GHz Test Setup

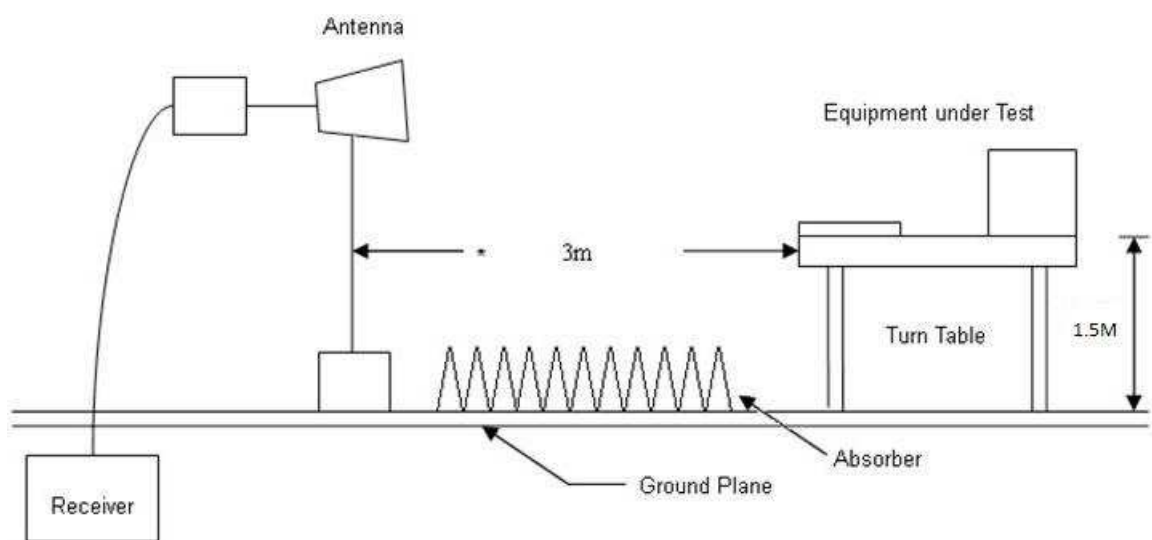





### 6.4 Test Result and Data (9kHz ~ 30MHz)

The 9kHz - 30MHz spurious emission is under limit 20dB more.

### 6.5 Test Result and Data (30MHz ~ 1GHz)

Power	: AC 120V	Pol/Phase	: VERTICAL
Test Mode	: Mode 1	Temperature	: 24 °C
Test Date	: Feb. 11, 2017	Humidity	: 63 %

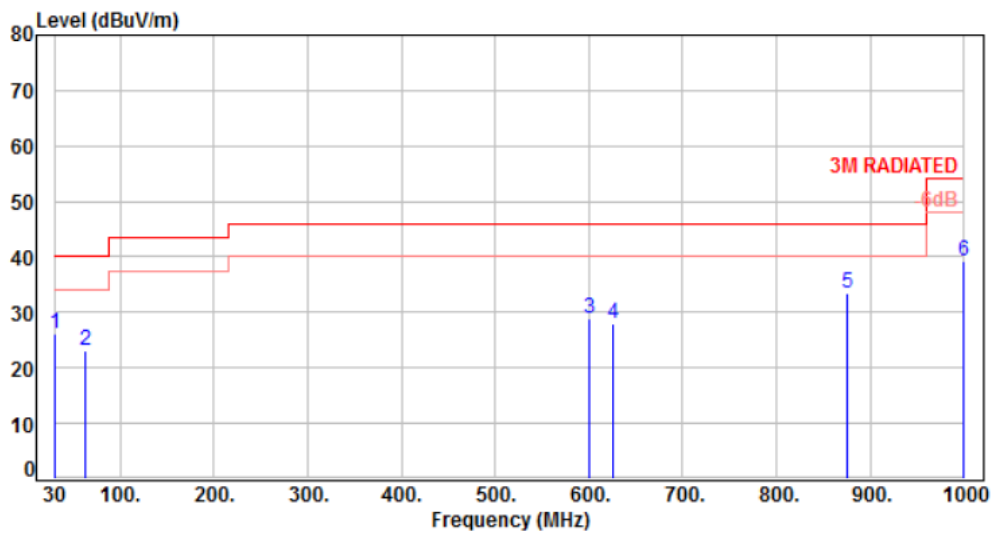

No.	Frequency (MHz)	Factor (dB)	Reading (dBuV)	Level (dBuV)	Limit (dBuV)	Margin (dB)	Detector	Height (cm)	Azimuth (deg)	P/F
1	30.00	-10.73	36.86	26.13	40.00	-13.87	Peak	100	0	P
2	62.98	-11.07	34.07	23.00	40.00	-17.00	Peak	100	0	P
3	600.36	-1.98	30.99	29.01	46.00	-16.99	Peak	100	0	P
4	625.58	-1.70	29.64	27.94	46.00	-18.06	Peak	100	0	P
5	875.84	1.87	31.59	33.46	46.00	-12.54	Peak	100	0	P
6	1000.00	3.44	35.68	39.12	54.00	-14.88	Peak	100	0	P

Note: Level=Reading+Factor  
Margin=Level-Limit  
Factor=Antenna Factor + cable loss - Amplifier Factor



Power	: AC 120V	Pol/Phase	: HORIZONTAL
Test Mode	: Mode 1	Temperature	: 24 °C
Test Date	: Feb. 11, 2017	Humidity	: 63 %

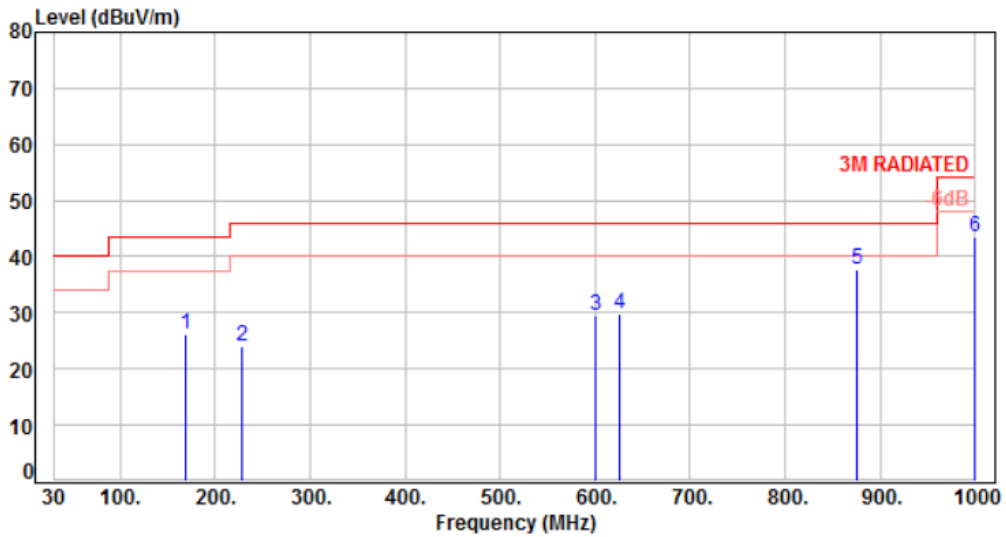

No.	Frequency (MHz)	Factor (dB)	Reading (dBuV)	Level (dBuV)	Limit (dBuV)	Margin (dB)	Detector	Height (cm)	Azimuth (deg)	P/F
1	169.68	-10.22	36.47	26.25	43.50	-17.25	Peak	100	0	P
2	227.88	-12.18	36.08	23.90	46.00	-22.10	Peak	100	0	P
3	600.36	-1.98	31.45	29.47	46.00	-16.53	Peak	100	0	P
4	625.58	-1.70	31.55	29.85	46.00	-16.15	Peak	100	0	P
5	875.84	1.87	35.99	37.86	46.00	-8.14	Peak	100	0	P
6	1000.00	3.44	40.18	43.62	54.00	-10.38	Peak	100	0	P

Note: Level=Reading+Factor  
 Margin=Level-Limit  
 Factor=Antenna Factor + cable loss - Amplifier Factor



6.6 Test Result and Data (1GHz ~ 25GHz)

Power	: AC 120V	Pol/Phase	: VERTICAL
Test Mode	: Mode 1, CH00	Temperature	: 24 °C
Test Date	: Feb. 11, 2017	Humidity	: 63 %

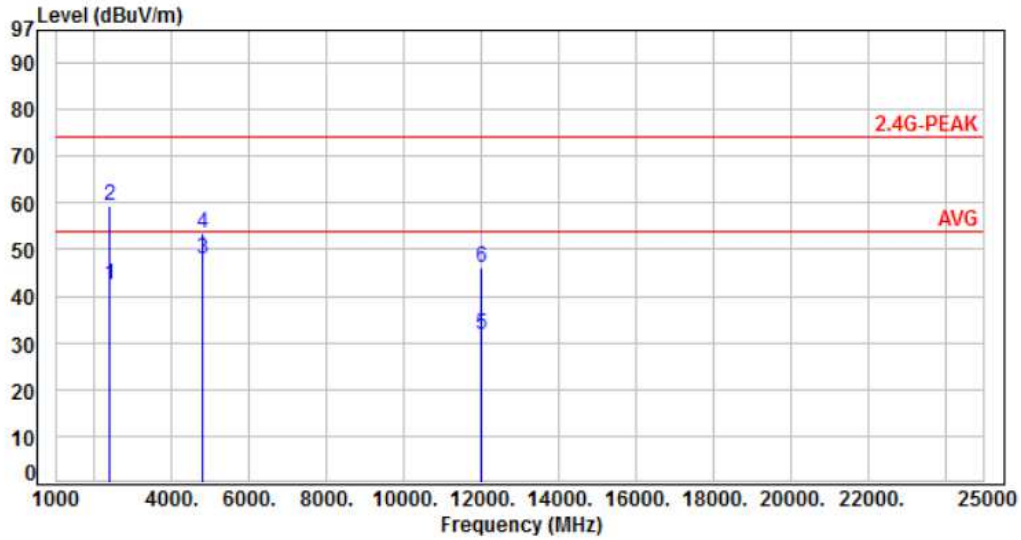

No.	Frequency (MHz)	Factor (dB)	Reading (dBuV)	Level (dBuV)	Limit (dBuV)	Margin (dB)	Detector	Height (cm)	Azimuth (deg)	P/F
1	2390.00	-15.75	58.24	42.49	54.00	-11.51	Average	102	48	P
2	2390.00	-15.75	74.96	59.21	74.00	-14.79	Peak	102	48	P
3	4804.00	-7.65	55.65	48.00	54.00	-6.00	Average	311	170	P
4	4804.00	-7.65	60.98	53.33	74.00	-20.67	Peak	311	170	P
5	12010.00	2.25	29.37	31.62	54.00	-22.38	Average	298	162	P
6	12010.00	2.25	43.71	45.96	74.00	-28.04	Peak	298	162	P

Note: Level=Reading+Factor  
 Margin=Level-Limit  
 Factor=Antenna Factor + cable loss - Amplifier Factor



Power	: AC 120V	Pol/Phase	: HORIZONTAL
Test Mode	: Mode 1, CH00	Temperature	: 24 °C
Test Date	: Feb. 11, 2017	Humidity	: 63 %

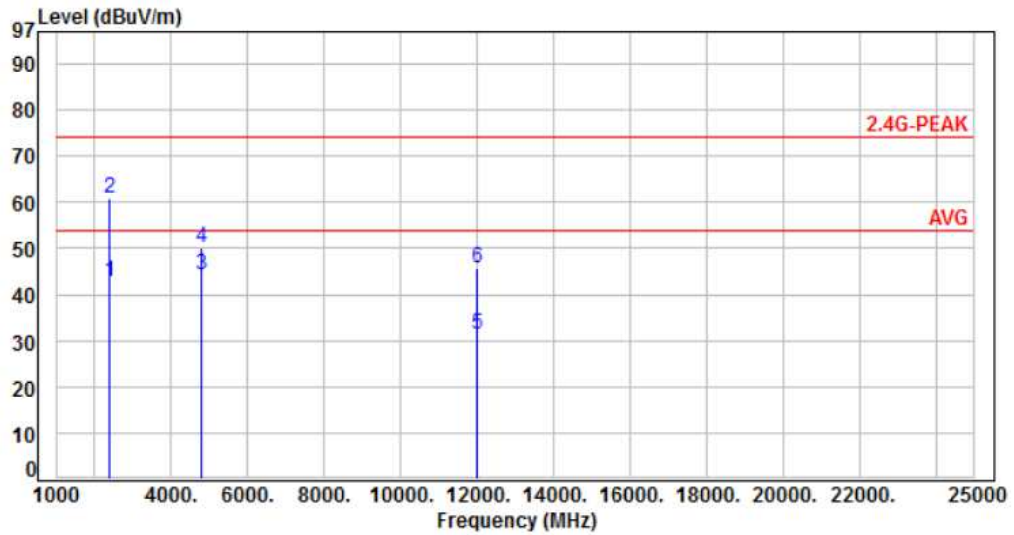

No.	Frequency (MHz)	Factor (dB)	Reading (dBuV)	Level (dBuV)	Limit (dBuV)	Margin (dB)	Detector	Height (cm)	Azimuth (deg)	P/F
1	2390.00	-15.75	58.58	42.83	54.00	-11.17	Average	124	168	P
2	2390.00	-15.75	76.57	60.82	74.00	-13.18	Peak	124	168	P
3	4804.00	-7.65	51.97	44.32	54.00	-9.68	Average	129	216	P
4	4804.00	-7.65	57.93	50.28	74.00	-23.72	Peak	129	216	P
5	12010.00	2.25	29.28	31.53	54.00	-22.47	Average	131	248	P
6	12010.00	2.25	43.31	45.56	74.00	-28.44	Peak	131	248	P

Note: Level=Reading+Factor  
 Margin=Level-Limit  
 Factor=Antenna Factor + cable loss - Amplifier Factor



Power	: AC 120V	Pol/Phase	: VERTICAL
Test Mode	: Mode 1, CH19	Temperature	: 24 °C
Test Date	: Feb. 11, 2017	Humidity	: 63 %

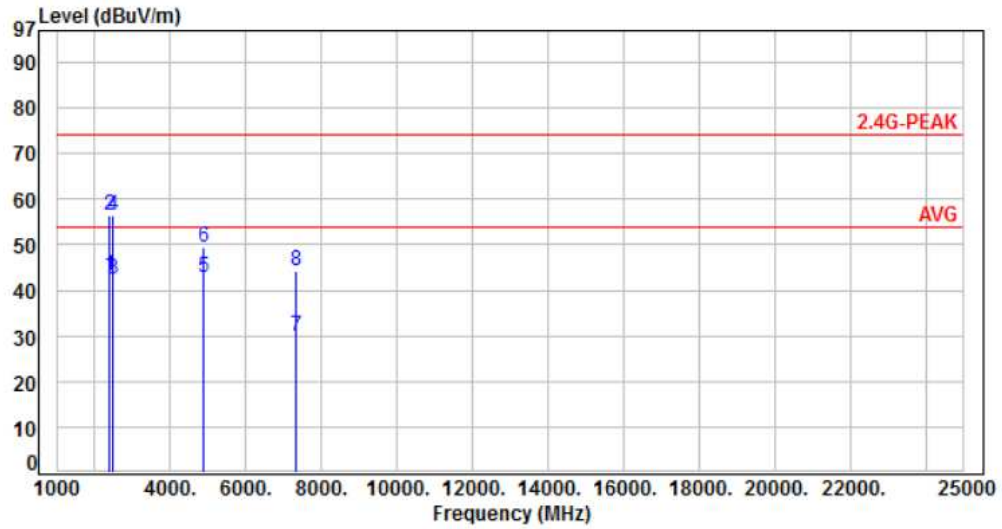

No.	Frequency (MHz)	Factor (dB)	Reading (dBuV)	Level (dBuV)	Limit (dBuV)	Margin (dB)	Detector	Height (cm)	Azimuth (deg)	P/F
1	2390.00	-15.75	58.76	43.01	54.00	-10.99	Average	100	231	P
2	2390.00	-15.75	72.26	56.51	74.00	-17.49	Peak	100	231	P
3	2483.50	-15.48	57.92	42.44	54.00	-11.56	Average	100	231	P
4	2483.50	-15.48	71.98	56.50	74.00	-17.50	Peak	100	231	P
5	4880.00	-7.36	49.98	42.62	54.00	-11.38	Average	311	176	P
6	4880.00	-7.36	56.89	49.53	74.00	-24.47	Peak	311	176	P
7	7320.00	-3.49	33.49	30.00	54.00	-24.00	Average	298	184	P
8	7320.00	-3.49	47.59	44.10	74.00	-29.90	Peak	298	184	P

Note: Level=Reading+Factor  
 Margin=Level-Limit  
 Factor=Antenna Factor + cable loss - Amplifier Factor



Power	: AC 120V	Pol/Phase	: HORIZONTAL
Test Mode	: Mode 1, CH19	Temperature	: 24 °C
Test Date	: Feb. 11, 2017	Humidity	: 63 %

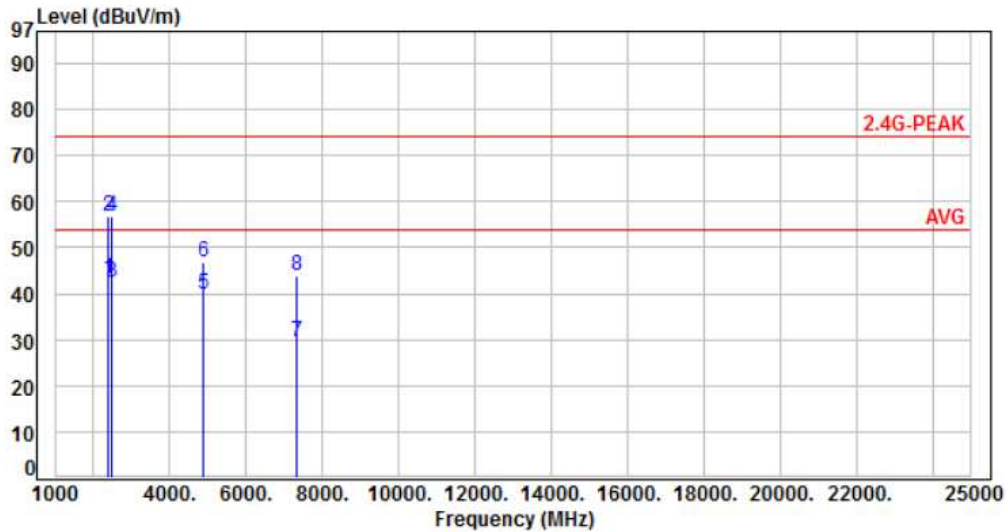

No.	Frequency (MHz)	Factor (dB)	Reading (dBuV)	Level (dBuV)	Limit (dBuV)	Margin (dB)	Detector	Height (cm)	Azimuth (deg)	P/F
1	2390.00	-15.75	58.90	43.15	54.00	-10.85	Average	112	193	P
2	2390.00	-15.75	72.45	56.70	74.00	-17.30	Peak	112	193	P
3	2483.50	-15.48	58.03	42.55	54.00	-11.45	Average	112	193	P
4	2483.50	-15.48	72.23	56.75	74.00	-17.25	Peak	112	193	P
5	4880.00	-7.36	47.12	39.76	54.00	-14.24	Average	157	198	P
6	4880.00	-7.36	54.21	46.85	74.00	-27.15	Peak	157	198	P
7	7320.00	-3.49	33.13	29.64	54.00	-24.36	Average	100	231	P
8	7320.00	-3.49	47.29	43.80	74.00	-30.20	Peak	100	231	P

Note: Level=Reading+Factor  
 Margin=Level-Limit  
 Factor=Antenna Factor + cable loss - Amplifier Factor



Power	: AC 120V	Pol/Phase	: VERTICAL
Test Mode	: Mode 1, CH39	Temperature	: 24 °C
Test Date	: Feb. 11, 2017	Humidity	: 63 %

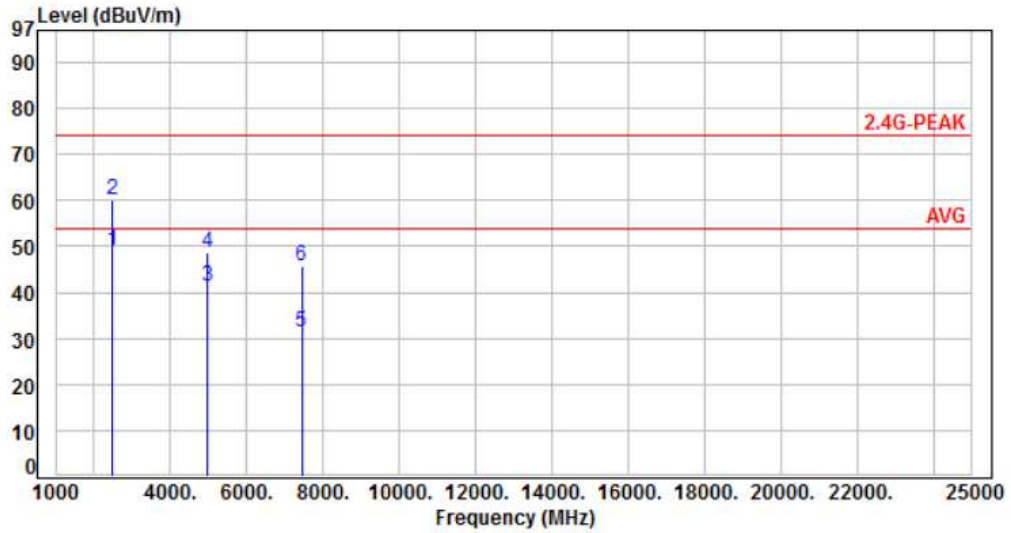

No.	Frequency (MHz)	Factor (dB)	Reading (dBuV)	Level (dBuV)	Limit (dBuV)	Margin (dB)	Detector	Height (cm)	Azimuth (deg)	P/F
1	2483.50	-15.48	64.51	49.03	54.00	-4.97	Average	114	245	P
2	2483.50	-15.48	75.53	60.05	74.00	-13.95	Peak	114	245	P
3	4960.00	-7.04	48.35	41.31	54.00	-12.69	Average	253	169	P
4	4960.00	-7.04	55.88	48.84	74.00	-25.16	Peak	253	169	P
5	7440.00	-3.30	34.82	31.52	54.00	-22.48	Average	237	172	P
6	7440.00	-3.30	49.21	45.91	74.00	-28.09	Peak	237	172	P

Note: Level=Reading+Factor  
 Margin=Level-Limit  
 Factor=Antenna Factor + cable loss - Amplifier Factor



Power	: AC 120V	Pol/Phase	: HORIZONTAL
Test Mode	: Mode 1, CH39	Temperature	: 24 °C
Test Date	: Feb. 11, 2017	Humidity	: 63 %

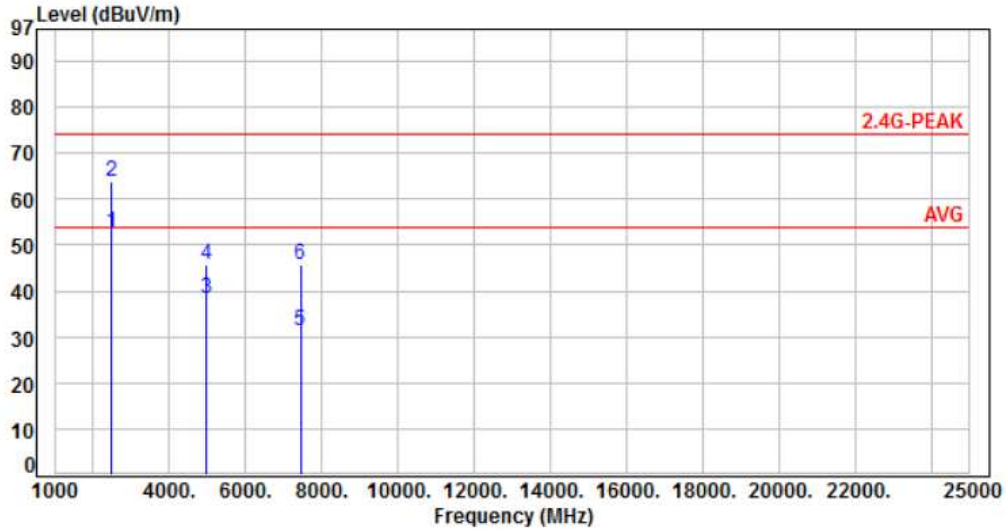

No.	Frequency (MHz)	Factor (dB)	Reading (dBuV)	Level (dBuV)	Limit (dBuV)	Margin (dB)	Detector	Height (cm)	Azimuth (deg)	P/F
1	2483.50	-15.48	68.29	52.81	54.00	-1.19	Average	100	288	P
2	2483.50	-15.48	79.25	63.77	74.00	-10.23	Peak	100	288	P
3	4960.00	-7.04	45.56	38.52	54.00	-15.48	Average	112	189	P
4	4960.00	-7.04	52.61	45.57	74.00	-28.43	Peak	112	189	P
5	7440.00	-3.30	34.59	31.29	54.00	-22.71	Average	149	212	P
6	7440.00	-3.30	49.07	45.77	74.00	-28.23	Peak	149	212	P

Note: Level=Reading+Factor  
 Margin=Level-Limit  
 Factor=Antenna Factor + cable loss - Amplifier Factor





### 6.7 Restricted Bands of Operation

Only spurious emissions are permitted in any of the frequency bands listed below:

MHz	MHz	MHz	GHz
0.09000 – 0.11000	16.42000 – 16.42300	399.9 – 410.0	4.500 – 5.250
0.49500 – 0.505**	16.69475 – 16.69525	608.0 – 614.0	5.350 – 5.460
2.17350 – 2.19050	16.80425 – 16.80475	960.0 – 1240.0	7.250 – 7.750
4.12500 – 4.12800	25.50000 – 25.67000	1300.0 – 1427.0	8.025 – 8.500
4.17725 – 4.17775	37.50000 – 38.25000	1435.0 – 1626.5	9.000 – 9.200
4.20725 – 4.20775	73.00000 – 74.60000	1645.5 – 1646.5	9.300 – 9.500
6.21500 – 6.21800	74.80000 – 75.20000	1660.0 – 1710.0	10.600 – 12.700
6.26775 – 6.26825	108.00000 – 121.94000	1718.8 – 1722.2	13.250 – 13.400
6.31175 – 6.31225	123.00000 – 138.00000	2200.0 – 2300.0	14.470 – 14.500
8.29100 – 8.29400	149.90000 – 150.05000	2310.0 – 2390.0	15.350 – 16.200
8.36200 – 8.36600	156.52475 – 156.52525	2483.5 – 2500.0	17.700 – 21.400
8.37625 – 8.38675	156.70000 – 156.90000	2655.0 – 2900.0	22.010 – 23.120
8.41425 – 8.41475	162.01250 – 167.17000	3260.0 – 3267.0	23.600 – 24.000
12.29000 – 12.29300	167.72000 – 173.20000	3332.0 – 3339.0	31.200 – 31.800
12.51975 – 12.52025	240.00000 – 285.00000	3345.8 – 3358.0	36.430 – 36.500
12.57675 – 12.57725	322.00000 – 335.40000	3600.0 – 4400.0	Above 38.6
13.36000 – 13.41000			

\*\* : Until February 1, 1999, this restricted band shall be 0.490-0.510 MHz



## 7. Test of Spurious Emission (Conducted)

### 7.1 Test Limit

Below -20dB of the highest emission level of operating band (In 100 kHz Resolution Bandwidth)

### 7.2 Test Procedure

- a. The transmitter output was connected to the spectrum analyzer via a low lose cable.
- b. Set RBW of spectrum analyzer to 100 KHz and VBW of spectrum analyzer to 300 KHz with convenient frequency span including 100 KHz bandwidth from band edge.
- c. Peak conducted output power measured within any 100 kHz outside the authorized frequency band shall be attenuated by at least 20dB relative to the maximum measured in-band peak PSD level.
- d. The band edges was measured and recorded.

### 7.3 Test Setup Layout

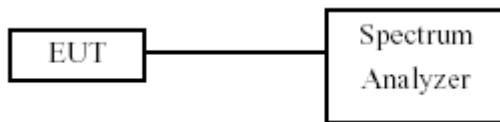

### 7.4 Test Result and Data

Test Result	: PASS	Temperature	: 21°C
Test Date	: Feb. 22, 2017	Humidity	: 58%

Note: Test plots refer to the following pages.



Modulation Type: GFSK  
CH00

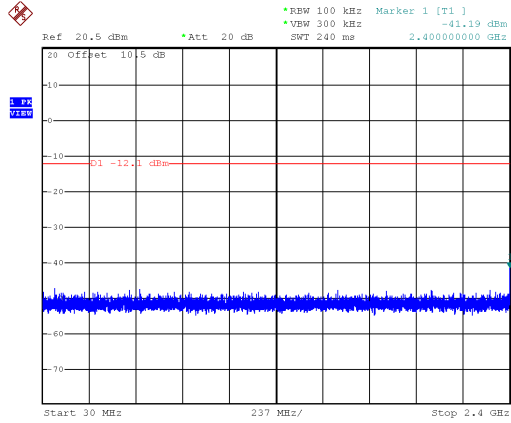

Modulation Type: GFSK  
CH19

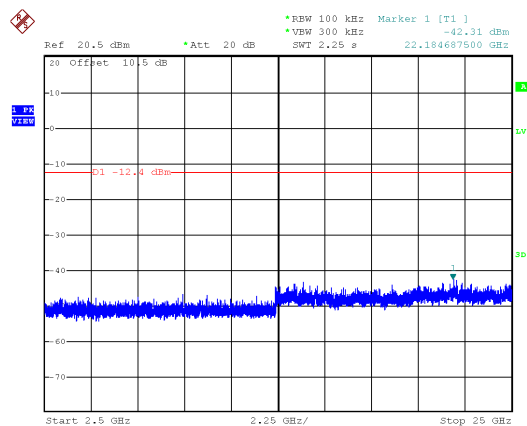
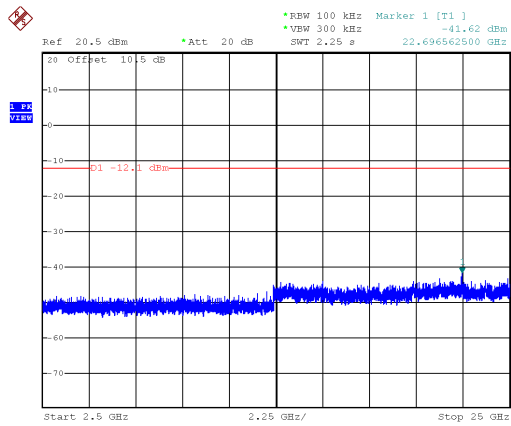
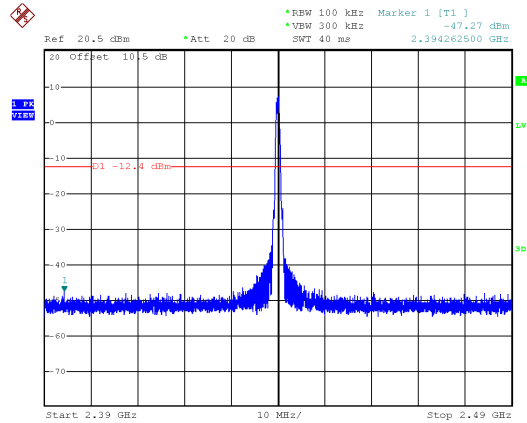
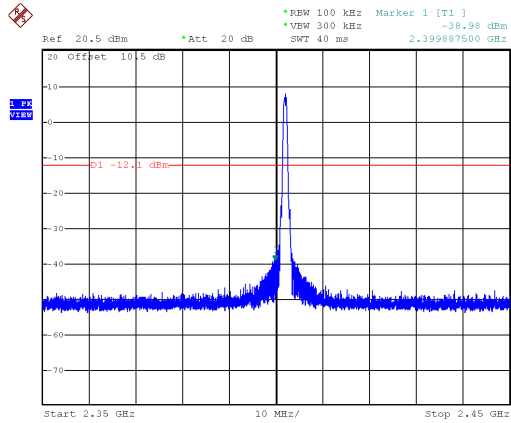
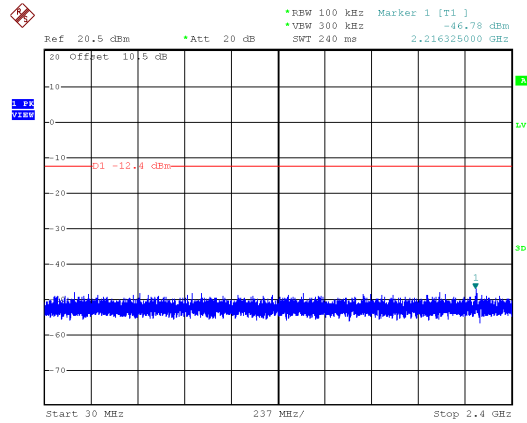



Modulation Type: GFSK  
CH39

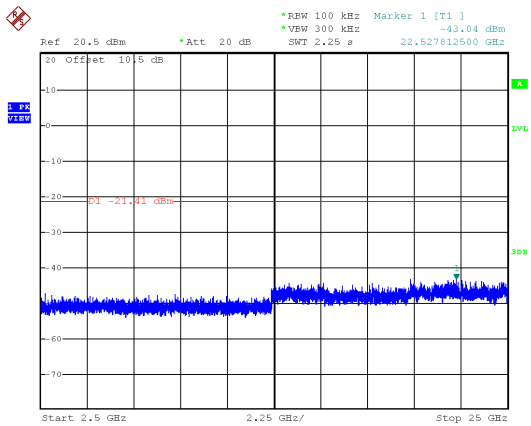
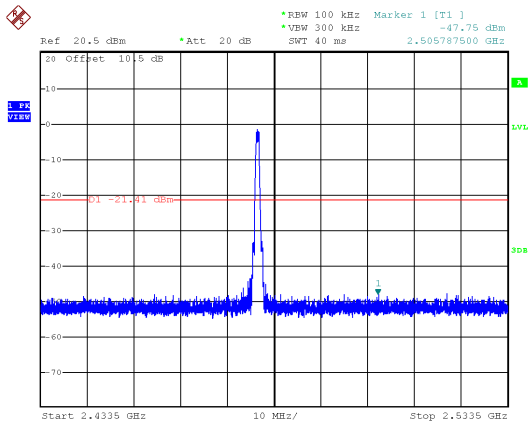
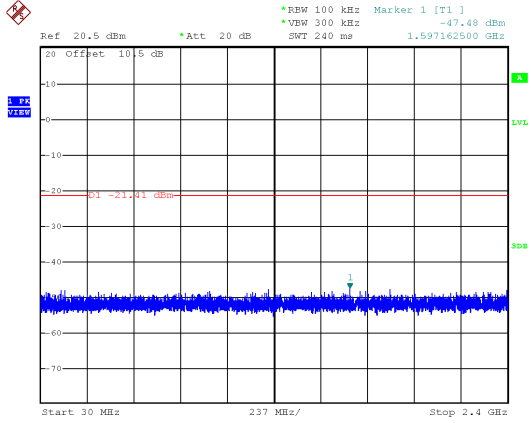



**8. 6dB Bandwidth Measurement Data**

**8.1 Test Limit**

The minimum of 6dB Bandwidth Measurement is 0.5 MHz.

**8.2 Test Procedures**

- The transmitter output was connected to the spectrum analyzer.
- Set RBW of spectrum analyzer to 1~5% of the emission bandwidth and VBW ≥ 3x RBW.
- The 6 dB bandwidth is defined as the total spectrum the power of which is higher than peak power minus 6 dB.
- The 6dB Bandwidth was measured and recorded.

**8.3 Test Setup Layout**

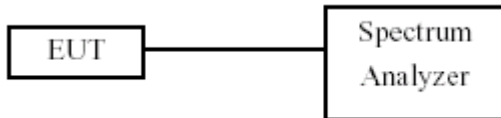

**8.4 Test Result and Data**

Test Result : PASS                      Temperature : 21°C  
 Test Date : Feb. 22, 2017             Humidity : 58%

Modulation Type	Channel	Frequency (MHz)	6dB Bandwidth (KHz)	Limit (KHz)
GFSK	00	2402	684.00	500
	19	2440	672.00	500
	39	2480	684.00	500



Modulation Type: GFSK  
CH00

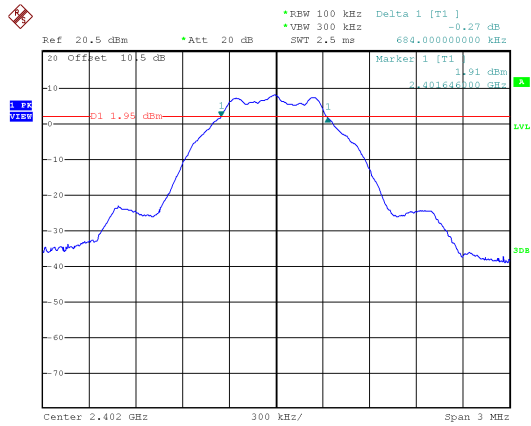

CH19

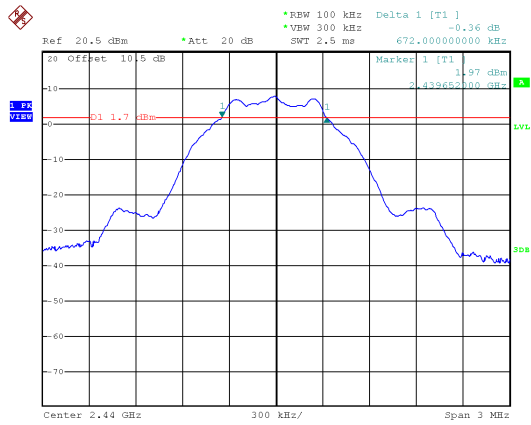

CH39

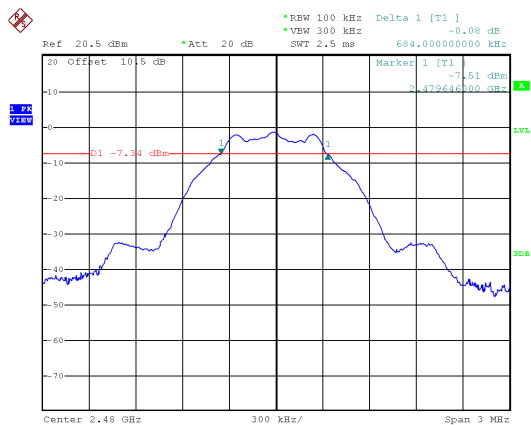



## 9. Maximum Peak and Average Output Power

### 9.1 Test Limit

The Maximum Peak Output Power Measurement is 30dBm.

### 9.2 Test Procedures

The antenna port (RF output) of the EUT was connected to the input (RF input) of a power meter. Power was read directly from the meter and cable loss connection was added to the reading to obtain power at the EUT antenna terminal. The EUT Output Power was set to maximum to produce the worse case test result.

### 9.3 Test Setup Layout

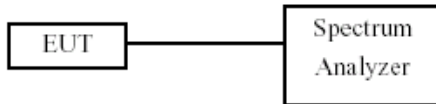

### 9.4 Test Result and Data

Test Result : PASS

Temperature : 21°C

Test Date : Feb. 22, 2017

Humidity : 58%

Modulation Standard	Channel	Frequency (MHz)	Power Output (dBm)		Peak Power Output (mW)	
			Peak	Average	Peak	Average
GFSK	00	2402	8.33	8.26	6.808	6.699
	19	2440	8.1	8.02	6.457	6.339
	39	2480	-0.82	-1.04	0.828	0.787



## 10. Power Spectral Density

### 10.1 Test Limit

The Maximum of Power Spectral Density Measurement is 8dBm.

### 10.2 Test Procedures

- a. The transmitter output was connected to spectrum analyzer.
- b. The spectrum analyzer's resolution bandwidth were set at 3KHz RBW and 30KHz VBW as that of the fundamental frequency. Set the sweep time=auto couple.
- c. The power spectral density was measured and recorded.

### 10.3 Test Setup Layout

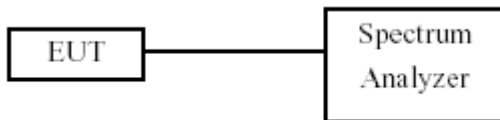

### 10.4 Test Result and Data

Test Result : PASS

Temperature : 21°C

Test Date : Feb. 22, 2017

Humidity : 58%

Modulation Standard	Channel	Frequency (MHz)	Maximum Power Density of 3 kHz Bandwidth (dBm)	Limit
GFSK	00	2402	-6.14	8.00
	19	2440	-6.4	8.00
	39	2480	-15.43	8.00





Modulation Type: GFSK  
CH00

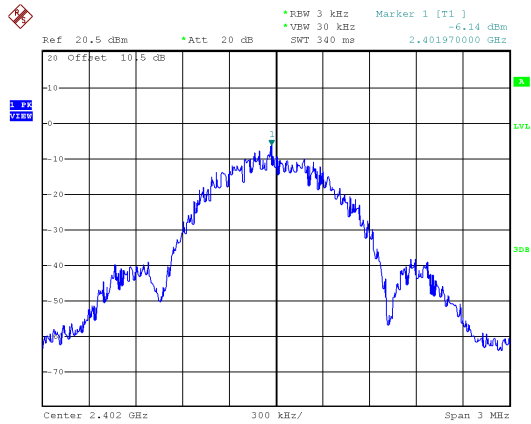

CH19

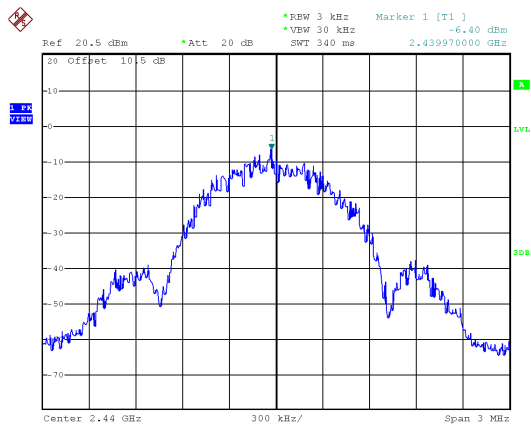

CH39

