



DR750X Plus | DR750X-1CH Plus | DR750X-2CH Plus
Quick Start Guide



▪ Model : DR750X-1CH Plus



▪ Model : DR750X Plus /
DR750X-2CH Plus

ENGLISH

www.blackvue.com

BLACKVUE

DR750X Plus | DR750X-1CH Plus |
DR750X-2CH Plus

For manuals, customer support and FAQs go to www.blackvue.com

Important safety information

For user safety and to avoid property damage, read through this manual and follow these safety instructions to use the product correctly.

- Do not disassemble, repair, or modify the product yourself.
Doing so may cause fire, electric shock, or malfunction. For internal inspection and repair, contact the service center.
- Do not adjust the product while driving.
Doing so may cause an accident. Stop or park your car in a safe place before installing and setting up the product.
- Do not operate the product with wet hands.
Doing so may cause electric shock.
- If any foreign matter gets inside the product, detach the power cord immediately.
Contact the service center for repair.
- Do not cover the product with any material.
Doing so may cause external deformation of the product or fire. Use the product and peripherals in a well-ventilated location.
- If the product is used outside the optimal temperature range (-20°C - 80°C / -4°F - 176°F), performance can decline or malfunctions may occur.
- When entering or exiting a tunnel, when directly facing into bright sunlight, or when recording at night without lighting the quality of recorded video may deteriorate.
- If the product is damaged or the power supply is cut due to an accident, video may not be recorded.
- Do not remove the microSD card while the microSD card is saving or reading data.
- The data can be damaged or malfunctions may occur.

FCC Compliance Information

This equipment has been tested and found to comply with the limits for a Class B digital device, pursuant to Part 15 of the FCC Rules. These limits are designed to provide reasonable protections against harmful interference in a residential installation.

This equipment generates, uses and can radiate radio frequency energy and, if not installed and used in accordance with the instructions, may cause harmful interference to radio communications. However, there is no guarantee that interference will not occur in a particular installation.

If this equipment does cause harmful interference to radio or television reception which can be determined by turning the equipment off and on, the user is encouraged to try to correct the interference by one or more of the following measures.

- Reorient or relocate the receiving antenna.
- Increase the separation between the equipment and receiver.
- Connect the equipment into an outlet on a circuit different from that to which the receiver is connected.
- Consult the dealer or an experienced radio, TV technician for help.
- Only shielded interface cable should be used.

Finally, any changes or modifications to the equipment by the user not expressly approved by the grantee or manufacture could void the user's authority to operate such equipment.

This device complies with Part 15 of the FCC Rules. Operation is subject to the following two conditions:

- (1) This device may not cause harmful interference, and
- (2) This device must accept any interference received, including interference that may cause undesired operation of this device.

FCC ID: YCK-DR750XP

CAUTION

Any changed or modifications in construction of this device which are not expressly approved by the party responsible for compliance could void the user's authority to operate the equipment.

There is a risk of explosion if the battery is replaced by an incorrect type.
Dispose of used batteries according to the instructions.

CE WARNING

- Changes and modifications not expressly approved by the party responsible for compliance could void the user's authority to operate the equipment.
- It is desirable that it be installed and operated with at least 20cm or more between the radiator and a person's body (excluding extremities: hand, wrists, feet, and ankles).

Disposal of your BlackVue dashcam



1. All electrical and electronic products should be disposed of separately from the municipal waste stream via designated collection facilities appointed by the government or the local authorities. Contact local authorities to learn about disposal and recycling options available in your area.
2. The correct disposal of your BlackVue dashcam will help prevent potential negative consequences for the environment and human health.
3. For more detailed information about disposal of your BlackVue dashcam, please contact your city office, waste disposal service or the shop where you purchased the product.

ICC Compliance

This Class [B] digital apparatus complies with Canadian ICES-003.

This radio transmitter has been approved by Industry Canada to operate with the antenna types listed below with the maximum permissible gain and required antenna impedance for each antenna type indicated. Antenna types not included in this list, having a gain greater than the maximum gain indicated for that type, are strictly prohibited for use with this device.

- IC Warning

This device complies with Industry Canada licence-exempt RSS standard(s).

Operation is subject to the following two conditions:

- (1) this device may not cause interference, and
- (2) this device must accept any interference, including interference that may cause undesired operation of the device.









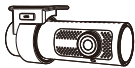

Le présent appareil est conforme aux CNR d'Industrie Canada applicable aux appareils radio exempts de licence.

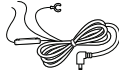
L'exploitation est autorisée aux deux conditions suivantes:

- (1) l'appareil ne doit pas produire de brouillage, et
- (2) l'utilisateur de l'appareil doit accepter tout brouillage radioélectrique subi, même si le brouillage est susceptible d'entraver le fonctionnement.

➤ In the box

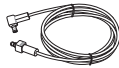
Check the box for each of the following items before installing the BlackVue dashcam.

 <p>Front camera</p>	 <p>Rear camera (DR750X-2CH Plus only)</p>
 <p>Cigarette lighter power cable</p>	 <p>Hardwiring power cable</p>
 <p>microSD card</p>	 <p>microSD card reader</p>
 <p>Double-sided tape for the front camera mounting bracket</p>	 <p>Double-sided tape for the rear camera mounting bracket (DR750X-2CH Plus only)</p>
 <p>Quick start guide</p>	 <p>Rear camera connection cable (DR750X-2CH Plus only)</p>
 <p>Pry tool</p>	 <p>1CH: Cable clips (5 EA) 2CH: Cable clips (8 EA)</p>

Need help?

Download the manual (including FAQs) and the latest firmware from www.blackvue.com
 Or contact a Customer Support expert at cs@pittasoft.com

► At a glance

The following diagrams explain each part of the BlackVue dashcam.

□ Front camera

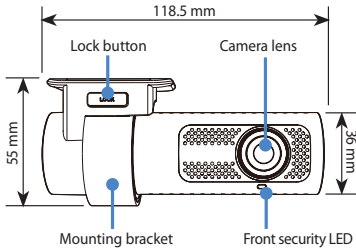

- Front security LED
- : Lights on during (i) normal mode, (ii) an event is being recorded (impact detected), (iii) manual recording has started, or (iv) motion is detected in parking mode.
 - : Blinks slowly during parking mode motion detection standby.

GPS LED

- : Lights blue when GPS is on.
- ⊙ : Blinks blue quickly when GPS is turning off.

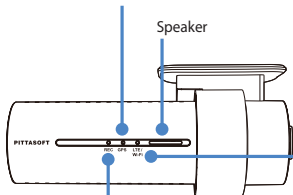

LTE/Wi-Fi LED

- : Lights yellow when LTE is connected.
- : Lights white when Wi-Fi is connected.
- ⊙ : Blinks white slowly when connecting to Wi-Fi.
- ⊙ : Blinks white quickly when Wi-Fi is turning off.

Recording LED

- : Lights orange in normal mode.
- : Lights red when (i) an event is being recorded (impact detected), or (ii) manual recording has started.
- : Lights green in parking mode when motion is detected.

Connectivity details label:

- Default Wi-Fi SSID
- Default Wi-Fi password
- Cloud code
- QR code

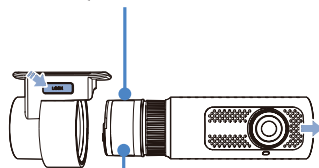

Serial number label

Proximity Sensor LED

● : Lights when proximity sensor is triggered.

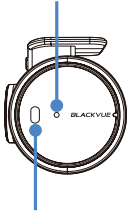

Proximity Sensor:

Touch or wave a finger within 20mm of the sensor to trigger a customizable function.

Available options:

- Turn on/off audio recording (default)
- Manual recording trigger
- Off

Rear camera connection port

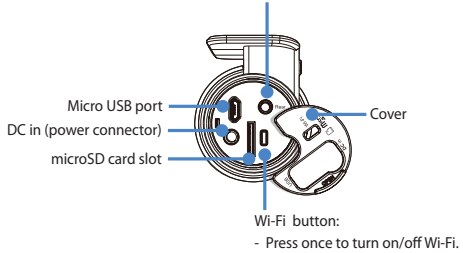

□ Rear camera (DR750X-2CH Plus only)

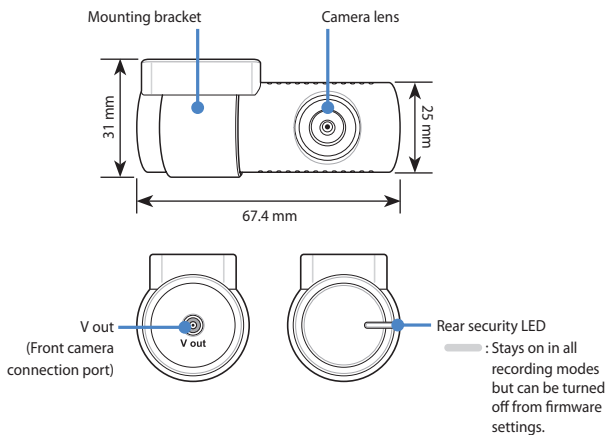

 **Note**

- For DR750X-1CH Plus user, the BlackVue rear camera is an optional accessory.

STEP 1 Install and power up

Install the front camera behind the rear view mirror. Install the rear camera at the top of the back windshield. Remove any foreign matter and clean and dry the windshield before installation.

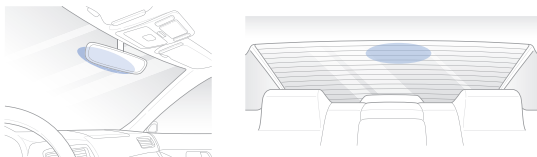

Note

- For DR750X-1CH Plus user, the BlackVue rear camera is an optional accessory.

Warning

- Do not install the product in a location where it can obstruct the driver's field of vision.

- A** Turn off the engine. Open the cover of the microSD card slot, gently push the card into the slot until it locks into place and close the cover.

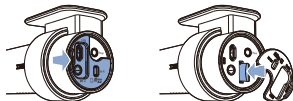

- B** Peel off the protective film from the double-sided tape and attach the front camera to the windshield behind the rear-view mirror.

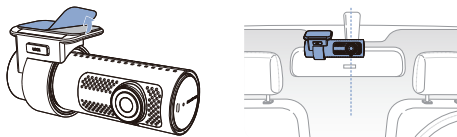

- C** Adjust the angle of the lens by rotating the body of the front camera. We recommend pointing the lens slightly downwards ($\approx 10^\circ$ below horizontal), so as to record video with a 6:4 road to background ratio.

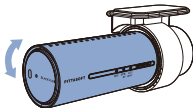

- D** Peel off the protective film from the double-sided tape and attach the rear camera to the rear windshield. Adjust the angle of the lens by rotating the body of the rear camera.

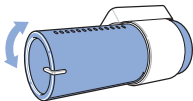

- E** Connect the front camera ('Rear' port) and the rear camera ('V out') using the rear camera connection cable.

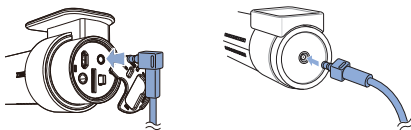

- F** Use the pry tool to lift the edges of the rubber window sealing and molding and tuck in the rear camera connection cable.

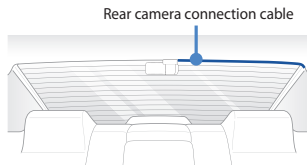

- G** Connectivity Module (Optional): Connect the connectivity module to the front camera and attach it to the edge of the window. Use the pry tool to tuck in the cable.
- H** Plug the cigarette lighter power cable into the cigarette lighter socket and the front camera. Skip to **L** for Hardwiring Power Cable setup.
- I** Use the pry tool to lift the edges of the windshield trim/molding and tuck in the power cord.

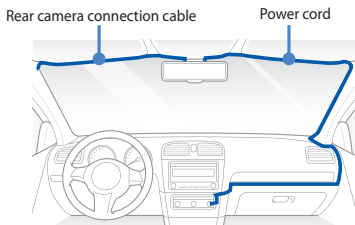

- J** Turn on the engine. The BlackVue dashcam will power up and start recording. Video files are stored on the microSD card.

- K** Turn off the engine. The dashcam will automatically stop recording and power down. To record in parking mode while the engine is off please connect the Hardwiring Power Cable (included in the box) or install a **Power Magic Battery Pack** (sold separately). A **Hardwiring Power Cable** uses the automotive battery to power your dashcam when the engine is off. A low voltage power cut-off function and a parking mode timer to protect the automotive battery from discharge is installed in the device. Settings can be changed in the BlackVue App or Viewer.
- L** Locate the fuse box to connect the hardwiring power cable.

 **Note**

- Location of the fuse box differ by manufacturer or model. For details, refer to the vehicle owner's manual.
- L-1** After removing fuse panel cover, find a fuse that powers on when engine is turned on(ex.cigarette lighter socket, audio, etc) and another fuse that remains powered on after the engine is turned off (ex.hazard light, interior light). Connect the ACC+ cable to a fuse that powers on after engine start, and BATT+ cable to a fuse that remains powered on after engine is turned off.

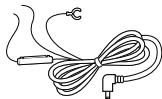

 **Note**

- To use battery saver feature, connect the BATT+ cable to the hazard light fuse. Functions of fuse differ by manufacturer or model. For details refer to the vehicle owner's manual.

- ② Connect the GND cable to metal ground bolt.

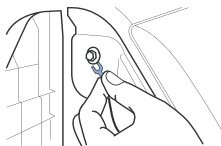

- ③ Connect the power cable to the DC in terminal of the front camera. BlackVue will power up and start recording. Video files are stored on the microSD card.

 **Note**

- When you run the dashcam for the first time the firmware is automatically loaded onto the microSD card. After the firmware has been loaded onto the microSD card you can customize settings using BlackVue Viewer on a computer.

STEP 2 Playback

□ Playing video files on your **smartphone** (Android/iOS)

- (A) Search for the BlackVue app in the Google Play Store or Apple App Store and install it on your smartphone.
- (B) "Pair" your smartphone with the BlackVue dashcam via Wi-Fi direct.
 - (i) Press the Wi-Fi button once to turn on Wi-Fi.
 - (ii) Go to your smartphone's **Settings** then select **Wi-Fi**, and make sure Wi-Fi is turned on.



- (iii) Choose your BlackVue dashcam from the network list. The dashcam's default SSID begins with its model number (e.g. BlackVue750XPlus-*****).
- (iv) Enter the password and tap join.

* To find the default Wi-Fi password, unplug the cables and remove the front camera from its mount. The default Wi-Fi SSID, password and cloud code are printed on the dashcam's connectivity details label.

(v) Open the BlackVue app and select **Wi-Fi**.

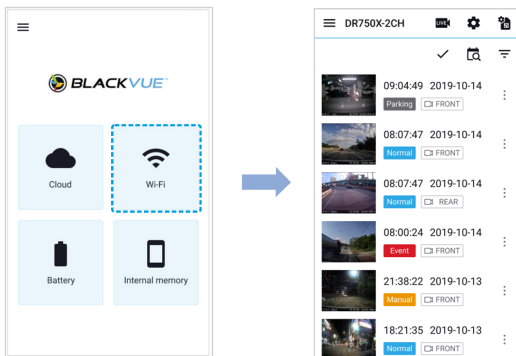

© Select the video file you want to play from the video list.

Note

- Wi-Fi direct lets you connect your smartphone to your dashcam via Wi-Fi within a range of 10m.
- For quick playback and download of the recordings, you can select the “Quick play file” option from App settings.
- All image shown are for illustration purposes only. Actual App may differ from images shown.

□ Playing video files on your computer (Windows/macOS)

- Ⓐ Remove the microSD card from the dashcam.

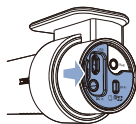

Open side cover



To remove

- Ⓑ Insert the card into the microSD card reader and connect it to a computer.

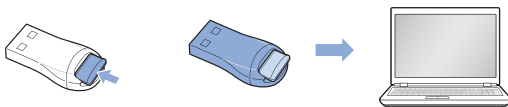

- Ⓒ Download BlackVue Viewer program from www.blackvue.com > **Support** > **Downloads** and install it on your computer.

- D Run BlackVue Viewer. To play, select a video and click on the play button or double click the selected video.

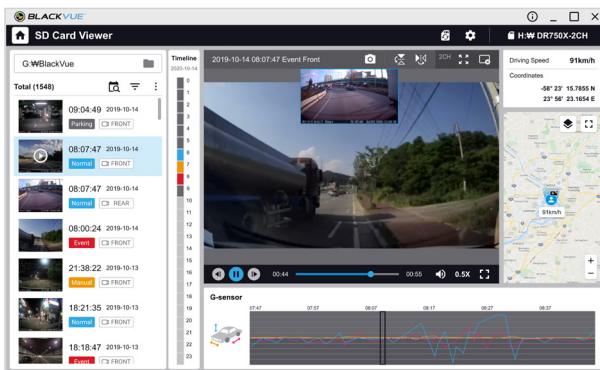

Windows/macOS Viewer

 **Note**

- All images shown are for illustration purpose only. Actual program may differ from images shown.

STEP 3 Changing dashcam's time zone, Wi-Fi password and other settings.

The dashcam's time zone is initially set to (GMT-11). To display the correct time please select your time zone.

□ Using your smartphone (Android/iOS)

- (A) "Pair" your smartphone with the BlackVue dashcam via Wi-Fi direct (for details see STEP 2 'Playing video files on your smartphone').
- (B) Open the BlackVue app and select **Wi-Fi**.
- (C) Tap the  button to access the Firmware settings menu.

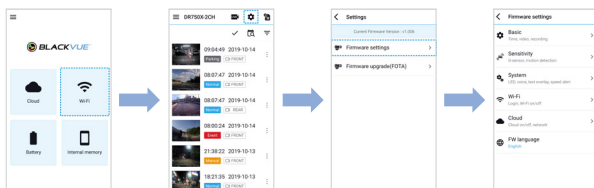

- (D) (i) Select **Firmware settings > Basic > Time**.
- (ii) Select your time zone to auto-sync with GPS time or you can set the time and date manually after enabling **Manual time setting**.

- E** Go back to the Firmware settings menu and configure other desired settings. Settings that can be changed include Wi-Fi SSID & password, image quality, sensitivity settings, voice recording on/off, speed unit (km/h, MPH, off), LEDs on/off, voice guidance volume, Cloud settings etc. Once settings are configured, tap  and tap **Save**.

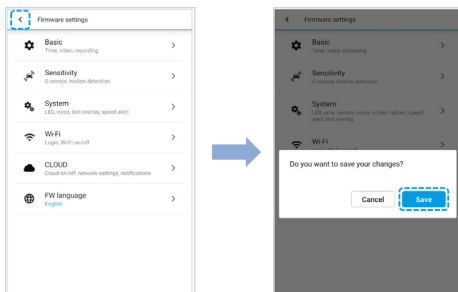

□ Changing the dashcam's time zone and other firmware settings on your **computer** (Windows/macOS)

Run BlackVue Viewer program after connecting dashcam's microSD card to your computer. Click on the  button to open the BlackVue settings panel.



Settings that can be changed include Wi-Fi SSID & password, image quality, sensitivity settings, voice recording on/off, speed unit (km/h, MPH, off), LEDs on/off, voice guidance volume, Cloud settings etc.

For more information about changing the settings in BlackVue Viewer, please refer to the manual from www.blackvue.com > **Support** > **Manuels**.

STEP 4 Connect to BLACKVUE CLOUD (Optional)

If you don't have a mobile Wi-Fi hotspot, Blackvue connectivity module or if you don't want to use the BLACKVUE CLOUD service, you can skip this step.

If you have a mobile Wi-Fi hotspot (also known as a portable Wi-Fi router), BlackVue connectivity module (CM100LTE), a car-embedded wireless internet network or a Wi-Fi network near your car, you can use the BlackVue app to connect to BLACKVUE CLOUD and see in real-time where your car is and the dashcam's live video feed.

For more information about using the BlackVue app, please refer to the manual from www.blackvue.com > **Support** > **Manuals**.



Create an account

- (i) Open the BlackVue app.
- (ii) Tap the ☰ button in the top-left corner and select **Create account**.
- (iii) Enter your name, e-mail address and choose a password. Re-enter your password and press **Sign up**.
- (iv) You will receive an e-mail. Click the link in the email to finish creating your account.



Register your dashcam with your account

- (i) In the BlackVue app select **Cloud** and login to your account.
- (ii) Tap **Yes** to enable push notifications (this setting can be adjusted at any time later).
- (iii) Select **Register new camera**.
- (iv) Register your camera using one of the following methods:

QR Code: Press **Scan QR Code** and line up the QR Code on your smartphone's screen.

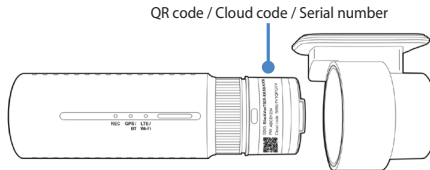

or

Manual registration: Enter your camera's Serial number and Cloud code and press **Register**.

Ⓒ **Connect your BlackVue dashcam to a Wi-Fi hotspot for Cloud connectivity**

- (i) Make sure your BlackVue dashcam and mobile Wi-Fi hotspot are on.
- (ii) "Pair" your smartphone with the BlackVue dashcam via Wi-Fi direct (for details see STEP 2 'Playing video files on your smartphone')
- (iii) Open the BlackVue app. Select **Wi-Fi** > **Settings** > **Firmware settings** > **Cloud**.

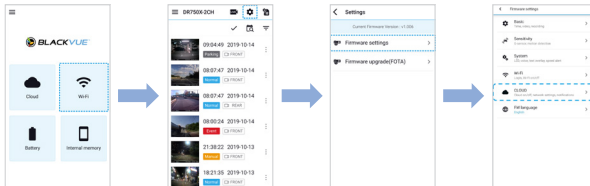

- (iv) Ensure **Enable Cloud service** is on. Select **Cloud service hotspot settings**.
- (v) Choose your Wi-Fi hotspot from the list. Enter the password and tap **OK**.

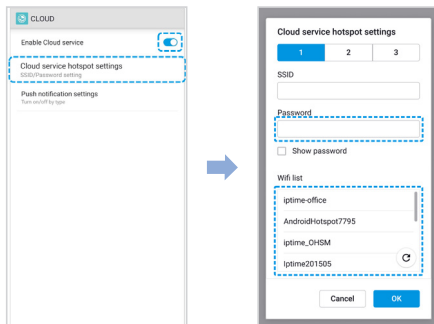

 **Note**

- Up to 3 Wi-Fi hotspot SSIDs can be saved (e.g. home, portable hotspot and work).
- The BlackVue DR750X Plus dashcam is not compatible with 5GHz wireless networks.

(vi) Go back to the Firmware settings menu, tap < and tap **Save**.

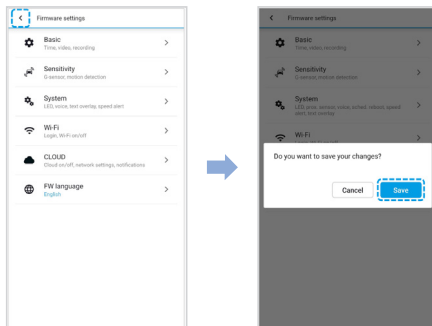

After rebooting, your dashcam will automatically establish internet connection. If internet connection was not established, please ensure Wi-Fi information was inserted correctly.

Select **Cloud** from the main screen to access all of the Cloud features.

Note

- If LTE and Wi-Fi hotspot is available for internet connection, Wi-Fi hotspot will be in priority. If LTE connection is preferred at all times, please remove Wi-Fi hotspot information.

Connect your BlackVue dashcam to Cloud connectivity (Using CM100LTE)

Make sure your BlackVue dashcam and connectivity module is connected. Then, follow the below steps for SIM registration.

- (i) Locate the SIM card slot. Unscrew the bolt from SIM slot cover. Then, unmount the SIM slot by using a SIM eject tool. Insert SIM in the SIM slot. Mount the SIM slot back in the connectivity module, then, screw the bolt to hold SIM slot cover.
- (ii) "Pair" your smartphone with the BlackVue dashcam via Wi-Fi direct.
- (iii) Open the BlackVue app and select **Wi-Fi** > .

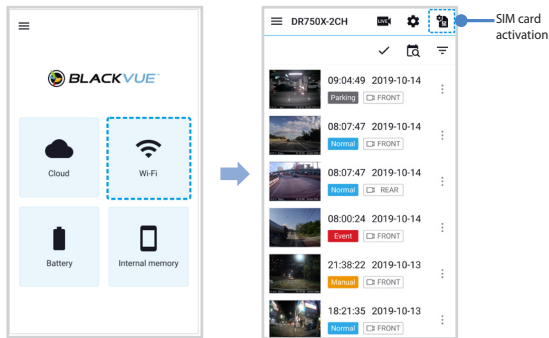

- (iv) Configure the APN settings to activate the SIM card. For detailed information, please check "SIM activation guide" in the packaging box or visit BlackVue Help Center: <https://helpcenter.blackvue.com> -> **SIM Activation Guide (LTE series)**.
- (v) Once your dashcam is connected to the internet, you can go to the **Cloud** menu to use BlackVue Cloud features.

 **Note**

- For full details, refer to the "SIM activation guide" that is included in the CM100LTE package.
- To use the BlackVue Cloud Service, SIM card must be properly activated for Internet access via LTE network.
- When the dashcam is connected to internet, you can use BlackVue Cloud features such as remote Live View and Video playback, Real-time location, push notification, Auto-upload, remote Firmware update etc. on BlackVue app and PC Viewer.
- Some Cloud features may not work when surrounding temperature is high or/and LTE speed is slow.
- For more information about using the BlackVue app, please refer to the manual from www.blackvue.com > **Support** > **Manuals**.

► Tips for optimal performance

- Ⓐ For stable operation of the dashcam, it is recommended to format the microSD card once a month.

Format using BlackVue Viewer (Windows):

Download **BlackVue Windows Viewer** from www.blackvue.com > **Support** > **Downloads** and install it on your computer. Insert the microSD card into the microSD card reader and connect the reader to your computer. Launch the copy of BlackVue Viewer that is installed on your computer. Click the Format  button, select the card drive and click OK.

Format using BlackVue Viewer (macOS):

Download **BlackVue Mac Viewer** from www.blackvue.com > **Support** > **Downloads** and install it on your computer. Insert the microSD card into the microSD card reader and connect the reader to your computer. Launch the copy of BlackVue Viewer that is installed on your computer. Click the Format  button and select the microSD card from the list of drives in the left frame. After selecting your microSD card select the Erase tab in the main window. Select "MS-DOS (FAT)" from the Volume Format drop-down menu and click Erase.

- Ⓑ Only use official BlackVue microSD cards. Other cards may have compatibility issues.
- Ⓒ Regularly upgrade the firmware for performance improvements and updated features. Firmware updates will be made available for download at www.blackvue.com > **Support** > **Downloads**.

Customer Support

For customer support, manuals and firmware updates please visit www.blackvue.com
You can also email a Customer Support expert at cs@pittasoft.com

Product specifications:

Model Name	DR750X Plus DR750X-1CH Plus DR750X-2CH Plus
Color/Size/Weight	Front: Black / Width 118.5 mm x Height 36 mm / 103 g Rear: Black / Width 67.4 mm x Height 25 mm / 25 g
Memory	microSD Card (32 GB / 64 GB / 128 GB / 256 GB)
Recording Modes	Normal recording, Event recording (when impact is detected in normal and parking mode), Manual recording and Parking recording (when motion is detected) * When using Hardwiring Power Cable, ACC+ will trigger parking mode. When using other methods, G-sensor will trigger parking mode.
Camera	Front: STARVIS™ CMOS Sensor (Approx. 2.1 M Pixel) Rear: STARVIS™ CMOS Sensor (Approx. 2.1 M Pixel)
Viewing Angle	Front: Diagonal 139°, Horizontal 116°, Vertical 61° Rear: Diagonal 139°, Horizontal 116°, Vertical 61°
Resolution/ Frame Rate	<Front - Rear> Full HD @60fps - Full HD @30fps * Frame rate may vary during Wi-Fi streaming.
Image Quality	Highest (Extreme), Highest, High, Normal
Video Compression Mode	MP4
Wi-Fi	Built-in (802.11 b,g,n)
Bluetooth	Built-in (4.2 LE,BDR,EDR)
GPS	Built-in (Dual Band : GPS, GLONASS)
LTE	External
Microphone	Built-in

Speaker (Voice Guidance)	Built-in
LED Indicators	Front: Recording LED, GPS LED, LTE/Wi-Fi LED, Front Security LED, Proximity Sensing indicator LED Rear: Rear Security LED
Button	Wi-Fi button: * Press once to turn on/off Wi-Fi. Proximity sensor: Touching the proximity sensor turns on/off audio recording or triggers manual recording depending on the firmware settings.
Sensor	3-Axis Acceleration Sensor
Backup Battery	Built-in super capacitor
Input Power	DC 12V-24V (3 pole DC Plug (Ø3.5 x Ø1.1)) to Wires (Black: GND / Yellow: B+ / Red: ACC)
Power Consumption	<ul style="list-style-type: none"> • DR750X-1CH Plus : Normal Mode (WiFi On / GPS On / 1CH) : Avg. 250mA / 12V Normal Mode (WiFi Off / GPS On / 1CH) : Avg. 200mA / 12V Parking Mode (WiFi On / GPS Off / 1CH) : Avg. 230mA / 12V Parking Mode (WiFi Off / GPS Off / 1CH) : Avg. 180mA / 12V • DR750X Plus / DR750X-2CH Plus : Normal Mode (WiFi On / GPS On / 2CH) : Avg. 390mA / 12V Normal Mode (WiFi Off / GPS On / 2CH) : Avg. 340mA / 12V Parking Mode (WiFi On / GPS Off / 2CH) : Avg. 350mA / 12V Parking Mode (WiFi Off / GPS Off / 2CH) : Avg. 300mA / 12V <p>* Actual power consumption may vary depending on use conditions and environment.</p>
Operation Temperature	-20 °C – 80 °C (-4 °F – 176 °F)

Storage Temperature	-20 °C – 80 °C (-4 °F – 176 °F)
High Temperature Cut-Off	Approx. 80 °C (176 °F)
Certifications	Front: FCC, ISED, CE, UKCA, RoHS, Telec, WEEE Rear: FCC, ISED, CE, UKCA, RoHS, WEEE
Software	BlackVue Viewer * Windows 7 or higher and MacOS X Sierra (10.12) or higher
Application	BlackVue Application (Android 5.0 or higher, iOS 11.0 or higher)
Others	Adaptive Format Free File Management System

* STARVIS is a trademark of Sony Corporation.

Note

- For DR750X-1CH Plus user, if rear camera is added, refer to 2CH specification.

Product Warranty

- The term of this product warranty is 1 year from the purchase date. (Accessories such as an External Battery/ microSD Card: 6 Months)
- We, PittaSoft Co., Ltd., provide the product warranty according to the Consumer Dispute Settlement Regulations (drawn up by the Fair Trade Commission). PittaSoft or designated partners will provide the warranty service upon request.

Circumstances		Warranty		
		Within the Term	Outside of the Term	
For performance/functional problems under normal use conditions	For serious repair required within 10 days of purchase		Exchange/Refund	N/A
	For serious repair required within 1 month of purchase		Exchange	
	For serious repair required within 1 month of exchange		Exchange/Refund	
	When not exchangeable		Refund	
	Repair (If Available)	For Defect	Free Repair	Paid Repair/ Paid Product Exchange
		Repeated problem with the same defect (up to 3 times)		
		Repeated trouble with different parts (up to 5 times)		
	Repair (If Unavailable)	For the loss of a product while being serviced/repaired	Exchange/Refund	Refund after depreciation plus an additional 10% (Maximum: purchase price)
		When repair is unavailable due to lack of spare parts within the component holding period		
		When repair is unavailable even when spare parts are available		
1) Malfunction due to customer fault <ul style="list-style-type: none"> - Malfunction & damage caused by user negligence (fall, shock, damage, unreasonable operation, etc.) or careless use - Malfunction & damage after being serviced/repaired by an unauthorized third party, and not through Pittasoft's Authorized Service Center. - Malfunction & damage due to the use of unauthorized components, consumables, or separately sold parts 		Paid Repair	Paid Repair	
2) Other Cases <ul style="list-style-type: none"> - Malfunction due to natural disasters (fire, flood, earthquake, etc.) - Expired life span of a consumable part - Malfunction due to external reasons 				

- This warranty is only valid in the country where you purchased the product.

Notes



DR750X-1CH Plus:



FCC ID : YCK-DR750XP / HVIN : DR750X-1CH Plus

DR750X Plus / DR750X-2CH Plus:



FCC ID : YCK-DR750XP / HVIN : DR750X-2CH Plus

Product | Car Dashcam
Model Name | DR750X Plus, DR750X-1CH Plus, DR750X-2CH Plus
Manufacturer | Pittasoft Co., Ltd.
Address | A 4th floor, ABN Tower, 331, Pangyo-ro, Bundang-gu
Seongnam-si, Gyeonggi-do South Korea
Customer Support | cs@pittasoft.com
Product Warranty | One-Year Limited Warranty
f facebook.com/BlackVueOfficial
i instagram.com/blackvueofficial
www.blackvue.com
Made in Korea