

**File No: HYTERA-I&M-79XIS-001**

**Rev: V1.0**

Date:2015.9.21

---

## Preface

Thanks for your favor in our product. To derive optimum performance from the product, please read this manual and the supplied Safety Information Booklet carefully before use.

This manual is applicable to the following model:

PD79XIS Digital Portable Radio (X may represent 2, 5, 6 or 8).

# Copyright Information

Hytera is the trademark or registered trademark of Hytera Communications Co., Ltd. (the Company) in PRC and/or other countries or areas. The Company retains the ownership of its trademarks and product names. All other trademarks and/or product names that may be used in this manual are properties of their respective owners.

The product described in this manual may include the Company's computer programs stored in memory or other media. Laws in PRC and/or other countries or areas protect the exclusive rights of the Company with respect to its computer programs. The purchase of this product shall not be deemed to grant, either directly or by implication, any rights to the purchaser regarding the Company's computer programs. Any of the Company's computer programs may not be copied, modified, distributed, decompiled, or reverse-engineered in any manner without the prior written consent of the Company.

The AMBE+2™ voice coding technology embodied in this product is protected by intellectual property rights including patent rights, copyrights and trade secrets of Digital Voice Systems, Inc. This voice coding technology is licensed solely for use within this product. The user of this technology is explicitly prohibited from attempting to decompile, reverse engineer, or disassemble the Object Code or in any other way convert the Object Code into a human readable form.

U.S. Patent No: #6,912,495 B2, #6,199,037 B1, #5,870,405, #5,826,222, #5,754,974, #5,701,390, #5,715,365, #5,649,050, #5,630,011, #5,581,656, #5,517,511, #5,491,772, #5,247,579, #5,226,084 and #5,195,166.

# Disclaimer

The Company endeavors to achieve the accuracy and completeness of this manual, but no warranty of accuracy or reliability is given. All the specifications and designs are subject to change without notice due to continuous technology development. No part of this manual may be copied, modified, translated, or distributed in any manner without the express written permission of us.

We do not guarantee, for any particular purpose, the accuracy, validity, timeliness, legitimacy or completeness of the Third Party products and contents involved in this manual.

If you have any suggestions or would like to learn more details, please visit our website at:

<http://www.hytera.com>.

## RF Radiation Information

The radio is not intended for use by general population in an uncontrolled environment. It is only for occupational use and only applied to work-related conditions.

The radio must be only used by users who are fully aware of the hazards of the exposure and who are able to exercise control over their RF exposure to qualify for the higher exposure limits.

### RF Radiation Profile

Radio Frequency (RF) is a frequency of electromagnetic radiation in the range at which radio signals are transmitted. RF technology is widely used in communication, medicine, food processing and other fields. It may generate radiation during use.

### RF Radiation Safety

In order to ensure user health, experts from relevant industries including science, engineering, medicine and health work with international organizations to develop standards for safe exposure to RF radiation. These standards consist of:

- United States Federal Communications Commission, Code of Federal Regulations; 47CFR part 2 sub-part J;
- American National Standards Institute (ANSI)/Institute of Electrical and Electronic Engineers (IEEE) C95. 1-1992;
- Institute of Electrical and Electronic Engineers (IEEE) C95. 1 – 1999;
- International Commission on Non-Ionizing Radiation Protection (ICNIRP) 1998;

## FCC Regulations

Federal Communication Commission (FCC) requires that all radio communication products should meet the requirements set forth in the above standards before they can be marketed in the U.S, and the manufacturer shall post a RF label on the product to inform users of operational instructions, so as to enhance their occupational health against exposure to RF energy.

## Operational Instructions and Training Guidelines

To ensure optimal performance and compliance with the occupational/controlled environment RF energy exposure limits in the above standards and guidelines, users should transmit no more than 50% of the time and always adhere to the following procedures:

Your radio radiates measurable RF energy only while it is transmitting (during talking), not when it is receiving (listening) or in standby mode.

## EU Regulatory Conformance

As certified by the qualified laboratory, the product is in compliance with the essential requirements and other relevant provisions of the Directive 1999/5/EC. Please note that the above information is applicable to EU countries only.

# Contents



<b>1. Documentation Conventions</b> .....	<b>7</b>
1.1 Instructional Icons.....	7
1.2 Notational Conventions.....	7
1.3 Key Operation.....	7
<b>2. Intrinsically Safe Radio Information</b> .....	<b>8</b>
2.1 Equipment marking.....	8
2.2 No Misoperations.....	8
2.3 Safety Instructions .....	9
2.4 Specifications.....	9
2.5 Compliance Standards.....	10
<b>3. Items in the Package</b> .....	<b>12</b>
<b>4. Product Introduction</b> .....	<b>13</b>
4.1 Product Controls .....	13
4.2 Programmable Keys .....	14
<b>5. Before Use</b> .....	<b>16</b>
5.1 Charge the Battery.....	16
5.2 Assembling Accessories .....	17
5.2.1 Assembling the Antenna .....	17
5.2.2 Assembling the Battery .....	17
5.2.3 Assembling the Belt Clip .....	18
5.2.4 Attaching Audio/Programming Cable .....	19
<b>6. Status Indication</b> .....	<b>21</b>
6.1 LCD Icon.....	21
6.2 LED Indicator.....	21
<b>7. Menu Navigation</b> .....	<b>23</b>
<b>8. Basic Operations</b> .....	<b>24</b>
8.1 Powering On/Off .....	24
8.2 Registering.....	24
8.3 Adjusting the Volume.....	24
8.4 Locking/Unlocking the Keypad.....	24
8.5 Selecting a Subgroup.....	25
8.6 Selecting a Group Contact.....	25
<b>9. Call</b> .....	<b>27</b>
9.1 Private Call .....	27
9.1.1 Initiating a Call .....	27
9.1.2 Receiving a Call.....	28
9.1.3 Voice Communication .....	28
9.1.4 Conversation Limit.....	28

9.1.5 Ending a call .....	28
9.2 PSTN/PABX Call.....	29
9.2.1 Initiating a Call .....	29
9.2.2 Receiving a Call.....	30
9.2.3 Voice Communication .....	30
9.2.4 Conversation Limit .....	30
9.2.5 Ending a call .....	30
9.3 Group Call.....	30
9.3.1 Initiating a Call .....	30
9.4 One Touch Call.....	33
9.5 Emergency Call .....	33
9.5.1 Initiating a Call .....	34
9.5.2 Receiving a Call.....	34
9.5.3 Voice Communication .....	34
9.5.4 Ending a call .....	34
9.6 Queue Call.....	34
9.7 Time-out Timer (TOT).....	35
10.3.2 CPS-P3 dialing rule .....	37
10.8 LQO .....	40
10.9 Hunt .....	40
10.9.1 TSCC Hunt .....	40
10.9.2 Hunt for Smooth Communications .....	43
10.10 Encrypt.....	44
10.11 Authentication .....	44
10.12 Covert Mode .....	45
10.13 Man Down (optional).....	45
10.14 Rent .....	45
10.15 Priority.....	45
10.18 GPS .....	47
<b>11. Troubleshooting .....</b>	<b>49</b>
<b>12. Care and Cleaning.....</b>	<b>51</b>

# 1. Documentation Conventions

For your better understanding of this manual, please read the following conventions first.

## 1.1 Instructional Icons

Icon	Description
 <b>Note</b>	Indicates references that can further describe the related topics.
 <b>Caution</b>	Indicates situations that could cause data loss or equipment damage.

## 1.2 Notational Conventions

Convention	Description
“ ”	The quotation marks enclose the name of a software interface element. For example, click “OK”.
<b>Bold</b>	The text in boldface denotes the name of a hardware button. For example, press the <b>PTT</b> key.
->	The symbol directs you to access a multi-level menu. For example, to select “New” from the “File” menu, we will describe it as follows: File -> New.

## 1.3 Key Operation

Operation	Definition
Short press	To press a key and release it quickly.
Long press	To press a key for the preset time (2s by default) and release it.
Hold	To press a key and do not release it.

## 2. Intrinsically Safe Radio Information

### 2.1 Equipment marking

#### FM/CAN

- Class I, Zone 0 AEx/Ex ia IIC T4 Ga
- 
- Class I,II,III Div1 Group A,B,C,D,E,F,G T120°C

#### ATEX

- II 1G Ex ia IIC T4
- II 1D Ex ia IIIC T120°C IP6X
- I M1 Ex ia

#### IECEX

- Ex ia IIC T4 Ga
- Ex ia IIIC T120°C Da IP6X
- Ex ia I Ma

### 2.2 No Misoperations

Stop operating this product and leave the explosive atmosphere immediately when the safety or integrity of the product is endangered, and deliver it to your local dealer for examination.

These items may endanger the product's safety or integrity:

- The radio is stored improperly;
- The radio is faulty;
- The radio works with overload;
- The radio's operational error or threshold value is out of allowed range.
- The radio is damaged during transportation;
- The radio's housing is obviously damaged or cracked;
- The radio logo or model is hard to be recognized;



## 2.3 Safety Instructions

### Caution

To protect you against any property loss, bodily injury or even death, be sure to observe the following safety instructions:

- Use only the Ex-battery BL1813-Ex and BL2413-Ex specified by the Company. The use of other batteries may result in Ex-protection failure.
- Charge the battery in a non-hazardous area only with the designated charger.
- Use the accessories specified by the Company only.
- Do not carry any standby battery into a hazardous area.
- Do not use a damaged antenna. If a damaged antenna comes into contact with your skin, a minor burn may result.
- Do not expose the radio to direct sunlight for a long time, nor place it close to a heating source.
- Hold the radio upright and keep its microphone 2.5 to 5 centimeters away from your mouth during use.
- If you wear a radio on your body, ensure its antenna is at least 0 centimeters away from your body during transmission.
- Please do not use the radio out of the operating temperature range specification of this product.
- Do not disassemble the radio or replace the accessories in a hazardous area.
- Do not remove the battery from the radio in a hazardous area.
- Do not attempt to repair and service the radio, batteries and its accessories. Please contact your dealer for repair and servicing.
- Do not disassemble or redo the radio. Unauthorized modification of the radio may result in termination of Ex-protection (intrinsic safety) of the radio.
- Improper usage of the product other than it is intended to be used for will impair safety of the product, yourself and surrounding environment.

## 2.4 Specifications

Item	Specifications
Rated Operating Voltage	DC 7.4V
Max. Operating Voltage	DC 8.4V
Max. Operating Current	1.8A

Weight (with standard antenna & battery)	About 498g
Sensitivity	0.70 $\mu\text{V}/(\text{V}/\text{m})^2$ to 0.85 $\mu\text{V}/(\text{V}/\text{m})^2$
RF Power Output	1W
Rated Audio Power Output	0.5W
Audio Distortion	3%
Ambient Temperature	-20°C–+55°C
Storage Temperature	-40°C–+85°C
Charging Temperature	0°C–+40°C
Battery	Ex-battery BL1813-Ex (1800mAh)
Battery Life	About 14 hours (5-5-90 duty cycle)
Charging Time	About 4 hours





## 2.5 Compliance Standards

Standard	Issue Date
<b>FM</b>	
FM Class 3600	2011
FM Class 3610	2010
FM Class 3810	2005
ANSI/IEC-60529(Ed. 4.0)	2004
ANSI/ISA-60079-0(12.00.01)	2009
ANSI/ISA-60079-11(12.02.01)	2012
ANSI/ISA-61010-1(82.02.01)	2004
<b>CAN</b>	
CAN/CSA-C22.2 No.0-M91	2006
CAN/CSA-C22.2 No.142-M1987	2009
CAN/CSA-C22.2 No.213-M1987	2008

Standard	Issue Date
CAN/CSA-C22.2 No.60079-0 (Ed. 5.0)	2011
CAN/CSA-C22.2 No.60079-11 (Ed. 5.0)	2011
CAN/CSA-C22.2 No.60529 (Ed. 5.0)	2005
CAN/CSA-C22.2 No.61010-1 (Ed. 2.0)	2009
<b>ATEX</b>	
EN 60079-0 (Ed. 5.0)	2009
EN 60079-11 (Ed. 6.0)	2012
EN 60529+A1 (Ed. 2.0)	1992
<b>IECEx</b>	
IEC-60079-0 (Ed. 5.0)	2007
IEC-60079-11 (Ed. 6.0)	2011
IEC-60529 (Ed. 2.1)	2001

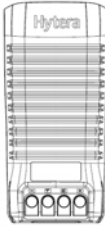
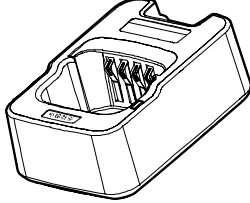
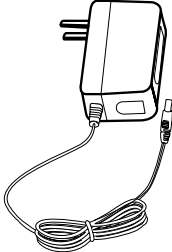
### 3. Items in the Package

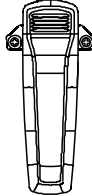
Please unpack carefully and check that all items listed below are received. If any item is missing or damaged, please contact your dealer.

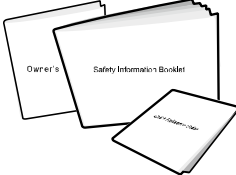
		
Portable Radio	Battery	Charger
		
Power Adapter	Antenna	Belt Clip
		
Strap	Documentation Kit	

 **Note**

And the frequency band is marked on the label of antenna; if not, refer to the label on the radio for frequency band information.

# 4. Product Introduction

This section introduces the mechanical structure and the programmable key features of this product.

## 4.1 Product Controls

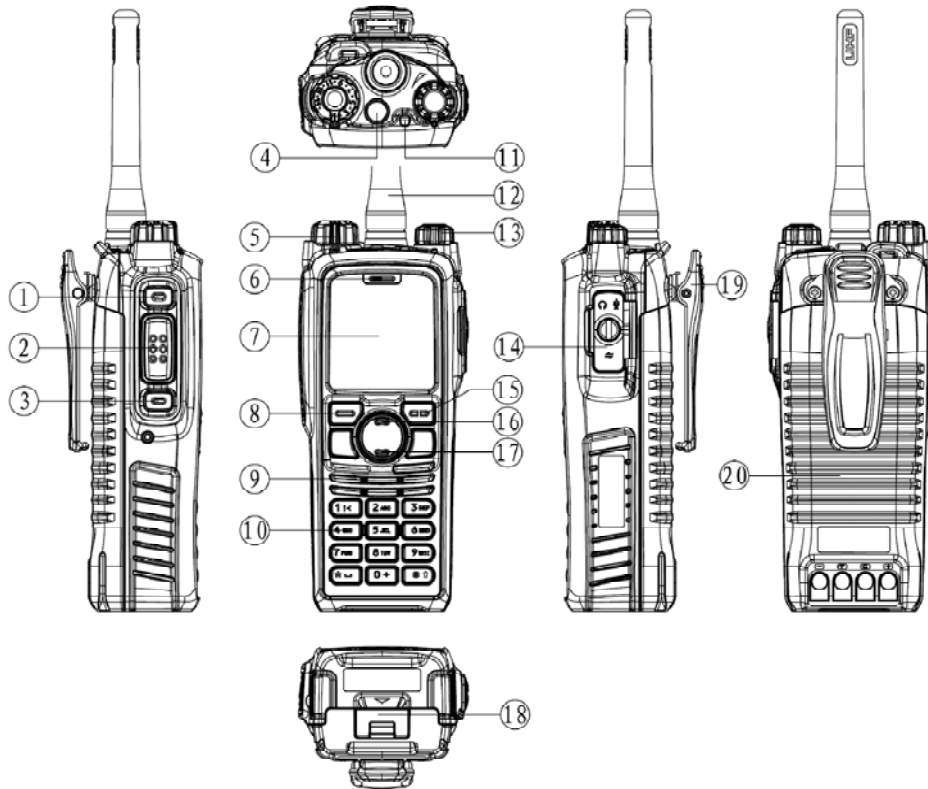

No.	Part Name	No.	Part Name
①	SK1 (Side Key 1)	⑪	LED Indicator
②	PTT Key	⑫	Antenna
③	SK2 (Side Key 2)	⑬	Power On-Off/Volume Control Knob
④	TK (Top Key)	⑭	Accessory Jack
⑤	Group Call Selector Knob	⑮	Back/Subgroup Key
⑥	Microphone	⑯	Up Key
⑦	LCD Display	⑰	Down Key
⑧	OK/Menu Key	⑱	Battery latch
⑨	Speaker	⑲	Belt clip
⑩	Numeric Keypad	⑳	Battery

## 4.2 Programmable Keys

For enhanced convenience, you may request your dealer to program the keys **SK1**, **SK2**, and **TK** as shortcuts to the functions listed below. For detailed introductions of the functions, see the chapter “Functions and Operations”.

No.	Programmable Features	Description
1	On-hook	To disconnect the call.
2	Keypad Lock	To lock or unlock the keypad quickly.
3	Adjust Power Level	To adjust Tx power level quickly.
4	Private Contact List	To access the menu “Contact List” quickly.
5	Current Subgroup Contact	To access the menu “Subgroup” quickly.
6	Call Log	To access the menu “Call Logs” quickly.
7	Operation Mode	To access the menu “Mode” quickly.
8	Hunt Mode	To access the menu “Hunt” quickly.
9	Manual Current Hunt	To hunt and make a registration again.
10	Background Hunt	To enable or disable the background hunt feature.
11	HomeStation Hunt	To enable or disable the home-station hunt feature.
12	Multi-site Handover	To enable or disable the multi-site handover feature.
13	Encrypt	To enable or disable the encryption feature.
14	LQO	To enable or disable LQO.
15	Covert Mode	To enable or disable the Covert mode.
16	Emergency On	To make an emergency call for help in emergent situations.
17	Emergency Off	To end the emergency call.
18	Battery Power Indicator	To check the battery power.
19	Man Down	To enable or disable the man down function.
20	Message	To access the menu “Message” quickly.
21	ReDial Call	To call the last person you have contacted.
22	BackDial Call	To call the last person who has contacted you.
23	Operation Mode Switch	To switch the operation mode of the radio.

No.	Programmable Features	Description
24	One Touch Call 1-5	To call or to send a message to the preset contact quickly.
25	VOX	To enable or disable the VOX feature.

 **Note**

- Long and short press of a key can be assigned with different functions by your dealer.
- The **TK** key is programmed as the **Emergency On/Off** key by default, and is programmable by your dealer.

# 5. Before Use

## 5.1 Charge the Battery

Use only the charger and battery specified by the company. Charger LED can indicate the charging status, as introduced in the table below. The following figure shows the steps for charging.

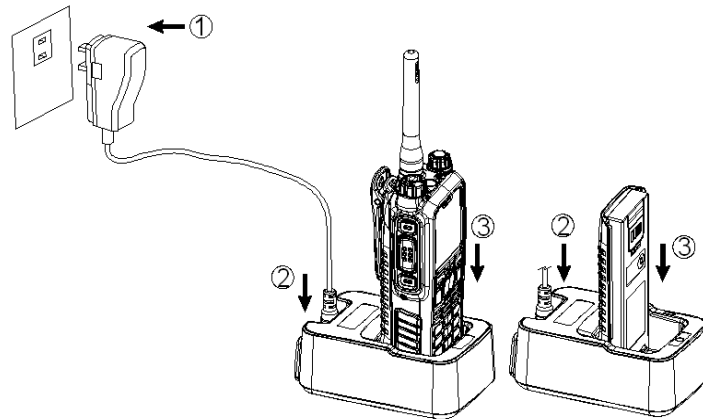

**Step 1** Connect the power adapter to AC socket. See arrow ①.

**Step 2** Plug the power adapter into the rear jack of the charger. See arrow ②.

**Step 3** Place the radio with the battery attached, or the battery alone, into the charger. See arrow ③.

During charging, the LED on the charger will indicate the charging status. The charging status begins when the charger LED glows red. When charging is complete, the charger LED glows green.

See the following table for details.



### Note

- To achieve optimal battery performance, please charge the battery for 5 hours before initial use.
- Be sure to read the Safety Information Booklet, to get necessary battery safety information.

LED	Charging Status
The LED flashes red slowly.	Standby
The LED glows red.	Charging
The LED glows orange.	90% charged
The LED glows green.	Fully charged



LED	Charging Status
The LED flashes red rapidly.	Failure

## 5.2 Assembling Accessories

### 5.2.1 Assembling the Antenna

Turn the antenna clockwise to fasten it.

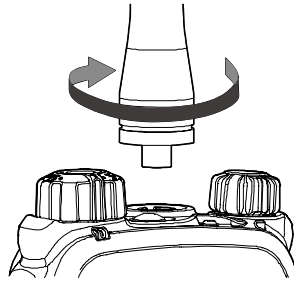

To remove the antenna, rotate it counter-clockwise.

### 5.2.2 Assembling the Battery

**Step 1** Align the battery slots with the guide rails on the radio, and push the battery ②.

## 4.3 Attaching the Battery

1. Align the battery slots with the guide rails on the terminal, and push the battery as ② shows.

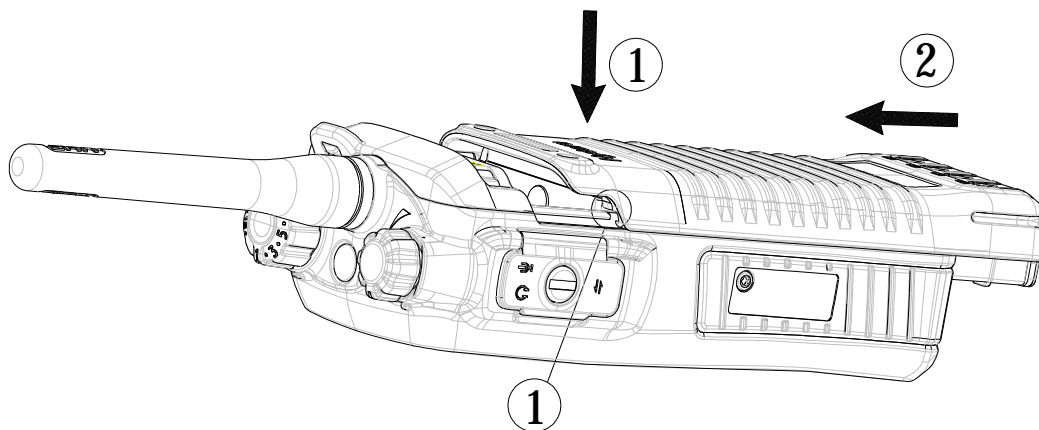

2. Open the battery latch and hold it down until the metal lock goes into the battery housing completely.

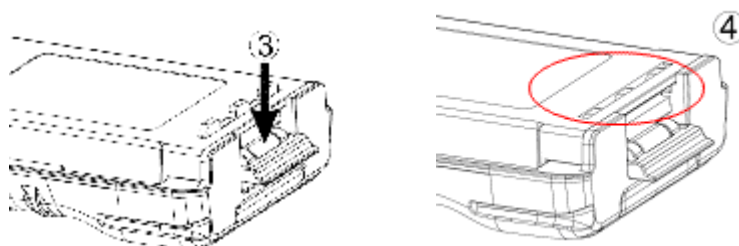

3. Push the battery until it is fully fitted into the slot, and then release the battery latch.

- 4.

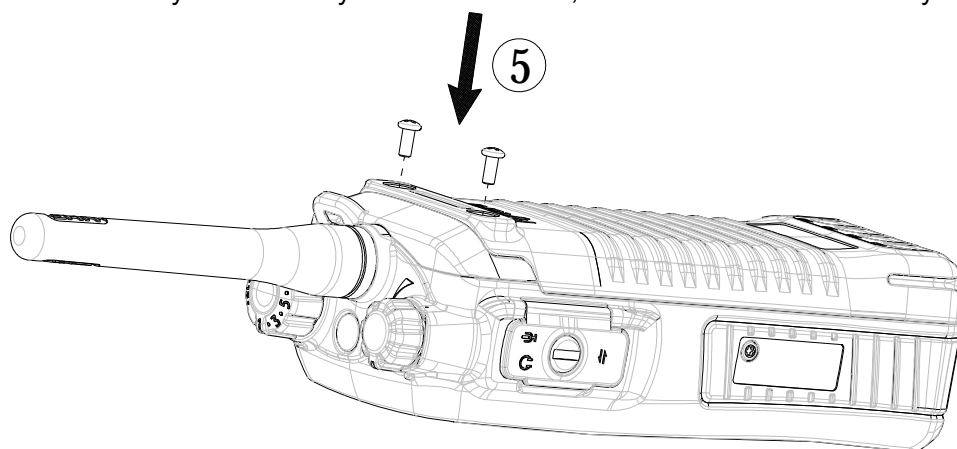

### Note:

To remove the battery, please power off the terminal first. Then open the battery latch, and slide the battery out while holding down the battery latch.

**Step 2** Align the screws with the screw holes in the belt clip and on the radio's back, and then tighten the screws.

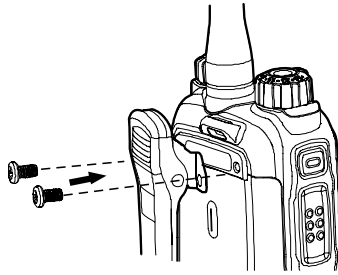

To remove the belt clip, loosen the screws.

## 5.2.4 Attaching Audio/Programming Cable

**Step 1** Open the accessory jack cover as the arrow shows.

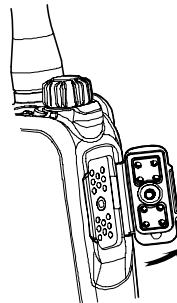

**Step 2** Align the plug with the accessory jack.

### **Caution**

- When aligning, make sure not to scrape the silica gel surrounding the accessory jack screw hole, in order to ensure the waterproof performance of the radio.
- Be sure to align the screw on the accessory connector to the screw hole in the jack before fastening the screw.

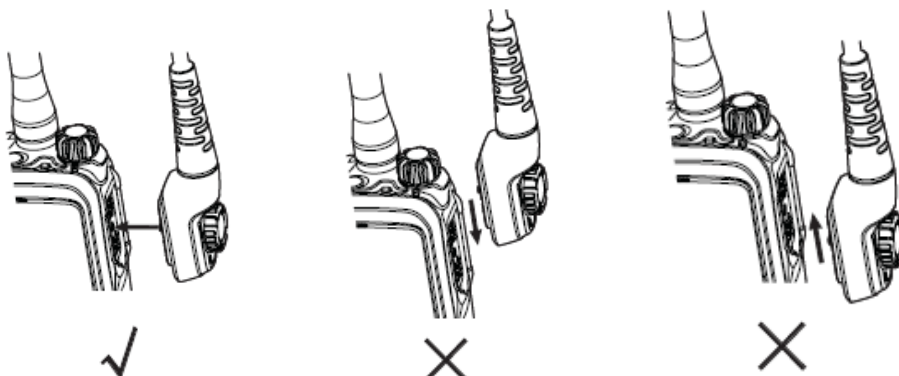



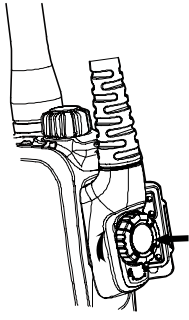











**Step 3** Tighten the screw on the connector.



To remove the accessory connector, loosen the screw.

## 6. Status Indication

### 6.1 LCD Icon

Icon Name	Icon	Radio Status
Operation Mode Icon		TMO Mode: In this mode, this product communicates with other radios or systems via the trunking system.
RSSI Icon		No signal.
		More bars indicate better signal strength.
Message Icon		New message/unread message.
		InBox is full.
Hunt Icon		Hunt status (This icon does not indicate the background hunt, homestation hunt and multi-site handover.)
Roam Icon		The radio is roaming.
TX Power Icon		Low TX power for the current channel.
		High TX power for the current channel.
Battery Strength Icon		More bars indicate more battery power.
Speaker Icon		The speaker is unmated.
VOX Icon		VOX is active.
Accessory Icon		An accessory is connected.
GPS Icon		The GPS feature is active, and valid GPS data is received.
		The GPS feature is active, but no valid GPS data is received.

### 6.2 LED Indicator

The top LED will help you easily identify the current radio status.

LED Indication	Radio Status
The LED flashes green.	Powering on
The LED flashes green slowly.	Standby
The LED glows green	Receiving
The LED glows red	Transmitting
The LED flashes red.	Making a call (the LED flashes on the calling radio).
The LED flashes orange rapidly.	Making a FOACSU private call (the LED flashes on the called radio).
The LED flashes orange slowly.	Hunting
The LED glows orange.	No voice is being transmitted or received on the channel after a call is established. Within such period, you can hold the <b>PTT</b> key to talk.

# 7. Menu Navigation

The following figure outlines your radio's menu structure. You can personalize menu options displayed in the radio via your dealer.

To select and confirm the options shown in the menu, press the **Menu** key to enter the main menu, and then press the **Up/Down** key to select your wanted option, finally press the **OK** key.

This radio supports menu reset function. If you do not operate the menu for a predefined time period, the radio will automatically return to the home screen. You can define the reset time or cancel the reset feature via your dealer.

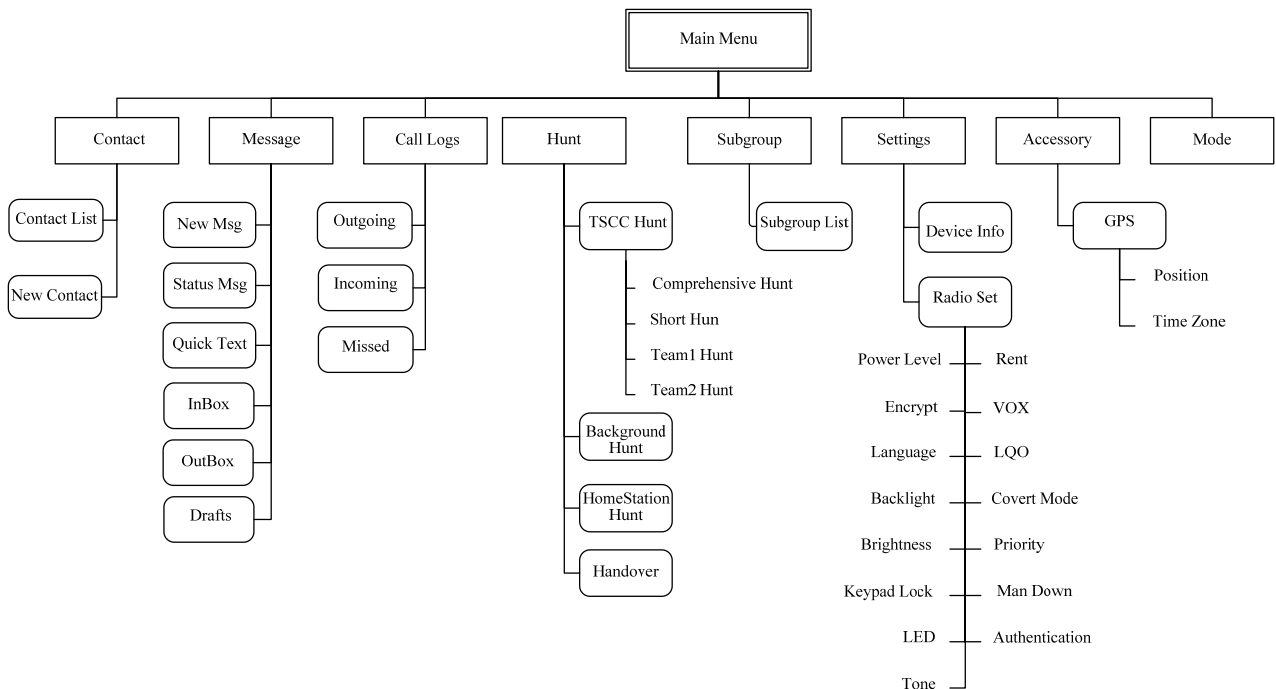

## 8. Basic Operations

### 8.1 Powering On/Off

Rotate the **Power On-Off/Volume Control** knob clockwise/counter-clockwise until a click is heard to turn the radio on/off.

### 8.2 Registering

For proper work, the radio will register with a proper base station automatically after powering on.

#### Hunting the control channel

Before registering, the radio will hunt through the control channels for available base stations.

**Step 1** The radio will start hunting automatically after powering on.

There are two hunting plans available. For details, see “Hunt” in “Functions and Operations” chapter. You need to preset the hunt plan by your dealer. The two hunt plans are:

- Fixed Control Channel
- Flexible Control Channel

**Step 2** During the hunt, both the prompt “Registering, Please Wait!” and the icon appear on the LCD, and the LED flashes orange slowly.

#### Making a registration

**Step 1** When hunting signals of the base station, the radio determines whether the base station allows it to register.

**Step 2** After registering successfully, the radio will display the prompt “Registered Successfully!” on the LCD. Then it is ready for use. If you want the radio to register with another base station, press the programmed **Manual Current Hunt** key to hunt again.



**Note:** It is highly recommended to put the frequently used frequencies of base stations in the control channel list via your dealer.

### 8.3 Adjusting the Volume

After turning on the radio, rotate the **Radio On-Off/Volume Control** knob clockwise to increase the call volume and group number notifying volume, or counter-clockwise to decrease them.

### 8.4 Locking/Unlocking the Keypad

When the keypad is not in use, you can lock it through any of the methods below to prevent accidental keypad operation.

- Combined Function Key



Use “OK+  ” to lock or unlock the keypad.

- Programmable Keys

Press the programmed **Keypad Lock** key to lock or unlock the keypad.

- Menu Selection

Go to “Settings -> Radio Set -> Keypad Lock”, and then select “Enable” or “Disable”.

- Enable: The keypad will be locked automatically if no operation is made within the preset time period.
- Disable: The keypad will not be locked automatically. However, you can lock or unlock the keypad via the key combination or **Keypad Lock** key mentioned above.

 **Note:** When the feature “Keypad Auto Lock” is enabled, the keypad will be locked automatically if no operation is made within the preset time period. You can use the “Disable” option in the menu “Keypad Lock” to deactivate the Keypad Auto Lock feature.

## 8.5 Selecting a Subgroup

You can include your desired group call contacts into a subgroup for efficient management. The radio supports up to 32 subgroups, each with a maximum of 16 group call contacts.

You may select a subgroup through any of the following methods:

- Menu

Go to the menu “Subgroup -> Members -> Group Call”, Afterwards, select “Set Default” and press the **OK** key to switch to that subgroup.

- Shortcuts

In the home screen, directly press the **Subgroup** key to enter the subgroup menu and select the subgroup.

 **Note:** This radio supports only one subgroup list which can contain 32 subgroups at most.

## 8.6 Selecting a Group Contact

### Operation

After the radio is powered on and makes a registration successfully, you may select a group call contact through any of the following methods:

- Knob

Rotate the **Group Call Selector** knob to select your desired group call contact. An audio alert and the prompt “No Group Program” will be given in case of no group call contact preset for this knob.

- Menu

Go to the menu “Subgroup -> Members -> Group Call”, and press the **Up /Down** key to select the group call contact.

- Shortcuts

You can press the programmed **Group Call List** key to access the group call list, and select the group call contact by pressing the **Up/Down** key.

### Group Call Attribute

Group call attribute means the attribute of a group that the group call contacts are in. It is set by the dealer. This radio supports four group call attributes: Background, Response, Participant and Radio ID. You can only find and call the contacts of Participant and Response in the subgroup member list, and receive group calls from the Response, Participant and Background. To receive different attributes of group calls, you need to have different configurations to the radio as listed below:

 **Note:** When the Radio ID is selected by the **Group Call Selector** knob, the radio can receive any group call made by the available group call contacts.

Group Call Attribute	Settings
Response	If the group call contact is available in the subgroup member list, the radio can receive the group calls made to this group without any operation by the <b>Group Call Selector</b> knob.
Participant	Only when the Participant group call contact or the Radio ID is selected by the <b>Group Call Selector</b> knob, can the radio receive the group calls made to this group.
Background	This group call contact is unavailable. Only when this group call contact is preset by the dealer, can the radio receive the group calls to this group.

# 9. Call

To ensure optimal volume of the receiving radio, keep the microphone approximately 2.5 to 5 centimeters away from your mouth.

 **Note:** Once the radio hasn't made a registration or no group call contact is preset for the **Group Call Selector** knob, the radio cannot make a call.

## 9.1 Private Call

Private call supports two call types, FOACSU and OACSU, configured by the trunking system.

- FOACSU: During call setup, the calling radio rings. The called party answers the call manually.
- OACSU: During call setup, the calling radio does not ring. The called party answers the call automatically.

### 9.1.1 Initiating a Call

When the radio transmits a private call, the icon  will appear on the LCD. The ring indication is given until the called party answers this call. You may transmit a private call through any of the following methods.



#### Contact List or Call Logs

**Step 1** Enter the Contact List (path: "Menu -> Contact -> Contact List") or Outgoing/Incoming/Missed Calls (path: "Menu -> Call Logs").

**Step 2** Use the **Up/Down** key to select the private call contact you want to call.

**Step 3** Press the  or the **PTT** key to make a call.

#### ReDial or BackDial Call Log

**Step 1** In the home screen, press the  or  key to access the appropriate call log.

**Step 2** Use the **Up/Down** key to select the private call contact you want to call.

**Step 3** Press the  or the **PTT** key to make a call.

#### Manual Dial

**Step 1** In the home screen, input a private call number using the keypad. See "Manual Dial" in "Functions and Operations" chapter for the range of private call number.





**Step 2** Press the  key, **PTT** key or  key to make a call.

#### Missed Call Screen

Press the **PTT** key in the "Missed Call" screen to directly call back the last missed private call contact, or press the  key or the **PTT** key to call back when viewing that call number.

## 9.1.2 Receiving a Call



### FOACSU Private Call

When a private call arrives, both ring and vibration indication will be given, with the icon  displayed on the LCD as well. You may press the  or **PTT** key within the preset time period to answer the call, and the radio will display the icon . An alert tone will be given as well. If you don't answer this call, the radio will display the icon  to remind you.

### OACSU Private Call

The call is established automatically. The icon  will appear on the LCD when this call is established successfully.

## 9.1.3 Voice Communication

After a private call is established, either the calling party or the called party can transmit a voice call only if the **PTT** key is free with the LCD displaying "PTT Enabled!". The radio will display the icon  during transmission and the icon  upon receipt respectively.

## 9.1.4 Conversation Limit

When a private call is established, both the calling party and the called party will display the call duration in a real-time way. See the following figure.

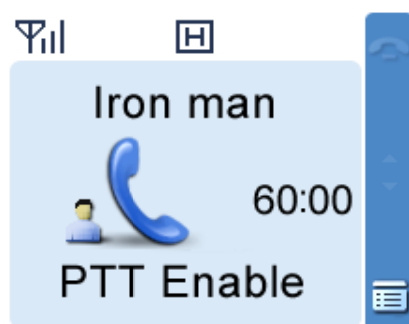

- At the calling party

The calling party will display the total allowed time for a call in a way of counting down. This time period is programmed by your dealer. The call will be ended when its duration exceeds the preset time.

- At the called party

The called party will display the actual communication time.

## 9.1.5 Ending a call

The voice communication will be terminated when one of the following situations occurs:

- Neither of the parties holds down the **PTT** key to talk within the preset time.
- The call duration exceeds the allowed time preset by the dealer.
- Either the calling party or the called party ends the in-progress call.

- Signal of base station is missing.
- Either the calling party or the called party selects an empty group by the **Group Call Selector** knob.
- A pre-emptive call or emergency call occupies the current channel.

## 9.2 PSTN/PABX Call

The radio can make and receive a PSTN/PABX call. Since PSTN call has the same calling process with PABX call, the following operations are based on the PSTN call.

### 9.2.1 Initiating a Call

When the radio transmits a PSTN call, the icon  will appear. The ring indication will be given until the called party answers this call. You may transmit a PSTN call through any of the following methods.



#### Contact List or Call Logs

**Step 1** Enter the Contact List (path: “Menu -> Contact -> Contact List”) or Outgoing/Incoming/Missed Calls (path: “Menu -> Call Logs”).

**Step 2** Use the **Up/Down** key to select the PSTN contact you want to call.

**Step 3** Press the  or **PTT** key to make a PSTN call.

#### ReDial or BackDial Call Log

**Step 1** In the home screen, press the  or  key to access the appropriate call log.

**Step 2** Use the **Up/Down** key to select the PSTN contact you want to call.

**Step 3** Press the  or **PTT** key to make a PSTN call.

#### Manual Dial



**Step 1** In the home screen, input a number using the keypad according to either of the following schemes. (For details, see “Manual Dial” in “Functions and Operations” chapter).

- CPS-P/CPS-P3 Dialing: 01 + PSTN number.
- 1343-E Dialing: \*01\* + PSTN number.

#### Note

To make a PABX call, enter the number according to either of the following schemes.



- CPS-P/CPS-P3 Dialing: 02 + PABX number.
- 1343-E Dialing: \*02\* + PABX number.



**Step 2** Press the  key, **PTT** key or  key to transmit a PSTN call.

#### Missed Call Screen

Hold the **PTT** key in the “Missed Call” screen to directly call back the last missed PSTN call contact, or press the  or the **PTT** key to call back when viewing that call number.

## 9.2.2 Receiving a Call

When a PSTN call arrives, both ring and vibration indication will be given, with the icon  displayed on the LCD as well. You may press the  or **PTT** key within the preset time period to answer the call.

When the call is established, the radio will display the icon . Ring alert will be given as well. If you don't answer this call, the radio will display the icon  to remind you.

## 9.2.3 Voice Communication

When a PSTN call is established, you can talk by holding the **PTT** key. When transmitting the voice, the radio cannot receive the voice of the PSTN user.

## 9.2.4 Conversation Limit

When a PSTN call is established, the calling party will display the call time preset by the dealer in a way of counting down. The called party will display the actual communication time.

The call will be ended when its duration exceeds the preset time.

## 9.2.5 Ending a call

The voice communication will be terminated when one of the following situations occurs:

- The call duration is over the allowed time preset by the dealer.
- Either the calling party or the called party ends the in-progress call.
- A pre-emptive call or emergency call occupies the current channel.
- The radio switches its operation mode via the menu.
- Either the calling party or the called party selects an empty group by the **Group Call Selector** knob.
- Either of the parties turns off the radio or logs out of the system.
- Signal of base station is missing.

## 9.3 Group Call

Group call includes general group call and broadcast group call. In a general group call, both the calling party and the called party can speak. However, in a broadcast call, only the calling party can speak, while the called party is able to listen to it only.

The radio cannot make a broadcast group call unless the dealer authorizes it.

As these two types of group calls have the same operations in general, we will only detail their differences in the following section.

### 9.3.1 Initiating a Call

When the radio transmits a group call, the icon  will appear. You may transmit a group call through any of the following methods.

## Transmitting a call to the preset contact

In the home screen, pressing the **PTT** key will transmit a group call to the group call contact the **Group Call Selector** knob turns to.

### Group Contact

**Step 1** In the home screen, press the **Menu** key and then select the “Subgroup” menu, or directly press the **Subgroup** key to enter the “Subgroup” menu.

**Step 2** Go to “Subgroup -> Members”.

**Step 3** Use the **Up/Down** key to select the group call contact you want to call.



**Step 4** Press  or **PTT** key to make a group call.

You can also select the “General Group Call” as the “Call Type”, and then press the **OK** key,  key or the **PTT** key to make the call.

#### Note

To make a broadcast group call, select the “Broadcast Group Call” as the “Call Type”, and press the **OK** key,  key or the **PTT** key.

### ReDial or BackDial Call Log

**Step 1** In the home screen, press the  or  key to access the appropriate call log.

**Step 2** Use the **Up/Down** key to select the group call contact you want to call.

**Step 3** Press the  or **PTT** key to make a general group call.

You can also select the “General Group Call” as the “Call Type”, and press the **OK** key,  or the **PTT** key to make the call.

#### Note

To make a broadcast group call, select the “Broadcast Group Call” as the “Call Type”, and press the **OK** key,  key or the **PTT** key.

### Manual Dial

**Step 1** In the home screen, input a group call number using the keypad. See “Manual Dial” in “Functions and Operations” chapter for the range of group call number.

- General group call: group call number
- Broadcast group call: In both CPS-P and CPS-P3 dialing schemes, input \*11\*+ group call number.

**Step 2** Press the  key, **PTT** key or  key to make a call.

## 9.3.2 Receiving a Call

You can receive a group call without any operation and the radio will display the icon . Ring alert will be given as well.



### 9.3.3 Late Entry

After a group call is established, other group members are allowed to join it without any operation.

The late entry feature is used in the following situations:

- The called party is not in the group operation range until the group call is established.
- The called party is not powered on until the group call is established.
- During the initiation of the group call, the called party is in another call (a private call or a group call). When the call is over, the group call is still on.
- During the initiation of the group call, the called party is within poor signal coverage or is encountering with the radio interference, and the signal gets better during the group call.
- A new member joins when the group call is established.

### 9.3.4 Voice Communication

- General Group Call: After the call is established, either the calling party or the called party can transmit a voice call only if the **PTT** key is free with “PTT Enabled!” displayed on the LCD. The radio will display the icon  upon transmitting and the icon  upon receipt respectively.
- Broadcast Group Call: After the call is established, only the calling party can talk by holding the **PTT** key. When transmitting the voice, the calling party will display the icon  on the LCD. As for the called party, it can only receive voice.

### 9.3.5 Conversation Limit

When a general group call is established, both the calling party and the called party will display the call duration in a real-time way. See the following figure.

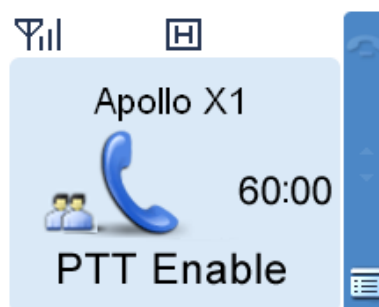

- At the calling party

The calling party will display the total conversation time for the call in a way of counting down the total allowed time. This time period is programmed by your dealer. The call will be ended when its duration exceeds the preset time.

- At the called party



The called party will display the actual conversation time. The timer will start counting once the called party joins the group call. If the called party takes the initiative to exit from this call and then rejoins it later, recount will be initiated.

### 9.3.6 Ending a call

#### General Group Call

The voice communication will be terminated when one of the following situations occurs:

- Neither of the parties holds the **PTT** key to talk within the preset time.
- The call duration exceeds the allowed time preset by the dealer.
- The calling party ends the in-progress call.
- Signal of base station is missing.
- A pre-emptive call or emergency call occupies the current channel.



#### Note:

If you hold the **PTT** key while some one is speaking, your radio will keep beeping, alerting you to transmission prohibition. To stop beeping, please release the **PTT** key. When the **PTT** is free, you can hold the **PTT** key to transmit.

#### Broadcast Group Call

The call will be terminated when one of the following situations occurs:

- The call duration exceeds the allowed time preset by the dealer.
- The calling party ends the in-progress call.
- Signal of base station is missing.
- A pre-emptive call or emergency call occupies the current channel.

### 9.4 One Touch Call

You dealer can set 5 One Touch Call shortcuts at most for you. This feature is used for calling the contact or sending the message quickly. The contact, call type and the message contents are all preset by the dealer.

**Operation:** To initiate a call or send a message, press the programmed **One Touch Call** key.

### 9.5 Emergency Call

In case of an emergency, you can use the feature to ask for help from your companion or control center. Emergency call is the highest-priority call which can disconnect any ongoing normal calls.

Only when the radio is authorized to emergency call, can it transmit such calls.

## 9.5.1 Initiating a Call

When the radio transmits an emergency call, the icon  will appear. You may transmit an emergency call through any of the following methods.

### Shortcuts



Press the programmed **Emergency On** key to transmit an emergency call to the called party configured by the dealer.

### Man Down Trigger

Man Down alarm will trigger an emergency call to the called party set by the dealer.

### Manual Dial



**Step 1** In the home screen, input “\*9\* + the number you want to call (e.g.: \*9\*80020200)” using the keypad.

**Step 2** Press the  key, **PTT** key or  key to transmit an emergency call.

## 9.5.2 Receiving a Call

When an emergency call arrives, you can answer it without any operation.

## 9.5.3 Voice Communication

After an emergency call is established, either the calling party or the called party can speak only if the **PTT** key is free with “PTT Enabled!” displayed on the LCD. The radio will display the icon  during transmission and the icon  upon receipt respectively.

## 9.5.4 Ending a call

The emergency call will be terminated when one of the following situations occurs:

- The call duration exceeds the allowed time preset by the dealer.
- When the emergency call is made to the group contact, the calling party ends the call or exits the Emergency mode.
- Signal of base station is missing.
- When the emergency call is made to the private call contact, both parties end the call or exit the Emergency mode.



**Note:** Both calling party and the called party adopt different method to exit the Emergency mode.

- Calling Party: presses the **Emergency Off** key.
- Called Party: presses the **TK** key within 1s after pressing the **Back** key.

## 9.6 Queue Call

When the channels are busy, the calls will queue according to their priorities for the system's distribution of channels. When the radio makes a call with a low priority, it will display the prompt “Queue Call” on the

LCD.

## 9.7 Time-out Timer (TOT)

The purpose of TOT is to prevent any user from occupying a channel for an extended period. If the preset time expires, the radio will automatically terminate the transmission and keep beeping. To stop beeping, please release the **PTT** key. You must wait for a certain time period (preset by your dealer) to initiate another transmission.

# 10. Functions and Operations

## 10.1 Home Screen

The feature allows you to quickly return to the previous menu or the home screen.

In the editing screen, press the  key, and the radio exits the screen and returns to the previous menu immediately; in other screens, press this key and the radio returns to the home screen immediately.

## 10.2 Managing the Contacts

You can manage your private call contacts via the menu “Contact” in the radio.

### 10.2.1 Contact List

You can save up to 200 entries of private call contact information in the list. To access the list, select “Contact -> Contact List” or press the shortcut key for Private Call Contact.

#### Viewing a Contact

You can view the alias and number of the contacts.

#### Editing a Contact

You can edit the number and alias of the contacts.

#### Deleting a Contact

You can delete a contact from the contact list. Please note that the list must contain one contact at least.

### 10.2.2 New Contact

You can add a new contact to the contact list. The number and alias of each contact must be unique. The alias can contain 16 characters at most. For the number range, please refer to “Manual Dial” in this chapter.





#### Note:

- You can press the  key to switch the input method when editing the alias.
- You can save the numbers from the Call Logs, ReDial List and BackDial List into the contact list.

## 10.3 Manual Dial

You can input the private or group contact ID manually using the keypad to make a call .

In the home screen, input your desired ID, and press the , **PTT**, or  key to make a call.

### 10.3.1 CPS-P dialing rule

#### Number

A contact number is composed of 3 parts: NP (3 digits) + FN (2 digits) + UN/GN (3 digits), totally 8 digits.

- NP (the number prefix) range: 328–899
- FN (the fleet number) range: 20–65 (for private call), 20–99 (for group call)
- UN (the unit number, for private call) range: 200–899; GN (the group number, for group call) range: 900–999

### Dialing rules

- In-fleet call: to directly dial UN/GN (3 digits) only.
- Inter-fleet call: to dial the FN (2 digits) + UN/GN (3 digits).
- Inter-prefix call: to dial the NP (3 digits) + FN (2 digits) + UN/GN (3 digits).

## 10.3.2 CPS-P3 dialing rule

### Number

A contact number is composed of 3 parts: NP (3 digits) + FN (2 digits) + UN/GN (3 digits), totally 8 digits.

- NP (the number prefix) range: 328 – 899
- FN (the fleet number) range: 20 – 89 (for both private call and fleet group call); 90, 97, 98, 99 (for hierarchical group call).
- UN (the unit number)/GN (the group number) range
  - For private call: When FN ranges from 20 to 41, UN will range from 200 to 899; when FN ranges from 42 to 89, UN will range from 200 to 549.
  - For fleet group call, GN range is 900 – 999; for hierarchical group call, GN range is 000 – 999.

### Dialing rules

- In-fleet call: to directly dial UN/GN (3 digits) only.
- Inter-fleet call: to dial the FN (2 digits) + UN/GN (3 digits).
- Inter-prefix call: to dial the NP (3 digits) + FN (2 digits) + UN/GN (3 digits).

## 10.3.3 1343-E dialing rule

This feature allows you to customize the dialing rules. You can request your dealer to customize the dialing rule according to your actual needs. Please note that the user should follow the same scheme in the same trunking system and each contact number is unique.

To learn more details regarding this dialing rule, please contact your local dealer.

## 10.4 Message

### Sending a message

**Step 1** Go to “Menu -> Message -> New Message” to enter the relevant interface .

**Step 2** Type the text and press the **OK** key.

**Step 3** Select the contact or input the contact number manually.

**Step 4** Press the **OK** key to send the message. When the message is sent successfully, the radio will display “Send Success!” on the LCD.

You can send the Quick Text or Status Message or forward the message saved in the InBox, OutBox or Drafts. See the detailed introductions of the submenus of Message respectively.

### **New Message**

You can create a new text message (23 characters at most) and save it to Drafts, or send it to a private call contact or a group call contact.

### **Quick Text**





Under this option there are some text messages (10 entries at most) preset by your dealer. You can choose to edit and send any entry.

### **Status Message**

Status Message contains the status code rather than the text, to ensure privacy of your communication. It is preset by your dealer via the programming software. You can send but not edit the message.

### **InBox**

The radio saves the received messages into the InBox and gives every message a corresponding icon to show whether it is read.





-  : Read message
-  : Unread message
-  : Read status message
-  : Unread status message

The InBox can save up to 50 received messages. When it is full, the icon  will appear, and the earliest message will be overwritten by the latest one automatically.

- For each message, you can choose to perform any of these operations: Reply, Forward (Status Message excluded), View Details and Delete.
- To delete all messages in the InBox, select “Message -> Inbox -> Delete All”.

### **OutBox**

The OutBox can save up to 50 sent messages. The following icons will appear to indicate whether the message is sent successfully.

-  : Message is sent successfully.
-  : The message is not sent successfully. In this case, you can resend it.
-  : Status Message is sent successfully.
-  : Status Message is not sent successfully. In this case, you can resend it.

When the OutBox is full, no icon will appear on LCD to alert you. In addition, the earliest message will

be overwritten by the latest one automatically.

- For each message, you can choose to perform any of these operations: Resend, Forward (Status Message excluded), View Details and Delete.
- To delete all messages in the OutBox, select “Message -> Outbox -> Delete All”.

## Drafts

The Drafts can save up to 20 draft messages. When the Drafts is full, the earliest message will be overwritten by the latest one automatically.

For each message, you can choose to perform any of these operations: Send, Save and Delete.

- After the message in the Drafts is sent, it will be removed from the Drafts and be saved to the Outbox.
- To delete all messages in the Drafts, select “Message -> Drafts -> Delete All”.

## 10.5 Call Logs

The radio saves only the entries of private calls, PSTN calls and PABX calls but not group calls.

At most 10 call entries can be saved in the Outgoing/Incoming/Missed list respectively. When the Outgoing/Incoming/Missed list is full, the earliest entry will be overwritten by latest one automatically.

The Missed list includes the missed FOACSU calls and OACSU calls.

**Operation:** You can press the **Menu** key to enter “Menu -> Call Logs” menu, or enter the “Call Logs” menu directly via the programmed **Call Log** key.

After accessing a list and selecting an entry, you can perform any of these operations: hold the **PTT** key to initiate a call, add the entry to Contact List or delete it. To delete all entries in the Outgoing/Incoming/Missed list at a time, select “Call Logs -> Outgoing/Incoming/Missed -> Delete All”.

## 10.6 MIC AGC

This feature can be enabled by your dealer via the programming software. When it is enabled, the product will control the audio gain to a proper range during transmission, providing improved voice with proper volume for the receiving radio.

## 10.7 VOX

VOX indicates that the voice transmission can be initiated by speaking into the microphone of radio instead of holding the **PTT** key. When the microphone detects that your voice reaches the required volume to trigger the transmission, the transmission is started automatically.

When VOX is enabled, the icon  will appear on the LCD.

### To enable or disable the VOX feature

Press the programmed **VOX** key.

Select “Menu -> Settings -> Radio Set -> VOX” menu.

## Adjust VOX Gain Level

You can adjust the sensitivity of microphone transmission via the “Menu -> Settings -> Radio Set -> VOX -> Gain Level” menu. The bigger the gain level, the higher the gain and the lower the sensitivity. Thus, the high volume is required to trigger the transmission.

- Internal VOX Gain Level: the sensitivity of internal microphone transmission.
- External VOX Gain Level: the sensitivity of external microphone transmission.



**Caution:** Please adjust the VOX Gain Level properly on your actual requirements.

## 10.8 LQO

This feature enables the radio to adjust the received voice volume automatically in standby mode to fit different using environments, as well as making the heard voice clear.

**Operation:** You can enable or disable the LQO feature by pressing the programmed **LQO** key or via the “Settings -> Radio Set -> LQO” menu.

## 10.9 Hunt

There are two types of hunt in different stages: the TSCC hunt during registration and the hunt for smooth communications after registration.

### 10.9.1 TSCC Hunt

In trunking system, the radio is required to register with a base station prior to normal operation. Before registering, the radio will hunt through the control channels for available base stations. During hunting, the LCD displays “Registering, Please Wait!” and the icon , and the LED flashes orange slowly.

There are two hunt plans: Fixed Control Channel and Flexible Control Channel. You can set the appropriate plan via your dealer.

#### Fixed Control Channel

There are certain rules to define the frequency distribution of the Fixed Control Channel together. If the trunking user frequency has such characteristic, you can configure the frequency for the radios together via the Fixed TSCC, and adopt the Fixed Control Channel plan.

If you adopt this plan, you can select the hunt mode by going to “Hunt -> TSCC Hunt” menu or pressing the programmed **Hunt Mode** key to access “Hunt” menu quickly.

See the hunt modes as follows:

- Short Hunt

In this mode, the radio will hunt for the last 10 control channels on which it registered successfully. If the radio fails to register on all the 10 channels, it will orderly hunt the channels in the Fixed TSCC



List preset by the dealer. The hunt process would recycle until the radio registers with a base station successfully.

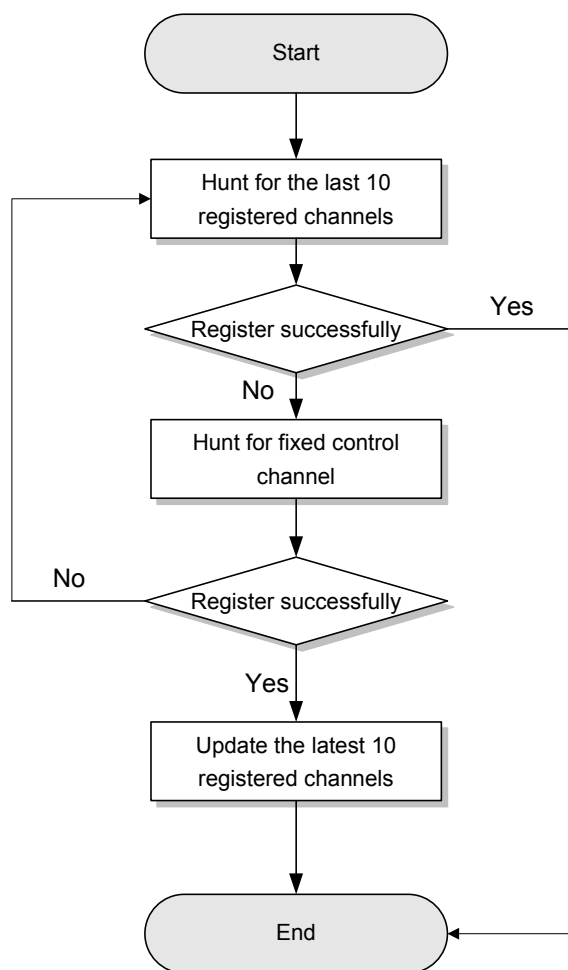

- Comprehensive Hunt

If Short Hunt brings no successful registration, Comprehensive Hunt will go from the channel defined at Lowest of Comprehensive Hunt. During the hunt, after every 100 channels are hunted, the previously mentioned 10 channels would be hunted again. If no successful registration is achieved after comprehensive hunt, the hunt will go on with the Fixed TSCC List. The hunt process would recycle until the radio registers with a base station successfully.

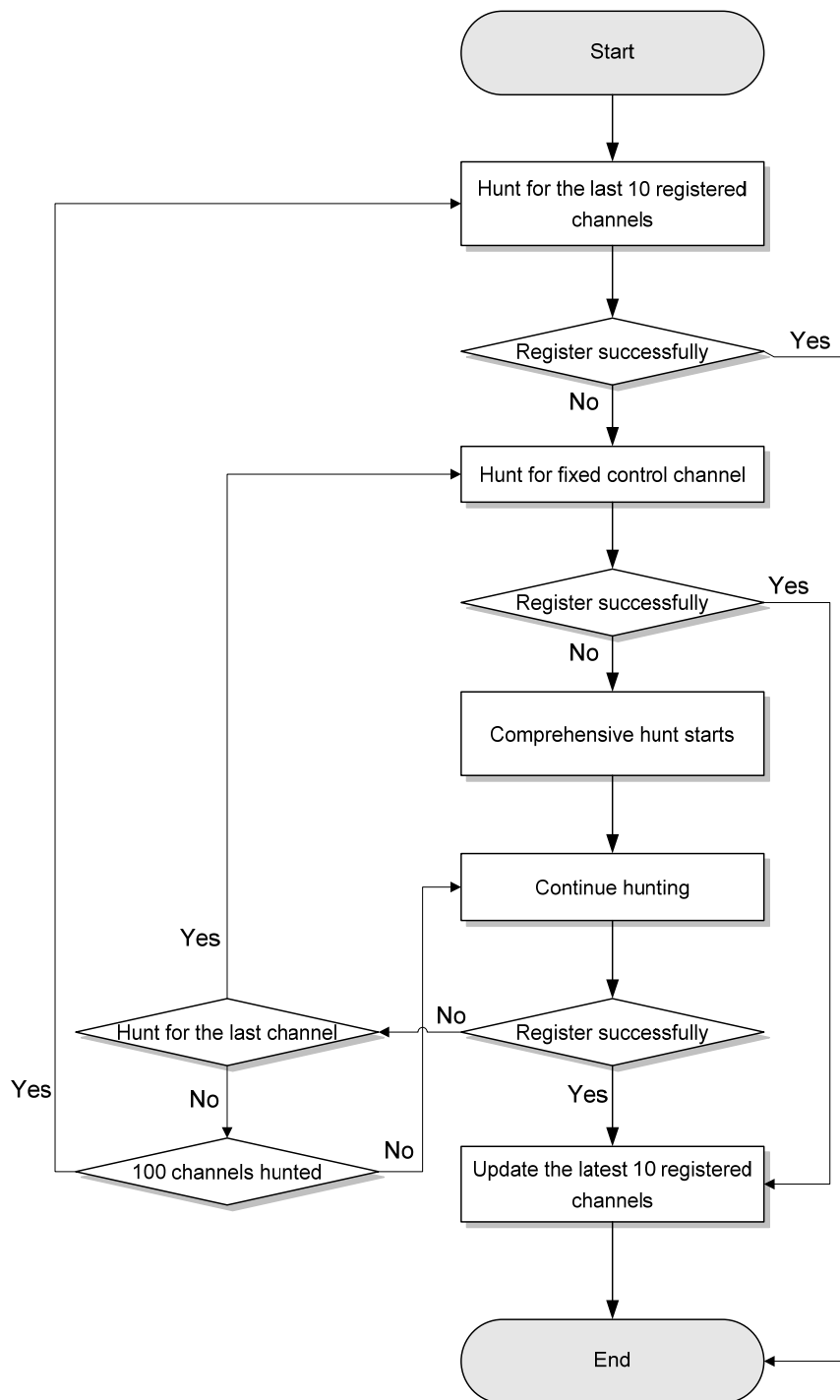

- Team Hunt

The radio will hunt for the last 10 control channels on which it has worked. If the radio fails to register on all the 10 channels, the team hunt will start with the Fixed TSCC List preset by the dealer. The hunt process would recycle until the radio registers with a base station successfully.

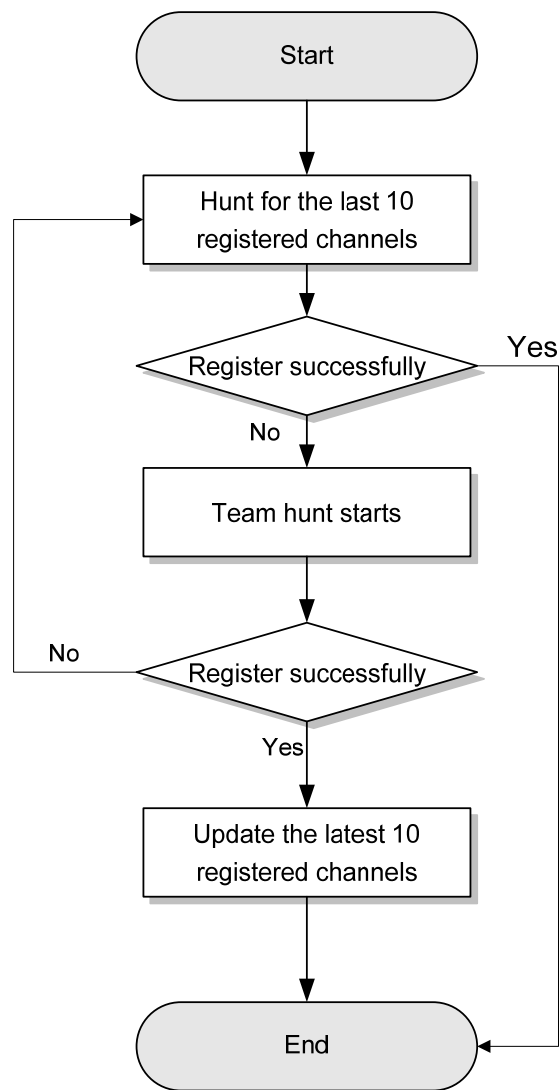

## Flexible Control Channel

There are certain rules to configure the frequency distribution of the Fixed Control Channel together. However, in practice, some trunking users do not have unified or orderly frequency plans, so Fixed Control Channel is unable to unify the frequency configuration. You can use Flexible TSCC for the frequency configuration and adopt the Flexible Control Channel plan.

The hunt process of Flexible Control Channel is similar to Short Hunt (see “Short Hunt”), and it only differs in that the hunted object is Flexible Control Channel rather than Fixed Control Channel.

### 10.9.2 Hunt for Smooth Communications

The system provides multiple hunt policies for the registered radios to ensure normal communications.

You can select your desired hunt method by accessing the “Hunt” menu from the “Menu” or via the programmed **Hunt Mode** key quickly.

You can also enable or disable your desired hunt quickly via the programmable key assigned with the corresponding hunt feature, such as the Background Hunt feature.

## Background Hunt

The idle radio will check the signal strength of the base station with which it registers. If the signal strength of the base station is below the value defined at Threshold Level, the radio will automatically hunt for another one with better signal and registers with it. Thus, the radio can always work with a base station with strong signal.

## HomeStation Hunt

The feature offers the radio the priority to register with a frequently used base station. This can balance the base station load well, especially in the area covered by multiple base stations, increasing system response speed and improving communication quality.

Each base station has a limited load. When the number of the radios registered with a base station reaches the upper limit, the system response will be delayed, resulting in intermittent communications. However, a radio works in a fixed area most of the time. Even though it works on the channel of another base station in the area covered by multiple base stations, it will jump to work on its home channel once the signal strength of the channel matches the defined value. The communications will not be affected at all during base station switch.

## Handover

The change in radio position may cause the signal strength received from base station to fluctuate, and the communication quality is affected accordingly. In case of weak signal strength, this feature enables the radio to work with another base station having better signals automatically, assuring quality communications.

## 10.10 Encrypt

Encrypt indicates the voices transmitted are encrypted between radios. For example, Radio A transmits the encrypted voice to Radio B, and Radio B should enable Encrypt feature to receive the voice.

**Operation:** You can enable/disable the Encrypt feature via the programmed **Encrypt** key or by entering the menu "Menu -> Settings -> Radio Set -> Encrypt".

## 10.11 Authentication

Authentication is used to ensure the validity of the user accounts in the network. It operates in a way that the radio and the base station authenticate the validity of each other. Currently, the authentication is only needed during registration. Only when both the radio and the base station pass the authentication can the registration be made.

**Operation:** You can enable/disable the feature via the "Menu -> Settings -> Radio Set -> Authentication" menu.

## 10.12 Covert Mode

When this feature is enabled, the radio will close any visible indications on it, such as the LED, Vibration, etc, which are set by your dealer. This feature is mainly used in special missions.

**Operation:** To enable or disable the Covert mode, you can press the programmed **Covert Mode** key, or enter the menu “Menu -> Settings -> Radio Set -> Covert Mode”.

## 10.13 Man Down (optional)

Your radio will sound a pre-alert tone if it is positioned aslant for a preset time period, and will enter the Emergency mode if you do not place it vertically within such time period. To exit the Emergency mode, please place it upright.

You can enable or disable the Man Down feature by pressing the programmed **Man Down** key or via the menu “Menu -> Settings -> Radio Set -> Man Down”.

The radio gives a high-pitched tone when the Man Down feature is enabled and a low-pitched tone when the feature is disabled.

## 10.14 Rent

You can rent the radio from your dealer. . When the rental period expires, you are not allowed to use this radio.

You can check the remaining rental time via the menu “Menu -> Settings -> Radio Set -> Rent -> Rent Query”.

If the Rent Pre-Alert feature is enabled, the radio will give a tone periodically to remind you of the remaining time on your rental.

## 10.15 Priority

This feature indicates the priority of the normal voice services. When there is no free service channel in the system, the system will respond to the higher-priority voice service first.

The normal voice services include all calls, such as private call, general group call, broadcast group call, PSTN call, PABX call, etc, except emergent call.

You can set the priority of your normal voice services via the menu “Menu -> Settings -> Radio Set -> Priority”.

- The priority follows this principle: Low < Medium < High. When the channels are occupied, the calls will queue according to their priorities for the system's distribution of channels. When the queue is full, the higher-priority calls can jump the queue, and, accordingly, the lower-priority calls will be extruded out (the system will prompt that it is busy). In addition, the emergency calls or preemption calls can forcibly disconnect the on-going lower-priority calls to release the channels for themselves.

- Preemption: This is the highest priority. When the system is busy, such calls do not need to queue. They can disconnect other on-going calls with lower priority to release the channels for themselves.

 **Note:** The “Preemption” option will not be available in your radio unless your dealer enables it.

## 10.16 Radio Set

You can optimize your radio performance via the following configuration according to actual needs and your preferences.

Enter “Menu -> Settings -> Radio Set” menu to set the items as introduced below:

### Power Level

This menu is to set the Tx power level to High or Low. High power can extend the coverage, enabling you to communicate with farther radios.

Alternatively, you can toggle the power level by pressing the programmed **Adjust Power Level** key in the home screen.

On the LCD, High power is indicated by  and Low power is indicated by .

### Language

This option allows you to set the language in which all interface information is displayed. Currently, this radio only supports English and Simplified Chinese.

### Backlight

This menu allows you to set the backlight. Activating the backlight can illuminate the LCD and the keypad, so as to facilitate your operation under dim light conditions. The menu has the following options:

- Off: The backlight will always remain off.
- On: The backlight is on all the time.
- Timed: If no operation or signal transmission/receipt occurs within the time preset by the dealer, the backlight will be turned off automatically.

### Brightness

This option allows you to set the display brightness. You can raise or lower it using the **Up/Down** key.

### Keypad Lock

This option allows you to set whether to enable this function. When "Enable" is selected, you can use the **Up/Down** key to set the time range after which the keypad will be locked. Available range: 5 – 60 seconds.

### LED Indicator

This option allows you to set whether to enable LED indicator. Generally, the LED indicator can indicate Tx/Rx, Hunt status, Incoming Call, etc. The indications of the LED are set by the dealer.

## Tone

You can select the tones on actual requirements.

Tone	Description
Radio Silent	This feature disables all the tones.
Talk Permit	The tone given upon successful signal transmission to prompt the user to talk.
Private Call	The tone given when the radio receives a private call successfully.
TxtMsg	The tone given when the radio receives a message.
Keypad	The tone given when you are operating the keypad.
Low Battery	The tone given when the radio is in low battery status. Then you will need to replace the battery.
Call End Tone	The tone given upon a call ending.
Group Call Tone	The tone given upon the receipt of a group call.
Incoming Call Tone	The tone given upon the receipt of a FOACSU call.
PTT Enable	The tone given when the PTT is enabled to transmit the voice.
Hunt Tone	The tone given when the radio starts the control channel hunt.
Group Notify	The group number played when you are selecting the group call contacts by the <b>Group Call Selector</b> knob.
Call Queued	The tone given when the radio is in the call queue, with the prompt "Queue Call" displayed on the LCD.

## 10.17 Mode

This feature allows you to select the work mode for the radio. Be prudent about this operation, as the change of mode will cause your radio to reboot.

**Operation:** Press the programmed **Operation Mode Switch** key to switch the mode directly.

You can also press the programmed **Operation Mode** key to enter "Mode" menu or go to "Menu -> Mode" for switching.

## 10.18 GPS

When GPS feature is enabled, you can check the position information of the radio and choose the time

zone for it. Go to “Menu -> Accessories -> GPS”.

## 10.19 Device Info





With this option, you can view basic information of your radio, including radio ID, serial number, model name, frequency range, firmware version, radio data version, boot loader version, etc.

Go to “Menu -> Settings -> Device Info”.

## 10.20 Battery Power Indicator

This feature allows you to know the current battery power.

Hold down the programmed **Battery Power Indicator** key, and the radio will give a specific indication to represent the current battery power. Release this key to exit.

Indication	Battery Power Icon	Battery Power
The LED glows green.		High
The LED glows orange.		Medium
The LED glows red.		Low
The LED glows red and the low battery tone sounds.		Insufficient



# 11. Troubleshooting

Phenomena	Analysis	Solution
Power-on failure	The battery may be improperly installed.	Remove the battery and attach it again.
	The battery may run out.	Recharge or replace the battery.
	The battery may suffer from poor contact caused by dirtied or damaged battery contacts.	Clean the battery contacts. If the problem can not be solved, contact your dealer or authorized service center for inspection and repair.
The radio cannot register successfully.	The radio may not detect signals from the base station.	Make sure you are within the coverage of the base station.
	The radio maybe not be authorized.	Contact the base station manager to check whether your radio is authorized in the network management system.
The radio registers repeatedly.	The signal is discontinuous.	Make sure you are within the coverage of the base station.
The radio cannot establish a call.	The signal is poor.	Make sure you are within the coverage of the base station.
No voice is heard after a call is established.	Your ID may be repeated.	Contact the base station manager to check whether your ID is repeated in the network management system.
The called party disconnects repeatedly during communication.	The signal is discontinuous.	Make sure you are within the coverage of the base station.
During receiving, the voice is weak, discontinuous or totally inactive.	Low battery	Recharge or replace the battery.
	The volume may be set to a low level.	Increase the volume by rotating the <b>Volume Control</b> knob clockwise, or ask your dealer to disable the Digital Mic AGC feature.
	The antenna may get loose or improperly installed.	Power off the radio, re-install the antenna and power on the radio again.

Phenomena	Analysis	Solution
	The speaker may be blocked or damaged.	Clean surface of the speaker. If the problem can not be solved, contact your dealer or our authorized service center for inspection and repair.
You can not communicate with other members.	The signal is poor.	Make sure you are within the communication range.
The voice is unclear.	The signal is poor.	Make sure you are within the communication range.
The noise is too loud.	The signal is poor.	Make sure you are within the communication range.
	You may be at an unfavorable position. For example, your communication may be blocked by high buildings or frustrated in the underground areas.	Move to an open and flat area, and restart the radio.
	You may suffer from external disturbance (such as electromagnetic interference).	Stay away from equipment that may cause interference.
You can not use the keys.	The keypad may fail to function temporarily.	Restart the radio.
The LCD does not display any information.	The LCD may fail to function temporarily.	Restart the radio.

If the above solutions can not fix the problems for you, or you may have some other queries, please contact us or your local dealer for more technical support.

## 12. Care and Cleaning

To guarantee optimal performance as well as a long service life of the product, please follow the tips below.

### Product Care

- Do not pierce or scrape the product.
- Keep the product far away from substances that can corrode the circuit.
- Do not hold the product by its antenna or earpiece cable directly.
- Attach the accessory jack cover when the product is not in use.

### Product Cleaning

 **Caution:** Power off and remove the battery before cleaning. Clean up the dust and fine particles on the product surface and charging piece with a clean and dry lint-free cloth or a brush regularly.

- Use neutral cleanser and a non-woven fabric to clean the keys, control knobs and front case after long-time use. Do not use chemical preparations such as stain removers, alcohol, sprays or oil preparations, so as to avoid surface case damage.
- Make sure the product is completely dry before use.

# 13. Appendix

## 13.1 Input Method

You can enter aliases, numbers or messages using the keypad. The radio supports these input methods: Chinese Pinyin (simplified), English and Number.

### Chinese Pinyin (Simplified)

**Step 1** Press  to switch to Chinese Pinyin mode.

**Step 2** Enter the pinyin through alphanumeric keys; then a list of possible combinations and corresponding characters will appear.

**Step 3** Use the **Up/Down** key to choose the right pinyin.

**Step 4** Press the **OK** key to highlight the characters, and choose the right character using the **Up/Down** key.

**Step 5** Press the **OK** key to enter the selected character.

You can repeat the above steps to continue.

### English

**Step 1** Press  to switch to uppercase English or lowercase English mode.

**Step 2** Press the key which bear your desired letter repeatedly until the letter appears.

You can repeat the above steps to continue.

### Number

**Step 1** Press  to switch to Number mode.

**Step 2** Enter the numbers through alphanumeric keys  to .

### Special Character

To enter common punctuations and special characters, press .

To input a space, press .

 **Note:** You can use the **Up/Down** key to move the cursor leftward/rightward in the entered text.

## **FCC Statement**

Operation is subject to the following two conditions: 1. This device may not cause harmful interference, and 2. This device must accept any interference received, including interference that may cause undesired operation.

Note:” Changes or modifications to this unit not expressly approved by the party responsible for compliance could void the user’s authority to operate the equipment.”

## **Compliance with RF Exposure Standards**

Hytera’s TETRA Terminal complies with the following RF energy exposure standards and guidelines:

- United States Federal Communications Commission, Code of Federal Regulations; 47 CFR § 1.1307, 1.1310 and 2.1093
- American National Standards Institute (ANSI) / Institute of Electrical and Electronic Engineers (IEEE) C95. 1:2005; Canada RSS102 Issue 5 March 2015.
- Institute of Electrical and Electronic Engineers (IEEE) C95.1:2005 Edition

## **RF Exposure Compliance and Control Guidelines and Operating Instructions**

To control your exposure and ensure compliance with the occupational/controlled environment exposure limits always adhere to the following procedures.

Guidelines:

- Do not remove the RF Exposure Label from the device.
- User awareness instructions should accompany device when transferred to other users.
- Do not use this device if the operational requirements described herein are not met.

Operating Instructions:

- Transmit no more than the rated duty factor of 50% of the time. To transmit (talk), push the Push-To-Talk (PTT) button. To receive calls, release the PTT button. Transmitting 50 % of the time, or less, is important because this radio generates measurable RF energy exposure only when transmitting (in terms of measuring for standards compliance).
- Hold the radio in a vertical position in front of face with the microphone (and the other parts of the radio, including the antenna) at least one inch (2.5 cm) away from the nose. Keeping the radio at the proper distance is important because RF exposures decrease with distance from the antenna. Antenna should be kept away from eyes.
- When worn on the body, always place the radio in a Hytera’s approved clip, holder, holster, case, or body harness for this product. Using approved body-worn accessories is important because the use of Hytera’s or other manufacturer’s non-approved accessories may result in exposure levels, which exceed the FCC’s occupational/controlled environment RF exposure limits.

- If you are not using a body-worn accessory and are not using the radio in the intended use position in front of the face, then ensure the antenna and the radio are kept at least 2.2 cm (one inch) from the body when transmitting. Keeping the radio at the proper distance is important because RF exposures decrease with increasing distance from the antenna.
- Use only manufacturer's name approved supplied or replacement antennas, batteries, and accessories. Use of non-manufacturer-name approved antennas, batteries, and accessories may exceed the FCC RF exposure guidelines.
- For a list of Hytera's approved accessories (see the user manual), or (visit the following website which lists approved accessories: [http: add website address](http://add website address)), or (The manufacturer should include the appropriate bracketed item{s} in the manual.)
- For a list of Hytera's approved accessories (see the user manual), or (visit the following website which lists approved accessories: [www.hytera.cn](http://www.hytera.cn))

### **IC statement**

The device has been tested and compliance with SAR limits, users can obtain Canadian information on RF exposure and compliance

Après examen de ce matériel aux conformité aux limites DAS et/ou aux limites d'intensité de champ RF, les utilisateurs peuvent sur l'exposition aux radiofréquences et la conformité and compliance d'acquérir les informations correspondantes

This device complies with Industry Canada licence-exempt RSS standard(s). Operation is subject to the following two conditions:

- (1) this device may not cause interference, and
- (2) this device must accept any interference, including interference that may cause undesired operation of the device.

*Le présent appareil est conforme aux CNR d'Industrie Canada applicables aux appareils radio exempts de licence. L'exploitation est autorisée aux deux conditions suivantes : (1) l'appareil ne doit pas produire de brouillage, et (2) l'utilisateur de l'appareil doit accepter tout brouillage radioélectrique subi, même si le brouillage est susceptible d'en compromettre le fonctionnement*