



# TEST REPORT

**Report Reference No.** ..... : **TRE1706008201** R/C.....: 91248

**FCC ID** ..... : **YAMMD61XU1**

**Applicant's name** ..... : **Hytera Communications Corporation Limited**

**Address**..... : Hytera Tower, Hi-Tech Industrial Park North, 9108# Beihuan Road, Nanshan District, Shenzhen, People's Republic of China

**Manufacturer**.....: Hytera Communications Corporation Limited

**Address**.....: Hytera Tower, Hi-Tech Industrial Park North, 9108# Beihuan Road, Nanshan District, Shenzhen, People's Republic of China

**Test item description**..... : **Digital Mobile Radio**

**Trade Mark**..... : Hytera

**Model/Type reference** ..... : MD615 U(1)

**Listed Model(s)** ..... : MD612 U(1),MD616 U(1),MD618 U(1)

**Standard** ..... : **FCC Part 90/FCC Part 2**

**Date of receipt of test sample**.....: June 12, 2017

**Date of testing**.....: June 13, 2017 – July 17, 2017

**Date of issue**.....: July 17, 2017

**Result** .....: **PASS**

Compiled by  
( position+printed name+signature) . : File administrators Shayne Zhu 

---

Supervised by  
( position+printed name+signature) . : Project Engineer Cary Luo 

---

Approved by  
( position+printed name+signature) . : RF Manager Hans Hu 

**Testing Laboratory Name** ..... : **Shenzhen Huatongwei International Inspection Co., Ltd.**

**Address**..... : 1/F, Bldg 3, Hongfa Hi-tech Industrial Park, Genyu Road, Tianliao, Gongming, Shenzhen, China

**Shenzhen Huatongwei International Inspection Co., Ltd. All rights reserved.**

This publication may be reproduced in whole or in part for non-commercial purposes as long as the Shenzhen Huatongwei International Inspection Co., Ltd. is acknowledged as copyright owner and source of the material. Shenzhen Huatongwei International Inspection Co., Ltd. takes no responsibility for and will not assume liability for damages resulting from the reader's interpretation of the reproduced material due to its placement and context.

*The test report merely corresponds to the test sample.  
It is not permitted to copy extracts of these test result without the written permission of the test laboratory.*

## Contents

<b>1.</b>	<b><u>TEST STANDARDS AND REPORT VERSION</u></b>	<b>3</b>
1.1.	Test Standards	3
1.2.	Report version	3
<b>2.</b>	<b><u>TEST DESCRIPTION</u></b>	<b>4</b>
<b>3.</b>	<b><u>SUMMARY</u></b>	<b>5</b>
3.1.	Client Information	5
3.2.	Product Description	5
3.3.	Test frequency list	6
3.4.	EUT operation mode	6
3.5.	EUT configuration	6
<b>4.</b>	<b><u>TEST ENVIRONMENT</u></b>	<b>7</b>
4.1.	Address of the test laboratory	7
4.2.	Test Facility	7
4.3.	Environmental conditions	8
4.4.	Statement of the measurement uncertainty	8
4.5.	Equipments Used during the Test	9
<b>5.</b>	<b><u>TEST CONDITIONS AND RESULTS</u></b>	<b>11</b>
5.1.	Maximum Transmitter Power	11
5.2.	Occupied Bandwidth	13
5.3.	Emission Mask	16
5.4.	Modulation Limit	18
5.5.	Audio Frequency Response	20
5.6.	Frequency Stability Test	22
5.7.	Transmitter Frequency Behaviour	25
5.8.	Spurious Emission on Antenna Port	29
5.9.	Transmitter Radiated Spurious Emission	31
5.10.	Conducted Emissions	39
5.11.	Radiated Emission	40
<b>6.</b>	<b><u>TEST SETUP PHOTOS OF THE EUT</u></b>	<b>43</b>
<b>7.</b>	<b><u>EXTERNAL AND INTERNAL PHOTOS OF THE EUT</u></b>	<b>45</b>

## 1. TEST STANDARDS AND REPORT VERSION

### 1.1. Test Standards

The tests were performed according to following standards:

[FCC Rules Part 90](#) Private land mobile radio services.

[TIA/EIA 603 D: June 2010](#) Land Mobile FM or PM Communications Equipment Measurement and Performance Standards.

[FCC Part 15 Subpart B](#) Unintentional Radiators

[FCC Part 2](#) Frequency allocations and radio treaty matters, general rules and regulations.

[KDB579009 D03 v01](#): Applications Part 90 Refarming Bands.

[KDB971168 D01 v02r02](#): MEASUREMENT GUIDANCE FOR CERTIFICATION OF LICENSED DIGITAL TRANSMITTERS

### 1.2. Report version

Version No.	Date of issue	Description
00	July 17, 2017	Original

## 2. Test Description

<b>Transmitter Requirement</b>			
Test item	Standards requirement	Result	
		Pass	N/A
Maximum Transmitter Power	FCC Part 90.205, FCC Part 2.1046	<input checked="" type="checkbox"/>	
Modulation Characteristic	FCC Part 90.207, FCC Part 2.1047	<input checked="" type="checkbox"/>	
Occupied Bandwidth	FCC Part 90.209, FCC Part 90.210, FCC Part 2.1049	<input checked="" type="checkbox"/>	
Emission Mask	FCC Part 90.209, FCC Part 90.210, FCC Part 2.1049	<input checked="" type="checkbox"/>	
Frequency Stability	FCC Part 90.213, FCC Part 2.1055	<input checked="" type="checkbox"/>	
Transmitter Frequency Behavior	FCC Part 90.214	<input checked="" type="checkbox"/>	
Transmitter Radiated Spurious Emission	FCC Part 90.210, FCC Part 2.1053	<input checked="" type="checkbox"/>	
Spurious Emission On Antenna Port	FCC Part 90.210, FCC Part 2.1051	<input checked="" type="checkbox"/>	
<b>Receiver Requirement</b>			
Test item	Standards requirement	Result	
		Pass	N/A
Conducted Emission	FCC Part 15.107		<input checked="" type="checkbox"/>
Radiated Emission	FCC Part 15.109	<input checked="" type="checkbox"/>	

### 3. SUMMARY

#### 3.1. Client Information

Applicant:	Hytera Communications Corporation Limited
Address:	Hytera Tower, Hi-Tech Industrial Park North, 9108# Beihuan Road, Nanshan District, Shenzhen, People's Republic of China
Manufacturer:	Hytera Communications Corporation Limited
Address:	Hytera Tower, Hi-Tech Industrial Park North, 9108# Beihuan Road, Nanshan District, Shenzhen, People's Republic of China

#### 3.2. Product Description

Name of EUT:	Digital Mobile Radio	
Trade mark:	Hytera	
Model/Type reference:	MD615 U(1)	
Listed mode(s):	MD612 U(1),MD616 U(1),MD618 U(1)	
Power supply:	DC 13.6V	
Battery information:	-	
Charger information:	-	
Adapter information:	-	
Operation Frequency Range:	From 400MHz to 470MHz	
Rated Output Power:	High Power: 45W (46.53dBm)/Low Power: 5W (36.99dBm)	
Modulation Type:	Analog Voice:	FM
	Digital Voice/Digital Data:	4FSK
Digital Type:	DMR	
Channel Separation:	Analog Voice:	<input checked="" type="checkbox"/> 12.5kHz
	Digital Voice /Digital Data:	<input checked="" type="checkbox"/> 12.5kHz <input type="checkbox"/> 6.25kHz
Emission Designator:	Analog Voice:	<input checked="" type="checkbox"/> 12.5kHz Channel Separation: 5K24F3E
	Digital Voice& Data:	<input checked="" type="checkbox"/> 12.5kHz Channel Separation: 7K19FXW <input type="checkbox"/> 6.25kHz Channel Separation: ---
	Digital Data:	<input checked="" type="checkbox"/> 12.5kHz Channel Separation: 7K19FXD <input type="checkbox"/> 6.25kHz Channel Separation: ---
Support data rate:	9.6kbps	
Antenna Type:	External	
Maximum Transmitter Power:	Digital	47.86W for 12.5kHz Channel Separation
	Analog	46.88W for 12.5kHz Channel Separation

Note:

- 1)The product has the same digital working characters when operating in both two digitized voice/data mode. So only one set of test results for digital modulation modes are provided in this test report.
- 2)This equipment is capable of supporting a minimum data rate of 4800 bits per second per 6.25 kHz of channel bandwidth. DMR interphone's bandwidth is 12.5 kHz, and it has a double time slot, one is the speech time slot, one is the data time slot, just language sequence is satisfied with 4800 bps/6.25 kHz BW.

### 3.3. Test frequency list

Mode	Modulation	Operation Frequency Range	Test Frequency (MHz)	
Analog	FM	400MHz~470MHz	CH <sub>L</sub>	400.0125
			CH <sub>M</sub>	435.0000
			CH <sub>H</sub>	469.9875
Digital	4FSK	400MHz~470MHz	CH <sub>L</sub>	400.0125
			CH <sub>M</sub>	435.0000
			CH <sub>H</sub>	469.9875

Note:

In section KDB 634817 D01 Sections II(f)1) and 2):

- (1) Test only on the allowed frequencies.
- (2) Test at least one frequency in each band for each rule part applied under and ensure the device is capable of operating on the frequency under each rule part. This requirement may result in testing on multiple frequencies. Testing on one frequency may be acceptable if multiple listed bands for a rule part with a continuous frequency range are split to remove a conflict with other rules and the technical requirements in the split bands are the same. Additional requirements for RF exposure may apply.

### 3.4. EUT operation mode

Test mode	Transmitting	Receiving	Power level		Digital	Analog	GPS	BT
			High	Low	12.5kHz	12.5kHz		
TX1	√		√		√			
TX2	√			√	√			
TX3	√		√			√		
TX4	√			√		√		
RX1		√			√			
RX2		√				√		
RX3		√					√	
RX4								√

√: is operation mode.

### 3.5. EUT configuration

The following peripheral devices and interface cables were connected during the measurement:

- - supplied by the manufacturer
- - supplied by the lab

●	Power Cable	Length (m) :	/
		Shield :	Unshielded
		Detachable :	Undetachable
○	Multimeter	Manufacturer :	/
		Model No. :	/

## **4. TEST ENVIRONMENT**

### **4.1. Address of the test laboratory**

Laboratory: Shenzhen Huatongwei International Inspection Co., Ltd.

Address: 1/F, Bldg 3, Hongfa Hi-tech Industrial Park, Genyu Road, Tianliao, Gongming, Shenzhen, China

Phone: 86-755-26748019 Fax: 86-755-26748089

### **4.2. Test Facility**

The test facility is recognized, certified, or accredited by the following organizations:

#### **CNAS-Lab Code: L1225**

Shenzhen Huatongwei International Inspection Co., Ltd. has been assessed and proved to be in compliance with CNAS-CL01 Accreditation Criteria for Testing and Calibration Laboratories (identical to ISO/IEC17025: 2005 General Requirements) for the Competence of Testing and Calibration Laboratories.

#### **A2LA-Lab Cert. No. 3902.01**

Shenzhen Huatongwei International Inspection Co., Ltd. EMC Laboratory has been accredited by A2LA for technical competence in the field of electrical testing, and proved to be in compliance with ISO/IEC 17025: 2005 General Requirements for the Competence of Testing and Calibration Laboratories and any additional program requirements in the identified field of testing.

#### **FCC-Registration No.: 317478**

Shenzhen Huatongwei International Inspection Co., Ltd. EMC Laboratory has been registered and fully described in a report filed with the FCC (Federal Communications Commission). The acceptance letter from the FCC is maintained in our files. Registration 317478.

#### **IC-Registration No.: 5377B**

Two 3m Alternate Test Site of Shenzhen Huatongwei International Inspection Co., Ltd. has been registered by Certification and Engineering Bureau of Industry Canada for the performance of radiated measurements with Registration No. 5377B.

#### **ACA**

Shenzhen Huatongwei International Inspection Co., Ltd. EMC Laboratory can also perform testing for the Australian C-Tick mark as a result of our A2LA accreditation.

### 4.3. Environmental conditions

Normal Conditon	
Relative humidity:	20 % to 75 %.
Air Pressure:	950~1050mba
Voltage:	DC 13.6V

### 4.4. Statement of the measurement uncertainty

The data and results referenced in this document are true and accurate. The reader is cautioned that there may be errors within the calibration limits of the equipment and facilities. The measurement uncertainty was calculated for all measurements listed in this test report acc. to CISPR 16 - 4 „Specification for radio disturbance and immunity measuring apparatus and methods – Part 4: Uncertainty in EMC Measurements“ and is documented in the Shenzhen Huatongwei International Inspection Co., Ltd quality system acc. to DIN EN ISO/IEC 17025. Furthermore, component and process variability of devices similar to that tested may result in additional deviation. The manufacturer has the sole responsibility of continued compliance of the device.

Hereafter the best measurement capability for Shenzhen Huatongwei laboratory is reported:

Test Items	Measurement Uncertainty	Notes
Frequency stability	25 Hz	(1)
Transmitter power conducted	0.57 dB	(1)
Transmitter power Radiated	2.20 dB	(1)
Conducted spurious emission 9KHz-40 GHz	1.60 dB	(1)
Conducted Emission 9KHz-30MHz	3.39 dB	(1)
Radiated Emission 30~1000MHz	4.65 dB	(1)
Radiated Emission 1~18GHz	5.16 dB	(1)
Radiated Emission 18-40GHz	5.54 dB	(1)
Occupied Bandwidth	35 Hz	(1)
FM deviation	25 Hz	(1)
Audio level	0.62 dB	(1)
Low Pass Filter Response	0.76 dB	(1)
Modulation Limiting	0.42 %	(1)
Transient Frequency Behavior	6.8 %	(1)

(1) This uncertainty represents an expanded uncertainty expressed at approximately the 95% confidence level using a coverage factor of  $k=1.96$ .



#### 4.5. Equipments Used during the Test

Conducted Emission				
Name of Equipment	Manufacturer	Model	Serial Number	Last Cal.
Artificial Mains	Rohde&Schwarz	ESH2-Z5	100028	2016/11/13
EMI Test Receiver	Rohde&Schwarz	ESCS 30	100038	2016/11/13
Pulse Limiter	Rohde&Schwarz	ESHSZ2	100044	2016/11/13
EMI Test Software	Rohde&Schwarz	ES-K1 V1.71	N/A	N/A
RF COMMUNICATION TEST SET	HP	8920A	3813A10206	2016/11/13
Artificial Mains	Rohde&Schwarz	ESH3-Z6	100210	2016/11/13
Artificial Mains	Rohde&Schwarz	ESH3-Z6	100211	2016/11/13
Test cable	ENVIROFLEX	3651	1101902	2016/11/13

Modulation Characteristic				
Name of Equipment	Manufacturer	Model	Serial Number	Last Cal.
RF COMMUNICATION TEST SET	HP	8920A	3813A10206	2016/11/13
RF Cable	Chengdu E-Microwave	----	----	2016/11/13

Frequency Stability				
Name of Equipment	Manufacturer	Model	Serial Number	Last Cal.
RF COMMUNICATION TEST SET	HP	8920A	3813A10206	2016/11/13
Signal Generator	Rohde&Schwarz	SMT03	100059	2016/11/13
Climate Chamber	ESPEC	EL-10KA	05107008	2016/11/13
RF Cable	Chengdu E-Microwave	----	----	2016/11/13

Transmitter Radiated Spurious Emission				
Name of Equipment	Manufacturer	Model	Serial Number	Last Cal.
Ultra-Broadband Antenna	Rohde&Schwarz	HL562	100015	2016/11/13
EMI Test Receiver	Rohde&Schwarz	ESI 26	100009	2016/11/13
RF Test Panel	Rohde&Schwarz	TS / RSP	335015/ 0017	N/A
HORN ANTENNA	Rohde&Schwarz	HF906	100039	2016/11/13
Turntable	ETS	2088	2149	N/A
Antenna Mast	ETS	2075	2346	N/A
EMI Test Software	Rohde&Schwarz	ES-K1 V1.71	N/A	N/A
RF COMMUNICATION TEST SET	HP	8920A	3813A10206	2016/11/13
Ultra-Broadband Antenna	ShwarzBeck	VULB9163	538	2016/11/13
Ultra-Broadband Antenna	ShwarzBeck	VULB9163	539	2016/11/13
HORN ANTENNA	ShwarzBeck	9120D	1012	2016/11/13
HORN ANTENNA	ShwarzBeck	9120D	1011	2016/11/13
TURNTABLE	MATURO	TT2.0	----	N/A
ANTENNA MAST	MATURO	TAM-4.0-P	----	N/A
Test cable	Siva Cables Italy	RG 58A/U	W14.02	2016/11/13

Maximum Transmitter Power & Spurious Emission On Antenna Port & Occupied Bandwidth & Emission Mask				
Name of Equipment	Manufacturer	Model	Serial Number	Last Cal.
Receiver	Rohde&Schwarz	ESI 26	100009	2016/11/13
Attenuator	R&S	ESH3-22	100449	2016/11/13
RF COMMUNICATION TEST SET	HP	8920A	3813A10206	2016/11/13
Digital Radio Test Set	AEROFLEX	3920	299001967	2016/11/13
High-Pass Filter	Anritsu	MP526B	6220875256	2016/11/13
High-Pass Filter	Anritsu	MP526D	6220878392	2016/11/13
Spectrum Analyzer	Aglient	E4407B	MY44210775	2016/11/13
Spectrum Analyzer	Rohde&Schwarz	FSP40	1164.4391.40	2016/11/13
SPECTRUM ANALYZER	Agilent	E4407B	MY44210775	2016/11/13
Attenuator	Chengdu E-Microwave	EMCAXX-10RNZ-3	----	2016/11/13
RF Cable	Chengdu E-Microwave	----	----	2016/11/13
Combiner	Chengdu E-Microwave	EMPD-T-2-180-10-600	----	2016/11/13

Transient Frequency Behavior				
Name of Equipment	Manufacturer	Model	Serial Number	Last Cal.
Signal Generator	Rohde&Schwarz	SMT03	100059	2016/11/13
Storage Oscilloscope	Tektronix	TDS3054B	B033027	2016/11/13
RF COMMUNICATION TEST SET	HP	8920A	3813A10206	2016/11/13
RF Cable	Chengdu E-Microwave	----	----	2016/11/13

The calibration interval was one year.

## 5. TEST CONDITIONS AND RESULTS

### 5.1. Maximum Transmitter Power

Applicants for licenses must request and use no more power than the actual power necessary for satisfactory operation.

#### LIMIT

##### **FCC Part 90.205, FCC Part 2.1046**

Maximum ERP is dependent upon the station's antenna HAAT and required service area.

The output power shall not exceed by more than 20 percent either the output power shown in the Radio Equipment List for transmitters included in this list or when not so listed, the manufacturer's rated output power for the particular transmitter specifically listed on the authorization.

#### TEST CONFIGURATION

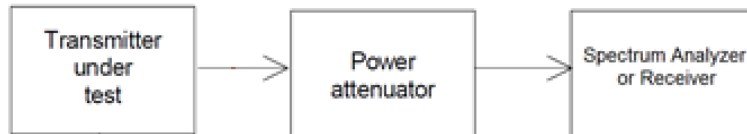

#### TEST PROCEDURE

Measurements shall be made to establish the radio frequency power delivered by the transmitter the standard output termination. The power output shall be monitored and recorded and no adjustment shall be made to the transmitter after the test has begun, except as noted below:

If the power output is adjustable, measurements shall be made for the highest and lowest power levels.

Connect the equipment as illustrated.

#### TEST MODE:

Please reference to the section 3.4

#### TEST RESULTS

**Passed**       **Not Applicable**

Please refer to the below test data:

Operation Mode	Test Channel	Measured power (dBm)	Measured power (W)	Limit (W)
TX1	CH <sub>L</sub>	46.70	46.77	36~54
	CH <sub>M</sub>	46.80	47.86	
	CH <sub>H</sub>	46.75	47.32	
TX2	CH <sub>L</sub>	36.56	4.53	4~6
	CH <sub>M</sub>	36.97	4.98	
	CH <sub>H</sub>	36.86	4.85	
TX3	CH <sub>L</sub>	46.59	45.60	36~54
	CH <sub>M</sub>	46.55	45.19	
	CH <sub>H</sub>	46.71	46.88	
TX4	CH <sub>L</sub>	37.28	5.35	4~6
	CH <sub>M</sub>	36.87	4.86	
	CH <sub>H</sub>	36.37	4.34	

## 5.2. Occupied Bandwidth

The occupied bandwidth, that is the frequency bandwidth such that, below its lower and above its upper frequency limits.

### LIMIT

#### FCC Part 90.209, FCC Part 90.210, FCC Part 2.1049

Frequency band (MHz)	Channel spacing (kHz)	Authorized bandwidth (kHz)
Below 252		
25-50	20	20
72-76	20	20
150-174	17.5	1 320/11.25/6
216-2205	6.25	20/11.25/6
220-222	5	4
406-5122	16.25	1 320/11.25/6
806-809/851-854	12.5	20
809-824/854-869	25	20
896-901/935-940	12.5	13.6
902-9284		
929-930	25	20
1427-14325	12.5	12.5
32450-2483.52		
Above 25002		

### TEST CONFIGURATION

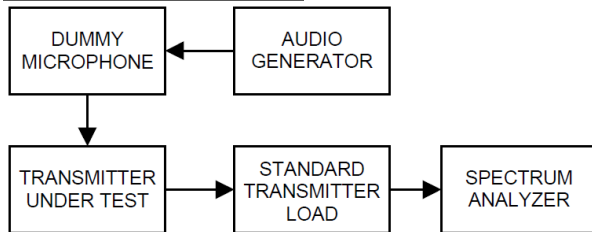

### TEST PROCEDURE

- 1 The EUT was modulated by 2.5kHz sine wave audio signal; the level of the audio signal employed is 16dB greater than that necessary to produce 50% of rated system deviation. Rated system deviation is 2.5 kHz for 12.5kHz channel spacing).
- 2 Spectrum set as follow:  
Centre frequency = fundamental frequency, span=50kHz for 12.5kHz channel spacing,  
RBW=100Hz, VBW=300Hz, Sweep = auto,  
Detector function = peak, Trace = max hold
- 3 Set 99% Occupied Bandwidth and 26dB Occupied Bandwidth
- 4 Measure and record the results in the test report.

### TEST MODE:

Please reference to the section 3.4

### TEST RESULTS

Passed       Not Applicable

Note: have pre-tested TX1 to TX4 mode, record the worst case mode TX1 and TX3 on the report.

Operation Mode	Test Channel	Occupied Bandwidth (kHz)		Limit(kHz)	Result
		99%	26dB		
TX1	CH <sub>L</sub>	7.04	9.456	≤11.25	Pass
	CH <sub>M</sub>	7.19	9.704		
	CH <sub>H</sub>	7.04	9.280		
TX3	CH <sub>L</sub>	5.24	10.112	≤11.25	Pass
	CH <sub>M</sub>	5.24	9.956		
	CH <sub>H</sub>	5.24	9.978		

Test plot as follows:

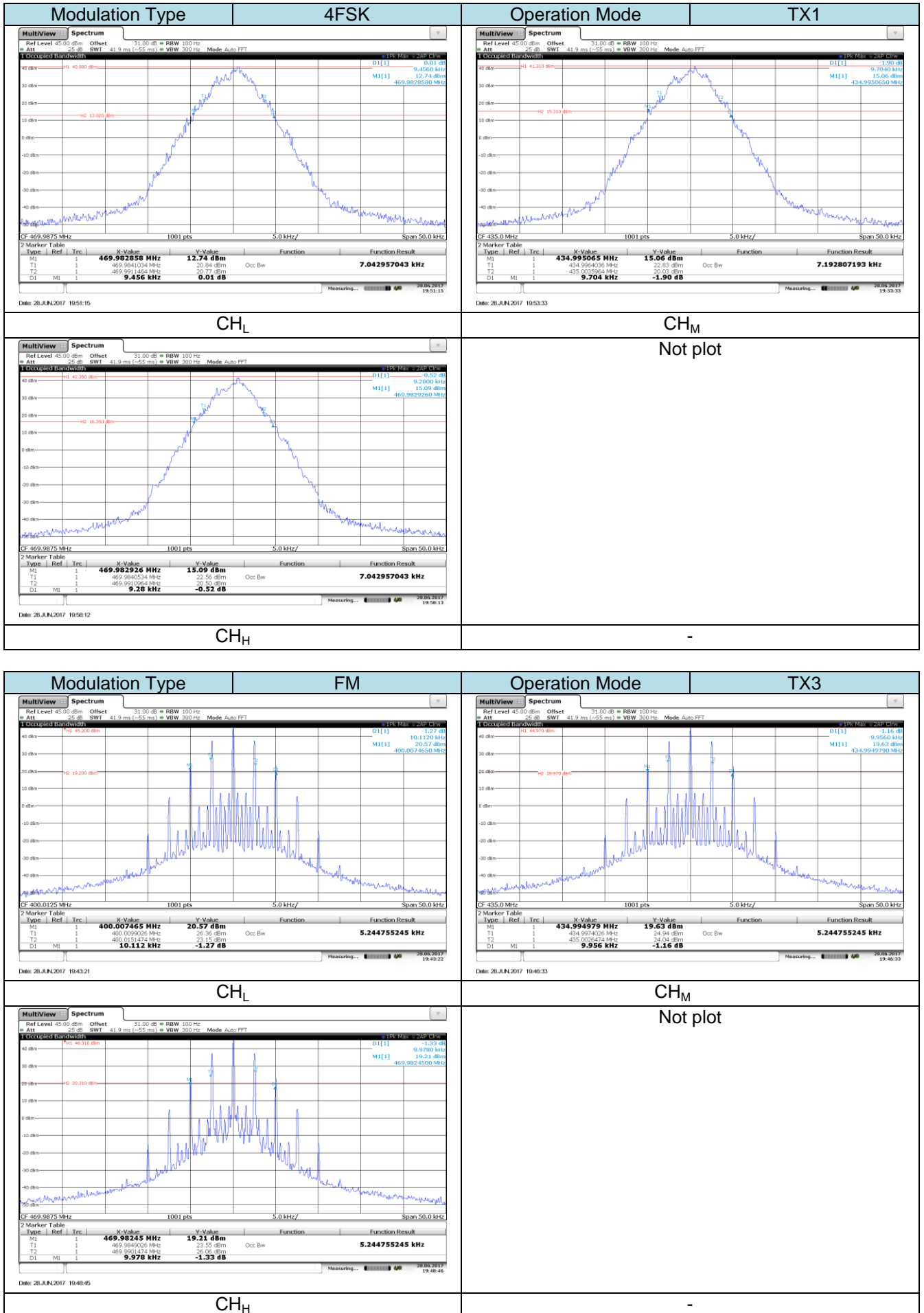

### 5.3. Emission Mask

Transmitters used in the radio services governed by this part must comply with the emission masks outlined in this section.

#### LIMIT

FCC Part 90.209, FCC Part 90.210, FCC Part 2.1049

Frequency band (MHz)	Mask for equipment with audio low pass filter	Mask for equipment without audio low pass filter
Below 251	A or B	A or C
25-50	B	C
72-76	B	C
150-1742	B, D, or E	C, D or E
150 paging only	B	C
220-222	F	F
421-5122.5	B, D, or E	C, D, or E
450 paging only	B	G
806-809/851-854	B	H
809-824/854-8693.5	B	G
896-901/935-940	I	J
902-928	K	K
929-930	B	G
4940-4990 MHz	L or M	L or M
5850-5925.4		
All other bands	B	C

(d) Emission Mask D—12.5 kHz channel bandwidth equipment.

For transmitters designed to operate with a 12.5 kHz channel bandwidth, any emission must be attenuated below the power (P) of the highest emission contained within the authorized bandwidth as follows:

- 1) On any frequency from the centre of the authorized bandwidth  $f_0$  to 5.625 kHz removed from  $f_0$ : 0dB
- 2) On any frequency removed from the centre of the authorized bandwidth by a displacement frequency ( $f_d$  in kHz) of more than 5.625 kHz but no more than 12.5 kHz: At least  $7.27(f_d - 2.88)$  dB.
- 3) On any frequency removed from the centre of the authorized bandwidth by a displacement frequency ( $f_d$  in kHz) of more than 12.5 kHz: At least  $50 + 10 \log(P)$  dB or 70 dB, whichever is the lesser attenuation.

#### TEST CONFIGURATION

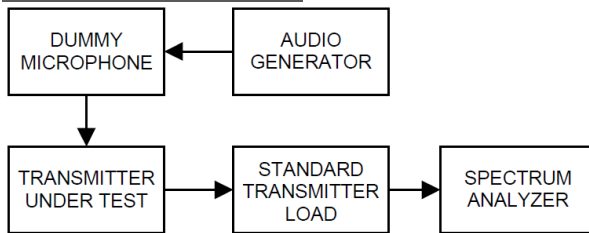

#### TEST PROCEDURE

- 1 Connect the equipment as illustrated.
- 2 Spectrum set as follow:  
Centre frequency = fundamental frequency, span=120kHz for 12.5kHz channel spacing,  
RBW=100Hz, VBW=1000Hz, Sweep = auto,  
Detector function = peak, Trace = max hold
- 3 Key the transmitter, and set the level of the unmodulated carrier to a full scale reference line. This is the 0dB reference for the measurement.
- 4 Modulate the transmitter with a 2500 Hz sine wave at an input level 16 dB greater than that necessary to produce 50% of rated system deviation(Rated system deviation is 2.5 kHz for 12.5kHz channel spacing). The input level shall be established at the frequency of maximum response of the audio modulating circuit. Transmitters employing digital modulation techniques that bypass the limiter and the audio low-pass filter shall be modulated as specified by the manufacturer
- 5 Measure and record the results in the test report.

#### TEST MODE:

Please reference to the section 3.4

#### TEST RESULTS

Passed       Not Applicable

Note: have pre-tested TX1 to TX4 mode, record the worst case mode TX1 and TX3 on the report.



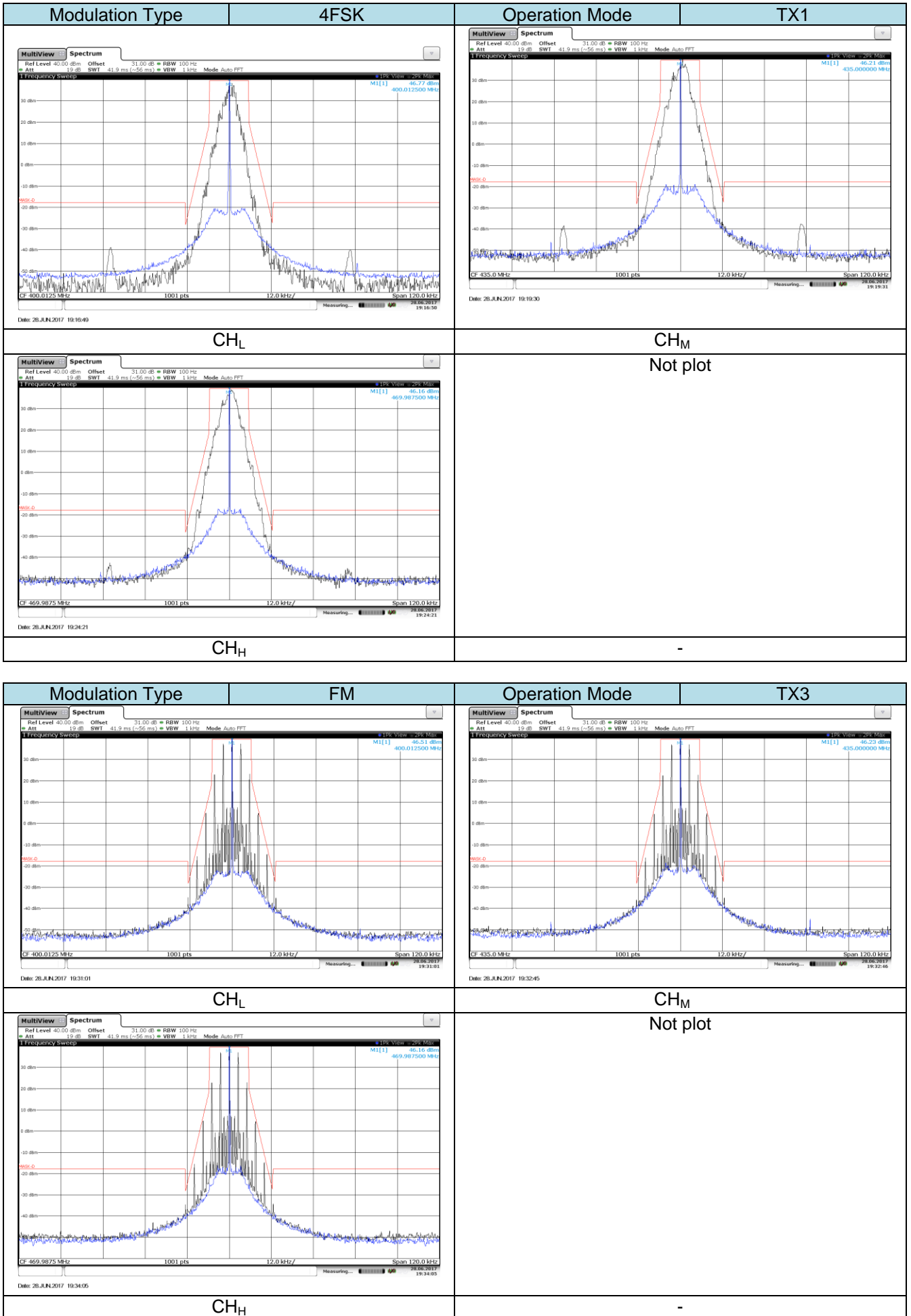

## 5.4. Modulation Limit

Modulation limiting is the transmitter circuit's ability to limit the transmitter from producing deviations in excess of a rated system deviation.

### LIMIT

FCC Part 2.1047(b)

2.5kHz for 12.5 KHz Channel Spacing System

### TEST CONFIGURATION

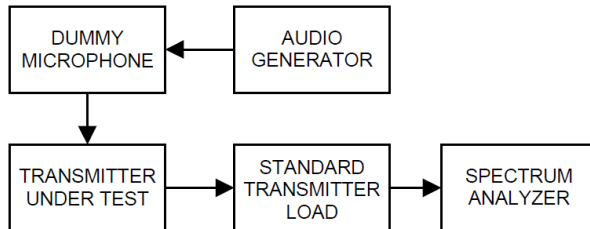

### TEST PROCEDURE

- 1) Connect the equipment as illustrated.
- 2) Adjust the transmitter per the manufacturer's procedure for full rated system deviation.
- 3) Set the test receiver to measure peak positive deviation. Set the audio bandwidth for  $\leq 0.25$  Hz to  $\geq 15,000$  Hz. Turn the de-emphasis function off.
- 4) Apply a 1000 Hz modulating signal to the transmitter from the audio frequency generator, and adjust the level to obtain 60% of full rated system deviation, this level is as a reference (0dB) and vary the input level from  $-20$  to  $+20$ dB.
- 5) Measure both the instantaneous and steady-state deviation at and after the time of increasing the audio input level
- 6) Repeat step 4-5 with input frequency changing to 300Hz, 1004Hz, 1500Hz and 2500Hz in sequence.

### TEST MODE:

Please reference to the section 3.4

### TEST RESULTS

**Passed**       **Not Applicable**

Note: have pre-tested TX3 to TX4 mode, record the worst case mode TX3 on the report.

TX3: CH <sub>H</sub>						
Modulation Level (dB)	Peak frequency deviation (kHz)				Limit (kHz)	Result
	300Hz	1004Hz	1500Hz	2500 Hz		
-20	0.085	0.191	0.293	0.423	2.5	Pass
-15	0.105	0.325	0.424	0.734		
-10	0.161	0.626	0.731	1.106		
-5	0.283	0.724	1.323	1.821		
0	0.432	1.538	1.767	1.82		
5	0.701	1.921	1.985	1.912		
10	0.955	2.121	1.872	1.897		
15	0.913	2.065	1.977	1.932		
20	0.872	2.076	1.901	1.945		

Test plot as follows:

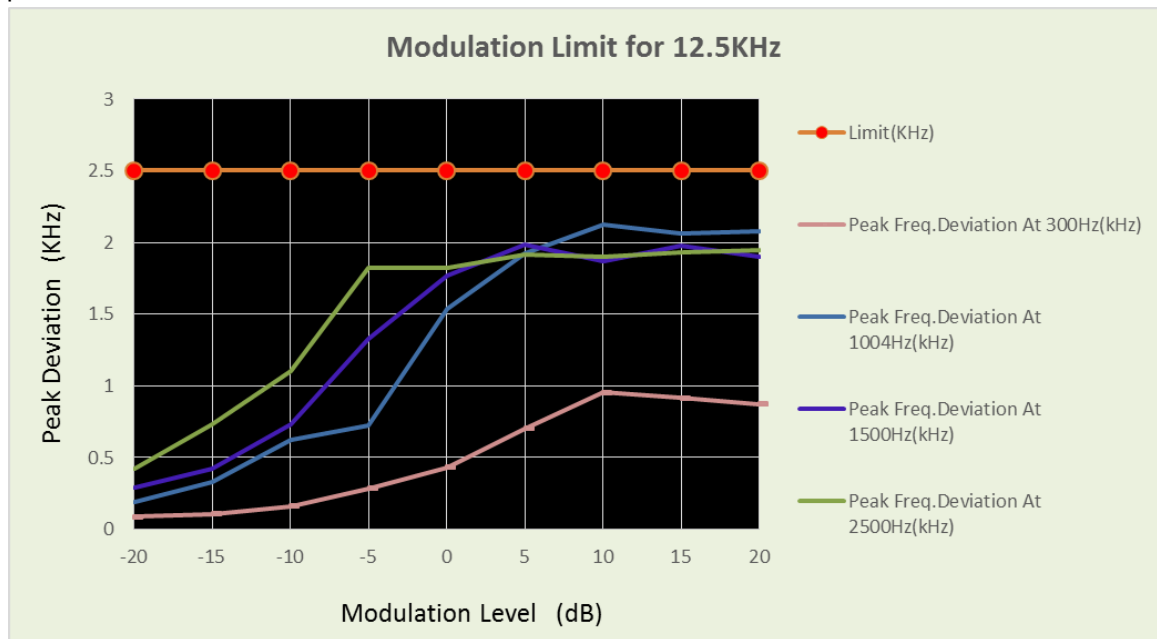

### 5.5. Audio Frequency Response

The audio frequency response is the degree of closeness to which the frequency deviation of the transmitter follows a prescribed characteristic.

**LIMIT**

2.1047(a): Voice modulated communication equipment. A curve or equivalent data showing the frequency response of the audio modulating circuit over a range of 100 to 5000 Hz shall be submitted. For equipment required to have an audio low-pass filter, a curve showing the frequency response of the filter or of all circuitry installed between the modulation limiter and the modulated stage shall be submitted.

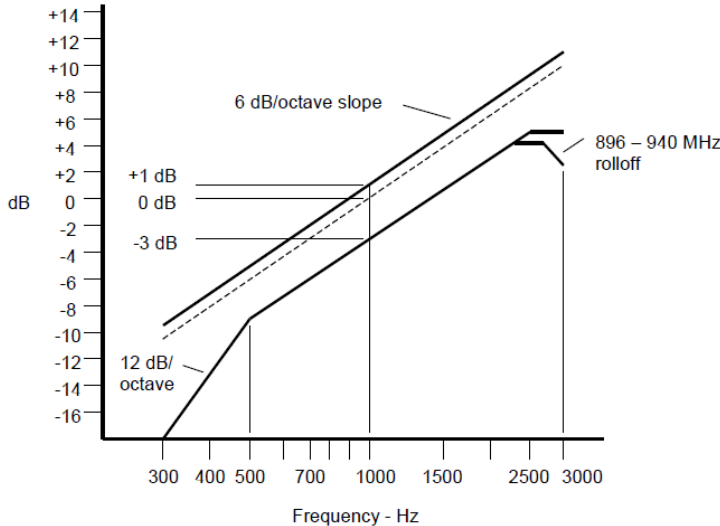

An additional 6 dB per octave attenuation is allowed from 2500 Hz to 3000 Hz in equipment operating in the 25 MHz to 869 MHz range.

**TEST CONFIGURATION**

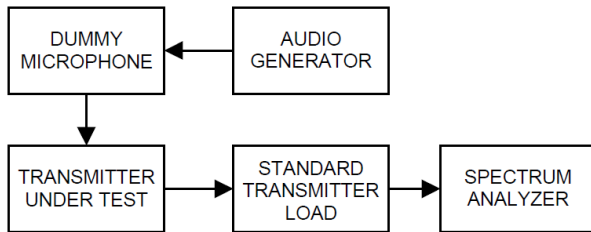

**TEST PROCEDURE**

- 1) Configure the EUT as shown in figure .
- 2) Adjust the audio input for 20% of rated system deviation at 1kHz using this level as a reference.
- 3) Vary the Audio frequency from 300Hz to 3 kHz and record the frequency deviation.
- 4) Audio Frequency Response =  $20\log_{10} (V_{FREQ}/V_{REF})$ .

**TEST MODE:**

Please reference to the section 3.4

**TEST RESULTS**

Passed       Not Applicable

Note: have pre-tested TX3 to TX4 mode, record the worst case mode TX3 on the report.

TX3: CH <sub>H</sub>			
Frequency (Hz)	Audio Frequency Response (dB)	Frequency (Hz)	Audio Frequency Response (dB)
100	-18.55	2100	5.78
200	-19.15	2200	5.99
300	-9.72	2300	6.27
400	-7.59	2400	6.61
500	-5.52	2500	7.01
600	-4.23	2600	7.47
700	-2.99	2700	7.89
800	-1.63	2800	8.37
900	-0.86	2900	8.53
1000	0.00	3000	8.07
1200	1.59	3500	-16.50
1400	2.87	4000	-19.86
1600	3.91	4500	-20.34
1800	4.65	5000	-23.54
2000	5.34		

Test plot as follows:

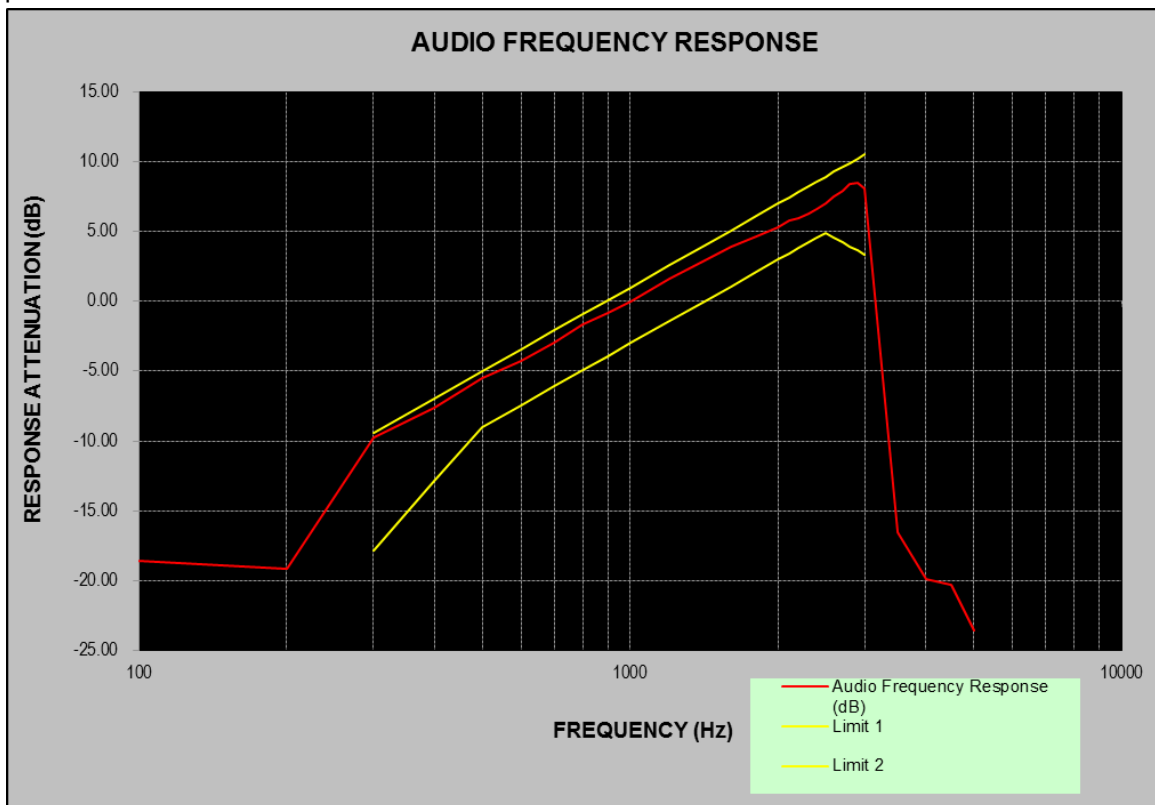

### 5.6. Frequency Stability Test

The carrier frequency stability is the ability of the transmitter to maintain an assigned carrier frequency.

**LIMIT**

**FCC Part 90.213, FCC Part 2.1055**

Frequency range (MHz)	Fixed and base stations	Mobile stations	
		Over 2 watts output power	2 watts or less output power
Below 25	1 2 3 100	100	200
25-50	20	20	50
72-76	5		50
150-174	5 115	65	4 650
216-220	1.0		1.0
220-222.12	0.1	1.5	1.5
421-512	7 11 142.5	85	85
806-809	141.0	1.5	1.5
809-824	141.5	2.5	2.5
851-854	1.0	1.5	1.5
854-869	1.5	2.5	2.5
896-901	140.1	1.5	1.5
902-928	2.5	2.5	2.5
902-928.13	2.5	2.5	2.5
929-930	1.5		
935-940	0.1	1.5	1.5
1427-1435	9300	300	300
Above 2450.10			

<sup>5</sup>In the 150-174 MHz band, fixed and base stations with a 12.5 kHz channel bandwidth must have a frequency stability of 2.5 ppm. Fixed and base stations with a 6.25 kHz channel bandwidth must have a frequency stability of 1.0 ppm.

<sup>7</sup>In the 421-512 MHz band, fixed and base stations with a 12.5 kHz channel bandwidth must have a frequency stability of 1.5 ppm. Fixed and base stations with a 6.25 kHz channel bandwidth must have a frequency stability of 0.5 ppm.

<sup>11</sup>Paging transmitters operating on paging-only frequencies must operate with frequency stability of 5 ppm in the 150-174 MHz band and 2.5 ppm in the 421-512 MHz band.

<sup>14</sup>Control stations may operate with the frequency tolerance specified for associated mobile frequencies.

**TEST CONFIGURATION**

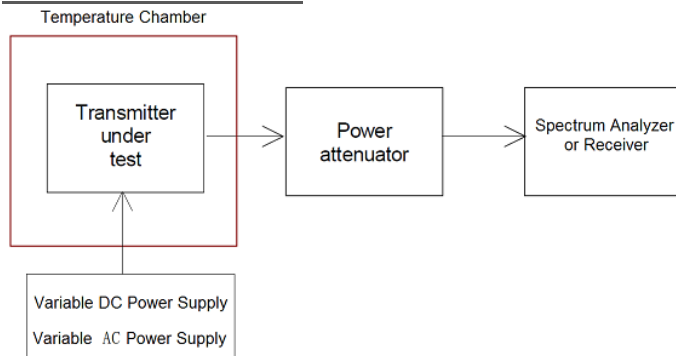

**TEST PROCEDURE**

1. According to FCC Part 2 Section 2.1055 (a)(1), the frequency stability shall be measured with variation of ambient temperature from -30°C to +50°C.
2. According to FCC Part 2 Section 2.1055 (d) (2), for battery powered equipment, the frequency stability shall be measured with reducing primary supply voltage to the battery operating end point, which is specified by the manufacture.
3. Vary primary supply voltage from 3.6V to 4.2V.
4. The EUT was set in the climate chamber and connected to an external DC power supply. The RF output was directly connected to Spectrum Analyzer, The coupling loss of the additional cables was recorded and taken in account for all the measurements. After temperature stabilization (approx. 20 min for each stage), the frequency for the lower, the middle and the highest frequency range was recorded. For Frequency stability Vs. Voltage the EUT was connected to a DC power supply and the voltage was adjusted in the required ranges. The result was recorded.

**TEST MODE:**

Please reference to the section 3.4

**TEST RESULTS** **Passed**       **Not Applicable**

Note: have pre-tested TX1 to TX4 mode, record the worst case mode TX1 and TX3 on the report.

TX1						
Test conditions		Frequency error (ppm)			Limit (ppm)	Result
Voltage(V)	Temp(°C)	CH <sub>L</sub>	CH <sub>M</sub>	CH <sub>H</sub>		
13.6	-30	0.04	0.03	0.02	±2.5	Pass
	-20	0.04	0.04	0.03		
	-10	0.03	0.04	0.04		
	0	0.02	0.05	0.04		
	10	0.02	0.04	0.04		
	20	0.04	0.05	0.05		
	30	0.03	0.04	0.04		
	40	0.03	0.04	0.05		
	50	0.04	0.05	0.04		
15.64	20	0.03	0.05	0.04		
11.56	20	0.04	0.06	0.06		

TX3						
Test conditions		Frequency error (ppm)			Limit (ppm)	Result
Voltage(V)	Temp(°C)	CH <sub>L</sub>	CH <sub>M</sub>	CH <sub>H</sub>		
13.6	-30	0.03	0.04	0.03	2.5	Pass
	-20	0.03	0.04	0.03		
	-10	0.03	0.04	0.04		
	0	0.03	0.04	0.04		
	10	0.03	0.04	0.04		
	20	0.03	0.04	0.04		
	30	0.03	0.04	0.04		
	40	0.03	0.04	0.04		
	50	0.04	0.05	0.04		
15.64	20	0.03	0.05	0.04		
11.56	20	0.05	0.05	0.04		



### 5.7. Transmitter Frequency Behaviour

**LIMIT**

**FCC part 90.214**

Transmitters designed to operate in the 150-174 MHz and 421-512 MHz frequency bands must maintain transient frequencies within the maximum frequency difference limits during the time intervals indicated:

Time intervals <sup>1 2</sup>	Maximum frequency difference <sup>3</sup>	All equipment	
		150 to 174 MHz	421 to 512 MHz
Transient Frequency Behavior for Equipment Designed to Operate on 25 kHz Channels			
t <sub>1</sub> <sup>4</sup>	±25.0 kHz	5.0 ms	10.0 ms
t <sub>2</sub>	±12.5 kHz	20.0 ms	25.0 ms
t <sub>3</sub> <sup>4</sup>	±25.0 kHz	5.0 ms	10.0 ms
Transient Frequency Behavior for Equipment Designed to Operate on 12.5 kHz Channels			
t <sub>1</sub> <sup>4</sup>	±12.5 kHz	5.0 ms	10.0 ms
t <sub>2</sub>	±6.25 kHz	20.0 ms	25.0 ms
t <sub>3</sub> <sup>4</sup>	±12.5 kHz	5.0 ms	10.0 ms
Transient Frequency Behavior for Equipment Designed to Operate on 6.25 kHz Channels			
t <sub>1</sub> <sup>4</sup>	±6.25 kHz	5.0 ms	10.0 ms
t <sub>2</sub>	±3.125 kHz	20.0 ms	25.0 ms
t <sub>3</sub> <sup>4</sup>	±6.25 kHz	5.0 ms	10.0 ms

Note:

- On is the instant when a 1 kHz test signal is completely suppressed, including any capture time due to phasing.
  - t<sub>1</sub> is the time period immediately following t<sub>on</sub>.
  - t<sub>2</sub> is the time period immediately following t<sub>1</sub>.
  - t<sub>3</sub> is the time period from the instant when the transmitter is turned off until t<sub>off</sub>.
  - t<sub>off</sub> is the instant when the 1 kHz test signal starts to rise.
- During the time from the end of t<sub>2</sub> to the beginning of t<sub>3</sub>, the frequency difference must not exceed the limits specified in § 90.213.
- Difference between the actual transmitter frequency and the assigned transmitter frequency.
- If the transmitter carrier output power rating is 6 watts or less, the frequency difference during this time period may exceed the maximum frequency difference for this time period.

**TEST CONFIGURATION**

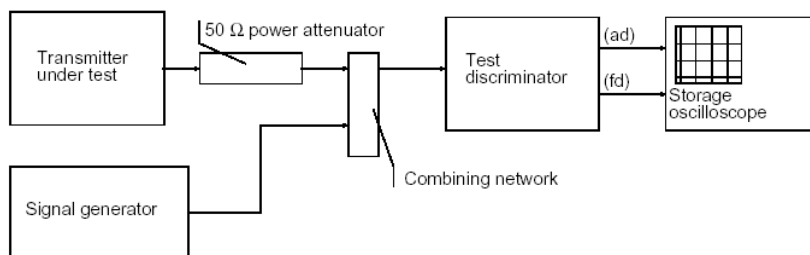

**TEST PROCEDURE**

According to TIA/EIA-603 2.2.19 requirement, as for the product different from PTT, we use test steps as follows:

1. Connect DUT into Test discriminator and Storage Oscilloscope and keep DUT stats ON;
2. Input 1kHz signal into DUT;
3. Set the modulation domain analyzer to trigger on the rising edge of the waveform in order to capture a single-shot turn-on of the transmitter signals;
4. Keep DUT in OFF state and Key the PTT;
5. Observe the stored oscilloscope of modulation domain analyzer. The signal trace shall be maintained within the allowable limits during the periods  $t_1$  and  $t_2$ , and shall also remain within limits following  $t_2$ ;
6. Adjust the modulation domain analyzer to trigger on the falling edge of the transmitter waveform in order to capture a single-shot turn-off transmitter of the transmitter signal.
7. Keep the digital portable radio in ON state and unkey the PTT;
8. Observe the stored oscilloscope of modulation domain analyzer, The signal trace shall be maintained within the allowable limits during the period  $t_3$ .
9. Set the signal generator to the assigned transmitter frequency and modulate it with a 1 kHz tone at  $\pm 12.5$  kHz deviation and set its output level to -100dBm.
10. Turn on the transmitter.
11. Supply sufficient attenuation via the RF attenuator to provide an input level to the stored oscilloscope
12. that is 40 dB below the maximum allowed input power when the transmitter is operating at its rated power level. Note this power level on the stored oscilloscope as  $P_0$ .
13. Turn off the transmitter.
14. Adjust the RF level of the signal generator to provide RF power equal to  $P_0$ . This signal generator RF level shall be maintained throughout the rest of the measurement.
15. Remove the attenuation, so the input power to the stored oscilloscope is increased by 30 dB when the transmitter is turned on.
16. Adjust the vertical amplitude control of the stored oscilloscope to display the 1000 Hz at  $\pm 4$  divisions vertically centered on the display. Set trigger mode of the Spectrum Analyzer to "Video", and tune the "trigger level" on suitable level. Then set the "trigger offset" to -10ms for turn on and -15ms for turn off.
17. Turn on the transmitter and the transient wave will be captured on the screen of Spectrum Analyzer. Observe the stored display. The instant when the 1 kHz test signal is completely suppressed is considered to be ton. The trace should be maintained within the allowed divisions during the period  $t_1$  and  $t_2$ .
18. Then turn off the transmitter, and another transient wave will be captured on the screen of Spectrum
19. Analyzer. The trace should be maintained within the allowed divisions during the period  $t_3$ .

**TEST MODE:**

Please reference to the section 3.4

**TEST RESULTS**

**Passed**       **Not Applicable**

Note: have pre-tested TX1 to TX4 mode, record the worst case mode TX1 and TX3 on the report.

Modulation Type: 4FSK(TX1)  
Transmitter Frequency Behaviour @ 12.5kHz Channel Separation-----Off – On

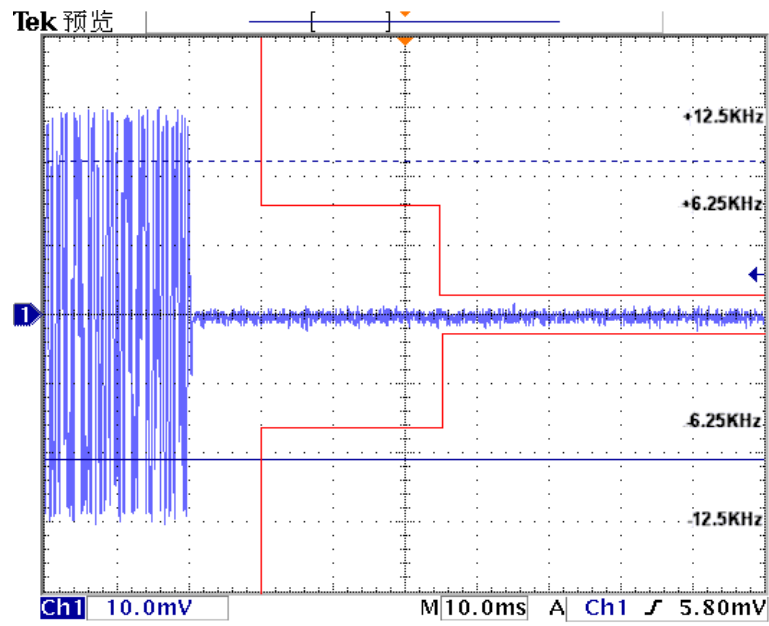

Transmitter Frequency Behaviour @ 12.5kHz Channel Separation-----On – Off

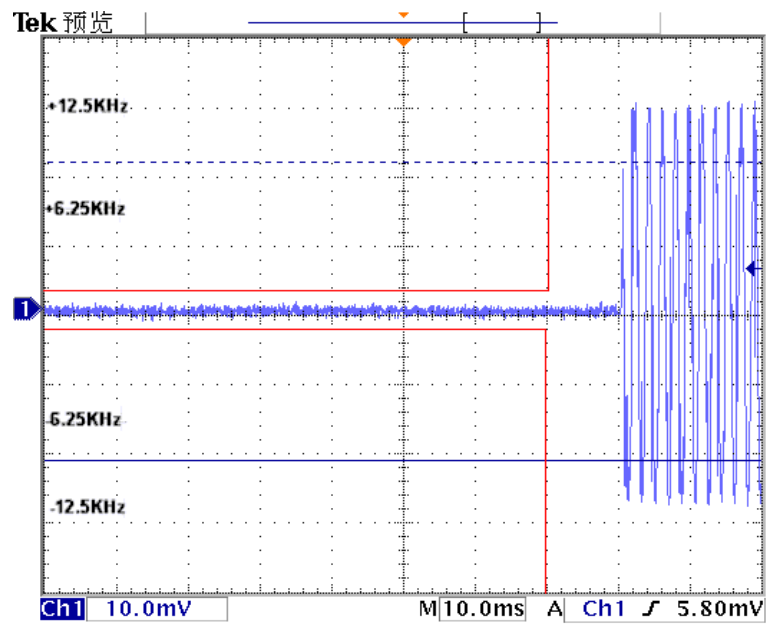

Modulation Type: FM(TX3)  
Transmitter Frequency Behaviour @ 12.5kHz Channel Separation-----Off – On

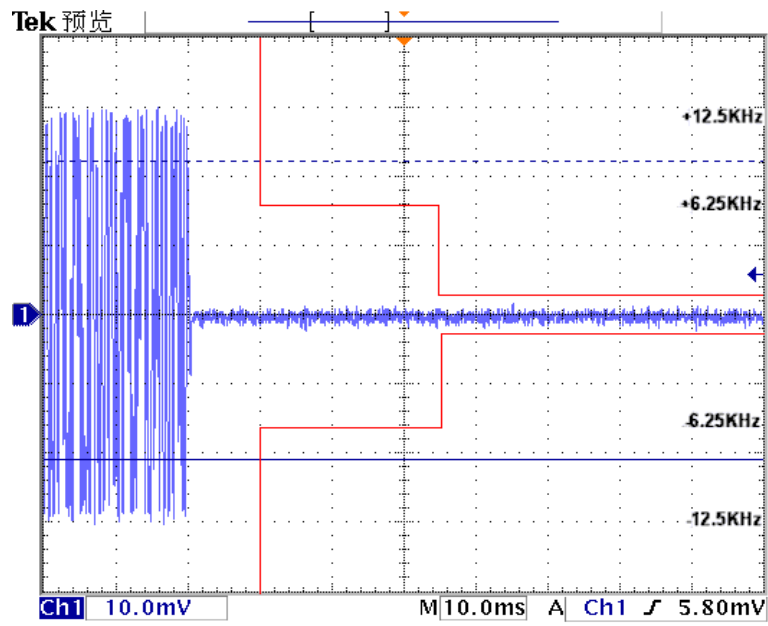

Transmitter Frequency Behaviour @ 12.5kHz Channel Separation-----On – Off

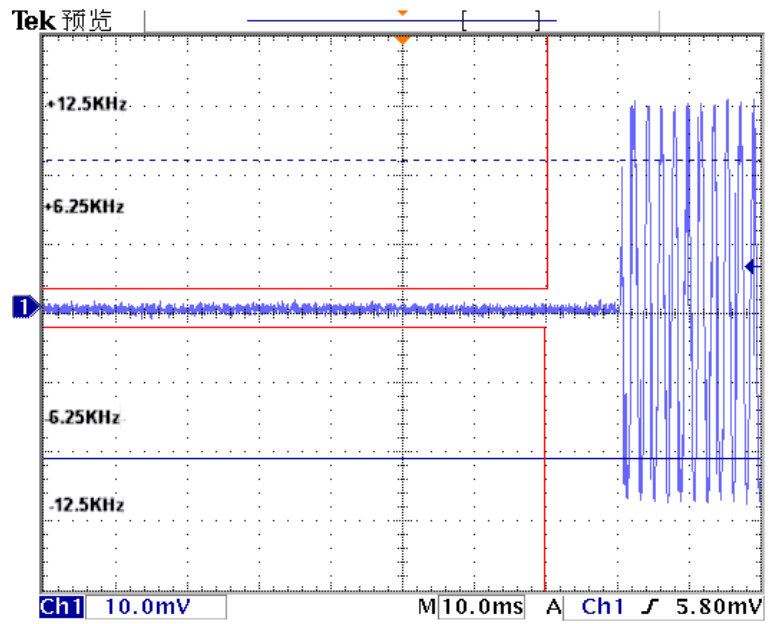

## 5.8. Spurious Emission on Antenna Port

Conducted spurious emissions are emissions at the antenna terminals on a frequency or frequencies that are outside a band sufficient to ensure transmission of information of required quality for the class of communication desired

### LIMIT

FCC Part 90.210, FCC Part 2.1051 (12.5 kHz Bandwidth only):

On any frequency removed from the center of the authorized bandwidth by a displacement frequency ( $f_d$  in kHz) of more than 12.5 kHz at least:

$50 + 10 \log (P_{\text{watts}})$

Note: In general, the worse case attenuation requirement shown above was applied.

Calculation: Limit (dBm) = EL - 50 - 10 log<sub>10</sub> (TP)

EL is the emission level of the Output Power expressed in dBm,

In this application, the EL is P (dBm)

Limit (dBm) = P (dBm) - 50 - 10 log (Pwatts) = -20dBm

### TEST CONFIGURATION

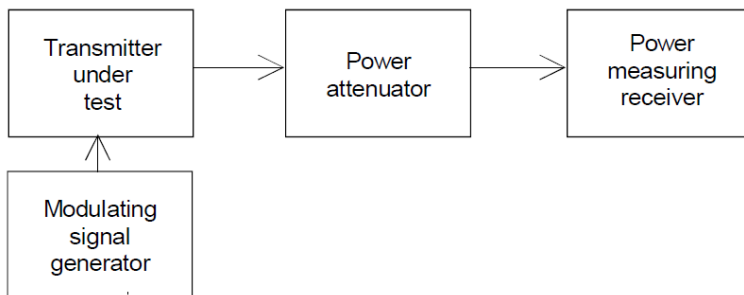

### TEST PROCEDURE

1. The RF output of the EUT was connected to a spectrum analyzer through appropriate attenuation.
2. The resolution bandwidth of the spectrum analyzer was set to 100 kHz. Sufficient scans were taken to show any out of band emission up to 10<sup>th</sup>. Harmonic for the lower and the highest frequency range.
3. Set RBW 100 kHz, VBW 300 kHz in the frequency band 30MHz to 1GHz, while set RBW=1MHz. VBW=3MHz from the 1GHz to 10<sup>th</sup> Harmonic.
4. The audio input was set the unmodulated carrier, the resulting picture is print out for each channel separation.

### TEST MODE:

Please reference to the section 3.4

### TEST RESULTS

**Passed**       **Not Applicable**

1. The measurement frequency range from 30 MHz to 5 GHz.
2. We tested TX1 to TX3 recorded worst case TX1 and TX3.

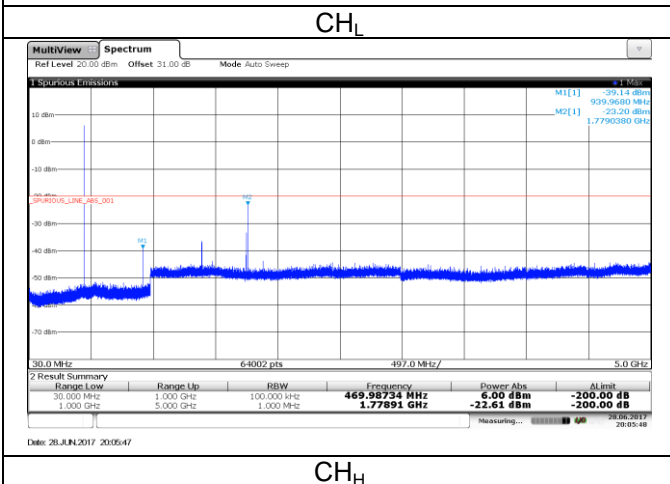
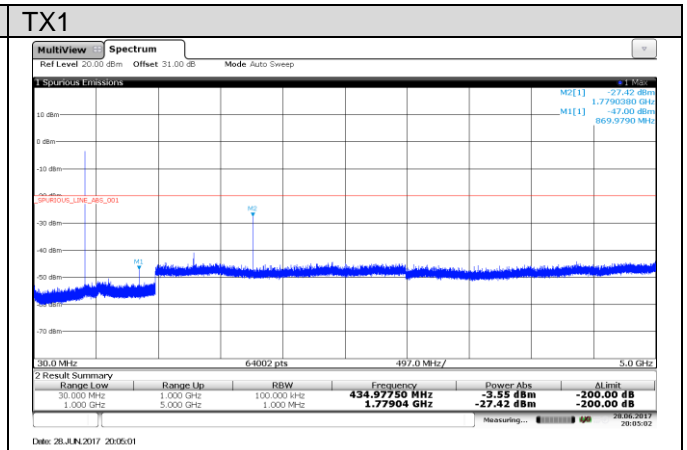
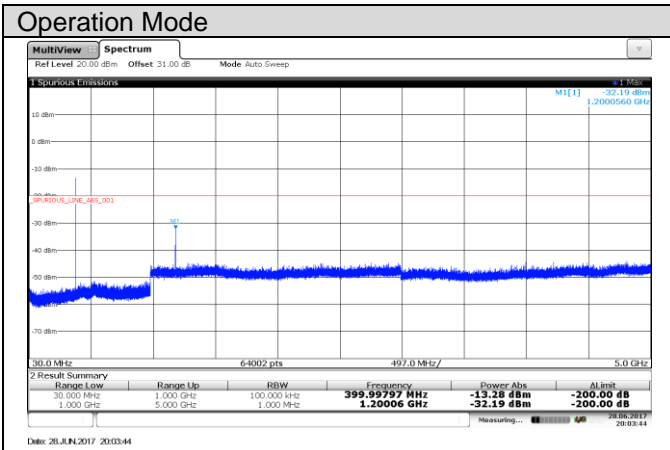

### CH<sub>M</sub>

No plot

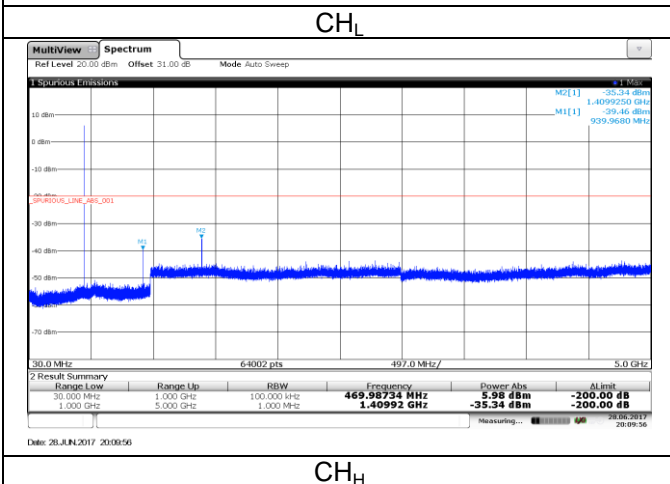
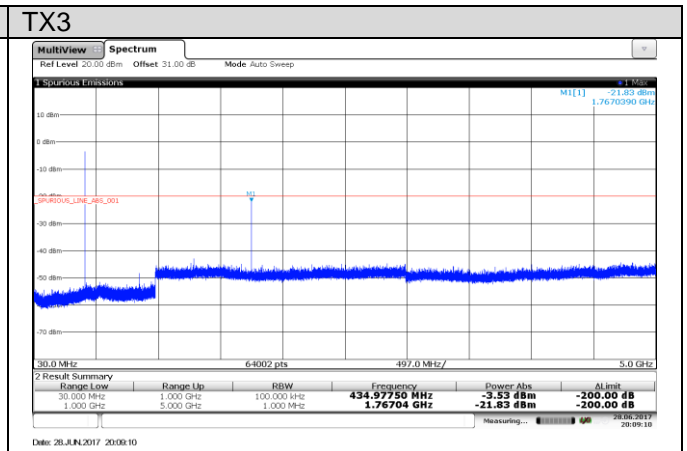
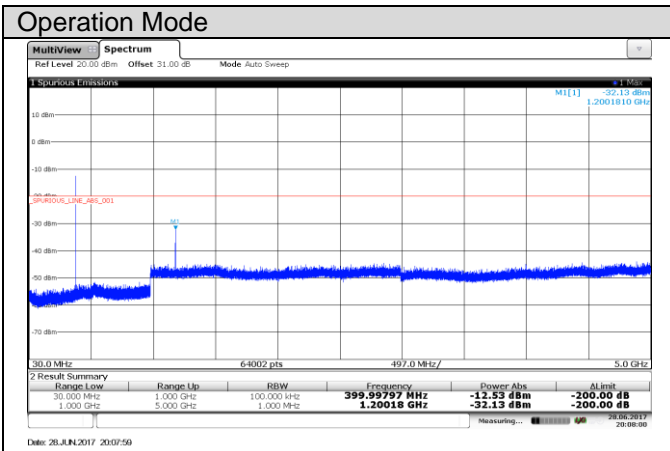

### CH<sub>M</sub>

No plot

### 5.9. Transmitter Radiated Spurious Emission

Radiated spurious emissions are emissions from the equipment when transmitting into a nonradiating load on a frequency or frequencies that are outside an occupied band sufficient to ensure transmission of information of required quality for the class of communications desired.

#### LIMIT

FCC Part 90.210, FCC Part 2.1053 (12.5 kHz Bandwidth only):

On any frequency removed from the center of the authorized bandwidth by a displacement frequency ( $f_d$  in kHz) of more than 12.5 kHz at least:

$$50 + 10 \log (P_{\text{watts}})$$

Note: In general, the worse case attenuation requirement shown above was applied.

$$\text{Calculation: Limit (dBm)} = \text{EL} - 50 - 10 \log_{10} (\text{TP})$$

EL is the emission level of the Output Power expressed in dBm,

In this application, the EL is P (dBm)

$$\text{Limit (dBm)} = P (\text{dBm}) - 50 - 10 \log (P_{\text{watts}}) = -20 \text{dBm}$$

#### TEST CONFIGURATION

Below 1GHz:

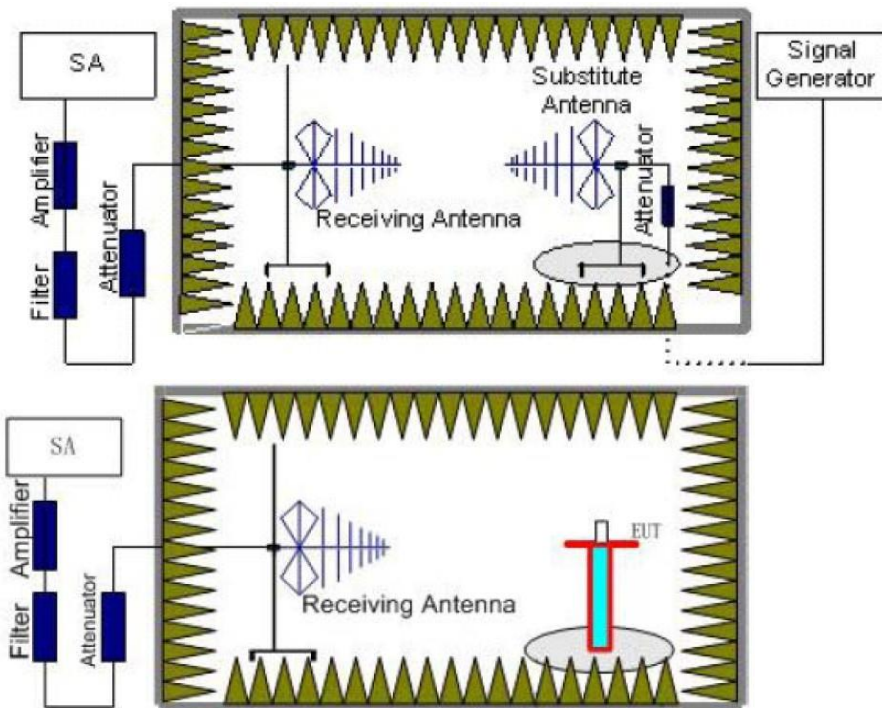

Above 1GHz:

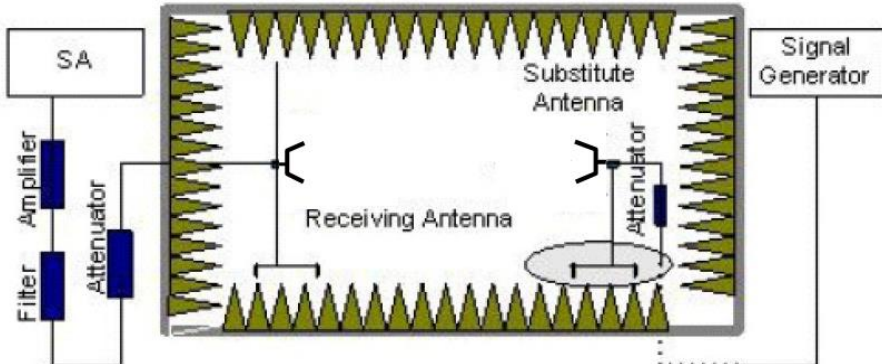

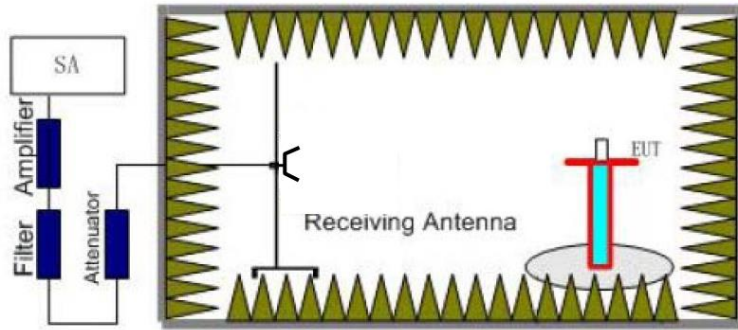

### **TEST PROCEDURE**

1. Standard Transmitter Load with a  $50\ \Omega$  input impedance and an output impedance matched to the test equipment.
2. EUT was placed on a 0.8 meter high non-conductive stand at a 3 meter test distance from the receive antenna. A receiving antenna was placed on the antenna mast 3 meters from the EUT for emission measurements. The height of receiving antenna is 1.0 m. Detected emissions were maximized at each frequency by rotating the EUT through  $360^\circ$  and adjusting the receiving antenna polarization. The radiated emission measurements of all transmit frequencies in six channels were measured with peak detector.
3. A log-periodic antenna or double-ridged waveguide horn antenna shall be substituted in place of the EUT. The log-periodic antenna will be driven by a signal generator and the level will be adjusted till the same power value on the spectrum analyzer or receiver. The level of the spurious emissions can be calculated through the level of the signal generator, cable loss, the gain of the substitution antenna and the reading of the spectrum analyzer or receiver.
4. The EUT is then put into continuously transmitting mode at its maximum power level during the test. Set Test Receiver or Spectrum RBW=1MHz,VBW=3MHz for above 1GHz and RBW=100kHz,VBW=300kHz for 30MHz to 1GHz, And the maximum value of the receiver should be recorded as (Pr).
5. The EUT shall be replaced by a substitution antenna. In the chamber, an substitution antenna for the frequency band of interest is placed at the reference point of the chamber. An RF Signal source for the frequency band of interest is connected to the substitution antenna with a cable that has been constructed to not interfere with the radiation pattern of the antenna. A power (PMea) is applied to the input of the substitution antenna, and adjust the level of the signal generator output until the value of the receiver reach the previously recorded (Pr). The power of signal source (PMea) is recorded. The test should be performed by rotating the test item and adjusting the receiving antenna polarization.
6. A amplifier should be connected to the Signal Source output port. And the cable should be connect between the Amplifier and the Substitution Antenna. The cable loss (Pcl) ,the Substitution Antenna Gain (Ga) and the Amplifier Gain (PAg) should be recorded after test.  
The measurement results are obtained as described below:  
Power(EIRP)=PMea- PAg - Pcl - Ga  
We used SMF100A microwave signal generator which signal level can up to 33dBm,so we not used power Amplifier for substitution test; The measurement results are amend as described below:  
Power(EIRP)=PMea- Pcl - Ga
7. This value is EIRP since the measurement is calibrated using an antenna of known gain (2.15 dBi) and known input power.
8. ERP can be calculated from EIRP by subtracting the gain of the dipole,  $ERP = EIRP - 2.15\text{dBi}$ .

### **TEST MODE:**

Please reference to the section 3.4

### **TEST RESULTS**

**Passed**       **Not Applicable**

Note:

1. In general, the worse case attenuation requirement shown above was applied.
2. The measurement frequency range from 30 MHz to 5 GHz.
3. We tested TX1 to TX3 recorded worst case TX1 and TX3.



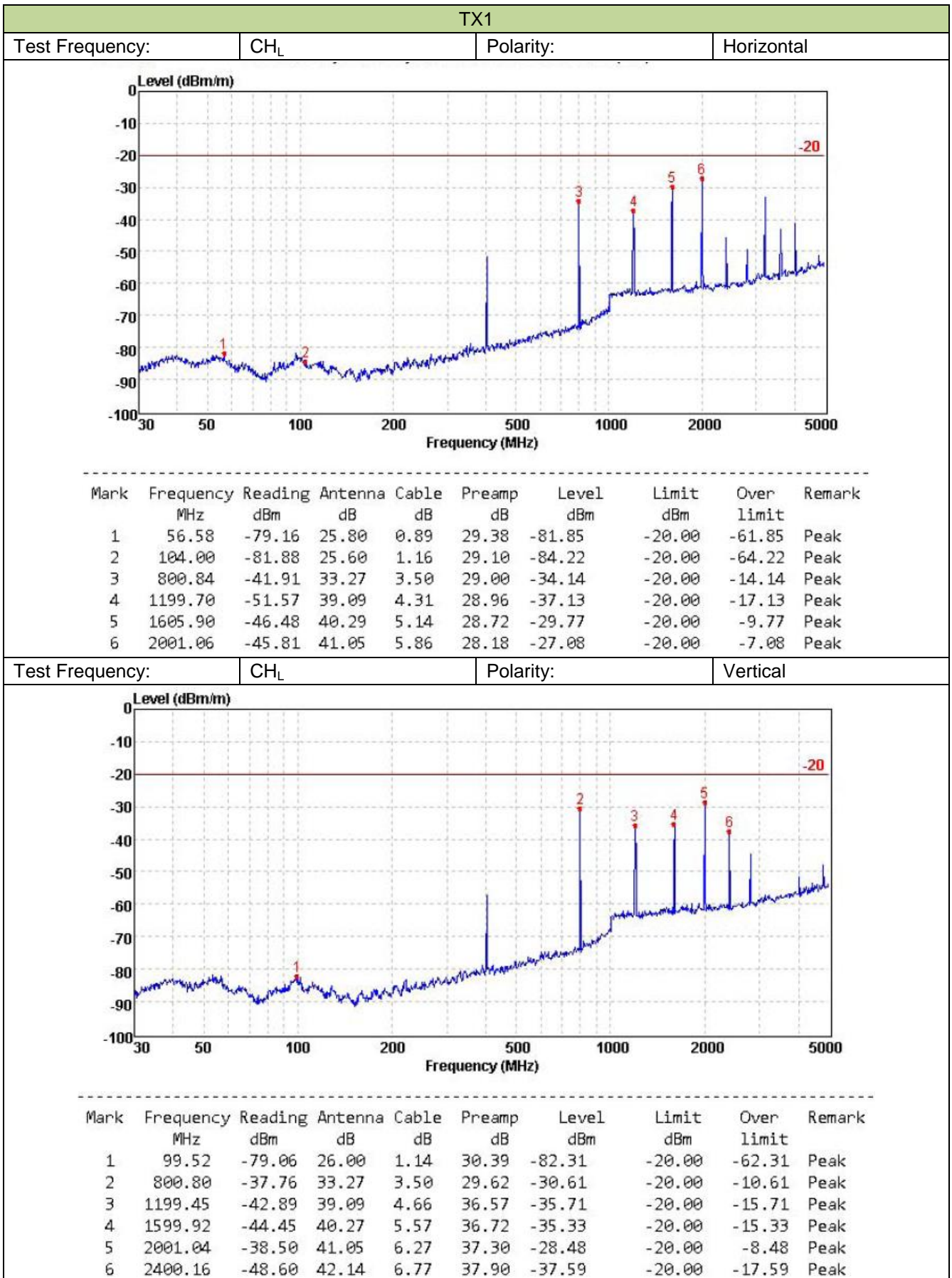

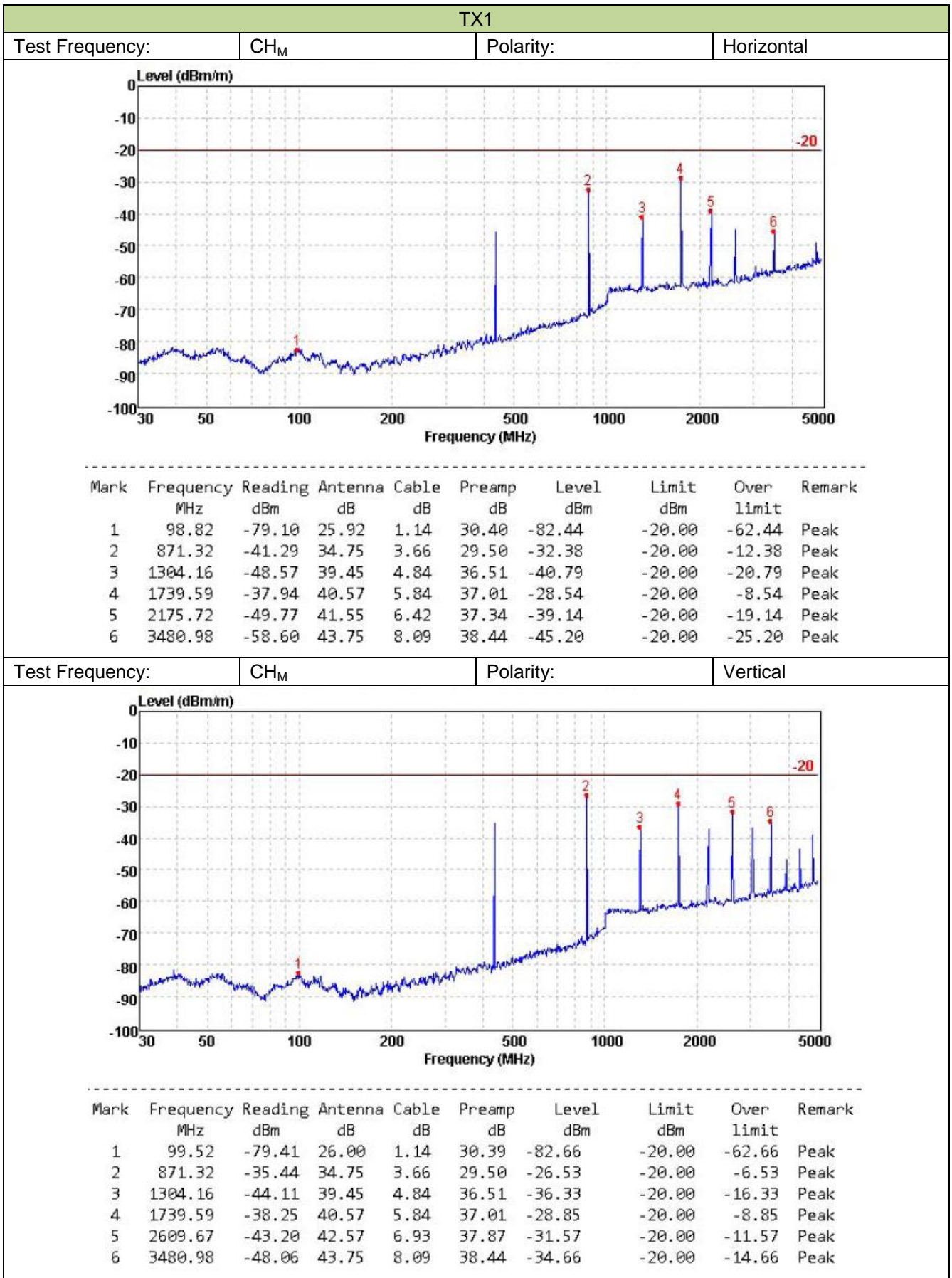

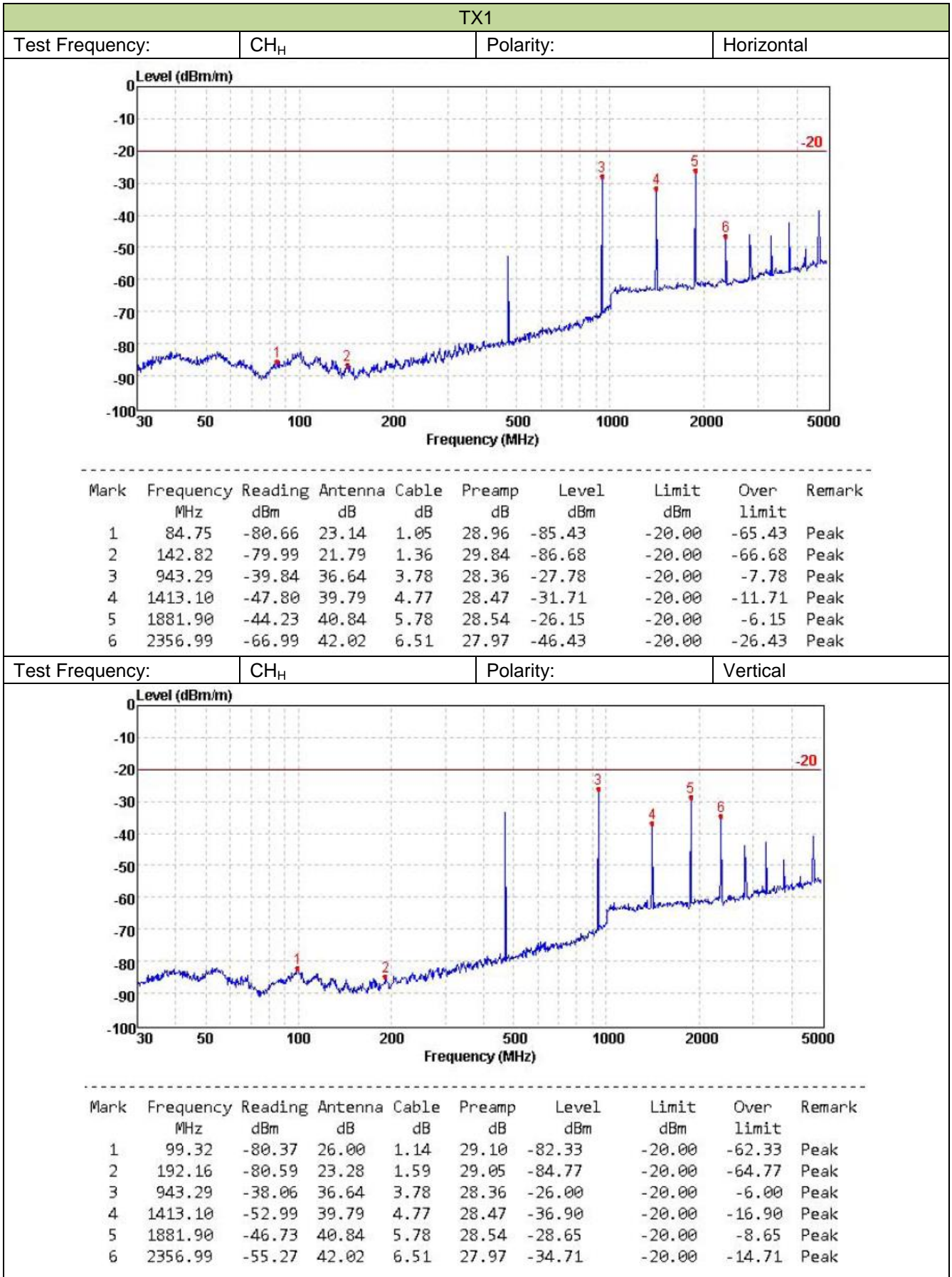

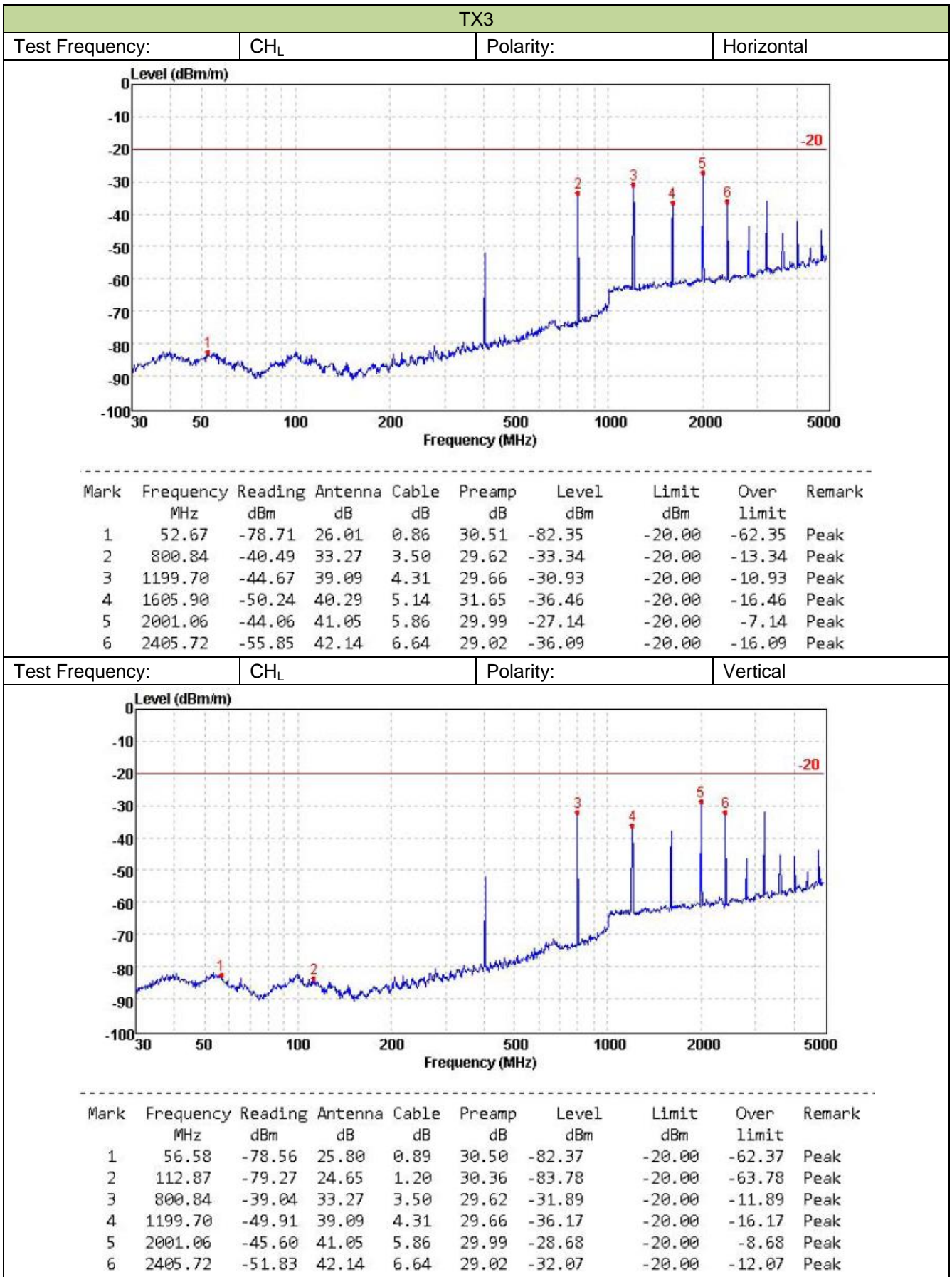

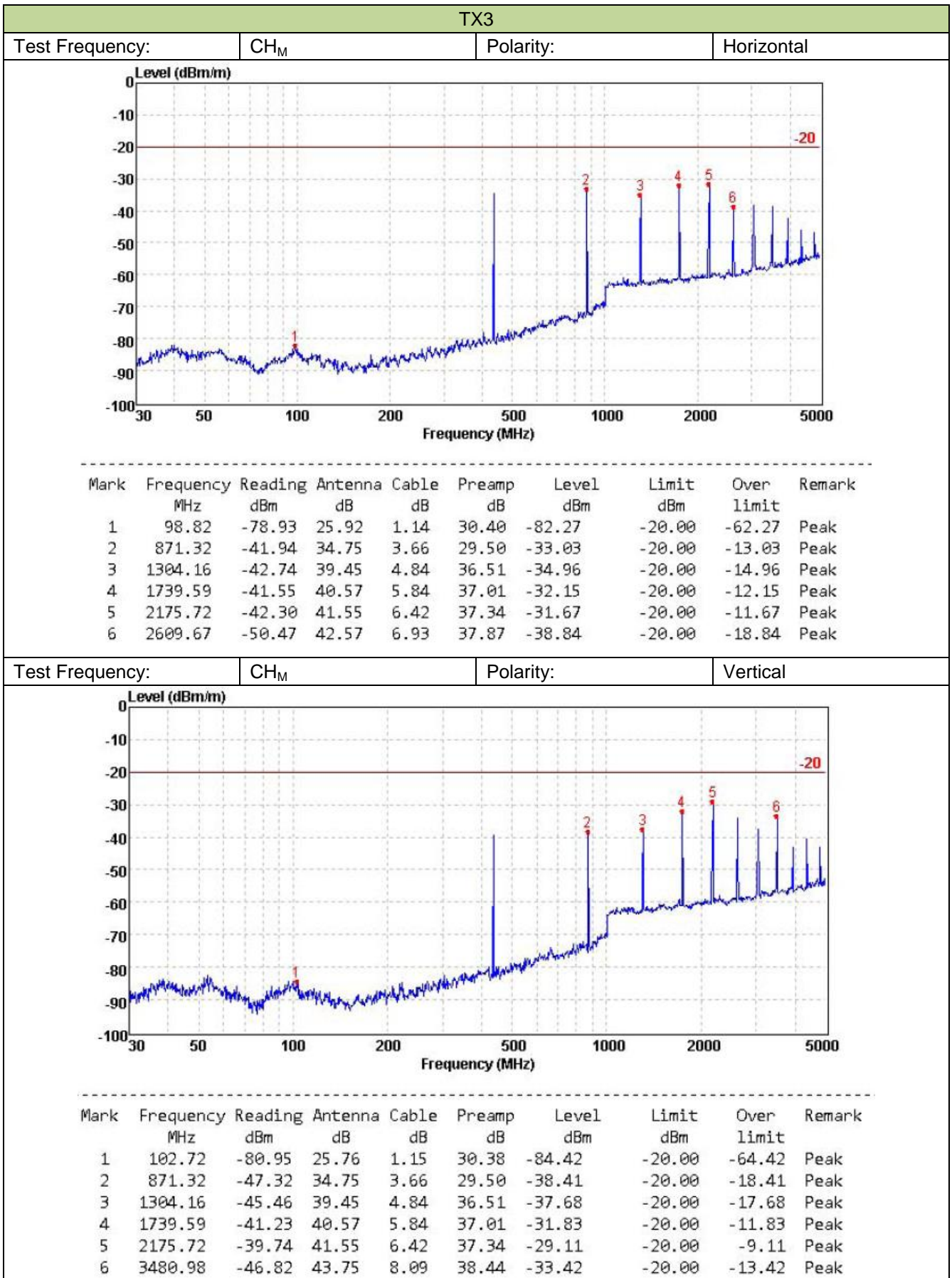

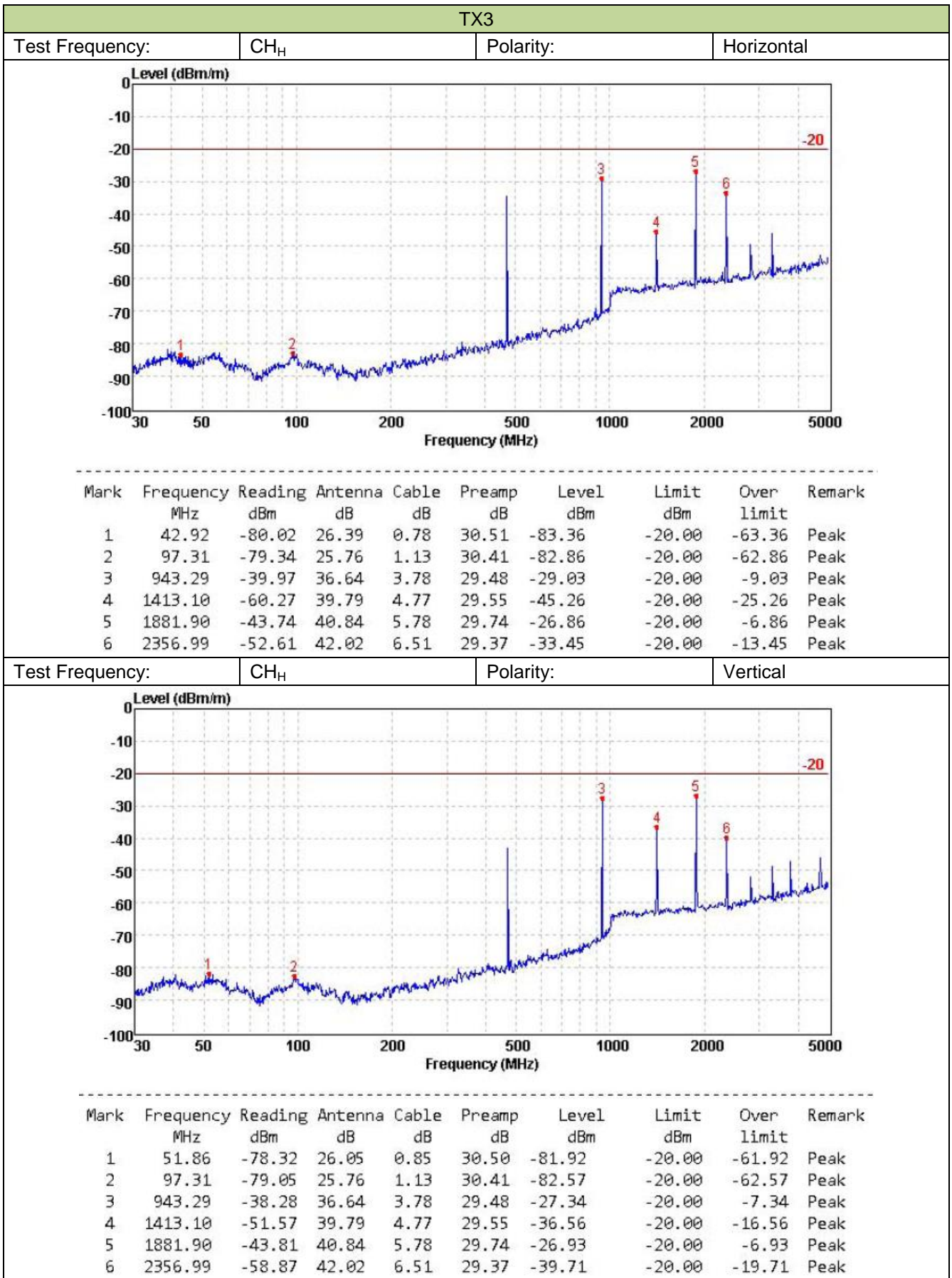

### 5.10. Conducted Emissions

The frequency spectrum from 0.15 MHz to 30 MHz was investigated. The LISN used was 50 ohm / 50 u Henry as specified by section 5.1 of ANSI C63.4-2014. Cables and peripherals were moved to find the maximum emission levels for each frequency.

**Limit**

**FCC part 15.107(a)**

Frequency of Emission (MHz)	Conducted Limit (dBµV)	
	Quasi-peak	Average
0.15-0.5	66 to 56 *	56 to 46 *
0.5-5	56	46
5-30	60	50

**TEST CONFIGURATION**

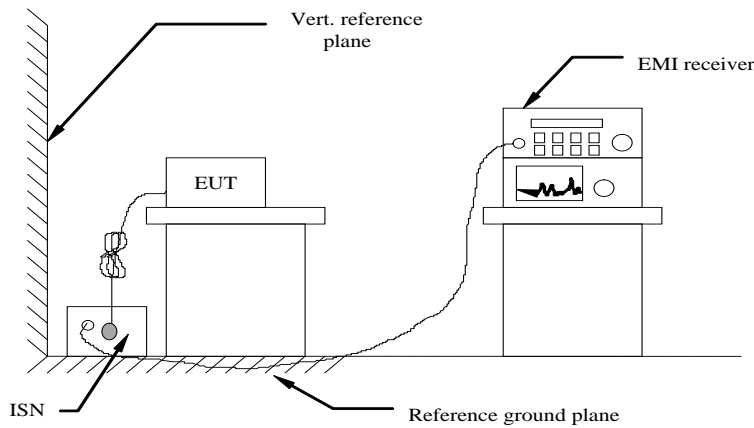

**TEST PROCEDURE**

- 1 The equipment was set up as per the test configuration to simulate typical actual usage per the user’s manual. The EUT is a tabletop system; a wooden table with a height of 0.8 meters is used and is placed on the ground plane as per ANSI C63.4-2014.
- 2 Support equipment, if needed, was placed as per ANSI C63.4-2014.
- 3 All I/O cables were positioned to simulate typical actual usage as per ANSI C63.4-2014.
- 4 If a EUT received AC120V/60Hz power through a Line Impedance Stabilization Network (LISN) which supplied power source and was grounded to the ground plane.
- 5 All support equipments received AC power from a second LISN, if any
- 6 The EUT test program was started. Emissions were measured on each current carrying line of the EUT using a spectrum Analyzer / Receiver connected to the LISN powering the EUT. The LISN has two monitoring points: Line 1 (Hot Side) and Line 2 (Neutral Side). Two scans were taken: one with Line 1 connected to Analyzer / Receiver and Line 2 connected to a 50 ohm load; the second scan had Line 1 connected to a 50 ohm load and Line 2 connected to the Analyzer / Receiver.
- 7 Analyzer / Receiver scanned from 150 kHz to 30MHz for emissions in each of the test modes.
- 8 During the above scans, the emissions were maximized by cable manipulation.

**TEST MODE:**

Please reference to the section 3.4

**TEST RESULTS**

Passed       Not Applicable

### 5.11. Radiated Emission

#### LIMIT

For unintentional device, according to § 15.109(a) except for Class A digital devices, the field strength of radiated emissions from unintentional radiators at a distance of 3 meters shall not exceed the following values:

Frequency (MHz)	Distance (Meters)	Radiated (dBµV/m)	Radiated (µV/m)
30-88	3	40.0	100
88-216	3	43.5	150
216-960	3	46.0	200
Above 960	3	54.0	500

For intentional device, according to § 15.209(a), the general requirement of field strength of radiated emissions from intentional radiators at a distance of 3 meters shall not exceed the above table.

#### TEST CONFIGURATION

(A) Radiated Emission Test Set-Up, Frequency below 1000MHz

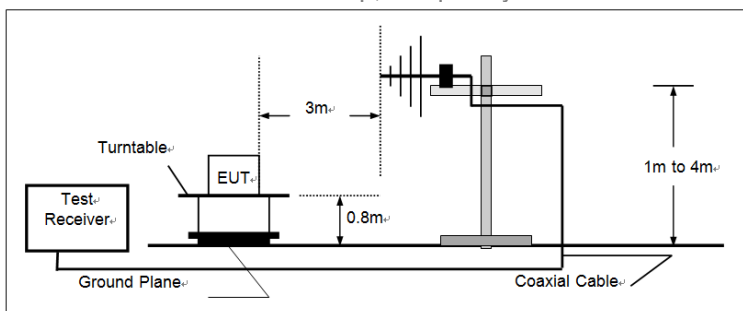

(B) Radiated Emission Test Set-Up, Frequency above 1000MHz

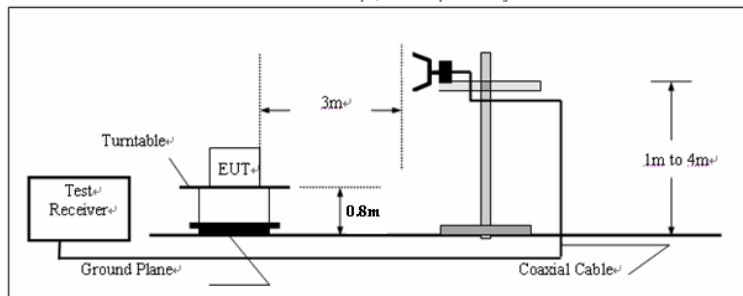

#### TEST PROCEDURE

- 1 The EUT was placed on a turn table which is 0.8m above ground plane.
- 2 Maximum procedure was performed by raising the receiving antenna from 1m to 4m and rotating the turn table from 0° to 360° to acquire the highest emissions from EUT
- 3 And also, each emission was to be maximized by changing the polarization of receiving antenna both horizontal and vertical.
- 4 Repeat above procedures until all frequency measurements have been completed.

#### TEST MODE:

Please reference to the section 3.4

#### TEST RESULTS

Passed       Not Applicable

Note:

1. The EUT shall be scanned from 30 MHz to the 5th harmonic of the highest oscillator frequency in the digital devices or 1 GHz whichever is higher.
2. Have pre-tested RX1 to RX4 mode, record the worst case mode RX1 on the report.



Test Mode:	RX1	Polarity:	Horizontal
------------	-----	-----------	------------

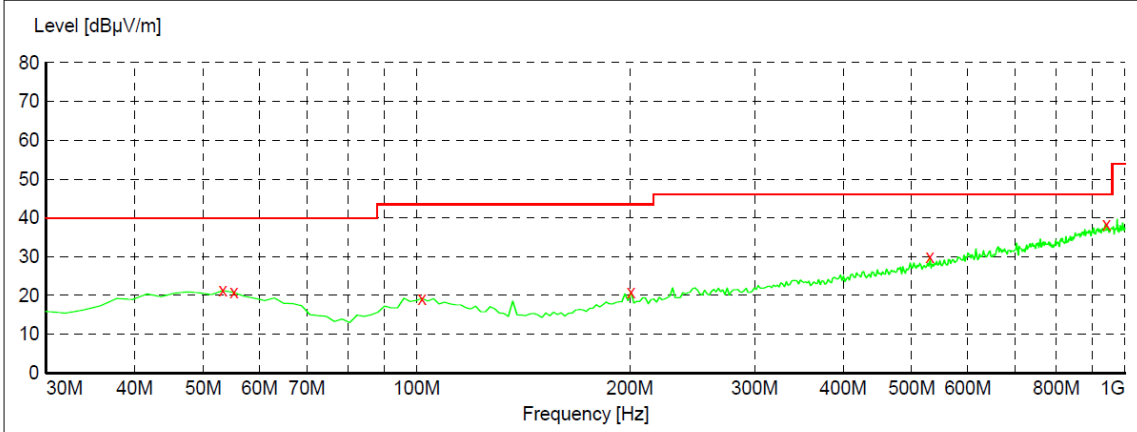

x x MES GM1706206033\_red

Frequency MHz	Level dBµV/m	Transd dB	Limit dBµV/m	Margin dB	Det.	Height cm	Azimuth deg	Polarization
53.280000	21.30	-9.0	40.0	18.7	QP	100.0	187.00	HORIZONTAL
55.220000	20.80	-9.2	40.0	19.2	QP	300.0	80.00	HORIZONTAL
101.780000	19.20	-10.5	43.5	24.3	QP	100.0	157.00	HORIZONTAL
200.720000	20.90	-9.9	43.5	22.6	QP	100.0	360.00	HORIZONTAL
530.520000	29.90	-1.1	46.0	16.1	QP	300.0	242.00	HORIZONTAL
941.800000	38.30	7.2	46.0	7.7	QP	100.0	360.00	HORIZONTAL

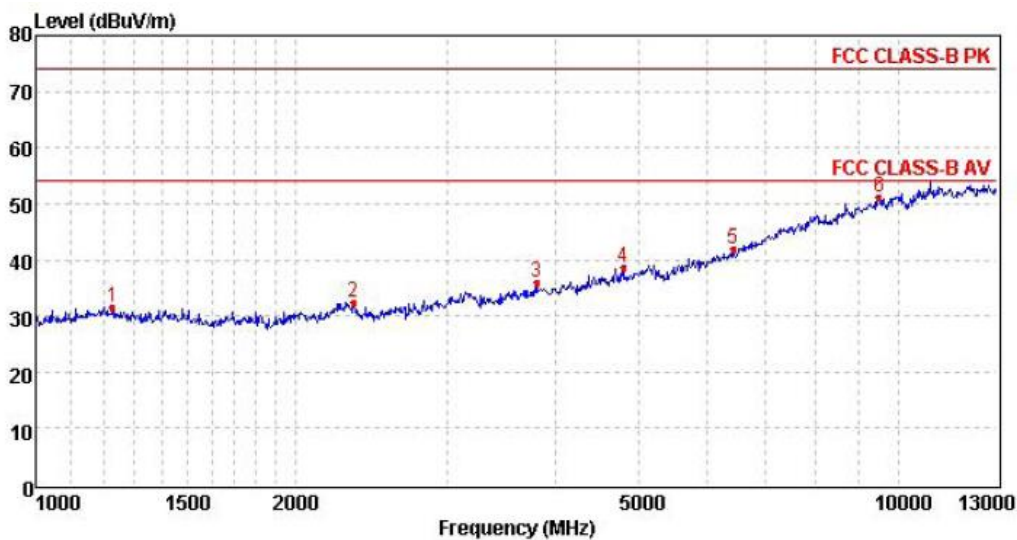

Mark	Frequency MHz	Reading dBuV/m	Antenna dB	Cable dB	Preamp dB	Level dBuV/m	Limit dBuV/m	Over limit	Remark
1	1227.77	37.12	26.27	4.71	36.55	31.55	74.00	-42.45	Peak
2	2337.30	35.67	27.91	6.67	37.72	32.53	74.00	-41.47	Peak
3	3805.09	36.00	29.61	8.51	38.23	35.89	74.00	-38.11	Peak
4	4793.13	34.46	31.57	9.54	36.97	38.60	74.00	-35.40	Peak
5	6437.58	32.74	33.56	11.06	35.32	42.04	74.00	-31.96	Peak
6	9482.62	33.61	39.03	13.71	35.24	51.11	74.00	-22.89	Peak

Test Mode:	RX1	Polarity:	Vertical
------------	-----	-----------	----------

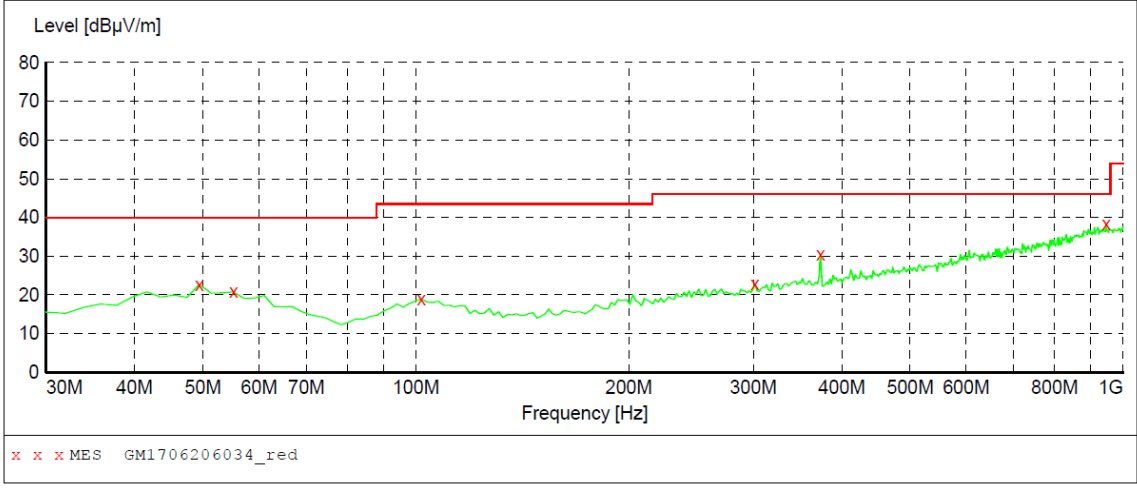

Frequency MHz	Level dBµV/m	Transd dB	Limit dBµV/m	Margin dB	Det.	Height cm	Azimuth deg	Polarization
49.400000	22.70	-8.7	40.0	17.3	QP	100.0	272.00	VERTICAL
55.220000	20.80	-9.2	40.0	19.2	QP	100.0	175.00	VERTICAL
101.780000	19.00	-10.5	43.5	24.5	QP	100.0	204.00	VERTICAL
301.600000	22.80	-7.2	46.0	23.2	QP	100.0	119.00	VERTICAL
373.380000	30.40	-5.3	46.0	15.6	QP	100.0	105.00	VERTICAL
945.680000	38.40	7.2	46.0	7.6	QP	100.0	119.00	VERTICAL

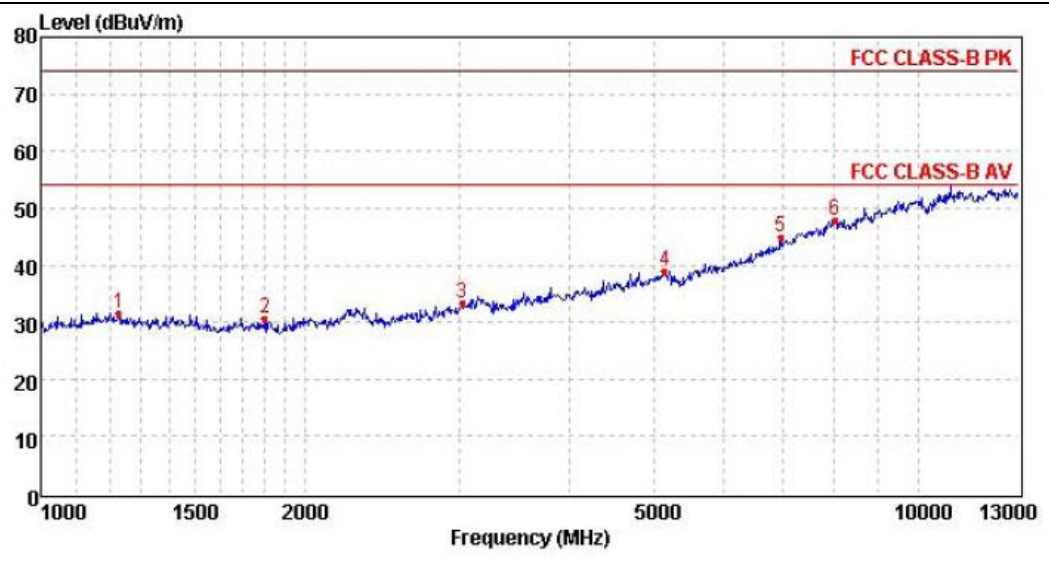

Mark	Frequency MHz	Reading dBuV/m	Antenna dB	Cable dB	Preamp dB	Level dBuV/m	Limit dBuV/m	Over limit	Remark
1	1227.77	37.12	26.27	4.71	36.55	31.55	74.00	-42.45	Peak
2	1799.26	36.45	25.40	5.96	37.14	30.67	74.00	-43.33	Peak
3	3020.71	35.28	28.64	7.50	38.23	33.19	74.00	-40.81	Peak
4	5136.84	33.83	31.75	9.78	36.26	39.10	74.00	-34.90	Peak
5	6970.36	32.68	35.12	11.81	34.82	44.79	74.00	-29.21	Peak
6	8026.42	33.05	37.07	12.36	34.53	47.95	74.00	-26.05	Peak

## 6. Test Setup Photos of the EUT

Transmitter Radiated Spurious Emission:

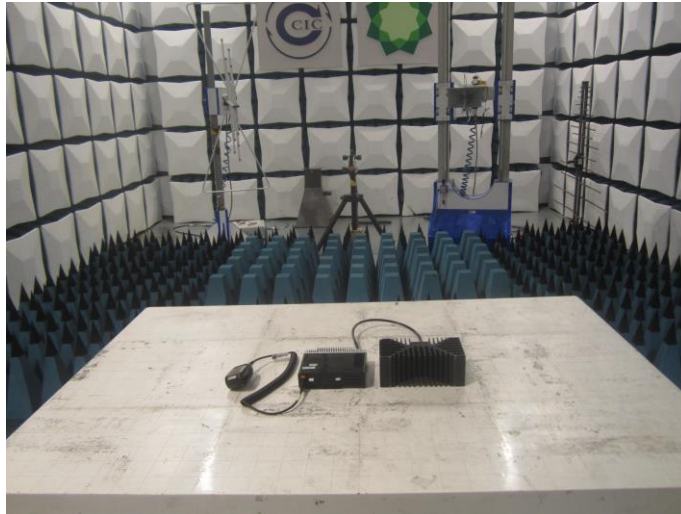

Radiated Emission:

30MHz-1GHz



Above 1GHz

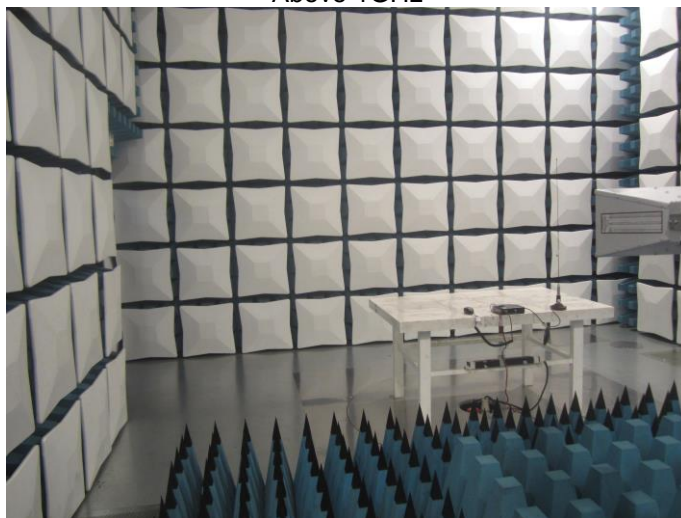

Frequency stability:

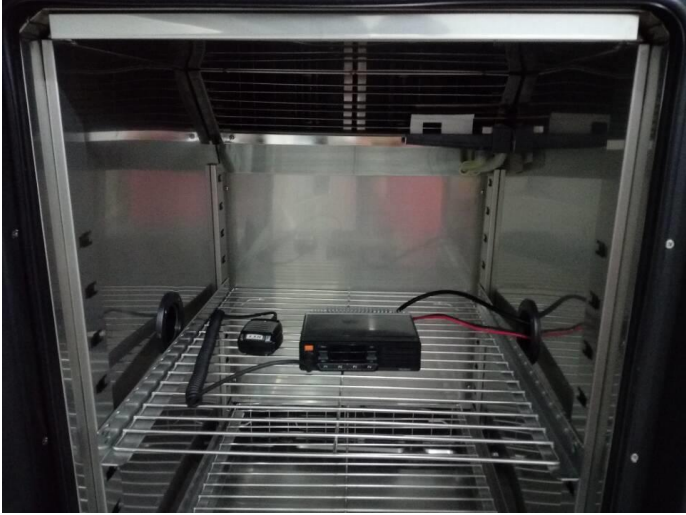

## 7. External and Internal Photos of the EUT

### External Photos of the EUT

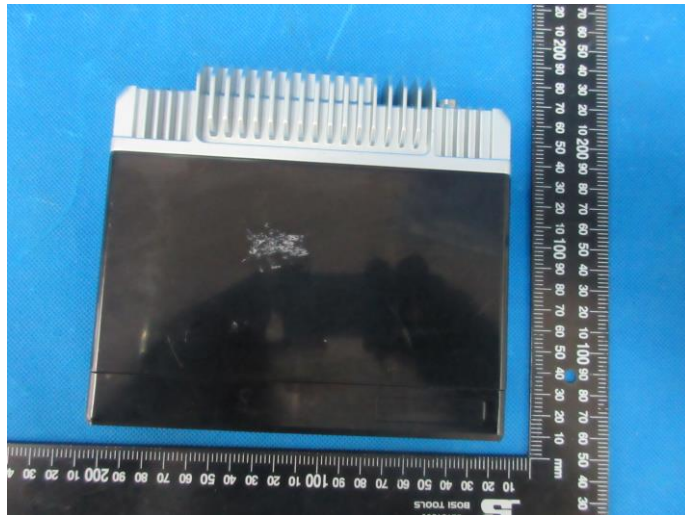
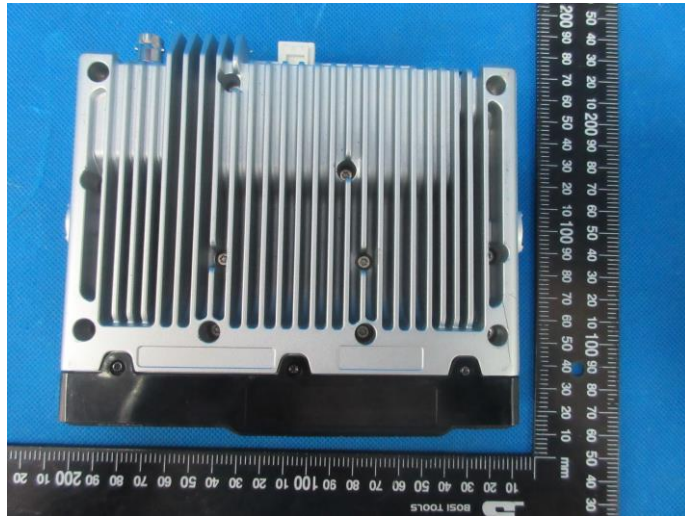



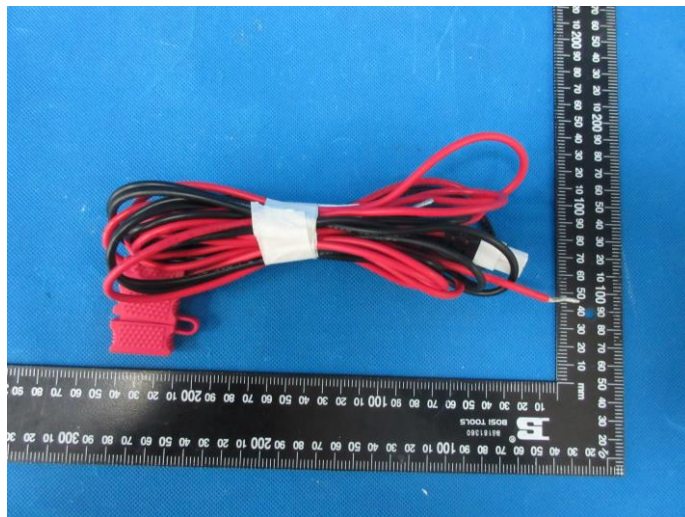

### Internal Photos of the EUT

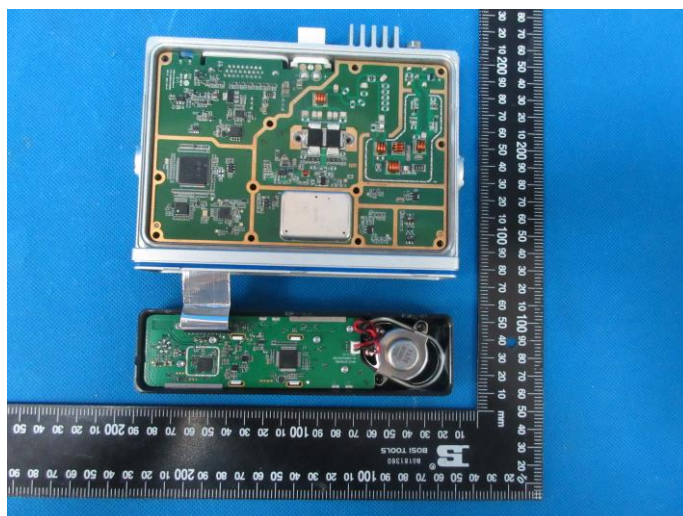
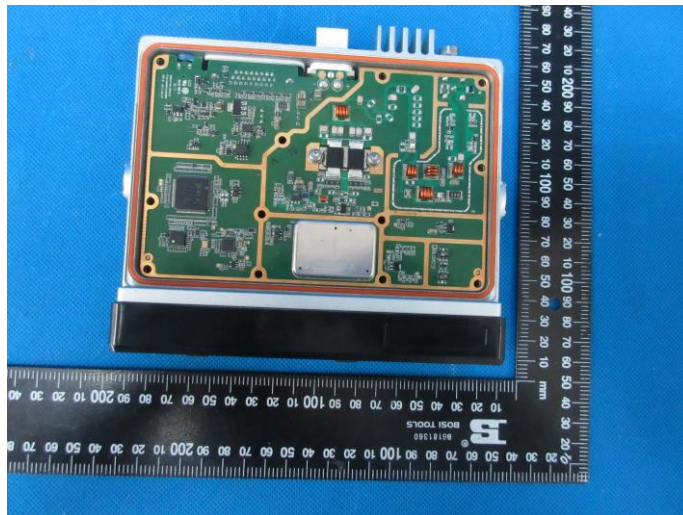
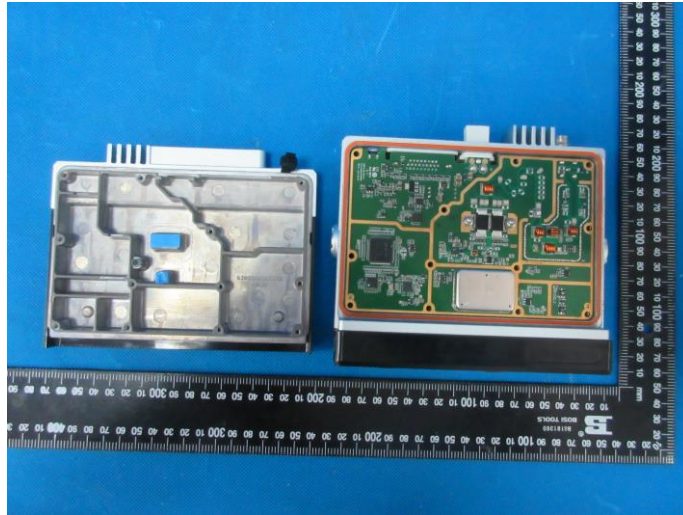



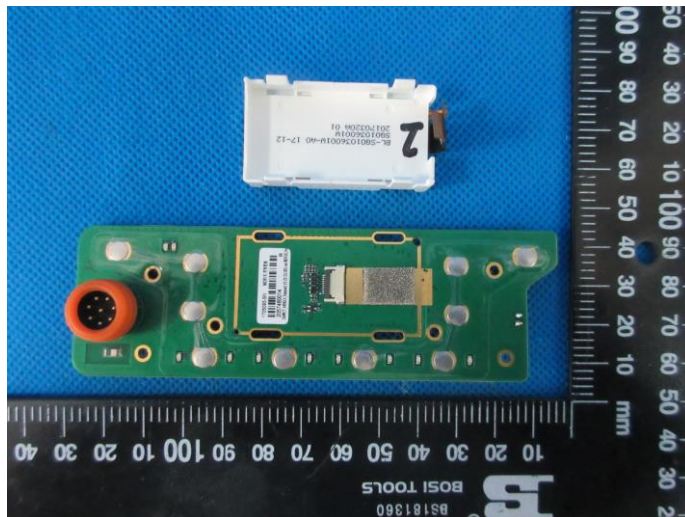
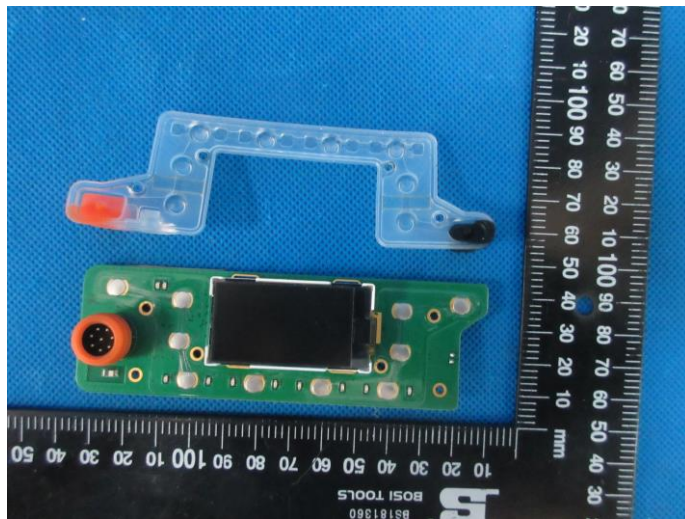
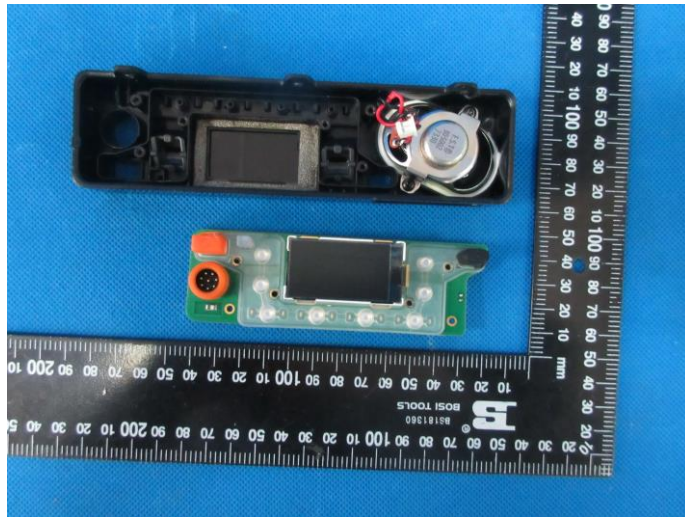

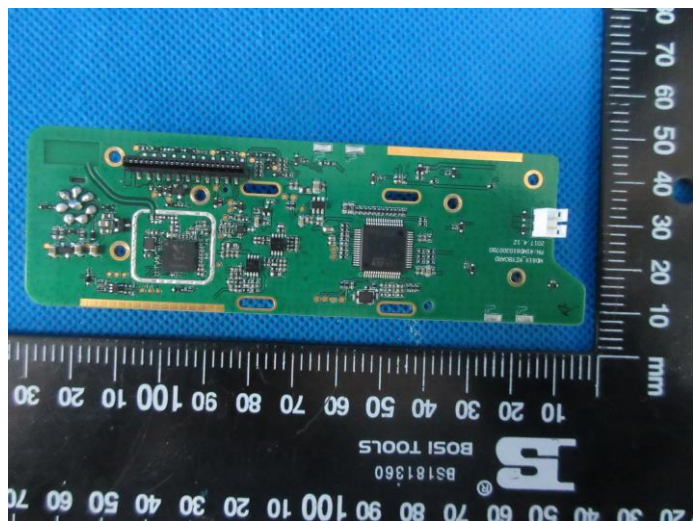
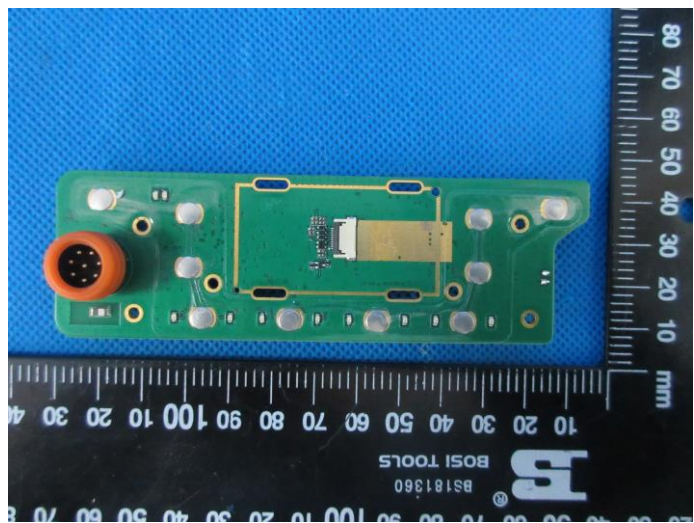
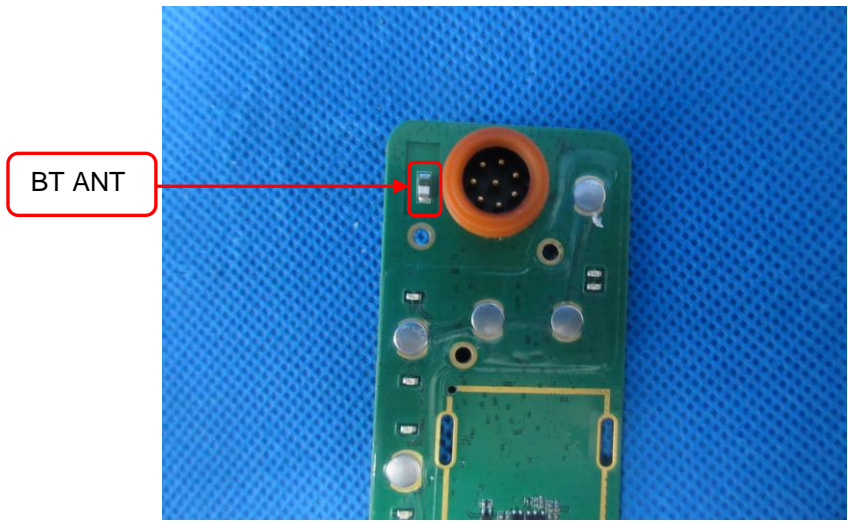

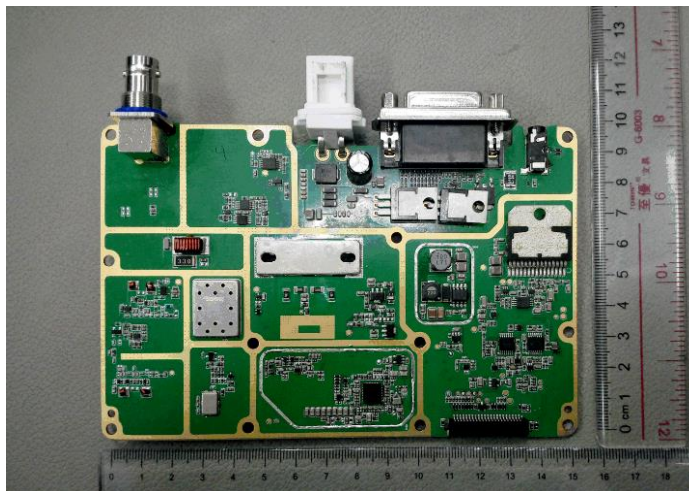
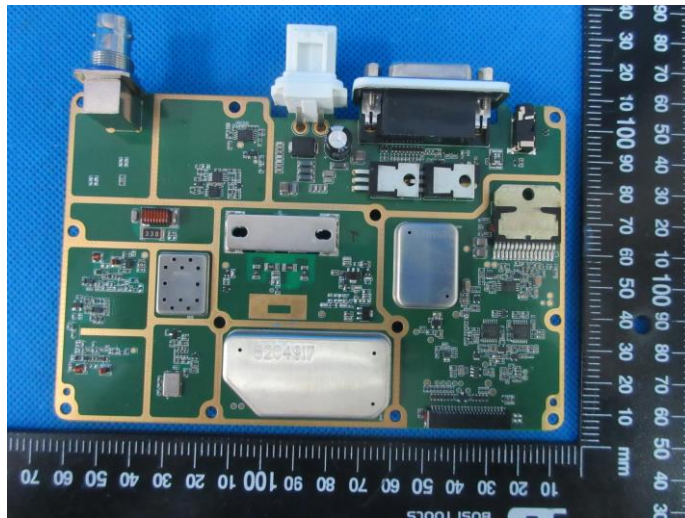
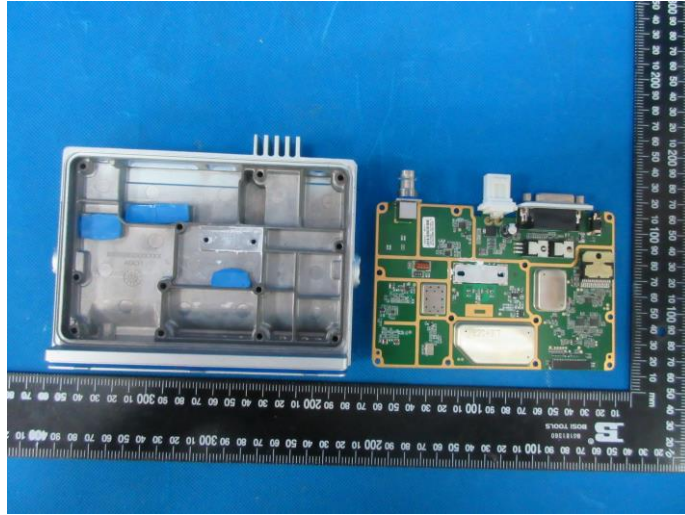

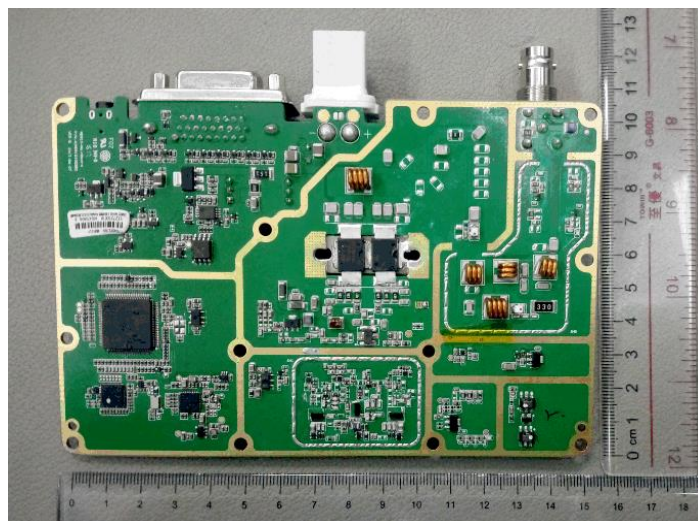
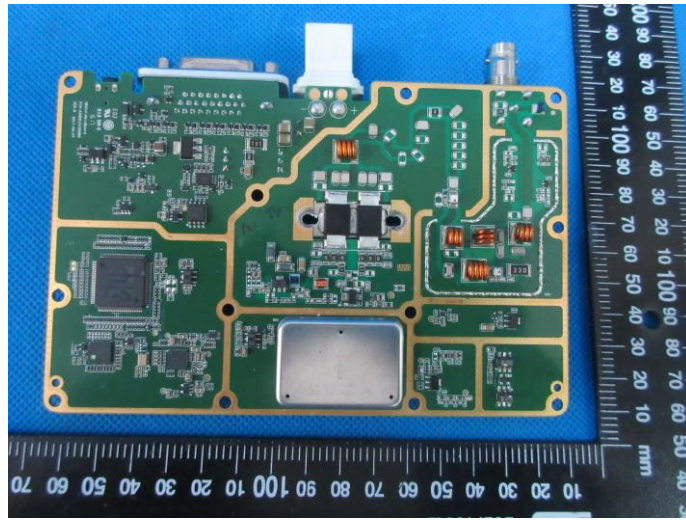

-----End of Report-----