



Test Report No. 9012364472

Applicant: Essence Home and Family Ltd.

Alarm system control panel

Model: M8000C

FCC ID: Y4I-M8000C

***From The Standards Institution
Of Israel
Industry Division
Electronics & Telematics Laboratory
EMC Section***



ACCLASS Accreditation Services

Certificate Number: AT-1359



Report No.: 9012364472

Page 1 of 21 pages

Title: Test on Alarm system control panel

FCC ID: Y4I-M8000C

Model: M8000C

Address:	11 Galgaley Haplada St., POB 2073, Herzliya, Israel
Sample for test selected by:	The customer
The date of tests:	1-4 November 2010

Description of Equipment Under Test (EUT):	Alarm system control panel.
Model:	M8000C
Manufactured by:	Essence Home and Family Ltd.

Reference Documents:

- ❖ CFR 47 FCC: Rules and Regulations; Part 15. "Radio frequency devices";
Subpart B: "Unintentional radiators" (2009).
Section 15.107. "Conducted limits".
Section 15.109. "Radiated emission limits".
Subpart C: "Intentional radiators" (2009).
Section 15.205. "Restricted bands of operations"
Section 15.207. "Conducted limits".
Section 15.209. "Radiated emission limits, general requirements".
"Radiated Emission Limits, Additional Provisions";
Section 15.249. "Operation within the bands 902 – 928 MHz, 2400 – 2483.5 MHz, 5725 – 5875 MHz and 24.0 24.25 GHz".

This Test Report contains 21 pages and may be used only in full.	This Test Report applies only to the specimen tested and may not be applied to other specimens of the same product.
--	---



Report No.: 9012364472

Page 2 of 21 pages

Title: Test on Alarm system control panel

FCC ID: Y4I-M8000C

Model: M8000C

Table of Contents

1. EUT Description and operation	3
1.1. General description:	3
2. Test summary	4
2.1. Potential emission sources:	7
2.2. EUT setup and operation:	7
3. Measurements, examinations and derived results	7
3.1. Location of the Test Site:	7
3.2. Test condition:	7
3.3. Test of field strength emission from intentional radiator	8
3.4. Test of transmitter occupied bandwidth.	14
3.5. Test of conducted emission at main terminal.	15
4. Appendix 1. Test equipment used	17
5. Appendix 2: Antenna Factor and Cable Loss	18

Report No.: 9012364472

Page 3 of 21 pages

Title: Test on Alarm system control panel

FCC ID: Y4I-M8000C

Model: M8000C

1. EUT Description and operation

1.1. General description:

* Note: the customer supplied all information in clause below.

M8000C (hereinafter EUT) is an end-to-end, bi-directional security, safety and home automation system used for communicating with wireless devices at 2425 MHz.

Among other functions, the We.R M8000C, Control Panel also enables communicating with wireless devices at 2.4 GHz, from anywhere in the home or office: Door / Window Transmitters, Keypads / Key Fob Commanders, Passive Infrared Detector, Indoor Video PIR Transmitters, Siren and others accessories.

The We.R M8000C Control Panel is based on We.R's proprietary monitoring platform, which incorporates state-of-the-art communication protocols, authentication software and applications for the maintenance and control of installed units.

Type of modulation:	OQPSK
Antenna type:	Integrated monopole mod. MCANO5018 mfr. MIC
Software version of radio unit	0.1
Hardware version of radio unit	rev.3

The EUT power source: 100 – 230VAC power supply.

The EUT's block diagram is shown in Figures 1

The EUT external and internal views are presented in photos #1.

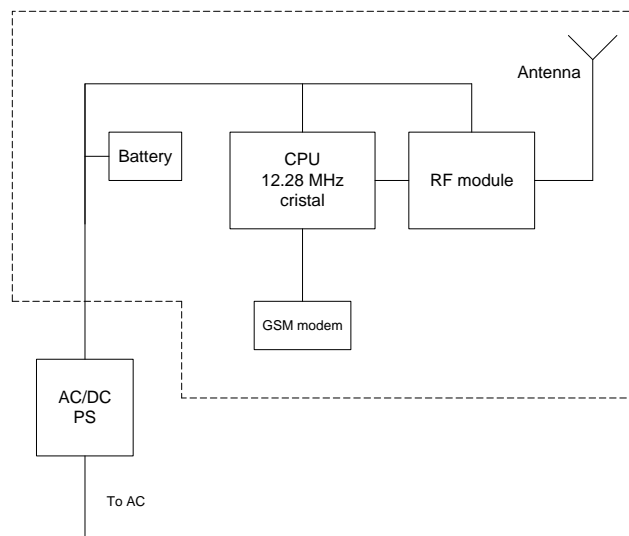

Figure 1. Transmitter block diagram.



Report No.: 9012364472

Page 4 of 21 pages

Title: Test on Alarm system control panel

FCC ID: Y4I-M8000C

Model: M8000C

2. Test summary

Parameter	FCC Part 15 Reference paragraph	Comply/not comply with the requirements
Conducted emission on unintentional radiation	Subpart B Section 15.107	Comply
Radiated emission on unintentional radiation	Subpart B Section 15.109	Comply
Test of field strength emission from intentional radiators	"Radiated Emission Limits, Additional Provisions"; Section 15.249.	Comply
Spurious emission from intentional radiators.	Subpart C Section 15.209	Comply
Conducted emission test on AC main.	Subpart C Section 15.207	Comply

Telematics
Laboratory

December 2010

Name: Eng. Yuri Rozenberg
Position: Head of EMC Branch

Name: Michael Feldman
Position: Test Technician

Measurement uncertainty.

Were relevant, the following measurement uncertainty level have been estimated for tests performed on the EUT as specified in CISPR 16-4-2:

This uncertainty represents an expanded uncertainty expressed at approximately the 95% confidence level using a coverage factor of k=2.

Test description	Expanded uncertainty
<p><u>Radiated emissions</u> in the open field test site at 3 m measuring distance:</p> <p>30 MHz – 1.0 GHz 1.0 GHz – 18 GHz</p>	<p>2 Uc (E) = ± 4.32 dB 2 Uc (E) = ± 4.47 dB</p>

Report No.: 9012364472

Page 5 of 21 pages

Title: Test on Alarm system control panel

FCC ID: Y4I-M8000C

Model: M8000C



Photo 1. EUT's external front and rear view

Report No.: 9012364472

Page 6 of 21 pages

Title: Test on Alarm system control panel

FCC ID: Y4I-M8000C

Model: M8000C



Photo 2. Spurious emissions test setup.

**Report No.:** 9012364472

Page 7 of 21 pages

Title: Test on Alarm system control panel**FCC ID:** Y4I-M8000C**Model:** M8000C

2.1. Potential emission sources:

The potential emission sources are detailed in Table 1.

Table 1. Potential emission sources

Frequency	Location
12.28 MHz	Microcontroller oscillator
2425 MHz	RF signal

2.2. EUT setup and operation:

Respective tests were performed in Transmission (Tx) and Receiving (Rx) modes. Radiated emission test was performed at carrier frequency -2425 MHz. Measurements of transmitter were performed in continue transmission mode.

3. Measurements, examinations and derived results

3.1. Location of the Test Site:

Preliminary radiated test was conducted at the EMC laboratory of the Standards Institution of Israel in Tel-Aviv. Final RE test was conducted in an Open Area Test Site located at Kibbutz Native Halamed Hai in Emek HaEla, Israel.

3.2. Test condition:

Temperature: 23 °C. Humidity: 59 %. Atmospheric pressure: 1009 mbar.

**Report No.:** 9012364472

Page 8 of 21 pages

Title: Test on Alarm system control panel**FCC ID:** Y4I-M8000C**Model:** M8000C

3.3. Test of field strength emission from intentional radiator

Per FCC Part 15 Subpart C Sections 15.109 and Subpart C Sections 15.209, 15.249.

3.3.1. Preliminary radiated emission tests:

Preliminary investigation was performed from the lowest radio frequency signal generated in the equipment and up to ten harmonic of a carrier frequency. Test was conducted in a semi-anechoic chamber at distance 1 and 3 meters. The EUT was setup in its typical configuration and operated in its various modes. For each mode of operation the frequency spectrum was monitored. EUT configuration, cable configuration and mode of operation, which produced the maximum level of emission, were documented. A list of frequencies to be tested was prepared.

3.3.2. Final measurements:

The final radiated emission measurements were performed at the Open Area Test Site at the 3 m test distance. The EUT was operated as described above. The EUT was installed on a turn - table. Biconilog and Double Ridged Guide antennas were used. The measurements were performed at each frequency that founded previously at which the signal level was 10 dB below the limit or less. The levels were maximized by rotating turntable through 360°, changing antenna height and changing antenna-to-EUT polarization from vertical to horizontal. The worse case result was noted in tables.

3.3.3. Radiated emission test results:

Final result measurements are presented in tables and plots ## 1 - 10 in this section. Results that have 20 dB below the limit not noted in the tables.

Report No.: 9012364472

Page 9 of 21 pages

Title: Test on Alarm system control panel

FCC ID: Y4I-M8000C

Model: M8000C

Table 2. Radiated emission result at carrier frequency.

Carrier frequency MHz	Antenna polarization.	Peak ampl. dB μ V/m	Average ampl. dB μ V/m	Specified limit@3m dB μ V/m	Margin dB	Reference to plots #
2425	Vertical	106.3	87.2*	94.0	6.8	1

*Average amplitude was calculated from measured peak (106.3 dB μ V/m) minus average factor (19.1 dB). For average factor calculation refer to plot # 11.

Table 3. Spurious emission results.

Freq. MHz	Antenna polariz. V/H	Turn-table Angle (°)	Antenna Height (m)	QP/Avrg* emission level dB μ V/m	Specified @3m limit, dB μ V/m	Margin dB
34.5	V	43	1.0	35.1	40.0	4.9
41.2	V	40	1.0	32.3	40.0	7.7
70.0	V	140	1.0	30.0	40.0	10.0
162.0	H	64	1.0	31.1	40.0	8.9
4850	V	12	1.0	53.3*	64.0@1m	10.7

3.3.4. Test procedure:

The test was conducted according to requirements of clause 15.249.

3.3.5. Requirements:

Fundamental frequency MHz	Specified field strength limit of fundamental dB μ V/m	Specified field strength limit of harmonics dB μ V/m
2425	94.0*	54.0*

*Limit based on average value. Peak value shall not exceed 20 dB above.

Note: The field strength of emissions radiated on any frequency outside of the specified band, except for harmonics shall be attenuated by at least 50 dB below the level of fundamental or to the general radiated emissions limits in section 15.209 whichever is the lesser attenuation.



Report No.: 9012364472

Page 10 of 21 pages

Title: Test on Alarm system control panel

FCC ID: Y4I-M8000C

Model: M8000C

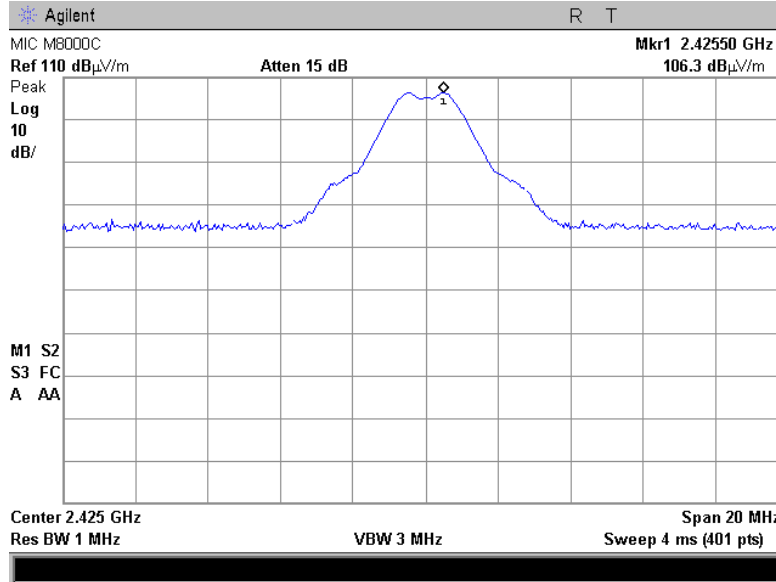

Plot # 1. Field strength of fundamental frequency 2425 MHz.

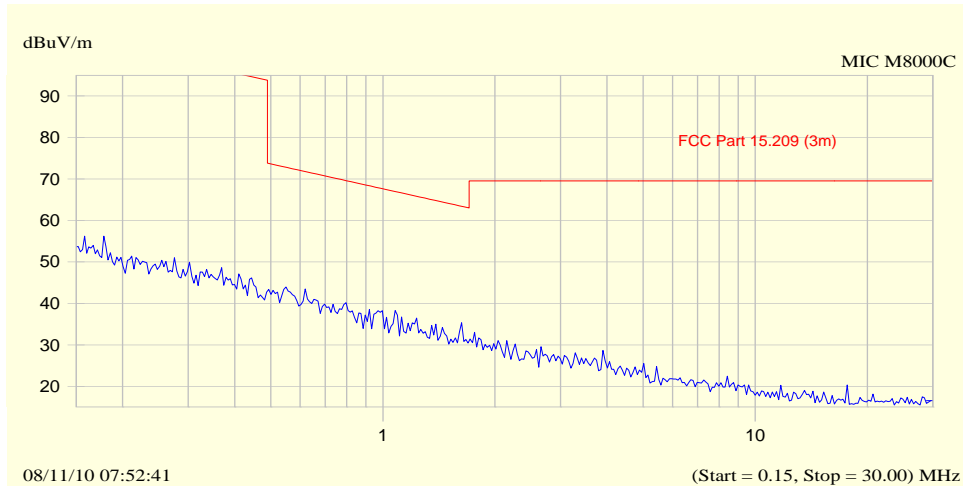

Plot # 2. Spurious emissions scan 0.15 MHz – 30 MHz. Test distance =3m.



Report No.: 9012364472

Page 11 of 21 pages

Title: Test on Alarm system control panel

FCC ID: Y4I-M8000C

Model: M8000C

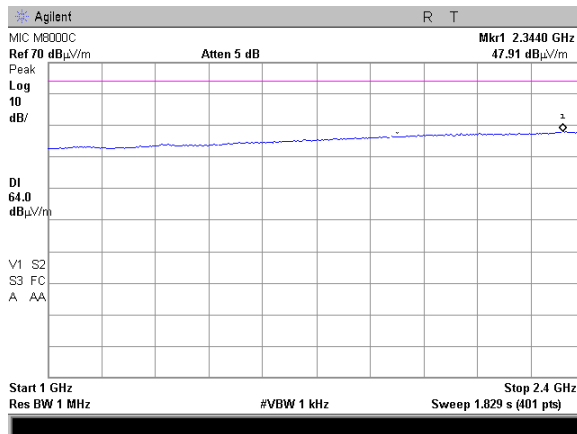

Plot # 3. Emission scan 1 – 2.4 GHz. Average detector

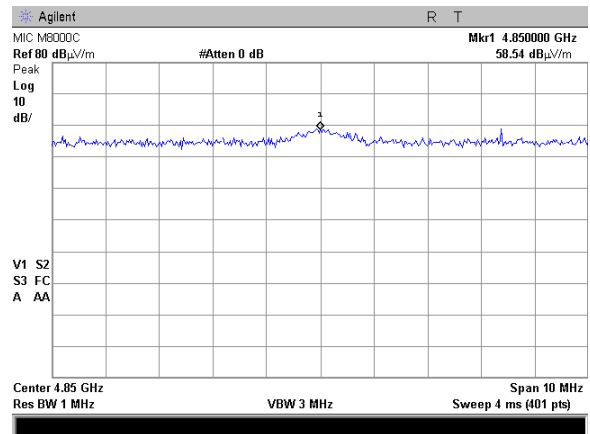

Plot # 4. Second harmonic 4.85 GHz. Peak detector.

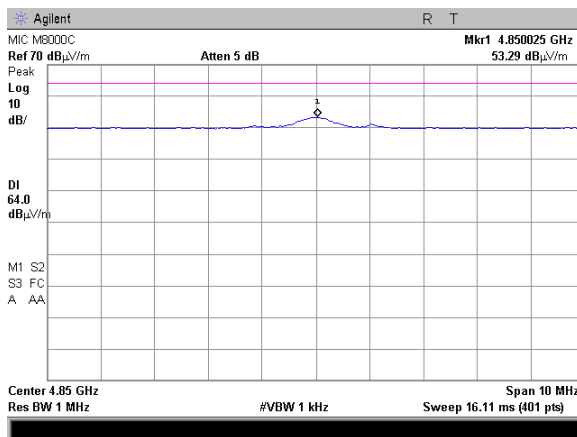

Plot # 5. Second harmonic 4.85 GHz. Average detector.

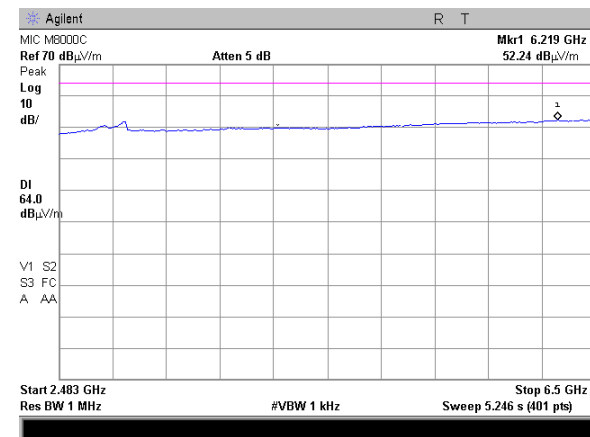

Plot # 6. Emission scan 2.483 – 6.5 GHz. Average detector

Spurious emissions scan 1 GHz – 6.5 GHz. Test distance =1m.



Report No.: 9012364472

Page 12 of 21 pages

Title: Test on Alarm system control panel

FCC ID: Y4I-M8000C

Model: M8000C

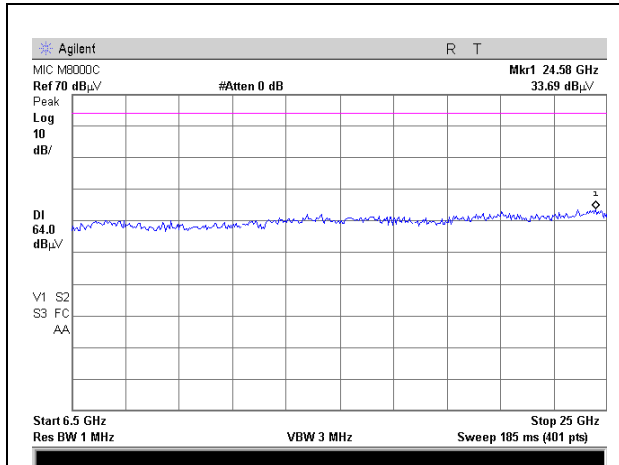

Plot # 7. Emissions scan 6.5 – 25 GHz. Peak detector. Test distance =1m.

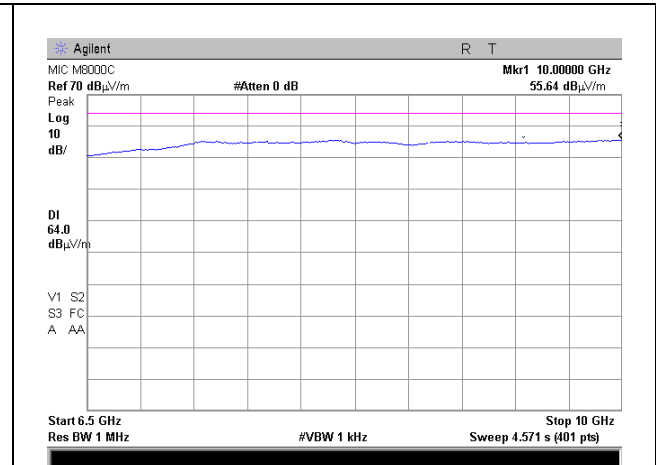

Plot # 8. Emissions scan 6.5 – 10 GHz. Average detector. Test distance =1m.

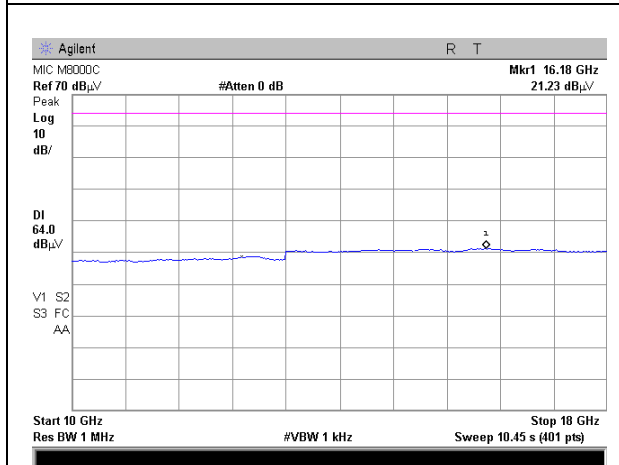

Plot # 9. Emissions scan 10 – 18 GHz. Average detector. Test distance =1m.

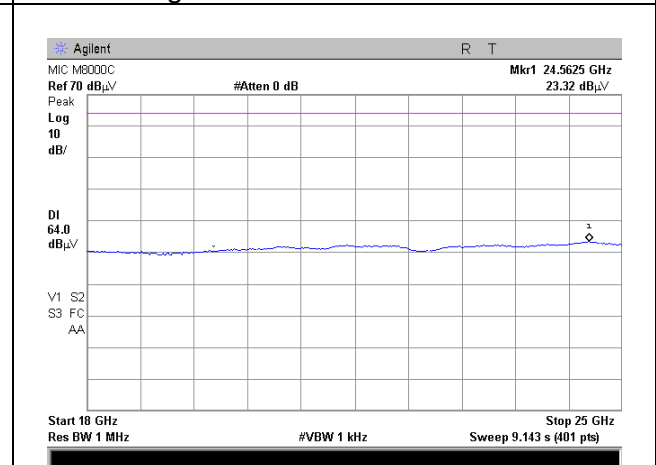

Plot # 10. Emissions scan 18 – 25 GHz. Average detector. Test distance =1m.

Report No.: 9012364472

Page 13 of 21 pages

Title: Test on Alarm system control panel

FCC ID: Y4I-M8000C

Model: M8000C

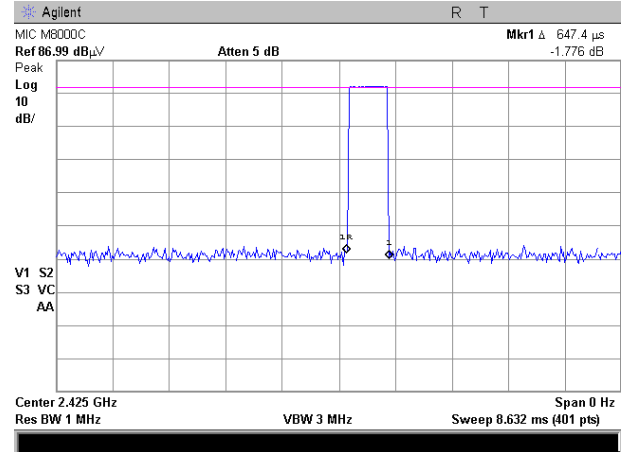
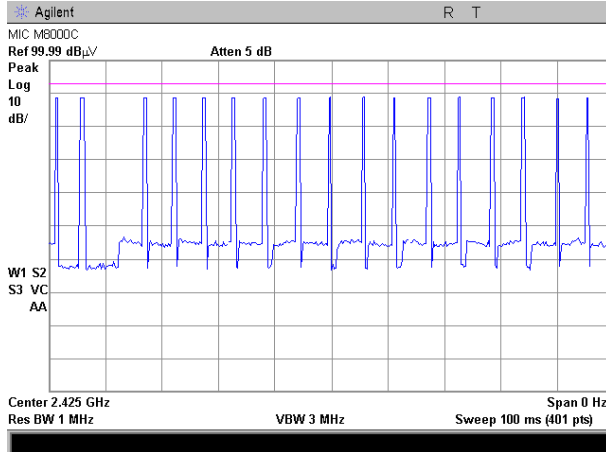

Plot # 11. EUT transmission duty cycle test.

Average factor was calculated from above test as follow: $20\text{Log} (17 \times 0.65 \text{ ms}) / 100 = -19.1 \text{ dB}$.



Report No.: 9012364472

Page 14 of 21 pages

Title: Test on Alarm system control panel

FCC ID: Y4I-M8000C

Model: M8000C

3.4. Test of transmitter occupied bandwidth.

Per FCC part 15.215(c).

3.4.1. Test result:

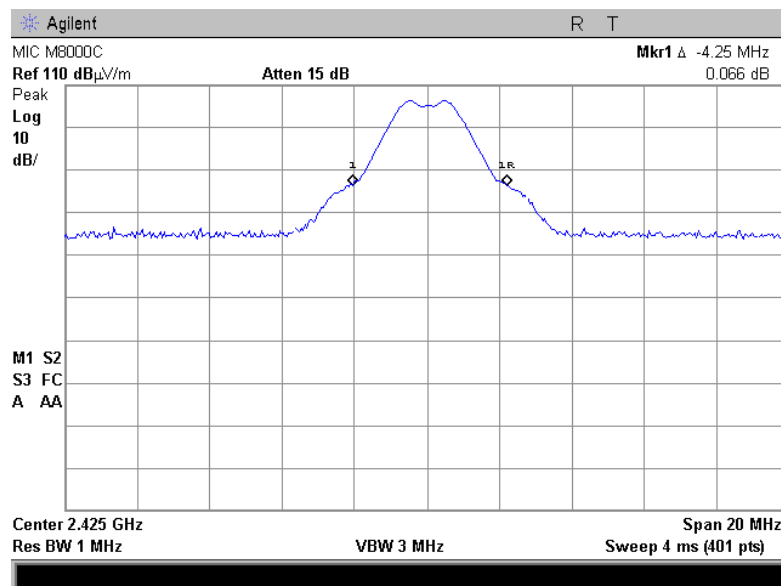

Plot # 12. Occupied bandwidth test result

3.4.2. Requirements:

Intentional radiator must be designed to insure that 20 dB emission bandwidth is contained inside specified frequency band.

3.4.3. Test summary

20 dB occupied bandwidth is 4.25 MHz.
The tested unit meets the standard requirement.

Report No.: 9012364472

Page 15 of 21 pages

Title: Test on Alarm system control panel

FCC ID: Y4I-M8000C

Model: M8000C

3.5. Test of conducted emission at main terminal.

3.5.1. General

Per FCC Part 15 Subpart B clause 15.107 (a) and Subpart C clause 15.207 (a)

3.5.2. Test results:

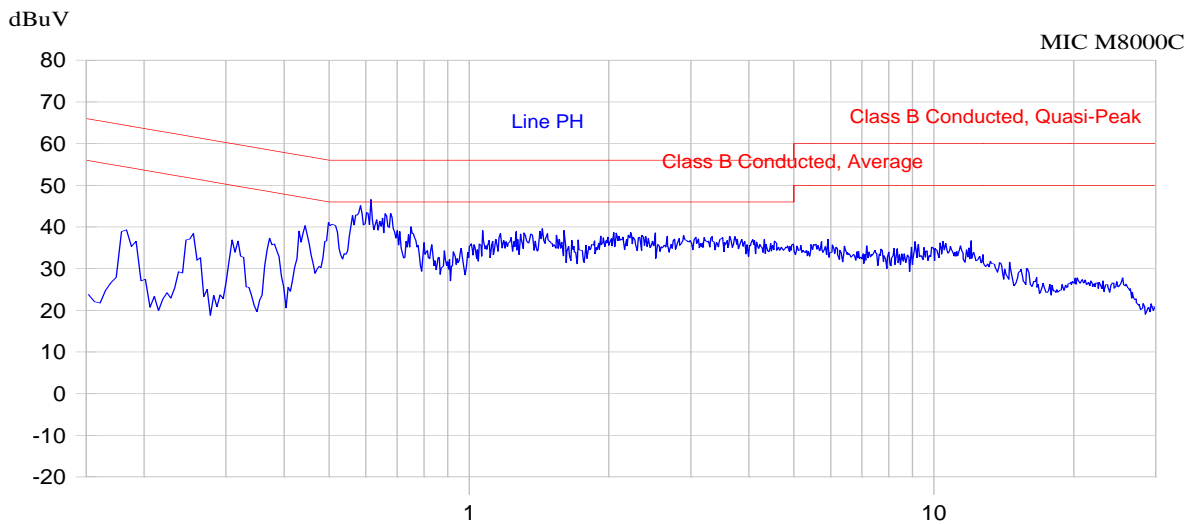

01/11/2010 12:08:03

(Start = 0.15, Stop = 30.00) MHz

Table 4. Test result. Line Phase.

Frequency MHz	QP Ampl. dB μ V	QP Limit dB μ V	Margin dB	Avg Ampl. dB μ V	Average Limit dB μ V	Margin dB
0.314	35.1	59.9	-24.7	24.8	49.9	-25.0
0.371	33.5	58.5	-24.9	22.1	48.5	-26.3
0.442	36.4	57.0	-20.6	24.1	47.0	-22.9
0.514	35.5	56.0	-20.5	21.9	46.0	-24.1
0.622	38.6	56.0	-17.4	25.2	46.0	-20.8
2.232	32.8	56.0	-23.2	19.4	46.0	-26.6

Report No.: 9012364472

Page 16 of 21 pages

Title: Test on Alarm system control panel

FCC ID: Y4I-M8000C

Model: M8000C

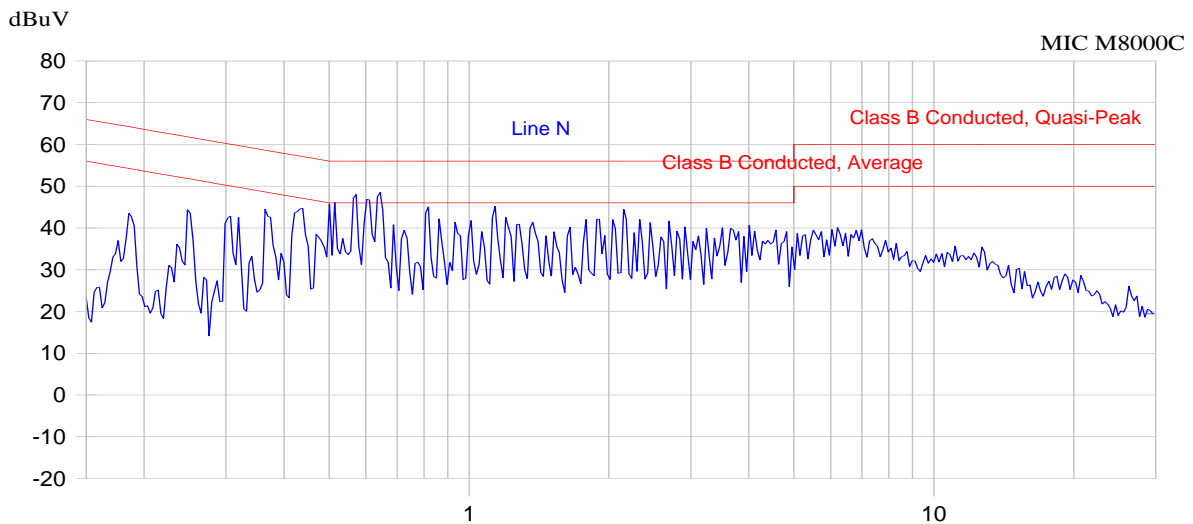

01/11/2010 12:19:33

(Start = 0.15, Stop = 30.00) MHz

Table 5. Test result. Line Neutral.

Frequency MHz	QP Ampl. dB μ V	QP Limit dB μ V	Margin dB	Avg Ampl. dB μ V	Average Limit dB μ V	Margin dB
0.314	43.0	59.9	-16.9	35.2	49.9	-14.7
0.371	41.2	58.5	-17.3	31.6	48.5	-16.9
0.442	43.2	57.0	-13.8	33.2	47.0	-13.9
0.514	42.3	56.0	-13.7	31.0	46.0	-15.0
0.622	45.3	56.0	-10.7	32.5	46.0	-13.5
2.232	37.8	56.0	-18.2	26.9	46.0	-19.1

3.5.3. Test summary:

The tested unit meets the standard requirement.

**Report No.:** 9012364472

Page 17 of 21 pages

Title: Test on Alarm system control panel**FCC ID:** Y4I-M8000C**Model:** M8000C

4. Appendix 1. Test equipment used

All measurements equipment is on SII calibration schedule with a recalibration interval not exceeding one year.

Instrument	MFR	Model	Serial No.	Due calibration date
EMI Receiver 9 kHz – 6.5 GHz	HP	8546A+85460A	SII 4068	April 2011
Biconilog Antenna 30 – 2000 MHz	Teseq GmbH	CBL 6112D	S/N 23181	Sept 2011
EMI Analyser 9 kHz - 26.5 GHz	HP	E7405A	SII 4944	Nov 2010
Antenna Double Ridged Guide, 1-18 GHz	EMCO	3115	SII4873	Sept 2011
Broadband Horn antenna, 15 – 40 GHz	Schwarzbeck Mess- Elektronik	BBHA 9170	9170-341	Oct 2011
Active Loop antenna 10 kHz – 30 MHz	EMCO	6502	SII 4874	Oct. 2011
RF coax cable, 4m	Huber-Suhner	Sucoflex 104PE	21328/4PE	Oct. 2011
RF coax cable, 1m	MMI	X116LCSX10040	10-11-002	April 2011
LISN 9 kHz – 30 MHz	FCC	LISN 250-32-4-16	SII5023	Oct 2011
Transient limiter 0.009-200 MHz	HP	11947A	3107105	Oct 2011
Oscilloscope	HP	54610B	US37340682	May 2011
RF coax cable, 4m	Sucoflex	104PE	21329/4PE	Oct 2011
Antenna Mast	R&S	HCM	100002	N/A
Metallic turntable	R&S	HCT12	100001	N/A
Positioning controller	R&S	HCC	100002	N/A

**Report No.:** 9012364472

Page 18 of 21 pages

Title: Test on Alarm system control panel**FCC ID:** Y4I-M8000C**Model:** M8000C

5. Appendix 2: Antenna Factor and Cable Loss

Cable Loss (10m cable + 6m mast)

Point	Frequency (MHz)	Cable Loss (dB)	Point	Frequency (MHz)	Cable Loss (dB)
1	30	0.53	21	1000	3.68
2	50	0.75	22	1100	3.82
3	100	1.08	23	1200	4.07
4	150	1.39	24	1300	4.24
5	200	1.61	25	1400	4.43
6	250	1.752	26	1500	4.6
7	300	2.00	27	1600	4.7
8	350	2.15	28	1700	4.85
9	400	2.26	29	1800	4.98
10	450	2.383	30	1900	5.19
11	500	2.52	31	2000	5.34
12	550	2.606	32	2100	5.51
13	600	2.75	33	2200	5.69
14	650	2.856	34	2300	5.89
15	700	3.06	35	2400	6.07
16	750	3.20	36	2500	6.22
17	800	3.27	37	2600	6.28
18	850	3.38	38	2700	6.41
19	900	3.46	39	2800	6.53
20	950	3.55	40	2900	6.84



Report No.: 9012364472

Page 19 of 21 pages

Title: Test on Alarm system control panel

FCC ID: Y4I-M8000C

Model: M8000C

**Antenna Factor
For Bilog Antenna, Model Number: CBL 6112D, S/N: 23181**

No.	f / MHz)	AF / dB/m	f / MHz)	AF / dB/m	f / MHz)	AF / dB/m	f / MHz)	AF / dB/m
1	30	17.90	170	9.40	530	17.70	1040	22.20
2	32	16.70	175	9.00	540	18.25	1060	22.50
3	34	15.55	180	8.50	550	18.60	1080	22.50
4	36	14.35	185	8.45	560	14.45	1100	22.40
5	38	13.30	190	8.60	570	18.40	1120	22.60
6	40	12.20	195	8.85	580	18.50	1140	22.45
7	42	11.05	200	8.95	590	18.60	1160	22.50
8	44	9.95	205	8.80	600	18.60	1180	22.40
9	46	8.90	210	8.50	610	18.80	1200	22.80
10	48	8.05	215	8.20	620	18.99	1220	22.95
11	50	7.30	220	8.50	630	19.05	1240	23.10
12	52	6.80	225	9.00	640	19.23	1260	23.40
13	54	6.45	230	9.65	650	19.10	1280	23.35
14	56	6.00	235	10.30	660	19.13	1300	23.62
15	58	5.70	240	11.00	670	19.04	1320	23.64
16	60	5.45	245	11.60	680	19.00	1340	23.86
17	62	5.30	250	12.00	690	19.17	1360	23.95
18	64	5.20	255	12.45	700	19.28	1380	23.90
19	66	5.30	260	12.85	710	19.25	1400	24.45
20	68	5.30	265	12.50	720	19.45	1420	24.74
21	70	5.35	270	12.45	730	19.75	1440	24.93
22	72	5.50	275	12.40	740	19.95	1460	25.03
23	74	5.80	280	12.55	750	20.07	1480	25.45
24	76	6.00	285	12.65	760	19.85	1500	25.30
25	78	6.60	290	12.75	770	19.80	1520	25.25
26	80	6.70	295	12.95	780	19.85	1540	25.36
27	82	7.15	300	13.00	790	19.95	1560	25.58
28	84	7.60	310	13.35	800	20.05	1580	25.50
29	86	8.10	320	13.75	810	20.10	1600	25.65
30	88	8.50	330	13.85	820	20.35	1620	25.60
31	90	8.90	340	14.10	830	20.40	1640	25.70
32	92	9.20	350	14.50	840	20.35	1660	25.83
33	94	9.75	360	14.70	850	20.46	1680	25.97
34	96	9.95	370	14.90	860	20.39	1700	26.10
35	98	10.20	380	15.10	870	20.29	1720	26.25
36	100	10.50	390	15.45	880	20.24	1740	26.04
37	105	11.25	400	16.00	890	20.35	1760	26.14
38	110	11.70	410	16.40	900	20.55	1780	26.20
39	115	11.70	420	16.70	910	20.45	1800	26.40
40	120	11.80	430	16.35	920	20.60	1820	26.64
41	125	11.80	440	16.30	930	20.60	1840	26.86
42	130	11.70	450	16.30	940	20.66	1860	27.12
43	135	11.35	460	16.70	950	20.88	1880	27.00
44	140	10.95	470	17.05	960	21.11	1900	27.25
45	145	10.35	480	17.20	970	20.93	1920	27.36
46	150	10.05	490	17.30	980	21.03	1940	27.68
47	155	9.70	500	17.40	990	21.05	1960	27.10
48	160	9.70	510	17.50	1000	21.10	1980	27.06
49	165	9.45	520	17.60	1020	21.40	2000	27.25



Report No.: 9012364472

Page 20 of 21 pages

Title: Test on Alarm system control panel

FCC ID: Y4I-M8000C

Model: M8000C

Antenna Factor

Double Ridged Guide Antenna mfr EMCO model 3115 1m calibration

Frequency MHz	Antenna Factor (dB/m)	Frequency MHz	Antenna Factor (dB/m)
1000	23.9	11000	38.9
2000	28.3	11000	38.9
3000	31.0	11500	39.6
4000	33.1	12000	39.4
4500	32.5	12500	39.2
5000	32.4	13000	40.3
6000	53.7	13500	41.0
6500	35.6	14000	41.2
7000	36.4	14500	41.3
7500	36.9	15000	40.0
8000	37.0	15500	38.0
8500	38.0	16000	38.1
9000	38.6	16500	40.3
9500	38.4	17000	42.2
10000	38.4	17500	44.6
10500	38.4	18000	46.2

Antenna Factor

Broadband Horn Antenna model BBHA 9170 1m calibration

Point	Frequency (GHz)	Antenna Factor (dB/m)
1	15.0	38.5
2	16.0	37.7
3	17.0	38.1
4	18.0	37.9
5	19.0	38.0
6	20.0	38.0
7	21.0	37.9
8	22.0	38.2
9	23.0	39.6
10	24.0	39.6
11	25.0	39.3
12	26.0	39.5
13	27.0	39.6
14	28.0	39.6
15	30.0	40.1
16	32.0	41.2
17	34.0	41.5
18	35.0	41.9
19	36.0	42.2
20	38.0	43.8
21	40.0	43.2



Report No.: 9012364472

Page 21 of 21 pages

Title: Test on Alarm system control panel

FCC ID: Y4I-M8000C

Model: M8000C

Antenna factor
Active Loop antenna mfr.EMCO mod. 6502 S/N 3424

Frequency (MHz)	Magnetic Antenna factor (dBS/m)	Electric Antenna factor (dB/m)
0.009	-31.46	20.07
0.010	-32.34	19.18
0.020	-36.15	15.38
0.050	-38.57	12.96
0.075	-38.78	12.75
0.100	-39.07	12.46
0.150	-39.07	12.45
0.250	-39.18	12.35
0.500	-39.29	12.24
0.750	-39.38	12.14
1.000	-39.57	11.95
2.000	-39.84	11.69
3.000	-40.09	11.44
4.000	-40.13	11.40
5.000	-40.24	11.28
10.000	-40.26	11.27
15.000	-40.70	10.83
20.000	-41.02	10.51
25.000	-41.94	9.59
30.000	-43.39	8.14

Cable Loss

Type: Sucoflex 104PE; Ser.No.21329/4PE; 4 m length

Point	Frequency GHz	Cable Loss dB
1	0.0-1.0	1.7
2	1.0- 3.5	3.2
3	3.5- 5.5	4.0
4	5.5 - 7.5	4.7
5	7.5 - 9.5	5.3
6	9.5 - 10.5	5.6
7	10.5 - 12.5	6.2
8	12.5 - 14.5	6.8
9	14.5 - 16.5	7.5
10	16.5 - 18.0	8.1