

FCC Test Report

(PART 90 Subpart M)

Report No.: RF150120C04A

FCC ID: XZB-MAXR552-4

Module Model: MaxR-552-4

Device Model: Locomate Commando RSU

Received Date: Oct. 06, 2015

Test Date: Oct. 12 ~ Nov. 05, 2015

Issued Date: Nov. 10, 2015

Applicant: Arada Systems, Inc

Address: 950 Stephenson Highway, Suite 200, Troy, MI 48083 ,USA

Issued By: Bureau Veritas Consumer Products Services (H.K.) Ltd., Taoyuan Branch

Lab Address: No. 47-2, 14th Ling, Chia Pau Vil., Lin Kou Dist., New Taipei City, Taiwan, R.O.C.

Test Location: No. 19, Hwa Ya 2nd Rd., Wen Hwa Vil., Kwei Shan Dist., Taoyuan City 33383, Taiwan, R.O.C.



This report is for your exclusive use. Any copying or replication of this report to or for any other person or entity, or use of our name or trademark, is permitted only with our prior written permission. This report sets forth our findings solely with respect to the test samples identified herein. The results set forth in this report are not indicative or representative of the quality or characteristics of the lot from which a test sample was taken or any similar or identical product unless specifically and expressly noted. Our report includes all of the tests requested by you and the results thereof based upon the information that you provided to us. You have 60 days from date of issuance of this report to notify us of any material error or omission caused by our negligence, provided, however, that such notice shall be in writing and shall specifically address the issue you wish to raise. A failure to raise such issue within the prescribed time shall constitute your unqualified acceptance of the completeness of this report, the tests conducted and the correctness of the report contents. Unless specific mention, the uncertainty of measurement has been explicitly taken into account to declare the compliance or non-compliance to the specification. The report must not be used by the client to claim product certification, approval, or endorsement by TAF or any government agencies

Table of Contents

Release Control Record	3
1 Certificate of Conformity	4
2 Summary of Test Results	5
2.1 Measurement Uncertainty	5
2.2 Test Instruments	6
3 General Information	7
3.1 General Description of EUT	7
3.2 Description of Test Modes	8
3.3 Configuration of System Under Test	8
3.3.1 Description of Support Units	8
3.4 Test Mode Applicability and Tested Channel Detail	9
3.5 EUT Operating Conditions	10
3.6 General Description of Applied Standards	10
4 Test Types and Results	11
4.1 Output Power Measurement	11
4.1.1 Limits of Output Power Measurement	11
4.1.2 Test Procedures	11
4.1.3 Test Setup	12
4.1.4 Test Results	13
4.2 Frequency Tolerance Measurement	24
4.2.1 Limits of Frequency Tolerance Measurement	24
4.2.2 Test Procedure	24
4.2.3 Test Setup	24
4.2.4 Test Results	25
4.3 Emission Bandwidth Measurement	27
4.3.1 Limits of Emission Bandwidth Measurement	27
4.3.2 Test Procedure	27
4.3.3 Test Setup	27
4.3.4 Test Result	28
4.4 Emission Mask Measurement	32
4.4.1 Limits of Emission Mask Measurement	32
4.4.2 Test Procedures	32
4.4.3 Test Setup	32
4.4.4 Test Results	33
4.5 Peak To Average Ratio	43
4.5.1 Limits of Peak To Average Ratio Measurement	43
4.5.2 Test Setup	43
4.5.3 Test Procedures	43
4.5.4 Test Results	44
4.6 Conducted Spurious Emissions	48
4.6.1 Limits of Conducted Spurious Emissions Measurement	48
4.6.2 Test Setup	48
4.6.3 Test Procedure	48
4.6.4 Test Results	49
4.7 Radiated Emission Measurement	85
4.7.1 Limits of Radiated Emission Measurement	85
4.7.2 Test Procedure	85
4.7.3 Deviation from Test Standard	85
4.7.4 Test Setup	85
4.7.5 Test Results	86
5 Pictures of Test Arrangements	106
Appendix – Information on the Testing Laboratories	107



Release Control Record

Issue No.	Description	Date Issued
RF150120C04A	Original release.	Nov. 10, 2015



1 Certificate of Conformity

Product: DSRC Device
Brand: LocoMate
Module Model: MaxR-552-4
Device Model: Locomate Commando RSU
Sample Status: Engineering sample
Applicant: Arada Systems, Inc
Test Date: Oct. 12 ~ Nov. 05, 2015
Standards: FCC Part 90, Subpart M
FCC Part 2

The above equipment has been tested by **Bureau Veritas Consumer Products Services (H.K.) Ltd., Taoyuan Branch**, and found compliance with the requirement of the above standards. The test record, data evaluation & Equipment Under Test (EUT) configurations represented herein are true and accurate accounts of the measurements of the sample's EMC characteristics under the conditions specified in this report.

Prepared by : Suntee Liu , **Date:** Nov. 10, 2015
Suntee Liu / Specialist

Approved by : Ken Liu , **Date:** Nov. 10, 2015
Ken Liu / Senior Manager

2 Summary of Test Results

Applied Standard: FCC Part 90 & Part 2			
FCC Clause	Test Item	Result	Remarks
Part 90.375	Maximum Transmitter Power	PASS	Meet the requirement of limit.
Part 90.377	Effective Isotropic Radiated Power (EIRP)	PASS	Meet the requirement of limit.
Part 90.379	Modulation Characteristic	PASS	Meet the requirement of limit.
Part 90.379	Frequency Tolerance	PASS	Meet the requirement of limit.
Part 90.379	Emission Bandwidth	PASS	Meet the requirement of limit.
Part 90.379	Emission Mask	PASS	Meet the requirement of limit.
---	Peak To Average Ratio	PASS	Meet the requirement of limit.
Part 2.1051	Conducted Spurious Emissions	PASS	Meet the requirement of limit.
Part 2.1053	Radiated Spurious Emissions	PASS	Meet the requirement of limit. Minimum passing margin is -5.5dB at 1594.00MHz.

2.1 Measurement Uncertainty

Where relevant, the following measurement uncertainty levels have been estimated for tests performed on the EUT as specified in CISPR 16-4-2:

Measurement	Frequency	Expanded Uncertainty (k=2) (±)
Radiated Emissions up to 1 GHz	30MHz ~ 200MHz	3.86 dB
	200MHz ~ 1000MHz	3.87 dB
Radiated Emissions above 1 GHz	1GHz ~ 18GHz	2.29 dB
	18GHz ~ 40GHz	2.29 dB



2.2 Test Instruments

Description & Manufacturer	Model No.	Serial No.	Cal. Date	Cal. Due
Test Receiver ROHDE & SCHWARZ	ESIB7	100187	Apr. 10, 2015	Apr. 09, 2016
Spectrum Analyzer ROHDE & SCHWARZ	FSP40	100041	Sep. 02, 2015	Sep. 01, 2016
BILOG Antenna SCHWARZBECK	VULB9168	9168-160	Feb. 05, 2015	Feb. 04, 2016
HORN Antenna SCHWARZBECK	9120D	209	Feb. 09, 2015	Feb. 08, 2016
HORN Antenna SCHWARZBECK	BBHA 9170	BBHA9170241	Feb. 09, 2015	Feb. 08, 2016
Preamplifier Agilent	8447D	2944A10738	Oct. 18, 2014	Oct. 17, 2015
			Oct. 18, 2015	Oct. 17, 2016
Preamplifier Agilent	8449B	3008A01964	Aug. 22, 2015	Aug. 21, 2016
RF signal cable HUBER+SUHNER	SUCOFLEX 104	Cable-CH3-03 (214378)	Aug. 22, 2015	Aug. 21, 2016
RF signal cable HUBER+SUHNER	SUCOFLEX 106	Cable-CH3-03 (309224+12738)	Aug. 22, 2015	Aug. 21, 2016
Software BV ADT	ADT_Radiated_ V7.6.15.9.4	NA	NA	NA
Antenna Tower inn-co GmbH	MA 4000	013303	NA	NA
Antenna Tower Controller BV ADT	AT100	AT93021702	NA	NA
Turn Table BV ADT	TT100	TT93021702	NA	NA
Turn Table Controller BV ADT	SC100	SC93021702	NA	NA
Mini-Circuits Power Splitter	ZN2PD-9G	NA	Jun. 09, 2015	Jun. 08, 2016
JFW 20dB attenuation	50HF-020-SMA	NA	NA	NA

- Note:
1. The calibration interval of the above test instruments is 12 months and the calibrations are traceable to NML/ROC and NIST/USA.
 2. The test was performed in HwaYa Chamber 3.
 3. The horn antenna and preamplifier (model: 8449B) are used only for the measurement of emission frequency above 1GHz if tested.
 4. The FCC Site Registration No. is 988962.
 5. The IC Site Registration No. is IC 7450F-3.

3 General Information

3.1 General Description of EUT

Product	DSRC Device
Brand	LocoMate
Module Model	MaxR-552-4
Device Model	Locomate Commando RSU
Status of EUT	Engineering sample
Power Supply Rating	3.3Vdc (host equipment)
Modulation Type	OFDM, BPSK, QPSK, 16QAM, 64QAM
RSU Class	Channel Bandwidth 10MHz: RSU class C Channel Bandwidth 20MHz: RSU class B
Data Rate	Channel Bandwidth 10MHz: 3, 4.5, 6, 9, 12, 18, 24, 27Mbps Channel Bandwidth 20MHz: 6, 9, 12, 18, 24, 36, 48, 54Mbps
Operating Frequency	Channel Bandwidth 10MHz: 5860MHz~5920MHz Channel Bandwidth 20MHz: 5875MHz~5905MHz
Number of Channel	Channel Bandwidth 10MHz: 7 Channel Bandwidth 20MHz: 2
Max. EIRP Power	Channel Bandwidth 10MHz: 26.90dBm (0.490W) Channel Bandwidth 20MHz: 19.21dBm (0.083W)
Antenna Type	Dipole antenna with 12dBi gain
Accessory Device	NA
Data Cable Supplied	NA

Note:

1. This report is issued as a supplementary report of BV ADT report No.: RF150120C04. This report is prepared for FCC class II permissive change. The differences compared with original report are changing product name, brand and adding a platform (End Product name: DSRC Device, Brand: LocoMate, Model: Locomate Commando RSU) which 2 modules are collocated in. 2 modules can not transmit simultaneously. All test items are retested in this report.
2. The above EUT information is declared by manufacturer and for more detailed features description, please refer to the manufacturer's specifications or User's Manual.

3.2 Description of Test Modes

7 channels are for the Channel Bandwidth 10MHz bandwidth of EUT:

Channel	Frequency (MHz)
172	5860
174	5870
176	5880
178	5890
180	5900
182	5910
184	5920

2 channels are for the Channel Bandwidth 20MHz bandwidth of EUT:

Channel	Frequency (MHz)
175	5875
181	5905

3.3 Configuration of System Under Test

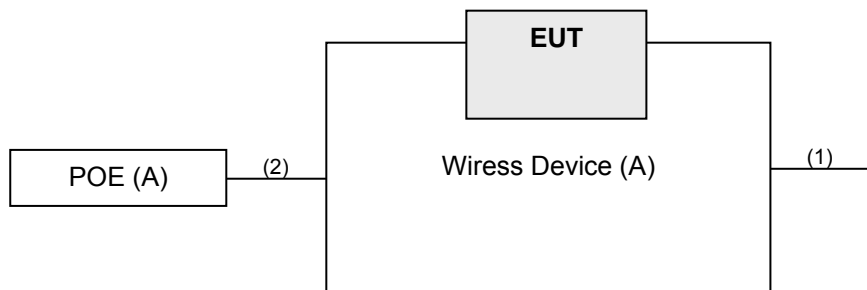

3.3.1 Description of Support Units

The EUT has been tested as an independent unit together with other necessary accessories or support units. The following support units or accessories were used to form a representative test configuration during the tests.

ID	Product	Brand	Model No.	Serial No.	FCC ID	Remarks
A.	Wireless Device	ARADA SYSTEMS	Locomate Commando RSU	NA	FCC DoC Approved	Provided by manufacturer
B.	POE	Gigabit	PI-100GH	NA	FCC DoC Approved	Provided by manufacturer

Note: All power cords of the above support units are non-shielded (1.8m).

ID	Descriptions	Qty.	Length (m)	Shielding (Yes/No)	Cores (Qty.)	Remarks
1.	LAN to RS232	1	1.3	N	0	Provided by manufacturer
2.	RJ45	1	5	N	0	-

3.4 Test Mode Applicability and Tested Channel Detail

Pre-Scan has been conducted to determine the worst-case mode from all possible combinations between available modulations, data rates, XYZ axis and antenna ports.

The worst case was found when positioned on Z-plane. Following channel(s) was (were) selected for the final test as listed below:

EUT Configure Mode	Description
A	Antenna 1
B	Antenna 2

EUT Configure Mode	Test Item	Channel Bandwidth (MHz)	Tested Channel	Data Rate (Mbps)
A, B	Maximum Transmitter Power	10	172, 174, 176, 178, 180, 182, 184	3, 27
		20	175, 181	6, 54
A, B	Effective Isotropic Radiated Power (EIRP)	10	172, 174, 176, 178, 180, 182, 184	3, 27
		20	175, 181	6, 54
A, B	Frequency Tolerance	10	184	3
A, B	Emission Bandwidth	10	172, 174, 176, 178, 180, 182, 184	3, 27
		20	175, 181	6, 54
A, B	Emission Mask	10	172, 174, 176, 178, 180, 182, 184	3, 27
		20	175, 181	6, 54
A, B	Peak To Average Ratio	10	172, 174, 176, 178, 180, 182, 184	3, 27
		20	175, 181	6, 54
A, B	Conducted Spurious Emissions	10	172, 174, 176, 178, 180, 182, 184	3, 27
		20	175, 181	6, 54
A, B	Radiated Spurious Emissions (Frequency range below 1GHz)	10	184	3
		20	175	6
A, B	Radiated Spurious Emissions (Frequency range above 1GHz)	10	172, 174, 176, 178, 180, 182, 184	3, 27
		20	175, 181	6, 54

Test Condition:

Test Item	Environmental Conditions	Input Power	Tested By
Maximum Transmitter Power	24 deg. C, 64% RH	120Vac	Match Tsui
Effective Isotropic Radiated Power (EIRP)	18 deg. C, 70% RH	120Vac	Nick Hsu
Frequency Tolerance	24 deg. C, 64% RH	120Vac	Match Tsui
Emission Bandwidth	24 deg. C, 64% RH	120Vac	Match Tsui
Emission Mask	24 deg. C, 64% RH	120Vac	Match Tsui
Peak To Average Ratio	24 deg. C, 64% RH	120Vac	Match Tsui
Conducted Spurious Emissions	24 deg. C, 64% RH	120Vac	Match Tsui
Radiated Emission	18 deg. C, 70% RH	120Vac	Nick Hsu Jones Chang

3.5 EUT Operating Conditions

The EUT makes a call to the communication simulator. The communication simulator station system controlled a EUT to export maximum output power under transmission mode and specific channel frequency.

3.6 General Description of Applied Standards

The EUT is a RF Product. According to the specifications of the manufacturer, it must comply with the requirements of the following standards:

FCC 47 CFR Part 2

FCC 47 CFR Part 90

KDB 971168 D01 Power Meas License Digital Systems v02r02

ANSI/TIA/EIA-603-D 2010

NOTE: All test items have been performed and recorded as per the above standards.

4 Test Types and Results

4.1 Output Power Measurement

4.1.1 Limits of Output Power Measurement

RSU class	Conducted Power (dBm)
A	0
B	10
C	20
D	28.8

Frequency Range	Channel	Bandwidth (MHz)	EIRP (dBm)
5850-5855	170		Reserved
5855-5865	172	5 /10	33
5865-5875	174	5 /10	33
5875-5885	176	5 /10	33
5885-5895	178	5 /10	33/44.8
5895-5905	180	5 /10	23
5905-5915	182	5 /10	23
5915-5925	184	5 /10	33/40
5865-5885	175	20	23
5895-5915	181	20	23

4.1.2 Test Procedures

EIRP / ERP Measurement:

- The EUT was set up for the maximum power with data modulation. The power was measured with Agilent Spectrum Analyzer. All measurements were done at 1 channel.
- Substitution method is used for E.I.R.P measurement. In the semi-anechoic chamber, EUT placed on the 0.8m height of Turn Table, rotated the table around 360 degrees to search the maximum radiation power and receiver antenna shall be rotated vertical and horizontal polarization and moved height from 1m to 4m to find the maximum polar radiated power. The "Read Value" is the spectrum reading the maximum power value.
- The substitution horn antenna is substituted for EUT at the same position and signals generator export the CW signal to the substitution antenna via a TX cable. Rotated the Turn Table and moved receiving antenna to find the maximum radiation power. Adjust output power level of S.G to get a Value of spectrum reading equal to "Read Value" of step b. Record the power level of S.G
- $EIRP = \text{Output power level of S.G} - \text{TX cable loss} + \text{Antenna gain of substitution horn}$. E.R.P power can be calculated form E.I.R.P power by subtracting the gain of dipole, $E.R.P \text{ power} = E.I.R.P \text{ power} - 2.15\text{dBi}$.

Conducted Power Measurement:

The EUT was set up for the maximum power with data modulation and link up with simulator. Set the EUT to transmit under low, middle and high channel and record the power level shown on simulator.

4.1.3 Test Setup

EIRP / ERP MEASUREMENT

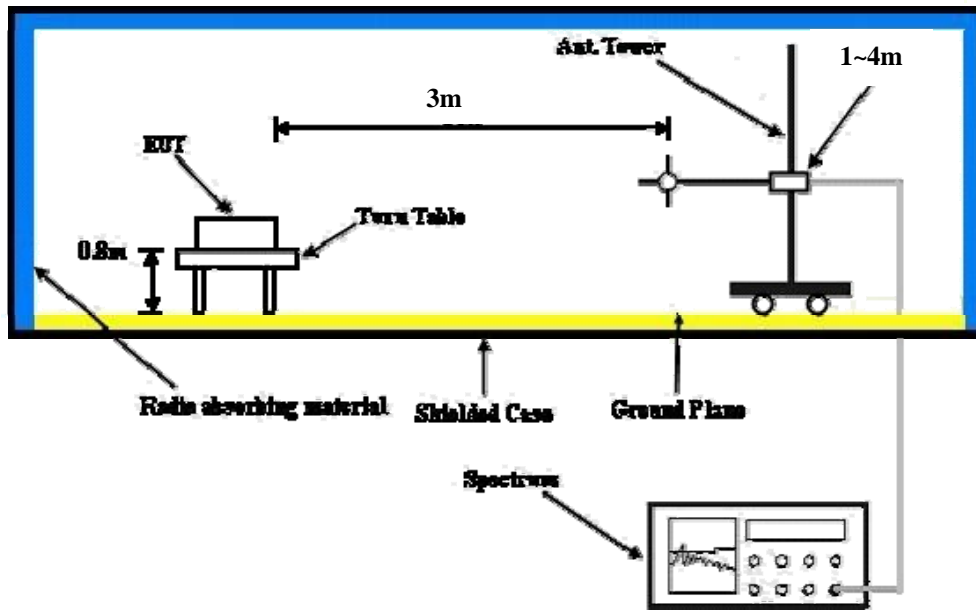

For the actual test configuration, please refer to the attached file (Test Setup Photo).

CONDUCTED POWER MEASUREMENT:



For the actual test configuration, please refer to the attached file (Test Setup Photo).

4.1.4 Test Results

Conducted Output Power (dBm)

Mode A

Channel Bandwidth 10MHz

Data Rate (Mbps)	Channel	Frequency (MHz)	Power (dBm)
3	172	5860	16.95
	174	5870	16.90
	176	5880	16.85
	178	5890	16.81
	180	5900	10.76
	182	5910	10.46
	184	5920	15.28
27	172	5860	15.42
	174	5870	16.34
	176	5880	16.35
	178	5890	16.33
	180	5900	10.40
	182	5910	10.03
	184	5920	14.23

Channel Bandwidth 20MHz

Data Rate (Mbps)	Channel	Frequency (MHz)	Power (dBm)
6	175	5875	8.62
	181	5905	9.40
54	175	5875	8.72
	181	5905	9.14

Mode B

Channel Bandwidth 10MHz

Data Rate (Mbps)	Channel	Frequency (MHz)	Power (dBm)
3	172	5860	17.26
	174	5870	17.06
	176	5880	16.83
	178	5890	16.61
	180	5900	10.29
	182	5910	10.99
	184	5920	14.80
27	172	5860	15.42
	174	5870	16.34
	176	5880	16.35
	178	5890	16.33
	180	5900	10.40
	182	5910	10.03
	184	5920	14.23

Channel Bandwidth 20MHz

Data Rate (Mbps)	Channel	Frequency (MHz)	Power (dBm)
6	175	5875	9.87
	181	5905	9.48
54	175	5875	8.72
	181	5905	9.14

EIRP Power (dBm)

Mode A

Channel Bandwidth 10MHz, Data Rate 3Mbps

Mode		TX channel 172					
Antenna Polarity & Test Distance: Horizontal at 3 M							
No.	Freq. (MHz)	Reading (dBm)	S.G Power Value (dBm)	Correction Factor (dB)	EIRP (dBm)	Limit (dBm)	Margin (dB)
1	5860.00	-41.92	9.54	0.68	10.22	33.00	-22.78
Antenna Polarity & Test Distance: Vertical at 3 M							
No.	Freq. (MHz)	Reading (dBm)	S.G Power Value (dBm)	Correction Factor (dB)	EIRP (dBm)	Limit (dBm)	Margin (dB)
1	5860.00	-24.20	25.67	0.68	26.35	33.00	-6.65

Mode		TX channel 174					
Antenna Polarity & Test Distance: Horizontal at 3 M							
No.	Freq. (MHz)	Reading (dBm)	S.G Power Value (dBm)	Correction Factor (dB)	EIRP (dBm)	Limit (dBm)	Margin (dB)
1	5870.00	-41.09	10.42	0.68	11.10	33.00	-21.90
Antenna Polarity & Test Distance: Vertical at 3 M							
No.	Freq. (MHz)	Reading (dBm)	S.G Power Value (dBm)	Correction Factor (dB)	EIRP (dBm)	Limit (dBm)	Margin (dB)
1	5870.00	-24.88	25.02	0.68	25.70	33.00	-7.30

Mode		TX channel 176					
Antenna Polarity & Test Distance: Horizontal at 3 M							
No.	Freq. (MHz)	Reading (dBm)	S.G Power Value (dBm)	Correction Factor (dB)	EIRP (dBm)	Limit (dBm)	Margin (dB)
1	5880.00	-42.25	9.32	0.68	10.00	33.00	-23.00
Antenna Polarity & Test Distance: Vertical at 3 M							
No.	Freq. (MHz)	Reading (dBm)	S.G Power Value (dBm)	Correction Factor (dB)	EIRP (dBm)	Limit (dBm)	Margin (dB)
1	5890.00	-25.13	24.82	0.68	25.50	33.00	-7.50

Mode		TX channel 178					
Antenna Polarity & Test Distance: Horizontal at 3 M							
No.	Freq. (MHz)	Reading (dBm)	S.G Power Value (dBm)	Correction Factor (dB)	EIRP (dBm)	Limit (dBm)	Margin (dB)
1	5890.00	-40.40	11.22	0.68	11.90	33.00	-21.10
Antenna Polarity & Test Distance: Vertical at 3 M							
No.	Freq. (MHz)	Reading (dBm)	S.G Power Value (dBm)	Correction Factor (dB)	EIRP (dBm)	Limit (dBm)	Margin (dB)
1	5890.00	-24.23	25.72	0.68	26.40	33.00	-6.60

Mode		TX channel 180					
Antenna Polarity & Test Distance: Horizontal at 3 M							
No.	Freq. (MHz)	Reading (dBm)	S.G Power Value (dBm)	Correction Factor (dB)	EIRP (dBm)	Limit (dBm)	Margin (dB)
1	5890.00	-47.30	4.32	0.68	5.00	23.00	-18.00
Antenna Polarity & Test Distance: Vertical at 3 M							
No.	Freq. (MHz)	Reading (dBm)	S.G Power Value (dBm)	Correction Factor (dB)	EIRP (dBm)	Limit (dBm)	Margin (dB)
1	5900.00	-30.14	19.84	0.68	20.52	23.00	-2.48

Mode		TX channel 182					
Antenna Polarity & Test Distance: Horizontal at 3 M							
No.	Freq. (MHz)	Reading (dBm)	S.G Power Value (dBm)	Correction Factor (dB)	EIRP (dBm)	Limit (dBm)	Margin (dB)
1	5910.00	-46.83	4.92	0.68	5.60	23.00	-17.40
Antenna Polarity & Test Distance: Vertical at 3 M							
No.	Freq. (MHz)	Reading (dBm)	S.G Power Value (dBm)	Correction Factor (dB)	EIRP (dBm)	Limit (dBm)	Margin (dB)
1	5910.00	-31.47	18.48	0.68	19.16	23.00	-3.84

Mode		TX channel 184					
Antenna Polarity & Test Distance: Horizontal at 3 M							
No.	Freq. (MHz)	Reading (dBm)	S.G Power Value (dBm)	Correction Factor (dB)	EIRP (dBm)	Limit (dBm)	Margin (dB)
1	5920.00	-41.31	10.52	0.68	11.20	33.00	-21.80
Antenna Polarity & Test Distance: Vertical at 3 M							
No.	Freq. (MHz)	Reading (dBm)	S.G Power Value (dBm)	Correction Factor (dB)	EIRP (dBm)	Limit (dBm)	Margin (dB)
1	5920.00	-25.60	24.32	0.68	25.00	33.00	-8.00

Note: $EIRP (dBm) = S.G Power Value (dBm) + Correction Factor (dB)$



Channel Bandwidth 10MHz, Data Rate 27Mbps

Mode		TX channel 172					
Antenna Polarity & Test Distance: Horizontal at 3 M							
No.	Freq. (MHz)	Reading (dBm)	S.G Power Value (dBm)	Correction Factor (dB)	EIRP (dBm)	Limit (dBm)	Margin (dB)
1	5860.00	-42.04	9.42	0.68	10.10	33.00	-22.90
Antenna Polarity & Test Distance: Vertical at 3 M							
No.	Freq. (MHz)	Reading (dBm)	S.G Power Value (dBm)	Correction Factor (dB)	EIRP (dBm)	Limit (dBm)	Margin (dB)
1	5860.00	-25.45	24.42	0.68	25.10	33.00	-7.90

Mode		TX channel 174					
Antenna Polarity & Test Distance: Horizontal at 3 M							
No.	Freq. (MHz)	Reading (dBm)	S.G Power Value (dBm)	Correction Factor (dB)	EIRP (dBm)	Limit (dBm)	Margin (dB)
1	5870.00	-40.29	11.22	0.68	11.90	33.00	-21.10
Antenna Polarity & Test Distance: Vertical at 3 M							
No.	Freq. (MHz)	Reading (dBm)	S.G Power Value (dBm)	Correction Factor (dB)	EIRP (dBm)	Limit (dBm)	Margin (dB)
1	5870.00	-23.78	26.12	0.68	26.80	33.00	-6.20

Mode		TX channel 176					
Antenna Polarity & Test Distance: Horizontal at 3 M							
No.	Freq. (MHz)	Reading (dBm)	S.G Power Value (dBm)	Correction Factor (dB)	EIRP (dBm)	Limit (dBm)	Margin (dB)
1	5880.00	-41.75	9.82	0.68	10.50	33.00	-22.50
Antenna Polarity & Test Distance: Vertical at 3 M							
No.	Freq. (MHz)	Reading (dBm)	S.G Power Value (dBm)	Correction Factor (dB)	EIRP (dBm)	Limit (dBm)	Margin (dB)
1	5880.00	-24.60	25.32	0.68	26.00	33.00	-7.00

Mode		TX channel 178					
Antenna Polarity & Test Distance: Horizontal at 3 M							
No.	Freq. (MHz)	Reading (dBm)	S.G Power Value (dBm)	Correction Factor (dB)	EIRP (dBm)	Limit (dBm)	Margin (dB)
1	5890.00	-40.70	10.92	0.68	11.60	33.00	-21.40
Antenna Polarity & Test Distance: Vertical at 3 M							
No.	Freq. (MHz)	Reading (dBm)	S.G Power Value (dBm)	Correction Factor (dB)	EIRP (dBm)	Limit (dBm)	Margin (dB)
1	5890.00	-24.23	25.72	0.68	26.40	33.00	-6.60

Mode		TX channel 180					
Antenna Polarity & Test Distance: Horizontal at 3 M							
No.	Freq. (MHz)	Reading (dBm)	S.G Power Value (dBm)	Correction Factor (dB)	EIRP (dBm)	Limit (dBm)	Margin (dB)
1	5900.00	-47.36	4.32	0.68	5.00	23.00	-18.00
Antenna Polarity & Test Distance: Vertical at 3 M							
No.	Freq. (MHz)	Reading (dBm)	S.G Power Value (dBm)	Correction Factor (dB)	EIRP (dBm)	Limit (dBm)	Margin (dB)
1	5900.00	-30.36	19.62	0.68	20.30	23.00	-2.70

Mode		TX channel 182					
Antenna Polarity & Test Distance: Horizontal at 3 M							
No.	Freq. (MHz)	Reading (dBm)	S.G Power Value (dBm)	Correction Factor (dB)	EIRP (dBm)	Limit (dBm)	Margin (dB)
1	5910.00	-46.73	5.02	0.68	5.70	23.00	-17.30
Antenna Polarity & Test Distance: Vertical at 3 M							
No.	Freq. (MHz)	Reading (dBm)	S.G Power Value (dBm)	Correction Factor (dB)	EIRP (dBm)	Limit (dBm)	Margin (dB)
1	5910.00	-31.10	18.80	0.70	19.50	23.00	-3.50

Mode		TX channel 184					
Antenna Polarity & Test Distance: Horizontal at 3 M							
No.	Freq. (MHz)	Reading (dBm)	S.G Power Value (dBm)	Correction Factor (dB)	EIRP (dBm)	Limit (dBm)	Margin (dB)
1	5920.00	-42.01	9.82	0.68	10.50	33.00	-22.50
Antenna Polarity & Test Distance: Vertical at 3 M							
No.	Freq. (MHz)	Reading (dBm)	S.G Power Value (dBm)	Correction Factor (dB)	EIRP (dBm)	Limit (dBm)	Margin (dB)
1	5920.00	-26.79	23.13	0.68	23.81	33.00	-9.19

Note: $EIRP (dBm) = S.G Power Value (dBm) + Correction Factor (dB)$

Channel Bandwidth 20MHz, Data Rate 6Mbps

Mode		TX channel 175					
Antenna Polarity & Test Distance: Horizontal at 3 M							
No.	Freq. (MHz)	Reading (dBm)	S.G Power Value (dBm)	Correction Factor (dB)	EIRP (dBm)	Limit (dBm)	Margin (dB)
1	5875.00	-52.02	-0.48	0.68	0.20	33.00	-32.80
Antenna Polarity & Test Distance: Vertical at 3 M							
No.	Freq. (MHz)	Reading (dBm)	S.G Power Value (dBm)	Correction Factor (dB)	EIRP (dBm)	Limit (dBm)	Margin (dB)
1	5875.00	-33.30	16.61	0.68	17.29	33.00	-15.71

Mode		TX channel 181					
Antenna Polarity & Test Distance: Horizontal at 3 M							
No.	Freq. (MHz)	Reading (dBm)	S.G Power Value (dBm)	Correction Factor (dB)	EIRP (dBm)	Limit (dBm)	Margin (dB)
1	5905.00	-50.30	1.42	0.68	2.10	23.00	-20.90
Antenna Polarity & Test Distance: Vertical at 3 M							
No.	Freq. (MHz)	Reading (dBm)	S.G Power Value (dBm)	Correction Factor (dB)	EIRP (dBm)	Limit (dBm)	Margin (dB)
1	5905.00	-32.45	17.52	0.68	18.20	23.00	-4.80

Note: EIRP (dBm) = S.G Power Value (dBm) + Correction Factor (dB)

Channel Bandwidth 20MHz, Data Rate 54Mbps

Mode		TX channel 175					
Antenna Polarity & Test Distance: Horizontal at 3 M							
No.	Freq. (MHz)	Reading (dBm)	S.G Power Value (dBm)	Correction Factor (dB)	EIRP (dBm)	Limit (dBm)	Margin (dB)
1	5875.00	-50.72	0.82	0.68	1.50	33.00	-31.50
Antenna Polarity & Test Distance: Vertical at 3 M							
No.	Freq. (MHz)	Reading (dBm)	S.G Power Value (dBm)	Correction Factor (dB)	EIRP (dBm)	Limit (dBm)	Margin (dB)
1	5875.00	-33.00	16.91	0.68	17.59	33.00	-15.41

Mode		TX channel 181					
Antenna Polarity & Test Distance: Horizontal at 3 M							
No.	Freq. (MHz)	Reading (dBm)	S.G Power Value (dBm)	Correction Factor (dB)	EIRP (dBm)	Limit (dBm)	Margin (dB)
1	5905.00	-49.50	2.22	0.68	2.90	23.00	-20.10
Antenna Polarity & Test Distance: Vertical at 3 M							
No.	Freq. (MHz)	Reading (dBm)	S.G Power Value (dBm)	Correction Factor (dB)	EIRP (dBm)	Limit (dBm)	Margin (dB)
1	5905.00	-33.15	16.82	0.68	17.50	23.00	-5.50

Note: EIRP (dBm) = S.G Power Value (dBm) + Correction Factor (dB)



Mode B

Channel Bandwidth 10MHz, Data Rate 3Mbps

Mode		TX channel 172					
Antenna Polarity & Test Distance: Horizontal at 3 M							
No.	Freq. (MHz)	Reading (dBm)	S.G Power Value (dBm)	Correction Factor (dB)	EIRP (dBm)	Limit (dBm)	Margin (dB)
1	5860.00	-40.04	11.42	0.68	12.10	33.00	-20.90
Antenna Polarity & Test Distance: Vertical at 3 M							
No.	Freq. (MHz)	Reading (dBm)	S.G Power Value (dBm)	Correction Factor (dB)	EIRP (dBm)	Limit (dBm)	Margin (dB)
1	5860.00	-24.65	25.22	0.68	25.90	33.00	-7.10

Mode		TX channel 174					
Antenna Polarity & Test Distance: Horizontal at 3 M							
No.	Freq. (MHz)	Reading (dBm)	S.G Power Value (dBm)	Correction Factor (dB)	EIRP (dBm)	Limit (dBm)	Margin (dB)
1	5870.00	-39.30	12.20	0.70	12.90	33.00	-20.10
Antenna Polarity & Test Distance: Vertical at 3 M							
No.	Freq. (MHz)	Reading (dBm)	S.G Power Value (dBm)	Correction Factor (dB)	EIRP (dBm)	Limit (dBm)	Margin (dB)
1	5870.00	-24.68	25.22	0.68	25.90	33.00	-7.10

Mode		TX channel 176					
Antenna Polarity & Test Distance: Horizontal at 3 M							
No.	Freq. (MHz)	Reading (dBm)	S.G Power Value (dBm)	Correction Factor (dB)	EIRP (dBm)	Limit (dBm)	Margin (dB)
1	5880.00	-40.05	11.52	0.68	12.20	33.00	-20.80
Antenna Polarity & Test Distance: Vertical at 3 M							
No.	Freq. (MHz)	Reading (dBm)	S.G Power Value (dBm)	Correction Factor (dB)	EIRP (dBm)	Limit (dBm)	Margin (dB)
1	5880.00	-25.10	24.82	0.68	25.50	33.00	-7.50

Mode		TX channel 178					
Antenna Polarity & Test Distance: Horizontal at 3 M							
No.	Freq. (MHz)	Reading (dBm)	S.G Power Value (dBm)	Correction Factor (dB)	EIRP (dBm)	Limit (dBm)	Margin (dB)
1	5890.00	-42.20	9.40	0.70	10.10	33.00	-22.90
Antenna Polarity & Test Distance: Vertical at 3 M							
No.	Freq. (MHz)	Reading (dBm)	S.G Power Value (dBm)	Correction Factor (dB)	EIRP (dBm)	Limit (dBm)	Margin (dB)
1	5890.00	-25.03	24.92	0.68	25.60	33.00	-7.40

Mode		TX channel 180					
Antenna Polarity & Test Distance: Horizontal at 3 M							
No.	Freq. (MHz)	Reading (dBm)	S.G Power Value (dBm)	Correction Factor (dB)	EIRP (dBm)	Limit (dBm)	Margin (dB)
1	5900.00	-48.76	2.92	0.68	3.60	23.00	-19.40
Antenna Polarity & Test Distance: Vertical at 3 M							
No.	Freq. (MHz)	Reading (dBm)	S.G Power Value (dBm)	Correction Factor (dB)	EIRP (dBm)	Limit (dBm)	Margin (dB)
1	5900.00	-29.28	20.70	0.68	21.38	23.00	-1.62

Mode		TX channel 182					
Antenna Polarity & Test Distance: Horizontal at 3 M							
No.	Freq. (MHz)	Reading (dBm)	S.G Power Value (dBm)	Correction Factor (dB)	EIRP (dBm)	Limit (dBm)	Margin (dB)
1	5910.00	-45.43	6.32	0.68	7.00	23.00	-16.00
Antenna Polarity & Test Distance: Vertical at 3 M							
No.	Freq. (MHz)	Reading (dBm)	S.G Power Value (dBm)	Correction Factor (dB)	EIRP (dBm)	Limit (dBm)	Margin (dB)
1	5910.00	-29.17	20.78	0.68	21.46	23.00	-1.54

Mode		TX channel 184					
Antenna Polarity & Test Distance: Horizontal at 3 M							
No.	Freq. (MHz)	Reading (dBm)	S.G Power Value (dBm)	Correction Factor (dB)	EIRP (dBm)	Limit (dBm)	Margin (dB)
1	5920.00	-43.31	8.52	0.68	9.20	33.00	-23.80
Antenna Polarity & Test Distance: Vertical at 3 M							
No.	Freq. (MHz)	Reading (dBm)	S.G Power Value (dBm)	Correction Factor (dB)	EIRP (dBm)	Limit (dBm)	Margin (dB)
1	5920.00	-24.11	25.81	0.68	26.49	33.00	-6.51

Note: EIRP (dBm) = S.G Power Value (dBm) + Correction Factor (dB)

Channel Bandwidth 10MHz, Data Rate 27Mbps

Mode		TX channel 172					
Antenna Polarity & Test Distance: Horizontal at 3 M							
No.	Freq. (MHz)	Reading (dBm)	S.G Power Value (dBm)	Correction Factor (dB)	EIRP (dBm)	Limit (dBm)	Margin (dB)
1	5860.00	-40.94	10.52	0.68	11.20	33.00	-21.80
Antenna Polarity & Test Distance: Vertical at 3 M							
No.	Freq. (MHz)	Reading (dBm)	S.G Power Value (dBm)	Correction Factor (dB)	EIRP (dBm)	Limit (dBm)	Margin (dB)
1	5860.00	-23.89	25.98	0.68	26.66	33.00	-6.34

Mode		TX channel 174					
Antenna Polarity & Test Distance: Horizontal at 3 M							
No.	Freq. (MHz)	Reading (dBm)	S.G Power Value (dBm)	Correction Factor (dB)	EIRP (dBm)	Limit (dBm)	Margin (dB)
1	5880.00	-41.35	10.22	0.68	10.90	33.00	-22.10
Antenna Polarity & Test Distance: Vertical at 3 M							
No.	Freq. (MHz)	Reading (dBm)	S.G Power Value (dBm)	Correction Factor (dB)	EIRP (dBm)	Limit (dBm)	Margin (dB)
1	5870.00	-25.48	24.42	0.68	25.10	33.00	-7.90

Mode		TX channel 176					
Antenna Polarity & Test Distance: Horizontal at 3 M							
No.	Freq. (MHz)	Reading (dBm)	S.G Power Value (dBm)	Correction Factor (dB)	EIRP (dBm)	Limit (dBm)	Margin (dB)
1	5880.00	-41.35	10.22	0.68	10.90	33.00	-22.10
Antenna Polarity & Test Distance: Vertical at 3 M							
No.	Freq. (MHz)	Reading (dBm)	S.G Power Value (dBm)	Correction Factor (dB)	EIRP (dBm)	Limit (dBm)	Margin (dB)
1	5880.00	-23.70	26.22	0.68	26.90	33.00	-6.10

Mode		TX channel 178					
Antenna Polarity & Test Distance: Horizontal at 3 M							
No.	Freq. (MHz)	Reading (dBm)	S.G Power Value (dBm)	Correction Factor (dB)	EIRP (dBm)	Limit (dBm)	Margin (dB)
1	5890.00	-40.30	11.32	0.68	12.00	33.00	-21.00
Antenna Polarity & Test Distance: Vertical at 3 M							
No.	Freq. (MHz)	Reading (dBm)	S.G Power Value (dBm)	Correction Factor (dB)	EIRP (dBm)	Limit (dBm)	Margin (dB)
1	5890.00	-24.61	25.34	0.68	26.02	33.00	-6.98

Mode		TX channel 180					
Antenna Polarity & Test Distance: Horizontal at 3 M							
No.	Freq. (MHz)	Reading (dBm)	S.G Power Value (dBm)	Correction Factor (dB)	EIRP (dBm)	Limit (dBm)	Margin (dB)
1	5900.00	-46.96	4.72	0.68	5.40	23.00	-17.60
Antenna Polarity & Test Distance: Vertical at 3 M							
No.	Freq. (MHz)	Reading (dBm)	S.G Power Value (dBm)	Correction Factor (dB)	EIRP (dBm)	Limit (dBm)	Margin (dB)
1	5900.00	-29.06	20.92	0.68	21.60	23.00	-1.40

Mode		TX channel 182					
Antenna Polarity & Test Distance: Horizontal at 3 M							
No.	Freq. (MHz)	Reading (dBm)	S.G Power Value (dBm)	Correction Factor (dB)	EIRP (dBm)	Limit (dBm)	Margin (dB)
1	5910.00	-47.13	4.62	0.68	5.30	23.00	-17.70
Antenna Polarity & Test Distance: Vertical at 3 M							
No.	Freq. (MHz)	Reading (dBm)	S.G Power Value (dBm)	Correction Factor (dB)	EIRP (dBm)	Limit (dBm)	Margin (dB)
1	5910.00	-28.83	21.12	0.68	21.80	23.00	-1.20

Mode		TX channel 184					
Antenna Polarity & Test Distance: Horizontal at 3 M							
No.	Freq. (MHz)	Reading (dBm)	S.G Power Value (dBm)	Correction Factor (dB)	EIRP (dBm)	Limit (dBm)	Margin (dB)
1	5920.00	-42.11	9.72	0.68	10.40	33.00	-22.60
Antenna Polarity & Test Distance: Vertical at 3 M							
No.	Freq. (MHz)	Reading (dBm)	S.G Power Value (dBm)	Correction Factor (dB)	EIRP (dBm)	Limit (dBm)	Margin (dB)
1	5920.00	-23.91	26.01	0.68	26.69	33.00	-6.31

Note: $EIRP (dBm) = S.G Power Value (dBm) + Correction Factor (dB)$



Channel Bandwidth 20MHz, Data Rate 6Mbps

Mode		TX channel 175					
Antenna Polarity & Test Distance: Horizontal at 3 M							
No.	Freq. (MHz)	Reading (dBm)	S.G Power Value (dBm)	Correction Factor (dB)	EIRP (dBm)	Limit (dBm)	Margin (dB)
1	5875.00	-49.23	2.31	0.68	2.99	23.00	-20.01
Antenna Polarity & Test Distance: Vertical at 3 M							
No.	Freq. (MHz)	Reading (dBm)	S.G Power Value (dBm)	Correction Factor (dB)	EIRP (dBm)	Limit (dBm)	Margin (dB)
1	5875.00	-31.45	18.46	0.68	19.14	23.00	-3.86

Mode		TX channel 181					
Antenna Polarity & Test Distance: Horizontal at 3 M							
No.	Freq. (MHz)	Reading (dBm)	S.G Power Value (dBm)	Correction Factor (dB)	EIRP (dBm)	Limit (dBm)	Margin (dB)
1	5905.00	-50.90	0.82	0.68	1.50	23.00	-21.50
Antenna Polarity & Test Distance: Vertical at 3 M							
No.	Freq. (MHz)	Reading (dBm)	S.G Power Value (dBm)	Correction Factor (dB)	EIRP (dBm)	Limit (dBm)	Margin (dB)
1	5905.00	-32.36	17.61	0.68	18.29	23.00	-4.71

Note: EIRP (dBm) = S.G Power Value (dBm) + Correction Factor (dB)

Channel Bandwidth 20MHz, Data Rate 54Mbps

Mode		TX channel 175					
Antenna Polarity & Test Distance: Horizontal at 3 M							
No.	Freq. (MHz)	Reading (dBm)	S.G Power Value (dBm)	Correction Factor (dB)	EIRP (dBm)	Limit (dBm)	Margin (dB)
1	5905.00	-49.36	2.36	0.68	3.04	23.00	-19.96
Antenna Polarity & Test Distance: Vertical at 3 M							
No.	Freq. (MHz)	Reading (dBm)	S.G Power Value (dBm)	Correction Factor (dB)	EIRP (dBm)	Limit (dBm)	Margin (dB)
1	5905.00	-31.44	18.53	0.68	19.21	23.00	-3.79

Mode		TX channel 181					
Antenna Polarity & Test Distance: Horizontal at 3 M							
No.	Freq. (MHz)	Reading (dBm)	S.G Power Value (dBm)	Correction Factor (dB)	EIRP (dBm)	Limit (dBm)	Margin (dB)
1	5875.00	-50.04	1.50	0.68	2.18	23.00	-20.82
Antenna Polarity & Test Distance: Vertical at 3 M							
No.	Freq. (MHz)	Reading (dBm)	S.G Power Value (dBm)	Correction Factor (dB)	EIRP (dBm)	Limit (dBm)	Margin (dB)
1	5875.00	-31.70	18.21	0.68	18.89	23.00	-4.11

Note: EIRP (dBm) = S.G Power Value (dBm) + Correction Factor (dB)

4.2 Frequency Tolerance Measurement

4.2.1 Limits of Frequency Tolerance Measurement

The transmitter center frequency stability shall be ± 10 ppm maximum.

4.2.2 Test Procedure

- a. Device is placed at the oven room. The oven room could control the temperatures and humidity. Power warm up is at least 15 min and power applied should perform before recording frequency error.
- b. EUT is connected the external power supply to control the AC input power. The test voltage range is from minimum to maximum working voltage. Each step shall be record the frequency error rate.
- c. The temperature range step is 10 degrees in this test items. All temperature levels shall be hold the ± 0.5 °C during the measurement testing. The each temperature step shall be at least 0.5 hours, consider the EUT could be test under the stability condition.

NOTE: The frequency error was recorded frequency error from the communication simulator.

4.2.3 Test Setup

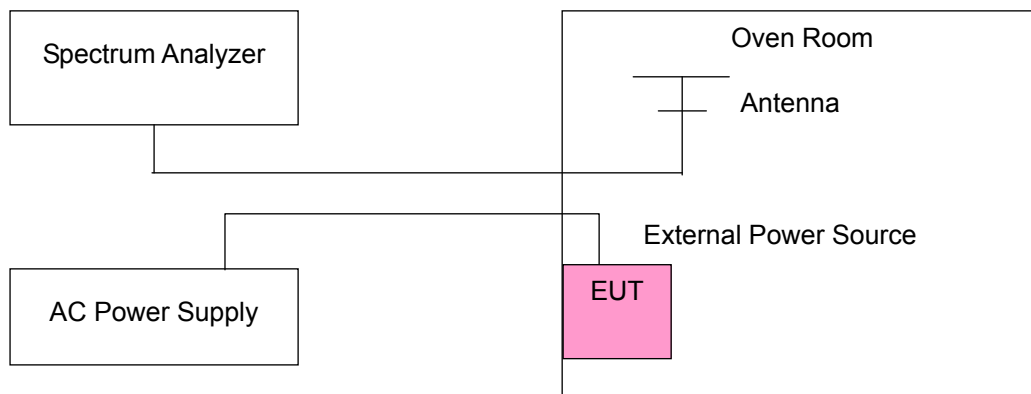

4.2.4 Test Results

Mode A

Frequency Error vs. Voltage

Voltage (Volts)	Frequency Error (ppm)	Limit (ppm)
138	3.35076	10
120	3.12476	10
102	3.61281	10

Note: The applicant defined the normal working voltage of the battery is from 102Vac to 138Vac.

Frequency Error vs. Temperature.

TEMP. (°C)	Frequency Error (ppm)	Limit (ppm)
70	3.23647	10
60	3.41425	10
50	3.31463	10
40	3.24586	10
30	3.13457	10
20	3.12476	10
10	3.04136	10
0	3.34947	10
-10	4.12365	10
-20	4.25649	10
-30	4.45648	10

Mode B

Frequency Error vs. Voltage

Voltage (Volts)	Frequency Error (ppm)	Limit (ppm)
138	3.20336	10
120	3.13546	10
102	3.18383	10

Note: The applicant defined the normal working voltage of the battery is from 102Vac to 138Vac.

Frequency Error vs. Temperature.

TEMP. (°C)	Frequency Error (ppm)	Limit (ppm)
70	3.35468	10
60	3.41425	10
50	3.29874	10
40	3.26547	10
30	3.15688	10
20	3.13546	10
10	3.12364	10
0	3.26547	10
-10	3.54781	10
-20	3.75686	10
-30	3.89753	10

4.3 Emission Bandwidth Measurement

4.3.1 Limits of Emission Bandwidth Measurement

The width of a frequency band such that, below the lower and above the upper frequency limits, the signal power at the 99% channel power of occupied bandwidth when resolution bandwidth should be approximately 1 % to 5 % of the occupied bandwidth (OBW)

4.3.2 Test Procedure

The EUT makes a call to the communication simulator. All measurements were done at low, middle and high operational frequency range. The communication simulator station system controlled a EUT to export maximum output power under transmission mode and specific channel frequency. Use OBW measurement function of Spectrum analyzer to measure 99 % occupied bandwidth.

4.3.3 Test Setup

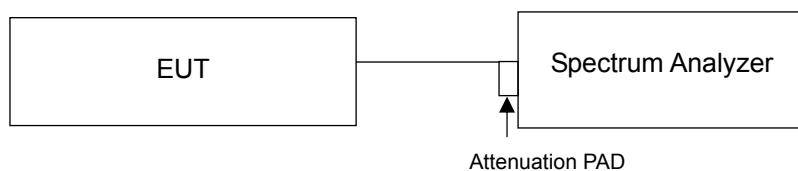

4.3.4 Test Result

Mode A

Channel Bandwidth 10MHz

Channel	Frequency (MHz)	99% Occupied Bandwidth (MHz)	
		Data Rate 3Mbps	Data Rate 27Mbps
172	5860	8.23	8.23
174	5870	8.23	8.23
176	5880	8.23	8.23
178	5890	8.26	8.23
180	5900	8.23	8.23
182	5910	8.23	8.26
184	5920	8.23	8.26

Spectrum Plot of Worst Value

Data Rate 3Mbps

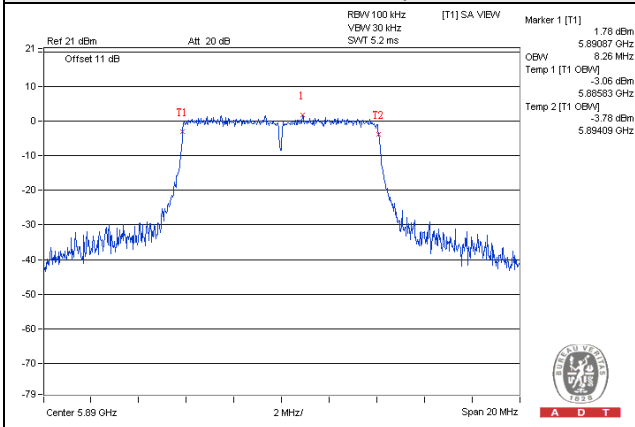

Data Rate 27Mbps

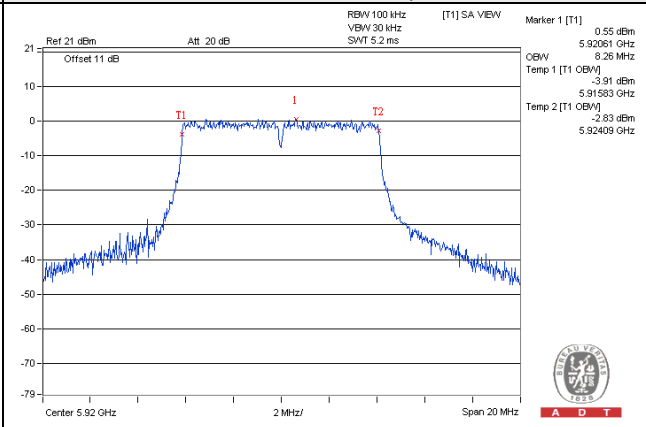

Channel Bandwidth 20MHz

Channel	Frequency (MHz)	99% Occupied Bandwidth (MHz)	
		Data Rate 6Mbps	Data Rate 54Mbps
175	5875	16.39	16.43
181	5905	16.39	16.43

Spectrum Plot of Worst Value

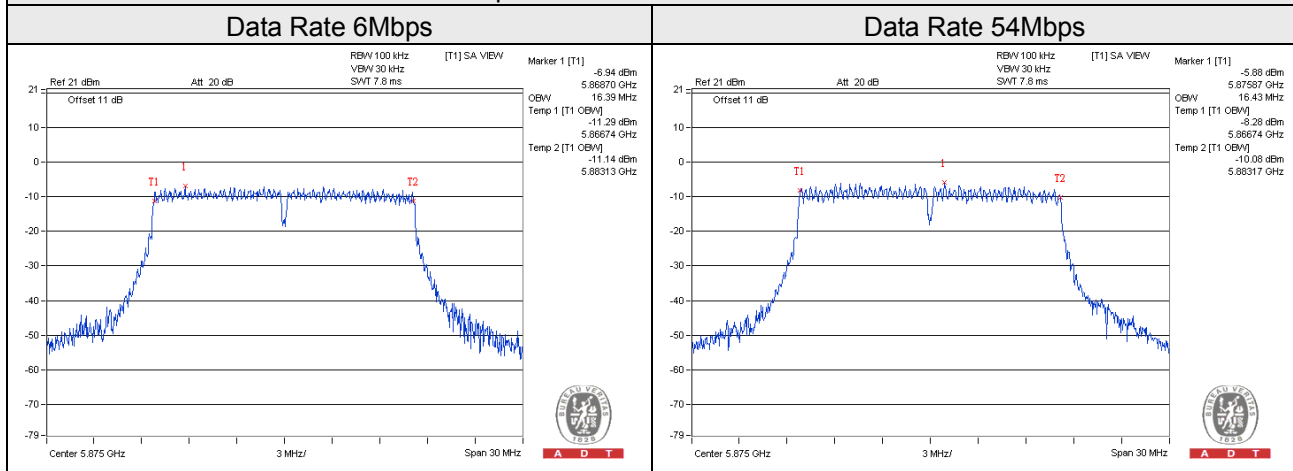

Mode B

Channel Bandwidth 10MHz

Channel	Frequency (MHz)	99% Occupied Bandwidth (MHz)	
		Data Rate 3Mbps	Data Rate 27Mbps
172	5860	8.23	8.26
174	5870	8.23	8.26
176	5880	8.23	8.23
178	5890	8.26	8.26
180	5900	8.23	8.23
182	5910	8.26	8.26
184	5920	8.23	8.26

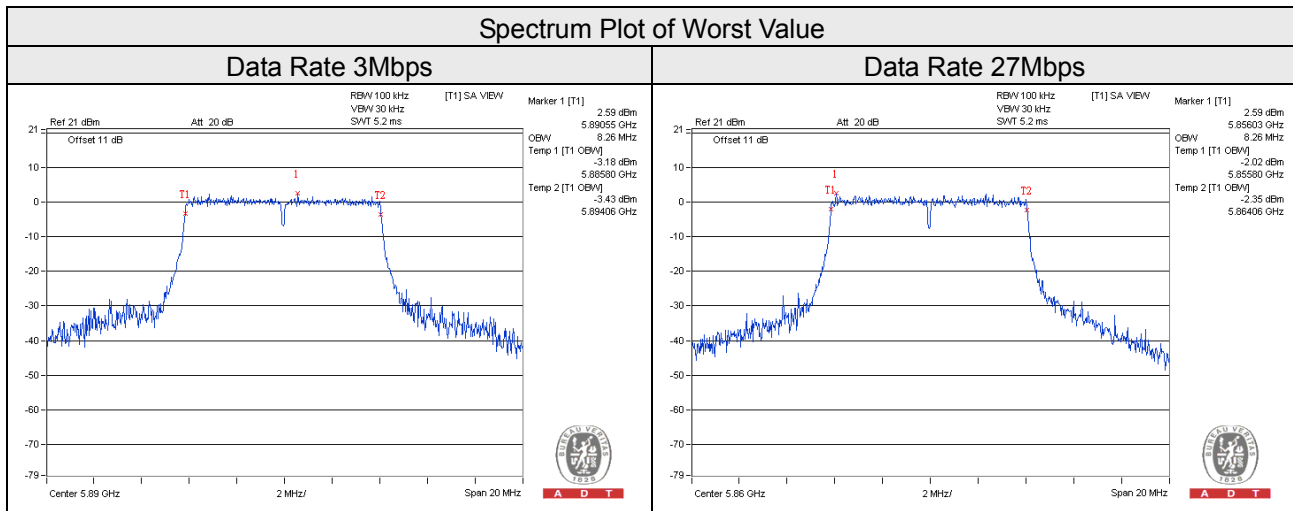

Channel Bandwidth 20MHz

Channel	Frequency (MHz)	99% Occupied Bandwidth (MHz)	
		Data Rate 6Mbps	Data Rate 54Mbps
175	5875	16.43	16.43
181	5905	16.43	16.39

Spectrum Plot of Worst Value

Data Rate 6Mbps

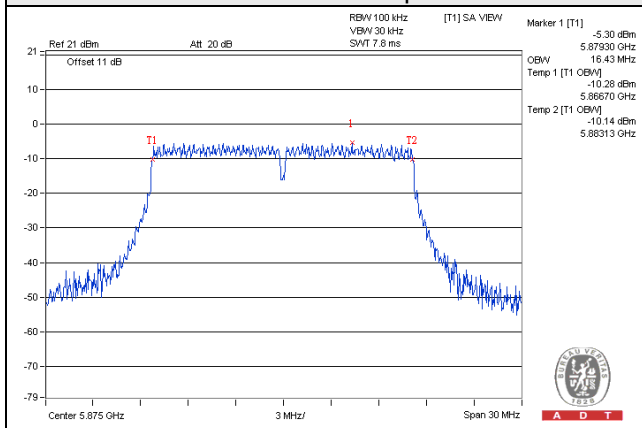

Data Rate 54Mbps

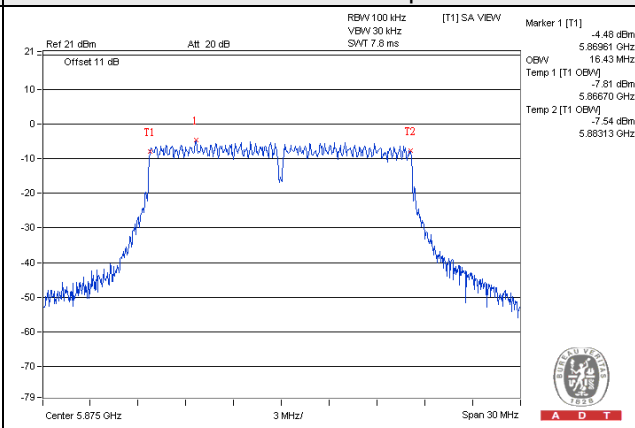

4.4 Emission Mask Measurement

4.4.1 Limits of Emission Mask Measurement

STA transmit power classification	± 4.5 MHz offset ($\pm f1$)	± 5.0 MHz offset ($\pm f2$)	± 5.5 MHz offset ($\pm f3$)	± 10 MHz offset ($\pm f4$)	± 15 MHz offset ($\pm f5$)
Class A	0	-10	-20	-28	-40
Class B	0	-16	-20	-28 <td -40	
Class C	0	-26	-32	-40	-50
Class D	0	-35	-45	-55	-65

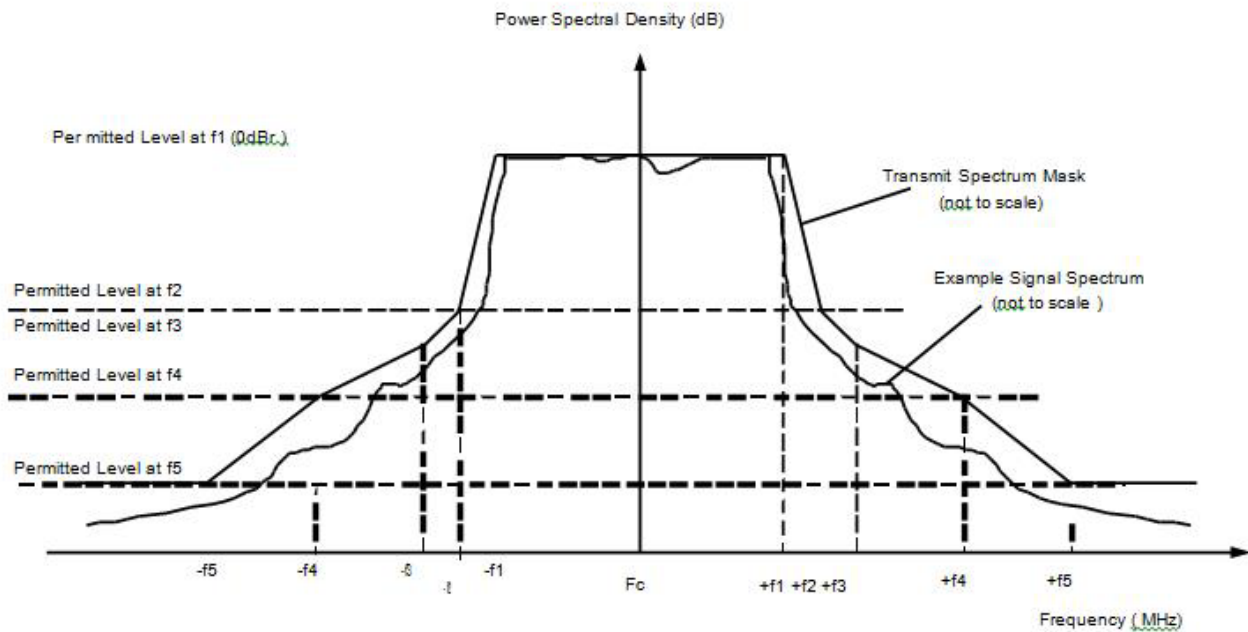

4.4.2 Test Procedures

1. The power was measured with Agilent Spectrum Analyzer. All measurements were done at 1 channel.
2. The measurement used the power splitter via EUT RF power connector between signal generator and spectrum analyzer.
3. Record the test plot.

4.4.3 Test Setup

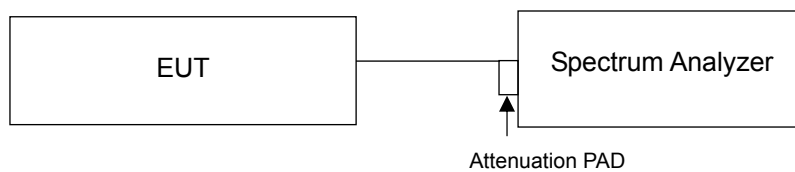

4.4.4 Test Results

Mode A

Channel Bandwidth 10MHz

Data Rate 3Mbps

CH172 5860MHz

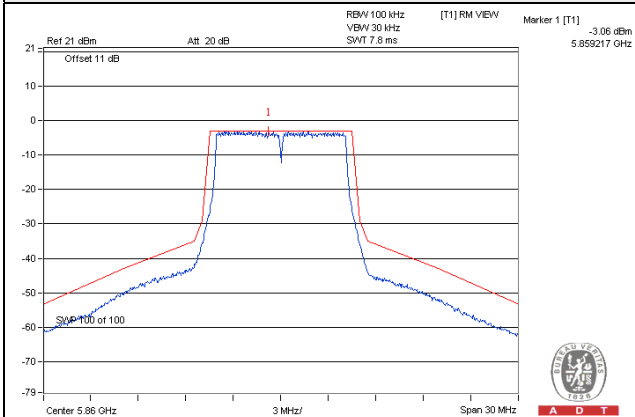

CH174 5870MHz

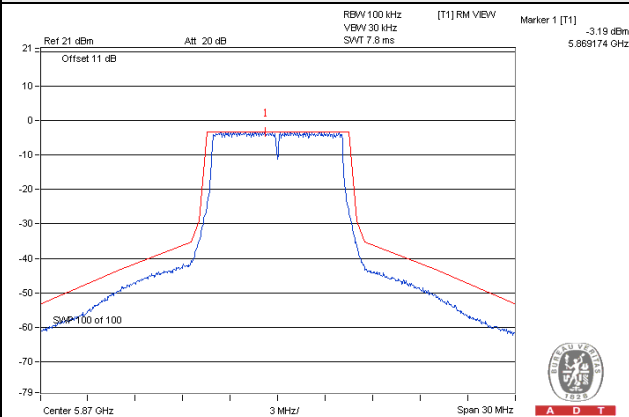

CH176 5880MHz

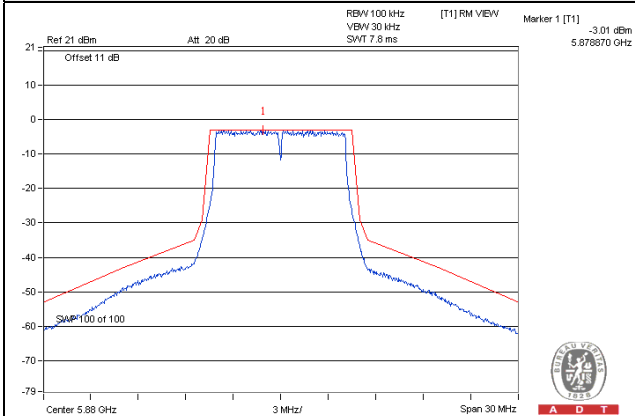

CH178 5890MHz

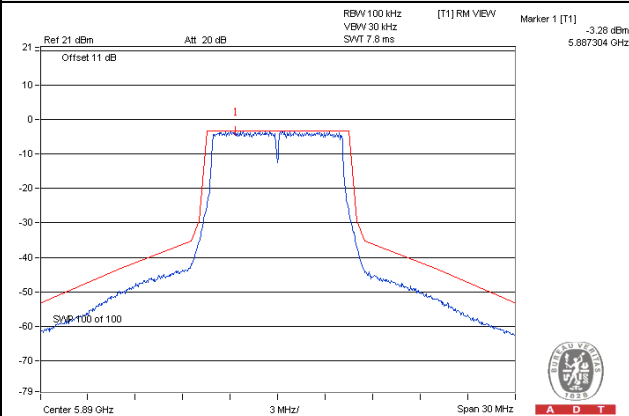

CH180 5900MHz

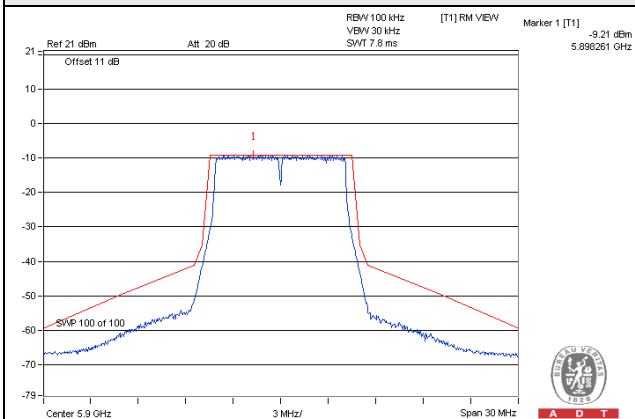

CH182 5910MHz

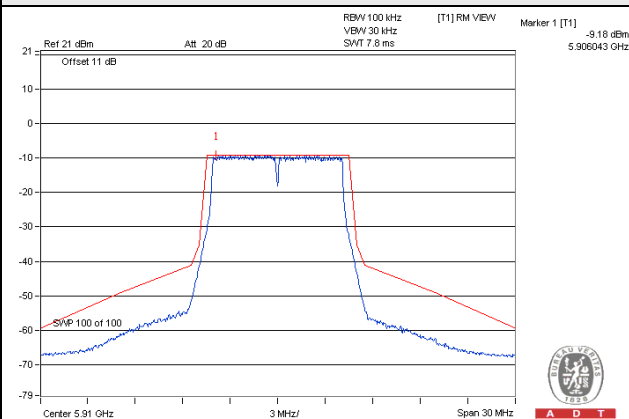

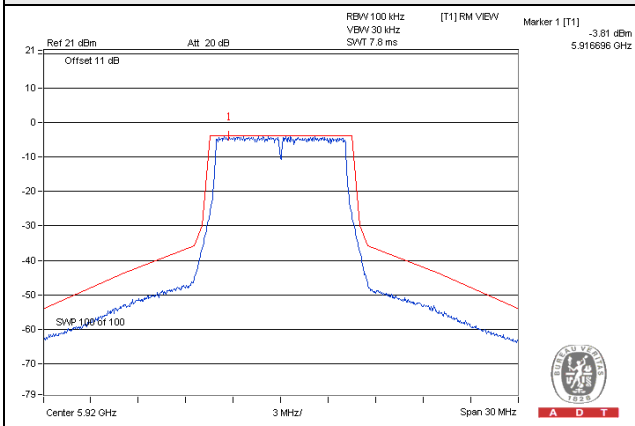
CH184 5920MHz

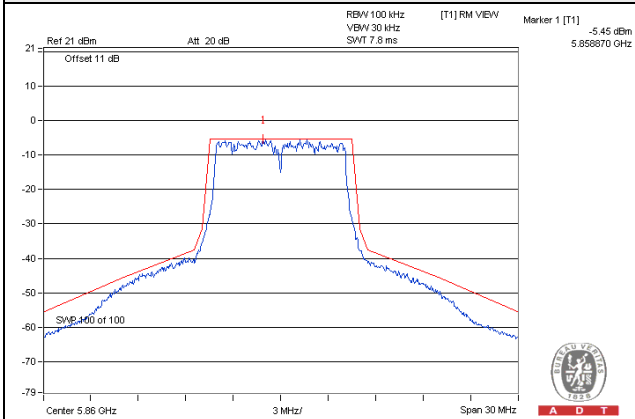
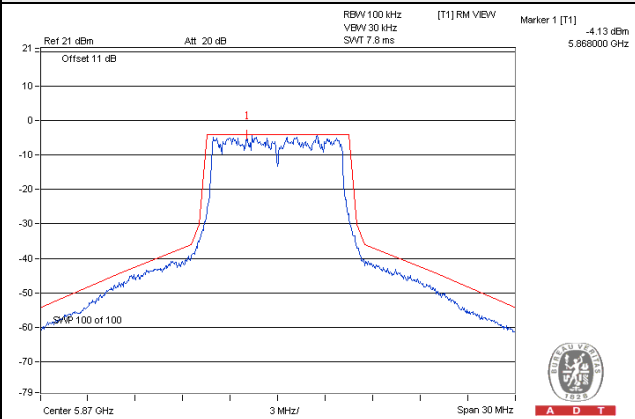
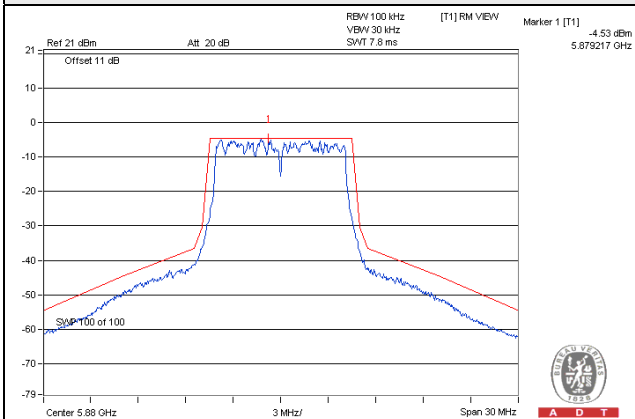
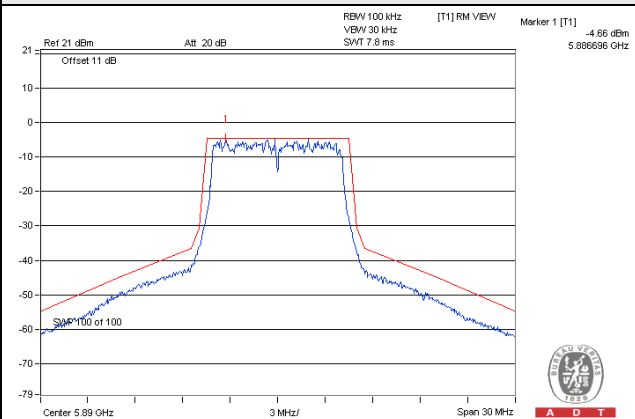
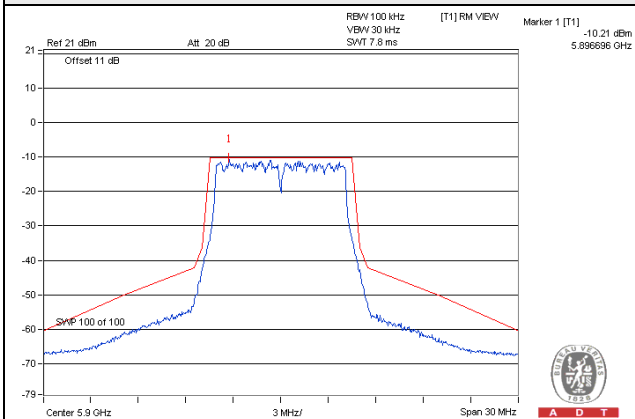
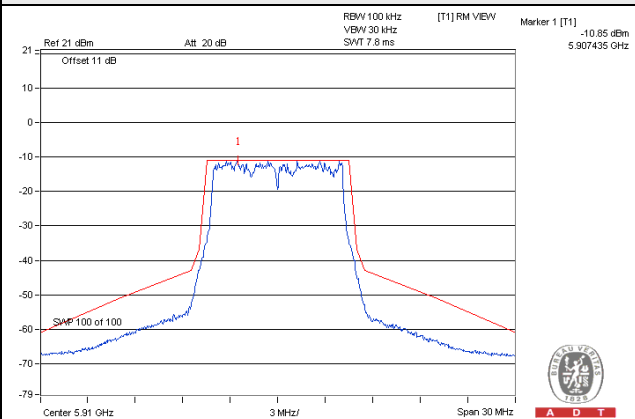
Data Rate 27Mbps
CH172 5860MHz

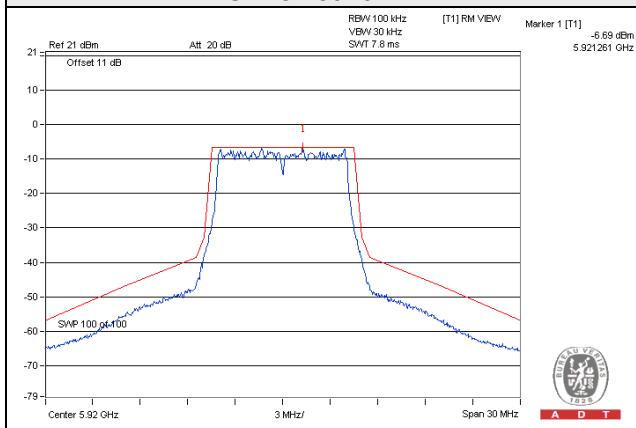
CH174 5870MHz

CH176 5880MHz

CH178 5890MHz

CH180 5900MHz

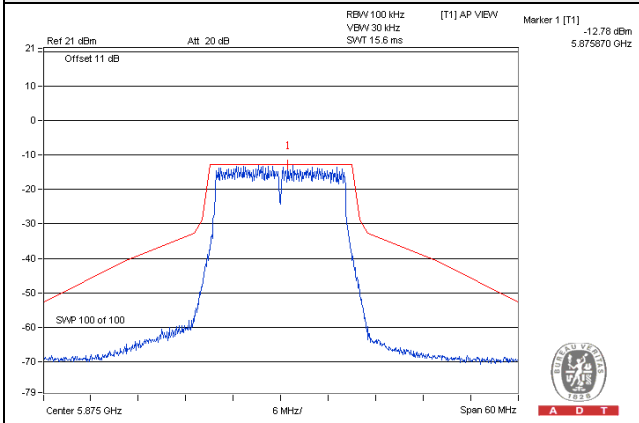
CH182 5910MHz

CH184 5920MHz

Channel Bandwidth 20MHz

Data Rate 6Mbps

CH175 5875MHz



CH181 5905MHz

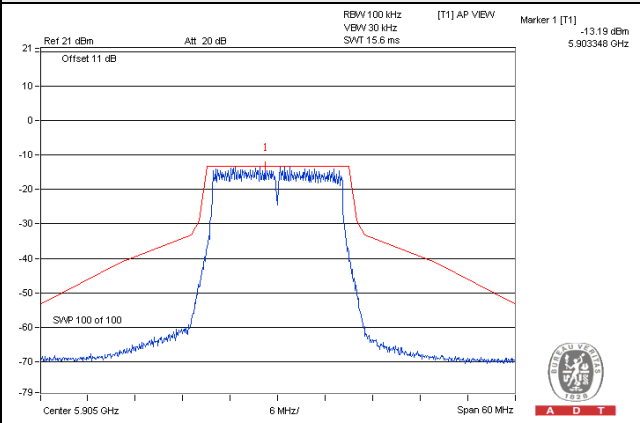

Data Rate 54Mbps

CH175 5875MHz

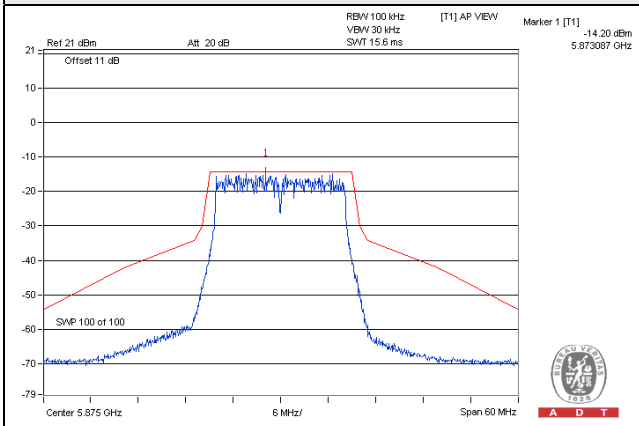

CH181 5905MHz

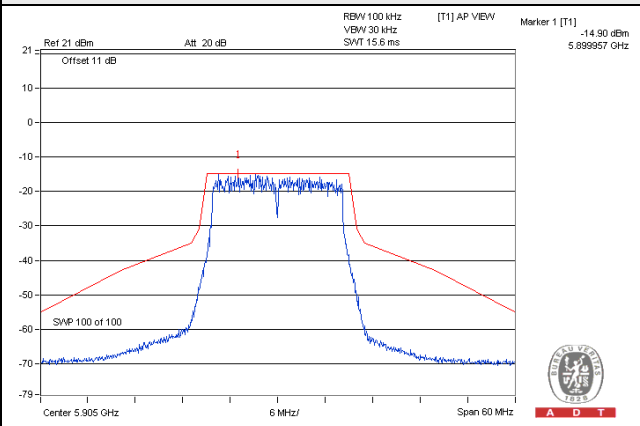

Mode B

Channel Bandwidth 10MHz

Data Rate 3Mbps

CH172 5860MHz

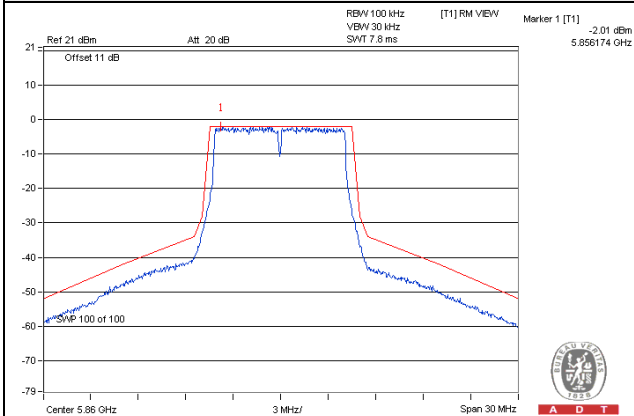

CH174 5870MHz

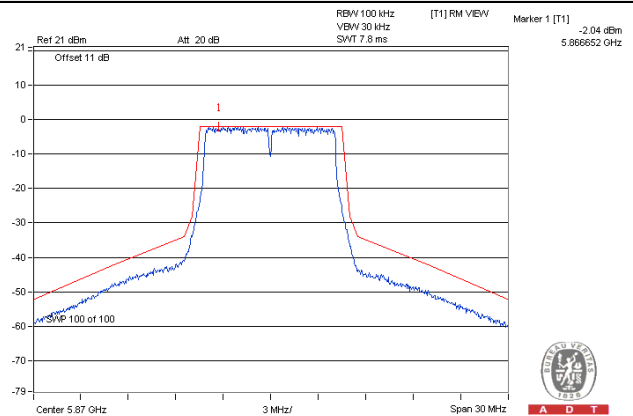

CH176 5880MHz

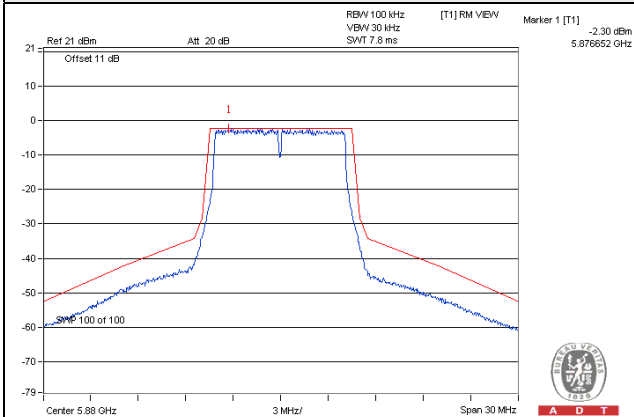

CH178 5890MHz

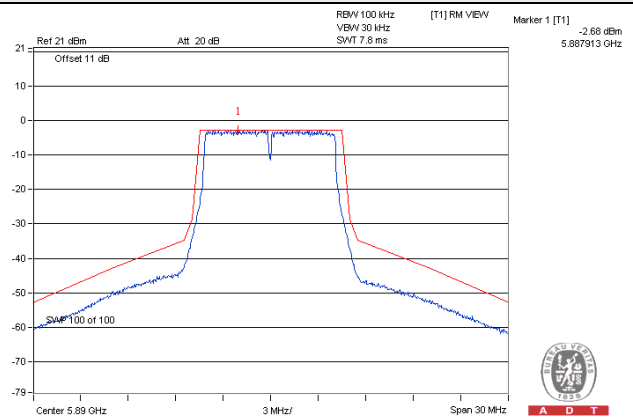

CH180 5900MHz

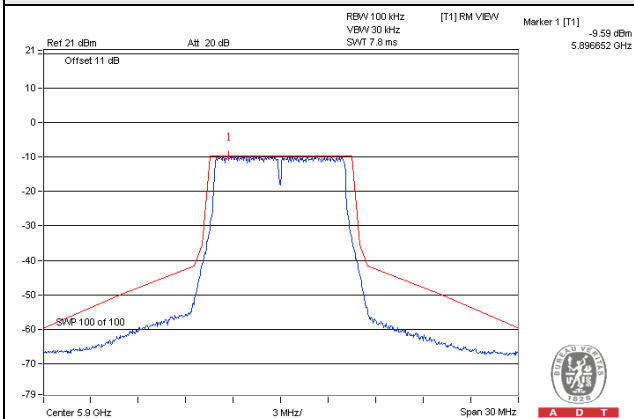

CH182 5910MHz

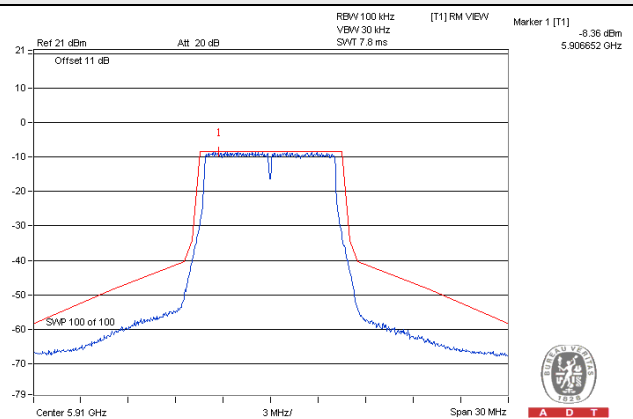

CH184 5920MHz

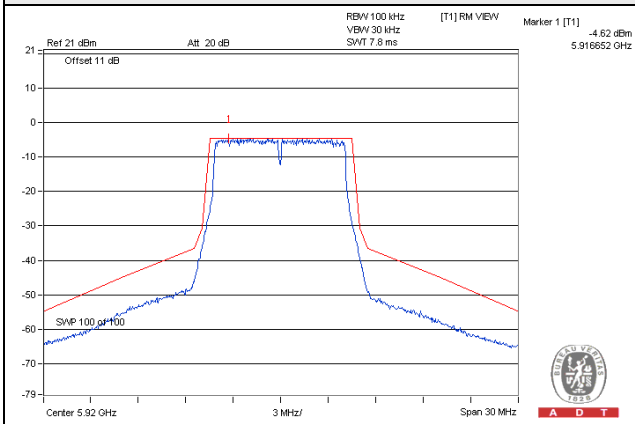

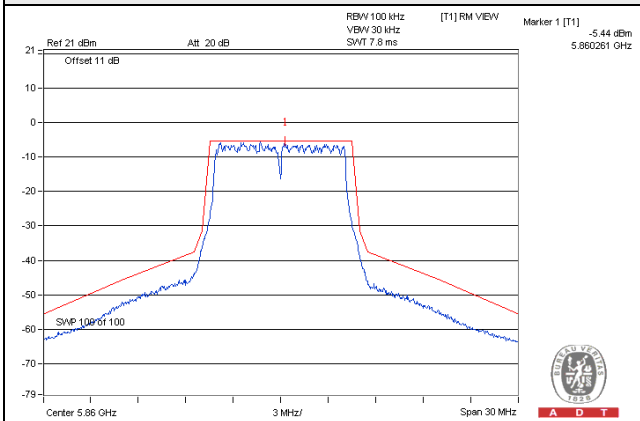
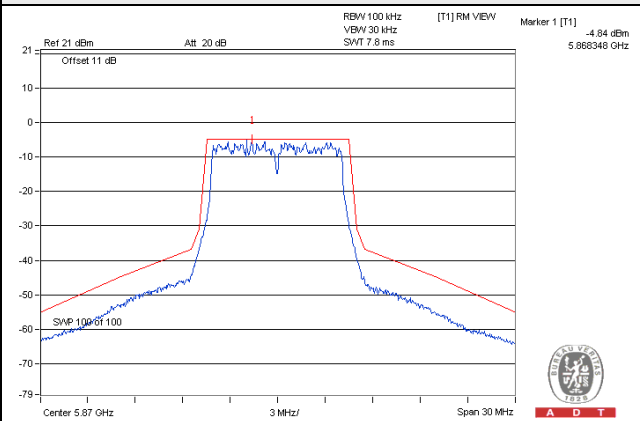
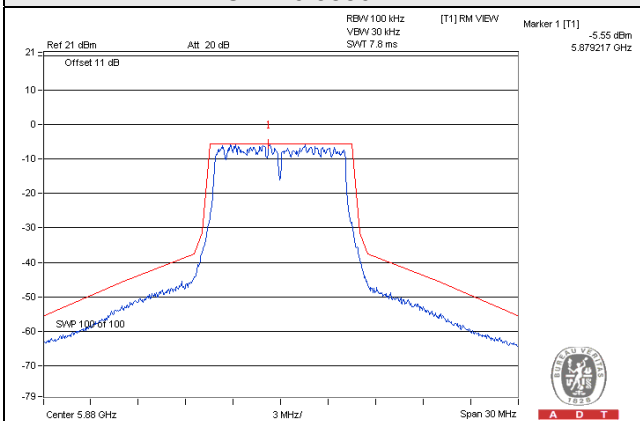
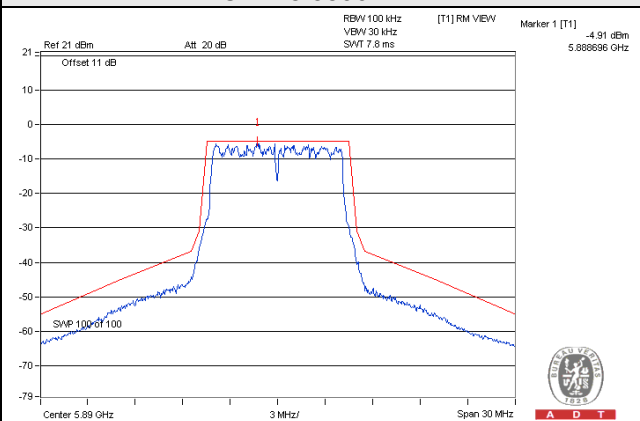
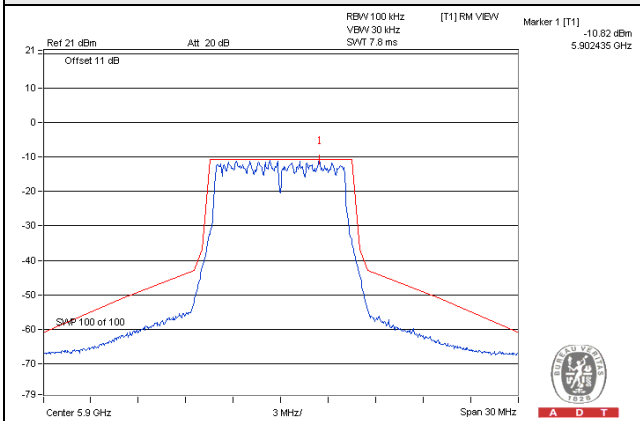
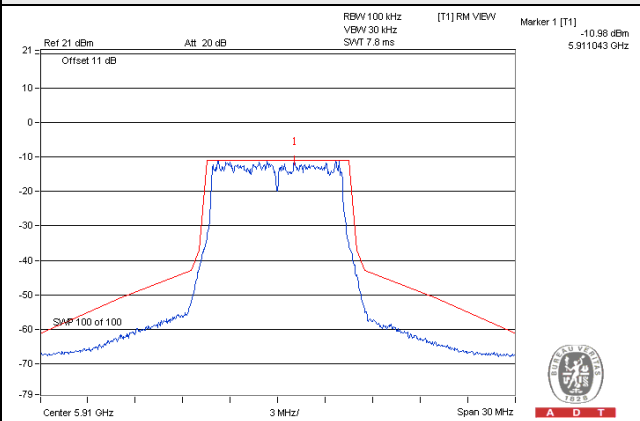
Data Rate 27Mbps
CH172 5860MHz

CH174 5870MHz

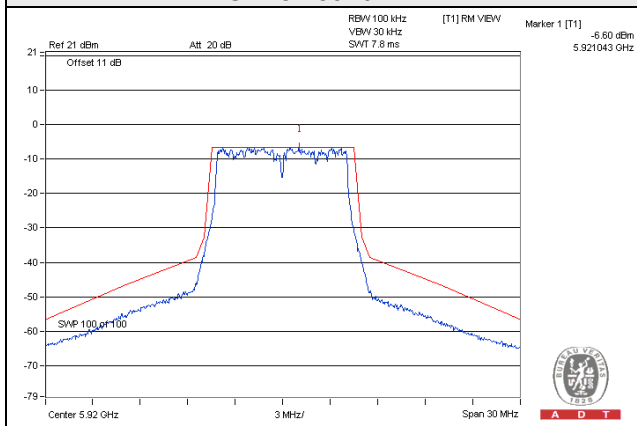
CH176 5880MHz

CH178 5890MHz

CH180 5900MHz

CH182 5910MHz

CH184 5920MHz



Channel Bandwidth 20MHz

Data Rate 6Mbps

CH175 5875MHz

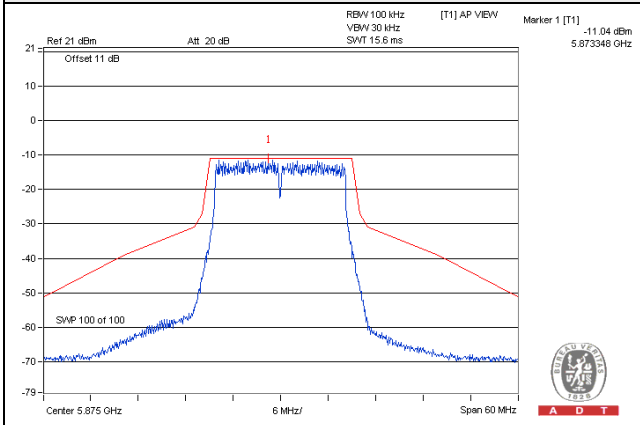

CH181 5905MHz

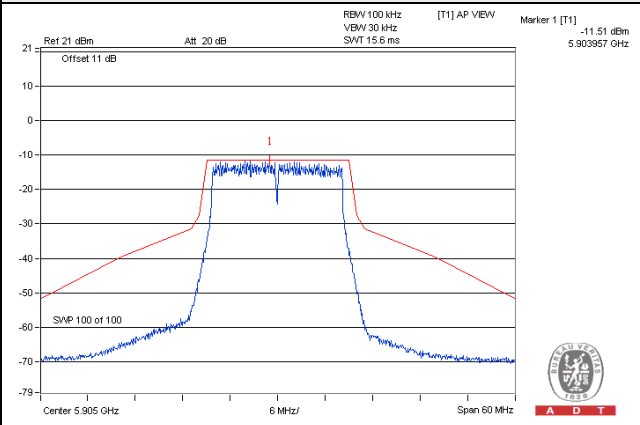

Data Rate 54Mbps

CH175 5875MHz

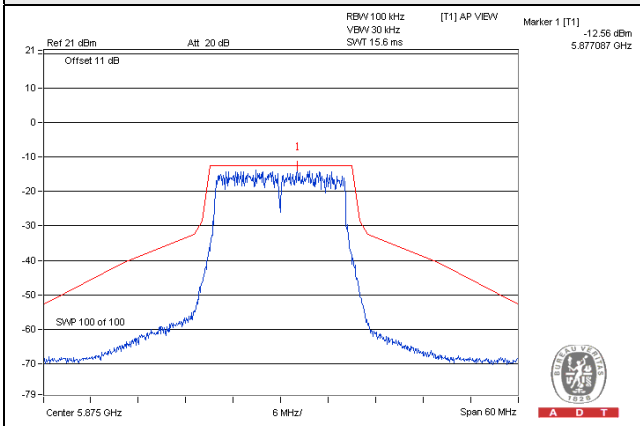

CH181 5905MHz

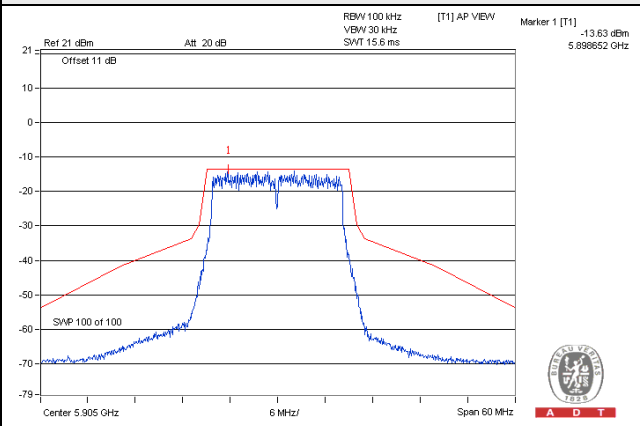

4.5 Peak To Average Ratio

4.5.1 Limits of Peak To Average Ratio Measurement

In measuring transmissions in this band using an average power technique, the peak to-average ratio (PAR) of the transmission may not exceed 13 dB

4.5.2 Test Setup

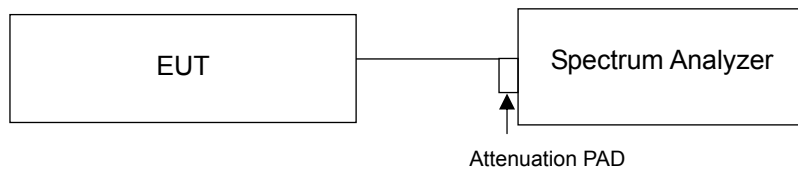

4.5.3 Test Procedures

1. Set resolution/measurement bandwidth \geq signal's occupied bandwidth;
2. Set the number of counts to a value that stabilizes the measured CCDF curve;
3. Record the maximum PAPR level associated with a probability of 0.1%.

4.5.4 Test Results

Mode A

Channel Bandwidth 10MHz

Channel	Frequency (MHz)	Peak To Average Ratio (dB)	
		Data Rate 3Mbps	Data Rate 27Mbps
172	5860	7.96	8.36
174	5870	7.84	8.41
176	5880	7.96	8.37
178	5890	7.89	8.40
180	5900	8.47	8.33
182	5910	8.05	8.30
184	5920	8.13	8.35

Spectrum Plot of Worst Value

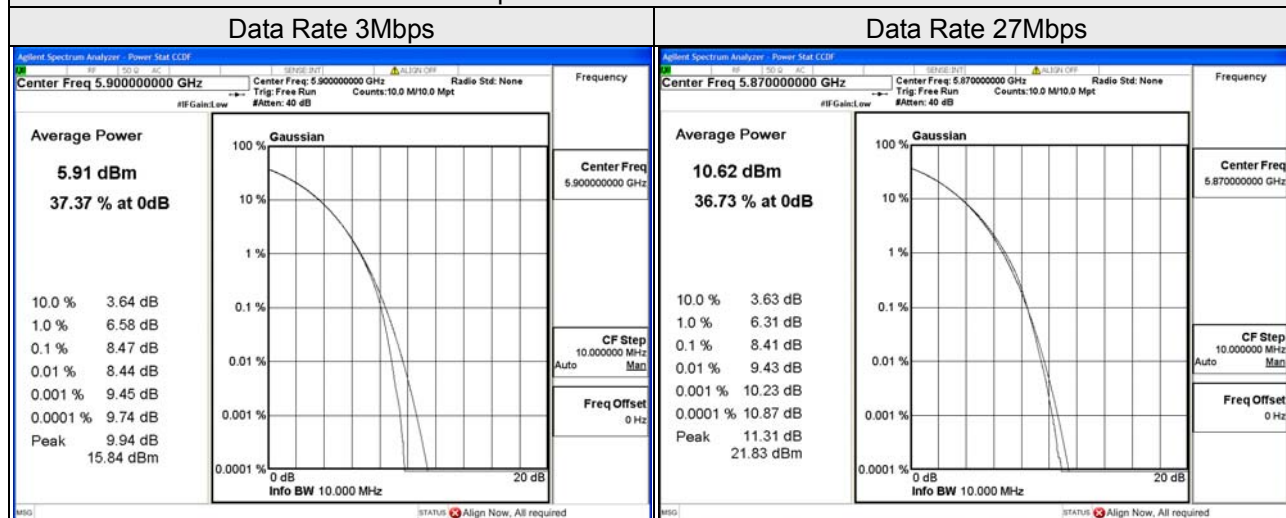

Channel Bandwidth 20MHz

Channel	Frequency (MHz)	Peak To Average Ratio (dB)	
		Data Rate 6Mbps	Data Rate 54Mbps
175	5875	7.93	8.23
181	5905	8.04	8.15

Spectrum Plot of Worst Value

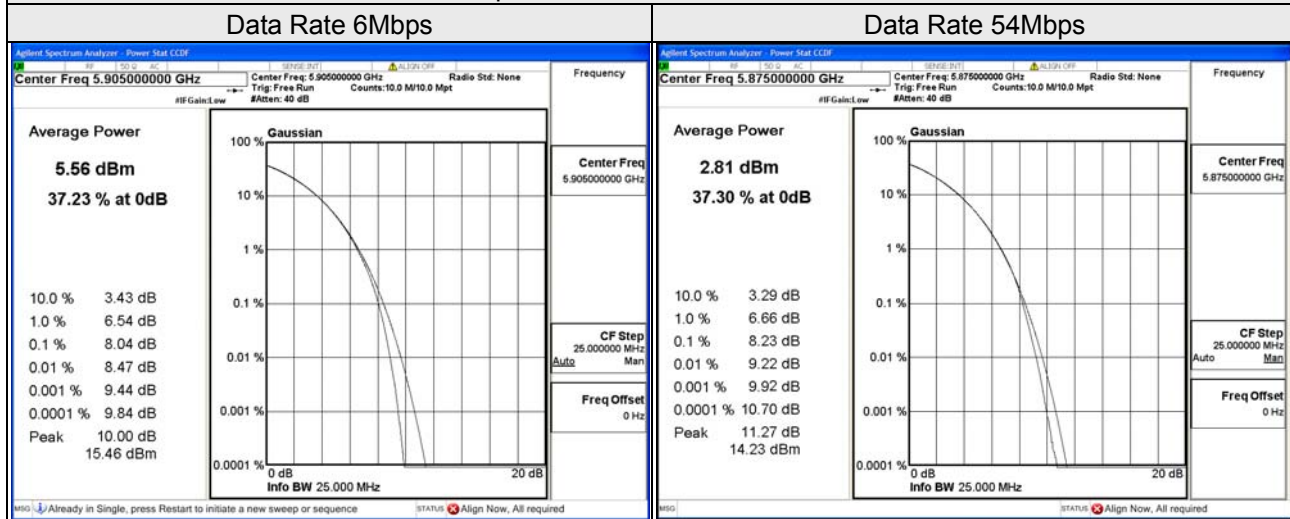

Mode B

Channel Bandwidth 10MHz

Channel	Frequency (MHz)	Peak To Average Ratio (dB)	
		Data Rate 3Mbps	Data Rate 27Mbps
172	5860	7.94	8.36
174	5870	7.83	8.41
176	5880	7.36	8.37
178	5890	7.89	8.40
180	5900	8.49	8.93
182	5910	8.05	8.31
184	5920	8.13	8.33

Spectrum Plot of Worst Value

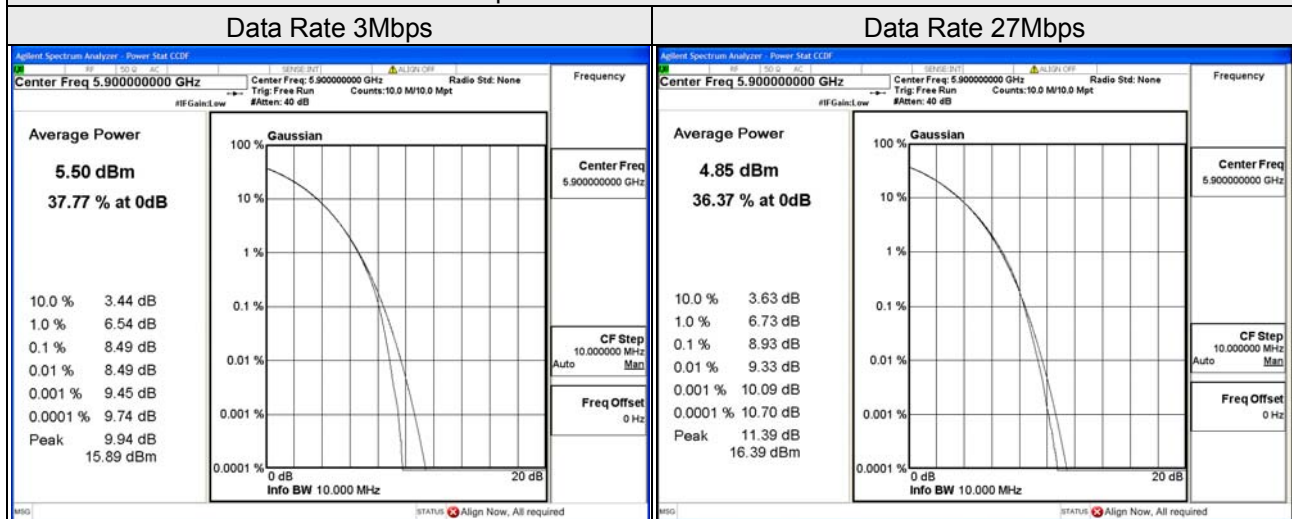

Channel Bandwidth 20MHz

Channel	Frequency (MHz)	Peak To Average Ratio (dB)	
		Data Rate 6Mbps	Data Rate 54Mbps
175	5875	7.93	8.23
181	5905	8.54	8.18

Spectrum Plot of Worst Value

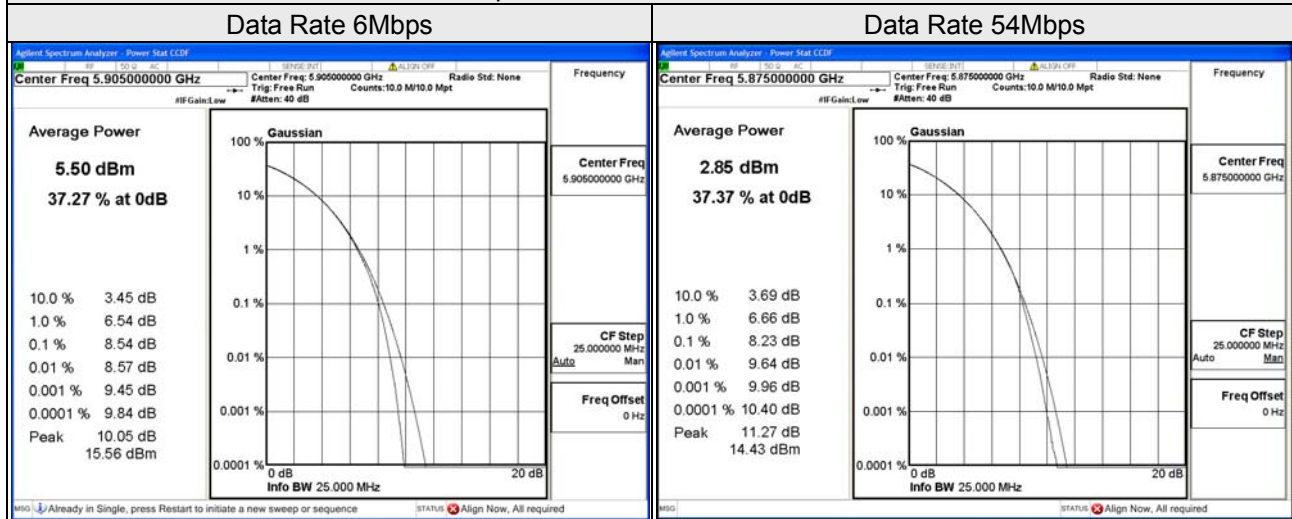

4.6 Conducted Spurious Emissions

4.6.1 Limits of Conducted Spurious Emissions Measurement

The power of any emission outside a licensee's frequency band(s) of operation shall be attenuated below the transmitter power (P) within the licensed band(s) of operation, measured in watts, by at least $[55 + 10 \log(P)]$ (-25dBm).

4.6.2 Test Setup

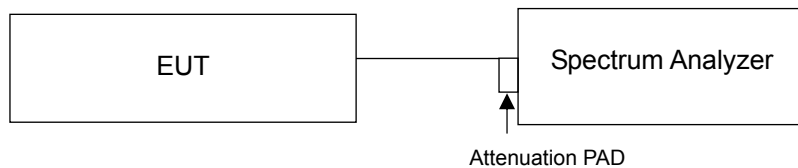

4.6.3 Test Procedure

- The EUT was set up for the maximum peak power with worst data modulation. The power was measured with Spectrum Analyzer.
- The conducted spurious emission used the RF cable via EUT RF power connector between spectrum analyzer.

When the spectrum scanned from 9kHz to 40GHz, it shall be connected to the band reject filter attenuated the carried frequency.

4.6.4 Test Results

Mode A

Channel Bandwidth 10MHz

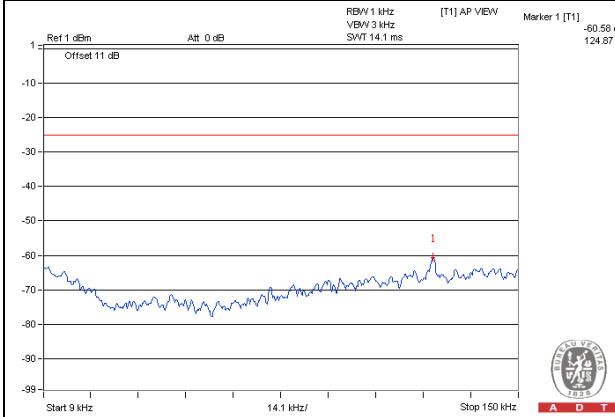
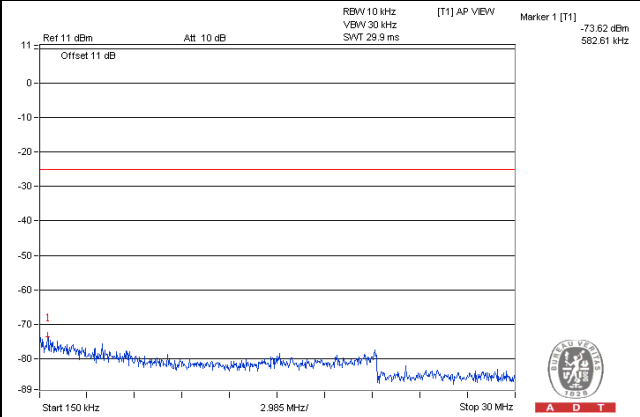
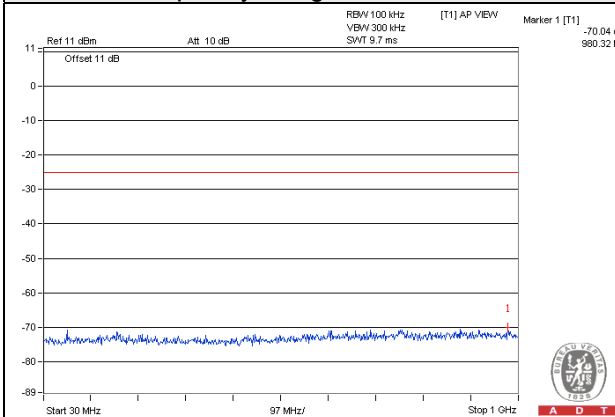
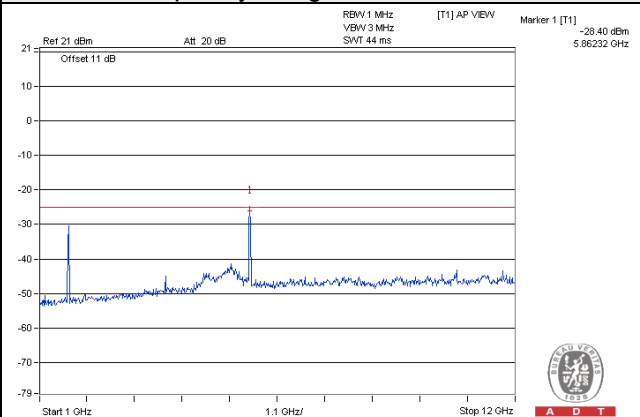
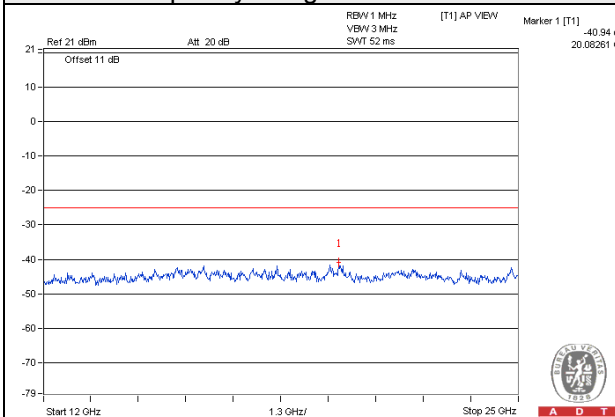
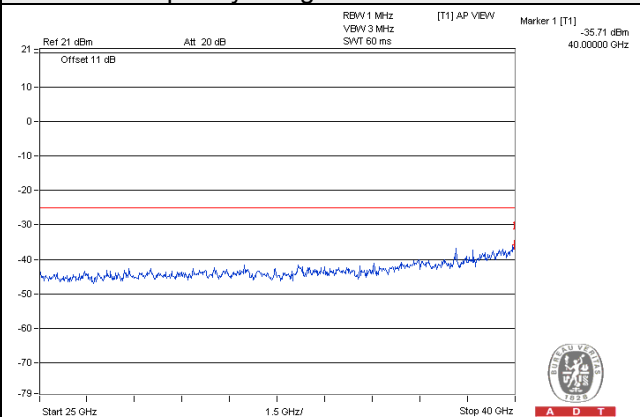
Data Rate 3Mbps
Channel 172
Frequency Range: 9kHz~150kHz

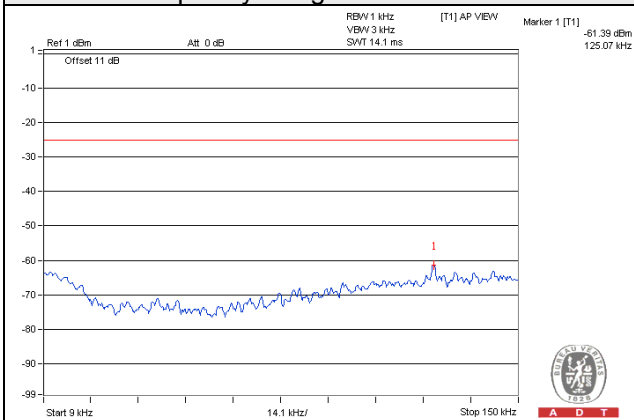
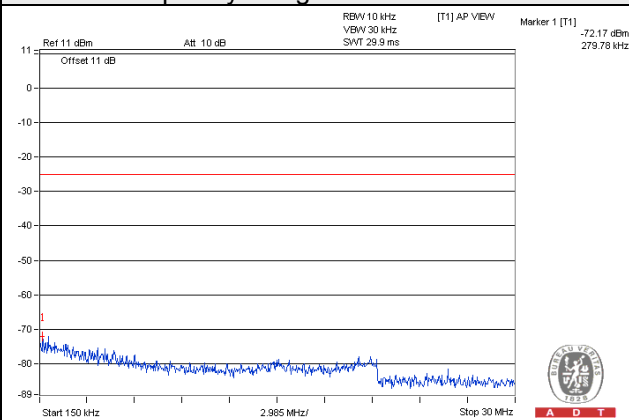
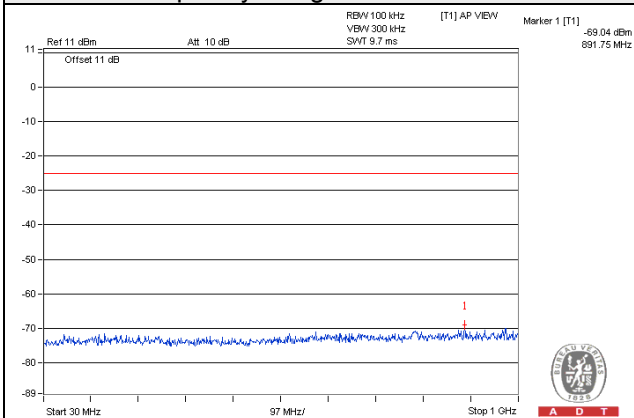
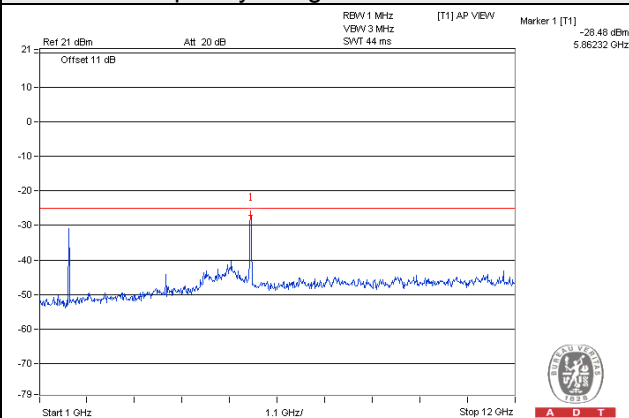
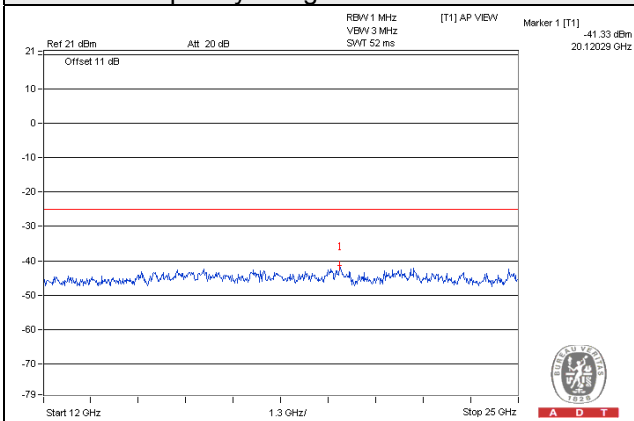
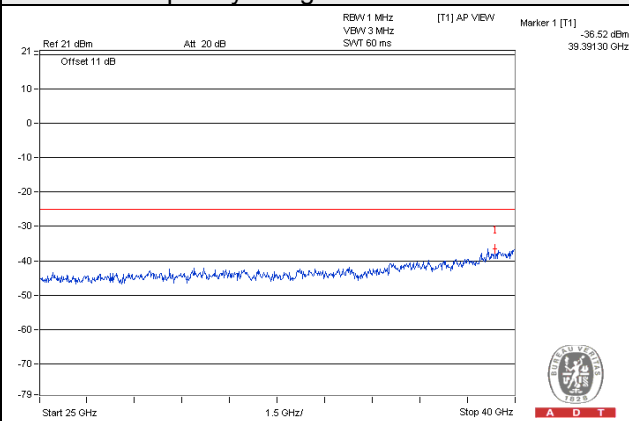
Frequency Range: 150kHz~30MHz

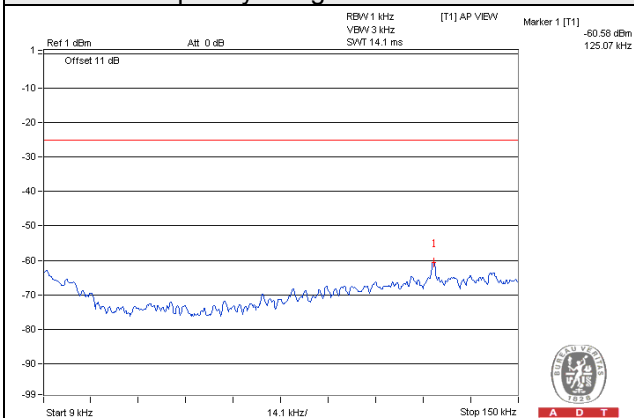
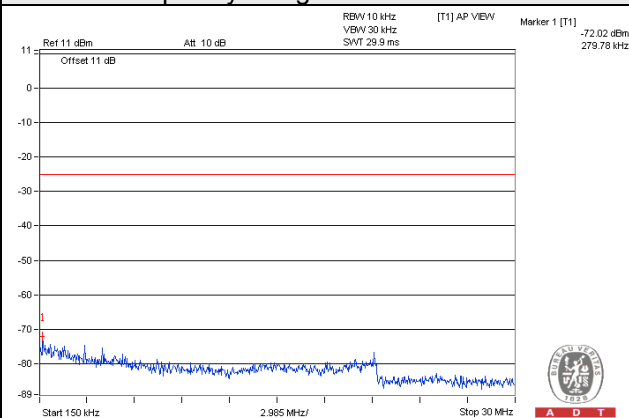
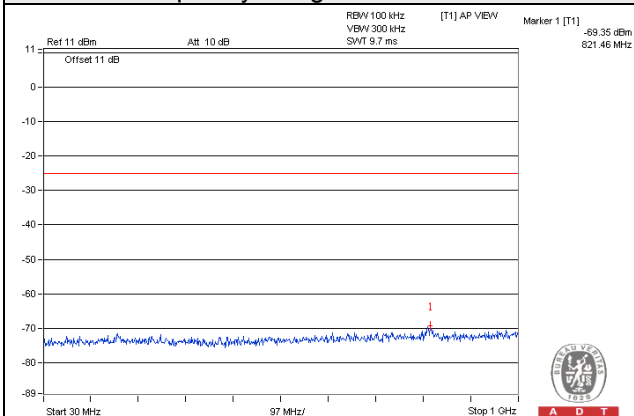
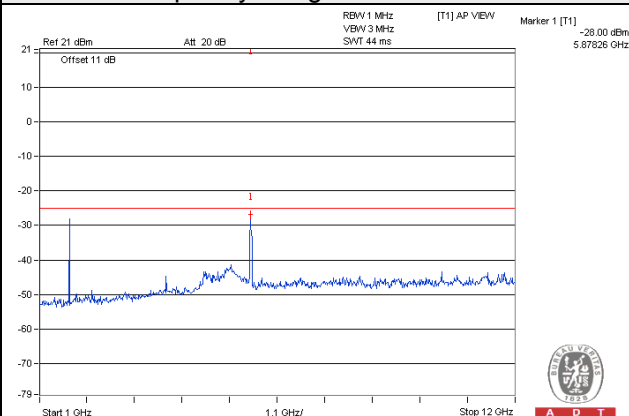
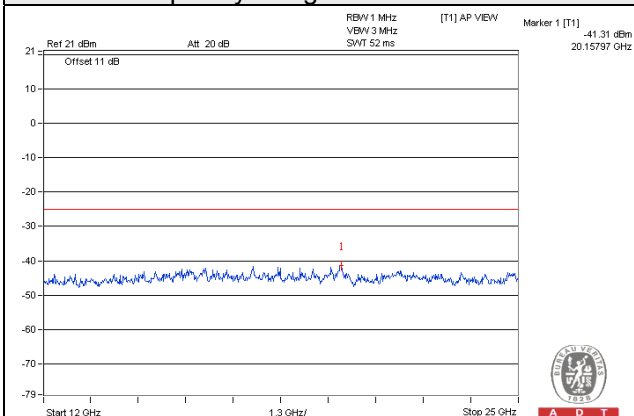
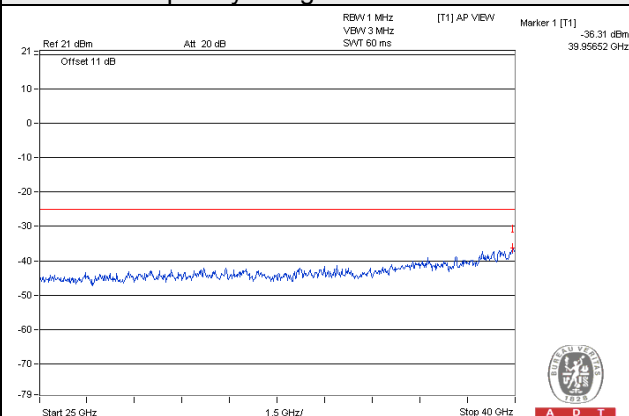
Frequency Range: 30MHz~1GHz

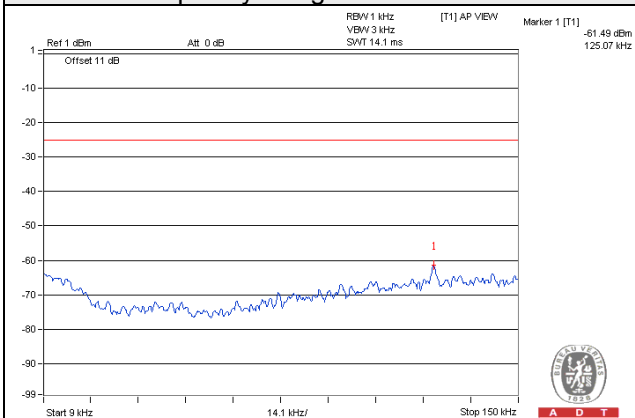
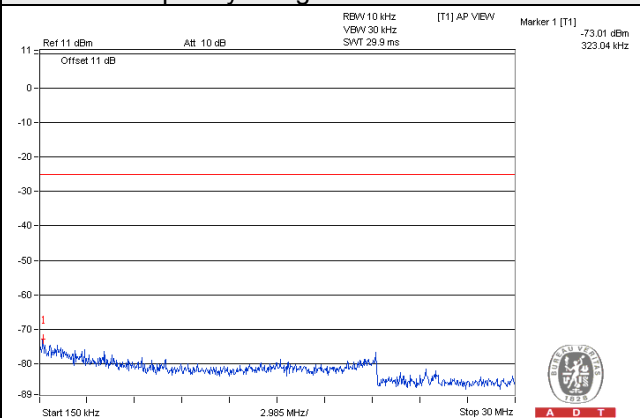
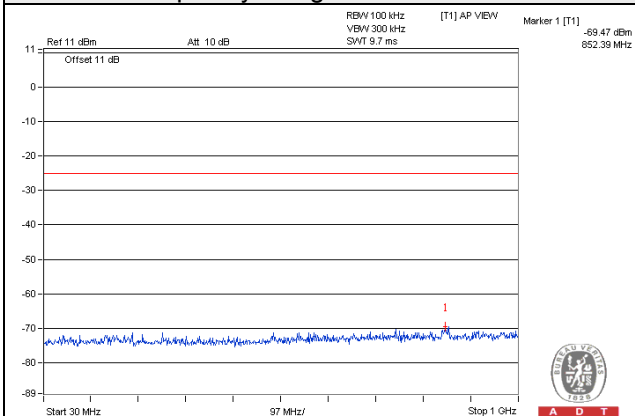
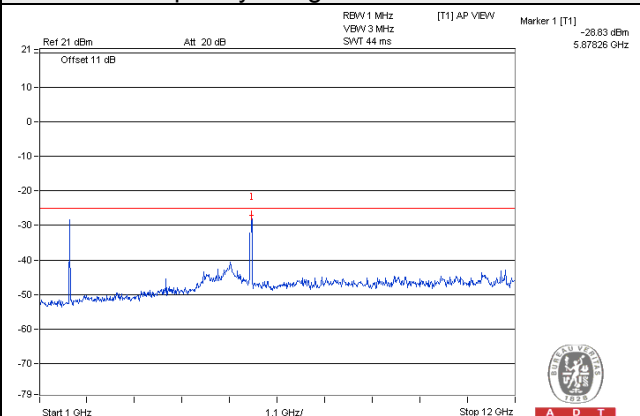
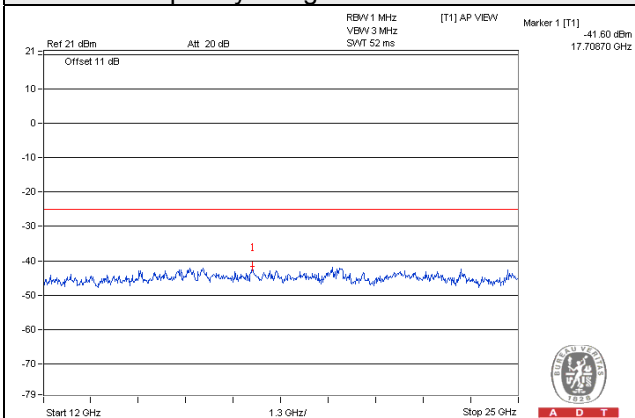
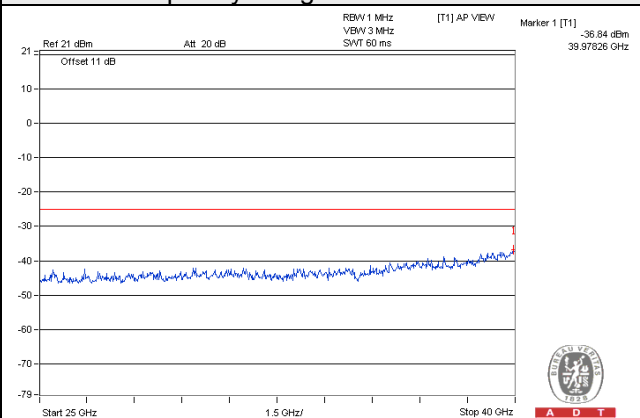
Frequency Range: 1GHz~12GHz

Frequency Range: 12GHz~25GHz

Frequency Range: 25GHz~40GHz

Data Rate 3Mbps
Channel 174
Frequency Range: 9kHz~150kHz

Frequency Range: 150kHz~30MHz

Frequency Range: 30MHz~1GHz

Frequency Range: 1GHz~12GHz

Frequency Range: 12GHz~25GHz

Frequency Range: 25GHz~40GHz

Data Rate 3Mbps
Channel 176
Frequency Range: 9kHz~150kHz

Frequency Range: 150kHz~30MHz

Frequency Range: 30MHz~1GHz

Frequency Range: 1GHz~12GHz

Frequency Range: 12GHz~25GHz

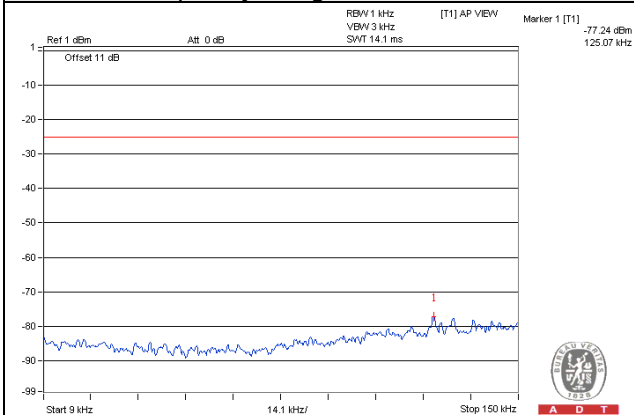
Frequency Range: 25GHz~40GHz

Data Rate 3Mbps
Channel 178
Frequency Range: 9kHz~150kHz

Frequency Range: 150kHz~30MHz

Frequency Range: 30MHz~1GHz

Frequency Range: 1GHz~12GHz

Frequency Range: 12GHz~25GHz

Frequency Range: 25GHz~40GHz

Data Rate 3Mbps

Channel 180

Frequency Range: 9kHz~150kHz



Frequency Range: 150kHz~30MHz

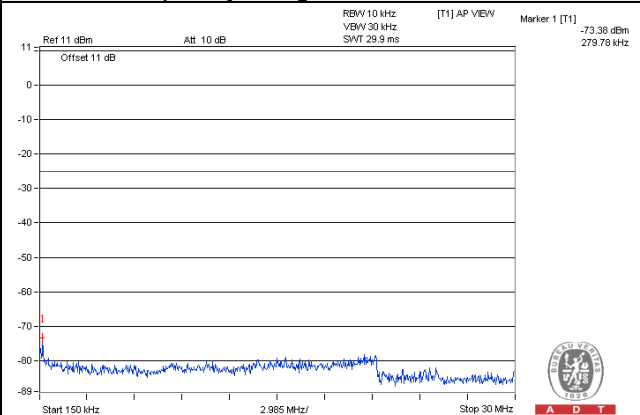

Frequency Range: 30MHz~1GHz

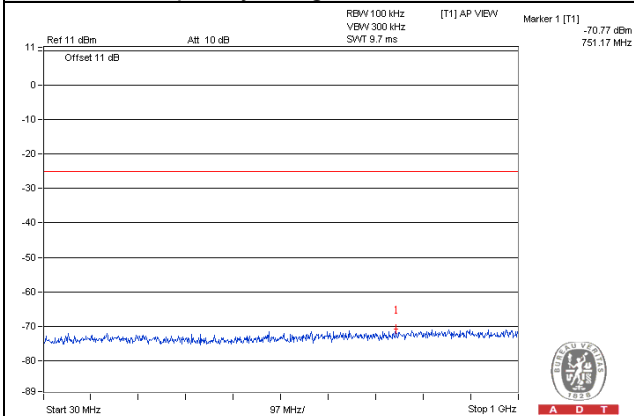

Frequency Range: 1GHz~12GHz

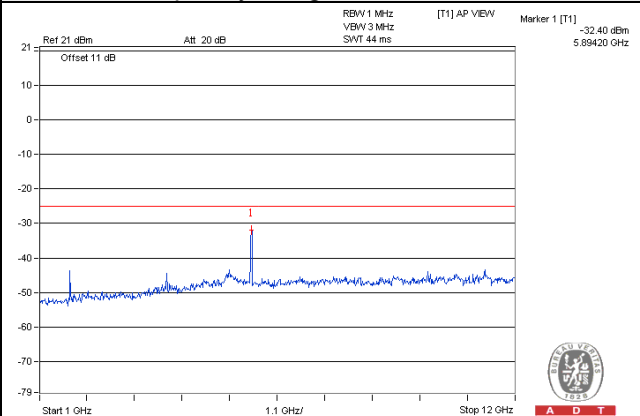

Frequency Range: 12GHz~25GHz

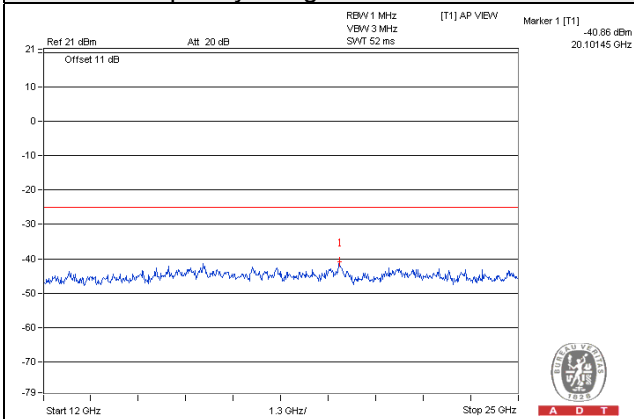

Frequency Range: 25GHz~40GHz

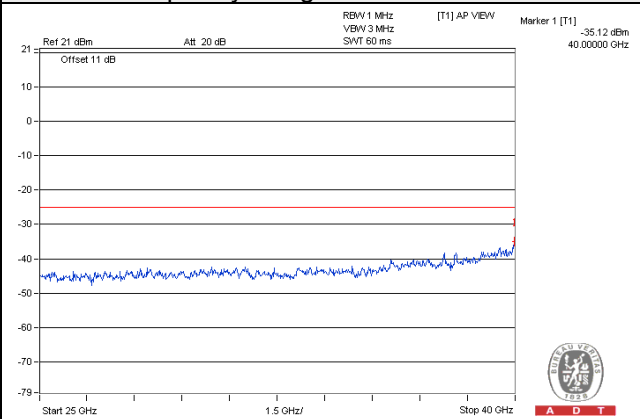

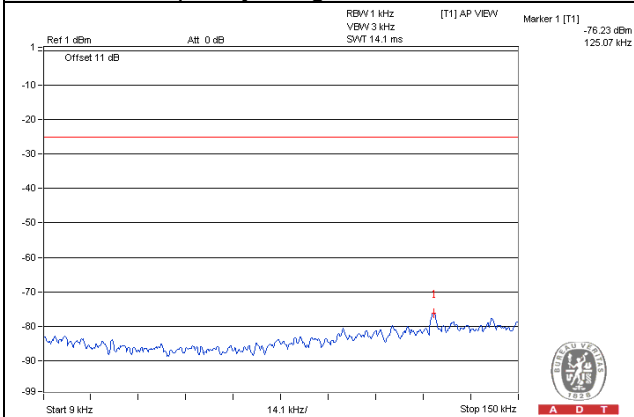
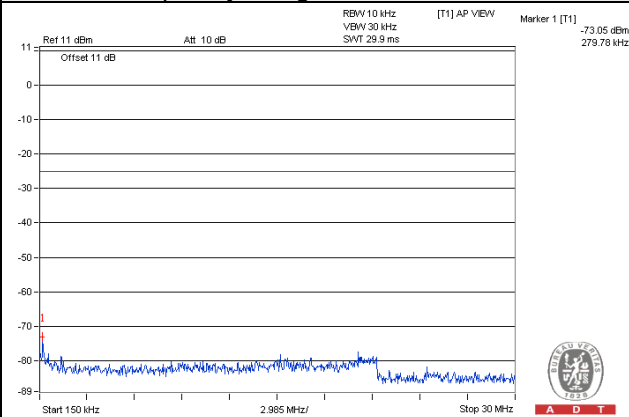
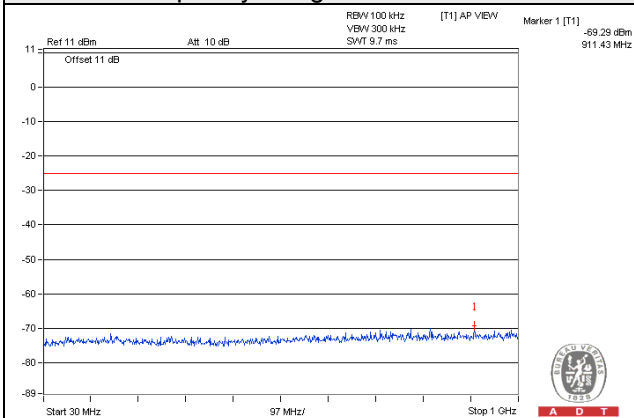
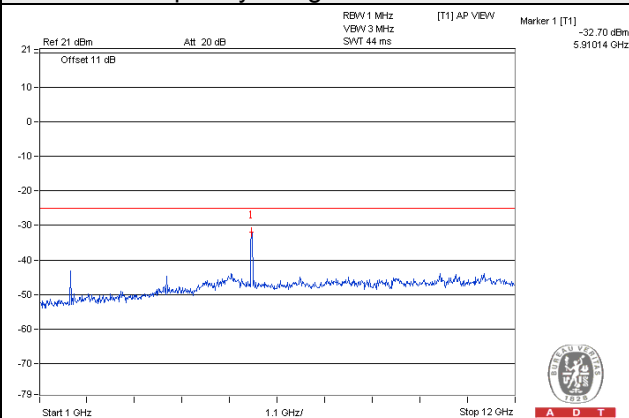
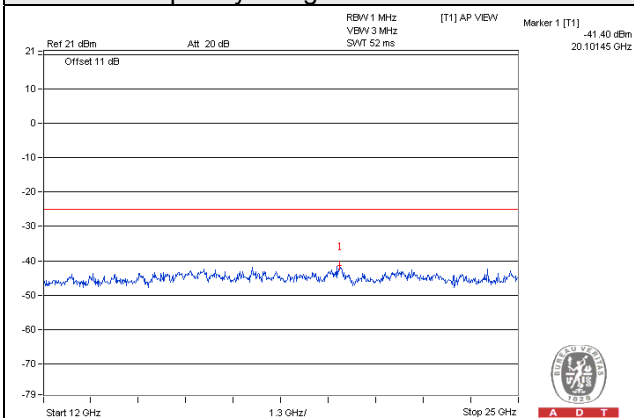
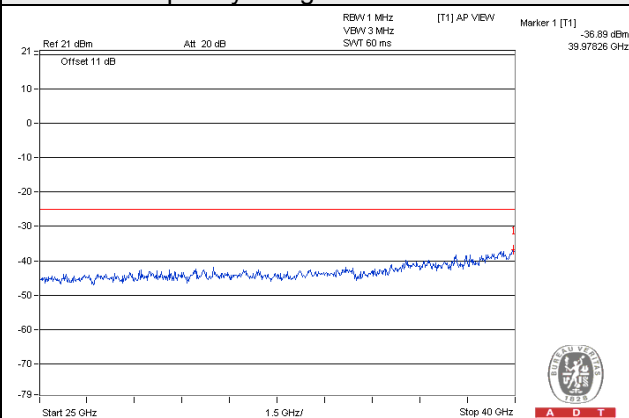
Data Rate 3Mbps
Channel 182
Frequency Range: 9kHz~150kHz

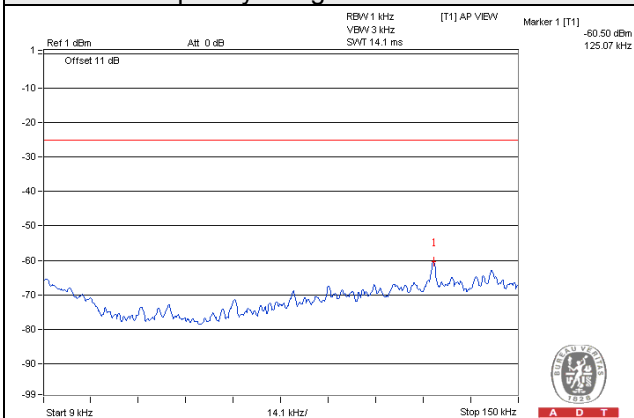
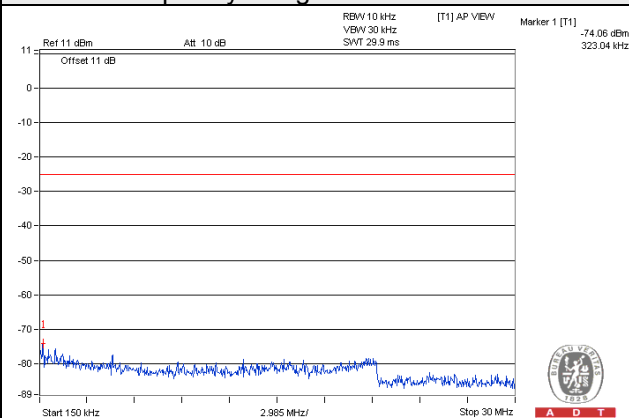
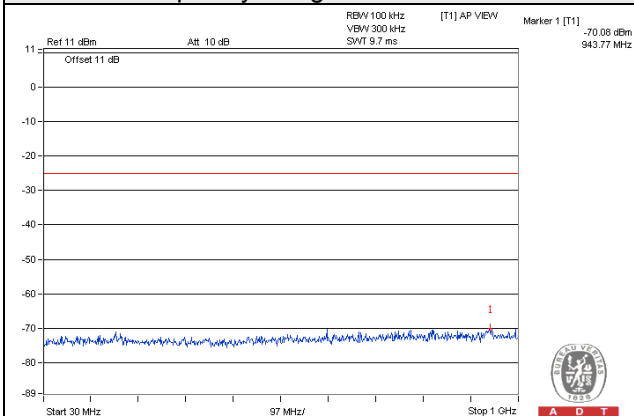
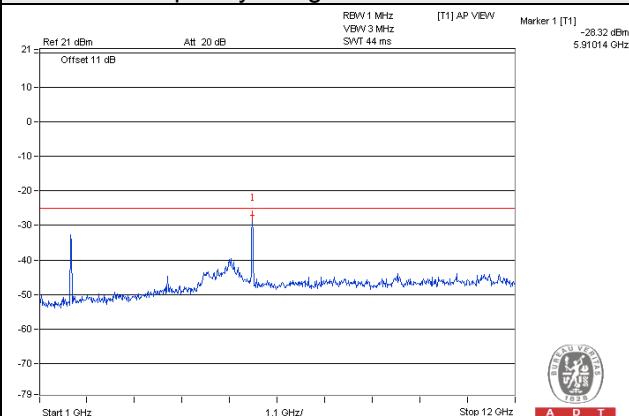
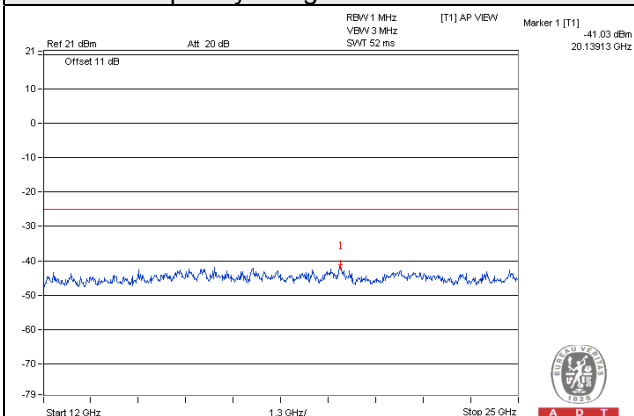
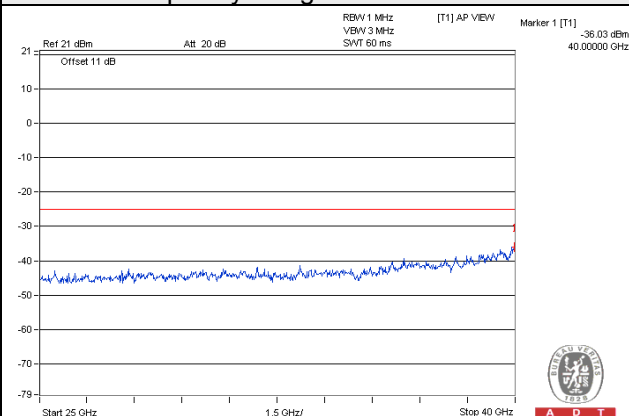
Frequency Range: 150kHz~30MHz

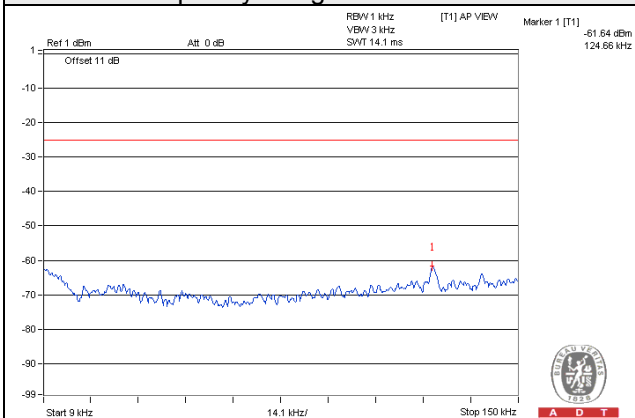
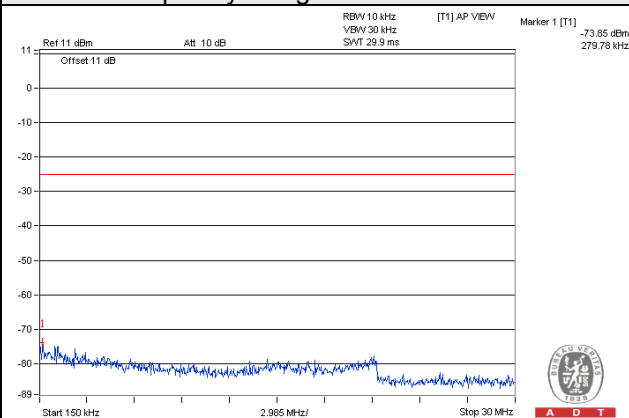
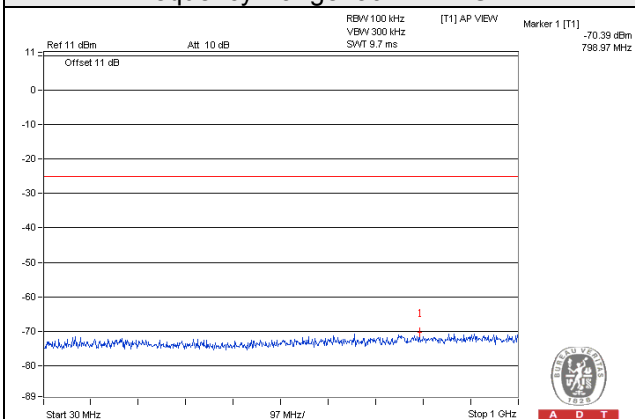
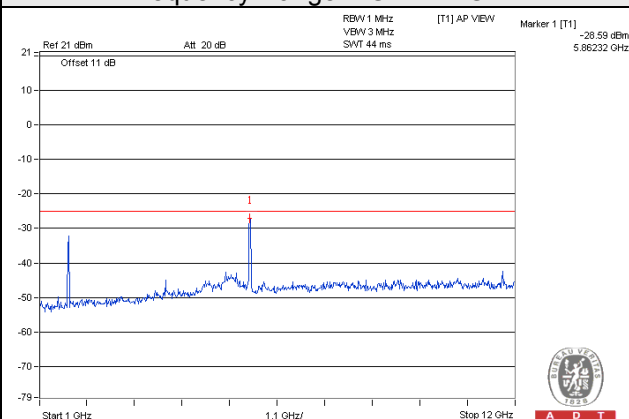
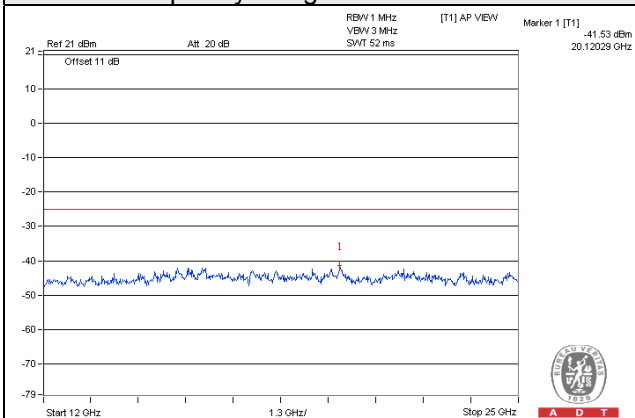
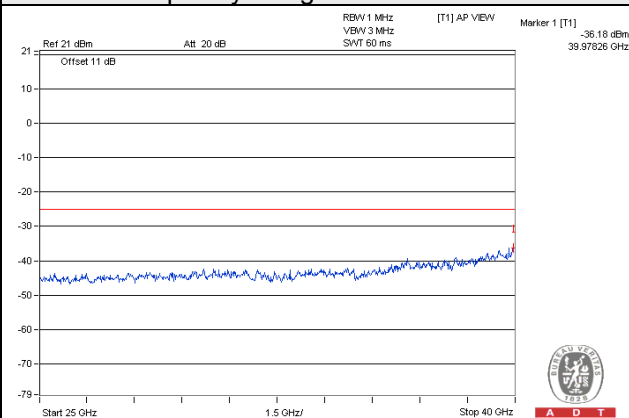
Frequency Range: 30MHz~1GHz

Frequency Range: 1GHz~12GHz

Frequency Range: 12GHz~25GHz

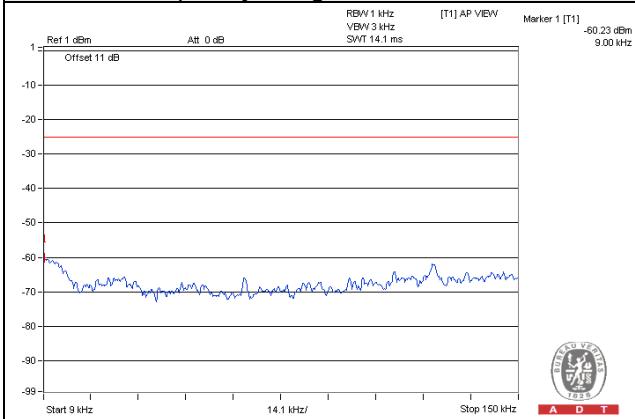
Frequency Range: 25GHz~40GHz

Data Rate 3Mbps
Channel 184
Frequency Range: 9kHz~150kHz

Frequency Range: 150kHz~30MHz

Frequency Range: 30MHz~1GHz

Frequency Range: 1GHz~12GHz

Frequency Range: 12GHz~25GHz

Frequency Range: 25GHz~40GHz

Data Rate 27Mbps
Channel 172
Frequency Range: 9kHz~150kHz

Frequency Range: 150kHz~30MHz

Frequency Range: 30MHz~1GHz

Frequency Range: 1GHz~12GHz

Frequency Range: 12GHz~25GHz

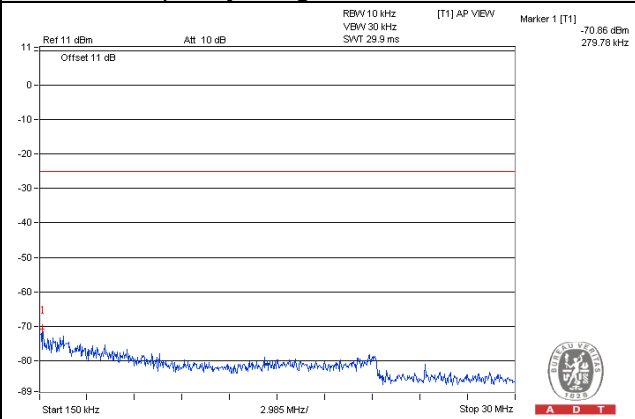
Frequency Range: 25GHz~40GHz

Data Rate 27Mbps
Channel 174

Frequency Range: 9kHz~150kHz



Frequency Range: 150kHz~30MHz



Frequency Range: 30MHz~1GHz

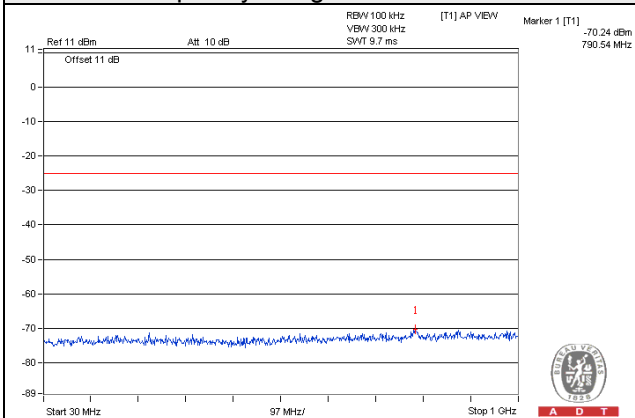

Frequency Range: 1GHz~12GHz

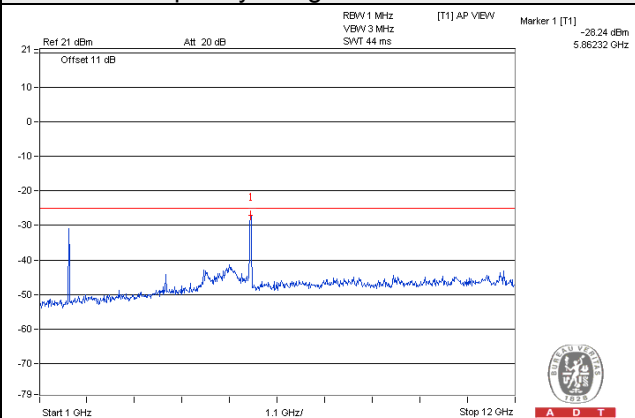

Frequency Range: 12GHz~25GHz

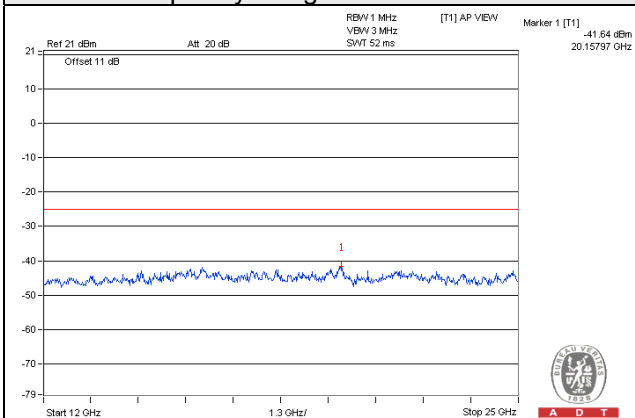

Frequency Range: 25GHz~40GHz

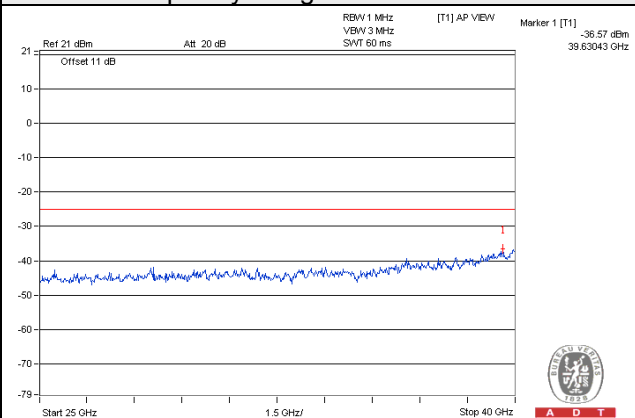

Data Rate 27Mbps
Channel 176

Frequency Range: 9kHz~150kHz

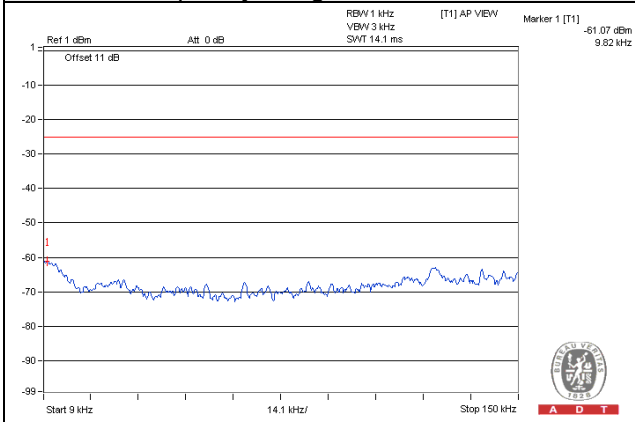

Frequency Range: 150kHz~30MHz

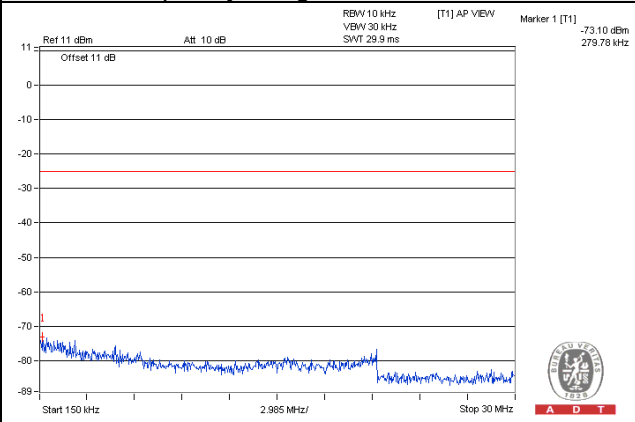

Frequency Range: 30MHz~1GHz

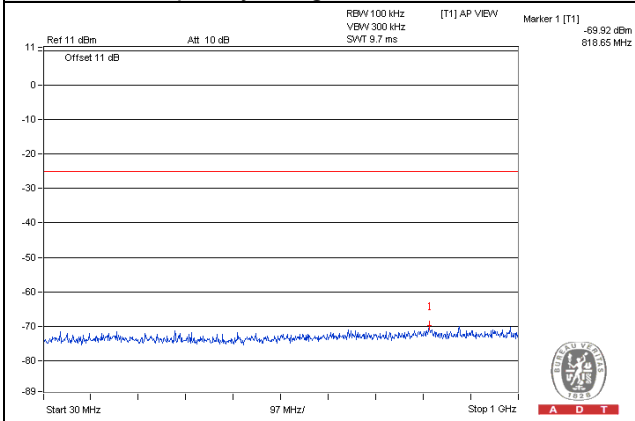

Frequency Range: 1GHz~12GHz

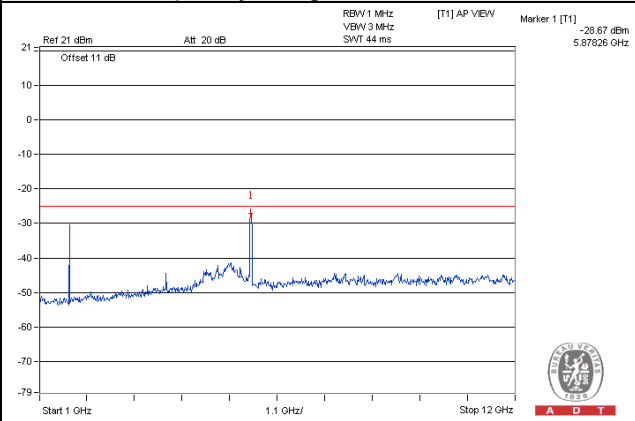

Frequency Range: 12GHz~25GHz

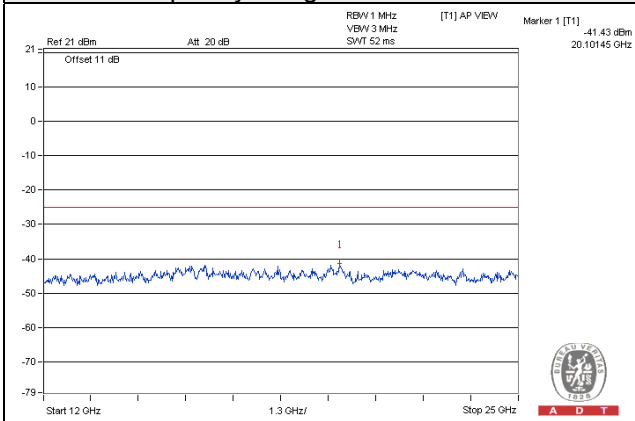

Frequency Range: 25GHz~40GHz

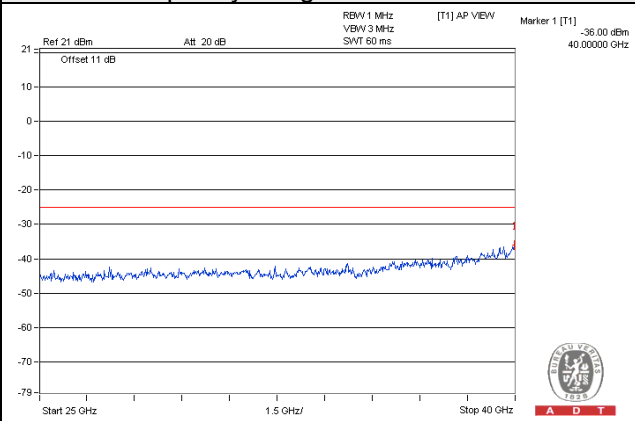

Data Rate 27Mbps

Channel 178

Frequency Range: 9kHz~150kHz

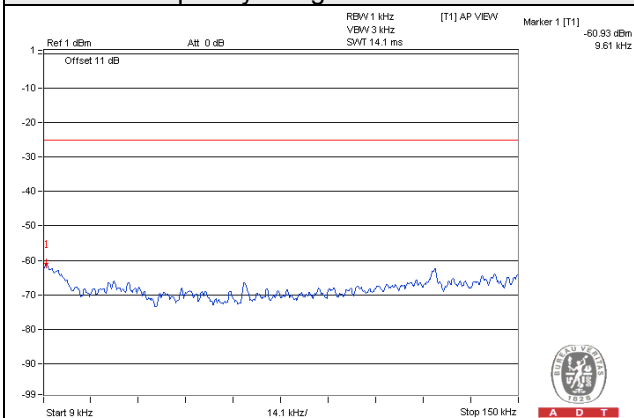

Frequency Range: 150kHz~30MHz

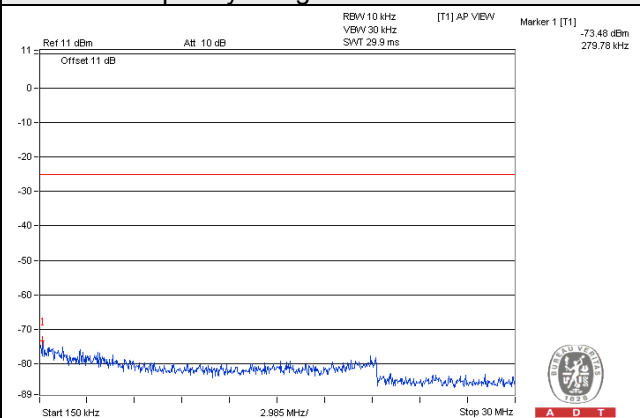

Frequency Range: 30MHz~1GHz

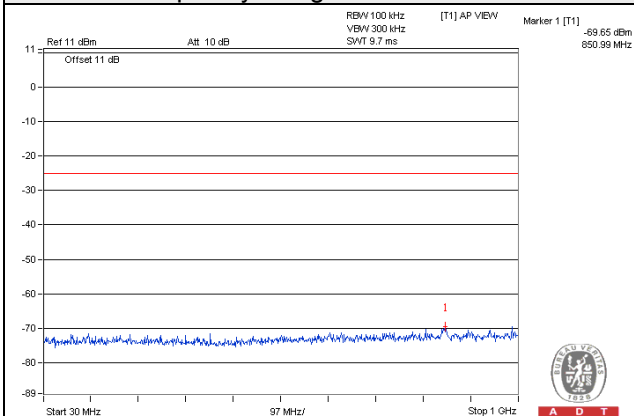

Frequency Range: 1GHz~12GHz

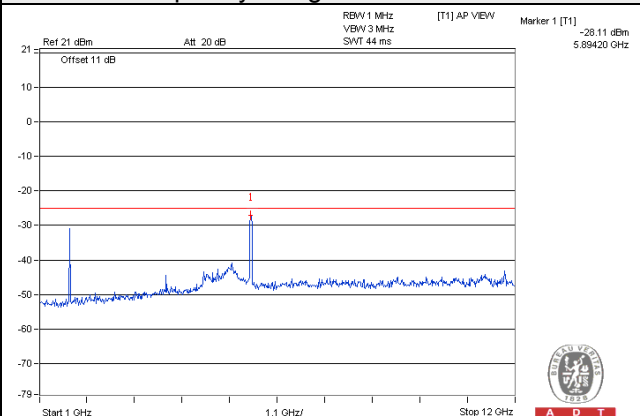

Frequency Range: 12GHz~25GHz

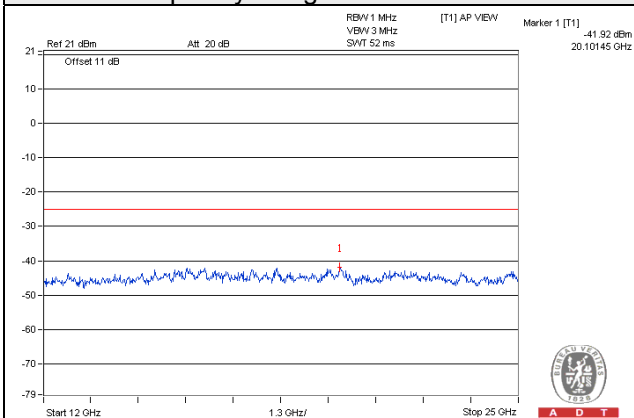

Frequency Range: 25GHz~40GHz

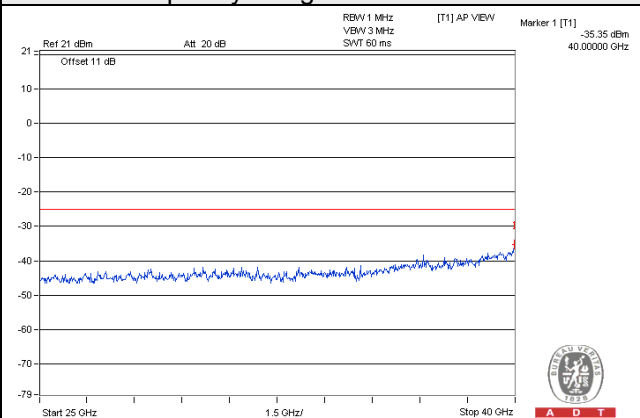

Data Rate 27Mbps
Channel 180

Frequency Range: 9kHz~150kHz

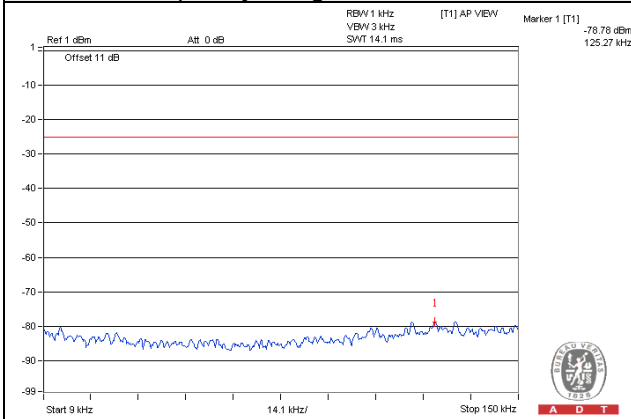

Frequency Range: 150kHz~30MHz

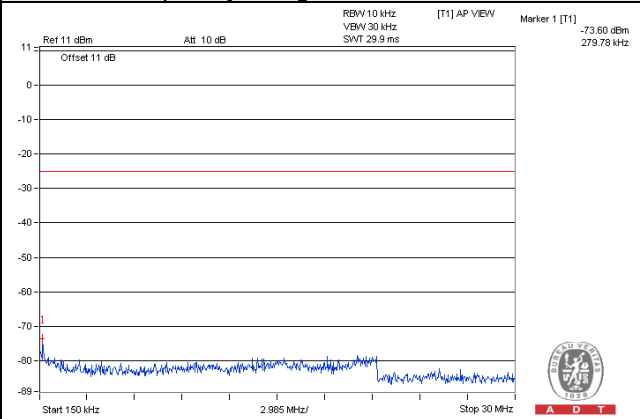

Frequency Range: 30MHz~1GHz

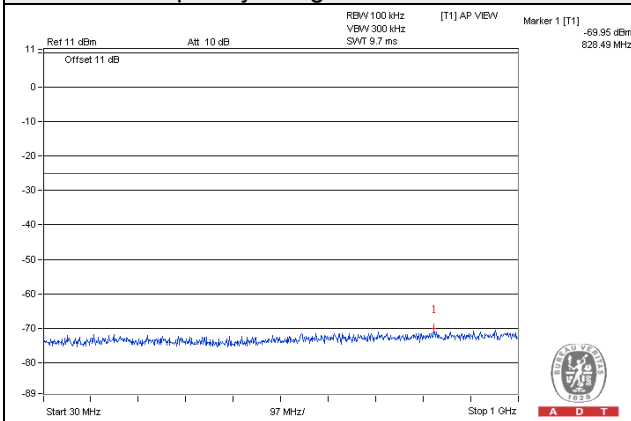

Frequency Range: 1GHz~12GHz

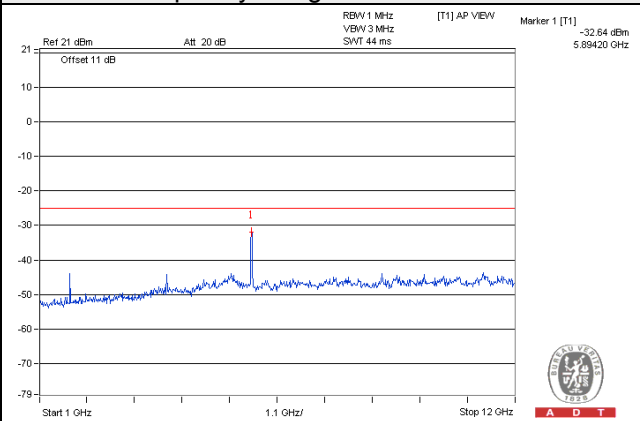

Frequency Range: 12GHz~25GHz

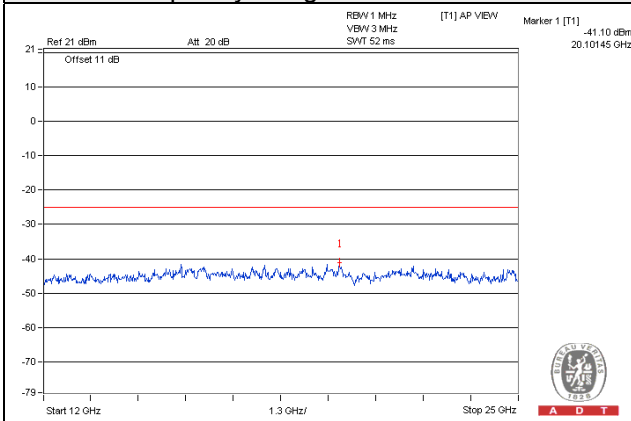

Frequency Range: 25GHz~40GHz

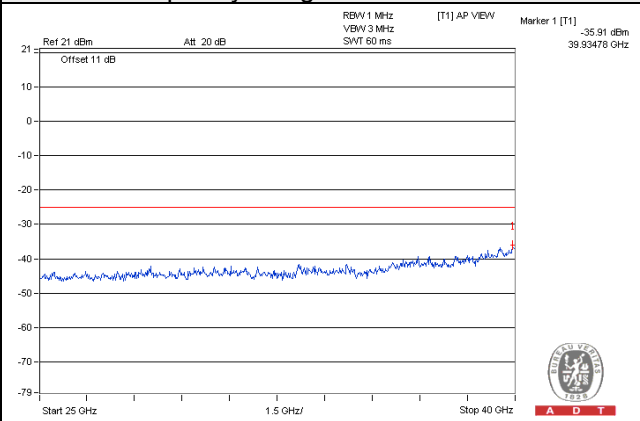

Data Rate 27Mbps
Channel 182

Frequency Range: 9kHz~150kHz

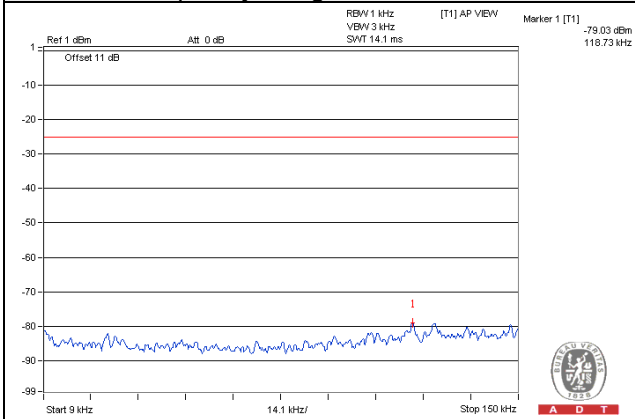

Frequency Range: 150kHz~30MHz

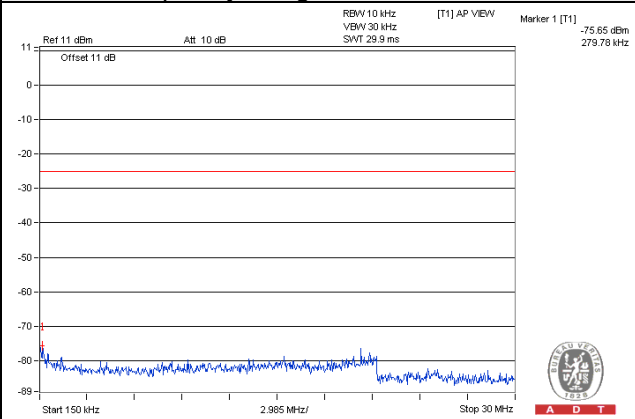

Frequency Range: 30MHz~1GHz

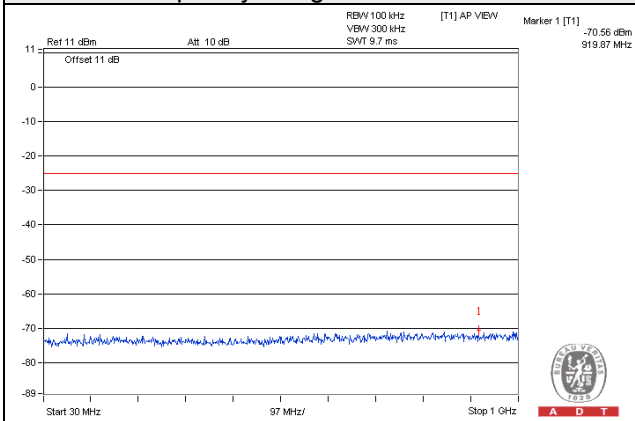

Frequency Range: 1GHz~12GHz

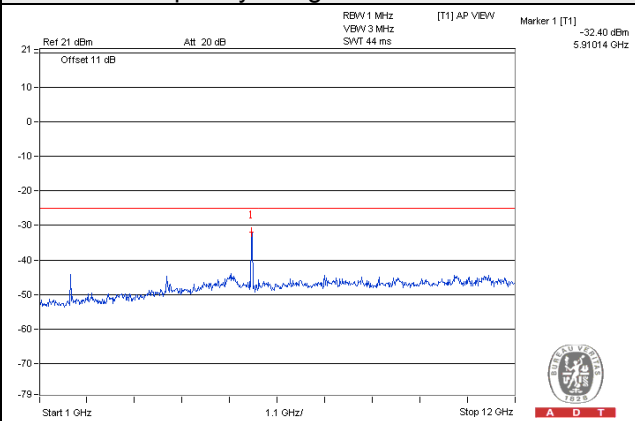

Frequency Range: 12GHz~25GHz

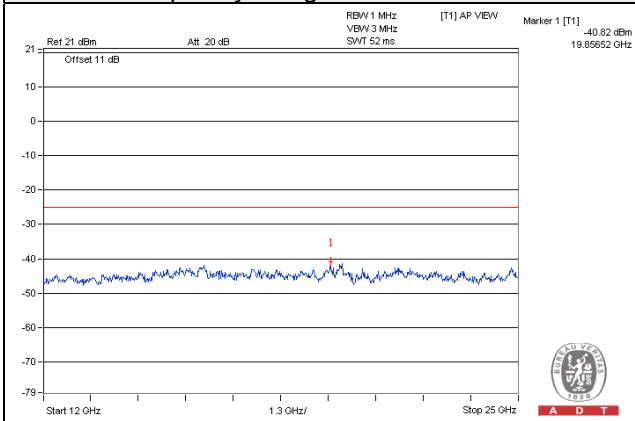

Frequency Range: 25GHz~40GHz

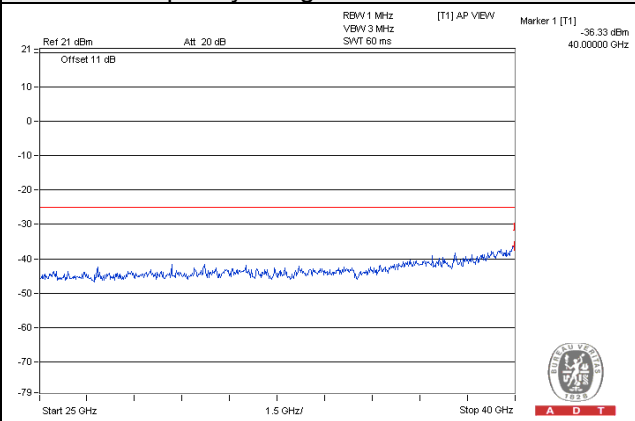

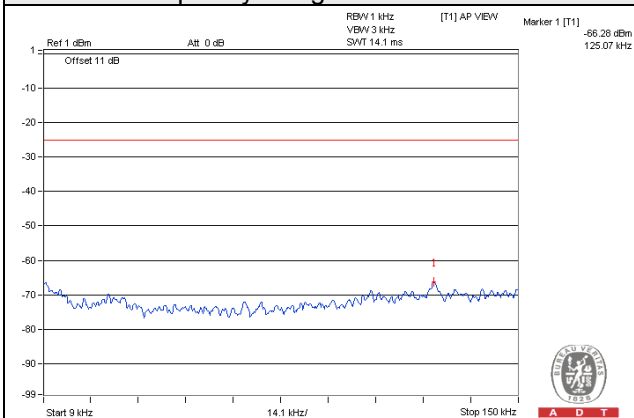
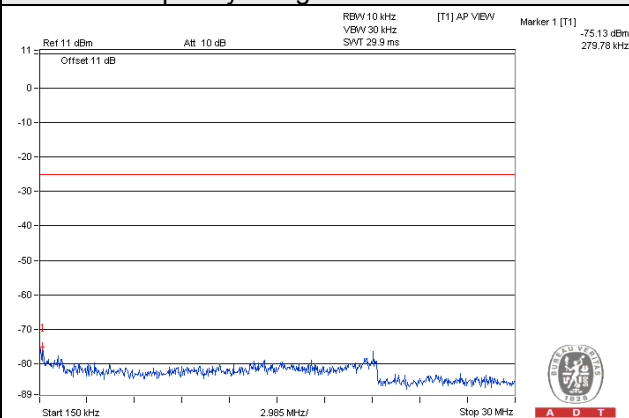
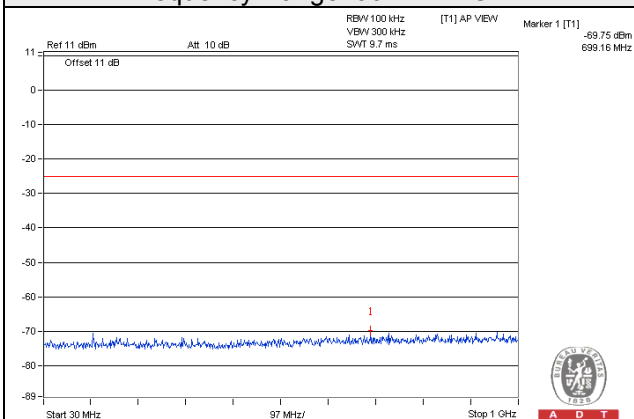
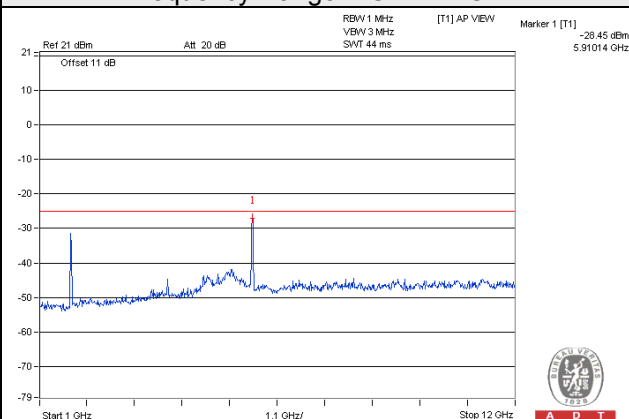
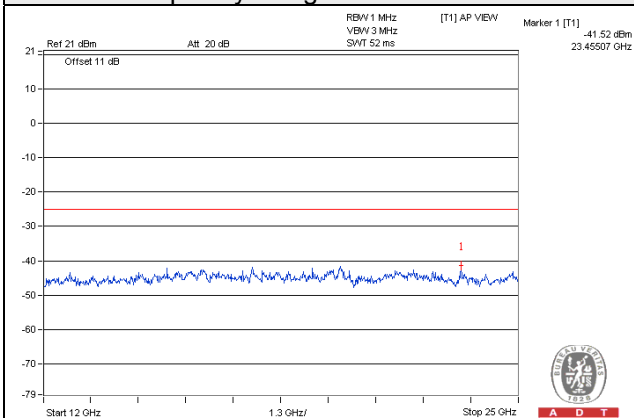
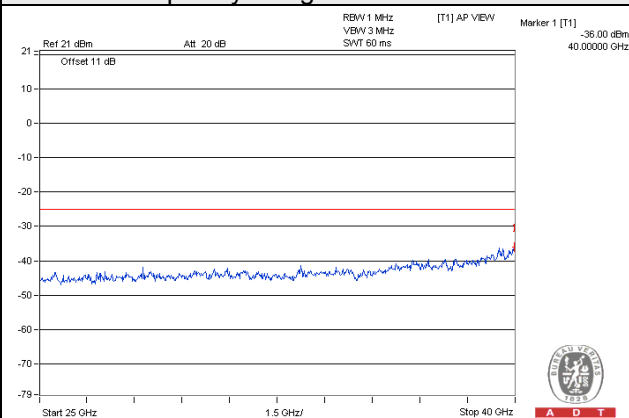
Data Rate 27Mbps
Channel 184
Frequency Range: 9kHz~150kHz

Frequency Range: 150kHz~30MHz

Frequency Range: 30MHz~1GHz

Frequency Range: 1GHz~12GHz

Frequency Range: 12GHz~25GHz

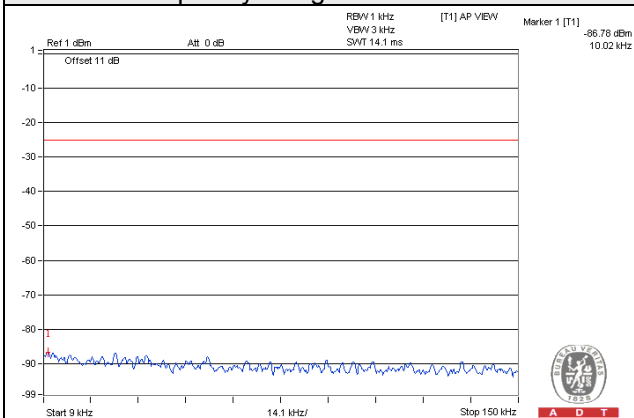
Frequency Range: 25GHz~40GHz

Channel Bandwidth 20MHz

Data Rate 6Mbps

Channel 175

Frequency Range: 9kHz~150kHz



Frequency Range: 150kHz~30MHz

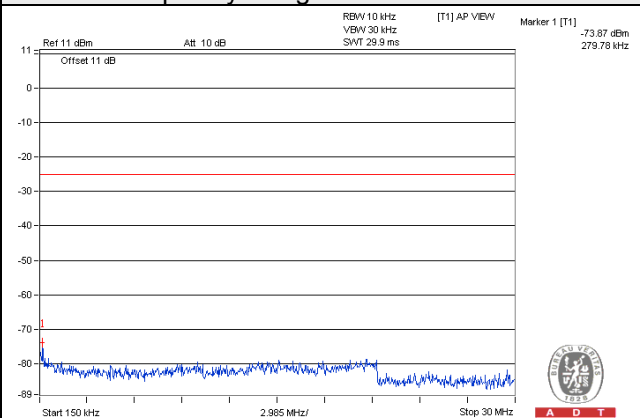

Frequency Range: 30MHz~1GHz

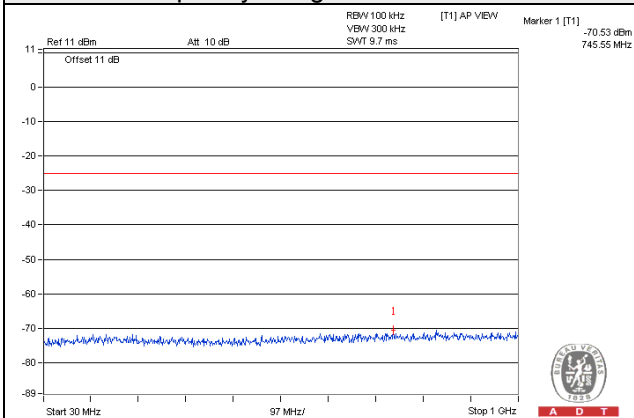

Frequency Range: 1GHz~12GHz

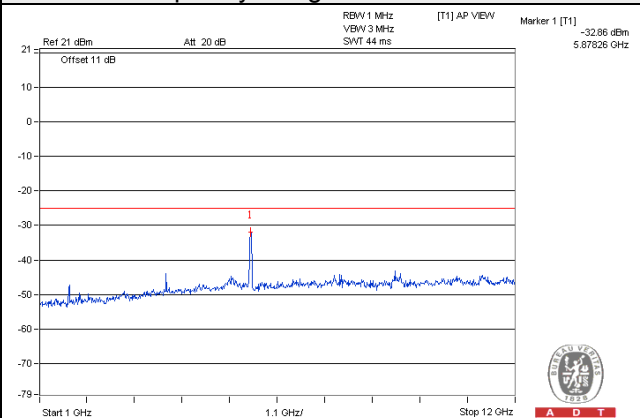

Frequency Range: 12GHz~25GHz

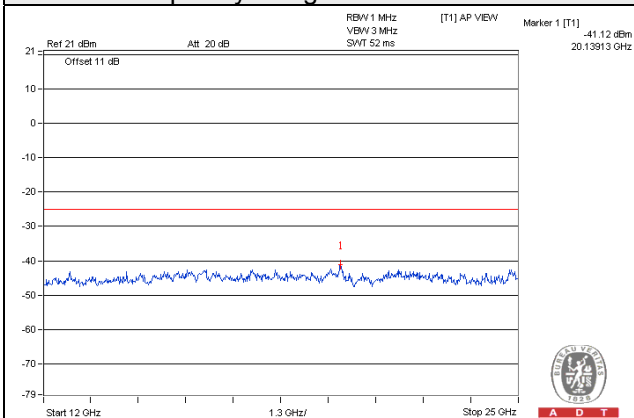

Frequency Range: 25GHz~40GHz

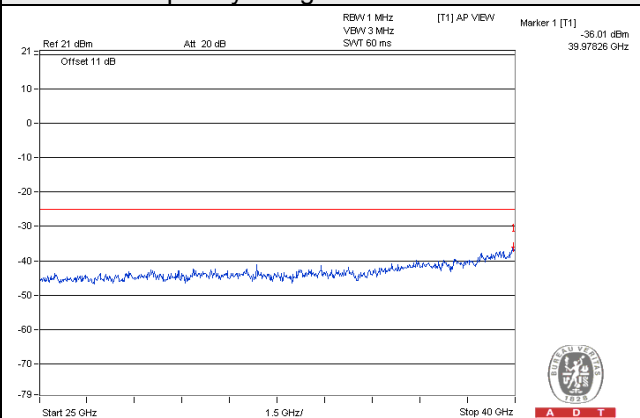

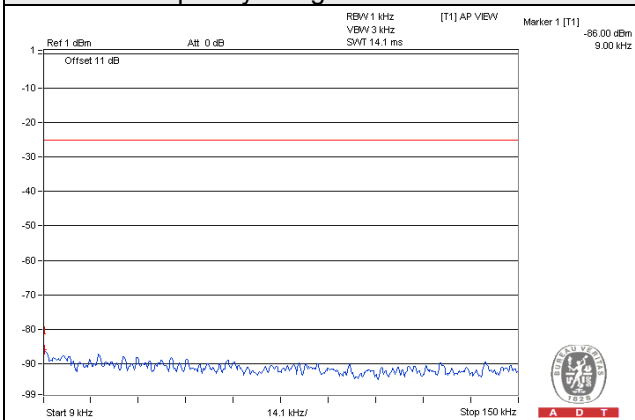
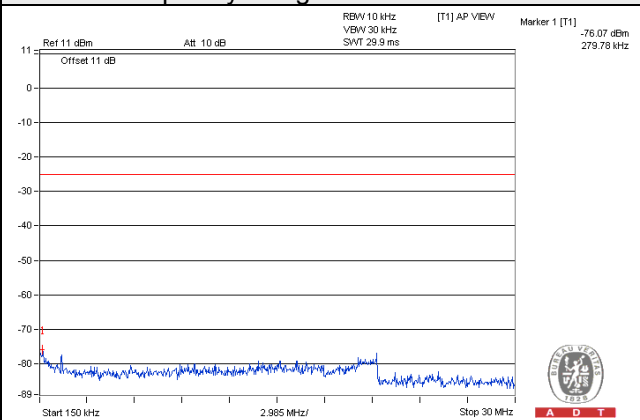
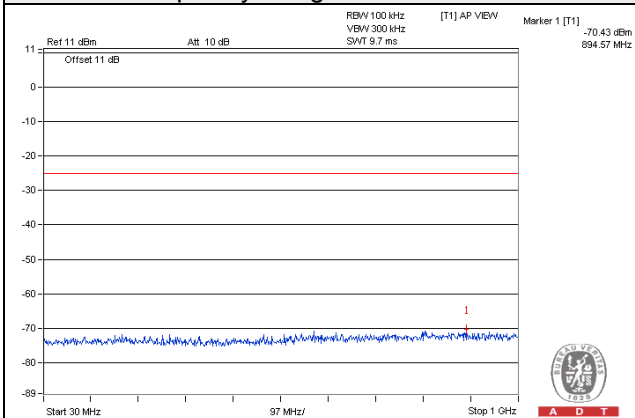
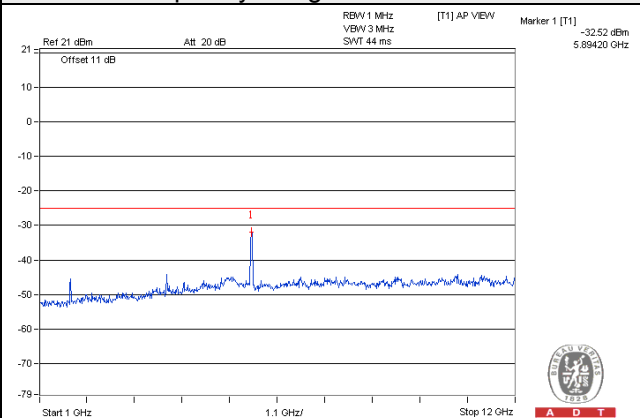
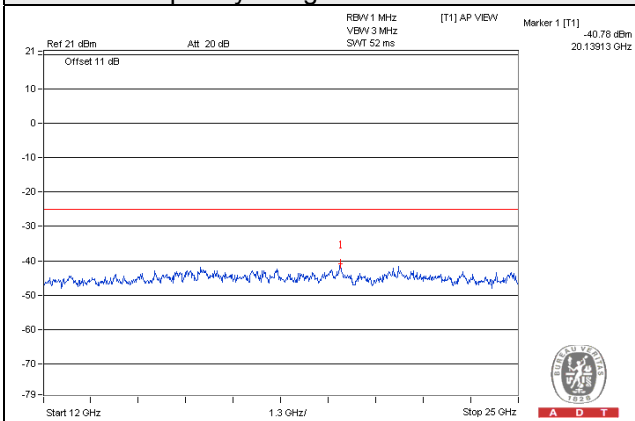
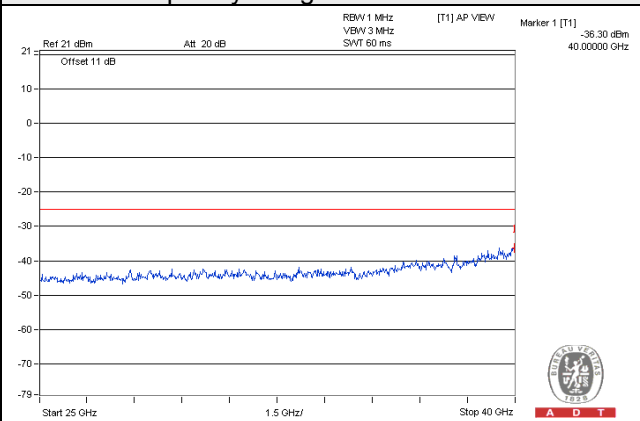
Data Rate 6Mbps
Channel 181
Frequency Range: 9kHz~150kHz

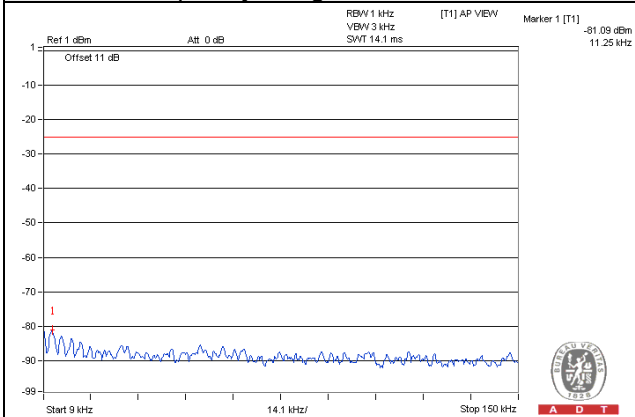
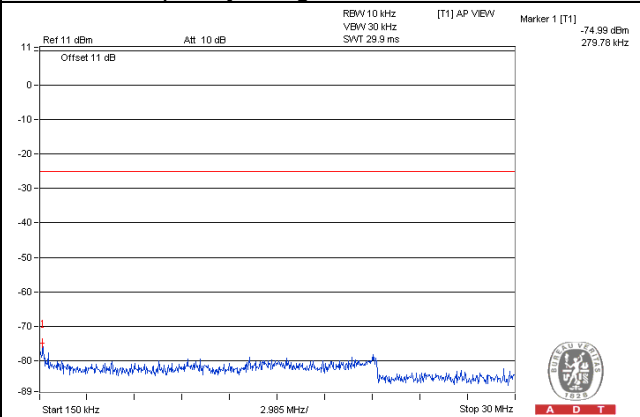
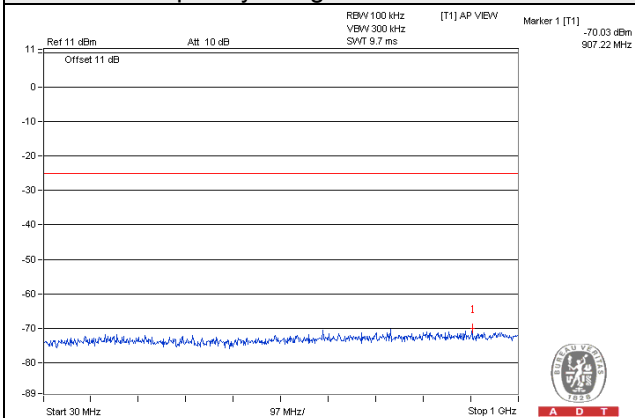
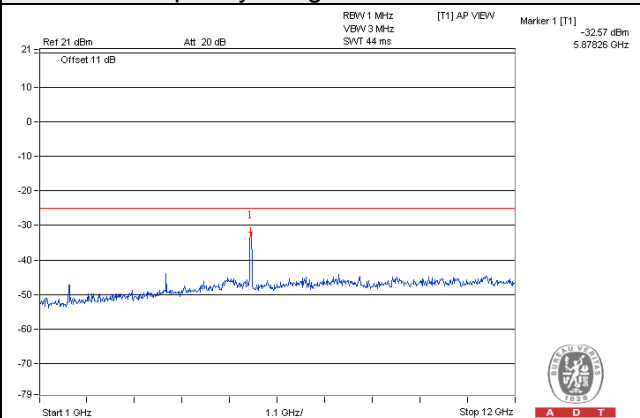
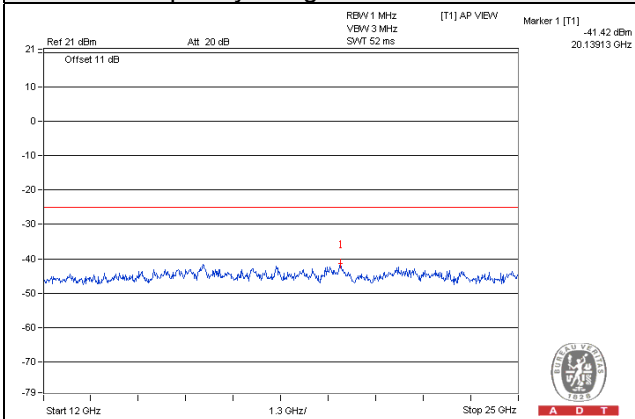
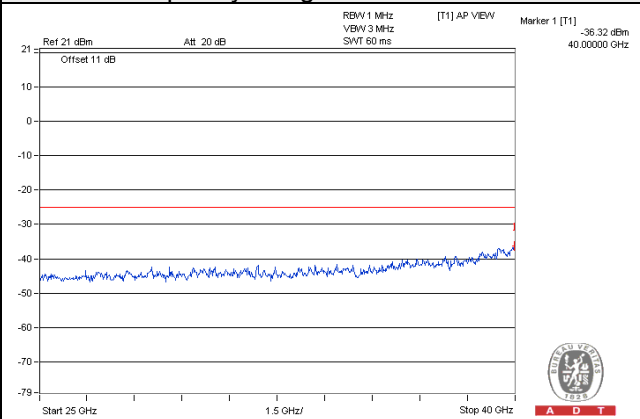
Frequency Range: 150kHz~30MHz

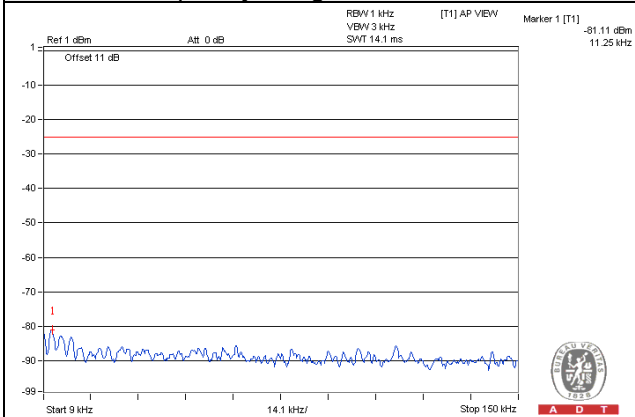
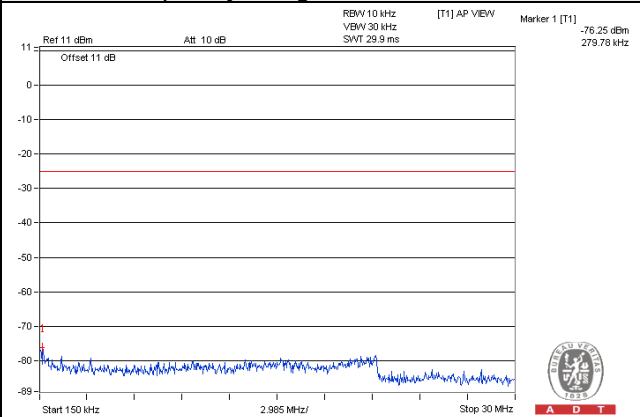
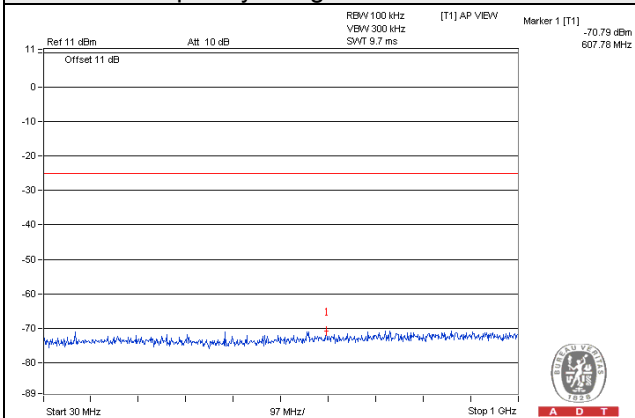
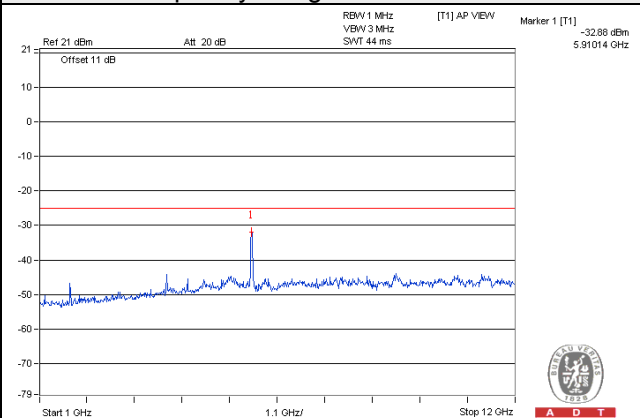
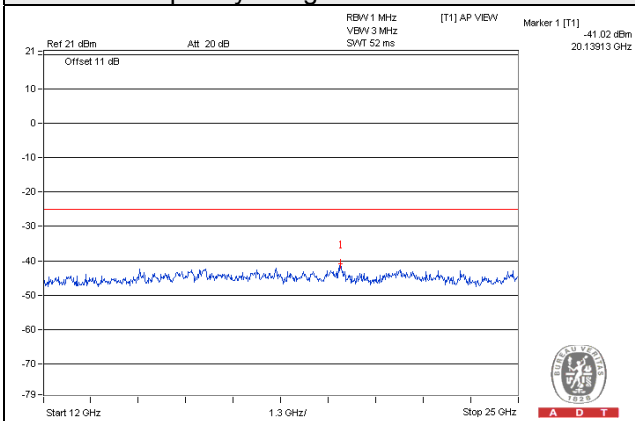
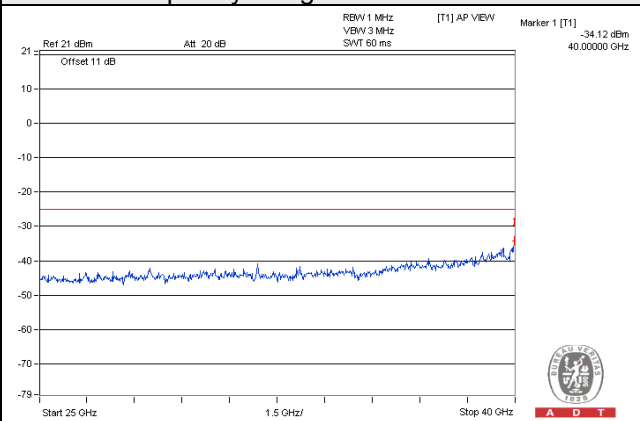
Frequency Range: 30MHz~1GHz

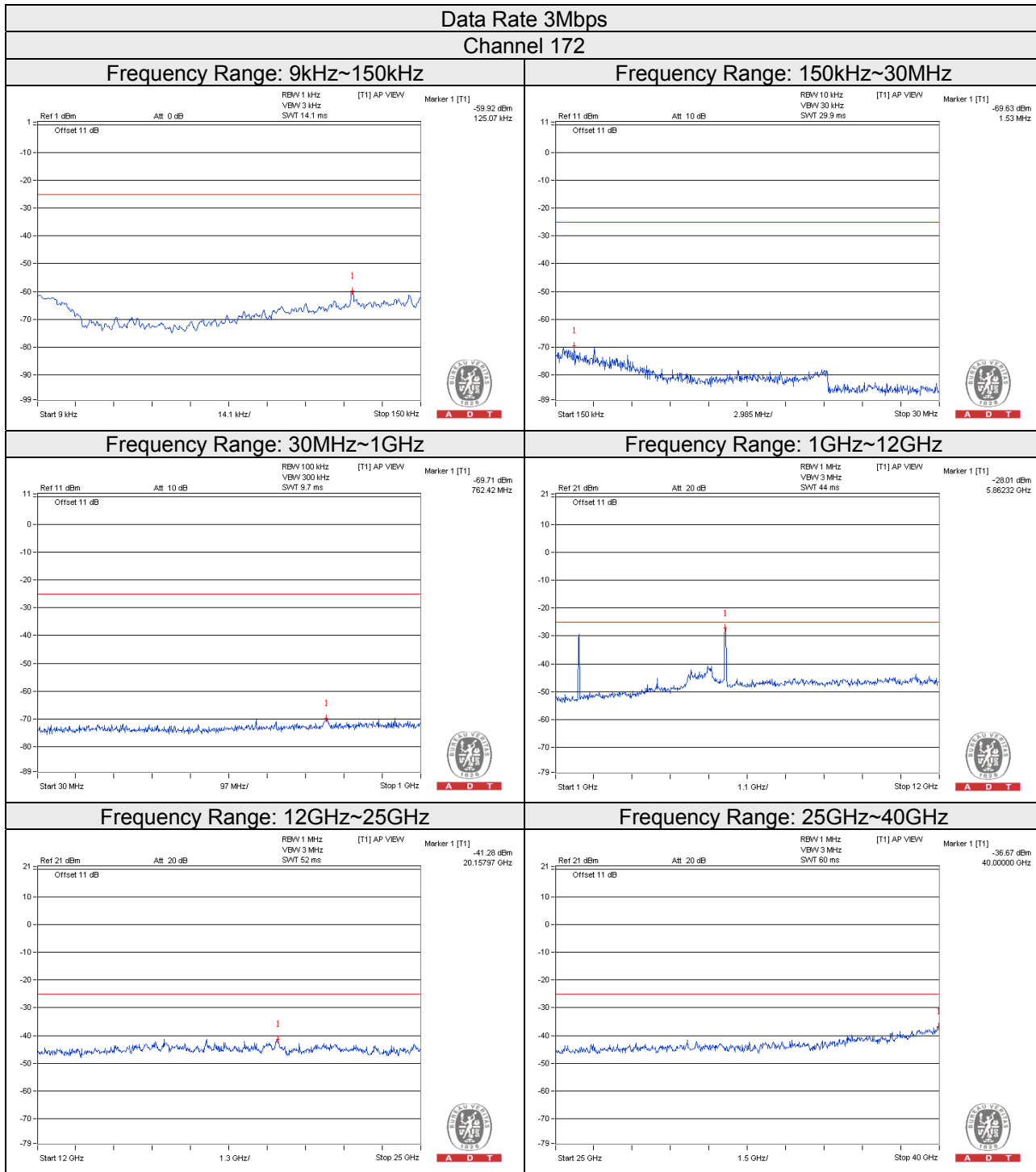
Frequency Range: 1GHz~12GHz

Frequency Range: 12GHz~25GHz

Frequency Range: 25GHz~40GHz

Data Rate 54Mbps
Channel 175
Frequency Range: 9kHz~150kHz

Frequency Range: 150kHz~30MHz

Frequency Range: 30MHz~1GHz

Frequency Range: 1GHz~12GHz

Frequency Range: 12GHz~25GHz

Frequency Range: 25GHz~40GHz

Data Rate 54Mbps
Channel 181
Frequency Range: 9kHz~150kHz

Frequency Range: 150kHz~30MHz

Frequency Range: 30MHz~1GHz

Frequency Range: 1GHz~12GHz

Frequency Range: 12GHz~25GHz

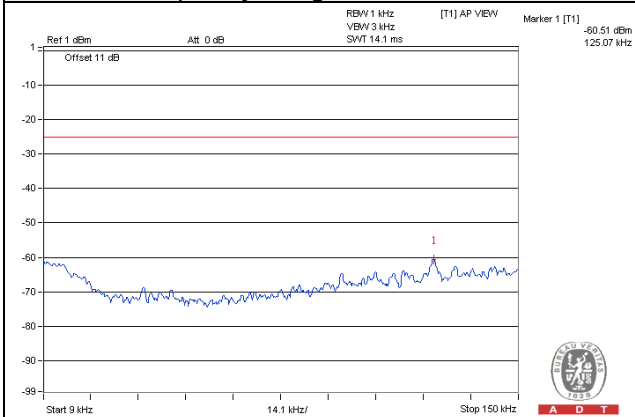
Frequency Range: 25GHz~40GHz

Mode B
Channel Bandwidth 10MHz

Data Rate 3Mbps

Channel 174

Frequency Range: 9kHz~150kHz



Frequency Range: 150kHz~30MHz

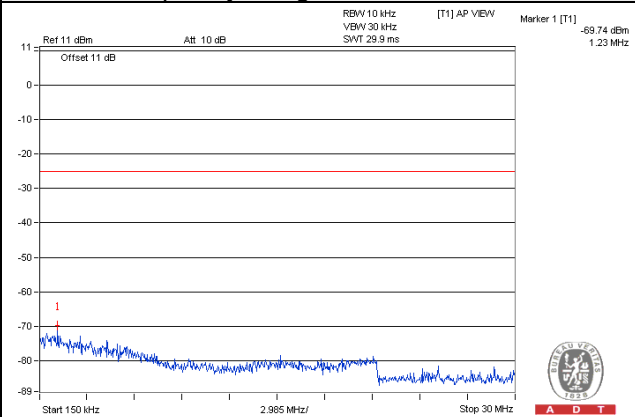

Frequency Range: 30MHz~1GHz

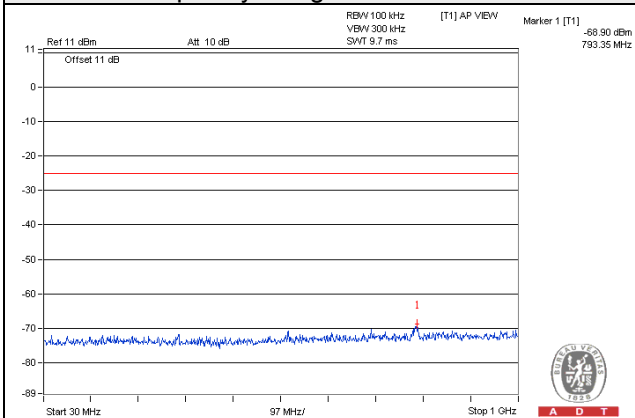

Frequency Range: 1GHz~12GHz

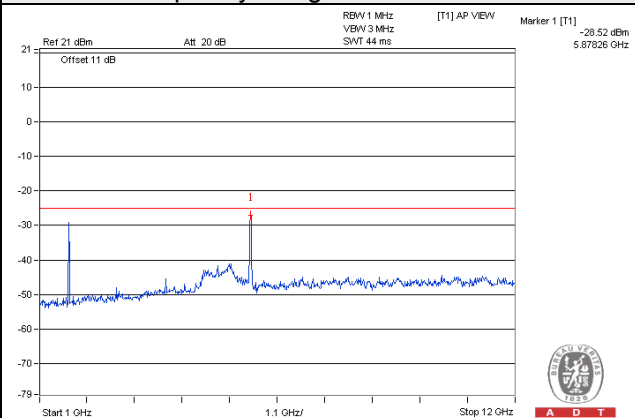

Frequency Range: 12GHz~25GHz

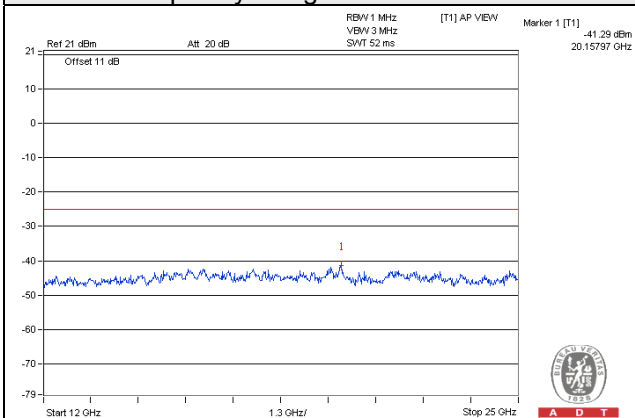

Frequency Range: 25GHz~40GHz

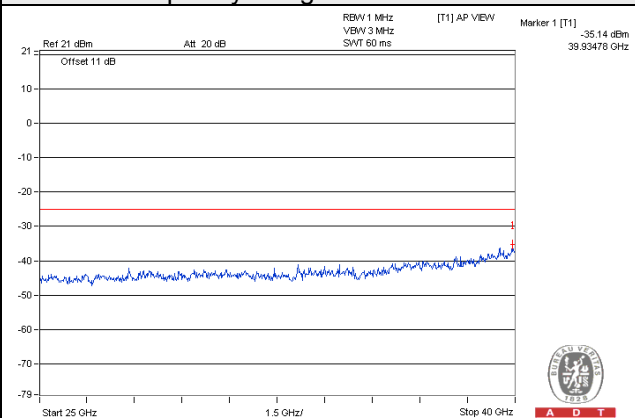

Data Rate 3Mbps

Channel 176

Frequency Range: 9kHz~150kHz

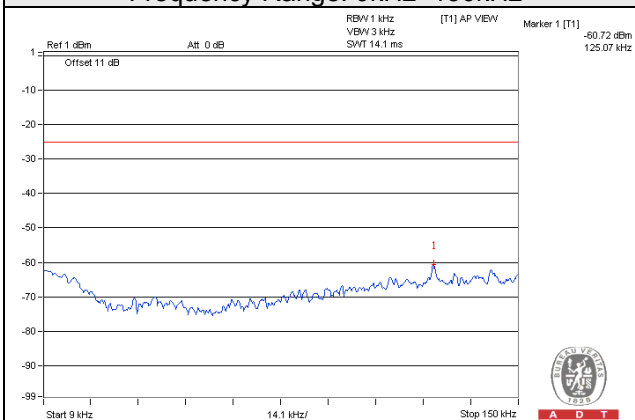

Frequency Range: 150kHz~30MHz

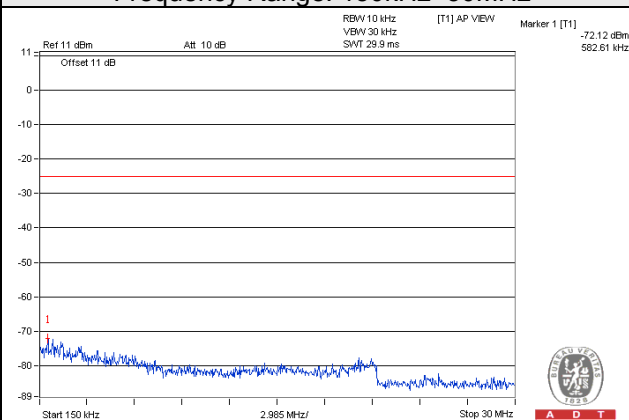

Frequency Range: 30MHz~1GHz

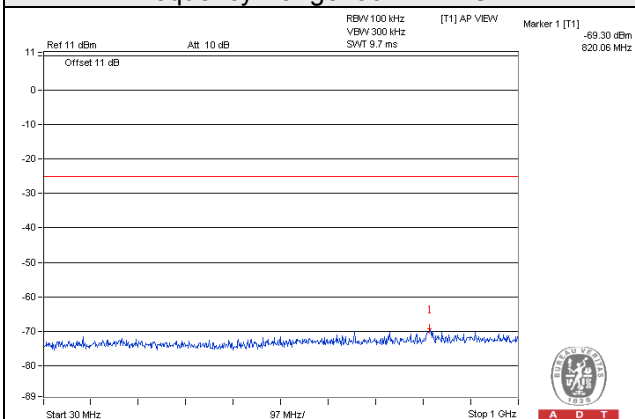

Frequency Range: 1GHz~12GHz

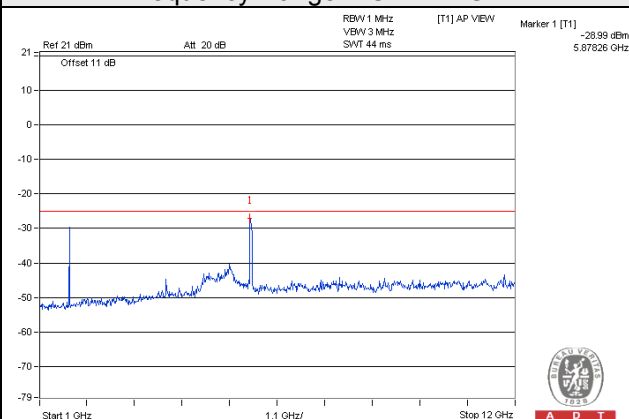

Frequency Range: 12GHz~25GHz

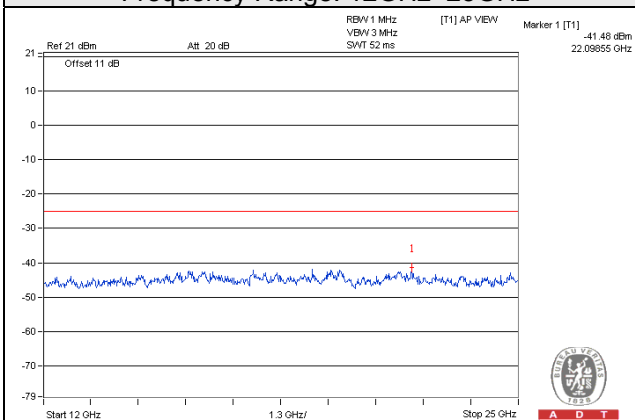

Frequency Range: 25GHz~40GHz

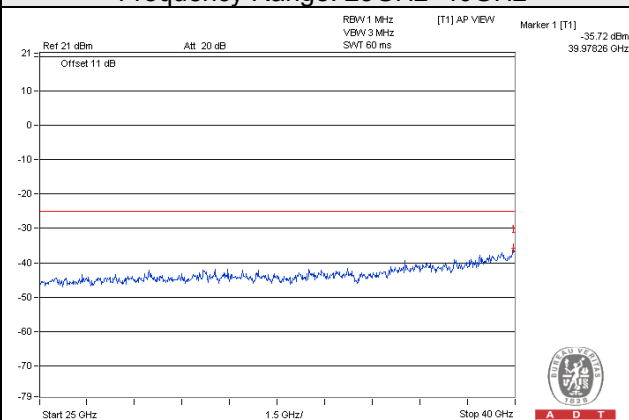

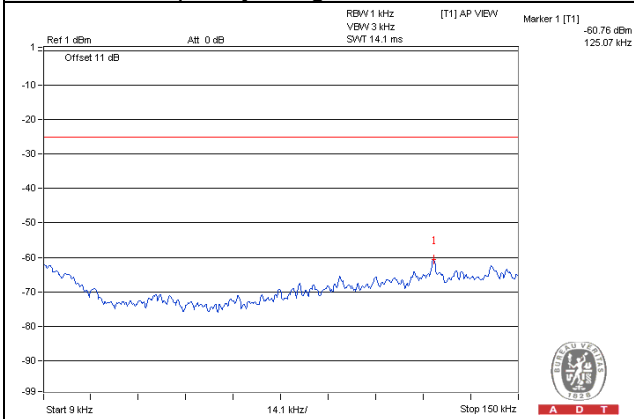
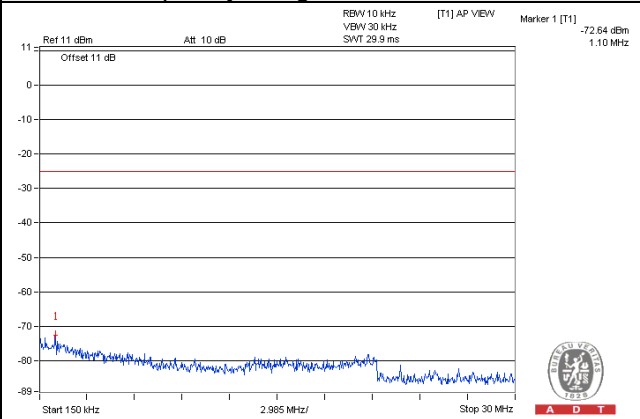
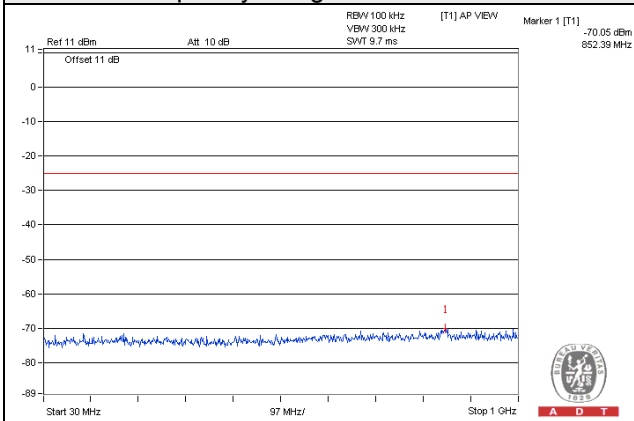
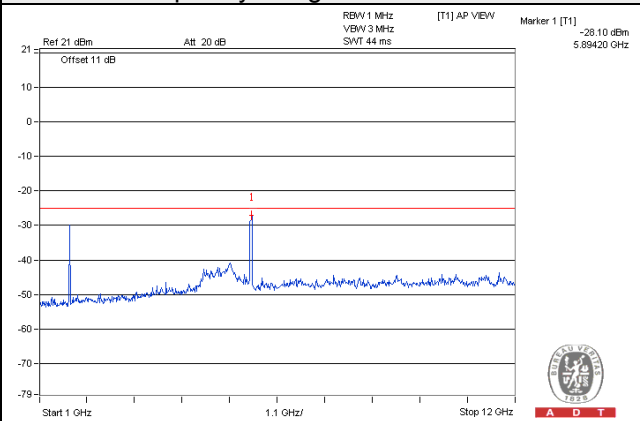
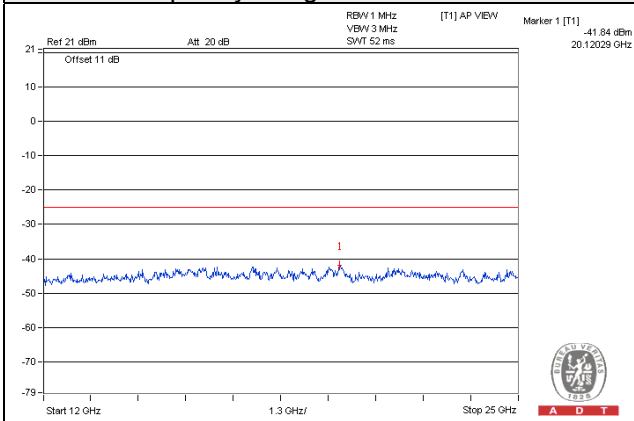
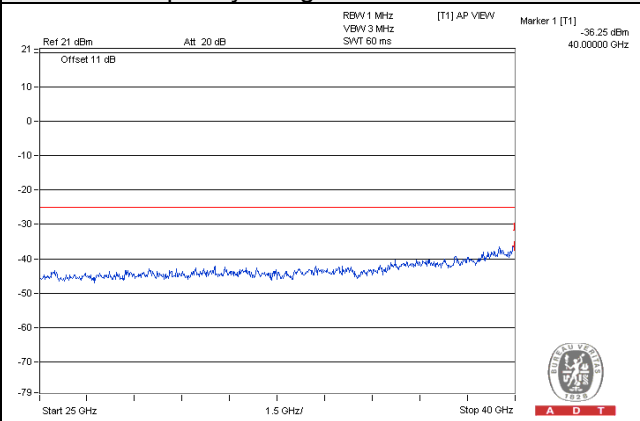
Data Rate 3Mbps
Channel 178
Frequency Range: 9kHz~150kHz

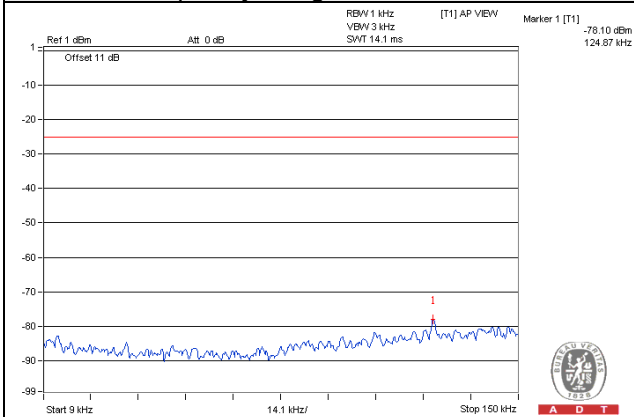
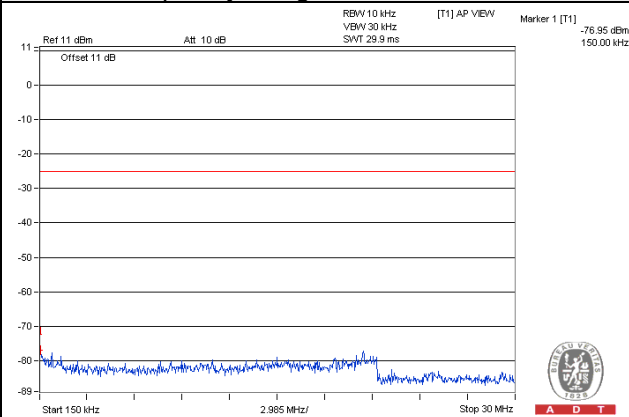
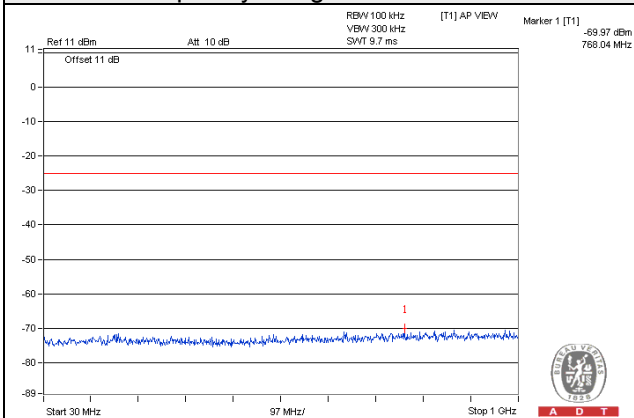
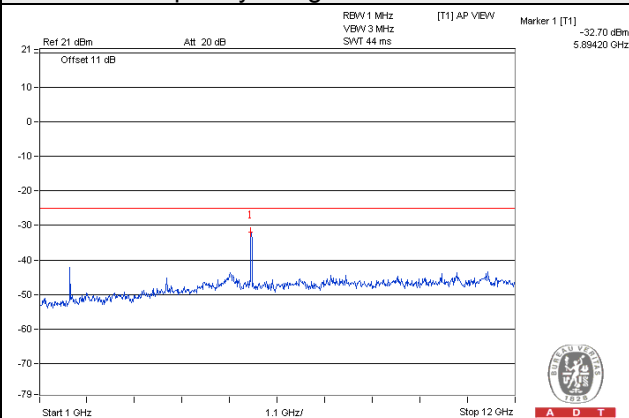
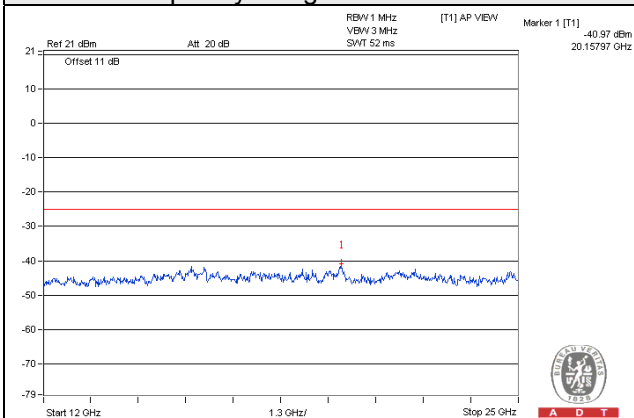
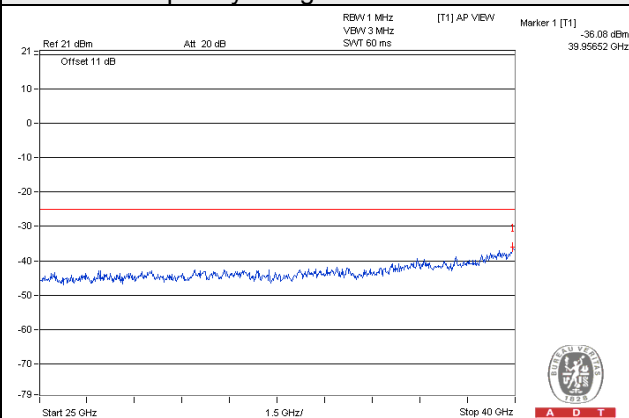
Frequency Range: 150kHz~30MHz

Frequency Range: 30MHz~1GHz

Frequency Range: 1GHz~12GHz

Frequency Range: 12GHz~25GHz

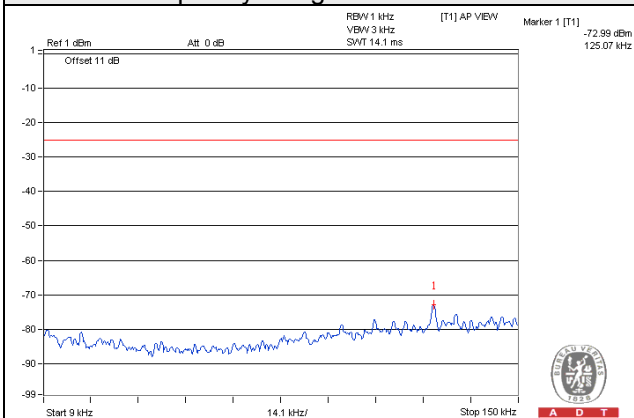
Frequency Range: 25GHz~40GHz

Data Rate 3Mbps
Channel 180
Frequency Range: 9kHz~150kHz

Frequency Range: 150kHz~30MHz

Frequency Range: 30MHz~1GHz

Frequency Range: 1GHz~12GHz

Frequency Range: 12GHz~25GHz

Frequency Range: 25GHz~40GHz

Data Rate 3Mbps

Channel 182

Frequency Range: 9kHz~150kHz



Frequency Range: 150kHz~30MHz

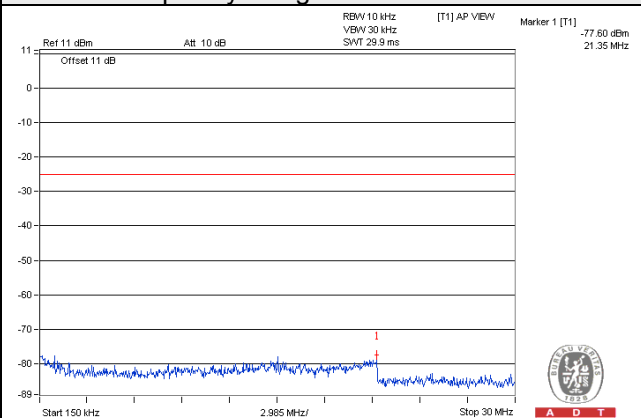

Frequency Range: 30MHz~1GHz

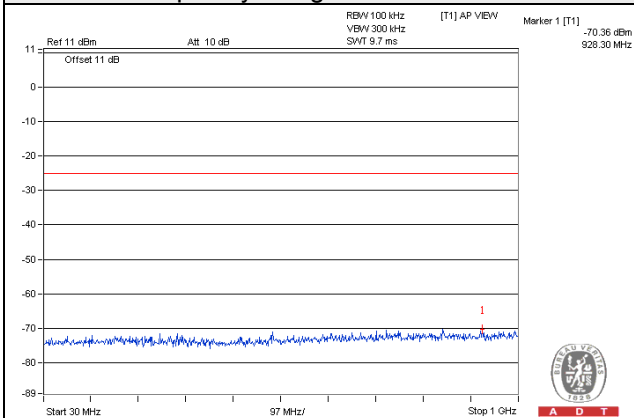

Frequency Range: 1GHz~12GHz

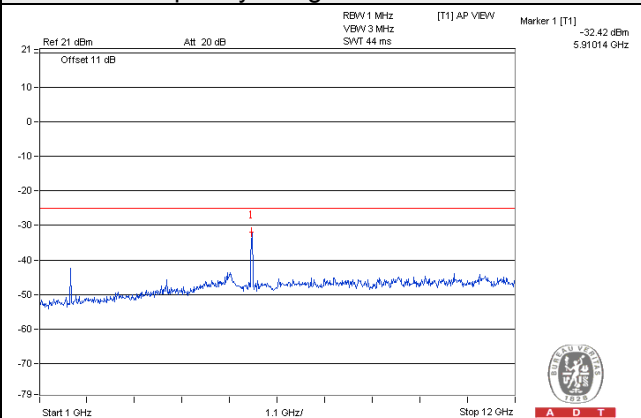

Frequency Range: 12GHz~25GHz

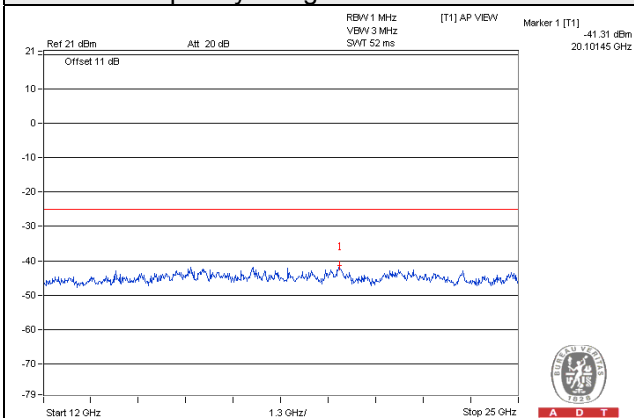

Frequency Range: 25GHz~40GHz

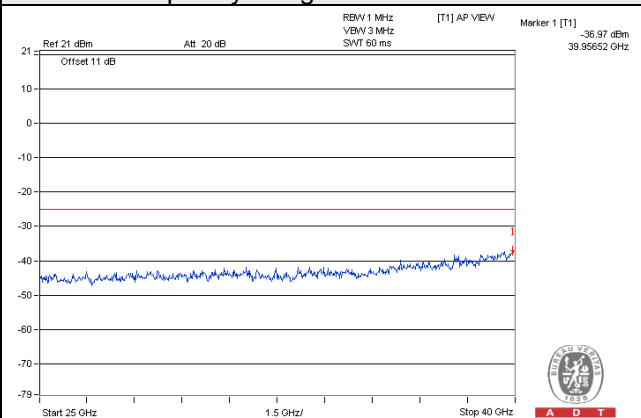

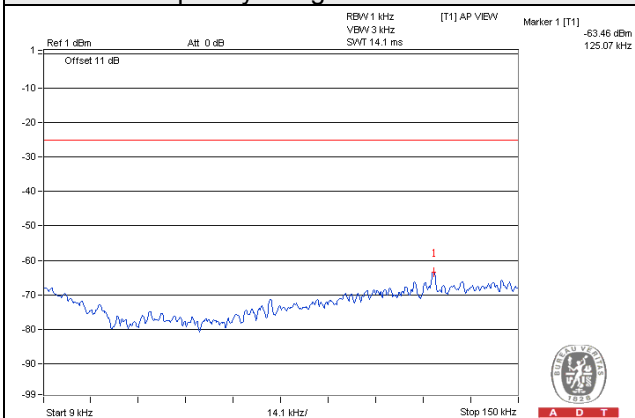
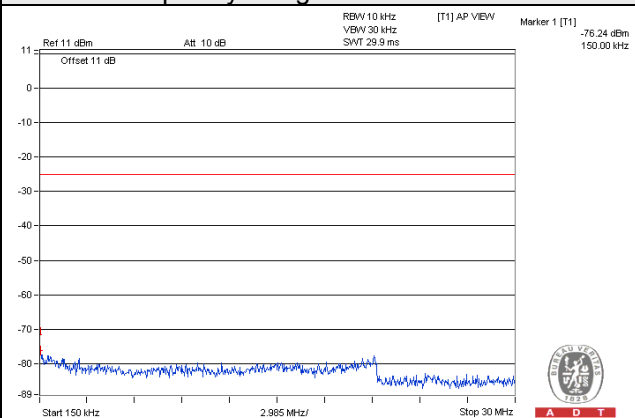
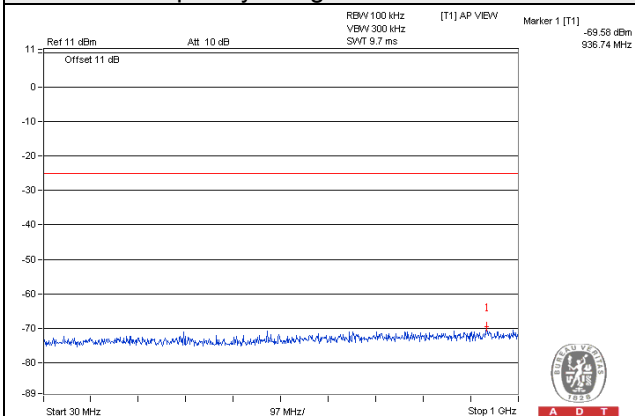
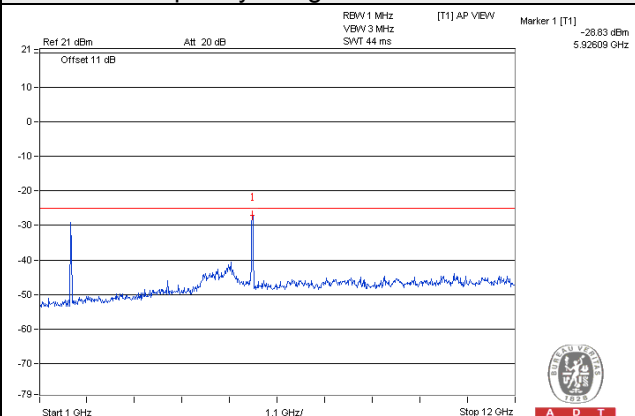
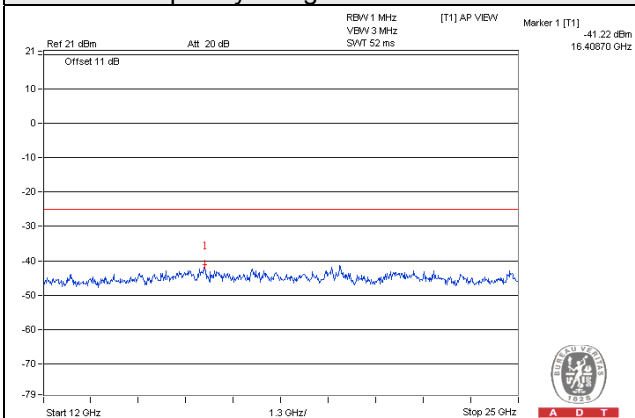
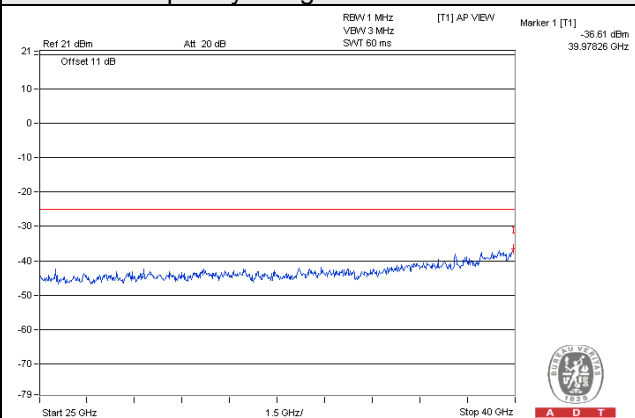
Data Rate 3Mbps
Channel 184
Frequency Range: 9kHz~150kHz

Frequency Range: 150kHz~30MHz

Frequency Range: 30MHz~1GHz

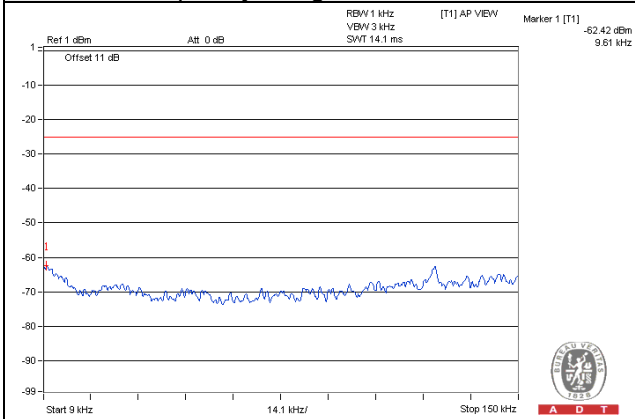
Frequency Range: 1GHz~12GHz

Frequency Range: 12GHz~25GHz

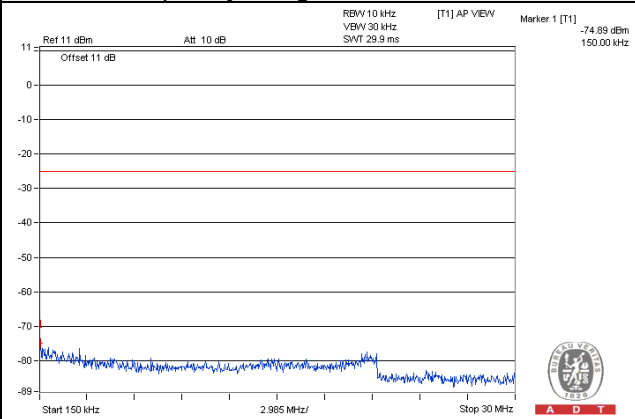
Frequency Range: 25GHz~40GHz

Data Rate 27Mbps
Channel 172

Frequency Range: 9kHz~150kHz



Frequency Range: 150kHz~30MHz



Frequency Range: 30MHz~1GHz

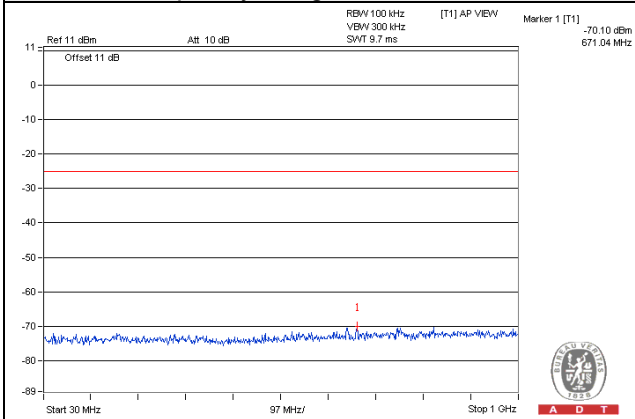

Frequency Range: 1GHz~12GHz

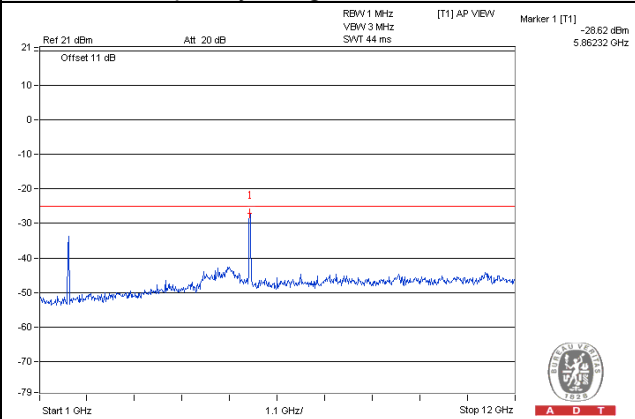

Frequency Range: 12GHz~25GHz

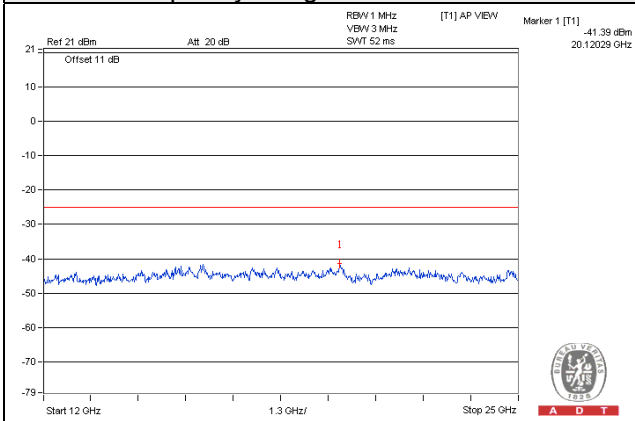

Frequency Range: 25GHz~40GHz

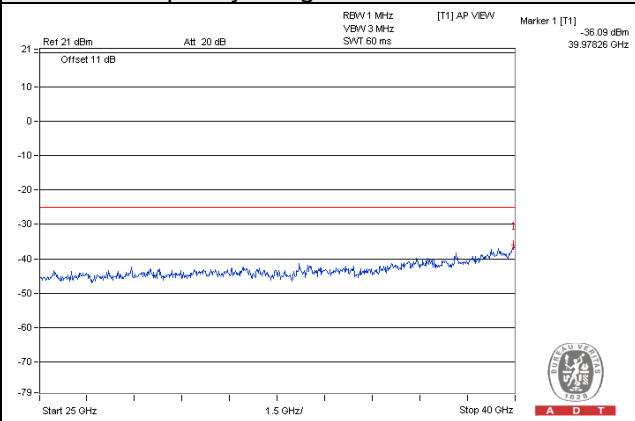

Data Rate 27Mbps
Channel 174

Frequency Range: 9kHz~150kHz

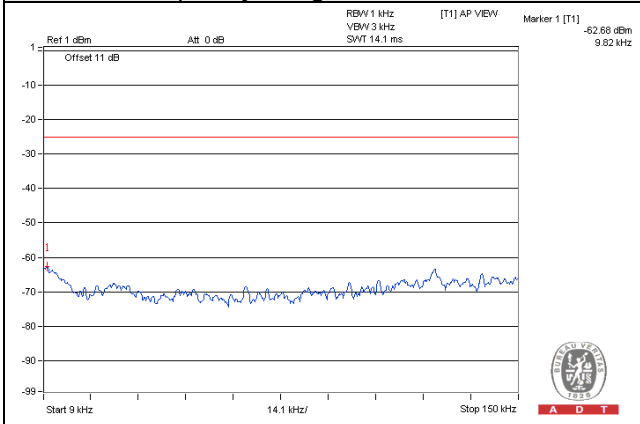

Frequency Range: 150kHz~30MHz

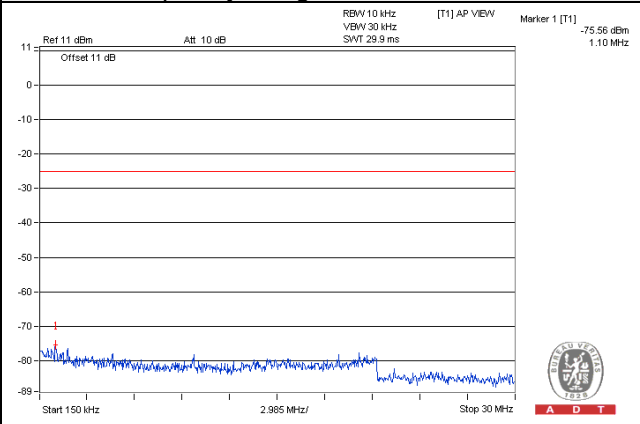

Frequency Range: 30MHz~1GHz

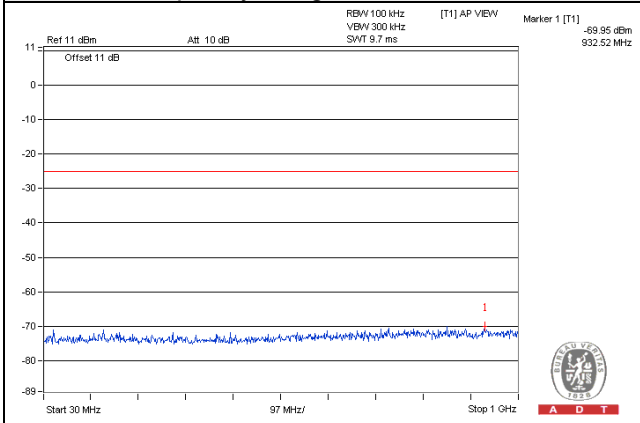

Frequency Range: 1GHz~12GHz

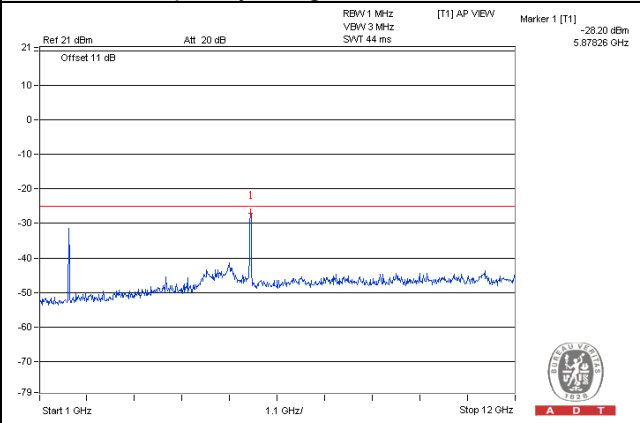

Frequency Range: 12GHz~25GHz

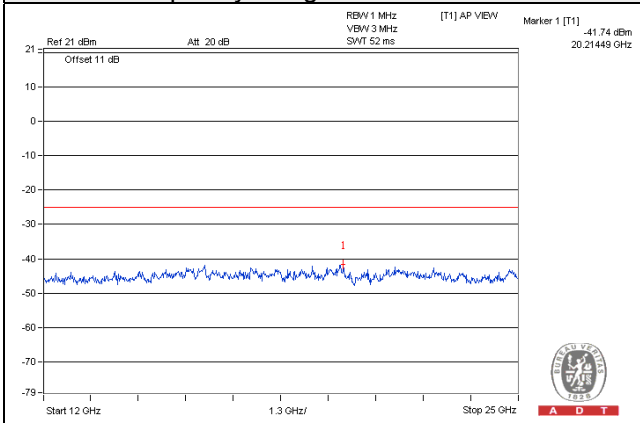

Frequency Range: 25GHz~40GHz

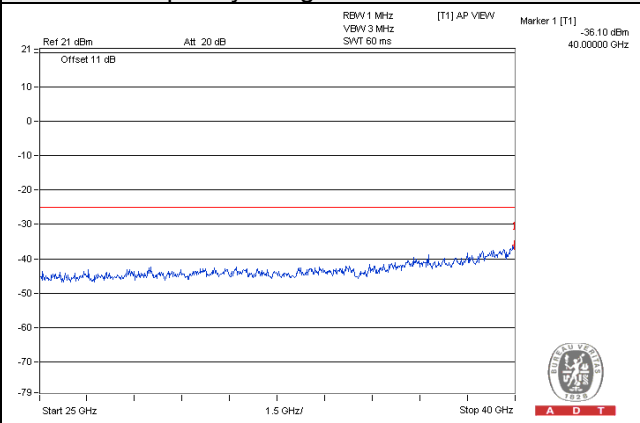

Data Rate 27Mbps
Channel 176

Frequency Range: 9kHz~150kHz

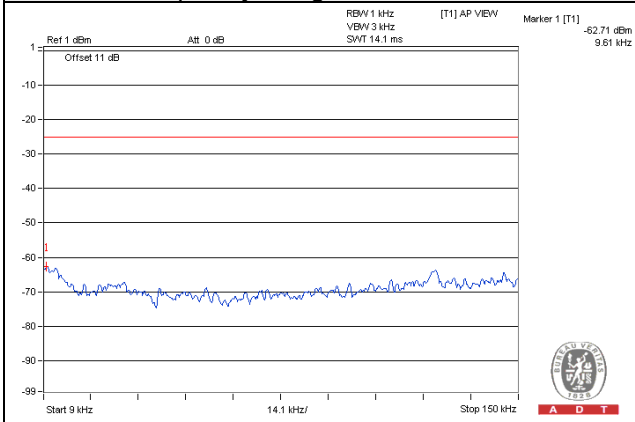

Frequency Range: 150kHz~30MHz

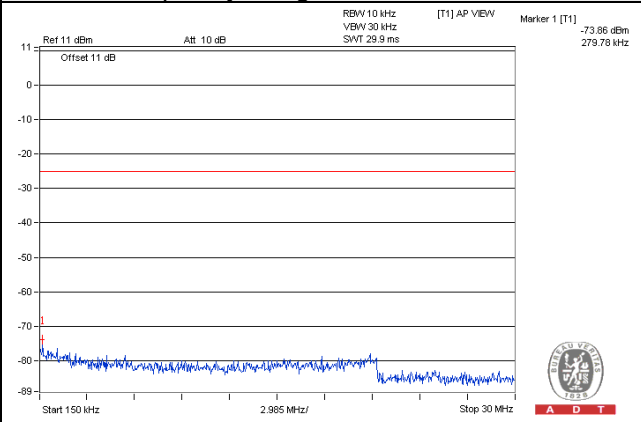

Frequency Range: 30MHz~1GHz

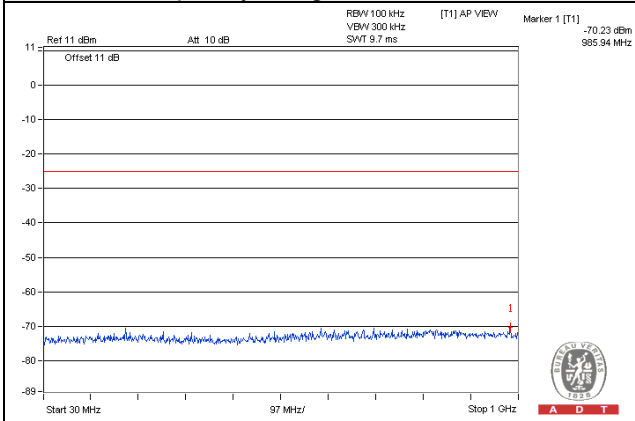

Frequency Range: 1GHz~12GHz

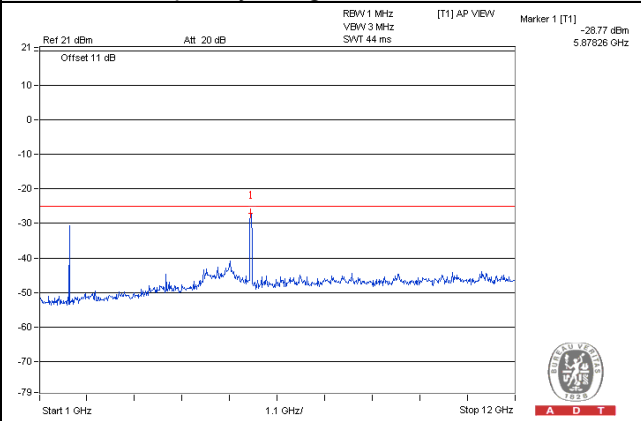

Frequency Range: 12GHz~25GHz

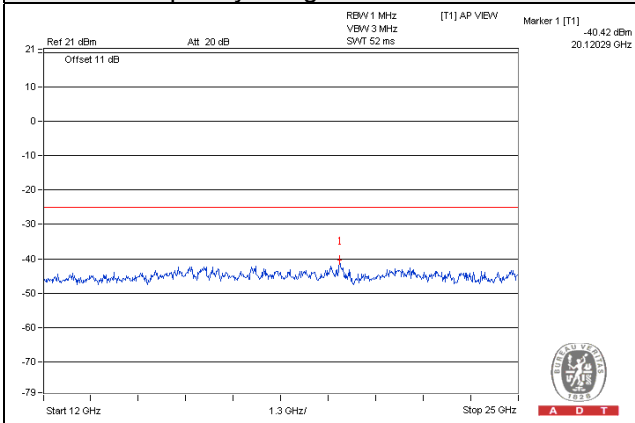

Frequency Range: 25GHz~40GHz

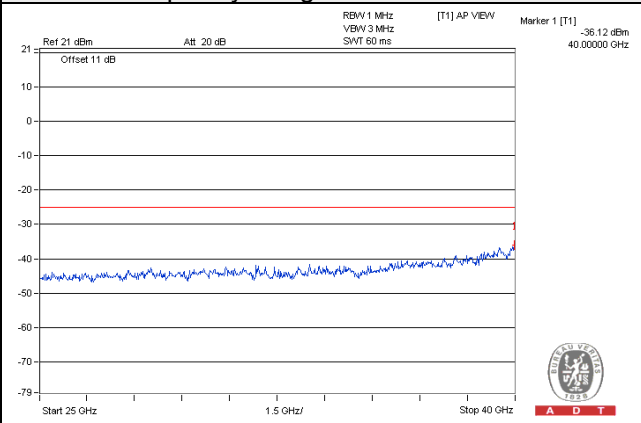

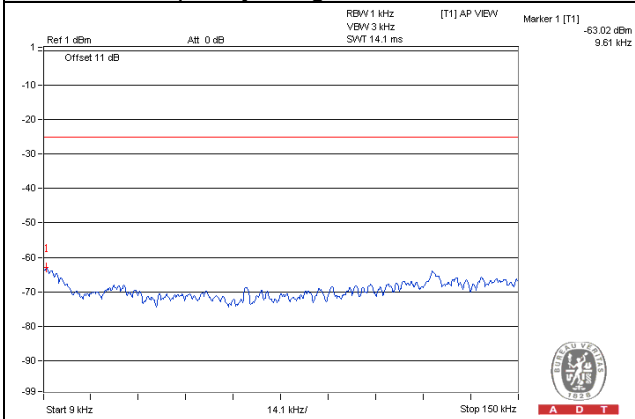
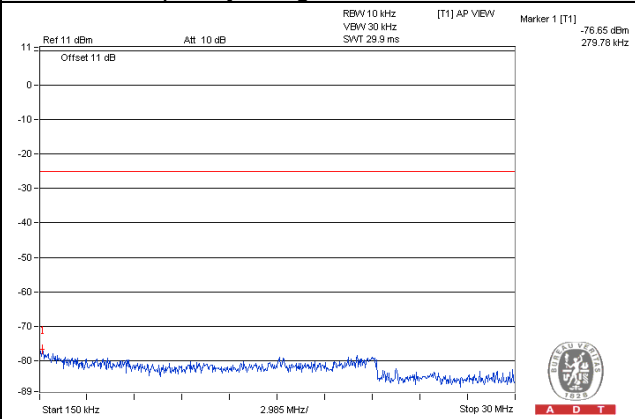
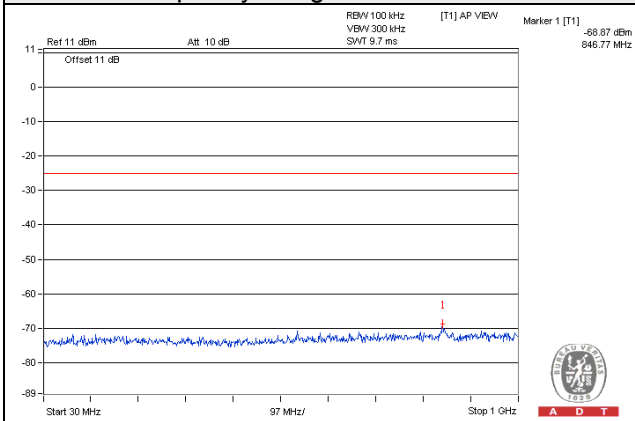
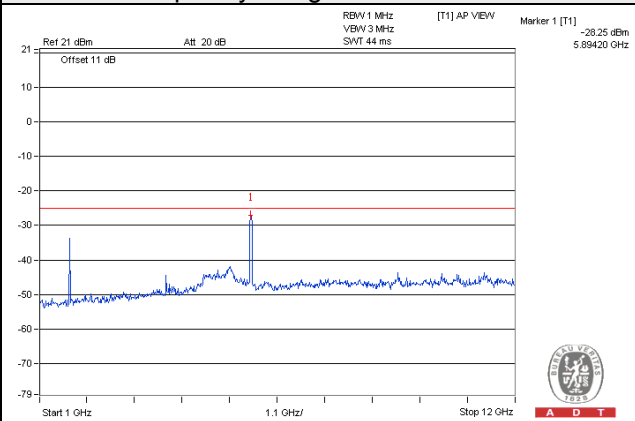
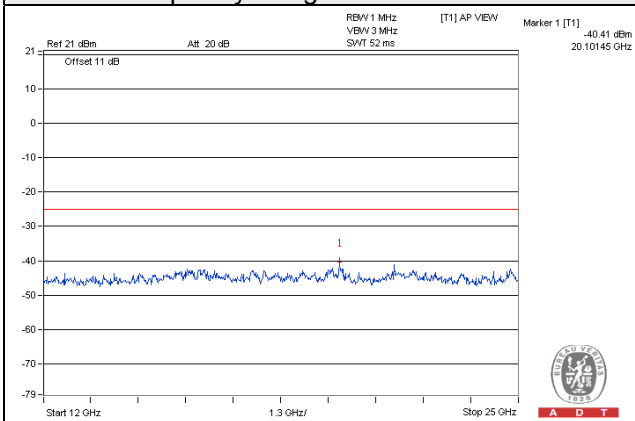
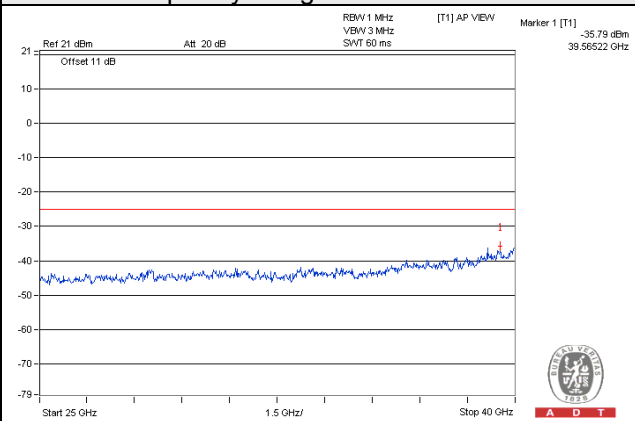
Data Rate 27Mbps
Channel 178
Frequency Range: 9kHz~150kHz

Frequency Range: 150kHz~30MHz

Frequency Range: 30MHz~1GHz

Frequency Range: 1GHz~12GHz

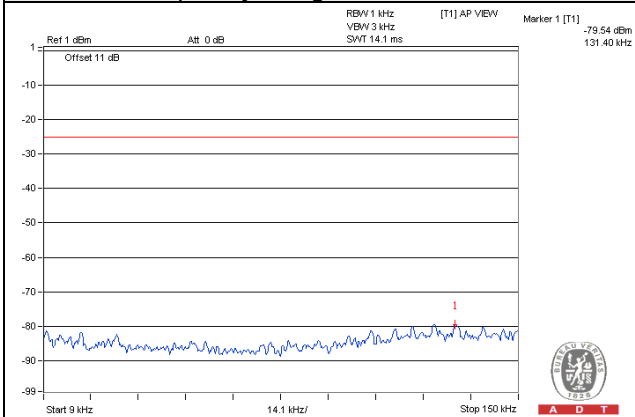
Frequency Range: 12GHz~25GHz

Frequency Range: 25GHz~40GHz

Data Rate 27Mbps

Channel 180

Frequency Range: 9kHz~150kHz



Frequency Range: 150kHz~30MHz

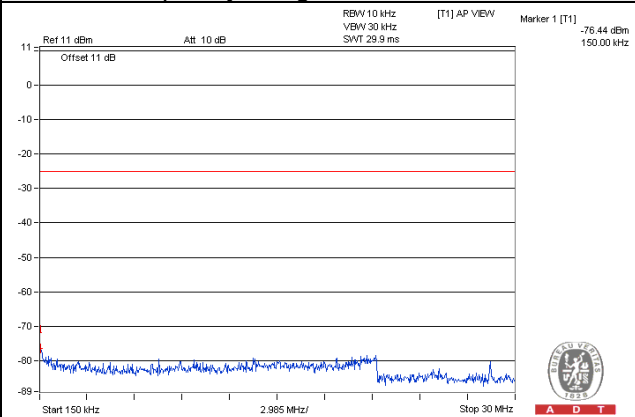

Frequency Range: 30MHz~1GHz

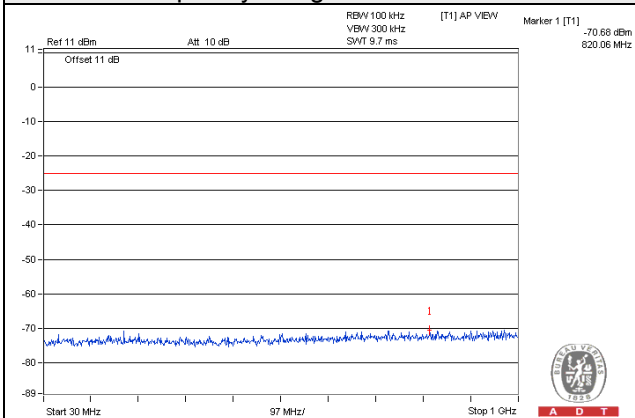

Frequency Range: 1GHz~12GHz

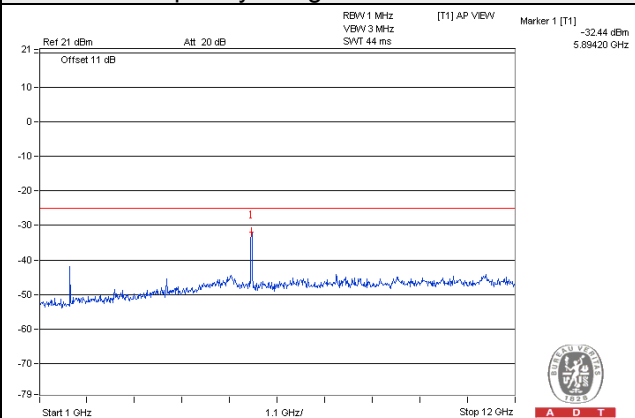

Frequency Range: 12GHz~25GHz

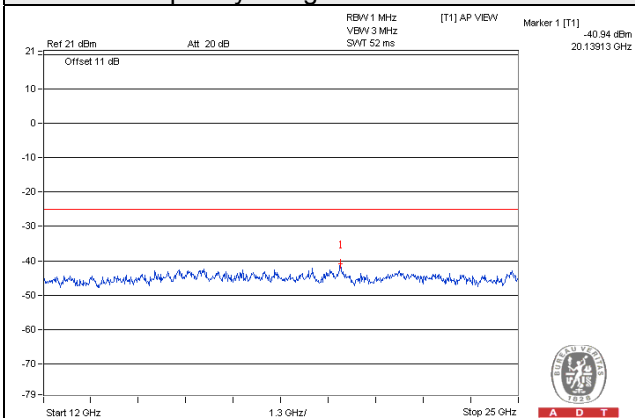

Frequency Range: 25GHz~40GHz

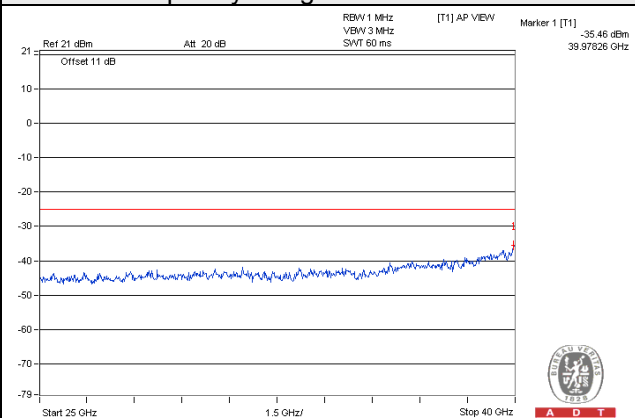

Data Rate 27Mbps

Channel 182

Frequency Range: 9kHz~150kHz

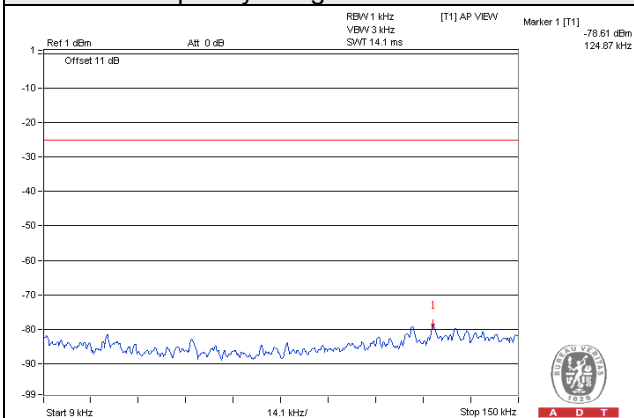

Frequency Range: 150kHz~30MHz

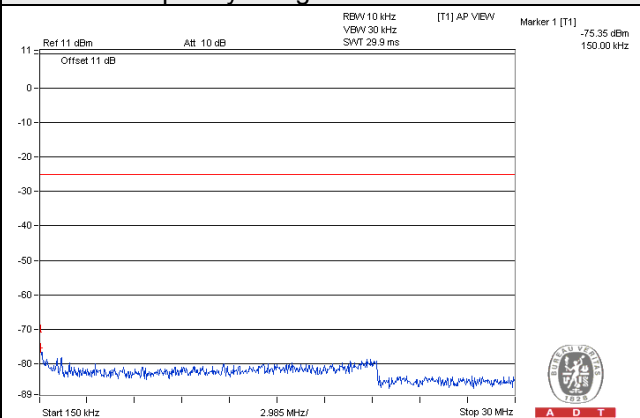

Frequency Range: 30MHz~1GHz

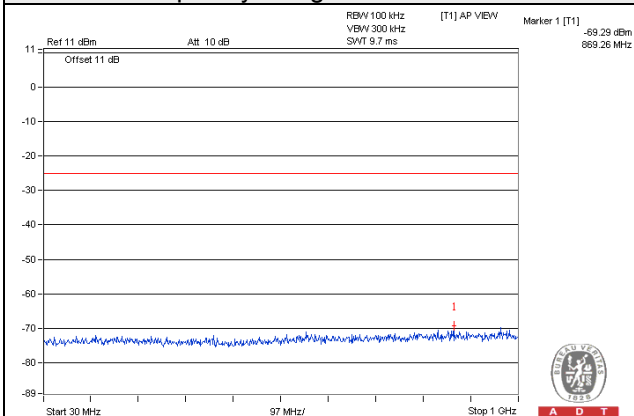

Frequency Range: 1GHz~12GHz

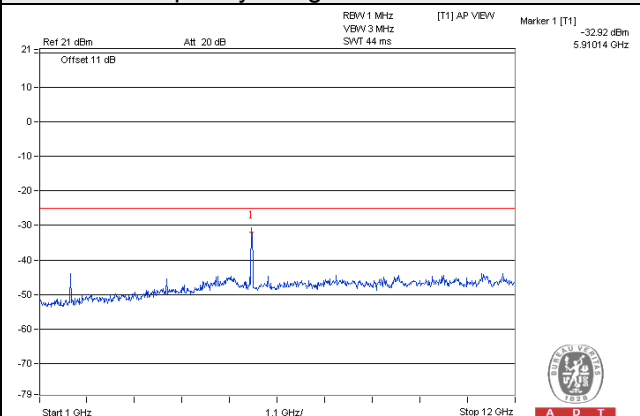

Frequency Range: 12GHz~25GHz

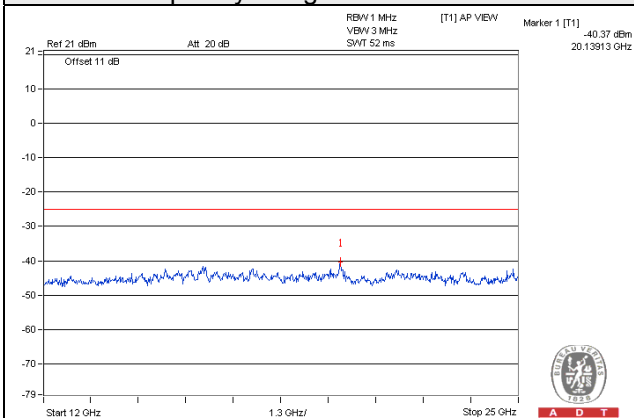

Frequency Range: 25GHz~40GHz

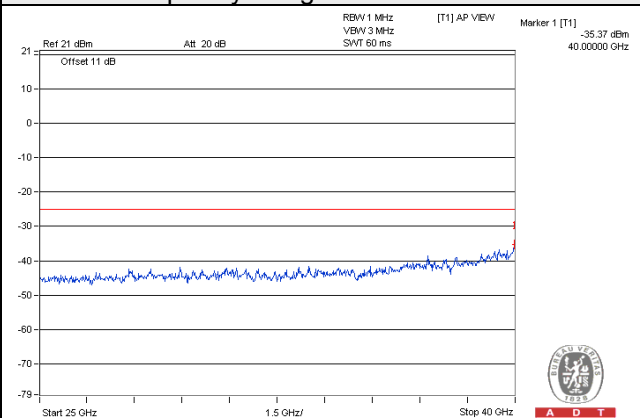

Data Rate 27Mbps

Channel 184

Frequency Range: 9kHz~150kHz

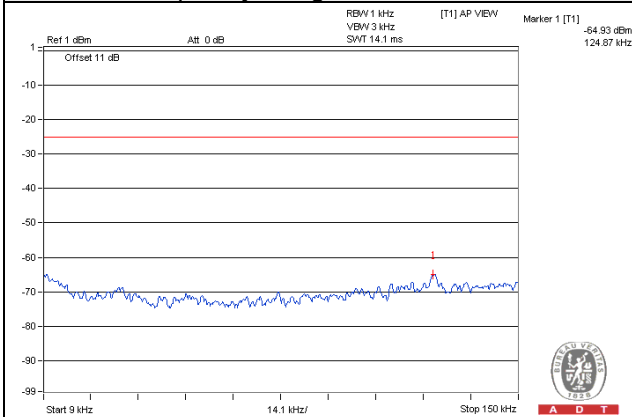

Frequency Range: 150kHz~30MHz

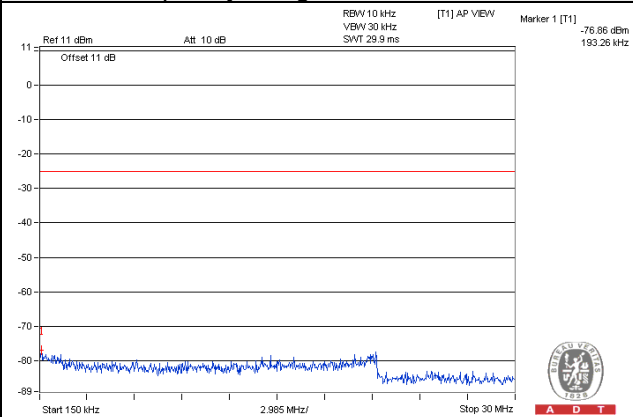

Frequency Range: 30MHz~1GHz

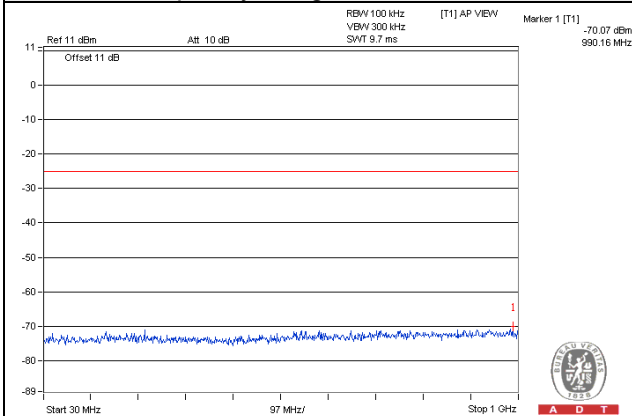

Frequency Range: 1GHz~12GHz

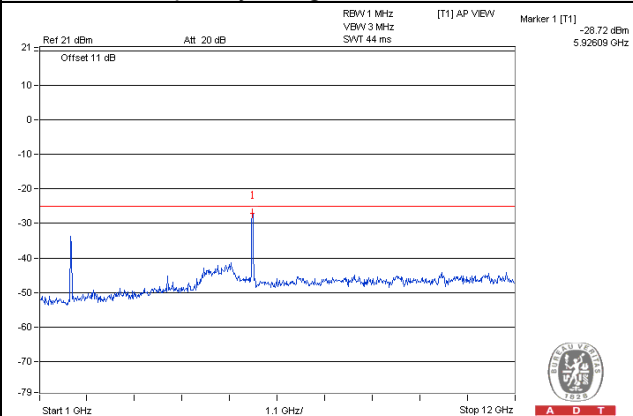

Frequency Range: 12GHz~25GHz

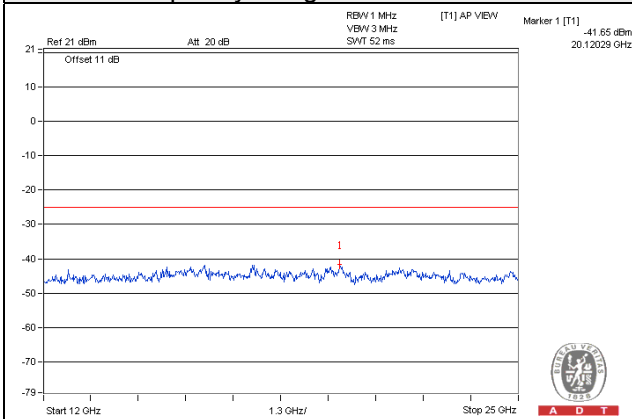

Frequency Range: 25GHz~40GHz

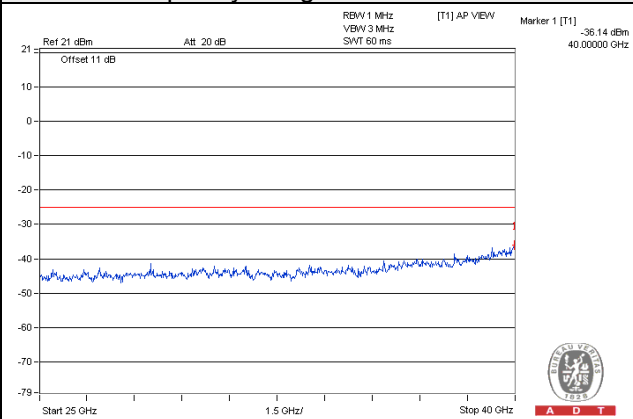

Channel Bandwidth 20MHz

Data Rate 6Mbps

Channel 175

Frequency Range: 9kHz~150kHz

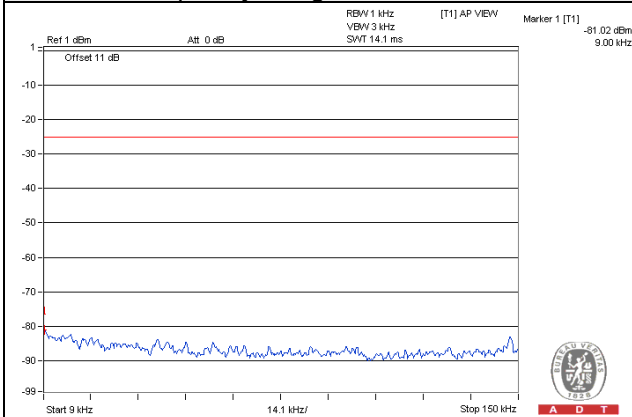

Frequency Range: 150kHz~30MHz

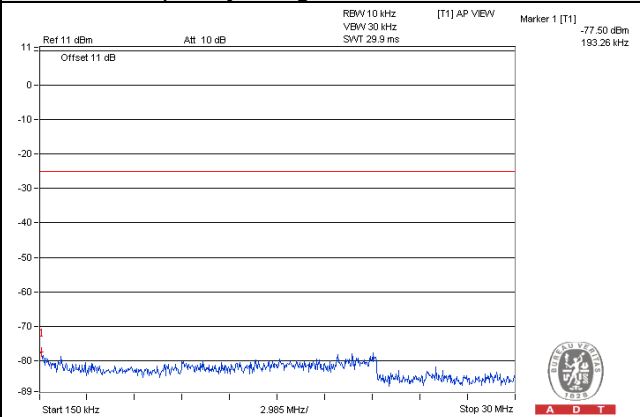

Frequency Range: 30MHz~1GHz

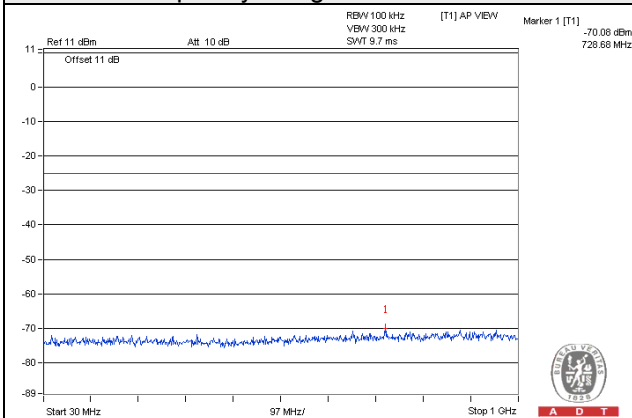

Frequency Range: 1GHz~12GHz

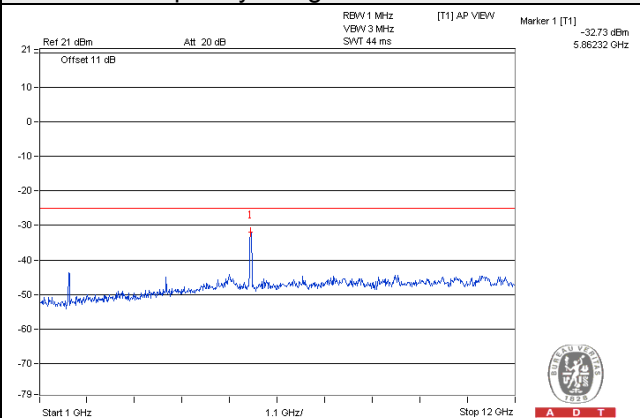

Frequency Range: 12GHz~25GHz

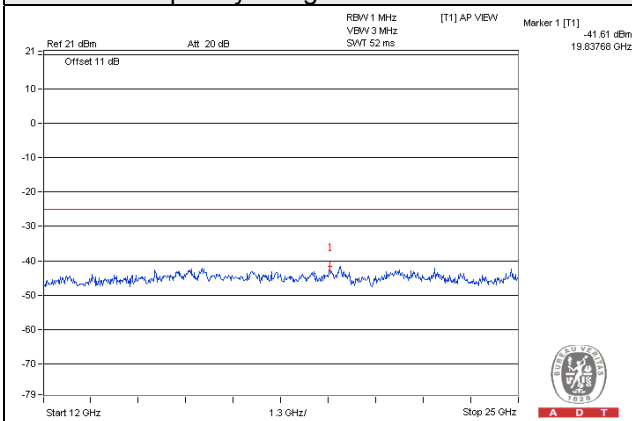

Frequency Range: 25GHz~40GHz

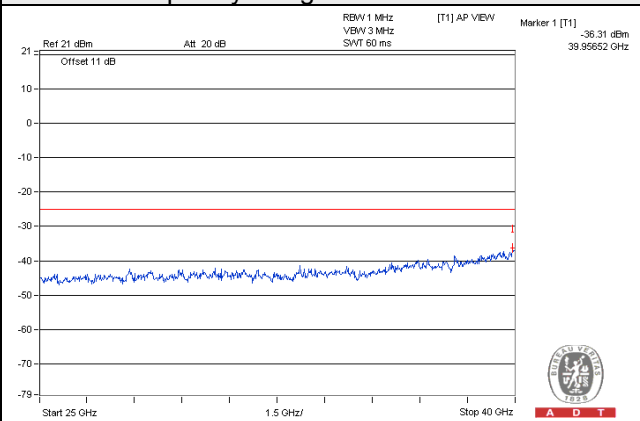

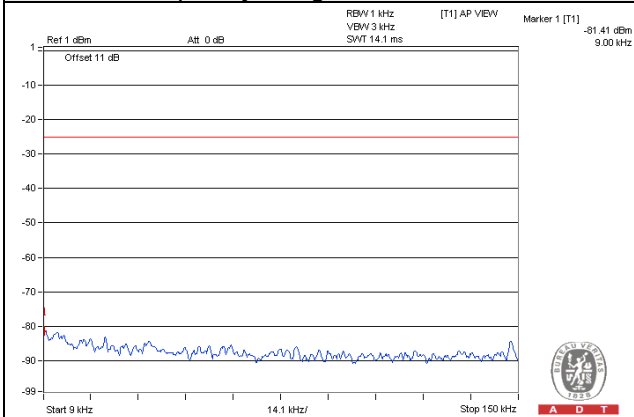
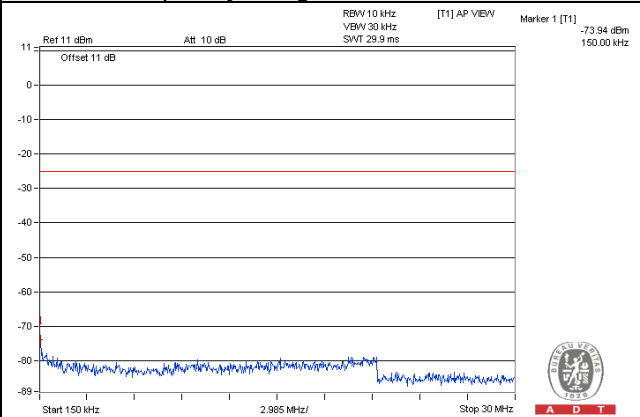
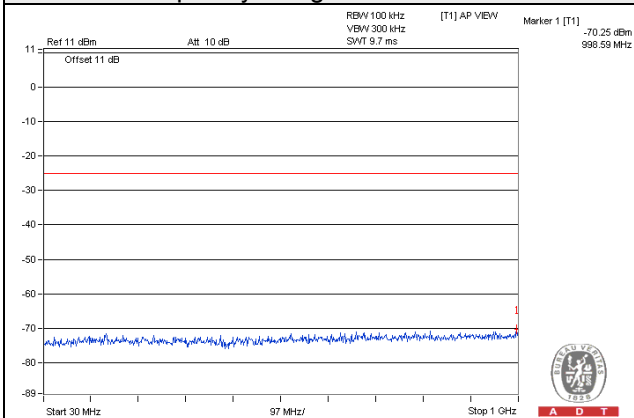
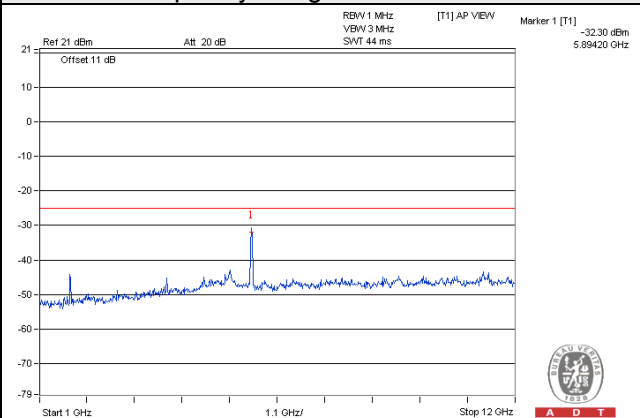
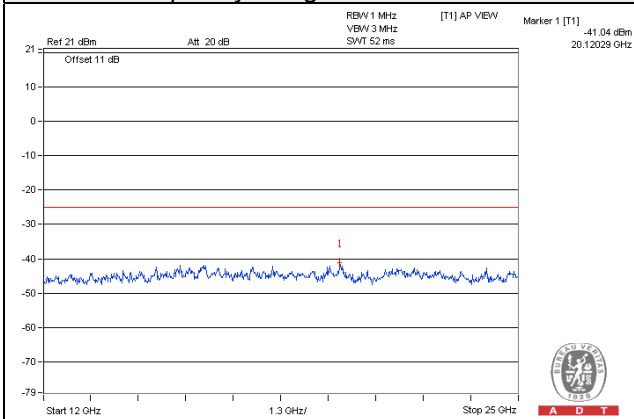
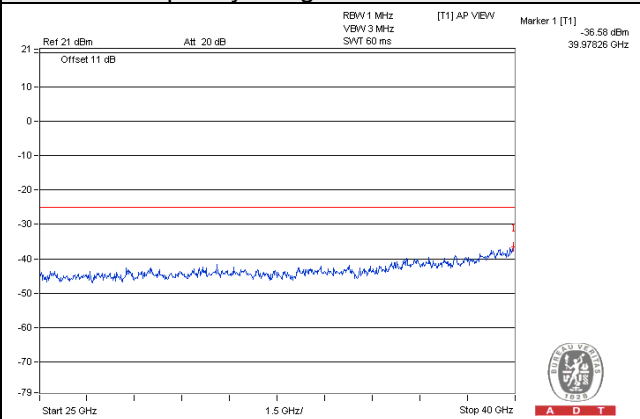
Data Rate 6Mbps
Channel 181
Frequency Range: 9kHz~150kHz

Frequency Range: 150kHz~30MHz

Frequency Range: 30MHz~1GHz

Frequency Range: 1GHz~12GHz

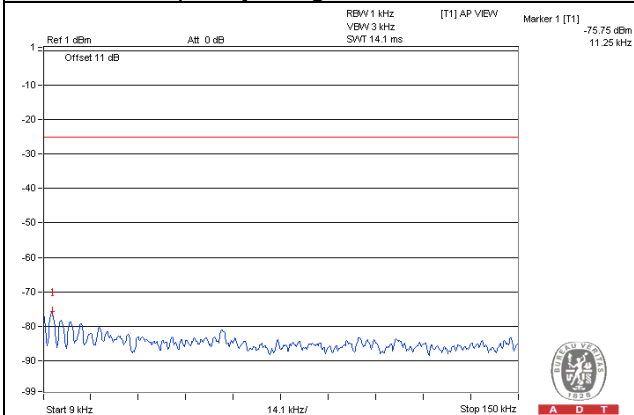
Frequency Range: 12GHz~25GHz

Frequency Range: 25GHz~40GHz

Data Rate 54Mbps

Channel 175

Frequency Range: 9kHz~150kHz



Frequency Range: 150kHz~30MHz

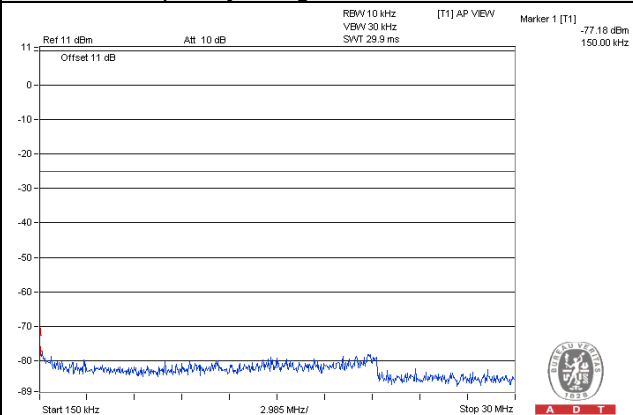

Frequency Range: 30MHz~1GHz

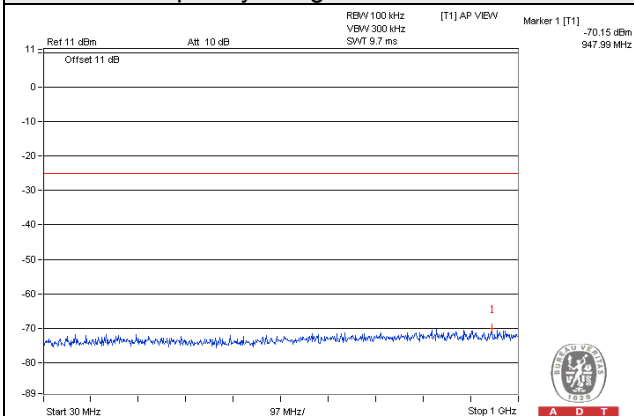

Frequency Range: 1GHz~12GHz

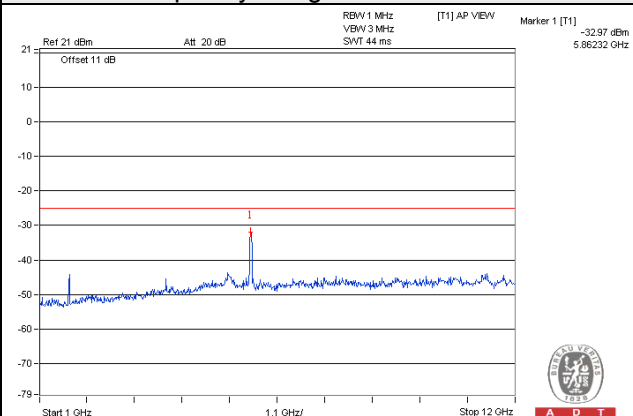

Frequency Range: 12GHz~25GHz

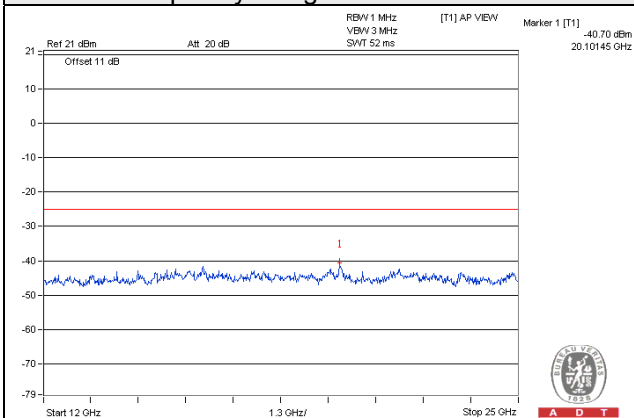

Frequency Range: 25GHz~40GHz

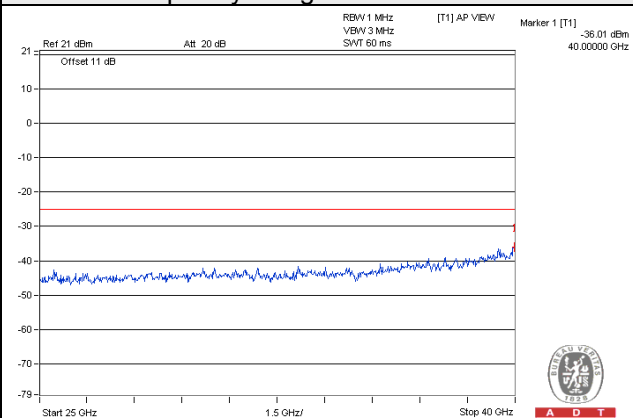

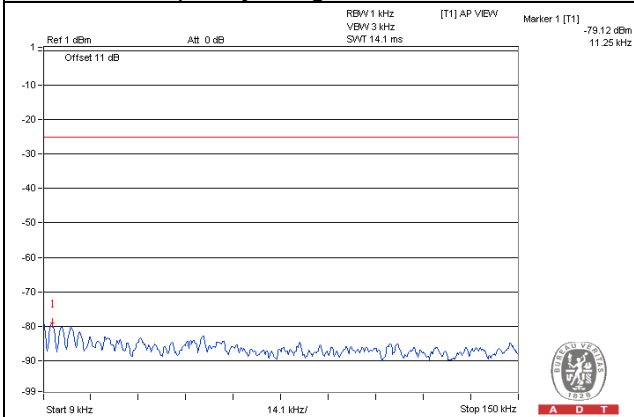
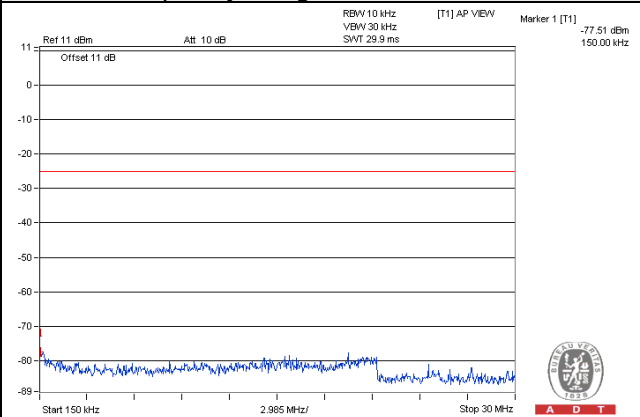
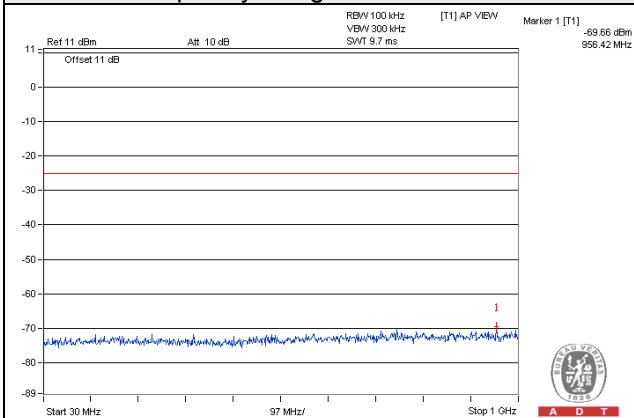
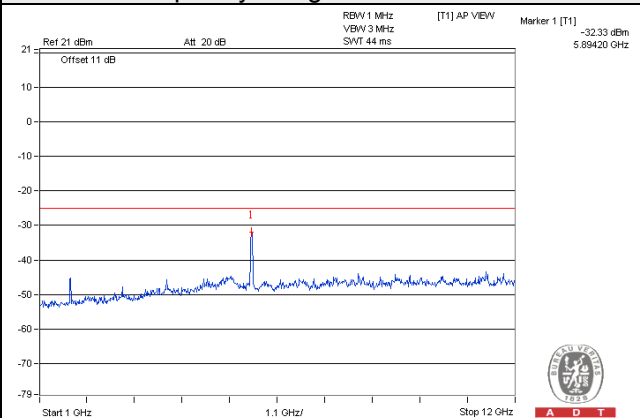
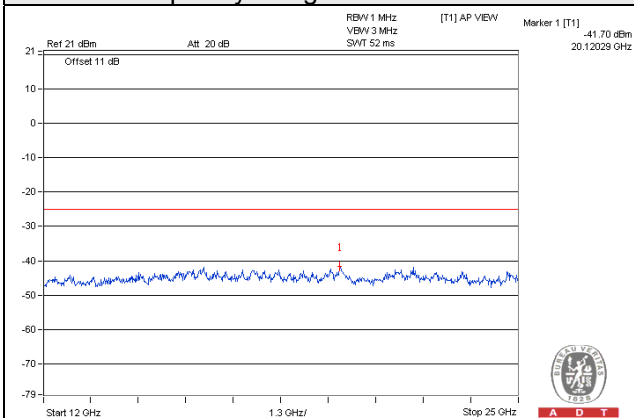
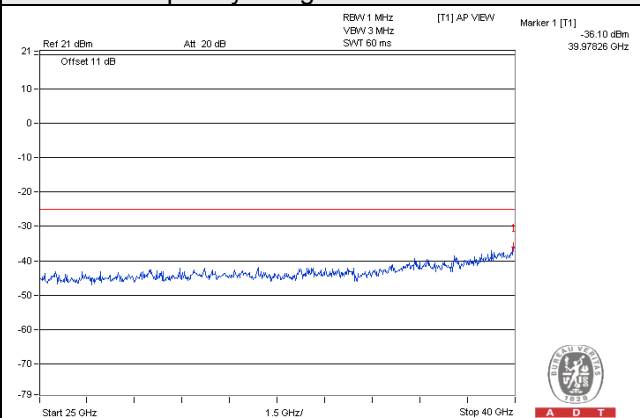
Data Rate 54Mbps
Channel 181
Frequency Range: 9kHz~150kHz

Frequency Range: 150kHz~30MHz

Frequency Range: 30MHz~1GHz

Frequency Range: 1GHz~12GHz

Frequency Range: 12GHz~25GHz

Frequency Range: 25GHz~40GHz

4.7 Radiated Emission Measurement

4.7.1 Limits of Radiated Emission Measurement

The power of any emission outside a licensee's frequency band(s) of operation shall be attenuated below the transmitter power (P) within the licensed band(s) of operation, measured in watts, by at least $[55 + 10 \log(P)]$ (e.i.r.p. -25dBm [70.2 dBuV/m at 3m]).

4.7.2 Test Procedure

- Substitution method is used for E.I.R.P measurement. In the semi-anechoic chamber, EUT placed on the 0.8m height of Turn Table, rotated the table around 360 degrees to search the maximum radiation power and receiver antenna shall be rotated vertical and horizontal polarization and moved height from 1m to 4m to find the maximum polar radiated power. The "Read Value" is the spectrum reading the maximum power value.
- The substitution horn antenna is substituted for EUT at the same position and signals generator export the CW signal to the substitution antenna via a TX cable. Rotated the Turn Table and moved receiving antenna to find the maximum radiation power. Adjust output power level of S.G to get a Value of spectrum reading equal to "Read Value " of step a. Record the power level of S.G
- $EIRP = \text{Output power level of S.G} - \text{TX cable loss} + \text{Antenna gain of substitution horn.}$
- E.R.P power can be calculated form E.I.R.P power by subtracting the gain of dipole, $E.R.P \text{ power} = E.I.R.P \text{ power} - 2.15\text{dBi.}$

Note: The resolution bandwidth and video bandwidth of test receiver/spectrum analyzer is 1MHz/3MHz.

4.7.3 Deviation from Test Standard

No deviation.

4.7.4 Test Setup

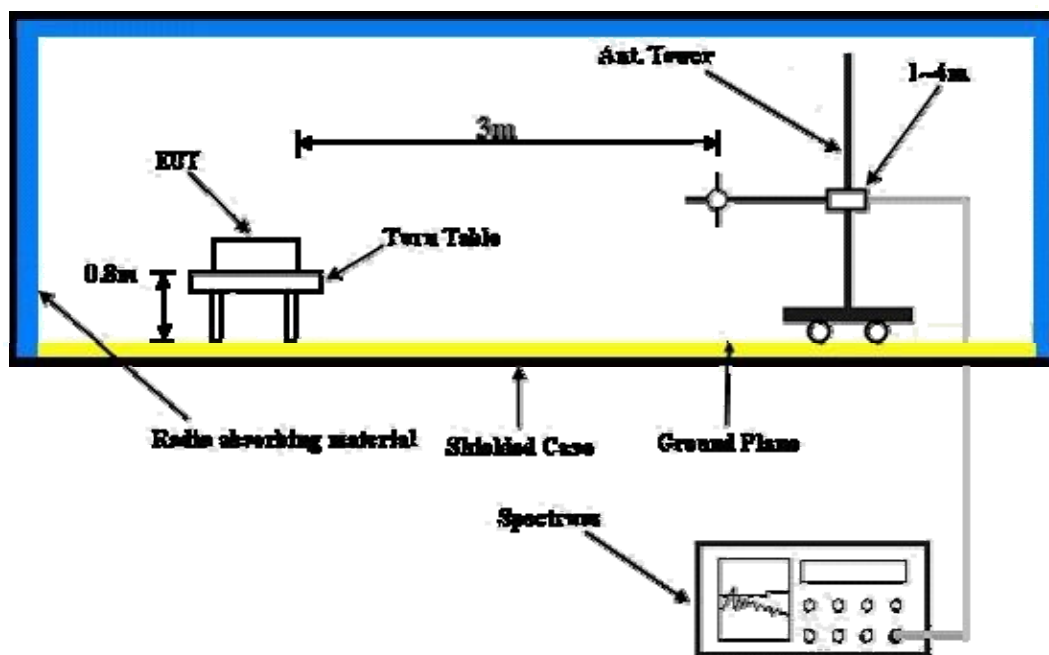

For the actual test configuration, please refer to the attached file (Test Setup Photo).

4.7.5 Test Results

Mode A

Below 1GHz

Channel Bandwidth 10MHz, Data Rate 3Mbps

Mode	TX channel 184	Frequency Range	Below 1000 MHz
------	----------------	-----------------	----------------

Antenna Polarity & Test Distance: Horizontal at 3 M							
No.	Freq. (MHz)	Reading (dBm)	S.G Power Value (dBm)	Correction Factor (dB)	EIRP (dBm)	Limit (dBm)	Margin (dB)
1	30.00	-52.80	-37.60	-12.20	-49.80	-25.00	-24.80
2	94.15	-42.70	-52.60	1.00	-51.60	-25.00	-26.60
3	366.29	-46.80	-54.40	5.20	-49.20	-25.00	-24.20
4	500.42	-52.40	-57.30	4.90	-52.40	-25.00	-27.40
5	739.52	-48.40	-49.20	4.80	-44.40	-25.00	-19.40
6	844.49	-53.20	-49.80	4.00	-45.80	-25.00	-20.80
Antenna Polarity & Test Distance: Vertical at 3 M							
No.	Freq. (MHz)	Reading (dBm)	S.G Power Value (dBm)	Correction Factor (dB)	EIRP (dBm)	Limit (dBm)	Margin (dB)
1	30.00	-38.20	-34.30	-12.20	-46.50	-25.00	-21.50
2	199.12	-50.90	-57.90	5.40	-52.50	-25.00	-27.50
3	376.01	-50.50	-55.90	5.30	-50.60	-25.00	-25.60
4	500.42	-56.50	-60.80	4.90	-55.90	-25.00	-30.90
5	739.52	-45.00	-42.80	4.80	-38.00	-25.00	-13.00
6	895.03	-53.90	-49.10	3.90	-45.20	-25.00	-20.20

Remarks:

1. Output Power (dBm) = S.G Value (dBm) + Correction Factor (dB).
2. Correction Factor (dB) = Substitution Antenna Gain (dB) + Cable Loss (dB).

Channel Bandwidth 20MHz, Data Rate 6Mbps

Mode	TX channel 175	Frequency Range	Below 1000 MHz
------	----------------	-----------------	----------------

Antenna Polarity & Test Distance: Horizontal at 3 M

No.	Freq. (MHz)	Reading (dBm)	S.G Power Value (dBm)	Correction Factor (dB)	EIRP (dBm)	Limit (dBm)	Margin (dB)
1	30.00	-53.00	-37.80	-12.20	-50.00	-25.00	-25.00
2	92.20	-41.30	-51.30	1.10	-50.20	-25.00	-25.20
3	201.06	-47.00	-60.30	5.40	-54.90	-25.00	-29.90
4	366.29	-46.30	-53.90	5.20	-48.70	-25.00	-23.70
5	681.20	-57.20	-59.30	5.10	-54.20	-25.00	-29.20
6	875.59	-59.60	-55.90	3.90	-52.00	-25.00	-27.00

Antenna Polarity & Test Distance: Vertical at 3 M

No.	Freq. (MHz)	Reading (dBm)	S.G Power Value (dBm)	Correction Factor (dB)	EIRP (dBm)	Limit (dBm)	Margin (dB)
1	30.00	-38.60	-34.70	-12.20	-46.90	-25.00	-21.90
2	92.20	-44.40	-52.00	1.10	-50.90	-25.00	-25.90
3	201.06	-51.80	-58.60	5.40	-53.20	-25.00	-28.20
4	267.15	-53.90	-57.50	5.30	-52.20	-25.00	-27.20
5	376.01	-47.50	-52.90	5.30	-47.60	-25.00	-22.60
6	681.20	-59.10	-58.30	5.10	-53.20	-25.00	-28.20
7	926.13	-64.90	-59.10	3.90	-55.20	-25.00	-30.20

Remarks:

1. Output Power (dBm) = S.G Value (dBm) + Correction Factor (dB).
2. Correction Factor (dB) = Substitution Antenna Gain (dB) + Cable Loss (dB).



Above 1GHz

Channel Bandwidth 10MHz, Data Rate 3Mbps

Mode	TX channel 172	Frequency Range	Above 1000MHz
------	----------------	-----------------	---------------

Antenna Polarity & Test Distance: Horizontal at 3 M							
No.	Freq. (MHz)	Reading (dBm)	S.G Power Value (dBm)	Correction Factor (dB)	EIRP (dBm)	Limit (dBm)	Margin (dB)
1	1594.00	-49.8	-46.8	5.3	-41.5	-25.0	-16.5
2	11720.00	-63.0	-54.4	2.9	-51.5	-25.0	-26.5
Antenna Polarity & Test Distance: Vertical at 3 M							
No.	Freq. (MHz)	Reading (dBm)	S.G Power Value (dBm)	Correction Factor (dB)	EIRP (dBm)	Limit (dBm)	Margin (dB)
1	1594.00	-41.9	-38.9	5.3	-33.6	-25.0	-8.6
2	11720.00	-64.1	-55.5	2.9	-52.6	-25.0	-27.6

Remarks:

1. Output Power (dBm) = S.G Value (dBm) + Correction Factor (dB).
2. Correction Factor (dB) = Substitution Antenna Gain (dB) + Cable Loss (dB).

Mode	TX channel 174	Frequency Range	Above 1000MHz
------	----------------	-----------------	---------------

Antenna Polarity & Test Distance: Horizontal at 3 M							
No.	Freq. (MHz)	Reading (dBm)	S.G Power Value (dBm)	Correction Factor (dB)	EIRP (dBm)	Limit (dBm)	Margin (dB)
1	1594.00	-48.9	-45.9	5.3	-40.6	-25.0	-15.6
2	11740.00	-63.9	-55.3	2.9	-52.4	-25.0	-27.4
Antenna Polarity & Test Distance: Vertical at 3 M							
No.	Freq. (MHz)	Reading (dBm)	S.G Power Value (dBm)	Correction Factor (dB)	EIRP (dBm)	Limit (dBm)	Margin (dB)
1	1594.00	-39.4	-36.4	5.3	-31.1	-25.0	-6.1
2	11740.00	-62.4	-53.8	2.9	-50.9	-25.0	-25.9

Remarks:

1. Output Power (dBm) = S.G Value (dBm) + Correction Factor (dB).
2. Correction Factor (dB) = Substitution Antenna Gain (dB) + Cable Loss (dB).

Mode	TX channel 176	Frequency Range	Above 1000MHz
------	----------------	-----------------	---------------

Antenna Polarity & Test Distance: Horizontal at 3 M							
No.	Freq. (MHz)	Reading (dBm)	S.G Power Value (dBm)	Correction Factor (dB)	EIRP (dBm)	Limit (dBm)	Margin (dB)
1	1594.00	-50.8	-47.8	5.3	-42.5	-25.0	-17.5
2	11760.00	-63.4	-54.8	3.0	-51.8	-25.0	-26.8
Antenna Polarity & Test Distance: Vertical at 3 M							
No.	Freq. (MHz)	Reading (dBm)	S.G Power Value (dBm)	Correction Factor (dB)	EIRP (dBm)	Limit (dBm)	Margin (dB)
1	1594.00	-38.8	-35.8	5.3	-30.5	-25.0	-5.5
2	11760.00	-62.9	-54.3	3.0	-51.3	-25.0	-26.3

Remarks:

1. Output Power (dBm) = S.G Value (dBm) + Correction Factor (dB).
2. Correction Factor (dB) = Substitution Antenna Gain (dB) + Cable Loss (dB).



Mode	TX channel 178	Frequency Range	Above 1000MHz
------	----------------	-----------------	---------------

Antenna Polarity & Test Distance: Horizontal at 3 M							
No.	Freq. (MHz)	Reading (dBm)	S.G Power Value (dBm)	Correction Factor (dB)	EIRP (dBm)	Limit (dBm)	Margin (dB)
1	1594.00	-49.4	-46.4	5.3	-41.1	-25.0	-16.1
2	11780.00	-63.8	-55.2	3.0	-52.2	-25.0	-27.2
Antenna Polarity & Test Distance: Vertical at 3 M							
No.	Freq. (MHz)	Reading (dBm)	S.G Power Value (dBm)	Correction Factor (dB)	EIRP (dBm)	Limit (dBm)	Margin (dB)
1	1594.00	-38.8	-35.8	5.3	-30.5	-25.0	-5.5
2	11780.00	-63.5	-54.9	3.0	-51.9	-25.0	-26.9

Remarks:

1. Output Power (dBm) = S.G Value (dBm) + Correction Factor (dB).
2. Correction Factor (dB) = Substitution Antenna Gain (dB) + Cable Loss (dB).

Mode	TX channel 180	Frequency Range	Above 1000MHz
------	----------------	-----------------	---------------

Antenna Polarity & Test Distance: Horizontal at 3 M							
No.	Freq. (MHz)	Reading (dBm)	S.G Power Value (dBm)	Correction Factor (dB)	EIRP (dBm)	Limit (dBm)	Margin (dB)
1	1594.00	-50.9	-47.9	5.3	-42.6	-25.0	-17.6
2	11800.00	-63.7	-55.1	3.1	-52.0	-25.0	-27.0
Antenna Polarity & Test Distance: Vertical at 3 M							
No.	Freq. (MHz)	Reading (dBm)	S.G Power Value (dBm)	Correction Factor (dB)	EIRP (dBm)	Limit (dBm)	Margin (dB)
1	1594.00	-40.5	-37.5	5.3	-32.2	-25.0	-7.2
2	11800.00	-63.7	-55.1	3.1	-52.0	-25.0	-27.0

Remarks:

1. Output Power (dBm) = S.G Value (dBm) + Correction Factor (dB).
2. Correction Factor (dB) = Substitution Antenna Gain (dB) + Cable Loss (dB).

Mode	TX channel 182	Frequency Range	Above 1000MHz
------	----------------	-----------------	---------------

Antenna Polarity & Test Distance: Horizontal at 3 M							
No.	Freq. (MHz)	Reading (dBm)	S.G Power Value (dBm)	Correction Factor (dB)	EIRP (dBm)	Limit (dBm)	Margin (dB)
1	1594.00	-50.7	-47.7	5.3	-42.4	-25.0	-17.4
2	11820.00	-63.5	-54.9	3.1	-51.8	-25.0	-26.8
Antenna Polarity & Test Distance: Vertical at 3 M							
No.	Freq. (MHz)	Reading (dBm)	S.G Power Value (dBm)	Correction Factor (dB)	EIRP (dBm)	Limit (dBm)	Margin (dB)
1	1594.00	-40.1	-37.1	5.3	-31.8	-25.0	-6.8
2	11820.00	-63.5	-54.9	3.1	-51.8	-25.0	-26.8

Remarks:

1. Output Power (dBm) = S.G Value (dBm) + Correction Factor (dB).
2. Correction Factor (dB) = Substitution Antenna Gain (dB) + Cable Loss (dB).



Mode	TX channel 184	Frequency Range	Above 1000MHz
------	----------------	-----------------	---------------

Antenna Polarity & Test Distance: Horizontal at 3 M							
No.	Freq. (MHz)	Reading (dBm)	S.G Power Value (dBm)	Correction Factor (dB)	EIRP (dBm)	Limit (dBm)	Margin (dB)
1	1594.00	-50.1	-47.1	5.3	-41.8	-25.0	-16.8
2	11840.00	-63.5	-54.9	3.2	-51.7	-25.0	-26.7

Antenna Polarity & Test Distance: Vertical at 3 M							
No.	Freq. (MHz)	Reading (dBm)	S.G Power Value (dBm)	Correction Factor (dB)	EIRP (dBm)	Limit (dBm)	Margin (dB)
1	1594.00	-40.8	-37.8	5.3	-32.5	-25.0	-7.5
2	11840.00	-63.1	-54.5	3.2	-51.3	-25.0	-26.3

Remarks:

1. Output Power (dBm) = S.G Value (dBm) + Correction Factor (dB).
2. Correction Factor (dB) = Substitution Antenna Gain (dB) + Cable Loss (dB).



Channel Bandwidth 10MHz, Data Rate 27Mbps

Mode	TX channel 172	Frequency Range	Above 1000MHz
------	----------------	-----------------	---------------

Antenna Polarity & Test Distance: Horizontal at 3 M

No.	Freq. (MHz)	Reading (dBm)	S.G Power Value (dBm)	Correction Factor (dB)	EIRP (dBm)	Limit (dBm)	Margin (dB)
1	1594.00	-48.5	-45.5	5.3	-40.2	-25.0	-15.2
2	11720.00	-63.4	-54.8	2.9	-51.9	-25.0	-26.9

Antenna Polarity & Test Distance: Vertical at 3 M

No.	Freq. (MHz)	Reading (dBm)	S.G Power Value (dBm)	Correction Factor (dB)	EIRP (dBm)	Limit (dBm)	Margin (dB)
1	1594.00	-40.8	-37.8	5.3	-32.5	-25.0	-7.5
2	11720.00	-63.4	-54.8	2.9	-51.9	-25.0	-26.9

Remarks:

1. Output Power (dBm) = S.G Value (dBm) + Correction Factor (dB).
2. Correction Factor (dB) = Substitution Antenna Gain (dB) + Cable Loss (dB).

Mode	TX channel 174	Frequency Range	Above 1000MHz
------	----------------	-----------------	---------------

Antenna Polarity & Test Distance: Horizontal at 3 M

No.	Freq. (MHz)	Reading (dBm)	S.G Power Value (dBm)	Correction Factor (dB)	EIRP (dBm)	Limit (dBm)	Margin (dB)
1	1594.00	-51	-48	5.3	-42.7	-25.0	-17.7
2	11740.00	-63.5	-54.9	2.9	-52	-25.0	-27.0

Antenna Polarity & Test Distance: Vertical at 3 M

No.	Freq. (MHz)	Reading (dBm)	S.G Power Value (dBm)	Correction Factor (dB)	EIRP (dBm)	Limit (dBm)	Margin (dB)
1	1594.00	-39.6	-36.6	5.3	-31.3	-25.0	-6.3
2	11740.00	-63.4	-54.8	2.9	-51.9	-25.0	-26.9

Remarks:

1. Output Power (dBm) = S.G Value (dBm) + Correction Factor (dB).
2. Correction Factor (dB) = Substitution Antenna Gain (dB) + Cable Loss (dB).

Mode	TX channel 176	Frequency Range	Above 1000MHz
------	----------------	-----------------	---------------

Antenna Polarity & Test Distance: Horizontal at 3 M

No.	Freq. (MHz)	Reading (dBm)	S.G Power Value (dBm)	Correction Factor (dB)	EIRP (dBm)	Limit (dBm)	Margin (dB)
1	1594.00	-50.6	-47.6	5.3	-42.3	-25.0	-17.3
2	11760.00	-63.4	-54.8	3.0	-51.8	-25.0	-26.8

Antenna Polarity & Test Distance: Vertical at 3 M

No.	Freq. (MHz)	Reading (dBm)	S.G Power Value (dBm)	Correction Factor (dB)	EIRP (dBm)	Limit (dBm)	Margin (dB)
1	1594.00	-41.5	-38.5	5.3	-33.2	-25.0	-8.2
2	11760.00	-63.6	-55.0	3.0	-52	-25.0	-27.0

Remarks:

1. Output Power (dBm) = S.G Value (dBm) + Correction Factor (dB).
2. Correction Factor (dB) = Substitution Antenna Gain (dB) + Cable Loss (dB).



Mode	TX channel 178	Frequency Range	Above 1000MHz
------	----------------	-----------------	---------------

Antenna Polarity & Test Distance: Horizontal at 3 M							
No.	Freq. (MHz)	Reading (dBm)	S.G Power Value (dBm)	Correction Factor (dB)	EIRP (dBm)	Limit (dBm)	Margin (dB)
1	1594.00	-51.0	-48	5.3	-42.7	-25.0	-17.7
2	11780.00	-63.8	-55.2	3.0	-52.2	-25.0	-27.2
Antenna Polarity & Test Distance: Vertical at 3 M							
No.	Freq. (MHz)	Reading (dBm)	S.G Power Value (dBm)	Correction Factor (dB)	EIRP (dBm)	Limit (dBm)	Margin (dB)
1	1594.00	-41.4	-38.4	5.3	-33.1	-25.0	-8.1
2	11780.00	-63.0	-54.4	3.0	-51.4	-25.0	-26.4

Remarks:

1. Output Power (dBm) = S.G Value (dBm) + Correction Factor (dB).
2. Correction Factor (dB) = Substitution Antenna Gain (dB) + Cable Loss (dB).

Mode	TX channel 180	Frequency Range	Above 1000MHz
------	----------------	-----------------	---------------

Antenna Polarity & Test Distance: Horizontal at 3 M							
No.	Freq. (MHz)	Reading (dBm)	S.G Power Value (dBm)	Correction Factor (dB)	EIRP (dBm)	Limit (dBm)	Margin (dB)
1	1594.00	-50.9	-47.9	5.3	-42.6	-25.0	-17.6
2	11800.00	-62.9	-54.3	3.1	-51.2	-25.0	-26.2
Antenna Polarity & Test Distance: Vertical at 3 M							
No.	Freq. (MHz)	Reading (dBm)	S.G Power Value (dBm)	Correction Factor (dB)	EIRP (dBm)	Limit (dBm)	Margin (dB)
1	1594.00	-41.3	-38.3	5.3	-33.0	-25.0	-8.0
2	11800.00	-63.3	-54.7	3.1	-51.6	-25.0	-26.6

Remarks:

1. Output Power (dBm) = S.G Value (dBm) + Correction Factor (dB).
2. Correction Factor (dB) = Substitution Antenna Gain (dB) + Cable Loss (dB).

Mode	TX channel 182	Frequency Range	Above 1000MHz
------	----------------	-----------------	---------------

Antenna Polarity & Test Distance: Horizontal at 3 M							
No.	Freq. (MHz)	Reading (dBm)	S.G Power Value (dBm)	Correction Factor (dB)	EIRP (dBm)	Limit (dBm)	Margin (dB)
1	1594.00	-51.4	-48.4	5.3	-43.1	-25.0	-18.1
2	11820.00	-63.6	-55.0	3.1	-51.9	-25.0	-26.9
Antenna Polarity & Test Distance: Vertical at 3 M							
No.	Freq. (MHz)	Reading (dBm)	S.G Power Value (dBm)	Correction Factor (dB)	EIRP (dBm)	Limit (dBm)	Margin (dB)
1	1594.00	-41.3	-38.3	5.3	-33.0	-25.0	-8.0
2	11820.00	-63.5	-54.9	3.1	-51.8	-25.0	-26.8

Remarks:

1. Output Power (dBm) = S.G Value (dBm) + Correction Factor (dB).
2. Correction Factor (dB) = Substitution Antenna Gain (dB) + Cable Loss (dB).



Mode	TX channel 184	Frequency Range	Above 1000MHz
------	----------------	-----------------	---------------

Antenna Polarity & Test Distance: Horizontal at 3 M							
---	--	--	--	--	--	--	--

No.	Freq. (MHz)	Reading (dBm)	S.G Power Value (dBm)	Correction Factor (dB)	EIRP (dBm)	Limit (dBm)	Margin (dB)
1	1594.00	-49.7	-46.7	5.3	-41.4	-25.0	-16.4
2	11840.00	-63.8	-55.2	3.2	-52.0	-25.0	-27.0

Antenna Polarity & Test Distance: Vertical at 3 M							
---	--	--	--	--	--	--	--

No.	Freq. (MHz)	Reading (dBm)	S.G Power Value (dBm)	Correction Factor (dB)	EIRP (dBm)	Limit (dBm)	Margin (dB)
1	1594.00	-42.0	-39.0	5.3	-33.7	-25.0	-8.7
2	11840.00	-63.9	-55.3	3.2	-52.1	-25.0	-27.1

Remarks:

1. Output Power (dBm) = S.G Value (dBm) + Correction Factor (dB).
2. Correction Factor (dB) = Substitution Antenna Gain (dB) + Cable Loss (dB).



A D T

Channel Bandwidth 20MHz, Data Rate 6Mbps

Mode	TX channel 175	Frequency Range	Above 1000MHz
------	----------------	-----------------	---------------

Antenna Polarity & Test Distance: Horizontal at 3 M

No.	Freq. (MHz)	Reading (dBm)	S.G Power Value (dBm)	Correction Factor (dB)	EIRP (dBm)	Limit (dBm)	Margin (dB)
1	1594.00	-57.7	-54.7	5.3	-49.4	-25.0	-24.4
2	11750.00	-67.1	-58.5	3.0	-55.5	-25.0	-30.5

Antenna Polarity & Test Distance: Vertical at 3 M

No.	Freq. (MHz)	Reading (dBm)	S.G Power Value (dBm)	Correction Factor (dB)	EIRP (dBm)	Limit (dBm)	Margin (dB)
1	1594.00	-52.1	-49.1	5.3	-43.8	-25.0	-18.8
2	11750.00	-67.2	-58.6	3.0	-55.6	-25.0	-30.6

Remarks:

1. Output Power (dBm) = S.G Value (dBm) + Correction Factor (dB).
2. Correction Factor (dB) = Substitution Antenna Gain (dB) + Cable Loss (dB).

Mode	TX channel 181	Frequency Range	Above 1000MHz
------	----------------	-----------------	---------------

Antenna Polarity & Test Distance: Horizontal at 3 M

No.	Freq. (MHz)	Reading (dBm)	S.G Power Value (dBm)	Correction Factor (dB)	EIRP (dBm)	Limit (dBm)	Margin (dB)
1	1594.00	-58.6	-55.6	5.3	-50.3	-25.0	-25.3
2	11810.00	-66.7	-58.1	3.1	-55.0	-25.0	-30.0

Antenna Polarity & Test Distance: Vertical at 3 M

No.	Freq. (MHz)	Reading (dBm)	S.G Power Value (dBm)	Correction Factor (dB)	EIRP (dBm)	Limit (dBm)	Margin (dB)
1	1594.00	-49.5	-46.5	5.3	-41.2	-25.0	-16.2
2	11810.00	-67.1	-58.5	3.1	-55.4	-25.0	-30.4

Remarks:

1. Output Power (dBm) = S.G Value (dBm) + Correction Factor (dB).
2. Correction Factor (dB) = Substitution Antenna Gain (dB) + Cable Loss (dB).



Channel Bandwidth 20MHz, Data Rate 54Mbps

Mode	TX channel 175	Frequency Range	Above 1000MHz
------	----------------	-----------------	---------------

Antenna Polarity & Test Distance: Horizontal at 3 M

No.	Freq. (MHz)	Reading (dBm)	S.G Power Value (dBm)	Correction Factor (dB)	EIRP (dBm)	Limit (dBm)	Margin (dB)
1	1594.00	-59.6	-56.6	5.3	-51.3	-25.0	-26.3
2	11750.00	-66.6	-58.0	3.0	-55.0	-25.0	-30.0

Antenna Polarity & Test Distance: Vertical at 3 M

No.	Freq. (MHz)	Reading (dBm)	S.G Power Value (dBm)	Correction Factor (dB)	EIRP (dBm)	Limit (dBm)	Margin (dB)
1	1594.00	-50.6	-47.6	5.3	-42.3	-25.0	-17.3
2	11750.00	-66.0	-57.4	3.0	-54.4	-25.0	-29.4

Remarks:

1. Output Power (dBm) = S.G Value (dBm) + Correction Factor (dB).
2. Correction Factor (dB) = Substitution Antenna Gain (dB) + Cable Loss (dB).

Mode	TX channel 181	Frequency Range	Above 1000MHz
------	----------------	-----------------	---------------

Antenna Polarity & Test Distance: Horizontal at 3 M

No.	Freq. (MHz)	Reading (dBm)	S.G Power Value (dBm)	Correction Factor (dB)	EIRP (dBm)	Limit (dBm)	Margin (dB)
1	1594.00	-57.9	-54.9	5.3	-49.6	-25.0	-24.6
2	11810.00	-67.1	-58.5	3.1	-55.4	-25.0	-30.4

Antenna Polarity & Test Distance: Vertical at 3 M

No.	Freq. (MHz)	Reading (dBm)	S.G Power Value (dBm)	Correction Factor (dB)	EIRP (dBm)	Limit (dBm)	Margin (dB)
1	1594.00	-51.0	-48.0	5.3	-42.7	-25.0	-17.7
2	11810.00	-67.0	-58.4	3.1	-55.3	-25.0	-30.3

Remarks:

1. Output Power (dBm) = S.G Value (dBm) + Correction Factor (dB).
2. Correction Factor (dB) = Substitution Antenna Gain (dB) + Cable Loss (dB).

Mode B

Below 1GHz

Channel Bandwidth 10MHz, Data Rate 3Mbps

Mode	TX channel 184	Frequency Range	Below 1000 MHz
------	----------------	-----------------	----------------

Antenna Polarity & Test Distance: Horizontal at 3 M

No.	Freq. (MHz)	Reading (dBm)	S.G Power Value (dBm)	Correction Factor (dB)	EIRP (dBm)	Limit (dBm)	Margin (dB)
1	30.00	-49.40	-34.20	-12.20	-46.40	-25.00	-21.40
2	92.20	-40.30	-50.30	1.10	-49.20	-25.00	-24.20
3	199.12	-47.00	-60.50	5.40	-55.10	-25.00	-30.10
4	366.29	-47.40	-55.00	5.20	-49.80	-25.00	-24.80
5	681.20	-58.50	-60.60	5.10	-55.50	-25.00	-30.50
6	834.77	-61.20	-57.80	4.00	-53.80	-25.00	-28.80

Antenna Polarity & Test Distance: Vertical at 3 M

No.	Freq. (MHz)	Reading (dBm)	S.G Power Value (dBm)	Correction Factor (dB)	EIRP (dBm)	Limit (dBm)	Margin (dB)
1	30.00	-35.10	-31.20	-12.20	-43.40	-25.00	-18.40
2	199.12	-52.00	-59.00	5.40	-53.60	-25.00	-28.60
3	267.15	-54.10	-57.70	5.30	-52.40	-25.00	-27.40
4	376.01	-48.20	-53.60	5.30	-48.30	-25.00	-23.30
5	729.80	-47.10	-45.20	4.90	-40.30	-25.00	-15.30
6	747.29	-50.10	-47.50	4.70	-42.80	-25.00	-17.80

Remarks:

1. Output Power (dBm) = S.G Value (dBm) + Correction Factor (dB).
2. Correction Factor (dB) = Substitution Antenna Gain (dB) + Cable Loss (dB).

Channel Bandwidth 20MHz, Data Rate 6Mbps

Mode	TX channel 175	Frequency Range	Below 1000 MHz
------	----------------	-----------------	----------------

Antenna Polarity & Test Distance: Horizontal at 3 M

No.	Freq. (MHz)	Reading (dBm)	S.G Power Value (dBm)	Correction Factor (dB)	EIRP (dBm)	Limit (dBm)	Margin (dB)
1	94.15	-40.50	-50.40	1.00	-49.40	-25.00	-24.40
2	199.12	-46.80	-60.30	5.40	-54.90	-25.00	-29.90
3	366.29	-48.30	-55.90	5.20	-50.70	-25.00	-25.70
4	500.42	-56.70	-61.60	4.90	-56.70	-25.00	-31.70
5	747.29	-48.20	-48.70	4.70	-44.00	-25.00	-19.00
6	875.59	-60.50	-56.80	3.90	-52.90	-25.00	-27.90

Antenna Polarity & Test Distance: Vertical at 3 M

No.	Freq. (MHz)	Reading (dBm)	S.G Power Value (dBm)	Correction Factor (dB)	EIRP (dBm)	Limit (dBm)	Margin (dB)
1	30.00	-38.40	-34.50	-12.20	-46.70	-25.00	-21.70
2	92.20	-45.80	-53.40	1.10	-52.30	-25.00	-27.30
3	199.12	-51.50	-58.50	5.40	-53.10	-25.00	-28.10
4	267.15	-53.50	-57.10	5.30	-51.80	-25.00	-26.80
5	376.01	-47.80	-53.20	5.30	-47.90	-25.00	-22.90
6	729.80	-46.10	-44.20	4.90	-39.30	-25.00	-14.30

Remarks:

1. Output Power (dBm) = S.G Value (dBm) + Correction Factor (dB).
2. Correction Factor (dB) = Substitution Antenna Gain (dB) + Cable Loss (dB).



Above 1GHz

Channel Bandwidth 10MHz, Data Rate 3Mbps

Mode	TX channel 172	Frequency Range	Above 1000MHz
------	----------------	-----------------	---------------

Antenna Polarity & Test Distance: Horizontal at 3 M							
No.	Freq. (MHz)	Reading (dBm)	S.G Power Value (dBm)	Correction Factor (dB)	EIRP (dBm)	Limit (dBm)	Margin (dB)
1	1594.00	-57.4	-54.4	5.3	-49.1	-25.0	-24.1
2	11720.00	-63.5	-54.9	2.9	-52.0	-25.0	-27.0
Antenna Polarity & Test Distance: Vertical at 3 M							
No.	Freq. (MHz)	Reading (dBm)	S.G Power Value (dBm)	Correction Factor (dB)	EIRP (dBm)	Limit (dBm)	Margin (dB)
1	1594.00	-50.3	-47.3	5.3	-42.0	-25.0	-17.0
2	11720.00	-63.6	-55.0	2.9	-52.1	-25.0	-27.1

Remarks:

1. Output Power (dBm) = S.G Value (dBm) + Correction Factor (dB).
2. Correction Factor (dB) = Substitution Antenna Gain (dB) + Cable Loss (dB).

Mode	TX channel 174	Frequency Range	Above 1000MHz
------	----------------	-----------------	---------------

Antenna Polarity & Test Distance: Horizontal at 3 M							
No.	Freq. (MHz)	Reading (dBm)	S.G Power Value (dBm)	Correction Factor (dB)	EIRP (dBm)	Limit (dBm)	Margin (dB)
1	1594.00	-56.4	-53.4	5.3	-48.1	-25.0	-23.1
2	11740.00	-63.2	-54.6	2.9	-51.7	-25.0	-26.7
Antenna Polarity & Test Distance: Vertical at 3 M							
No.	Freq. (MHz)	Reading (dBm)	S.G Power Value (dBm)	Correction Factor (dB)	EIRP (dBm)	Limit (dBm)	Margin (dB)
1	1594.00	-51.1	-48.1	5.3	-42.8	-25.0	-17.8
2	11740.00	-63.7	-55.1	2.9	-52.2	-25.0	-27.2

Remarks:

1. Output Power (dBm) = S.G Value (dBm) + Correction Factor (dB).
2. Correction Factor (dB) = Substitution Antenna Gain (dB) + Cable Loss (dB).

Mode	TX channel 176	Frequency Range	Above 1000MHz
------	----------------	-----------------	---------------

Antenna Polarity & Test Distance: Horizontal at 3 M							
No.	Freq. (MHz)	Reading (dBm)	S.G Power Value (dBm)	Correction Factor (dB)	EIRP (dBm)	Limit (dBm)	Margin (dB)
1	1594.00	-56.6	-53.6	5.3	-48.3	-25.0	-23.3
2	11760.00	-63.1	-54.5	3.0	-51.5	-25.0	-26.5
Antenna Polarity & Test Distance: Vertical at 3 M							
No.	Freq. (MHz)	Reading (dBm)	S.G Power Value (dBm)	Correction Factor (dB)	EIRP (dBm)	Limit (dBm)	Margin (dB)
1	1594.00	-49.7	-46.7	5.3	-41.4	-25.0	-16.4
2	11760.00	-63.3	-54.7	3.0	-51.7	-25.0	-26.7

Remarks:

1. Output Power (dBm) = S.G Value (dBm) + Correction Factor (dB).
2. Correction Factor (dB) = Substitution Antenna Gain (dB) + Cable Loss (dB).



Mode	TX channel 178	Frequency Range	Above 1000MHz
------	----------------	-----------------	---------------

Antenna Polarity & Test Distance: Horizontal at 3 M							
No.	Freq. (MHz)	Reading (dBm)	S.G Power Value (dBm)	Correction Factor (dB)	EIRP (dBm)	Limit (dBm)	Margin (dB)
1	1594.00	-56.5	-53.5	5.3	-48.2	-25.0	-23.2
2	11780.00	-63.1	-54.5	3.0	-51.5	-25.0	-26.5
Antenna Polarity & Test Distance: Vertical at 3 M							
No.	Freq. (MHz)	Reading (dBm)	S.G Power Value (dBm)	Correction Factor (dB)	EIRP (dBm)	Limit (dBm)	Margin (dB)
1	1594.00	-49.9	-46.9	5.3	-41.6	-25.0	-16.6
2	11780.00	-63.2	-54.6	3.0	-51.6	-25.0	-26.6

Remarks:

1. Output Power (dBm) = S.G Value (dBm) + Correction Factor (dB).
2. Correction Factor (dB) = Substitution Antenna Gain (dB) + Cable Loss (dB).

Mode	TX channel 180	Frequency Range	Above 1000MHz
------	----------------	-----------------	---------------

Antenna Polarity & Test Distance: Horizontal at 3 M							
No.	Freq. (MHz)	Reading (dBm)	S.G Power Value (dBm)	Correction Factor (dB)	EIRP (dBm)	Limit (dBm)	Margin (dB)
1	1594.00	-56.6	-53.6	5.3	-48.3	-25.0	-23.3
2	11800.00	-63.0	-54.4	3.1	-51.3	-25.0	-26.3
Antenna Polarity & Test Distance: Vertical at 3 M							
No.	Freq. (MHz)	Reading (dBm)	S.G Power Value (dBm)	Correction Factor (dB)	EIRP (dBm)	Limit (dBm)	Margin (dB)
1	1594.00	-50.1	-47.1	5.3	-41.8	-25.0	-16.8
2	11800.00	-62.8	-54.2	3.1	-51.1	-25.0	-26.1

Remarks:

1. Output Power (dBm) = S.G Value (dBm) + Correction Factor (dB).
2. Correction Factor (dB) = Substitution Antenna Gain (dB) + Cable Loss (dB).

Mode	TX channel 182	Frequency Range	Above 1000MHz
------	----------------	-----------------	---------------

Antenna Polarity & Test Distance: Horizontal at 3 M							
No.	Freq. (MHz)	Reading (dBm)	S.G Power Value (dBm)	Correction Factor (dB)	EIRP (dBm)	Limit (dBm)	Margin (dB)
1	1594.00	-56.5	-53.5	5.3	-48.2	-25.0	-23.2
2	11800.00	-62.8	-54.2	3.1	-51.1	-25.0	-26.1
Antenna Polarity & Test Distance: Vertical at 3 M							
No.	Freq. (MHz)	Reading (dBm)	S.G Power Value (dBm)	Correction Factor (dB)	EIRP (dBm)	Limit (dBm)	Margin (dB)
1	1594.00	-51.2	-48.2	5.3	-42.9	-25.0	-17.9
2	11820.00	-63.5	-54.9	3.1	-51.8	-25.0	-26.8

Remarks:

1. Output Power (dBm) = S.G Value (dBm) + Correction Factor (dB).
2. Correction Factor (dB) = Substitution Antenna Gain (dB) + Cable Loss (dB).



Mode	TX channel 184	Frequency Range	Above 1000MHz
------	----------------	-----------------	---------------

Antenna Polarity & Test Distance: Horizontal at 3 M							
No.	Freq. (MHz)	Reading (dBm)	S.G Power Value (dBm)	Correction Factor (dB)	EIRP (dBm)	Limit (dBm)	Margin (dB)
1	1594.00	-56.6	-53.6	5.3	-48.3	-25.0	-23.3
2	11840.00	-62.7	-54.1	3.2	-50.9	-25.0	-25.9

Antenna Polarity & Test Distance: Vertical at 3 M							
No.	Freq. (MHz)	Reading (dBm)	S.G Power Value (dBm)	Correction Factor (dB)	EIRP (dBm)	Limit (dBm)	Margin (dB)
1	1594.00	-49.8	-46.8	5.3	-41.5	-25.0	-16.5
2	11840.00	-62.9	-54.3	3.2	-51.1	-25.0	-26.1

Remarks:

1. Output Power (dBm) = S.G Value (dBm) + Correction Factor (dB).
2. Correction Factor (dB) = Substitution Antenna Gain (dB) + Cable Loss (dB).



Channel Bandwidth 10MHz, Data Rate 27Mbps

Mode	TX channel 172	Frequency Range	Above 1000MHz
------	----------------	-----------------	---------------

Antenna Polarity & Test Distance: Horizontal at 3 M

No.	Freq. (MHz)	Reading (dBm)	S.G Power Value (dBm)	Correction Factor (dB)	EIRP (dBm)	Limit (dBm)	Margin (dB)
1	1594.00	-55.4	-52.4	5.3	-47.1	-25.0	-22.1
2	11720.00	-63.2	-54.6	2.9	-51.7	-25.0	-26.7

Antenna Polarity & Test Distance: Vertical at 3 M

No.	Freq. (MHz)	Reading (dBm)	S.G Power Value (dBm)	Correction Factor (dB)	EIRP (dBm)	Limit (dBm)	Margin (dB)
1	1594.00	-49.7	-46.7	5.3	-41.4	-25.0	-16.4
2	11720.00	-63.6	-55.0	2.9	-52.1	-25.0	-27.1

Remarks:

1. Output Power (dBm) = S.G Value (dBm) + Correction Factor (dB).
2. Correction Factor (dB) = Substitution Antenna Gain (dB) + Cable Loss (dB).

Mode	TX channel 174	Frequency Range	Above 1000MHz
------	----------------	-----------------	---------------

Antenna Polarity & Test Distance: Horizontal at 3 M

No.	Freq. (MHz)	Reading (dBm)	S.G Power Value (dBm)	Correction Factor (dB)	EIRP (dBm)	Limit (dBm)	Margin (dB)
1	1594.00	-55.6	-52.6	5.3	-47.3	-25.0	-22.3
2	11740.00	-63.5	-54.9	2.9	-52.0	-25.0	-27.0

Antenna Polarity & Test Distance: Vertical at 3 M

No.	Freq. (MHz)	Reading (dBm)	S.G Power Value (dBm)	Correction Factor (dB)	EIRP (dBm)	Limit (dBm)	Margin (dB)
1	1594.00	-52.2	-49.2	5.3	-43.9	-25.0	-18.9
2	11740.00	-63.7	-55.1	2.9	-52.2	-25.0	-27.2

Remarks:

1. Output Power (dBm) = S.G Value (dBm) + Correction Factor (dB).
2. Correction Factor (dB) = Substitution Antenna Gain (dB) + Cable Loss (dB).

Mode	TX channel 176	Frequency Range	Above 1000MHz
------	----------------	-----------------	---------------

Antenna Polarity & Test Distance: Horizontal at 3 M

No.	Freq. (MHz)	Reading (dBm)	S.G Power Value (dBm)	Correction Factor (dB)	EIRP (dBm)	Limit (dBm)	Margin (dB)
1	1594.00	-55.5	-52.5	5.3	-47.2	-25.0	-22.2
2	11760.00	-64.2	-55.6	3.0	-52.6	-25.0	-27.6

Antenna Polarity & Test Distance: Vertical at 3 M

No.	Freq. (MHz)	Reading (dBm)	S.G Power Value (dBm)	Correction Factor (dB)	EIRP (dBm)	Limit (dBm)	Margin (dB)
1	1594.00	-51.3	-48.3	5.3	-43.0	-25.0	-18.0
2	11760.00	-63.9	-55.3	3.0	-52.3	-25.0	-27.3

Remarks:

1. Output Power (dBm) = S.G Value (dBm) + Correction Factor (dB).
2. Correction Factor (dB) = Substitution Antenna Gain (dB) + Cable Loss (dB).



Mode	TX channel 178	Frequency Range	Above 1000MHz
------	----------------	-----------------	---------------

Antenna Polarity & Test Distance: Horizontal at 3 M							
No.	Freq. (MHz)	Reading (dBm)	S.G Power Value (dBm)	Correction Factor (dB)	EIRP (dBm)	Limit (dBm)	Margin (dB)
1	1594.00	-56.4	-53.4	5.3	-48.1	-25.0	-23.1
2	11780.00	-63.8	-55.2	3.0	-52.2	-25.0	-27.2
Antenna Polarity & Test Distance: Vertical at 3 M							
No.	Freq. (MHz)	Reading (dBm)	S.G Power Value (dBm)	Correction Factor (dB)	EIRP (dBm)	Limit (dBm)	Margin (dB)
1	1594.00	-50.4	-47.4	5.3	-42.1	-25.0	-17.1
2	11780.00	-63.8	-55.2	3.0	-52.2	-25.0	-27.2

Remarks:

1. Output Power (dBm) = S.G Value (dBm) + Correction Factor (dB).
2. Correction Factor (dB) = Substitution Antenna Gain (dB) + Cable Loss (dB).

Mode	TX channel 180	Frequency Range	Above 1000MHz
------	----------------	-----------------	---------------

Antenna Polarity & Test Distance: Horizontal at 3 M							
No.	Freq. (MHz)	Reading (dBm)	S.G Power Value (dBm)	Correction Factor (dB)	EIRP (dBm)	Limit (dBm)	Margin (dB)
1	1594.00	-57.6	-54.6	5.3	-49.3	-25.0	-24.3
2	11800.00	-63.9	-55.3	3.1	-52.2	-25.0	-27.2
Antenna Polarity & Test Distance: Vertical at 3 M							
No.	Freq. (MHz)	Reading (dBm)	S.G Power Value (dBm)	Correction Factor (dB)	EIRP (dBm)	Limit (dBm)	Margin (dB)
1	1594.00	-51.3	-48.3	5.3	-43.0	-25.0	-18.0
2	11800.00	-64.0	-55.4	3.1	-52.3	-25.0	-27.3

Remarks:

1. Output Power (dBm) = S.G Value (dBm) + Correction Factor (dB).
2. Correction Factor (dB) = Substitution Antenna Gain (dB) + Cable Loss (dB).

Mode	TX channel 182	Frequency Range	Above 1000MHz
------	----------------	-----------------	---------------

Antenna Polarity & Test Distance: Horizontal at 3 M							
No.	Freq. (MHz)	Reading (dBm)	S.G Power Value (dBm)	Correction Factor (dB)	EIRP (dBm)	Limit (dBm)	Margin (dB)
1	1594.00	-57.3	-54.3	5.3	-49.0	-25.0	-24.0
2	11820.00	-63.5	-54.9	3.1	-51.8	-25.0	-26.8
Antenna Polarity & Test Distance: Vertical at 3 M							
No.	Freq. (MHz)	Reading (dBm)	S.G Power Value (dBm)	Correction Factor (dB)	EIRP (dBm)	Limit (dBm)	Margin (dB)
1	1594.00	-51.0	-48.0	5.3	-42.7	-25.0	-17.7
2	11820.00	-63.7	-55.1	3.1	-52.0	-25.0	-27.0

Remarks:

1. Output Power (dBm) = S.G Value (dBm) + Correction Factor (dB).
2. Correction Factor (dB) = Substitution Antenna Gain (dB) + Cable Loss (dB).



Mode	TX channel 184	Frequency Range	Above 1000MHz
------	----------------	-----------------	---------------

Antenna Polarity & Test Distance: Horizontal at 3 M							
No.	Freq. (MHz)	Reading (dBm)	S.G Power Value (dBm)	Correction Factor (dB)	EIRP (dBm)	Limit (dBm)	Margin (dB)
1	1594.00	-56.9	-53.9	5.3	-48.6	-25.0	-23.6
2	11840.00	-63.6	-55.0	3.2	-51.8	-25.0	-26.8

Antenna Polarity & Test Distance: Vertical at 3 M							
No.	Freq. (MHz)	Reading (dBm)	S.G Power Value (dBm)	Correction Factor (dB)	EIRP (dBm)	Limit (dBm)	Margin (dB)
1	1594.00	-50.7	-47.7	5.3	-42.4	-25.0	-17.4
2	11840.00	-63.3	-54.7	3.2	-51.5	-25.0	-26.5

Remarks:

1. Output Power (dBm) = S.G Value (dBm) + Correction Factor (dB).
2. Correction Factor (dB) = Substitution Antenna Gain (dB) + Cable Loss (dB).



Channel Bandwidth 20MHz, Data Rate 6Mbps

Mode	TX channel 175	Frequency Range	Above 1000MHz
------	----------------	-----------------	---------------

Antenna Polarity & Test Distance: Horizontal at 3 M

No.	Freq. (MHz)	Reading (dBm)	S.G Power Value (dBm)	Correction Factor (dB)	EIRP (dBm)	Limit (dBm)	Margin (dB)
1	1250.00	-47.3	-47.1	4.1	-43.0	-25.0	-18.0
2	11750.00	-65.9	-38.9	3.0	-35.9	-25.0	-10.9

Antenna Polarity & Test Distance: Vertical at 3 M

No.	Freq. (MHz)	Reading (dBm)	S.G Power Value (dBm)	Correction Factor (dB)	EIRP (dBm)	Limit (dBm)	Margin (dB)
1	1250.00	-46.5	-46.1	4.1	-42.0	-25.0	-17.0
2	11750.00	-63.5	-37.5	3.0	-34.5	-25.0	-9.5

Remarks:

1. Output Power (dBm) = S.G Value (dBm) + Correction Factor (dB).
2. Correction Factor (dB) = Substitution Antenna Gain (dB) + Cable Loss (dB).

Mode	TX channel 181	Frequency Range	Above 1000MHz
------	----------------	-----------------	---------------

Antenna Polarity & Test Distance: Horizontal at 3 M

No.	Freq. (MHz)	Reading (dBm)	S.G Power Value (dBm)	Correction Factor (dB)	EIRP (dBm)	Limit (dBm)	Margin (dB)
1	1250.00	-48.3	-48.1	4.1	-44.0	-25.0	-19.0
2	11810.00	-63.4	-36.5	3.1	-33.4	-25.0	-8.4

Antenna Polarity & Test Distance: Vertical at 3 M

No.	Freq. (MHz)	Reading (dBm)	S.G Power Value (dBm)	Correction Factor (dB)	EIRP (dBm)	Limit (dBm)	Margin (dB)
1	1250.00	-45.5	-45.1	4.1	-41.0	-25.0	-16.0
2	11810.00	-63.9	-37.4	3.1	-34.3	-25.0	-9.3

Remarks:

1. Output Power (dBm) = S.G Value (dBm) + Correction Factor (dB).
2. Correction Factor (dB) = Substitution Antenna Gain (dB) + Cable Loss (dB).



Channel Bandwidth 20MHz, Data Rate 54Mbps

Mode	TX channel 175	Frequency Range	Above 1000MHz
------	----------------	-----------------	---------------

Antenna Polarity & Test Distance: Horizontal at 3 M

No.	Freq. (MHz)	Reading (dBm)	S.G Power Value (dBm)	Correction Factor (dB)	EIRP (dBm)	Limit (dBm)	Margin (dB)
1	1250.00	-47.6	-47.4	4.1	-43.3	-25.0	-18.3
2	11750.00	-66.0	-39.0	3.0	-36.0	-25.0	-11.0

Antenna Polarity & Test Distance: Vertical at 3 M

No.	Freq. (MHz)	Reading (dBm)	S.G Power Value (dBm)	Correction Factor (dB)	EIRP (dBm)	Limit (dBm)	Margin (dB)
1	1250.00	-45.6	-45.2	4.1	-41.1	-25.0	-16.1
2	11750.00	-65.7	-39.7	3.0	-36.7	-25.0	-11.7

Remarks:

1. Output Power (dBm) = S.G Value (dBm) + Correction Factor (dB).
2. Correction Factor (dB) = Substitution Antenna Gain (dB) + Cable Loss (dB).

Mode	TX channel 181	Frequency Range	Above 1000MHz
------	----------------	-----------------	---------------

Antenna Polarity & Test Distance: Horizontal at 3 M

No.	Freq. (MHz)	Reading (dBm)	S.G Power Value (dBm)	Correction Factor (dB)	EIRP (dBm)	Limit (dBm)	Margin (dB)
1	1250.00	-49.5	-49.3	4.1	-45.2	-25.0	-20.2
2	11810.00	-68.0	-41.1	3.1	-38.0	-25.0	-13.0

Antenna Polarity & Test Distance: Vertical at 3 M

No.	Freq. (MHz)	Reading (dBm)	S.G Power Value (dBm)	Correction Factor (dB)	EIRP (dBm)	Limit (dBm)	Margin (dB)
1	1250.00	-45.9	-45.5	4.1	-41.4	-25.0	-16.4
2	11810.00	-66.7	-40.2	3.1	-37.1	-25.0	-12.1

Remarks:

1. Output Power (dBm) = S.G Value (dBm) + Correction Factor (dB).
2. Correction Factor (dB) = Substitution Antenna Gain (dB) + Cable Loss (dB).

5 Pictures of Test Arrangements

Please refer to the attached file (Test Setup Photo).





Appendix – Information on the Testing Laboratories

We, Bureau Veritas Consumer Products Services (H.K.) Ltd., Taoyuan Branch, were founded in 1988 to provide our best service in EMC, Radio, Telecom and Safety consultation. Our laboratories are accredited and approved according to ISO/IEC 17025.

If you have any comments, please feel free to contact us at the following:

Linko EMC/RF Lab

Tel: 886-2-26052180

Fax: 886-2-26051924

Hsin Chu EMC/RF Lab/Telecom Lab

Tel: 886-3-5935343

Fax: 886-3-5935342

Hwa Ya EMC/RF/Safety

Tel: 886-3-3183232

Fax: 886-3-3270892

Email: service.adt@tw.bureauveritas.com

Web Site: www.bureauveritas-adt.com

The address and road map of all our labs can be found in our web site also.

--- END ---