



TEST REPORT

Report Reference No...... : **TRE1504001502** **R/C**.....: **70967**
FCC ID..... : **XYH-MRM400**
IC : **8759A-MRM400**
Applicant's name..... : **RCA Communications Systems**
Address..... : 133 West Market Street Suite 227 Indianapolis IN USA
Manufacturer.....: **RCA Communications Systems**
Address.....: 133 West Market Street Suite 227 Indianapolis IN USA
Test item description : **VHF Marine Two-Way Radio**
Trade Mark: RCA
Model/Type reference.....: MRM400
Listed Model(s).....: RS-507M
Standard : **FCC Part 80/FCC Part 2/ FCC Part 15B/RSS-182/RSS-Gen**
Date of receipt of test sample.....: Apr 7, 2015
Date of testing.....: Apr 8, 2015- Apr 28, 2015
Date of issue.....: Apr 28, 2015
Result.....: **PASS**

Compiled by
 (position+printed name+signature)..: File administrators Shayne Zhu

Shayne Zhu

Supervised by
 (position+printed name+signature)..: Project Engineer Cary Luo

Cary Luo

Approved by
 (position+printed name+signature)..: RF Manager Hans Hu

Hans Hu

Testing Laboratory Name : **Shenzhen Huatongwei International Inspection Co., Ltd**
Address.....: Keji Nan No.12 Road, Hi-tech Park, Shenzhen, China

Shenzhen Huatongwei International Inspection Co., Ltd. All rights reserved.

This publication may be reproduced in whole or in part for non-commercial purposes as long as the Shenzhen Huatongwei International Inspection Co., Ltd is acknowledged as copyright owner and source of the material. Shenzhen Huatongwei International Inspection Co., Ltd takes no responsibility for and will not assume liability for damages resulting from the reader's interpretation of the reproduced material due to its placement and context.

Contents

1.	<u>TEST STANDARDS AND TEST DESCRIPTION</u>	3
1.1.	Test Standards	3
1.2.	Test Description	3
2.	<u>SUMMARY</u>	4
2.1.	Client Information	4
2.2.	Product Description	4
2.3.	EUT operation mode	5
2.4.	EUT configuration	5
2.5.	Related Submittal(s) / Grant (s)	5
2.6.	Modifications	5
3.	<u>TEST ENVIRONMENT</u>	6
3.1.	Address of the test laboratory	6
3.2.	Test Facility	6
3.3.	Environmental conditions	7
3.4.	Statement of the measurement uncertainty	7
3.5.	Equipments Used during the Test	8
4.	<u>TEST CONDITIONS AND RESULTS</u>	10
4.1.	Conducted Emissions Test	10
4.2.	Maximum Transmitter Power	12
4.3.	Occupied Bandwidth	16
4.4.	Emission Mask	20
4.5.	Modulation Characteristics	24
4.6.	Frequency Stability Test	28
4.7.	Spurious Emission on Antenna Port	30
4.8.	Transmitter Radiated Spurious Emission	34
4.9.	Receiver Radiated Spurious Emission	40
4.10.	Receiver Conducted Spurious Emission	50
5.	<u>TEST SETUP PHOTOS OF THE EUT</u>	51
6.	<u>EXTERNAL AND INTERNAL PHOTOS OF THE EUT</u>	52
	<u>INTERNAL PHOTOS OF THE EUT</u>	53

1. TEST STANDARDS AND TEST DESCRIPTION

1.1. Test Standards

The tests were performed according to following standards:

[FCC Rules Part 80 :2014](#) Stations In The Maritime Services.

[TIA/EIA 603 D:June 2010](#) Land Mobile FM or PM Communications Equipment Measurement and Performance Standards.

[FCC Part 15 Subpart B:2014](#) Unintentional Radiators.

[FCC Part 2: 2014](#) Frequency allocations and radio treaty matters, general rules and regulations.

[RSS-182 Issue 5 January 2012:](#) Maritime Radio Transmitters and Receivers in the Band 156-162.5 MHz

[RSS-Gen Issue 4, November 2014:](#) General Requirements and Information for the Certification of Radio Apparatus

1.2. Test Description

Test specification clause	Test case	Verdict
FCC Part 15.207/RSS-Gen	Conducted Emission	N/A
FCC Part 80.215/RSS-182 § 5.2	Maximum Transmitter Power	PASS
FCC Part 80.213/RSS-182 § 7.8	Modulation Characteristic	PASS
FCC Part 80.205/RSS-182 § 3.1	Occupied Bandwidth	PASS
FCC Part 80.211(f)	Emission Mask	PASS
FCC Part 80.209/RSS-182 § 5.1	Frequency Stability	PASS
FCC Part 80. 211(f)(3)/RSS-182 § 7.9	Transmitter Radiated Spurious Emssion	PASS
FCC Part 80. 211(f)(3)/RSS-182 § 7.9	Spurious Emssion On Antenna Port	PASS
RSS-182 § 7.11/ RSS-Gen	Receiver Radiated Spurious Emssion	PASS
RSS-182 § 7.11/ RSS-Gen	Receiver Conducted Spurious Emission	N/A

Remark:

- 1.The measurement uncertainty is not included in the test result.
- 2.RSS-182 clause 6.1 User Manual: Reference to the Cobra Marine Owner's Manual Product Features
- 3.RSS-182 clause 7.1 Frequency Plan and Channel Spacing: Reference to User manual VHF Marine Channel Assignments.
- 4.RSS-182 clause 7.2 Required Operating Frequencies: Reference to User manual VHF Marine Channel Assignments.
- 5.RSS-182 clause 7.3 Types of Modulation and Equipment Characteristics Specifications: Reference to User manual Specification.
- 6.RSS-182 clause 7.6 Transport Canada Specifications: Reference to Type D DSC EN 301 025 test report No.: TRE1504001501
- 7.RSS-182 clause 7.7 VHF AIS Transponders: Reference to User manual Specification.

2. SUMMARY

2.1. Client Information

Applicant:	RCA Communications Systems
Address:	133 West Market Street Suite 227 Indianapolis IN USA
Manufacturer:	RCA Communications Systems
Address:	133 West Market Street Suite 227 Indianapolis IN USA

2.2. Product Description

Name of EUT	VHF Marine Two-Way Radio	
Trade Mark:	RCA	
Model/Type reference:	MRM400	
Listed Model(s):	RS-507M	
Power supply:	DC 13.80V	
Charger information:	/	
Battery information:	/	
Adapter information:	/	
Operation Frequency Range:	From 156.05MHz to 157.425MHz	
Rated Output Power:	High Power:25 Watts(43.98dBm)/Low Power:1 Watts(30.00dBm)	
Modulation Type:	FM for Analog Voice	
	FSK for Digital Data	
Channel Separation:	Analog Voice	25kHz
	Digital Data	25kHz
Antenna Type:	External	
Hard version:	6PD7-2008BMB	
Soft version:	M-2008BM-B0923	

Note: The product has the same digital working characters when operating in both two digitized voice/data mode. So only one set of test results for digital modulation modes are provided in this test report.

Test frequency list

Modulation Type	Channel Separation	Test Frequency (MHz)
Analog/FM	25kHz	156.05(CH1)
		156.8(CH16)
		157.425(CH88)

Note:

In section 15.31(m), regards to the operating frequency range over 10 MHz, the Lowest frequency, the middle frequency, and the highest frequency of channel were selected to perform the test, please see the above listed frequency for testing.

2.3. EUT operation mode

The EUT has been tested under typical operating condition and The Transmitter was operated in the normal operating mode. The TX frequency was fixed which was for the purpose of the measurements.

EUT operation mode no.	Description of operation mode	Additional information
Op 1	FM+BW25kHz+TX	The equipment is set with FM modulation and 25kHz bandwidth at maximum rated power for transmitter, powered by DC 13.80V
Op 2	FM+BW25kHz+TX	The equipment is set with FM modulation and 25kHz bandwidth at minimum rated power for transmitter, powered by DC 13.80V
Op 3	FM+BW25kHz+RX	The equipment is set with FM modulation and 25kHz bandwidth at receiver or standby, powered by DC 13.80V
Op 4	GPS	Gps Receiver Mode, powered by DC 13.80V

2.4. EUT configuration

The following peripheral devices and interface cables were connected during the measurement:

- - supplied by the manufacturer
- - supplied by the lab

●	Power Cable	Length (m) :	3.00
		Shield :	Unshielded
		Detachable :	Undetachable
○	Multimeter	Manufacturer :	/
		Model No. :	/

2.5. Related Submittal(s) / Grant (s)

This submittal(s) (test report) is intended for FCC ID: XYH-MRM400 filing to comply with FCC Part 80 rules.

This submittal(s) (test report) is intended for IC: 8759A-MRM400 filing to comply with RSS-182 rules.

2.6. Modifications

No modifications were implemented to meet testing criteria.

3 . TEST ENVIRONMENT

3.1. Address of the test laboratory

Laboratory: Shenzhen Huatongwei International Inspection Co., Ltd.
Address: Keji Nan No.12 Road, Hi-tech Park, Shenzhen, China
Phone: 86-755-26748019 Fax: 86-755-26748089

3.2. Test Facility

The test facility is recognized, certified, or accredited by the following organizations:

CNAS-Lab Code: L1225

Shenzhen Huatongwei International Inspection Co., Ltd. has been assessed and proved to be in compliance with CNAS-CL01 Accreditation Criteria for Testing and Calibration Laboratories (identical to ISO/IEC 17025: 2005 General Requirements) for the Competence of Testing and Calibration Laboratories, Date of Registration: Feb. 28, 2015. Valid time is until February 27, 2018.

A2LA-Lab Cert. No. 2243.01

Shenzhen Huatongwei International Inspection Co., Ltd. EMC Laboratory has been accredited by A2LA for technical competence in the field of electrical testing, and proved to be in compliance with ISO/IEC 17025: 2005 General Requirements for the Competence of Testing and Calibration Laboratories and any additional program requirements in the identified field of testing. Valid time is until Sept 30, 2015.

FCC-Registration No.: 662850

Shenzhen Huatongwei International Inspection Co., Ltd. EMC Laboratory has been registered and fully described in a report filed with the FCC (Federal Communications Commission). The acceptance letter from the FCC is maintained in our files. Registration 662850, Renewal date Jul. 01, 2012, valid time is until Jun. 01, 2015.

FCC-Registration No.: 317478

Shenzhen Huatongwei International Inspection Co., Ltd. (Gongming EMC Laboratory) has been registered and fully described in a report filed with the FCC (Federal Communications Commission). The acceptance letter from the FCC is maintained in our files. Registration 317478, Renewal date July 18, 2014, valid time is until July. 18, 2017.

IC-Registration No.: 5377A

The 3m Alternate Test Site of Shenzhen Huatongwei International Inspection Co., Ltd. has been registered by Certification and Engineering Bureau of Industry Canada for the performance of radiated measurements with Registration No. 5377A on Dec. 31, 2013, valid time is until Dec. 31, 2016.

IC-Registration No.: 5377B

The 3m Alternate Test Site of Shenzhen Huatongwei International Inspection Co., Ltd. (Gongming EMC Laboratory) has been registered by Certification and Engineering Bureau of Industry Canada for the performance of radiated measurements with Registration No. 5377B on September 3, 2014, valid time is until September 3, 2017.

ACA

Shenzhen Huatongwei International Inspection Co., Ltd. EMC Laboratory can also perform testing for the Australian C-Tick mark as a result of our A2LA accreditation.

VCCI

The 3m Semi-anechoic chamber (12.2m×7.95m×6.7m) of Shenzhen Huatongwei International Inspection Co., Ltd. has been registered in accordance with the Regulations for Voluntary Control Measures with Registration No.:R-2484. Date of Registration: Dec. 20, 2012. Valid time is until Dec. 29, 2015.

Radiated disturbance above 1GHz measurement of Shenzhen Huatongwei International Inspection Co., Ltd. has been registered in accordance with the Regulations for Voluntary Control Measures with Registration No.: G-292. Date of Registration: Dec. 24, 2013. Valid time is until Dec. 23, 2016.

Main Ports Conducted Interference Measurement of Shenzhen Huatongwei International Inspection Co., Ltd. has been registered in accordance with the Regulations for Voluntary Control Measures with Registration No.: C-2726. Date of Registration: Dec. 20, 2012. Valid time is until Dec. 19, 2015.

Telecommunication Ports Conducted Interference Measurement of Shenzhen Huatongwei International Inspection Co., Ltd. has been registered in accordance with the Regulations for Voluntary Control Measures with Registration No.: T-1837. Date of Registration: May 07, 2013. Valid time is until May 06, 2016.

DNV

Shenzhen Huatongwei International Inspection Co., Ltd. has been found to comply with the requirements of DNV towards subcontractor of EMC and safety testing services in conjunction with the EMC and Low voltage Directives and in the voluntary field. The acceptance is based on a formal quality Audit and follow-ups according to relevant parts of ISO/IEC Guide 17025 (2005), in accordance with the requirements of the DNV Laboratory Quality Manual towards subcontractors. Valid time is until Aug. 24, 2016.

3.3. Environmental conditions

During the measurement the environmental conditions were within the listed ranges:

Temperature:	15~35°C
Relative Humidity:	30~60 %
Air Pressure:	950~1050mba

3.4. Statement of the measurement uncertainty

The data and results referenced in this document are true and accurate. The reader is cautioned that there may be errors within the calibration limits of the equipment and facilities. The measurement uncertainty was calculated for all measurements listed in this test report acc. to CISPR 16 - 4 „Specification for radio disturbance and immunity measuring apparatus and methods – Part 4: Uncertainty in EMC Measurements“ and is documented in the Shenzhen Huatongwei International Inspection Co., Ltd quality system acc. to DIN EN ISO/IEC 17025. Furthermore, component and process variability of devices similar to that tested may result in additional deviation. The manufacturer has the sole responsibility of continued compliance of the device.

Hereafter the best measurement capability for Shenzhen Huatongwei laboratory is reported:

Test Items	Measurement Uncertainty	Notes
Frequency stability	25 Hz	(1)
Transmitter power conducted	0.57 dB	(1)
Transmitter power Radiated	2.20 dB	(1)
Conducted spurious emission 9KHz-40 GHz	1.60 dB	(1)
Conducted Emission 9KHz-30MHz	3.39 dB	(1)
Radiated Emission 30~1000MHz	4.65 dB	(1)
Radiated Emission 1~18GHz	5.16 dB	(1)
Radiated Emission 18-40GHz	5.54 dB	(1)
Occupied Bandwidth	-----	(1)
Emission Mask	-----	(1)
Modulation Characteristic	-----	(1)

(1) This uncertainty represents an expanded uncertainty expressed at approximately the 95% confidence level using a coverage factor of $k=1.96$.

3.5. Equipments Used during the Test

AC&DC Power Conducted Emission				
Name of Equipment	Manufacturer	Model	Serial Number	Last Cal.
Artificial Mains	Rohde&Schwarz	ESH2-Z5	100028	2014/11/1
EMI Test Receiver	Rohde&Schwarz	ESCS 30	100038	2014/11/1
Pulse Limiter	Rohde&Schwarz	ESHSZ2	100044	2014/11/1
EMI Test Software	Rohde&Schwarz	ES-K1 V1.71	N/A	N/A
RF COMMUNICATION TEST SET	HP	8920A	3813A10206	2014/11/1

Modulation Characteristic				
Name of Equipment	Manufacturer	Model	Serial Number	Last Cal.
RF COMMUNICATION TEST SET	HP	8920A	3813A10206	2014/11/1

Frequency Stability				
Name of Equipment	Manufacturer	Model	Serial Number	Last Cal.
RF COMMUNICATION TEST SET	HP	8920A	3813A10206	2014/11/1
Signal Generator	Rohde&Schwarz	SMT03	100059	2014/11/1
Climate Chamber	ESPEC	EL-10KA	05107008	2014/11/1

Transmitter Radiated Spurious Emission				
Name of Equipment	Manufacturer	Model	Serial Number	Last Cal.
Ultra-Broadband Antenna	Rohde&Schwarz	HL562	100015	2014/11/1
EMI Test Receiver	Rohde&Schwarz	ESI 26	100009	2014/11/1
RF Test Panel	Rohde&Schwarz	TS / RSP	335015/ 0017	N/A
HORN ANTENNA	Rohde&Schwarz	HF906	100039	2014/11/1
Turntable	ETS	2088	2149	N/A
Antenna Mast	ETS	2075	2346	N/A
EMI Test Software	Rohde&Schwarz	ES-K1 V1.71	N/A	N/A
RF COMMUNICATION TEST SET	HP	8920A	3813A10206	2014/11/1
Ultra-Broadband Antenna	ShwarzBeck	VULB9163	538	2014/11/1
Ultra-Broadband Antenna	ShwarzBeck	VULB9163	539	2014/11/1
HORN ANTENNA	ShwarzBeck	9120D	1012	2014/11/1
HORN ANTENNA	ShwarzBeck	9120D	1011	2014/11/1
TURNTABLE	MATURO	TT2.0	----	N/A
ANTENNA MAST	MATURO	TAM-4.0-P	----	N/A

Maximum Transmitter Power & Spurious Emission On Antenna Port & Occupied Bandwidth & Emission Mask				
Name of Equipment	Manufacturer	Model	Serial Number	Last Cal.
Receiver	Rohde&Schwarz	ESI 26	100009	2014/11/1
Attenuator	R&S	ESH3-22	100449	2014/11/1
RF COMMUNICATION TEST SET	HP	8920A	3813A10206	2014/11/1
High-Pass Filter	Anritsu	MP526B	6220875256	2014/11/1
High-Pass Filter	Anritsu	MP526D	6220878392	2014/11/1
Spectrum Analyzer	Agilent	E4407B	MY44210775	2014/11/1
Spectrum Analyzer	Rohde&Schwarz	FSP40	1164.4391.40	2014/11/1
SPECTRUM ANALYZER	Agilent	E4407B	MY44210775	2014/11/1

Transient Frequency Behavior				
Name of Equipment	Manufacturer	Model	Serial Number	Last Cal.
Signal Generator	Rohde&Schwarz	SMT03	100059	2014/11/1
Storage Oscilloscope	Tektronix	TDS3054B	B033027	2014/11/1
RF COMMUNICATION TEST SET	HP	8920A	3813A10206	2014/11/1

The calibration interval was one year.

4. TEST CONDITIONS AND RESULTS

4.1. Conducted Emissions Test

TEST APPLICABLE

The EUT was tested according to ANSI C63.4 - 2009. The frequency spectrum from 0.15 MHz to 30 MHz was investigated. The LISN used was 50 ohm / 50 u Henry as specified by section 5.1 of ANSI C63.4 - 2009. Cables and peripherals were moved to find the maximum emission levels for each frequency.

TEST CONFIGURATION

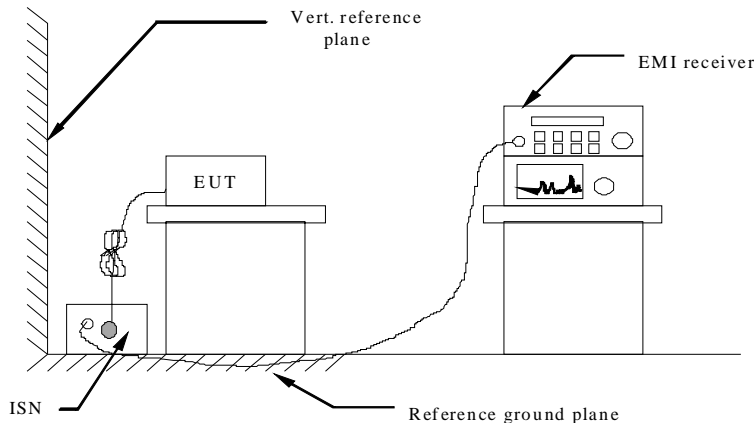

TEST PROCEDURE

- 1 The equipment was set up as per the test configuration to simulate typical actual usage per the user's manual. The EUT is a tabletop system; a wooden table with a height of 0.8 meters is used and is placed on the ground plane as per ANSI C63.4-2009.
- 2 Support equipment, if needed, was placed as per ANSI C63.4-2009.
- 3 All I/O cables were positioned to simulate typical actual usage as per ANSI C63.4-2009.
- 4 If a EUT received AC120V/60Hz power through a Line Impedance Stabilization Network (LISN) which supplied power source and was grounded to the ground plane.
- 5 If a EUT received DC 13.80V power through a Impedance Stabilization Network (ISN) which supplied power source and was grounded to the ground plane.
- 6 All support equipments received AC power from a second LISN, if any.
- 7 The EUT test program was started. Emissions were measured on each current carrying line of the EUT using a spectrum Analyzer / Receiver connected to the LISN powering the EUT. The LISN has two monitoring points: Line 1 (Hot Side) and Line 2 (Neutral Side). Two scans were taken: one with Line 1 connected to Analyzer / Receiver and Line 2 connected to a 50 ohm load; the second scan had Line 1 connected to a 50 ohm load and Line 2 connected to the Analyzer / Receiver.
- 8 Analyzer / Receiver scanned from 150 kHz to 30MHz for emissions in each of the test modes.
- 9 During the above scans, the emissions were maximized by cable manipulation.

Conducted Power Line Emission Limit

For intentional device, according to § 15.207(a) and RSS-Gen for Conducted Emission Limits is as following:

Frequency of Emission (MHz)	Conducted Limit (dBµV)	
	Quasi-peak	Average
0.15-0.5	66 to 56 *	56 to 46 *
0.5-5	56	46
5-30	60	50

* Decreasing linearly with the logarithm of the frequency

For intentional device, according to §15.207(a) and RSS-Gen Line Conducted Emission Limit is same as above table.

TEST RESULTS

Not applicable to this device (because the equipment is powered by the battery, without AC mains power input ports)

4.2. Maximum Transmitter Power

TEST APPLICABLE

Per FCC Part 2.1046 and Part 90.205: Maximum ERP is dependent upon the station’s antenna HAAT and required service area.

Per RSS-119 Section 5.4 and 5.4.1: The output power shall be within ±1.0 dB of the manufacturer’s rated power. Typical transmitter output powers are 110 watts for base and/or fixed stations (paging transmitters excepted), and 30 watts for mobile stations. Higher powers may be certified, but it should be noted that mobile stations are normally only licensed up to 30 watts. See the SRSP relevant to the operating frequency for equipment power limits.

FCC Part 2.1046 and 80.215(e)(1) Ship stations 156–162 MHz - 25W^{1,2}

Marine utility stations and hand-held portable transmitters: 156–162 MHz -10W , the output power shall be within ±1.0 dB of the manufacturer’s rated power.

1 Reducible to 1 watt or less, except for transmitters limited to public correspondence channels and used in an automated system.

2 The frequencies 156.775 and 156.825 MHz are available for navigation-related port operations or ship movement only, and all precautions must be taken to avoid harmful interference to channel 16. Transmitter output power is limited to 1 watt for ship stations, and 10 watts for coast stations.

FCC Part 2.1046 and 80.215(e)(1) Marine utility stations and hand-held portable transmitters: 156-162 MHz-10W, the output power shall be within ±1.0 dB of the manufacturer’s rated power.

RSS-182 Section 7.5 Ship station transmitters shall have power control features implemented to reduce the carrier power to one watt or less for use at short ranges, except for DSC equipment operating on the 156.525 MHz (channel 70) frequency, for which the power reduction facility is optional. The output power shall be within ±1.0 dB of the manufacturer’s rated power and not exceed the limits listed in Table 3, unless indicated otherwise.

Table 3 lists typical transmitter output powers for equipment certified under this standard.

Stations	Typical Power
Coast stations	50 W
Ship stations Minimum: Maximum:	6 W 25 W
Hand-held portable transmitters	5 W
Survival two-way radiotelephones	Should have a minimum e.i.r.p. of 0.25 watt

TEST PROCEDURE

Measurements shall be made to establish the radio frequency power delivered by the transmitter the standard output termination. The power output shall be monitored and recorded and no adjustment shall be made to the transmitter after the test has begun, except as noted below:

If the power output is adjustable, measurements shall be made for the highest and lowest power levels.

The EUT connect to the Receiver through 20 dB attenuator.

Measurement with Spectrum Analyzer E4407B conducted, external power supply with 13.80 V stabilized supply voltage.

TEST CONFIGURATION

EUT		Attenuator		Spectrum Analyzer/Receiver
-----	--	------------	--	----------------------------

The EUT was directly connected to a RF Communication Test set by a 20 dB attenuator

TEST RESULTS

Operation Mode	Test Frequency (MHz)	Measured power (dBm)	Difference (dB)	Limit (dB)	Result
Op 1	156.05	44.06	0.08	-1 ~ +1	Pass
	156.8	44.08	0.1		
	157.425	44.08	0.1		
Op 2	156.05	30.26	0.26	-1 ~ +1	Pass
	156.8	30.31	0.31		
	157.425	30.34	0.34		

Test plot as follows:

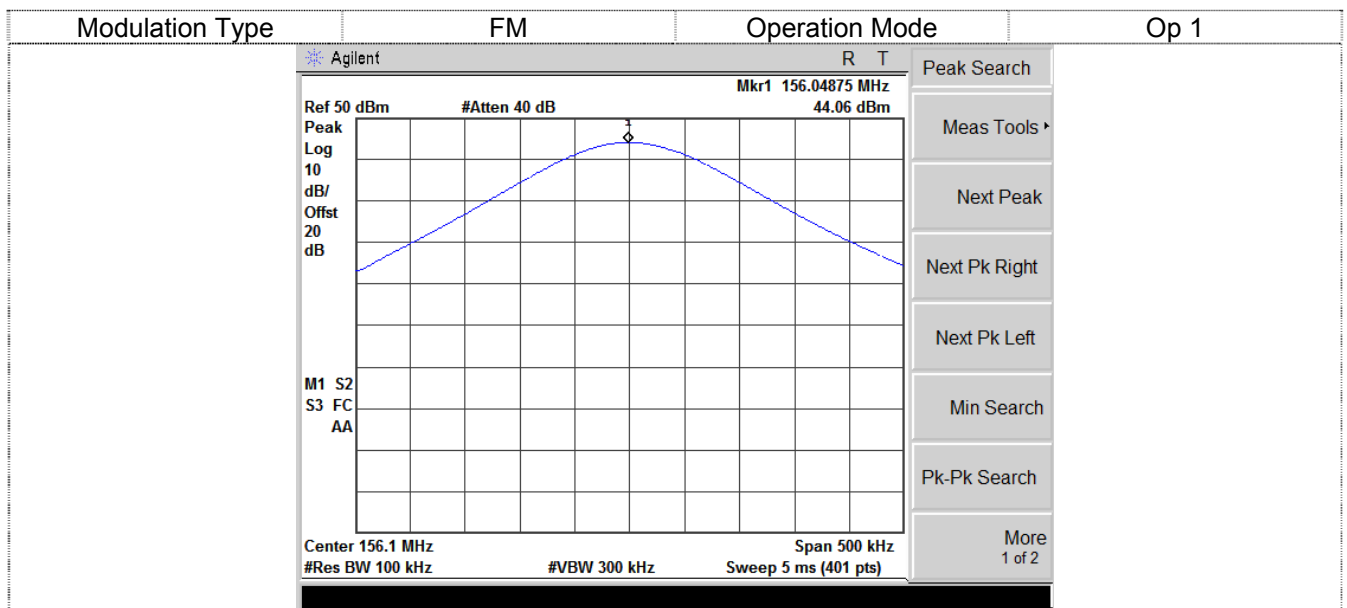

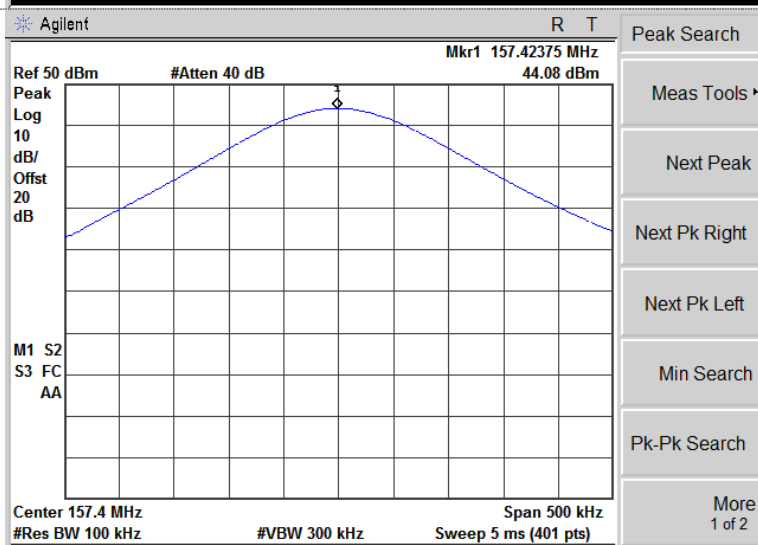
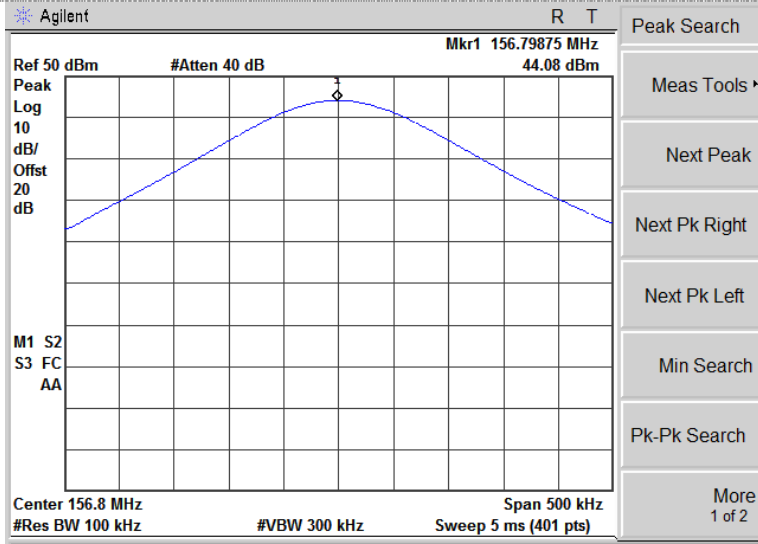

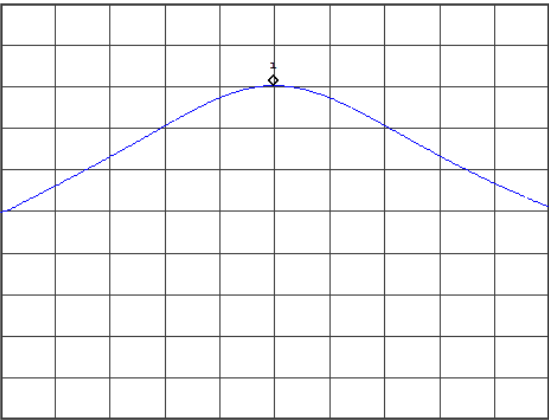
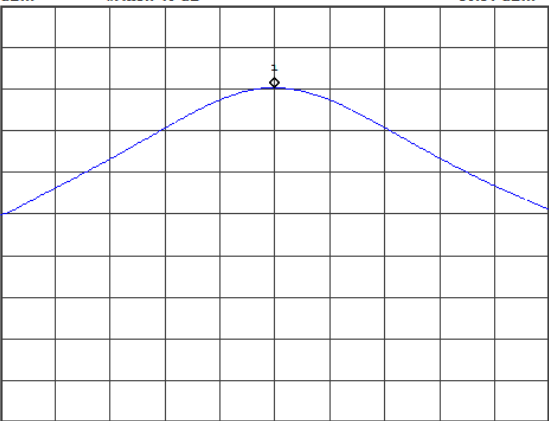
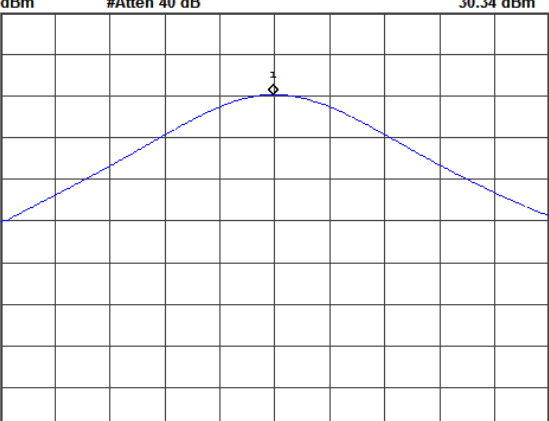
Modulation Type	FM	Operation Mode	Op 2
<p>Agilent R T</p> <p>Ref 50 dBm #Atten 40 dB Mkr1 156.04875 MHz 30.26 dBm</p>  <p>M1 S2 S3 FC AA</p> <p>Center 156.1 MHz Span 500 kHz #Res BW 100 kHz #VBW 300 kHz Sweep 5 ms (401 pts)</p>			<p>Peak Search</p> <p>Meas Tools ▾</p> <p>Next Peak</p> <p>Next Pk Right</p> <p>Next Pk Left</p> <p>Min Search</p> <p>Pk-Pk Search</p> <p>More 1 of 2</p>
<p>Agilent R T</p> <p>Ref 50 dBm #Atten 40 dB Mkr1 156.80000 MHz 30.31 dBm</p>  <p>M1 S2 S3 FC AA</p> <p>Center 156.8 MHz Span 500 kHz #Res BW 100 kHz #VBW 300 kHz Sweep 5 ms (401 pts)</p>			<p>Peak Search</p> <p>Meas Tools ▾</p> <p>Next Peak</p> <p>Next Pk Right</p> <p>Next Pk Left</p> <p>Min Search</p> <p>Pk-Pk Search</p> <p>More 1 of 2</p>
<p>Agilent R T</p> <p>Ref 50 dBm #Atten 40 dB Mkr1 157.42375 MHz 30.34 dBm</p>  <p>M1 S2 S3 FC AA</p> <p>Center 157.4 MHz Span 500 kHz #Res BW 100 kHz #VBW 300 kHz Sweep 5 ms (401 pts)</p>			<p>Peak Search</p> <p>Meas Tools ▾</p> <p>Next Peak</p> <p>Next Pk Right</p> <p>Next Pk Left</p> <p>Min Search</p> <p>Pk-Pk Search</p> <p>More 1 of 2</p>

4.3. Occupied Bandwidth

TEST APPLICABLE

Occupied Bandwidth: The EUT was connected to the audio signal generator and the spectrum analyzer via the main RF connector, and through an appropriate attenuator. The EUT was controlled to transmit its maximum power. Then the bandwidth of 99% power can be measured by the spectrum analyzer.

TEST CONFIGURATION

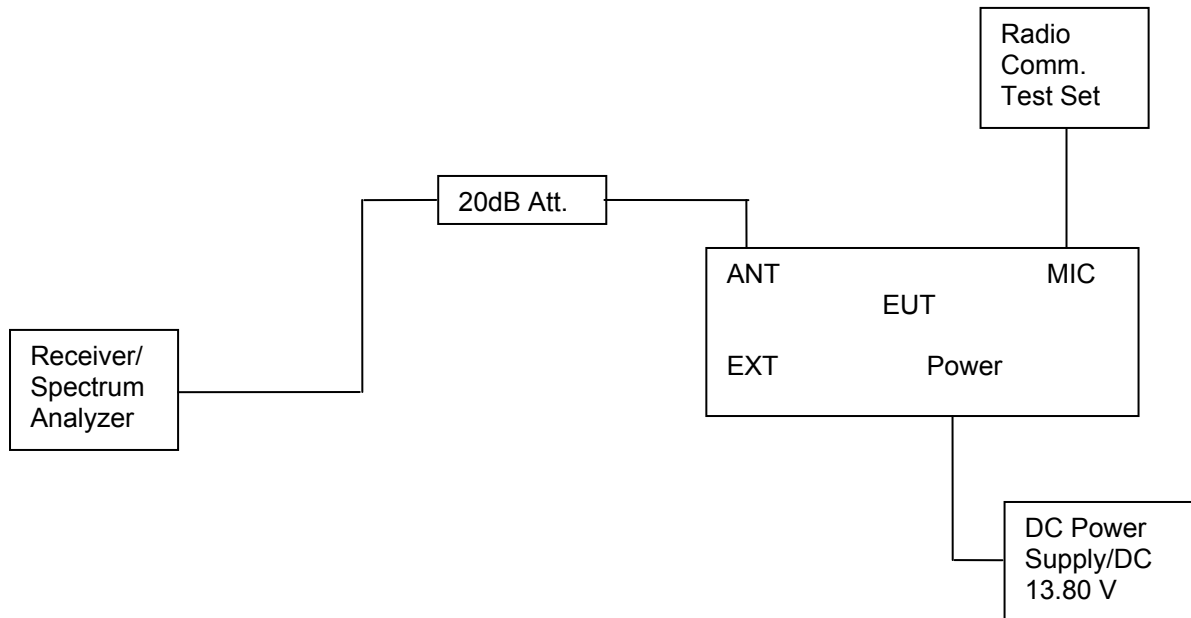

TEST PROCEDURE

- 1 The EUT was modulated by 2.5kHz Sine wave audio signal; the level of the audio signal employed is 16 dB greater than that necessary to produce 50% of rated system deviation. Rated system deviation is 2.5 kHz (12.5kHz channel spacing) and 5 kHz (25 kHz channel spacing).
- 2 Set EUT as normal operation.
 - 1)Set SPA Center Frequency = fundamental frequency, RBW=100Hz, VBW=300Hz,span=50kHz for 12.5KHz channel spacing.
 - 2)Set SPA Center Frequency = fundamental frequency, RBW=300Hz, VBW=1kHz,span=50kHz for 25kHz channel spacing.
- 3 Set SPA Max hold. Mark peak, Set 99% Occupied Bandwidth and 26dB Occupied Bandwidth.
- 4 Set SPA Center Frequency=fundamental frequency, set =100Hz, VBW=300Hz, span=50kHz for 12.5KHz channel spacing.
Set SPA Center Frequency=fundamental frequency, set =300Hz,VBW=1kHz,span=50kHz for 25kHz channel spacing.

TEST RESULTS

Remark:We tested and reocrded Op 1 to Op 2.

Operation Mode	Test Frequency (MHz)	Occupied Bandwidth (kHz)		Limit (kHz)	Result
		99%	26dB		
Op 1	156.05	14.65	15.58	≤20.0	Pass
	156.8	14.60	15.59		
	157.425	14.54	15.56		
Op 2	156.05	14.62	15.56	≤20.0	Pass
	156.8	14.61	15.56		
	157.425	14.56	15.55		

Test plot as follows:

Modulation Type	FM	Operation Mode	Op 1
<p>Agilent R T</p> <p>Ch Freq 156.05 MHz Trig Free</p> <p>Occupied Bandwidth</p> <p>Center 156.050000 MHz</p> <p>Ref 50 dBm #Atten 40 dB</p> <p>#Peak Log 10 dB/ Offst 20 dB</p> <p>Center 156.1 MHz Span 60 kHz</p> <p>#Res BW 300 Hz #VBW 1 kHz Sweep 2.688 s (401 pts)</p> <p>Occupied Bandwidth 14.6458 kHz</p> <p>Occ BW % Pwr 99.00 % x dB -26.00 dB</p> <p>Transmit Freq Error -303.251 Hz</p> <p>x dB Bandwidth 15.577 kHz</p>			<p>Freq/Channel</p> <p>Center Freq 156.050000 MHz</p> <p>Start Freq 156.020000 MHz</p> <p>Stop Freq 156.080000 MHz</p> <p>CF Step 6.00000000 kHz Auto Man</p> <p>Freq Offset 0.00000000 Hz</p> <p>Signal Track On Off</p> <p>Scale Type Log Lin</p>
<p>Agilent R T</p> <p>Ch Freq 156.8 MHz Trig Free</p> <p>Occupied Bandwidth</p> <p>Center 156.8 MHz</p> <p>Ref 50 dBm #Atten 40 dB</p> <p>#Peak Log 10 dB/ Offst 20 dB</p> <p>Center 156.8 MHz Span 60 kHz</p> <p>#Res BW 300 Hz #VBW 1 kHz Sweep 2.688 s (401 pts)</p> <p>Occupied Bandwidth 14.6034 kHz</p> <p>Occ BW % Pwr 99.00 % x dB -26.00 dB</p> <p>Transmit Freq Error -325.043 Hz</p> <p>x dB Bandwidth 15.590 kHz</p>			<p>Trace/View</p> <p>Trace 1 2 3</p> <p>Clear Write</p> <p>Max Hold</p> <p>Min Hold</p> <p>View</p> <p>Blank</p> <p>More 1 of 2</p>
<p>Agilent R T</p> <p>Ch Freq 157.425 MHz Trig Free</p> <p>Occupied Bandwidth</p> <p>Center 157.4 MHz</p> <p>Ref 50 dBm #Atten 40 dB</p> <p>#Peak Log 10 dB/ Offst 20 dB</p> <p>Center 157.4 MHz Span 60 kHz</p> <p>#Res BW 300 Hz #VBW 1 kHz Sweep 2.688 s (401 pts)</p> <p>Occupied Bandwidth 14.5351 kHz</p> <p>Occ BW % Pwr 99.00 % x dB -26.00 dB</p> <p>Transmit Freq Error -321.398 Hz</p> <p>x dB Bandwidth 15.559 kHz</p>			<p>Freq/Channel</p> <p>Center Freq 157.425000 MHz</p> <p>Start Freq 157.395000 MHz</p> <p>Stop Freq 157.455000 MHz</p> <p>CF Step 6.00000000 kHz Auto Man</p> <p>Freq Offset 0.00000000 Hz</p> <p>Signal Track On Off</p> <p>Scale Type Log Lin</p>

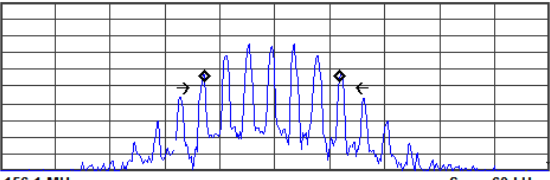
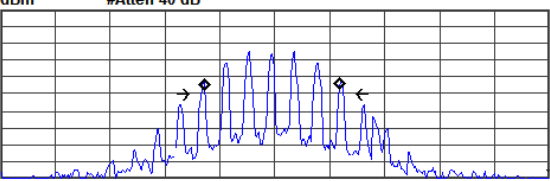
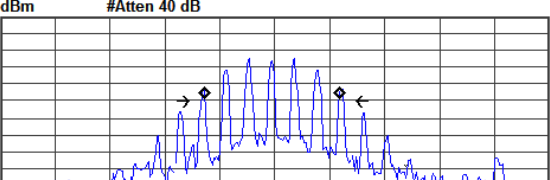
Modulation Type	FM	Operation Mode	Op 2												
<p>Agilent R T</p> <p>Ch Freq 156.05 MHz Trig Free</p> <p>Occupied Bandwidth</p> <hr/> <p>Ref 50 dBm #Atten 40 dB</p>  <p>Center 156.1 MHz Span 60 kHz #Res BW 300 Hz #VBW 1 kHz Sweep 2.688 s (401 pts)</p> <table border="1" data-bbox="448 616 1059 741"> <tr> <td>Occupied Bandwidth</td> <td>Occ BW % Pwr</td> <td>99.00 %</td> </tr> <tr> <td>14.6186 kHz</td> <td>x dB</td> <td>-26.00 dB</td> </tr> <tr> <td>Transmit Freq Error</td> <td>-297.002 Hz</td> <td></td> </tr> <tr> <td>x dB Bandwidth</td> <td>15.557 kHz</td> <td></td> </tr> </table>			Occupied Bandwidth	Occ BW % Pwr	99.00 %	14.6186 kHz	x dB	-26.00 dB	Transmit Freq Error	-297.002 Hz		x dB Bandwidth	15.557 kHz		<p>Trace/View</p> <p>Trace 1 2 3</p> <p>Clear Write</p> <p>Max Hold</p> <p>Min Hold</p> <p>View</p> <p>Blank</p> <p>More 1 of 2</p>
Occupied Bandwidth	Occ BW % Pwr	99.00 %													
14.6186 kHz	x dB	-26.00 dB													
Transmit Freq Error	-297.002 Hz														
x dB Bandwidth	15.557 kHz														
<p>Agilent R T</p> <p>Ch Freq 156.8 MHz Trig Free</p> <p>Occupied Bandwidth</p> <p>Span 60.00000000 kHz</p> <hr/> <p>Ref 50 dBm #Atten 40 dB</p>  <p>Center 156.8 MHz Span 60 kHz #Res BW 300 Hz #VBW 1 kHz Sweep 2.688 s (401 pts)</p> <table border="1" data-bbox="448 1176 1059 1303"> <tr> <td>Occupied Bandwidth</td> <td>Occ BW % Pwr</td> <td>99.00 %</td> </tr> <tr> <td>14.6061 kHz</td> <td>x dB</td> <td>-26.00 dB</td> </tr> <tr> <td>Transmit Freq Error</td> <td>-295.851 Hz</td> <td></td> </tr> <tr> <td>x dB Bandwidth</td> <td>15.557 kHz</td> <td></td> </tr> </table>			Occupied Bandwidth	Occ BW % Pwr	99.00 %	14.6061 kHz	x dB	-26.00 dB	Transmit Freq Error	-295.851 Hz		x dB Bandwidth	15.557 kHz		<p>Trace/View</p> <p>Trace 1 2 3</p> <p>Clear Write</p> <p>Max Hold</p> <p>Min Hold</p> <p>View</p> <p>Blank</p> <p>More 1 of 2</p>
Occupied Bandwidth	Occ BW % Pwr	99.00 %													
14.6061 kHz	x dB	-26.00 dB													
Transmit Freq Error	-295.851 Hz														
x dB Bandwidth	15.557 kHz														
<p>Agilent R T</p> <p>Ch Freq 157.425 MHz Trig Free</p> <p>Occupied Bandwidth</p> <hr/> <p>Ref 50 dBm #Atten 40 dB</p>  <p>Center 157.4 MHz Span 60 kHz #Res BW 300 Hz #VBW 1 kHz Sweep 2.688 s (401 pts)</p> <table border="1" data-bbox="448 1736 1059 1865"> <tr> <td>Occupied Bandwidth</td> <td>Occ BW % Pwr</td> <td>99.00 %</td> </tr> <tr> <td>14.5635 kHz</td> <td>x dB</td> <td>-26.00 dB</td> </tr> <tr> <td>Transmit Freq Error</td> <td>-302.644 Hz</td> <td></td> </tr> <tr> <td>x dB Bandwidth</td> <td>15.548 kHz</td> <td></td> </tr> </table>			Occupied Bandwidth	Occ BW % Pwr	99.00 %	14.5635 kHz	x dB	-26.00 dB	Transmit Freq Error	-302.644 Hz		x dB Bandwidth	15.548 kHz		<p>Trace/View</p> <p>Trace 1 2 3</p> <p>Clear Write</p> <p>Max Hold</p> <p>Min Hold</p> <p>View</p> <p>Blank</p> <p>More 1 of 2</p>
Occupied Bandwidth	Occ BW % Pwr	99.00 %													
14.5635 kHz	x dB	-26.00 dB													
Transmit Freq Error	-302.644 Hz														
x dB Bandwidth	15.548 kHz														

4.4. Emission Mask

TEST APPLICABLE

According to §80.211

- (a). Emission Mask B: For transmitters that are equipped with an audio low-pass filter pursuant to §80.211(f), the power of any emission must be below the unmodulated carrier power (P) as follows:
 - (1) On any frequency removed from the assigned frequency by more than 50 percent, but not more than 100 percent of the authorized bandwidth: At least 25 dB.
 - (2) On any frequency removed from the assigned frequency by more than 100 percent, but not more than 250 percent of the authorized bandwidth: At least 35 dB.
 - (3) On any frequency removed from the assigned frequency by more than 250 percent of the authorized bandwidth: At least $43 + 10 \log (P)$ dB.
- (b). Emission Mask D: 12.5 kHz channel bandwidth equipment: For transmitters designed to operate with a 12.5 kHz channel bandwidth, any emission must be attenuated below the power (P) of the highest emission contained within the authorized bandwidth as follows:
 - (1) On any frequency from the center of the authorized bandwidth f_0 to 5.625 kHz removed from f_0 : Zero dB.
 - (2) On any frequency removed from the center of the authorized bandwidth by a displacement frequency (f_d in kHz) of more than 5.625 kHz but no more than 12.5 kHz: At least $7.27(f_d - 2.88 \text{ kHz})$ dB.
 - (3) On any frequency removed from the center of the authorized bandwidth by a displacement frequency (f_d in kHz) of more than 12.5 kHz: At least $50 + 10 \log (P)$ dB or 70 dB, whichever is the lesser attenuation.

TEST CONFIGURATION

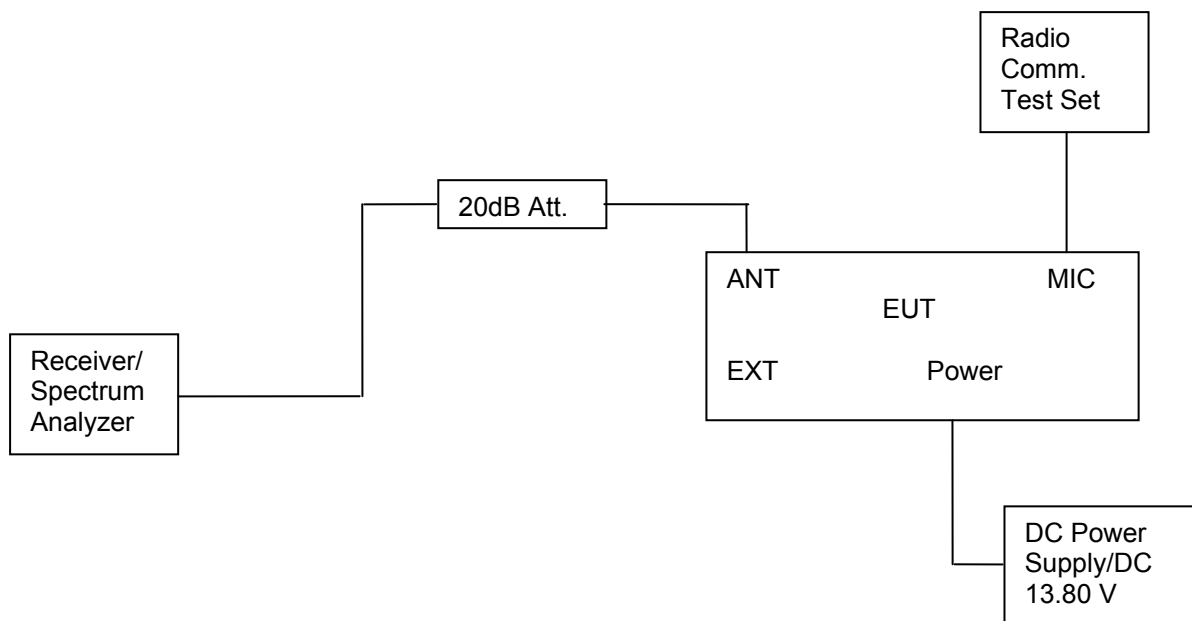

TEST PROCEDURE

1. The EUT was modulated by 2.5kHz Sine wave audio signal; the level of the audio signal employed is 16 dB greater than that necessary to produce 50% of rated system deviation. Rated system deviation is 2.5 kHz (12.5kHz channel spacing) and 5kHz (25 kHz channel spacing).
2. Set EUT as normal operation.
 - 1) Set SPA Center Frequency = fundamental frequency, RBW=100Hz, VBW=300Hz, span=50kHz for 12.5KHz channel spacing.
 - 2) Set SPA Center Frequency = fundamental frequency, RBW=300Hz, VBW=1kHz, span=120kHz for 25KHz channel spacing.

TEST RESULTS

Remark: We tested and recorded Op 1 to Op2.

Operation Mode	Test Frequency (MHz)	RBW (Hz)	Applicable Mask	Result
Op 1	156.05	300.00	B	Pass
	156.8			
	157.425			
Op 2	156.05	300.00	B	Pass
	156.8			
	157.425			

Test plot as follows:

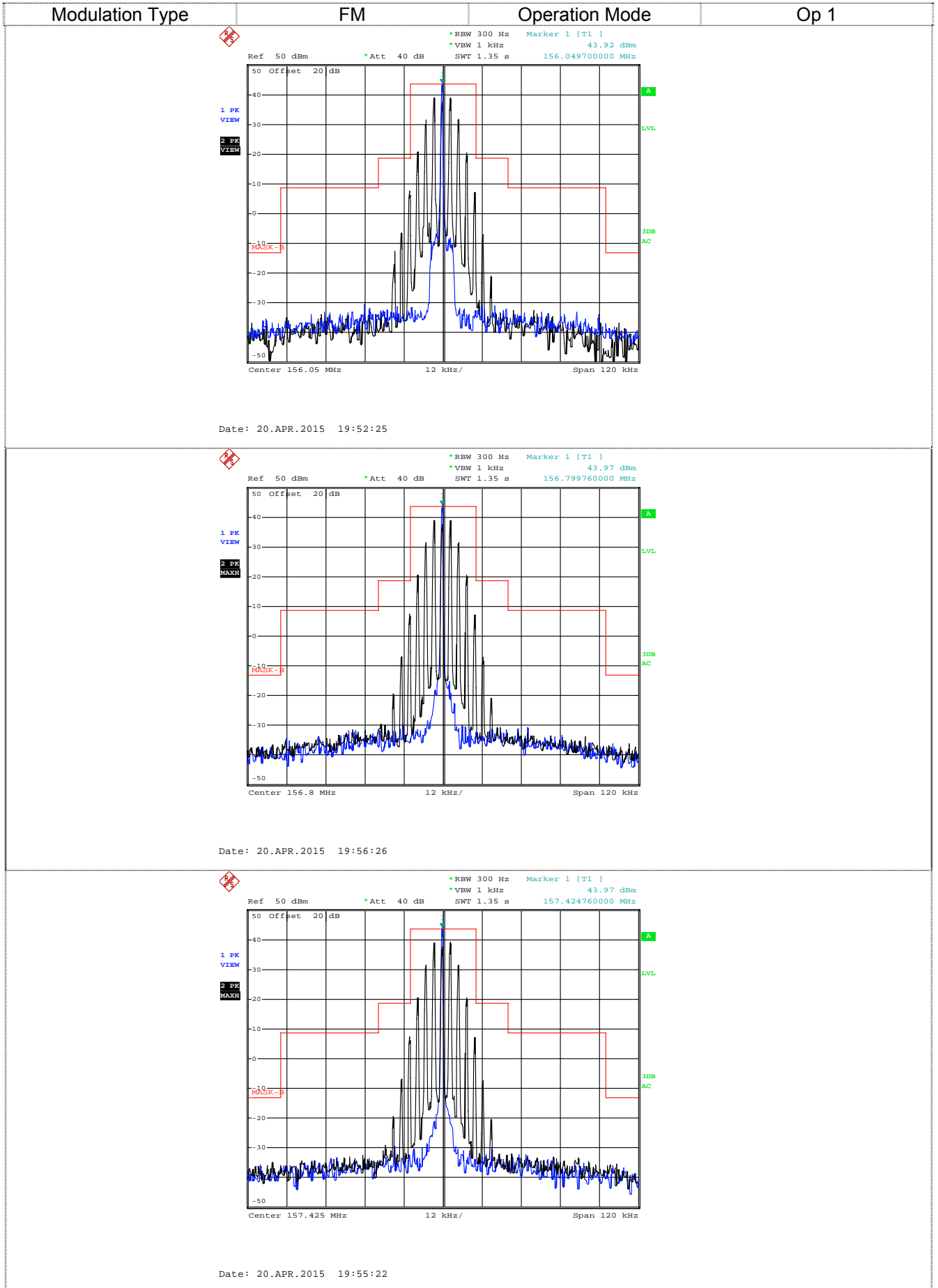

Modulation Type	FM	Operation Mode	Op 2
-----------------	----	----------------	------

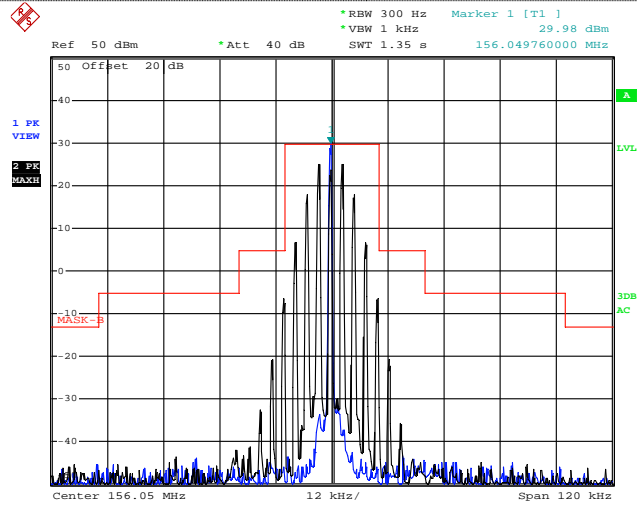

Date: 20.APR.2015 20:00:44

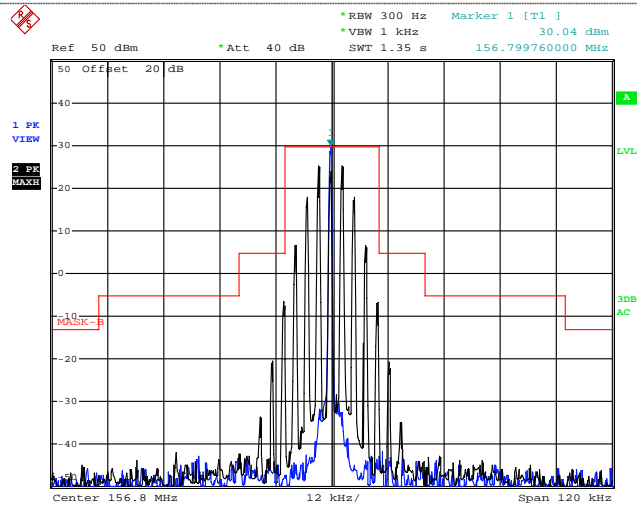

Date: 20.APR.2015 19:59:02

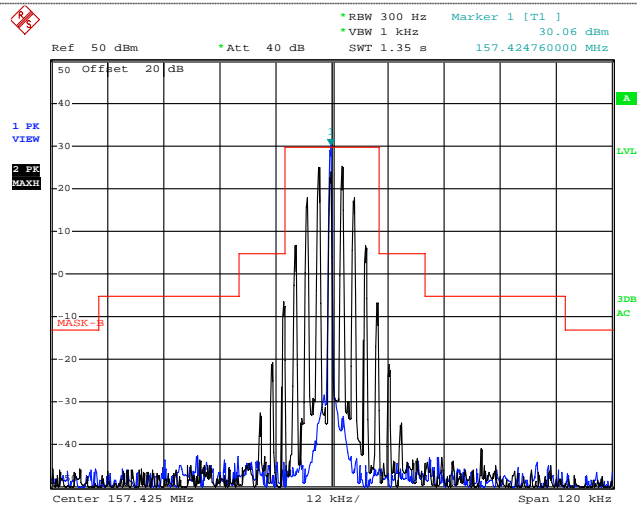

Date: 20.APR.2015 20:01:43

4.5. Modulation Characteristics

TEST APPLICABLE

According to CFR47 section 2.1047(a), for Voice Modulation Communication Equipment, the frequency response of the audio modulation circuit over a range of 100 to 5000Hz shall be measured.

80.213 (e) Coast station transmitters operated in the 156–162 MHz band must be equipped with an audio low-pass filter. The filter must be installed between the modulation limiter and the modulated radio frequency stage. At frequencies between 3 kHz and 20 kHz it must have an attenuation greater than at 1 kHz by at least $60\log_{10}(f/3)$ dB where “f” is the audio frequency in kilohertz. At frequencies above 20 kHz the attenuation must be at least 50 dB greater than at 1 kHz. The Audio Low Pass Filter

RSS-182 Clause show Coast station shall be equipped with an audio low-pass filter. 6 dB pre-emphasis network is required; it is to be connected before the deviation limiter in the transmit path.

TEST PROCEDURE

Modulation Limit

- 1 Configure the EUT as shown in figure 1, adjust the audio input for 60% of rated system deviation at 1kHz using this level as a reference (0dB) and vary the input level from –20 to +20dB. Record the frequency deviation obtained as a function of the input level.
- 2 Repeat step 1 with input frequency changing to 300, 1004, 1500 and 2500Hz in sequence.

Audio Frequency Response

- 1 Configure the EUT as shown in figure 1.
- 2 Adjust the audio input for 20% of rated system deviation at 1kHz using this level as a reference (0dB).
- 3 Vary the Audio frequency from 100 Hz to 3 kHz and record the frequency deviation.
- 4 Audio Frequency Response = $20\log_{10}(\text{Deviation of test frequency}/\text{Deviation of 1kHz reference})$.

Audio Low Pass Filter

1. Configure the EUT as shown in figure 1.
2. Apply a 1000 Hz tone from the audio frequency generator and adjust the level per manufacturer's specifications
3. Set the audio frequency generator to the desired test frequency between 3000 Hz and the upper low pass .filter limit
4. Low pass frequency response = $LEV_{\text{FREQ}} - LEV_{\text{REF}}$.

TEST CONFIGURATION

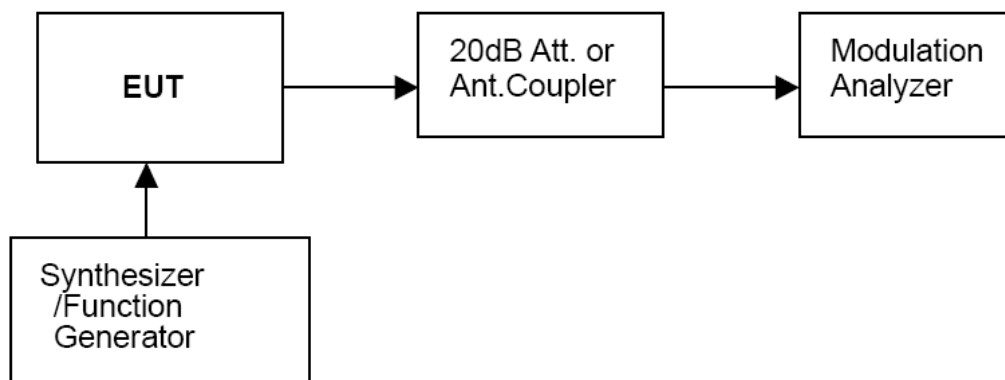

TEST RESULTS

Remark: We tested Op 1 to Op 2. recorded worst case at Op 1 for 156.8MHz.

a).Modulation Limit:

Op 1: 156.8MHz						
Modulation Level (dB)	Peak Freq. Deviation At 300Hz (kHz)	Peak Freq. Deviation At 1004Hz (kHz)	Peak Freq. Deviation At 1500Hz (kHz)	Peak Freq. Deviation At 2500 Hz (kHz)	Limit (kHz)	Result
-20	0.15	0.35	0.73	1.17	5.0	Pass
-15	0.13	0.55	1.56	2.45		
-10	0.52	1.08	2.75	4.16		
-5	0.78	3.07	4.34	4.16		
0	0.76	3.05	4.33	4.15		
5	0.74	2.93	4.37	4.12		
10	0.73	3.12	4.45	4.18		
15	1.36	4.73	4.42	4.17		
20	2.36	4.56	4.43	4.15		

Test plot as follows:

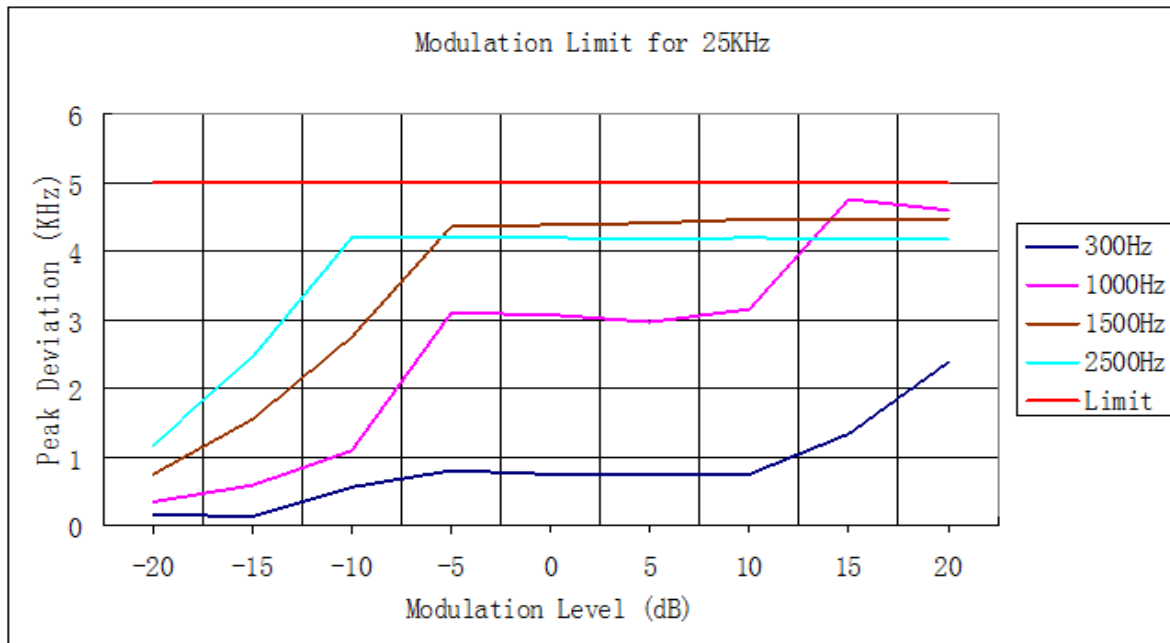

b). Audio Frequency Response:

Method of Measurement:

The audio frequency response was measured in accordance with TIA/EIA Specification 603 with no exception. A curve or equivalent data showing the frequency response of the audio modulating circuit over a range of 300-3000Hz shall be submitted and Audio Post Limiter Low Pass Filter Response from 3.0kHz to 50kHz. However, the audio frequency response should test from 100Hz to 5.0 kHz according to FCC Part 2.1047(a).

Note:The Audio Frequency Response is identical for 25kHz channel separation

Op 1: 156.8MHz			
Frequency (kHz)	Frequency Deviation (kHz)	1KHz Reference Deviation (kHz)	Audio Frequency Response (dB)
0.1	0.04	1.04	-28.30
0.2	0.05	1.04	-26.36
0.3	0.16	1.04	-16.26
0.4	0.21	1.04	-13.90
0.5	0.31	1.04	-10.51
0.6	0.57	1.04	-5.22
0.7	0.69	1.04	-3.56
0.8	0.73	1.04	-3.07
0.9	0.75	1.04	-2.84
1	1.04	1.04	0.00
1.2	1.15	1.04	0.87
1.4	1.22	1.04	1.39
1.6	1.36	1.04	2.33
1.8	1.63	1.04	3.90
2	1.89	1.04	5.19
2.2	2.03	1.04	5.81
2.4	2.25	1.04	6.70
2.6	2.46	1.04	7.48
2.7	2.58	1.04	7.89
2.8	2.62	1.04	8.03
3	2.77	1.04	8.51
3.5	0.04	1.04	-28.30
4	0.04	1.04	-28.30
4.5	0.04	1.04	-28.30
5	0.04	1.04	-28.30

Test plot as follows:

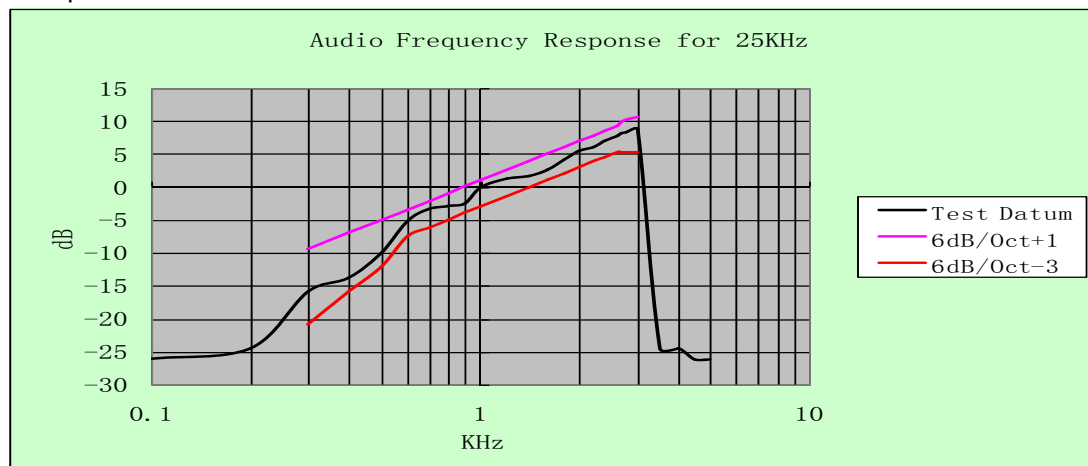

c). Audio Low Pass Filter:

Op 1: 156.8MHz		
Audio Frequency (kHz)	1kHz Reference Response Attenuation (dB)	Limit (dB)
3.0	-11.53	0.00
3.5	-14.74	-2.68
4.0	-17.82	-5.00
5.0	-19.84	-8.87
6.0	-21.86	-12.04
7.0	-25.95	-14.72
8.0	-29.92	-17.04
9.0	-32.03	-19.08
10.0	-36.16	-20.92
15.0	-40.53	-28.00
20.0	-41.82	-28.00
30.0	-42.72	-28.00
50.0	-44.85	-28.00
70.0	-44.71	-28.00

Test plot as follows:

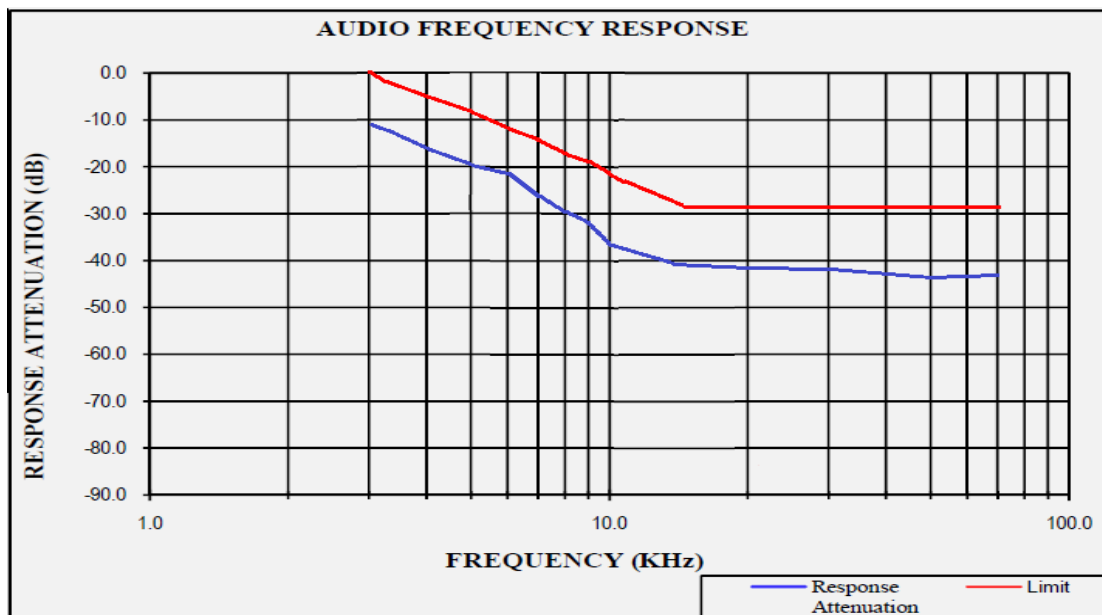

4.6. Frequency Stability Test

TEST APPLICABLE

- 1 According to FCC Part 2 Section 2.1055 (a)(1), the frequency stability shall be measured with variation of ambient temperature from -30°C to +50°C centigrade.
- 2 According to FCC Part 2 Section 2.1055 (d) (2), for battery powered equipment, the frequency stability shall be measured with reducing primary supply voltage to the battery operating end point, which is specified by the manufacture.
- 3 Vary primary supply voltage from 85 to 115 percent of the nominal value.
- 4 According to §80.209(a), the frequency stability limit:
 - 1) Ship stations:10ppm
 - 2) Coast stations:
 For carriers licensed to operate with a carrier power:
 - i) Below 3 watts:10ppm
 - ii)3 to 100 watts:5ppm
- 5 According to RSS-182 Section7.4, the frequency stability limit :
 - 1) Ship stations:10ppm
 - 2) Coast stations:
 For carriers licensed to operate with a carrier power:
 - i) Below 3 watts:10ppm
 - ii)3 to 100 watts:5ppm
 - iii)Above 100 watts:2.5ppm

TEST PROCEDURE

The EUT was set in the climate chamber and connected to an external DC power supply. The RF output was directly connected to Spectrum Analyzer ESI 26. The coupling loss of the additional cables was recorded and taken in account for all the measurements. After temperature stabilization (approx. 20 min for each stage), the frequency for the lower, the middle and the highest frequency range was recorded. For Frequency stability Vs. Voltage the EUT was connected to a DC power supply and the voltage was adjusted in the required ranges. The result was recorded.

TEST CONFIGURATION

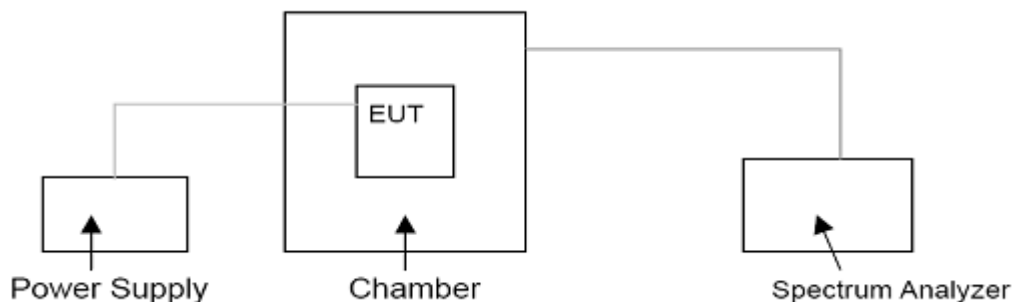

TEST LIMITS

According to 80.209(a)(5), Transmitters used must have minimum frequency stability as specified in the following table:

(5) Band 156-162 MHz:	
(i) Coast stations:	
For carriers licensed to operate with a carrier power:	
Below 3 watts	10.
3 to 100 watts	5. ⁷
(ii) Ship stations	10. ⁴
(iii) Survival craft stations operating on 121.500 MHz	50.
(iv) EPIRBs:	
Operating on 121.500 and 243.000 MHz	50.
Operating on 156.750 and 156.800 MHz. ⁶	10.

According to RSS-182 Section 7.4, Transmitters used must have minimum frequency stability as specified in the following table:

Type of Equipment	Frequency Stability Limit
Coast stations	±10.0 ppm for transmitter power less than 3 watts ±5.0 ppm for transmitter power between 3 and 100 watts ±2.5 ppm for transmitter power exceeding 100 watts
Ship stations	±10 ppm

TEST RESULTS

Remark: We tested and recorded Op 1 to Op 2.

Op 1						
Test conditions		Frequency error (ppm)			Limit (ppm)	Result
Voltage(V)	Temp(°C)	156.05MHz	156.8MHz	157.425MHz		
13.8	-30	0.13	-0.13	-0.13	5.0	Pass
	-20	0.18	-0.16	0.14		
	-10	0.19	-0.13	-0.23		
	0	-0.12	-0.11	0.19		
	10	-0.15	0.16	-0.16		
	20	0.24	-0.13	0.13		
	30	-0.23	0.21	-0.15		
	40	-0.08	0.13	-0.17		
	50	-0.18	0.14	0.16		
11.73(85% Rated)	20	0.15	0.16	0.14		
15.87(115% Rated)	20	-0.17	0.19	0.19		

Op 2						
Test conditions		Frequency error (ppm)			Limit (ppm)	Result
Voltage(V)	Temp(°C)	156.05MHz	156.8MHz	157.425MHz		
13.8	-30	-0.15	-0.16	-0.18	10.0	Pass
	-20	0.14	0.09	0.14		
	-10	0.16	-0.18	-0.22		
	0	-0.13	-0.17	0.19		
	10	-0.11	0.16	-0.18		
	20	0.23	0.14	0.13		
	30	-0.20	0.19	-0.16		
	40	-0.12	0.17	-0.15		
	50	0.14	0.15	0.14		
11.73(85% Rated)	20	0.17	0.17	0.15		
15.87(115% Rated)	20	0.23	0.19	0.18		

4.7. Spurious Emssion on Antenna Port

TEST APPLICABLE

The same as Section 4.4

TEST PROCEDURE

The RF output of the EUT was connected to a spectrum analyzer through appropriate attenuation. The resolution bandwidth of the spectrum analyzer was set to 100 kHz. Sufficient scans were taken to show any out of band emission up to 10th. Harmonic for the lower and the highest frequency range. Set RBW 100 kHz, VBW 300 kHz in the frequency band 30MHz to 1GHz,while set RBW=1MHz.VBW=3MHz from the 1GHz to 10th Harmonic.

The audio input was set to 0 to get the unmodulated carrier, the resulting picture is print out for each channel separation.

TEST CONFIGURATION

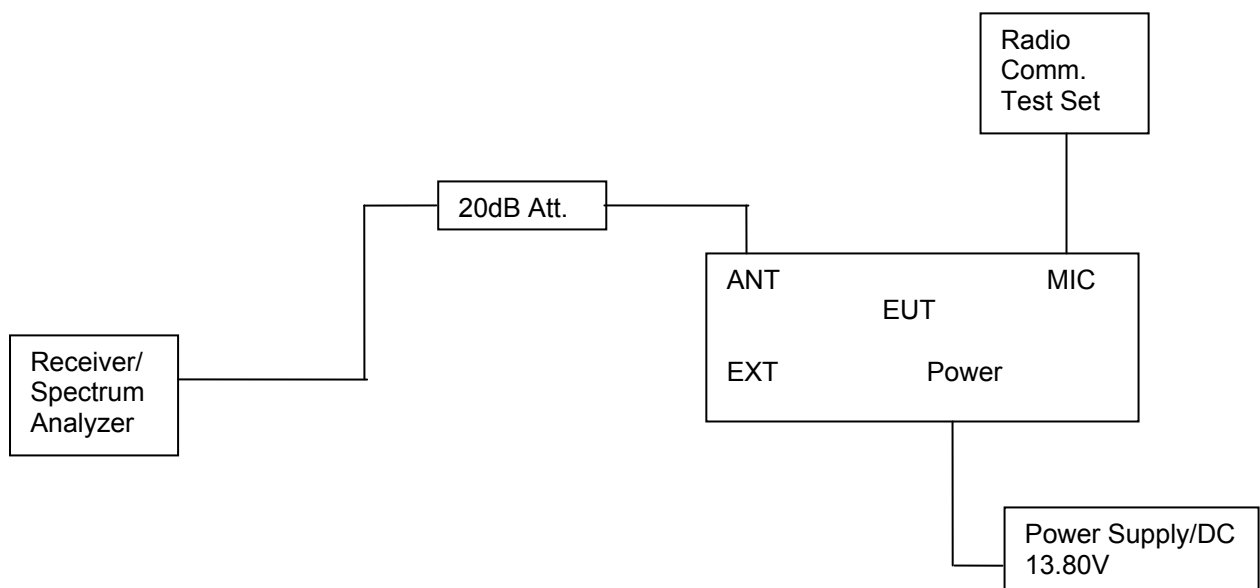

LIMIT

Modulation Type: FM

FCC Part 22.359, 74.462, 80.211 and 90.210 and RSS Gen, RSS 119 Issue 11 (25 kHz bandwidth only):

On any frequency removed from the center of the assigned channel by more than 250 percent at least:

Low: $43 + 10 \log (P_{watts}) = 43 + 10 \log (25.47) = 57.06 \text{ dB}$

High: $43 + 10 \log (P_{watts}) = 43 + 10 \log (25.59) = 57.08 \text{ dB}$

Calculation: Limit (dBm) = EL-43-10log10 (TP)

Notes: EL is the emission level of the Output Power expressed in dBm,
In this application, the EL is 43.98 dBm.

Limit (dBm) = $43.98 - 43 - 10 \log_{10} (25.47) = -13 \text{ dBm}$

TEST RESULTS

Remark: We tested Op 1 to Op 2, recorded worst case at Op 1.

Note:

1. In general, the worse case attenuation requirement shown above was applied.
2. The measurement frequency range from 30 MHz to 2GHz.

Test plot as follows:

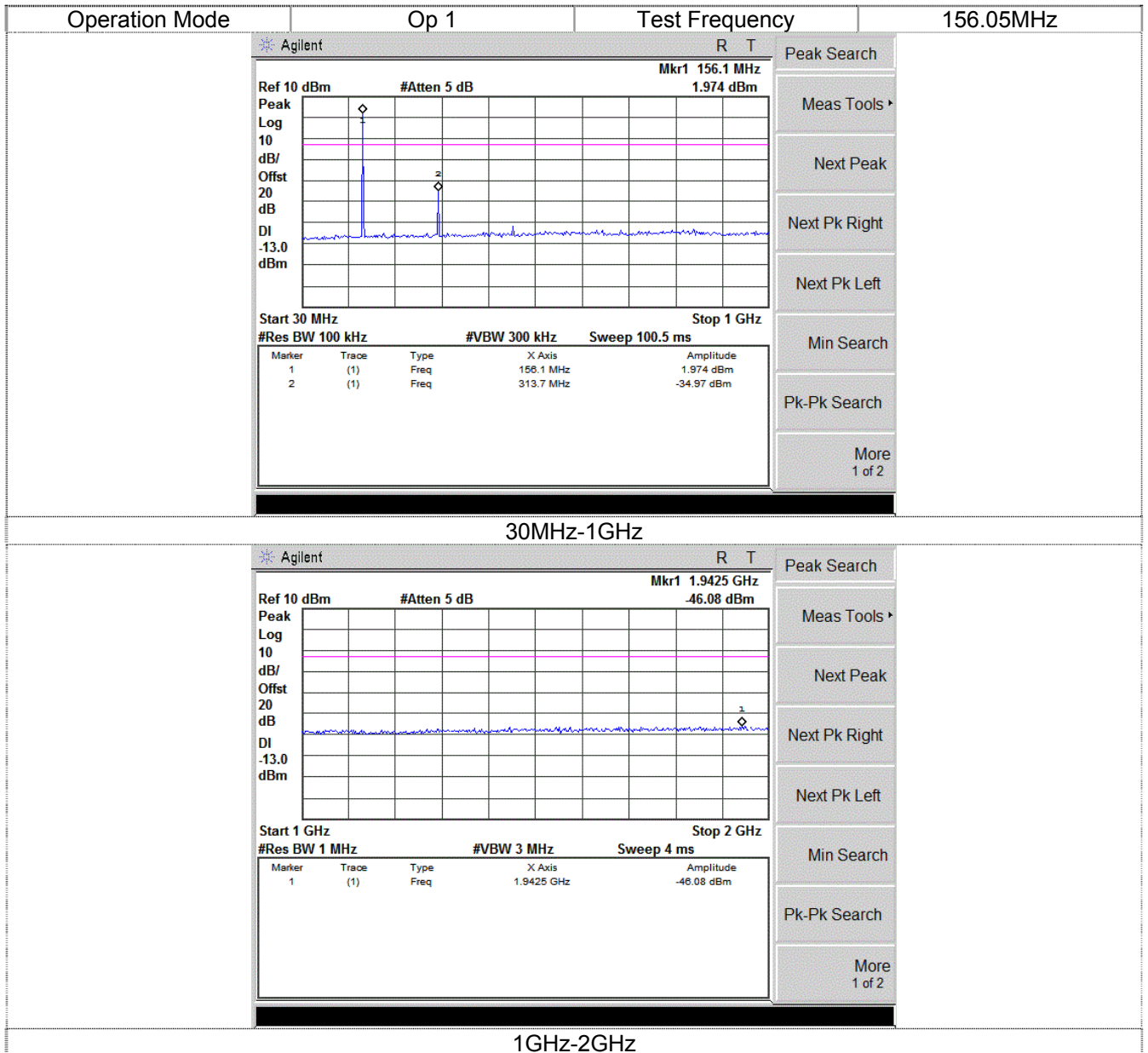

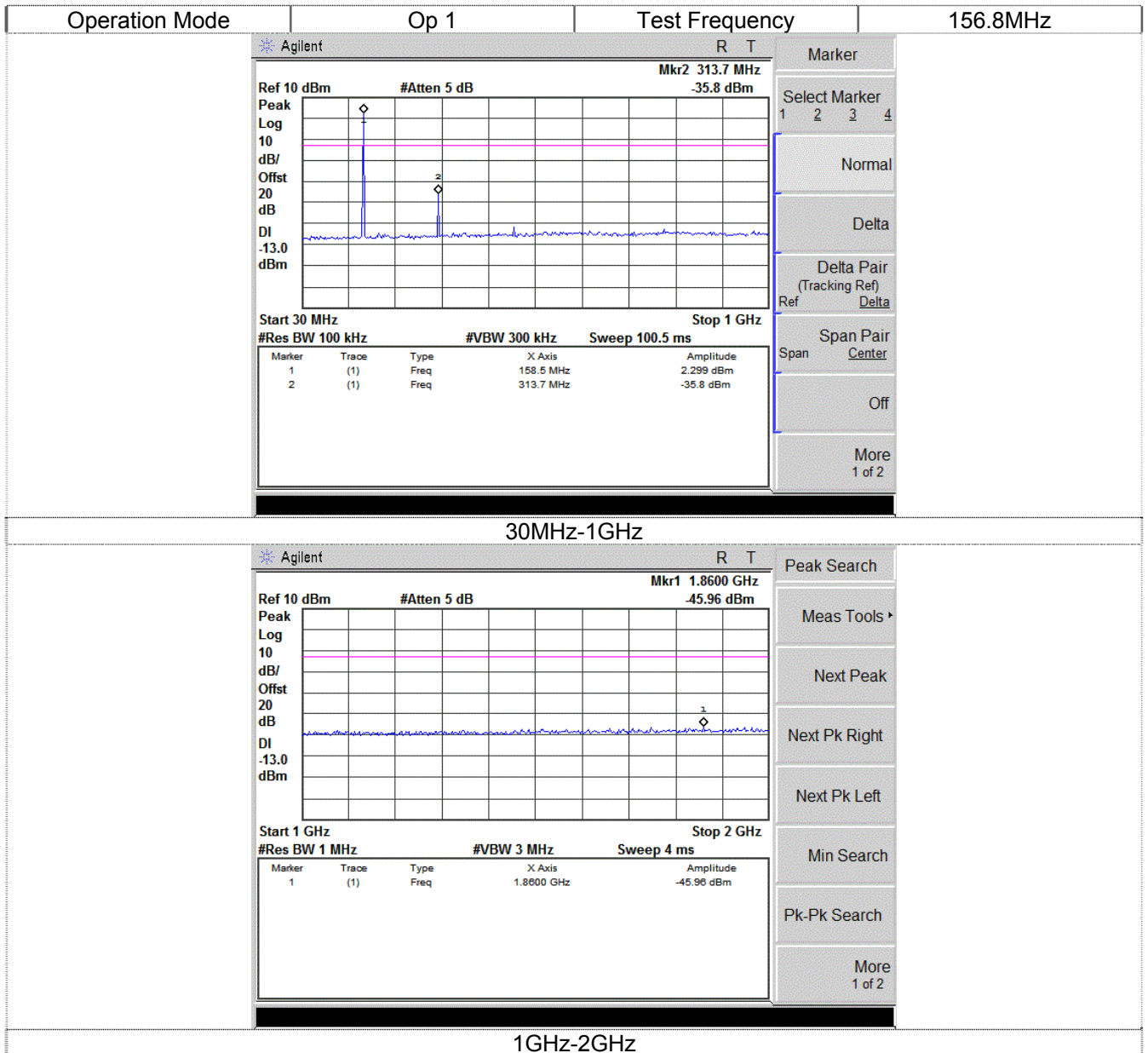



4.8. Transmitter Radiated Spurious Emission

TEST APPLICABLE

According to the TIA/EIA 603 test method, and according to Section 80.211, the power of each unwanted emission shall be less than Transmitted Power as specified below for transmitters designed to operate with 12.5 kHz channel bandwidth:

- 1 On any frequency removed from the center of the authorized bandwidth f_0 to 5.625kHz removed from f_0 : Zero dB
- 2 On any frequency removed from the center of the authorized bandwidth by a displacement frequency (f_d in kHz) f_0 of more than 5.625kHz but no more than 12.5 kHz: At least 7.27dB
- 3 On any frequency removed from the center of the authorized bandwidth by a displacement frequency (f_d in KHz) f_0 of more than 12.5 kHz: At least $50+10 \log (P)$ dB or 70 dB, which ever is lesser attenuation.

For transmitters designed to transmit with 25kHz channel separation and equipped with an audio low-pass filter, the power of any emission must be attenuated below the unmodulated carrier power (P) as following:

- 1 On any frequency removed from the assigned frequency by more than 50 percent, but no more than 100 percent of the authorized bandwidth: At least 25 dB.
- 2 On any frequency removed from the assigned frequency by more than 100 percent, but no more than 250 percent of the authorized bandwidth: At least 35 dB.
- 3 On any frequency removed from the assigned frequency by more than 250 percent of the authorized bandwidth: At least $43+10\text{Log} (P)$ dB.

TEST CONFIGURATION

Below 1GHz:

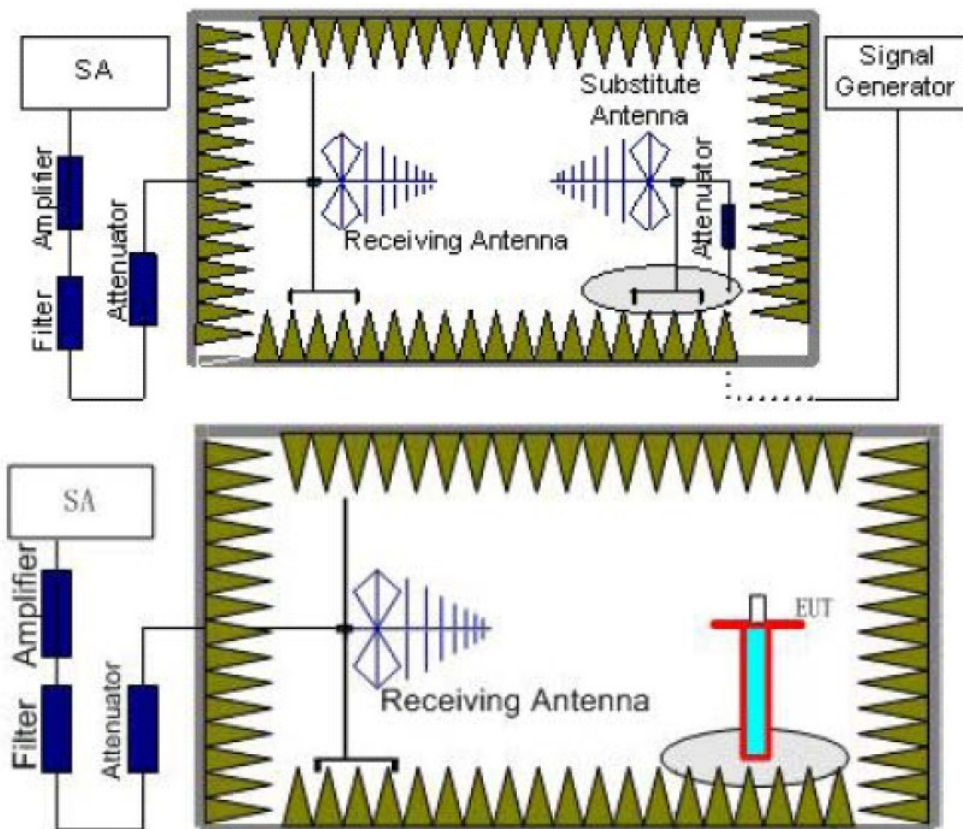

Above 1GHz:

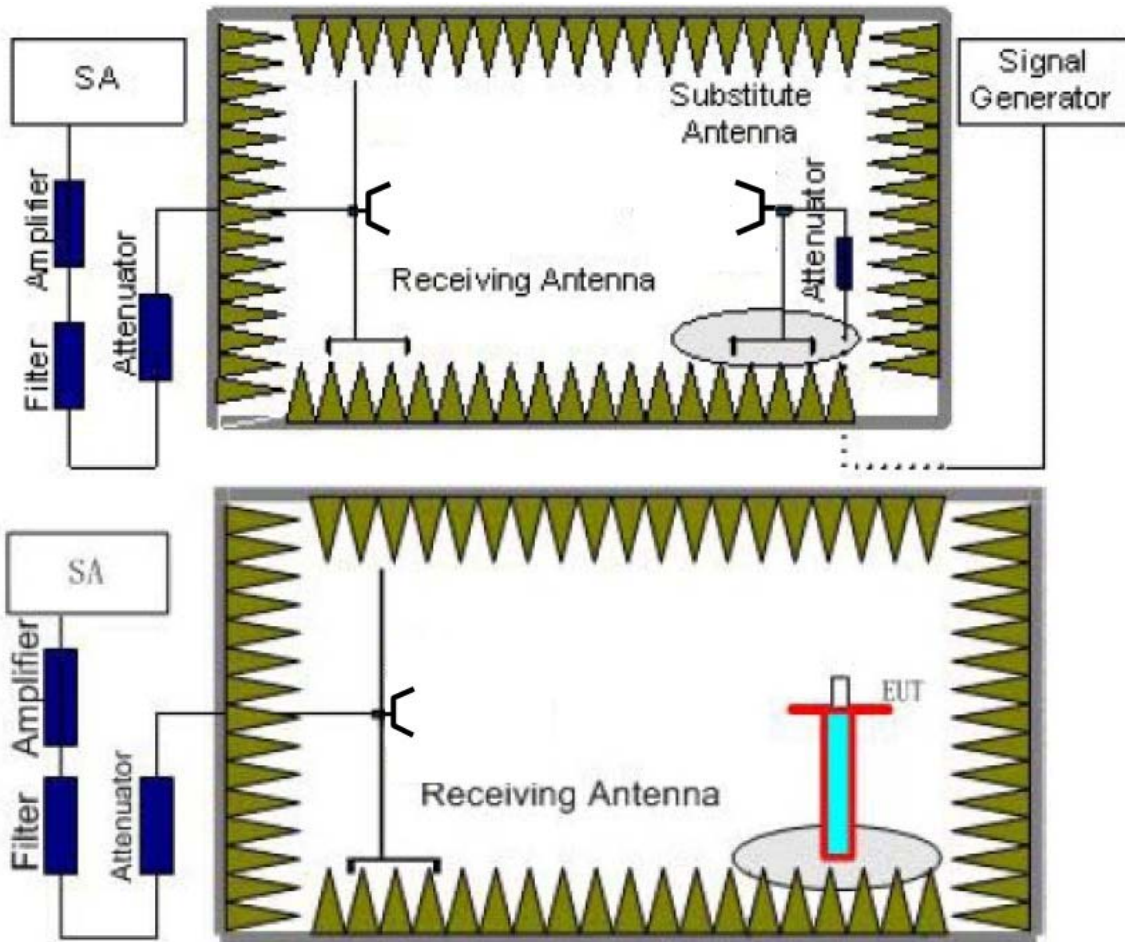

TEST PROCEDURE

1. EUT was placed on a 0.8 meter high non-conductive stand at a 3 meter test distance from the receive antenna. A receiving antenna was placed on the antenna mast 3 meters from the EUT for emission measurements. The height of receiving antenna is 1.0 m. Detected emissions were maximized at each frequency by rotating the EUT through 360° and adjusting the receiving antenna polarization. The radiated emission measurements of all transmit frequencies in six channels were measured with peak detector.
2. A log-periodic antenna or double-ridged waveguide horn antenna shall be substituted in place of the EUT. The log-periodic antenna will be driven by a signal generator and the level will be adjusted till the same power value on the spectrum analyzer or receiver. The level of the spurious emissions can be calculated through the level of the signal generator, cable loss, the gain of the substitution antenna and the reading of the spectrum analyzer or receiver.
3. The EUT is then put into continuously transmitting mode at its maximum power level during the test. Set Test Receiver or Spectrum RBW=1MHz, VBW=3MHz for above 1GHz and RBW=100kHz, VBW=300kHz for 30MHz to 1GHz, And the maximum value of the receiver should be recorded as (P_r).
4. The EUT shall be replaced by a substitution antenna. In the chamber, an substitution antenna for the frequency band of interest is placed at the reference point of the chamber. An RF Signal source for the frequency band of interest is connected to the substitution antenna with a cable that has been constructed to not interfere with the radiation pattern of the antenna. A power (P_{Mea}) is applied to the input of the substitution antenna, and adjust the level of the signal generator output until the value of the receiver reach the previously recorded (P_r). The power of signal source (P_{Mea}) is recorded. The test should be performed by rotating the test item and adjusting the receiving antenna polarization.
5. A amplifier should be connected to the Signal Source output port. And the cable should be connect between the Amplifier and the Substitution Antenna. The cable loss (P_{cl}), the Substitution Antenna Gain (G_a) and the Amplifier Gain (P_{Ag}) should be recorded after test. The measurement results are obtained as described below:

$$\text{Power(EIRP)} = P_{\text{Mea}} - P_{\text{cl}} - G_a$$
 We used SMF100A microwave signal generator which signal level can up to 33dBm, so we not used power Amplifier for substitution test; The measurement results are amend as described below:

$$\text{Power(EIRP)} = P_{\text{Mea}} - P_{\text{cl}} - G_a$$
6. This value is EIRP since the measurement is calibrated using an antenna of known gain (2.15 dBi) and known input power.

7. ERP can be calculated from EIRP by subtracting the gain of the dipole, $ERP = EIRP - 2.15 \text{dBi}$.

LIMIT

Modulation Type: FM

FCC Part 22.359, 74.462, 80.211 and 90.210 and RSS Gen, RSS 119 Issue 11 (25 kHz bandwidth only):

On any frequency removed from the center of the assigned channel by more than 250 percent at least:

Low: $43 + 10 \log(\text{Pwatts}) = 43 + 10 \log(25.47) = 57.06 \text{ dB}$

High: $43 + 10 \log(\text{Pwatts}) = 43 + 10 \log(25.59) = 57.08 \text{ dB}$

Calculation: Limit (dBm) = $EL - 43 - 10 \log_{10}(\text{TP})$

Notes: EL is the emission level of the Output Power expressed in dBm,

In this application, the EL is 43.98 dBm.

Limit (dBm) = $43.98 - 43 - 10 \log_{10}(25.47) = -13 \text{ dBm}$

TEST RESULTS

Remark: We tested Op 1 to Op 2. recorded worst case at Op 1.

Note: 1. In general, the worse case attenuation requirement shown above was applied.

2. The measurement frequency range from 30 MHz to 2 GHz.

Test plot as follows:

Op 1

Test Frequency: 156.05 MHz Polarity: Horizontal

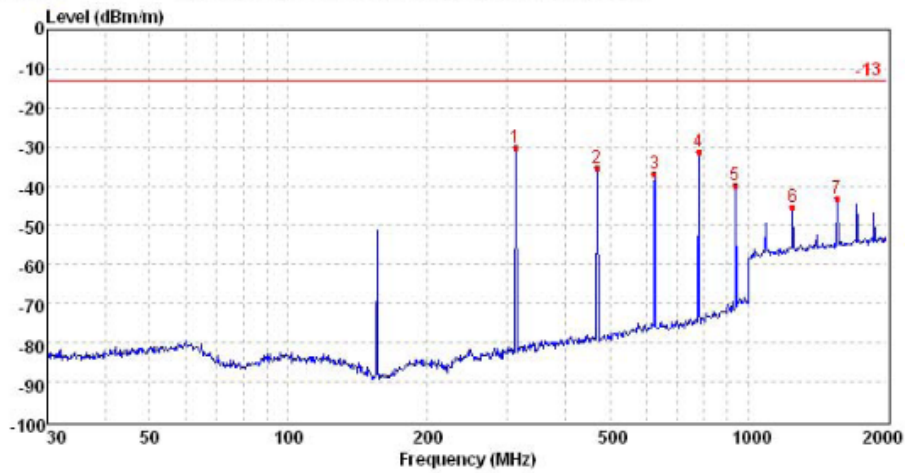

Mark	Frequency MHz	Reading dBm	Antenna dB	Cable dB	Preamp dB	Level dBm	Limit dBm	Over limit	Remark
1	312.06	-29.55	26.50	1.96	28.86	-29.95	-13.00	-16.95	Peak
2	469.24	-38.09	29.34	2.42	28.91	-35.24	-13.00	-22.24	Peak
3	626.07	-42.65	31.76	2.95	28.73	-36.67	-13.00	-23.67	Peak
4	781.33	-38.82	33.03	3.27	28.54	-31.06	-13.00	-18.06	Peak
5	938.10	-51.66	36.45	3.64	28.38	-39.95	-13.00	-26.95	Peak
6	1248.33	-60.53	39.26	4.24	28.23	-45.26	-13.00	-32.26	Peak
7	1560.49	-60.20	40.18	4.86	28.13	-43.29	-13.00	-30.29	Peak

Test Frequency: 156.05MHz Polarity: Vertical

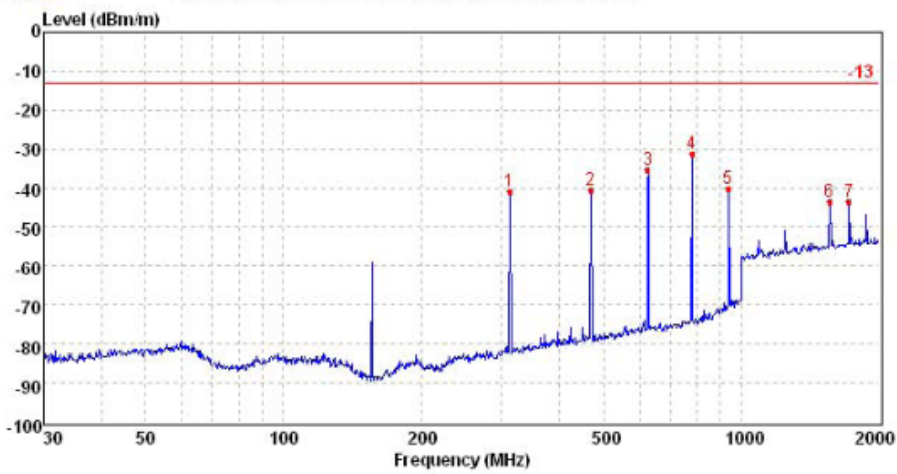

Mark	Frequency MHz	Reading dBm	Antenna dB	Cable dB	Preamp dB	Level dBm	Limit dBm	Over limit	Remark
1	312.06	-40.47	26.50	1.96	28.86	-40.87	-13.00	-27.87	Peak
2	469.24	-43.24	29.34	2.42	28.91	-40.39	-13.00	-27.39	Peak
3	626.07	-41.30	31.76	2.95	28.73	-35.32	-13.00	-22.32	Peak
4	781.33	-38.88	33.03	3.27	28.54	-31.12	-13.00	-18.12	Peak
5	938.10	-52.00	36.45	3.64	28.38	-40.29	-13.00	-27.29	Peak
6	1560.49	-60.42	40.18	4.86	28.13	-43.51	-13.00	-30.51	Peak
7	1717.13	-60.87	40.52	5.12	28.09	-43.32	-13.00	-30.32	Peak

Op 1

Test Frequency: 156.8 MHz Polarity: *Horizontal*

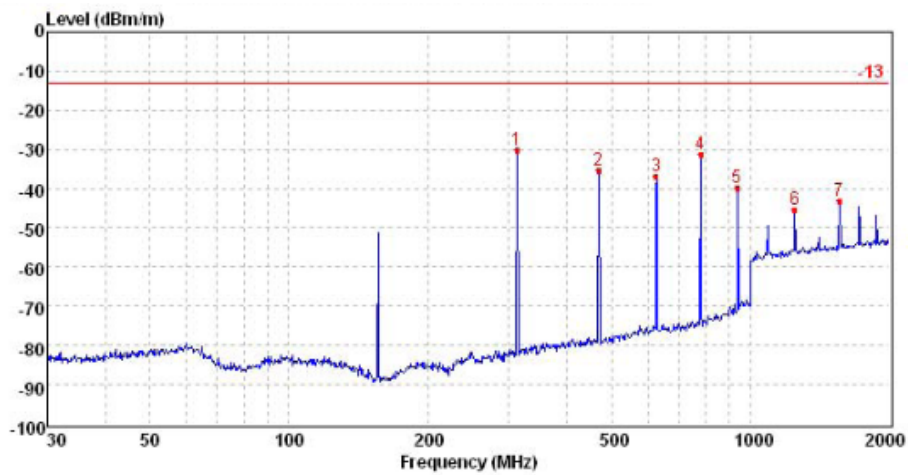

Mark	Frequency MHz	Reading dBm	Antenna dB	Cable dB	Preamp dB	Level dBm	Limit dBm	Over limit	Remark
1	312.06	-29.55	26.50	1.96	28.86	-29.95	-13.00	-16.95	Peak
2	469.24	-38.09	29.34	2.42	28.91	-35.24	-13.00	-22.24	Peak
3	626.07	-42.65	31.76	2.95	28.73	-36.67	-13.00	-23.67	Peak
4	781.33	-38.82	33.03	3.27	28.54	-31.06	-13.00	-18.06	Peak
5	938.10	-51.66	36.45	3.64	28.38	-39.95	-13.00	-26.95	Peak
6	1248.33	-60.53	39.26	4.24	28.23	-45.26	-13.00	-32.26	Peak
7	1560.49	-60.20	40.18	4.86	28.13	-43.29	-13.00	-30.29	Peak

Test Frequency: 156.8MHz Polarity: *Vertical*

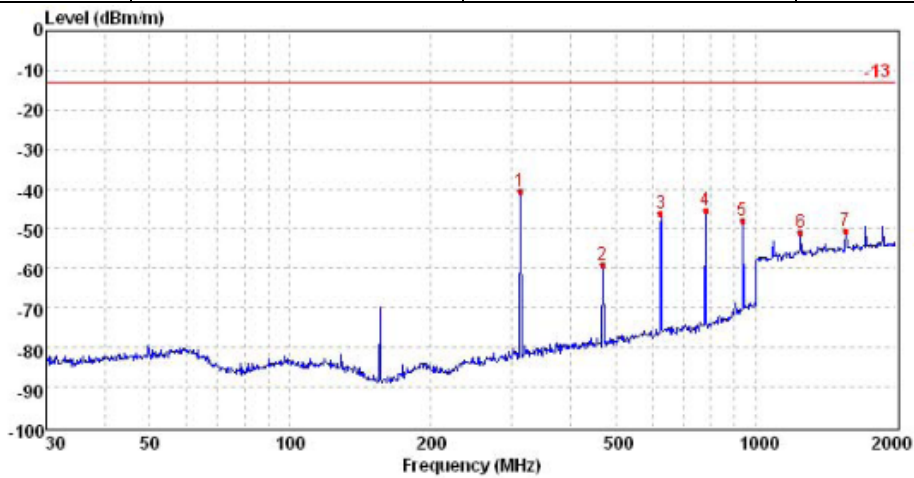

Mark	Frequency MHz	Reading dBm	Antenna dB	Cable dB	Preamp dB	Level dBm	Limit dBm	Over limit	Remark
1	312.06	-40.30	26.50	1.96	28.86	-40.70	-13.00	-27.70	Peak
2	469.24	-61.99	29.34	2.42	28.91	-59.14	-13.00	-46.14	Peak
3	626.07	-52.26	31.76	2.95	28.73	-46.28	-13.00	-33.28	Peak
4	781.33	-53.15	33.03	3.27	28.54	-45.39	-13.00	-32.39	Peak
5	938.10	-59.75	36.45	3.64	28.38	-48.04	-13.00	-35.04	Peak
6	1248.33	-66.30	39.26	4.24	28.23	-51.03	-13.00	-38.03	Peak
7	1560.49	-67.40	40.18	4.86	28.13	-50.49	-13.00	-37.49	Peak

Op 1

Test Frequency: 157.425 MHz Polarity: Horizontal

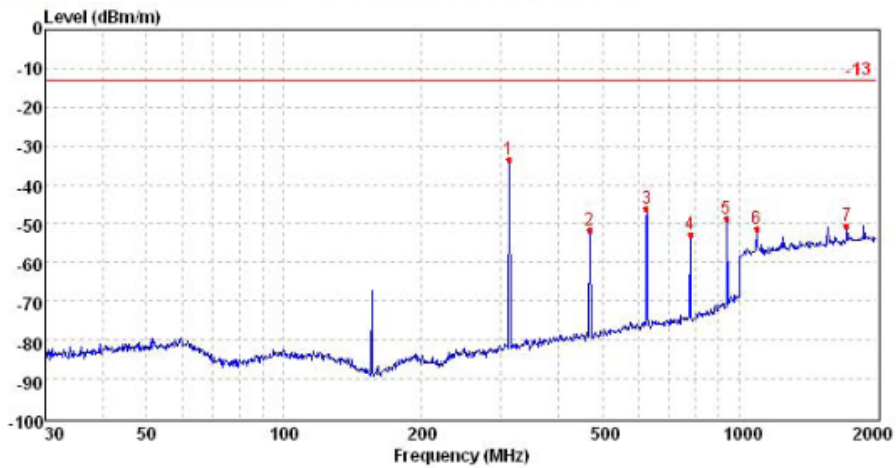

Mark	Frequency MHz	Reading dBm	Antenna dB	Cable dB	Preamp dB	Level dBm	Limit dBm	Over limit	Remark
1	312.06	-32.99	26.50	1.96	28.86	-33.39	-13.00	-20.39	Peak
2	469.24	-54.62	29.34	2.42	28.91	-51.77	-13.00	-38.77	Peak
3	626.07	-52.00	31.76	2.95	28.73	-46.02	-13.00	-33.02	Peak
4	781.33	-60.69	33.03	3.27	28.54	-52.93	-13.00	-39.93	Peak
5	938.10	-60.52	36.45	3.64	28.38	-48.81	-13.00	-35.81	Peak
6	1092.02	-65.74	38.70	3.90	28.28	-51.42	-13.00	-38.42	Peak
7	1717.13	-67.99	40.52	5.12	28.09	-50.44	-13.00	-37.44	Peak

Test Frequency: 157.425MHz Polarity: Vertical

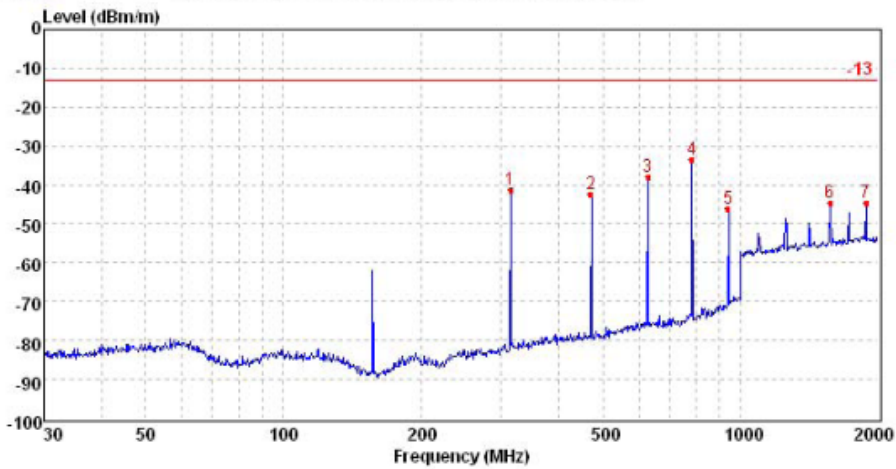

Mark	Frequency MHz	Reading dBm	Antenna dB	Cable dB	Preamp dB	Level dBm	Limit dBm	Over limit	Remark
1	314.26	-41.06	26.55	1.97	28.86	-41.40	-13.00	-28.40	Peak
2	470.89	-45.34	29.34	2.42	28.91	-42.49	-13.00	-29.49	Peak
3	628.27	-43.99	31.76	2.95	28.72	-38.00	-13.00	-25.00	Peak
4	784.08	-41.40	33.09	3.27	28.53	-33.57	-13.00	-20.57	Peak
5	941.41	-58.15	36.64	3.64	28.37	-46.24	-13.00	-33.24	Peak
6	1568.08	-61.43	40.20	4.86	28.13	-44.50	-13.00	-31.50	Peak
7	1881.65	-62.86	40.84	5.38	28.06	-44.70	-13.00	-31.70	Peak

4.9. Receiver Radiated Spurious Emission

TEST APPLICABLE

The field strength is calculated by adding the Antenna Factor and Cable Factor and subtracting the Amplifier Gain and Duty Cycle Correction Factor (if any) from the measured reading. The basic equation with a sample calculation is as follows:

$$FS = RA + AF + CL - AG$$

Where FS = Field Strength	CL = Cable Attenuation Factor (Cable Loss)
RA = Reading Amplitude	AG = Amplifier Gain
AF = Antenna Factor	

TEST CONFIGURATION

(A) Radiated Emission Test Set-Up, Frequency below 1000MHz

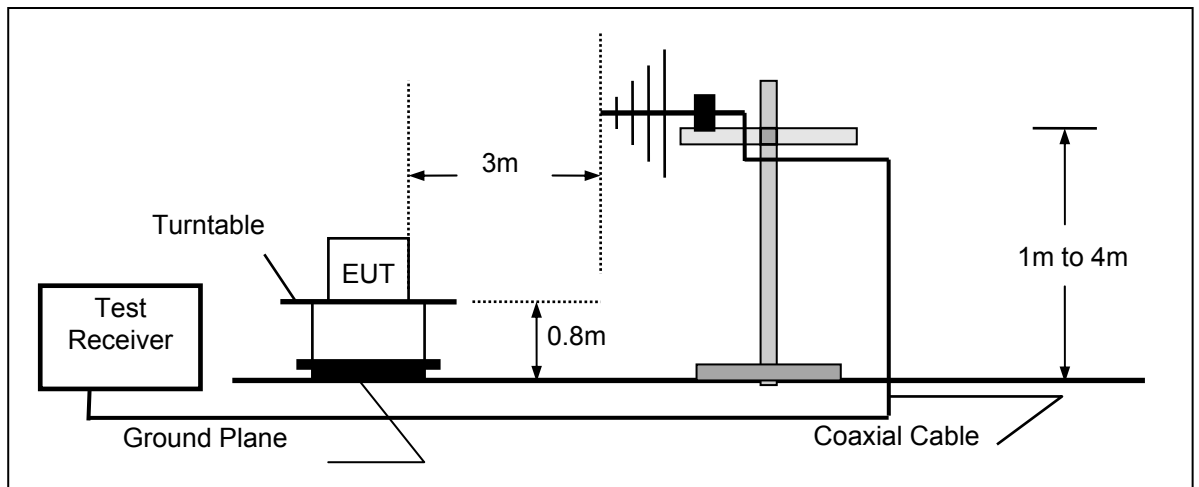

(B) Radiated Emission Test Set-Up, Frequency above 1000MHz

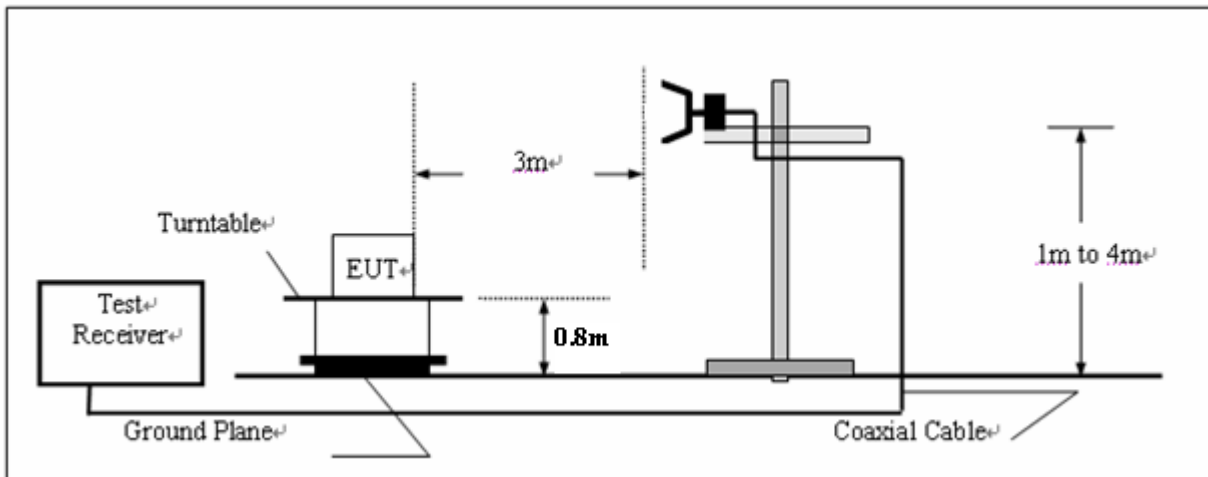

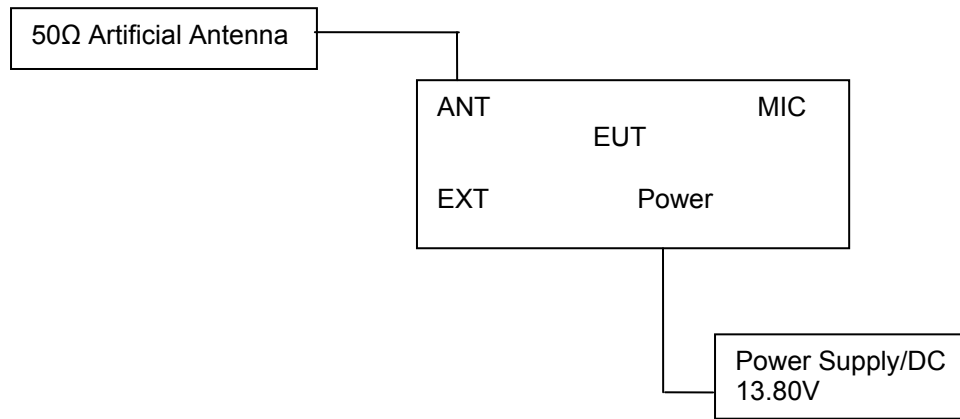

TEST PROCEDURE

- 1 The EUT was placed on a turn table which is 0.8m above ground plane.
- 2 Maximum procedure was performed by raising the receiving antenna from 1m to 4m and rotating the turn table from 0° to 360° to acquire the highest emissions from EUT
- 3 And also, each emission was to be maximized by changing the polarization of receiving antenna both horizontal and vertical.
- 4 Repeat above procedures until all frequency measurements have been completed.

RECEIVER RADIATED SPOUIOUS LIMIT

For unintentional device, according to § 15.109(a) and RSS-Gen, except for Class A digital devices, the field strength of radiated emissions from unintentional radiators at a distance of 3 meters shall not exceed the following values:

Frequency (MHz)	Distance (Meters)	Radiated (dBµV/m)	Radiated (µV/m)
30-88	3	40.0	100
88-216	3	43.5	150
216-960	3	46.0	200
Above 960	3	54.0	500

For intentional device, according to § 15.209(a), the general requirement of field strength of radiated emissions from intentional radiators at a distance of 3 meters shall not exceed the above table.

TEST RESULTS

Remak:

- 1.The Radiated Measurement (Standby mode /Receiver mode) are performed to the three channels (the high channel, the middle channel and the low channel), the datum recorded below is the worst case for each channel separation;and the EUT shall be scanned from 30 MHz to the 5th harmonic of the highest oscillator frequency in the digital devices or 1 GHz whichever is higher.
- 2.Test performed at Op 3 , Op 4 operation mode respectively.And the datum append below is the Op 3 operation mode and Op 4.

Op 3

Test Frequency: 156.05MHz Polarity: Horizontal

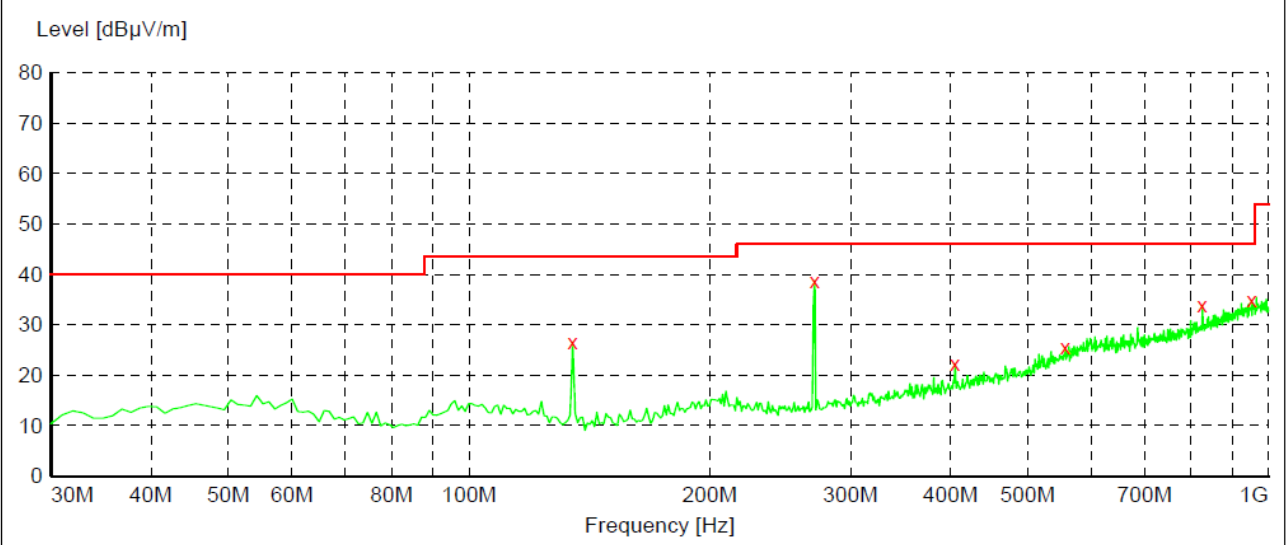

x x MES GM04276126_red
 MES GM04276126_pre
 LIM FCC ClassB F QP/AV FCC ClassB, field strength 3m

Frequency MHz	Level dBµV/m	Transd dB	Limit dBµV/m	Margin dB	Det.	Height cm	Azimuth deg	Polarization
134.760000	26.60	-17.7	43.5	16.9	QP	300.0	114.00	HORIZONTAL
270.560000	38.80	-14.7	46.0	7.2	QP	100.0	126.00	HORIZONTAL
405.390000	22.20	-10.6	46.0	23.8	QP	100.0	67.00	HORIZONTAL
556.710000	25.60	-4.5	46.0	20.4	QP	300.0	0.00	HORIZONTAL
826.370000	33.90	1.0	46.0	12.1	QP	300.0	335.00	HORIZONTAL
952.470000	34.90	3.7	46.0	11.1	QP	100.0	326.00	HORIZONTAL

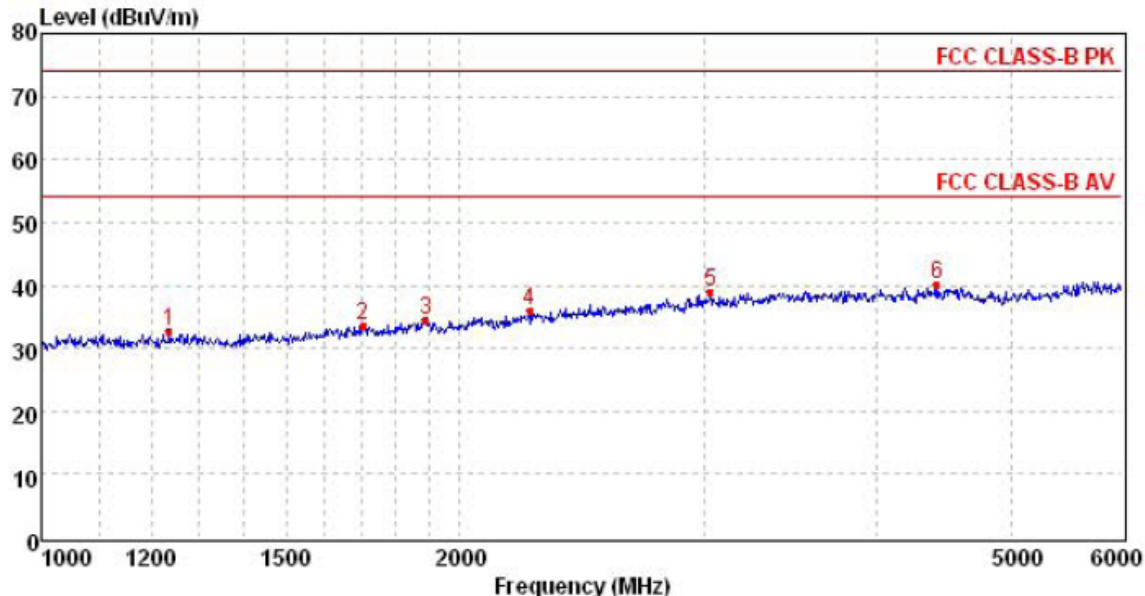

Mark	Frequency MHz	Reading dBuV/m	Antenna dB	Cable dB	Preamp dB	Level dBuV/m	Limit dBuV/m	Over limit	Remark
1	1235.44	40.12	24.46	4.62	36.55	32.65	74.00	-41.35	Peak
2	1705.65	39.76	25.33	5.62	37.02	33.69	74.00	-40.31	Peak
3	1892.44	39.76	25.83	5.96	37.17	34.38	74.00	-39.62	Peak
4	2247.63	39.95	27.04	6.59	37.46	36.12	74.00	-37.88	Peak
5	3031.63	40.20	28.52	8.22	37.99	38.95	74.00	-35.05	Peak
6	4416.59	38.72	30.69	8.92	38.28	40.05	74.00	-33.95	Peak

Op 3

Test Frequency:	156.05MHz	Polarity:	Vertical
-----------------	-----------	-----------	----------

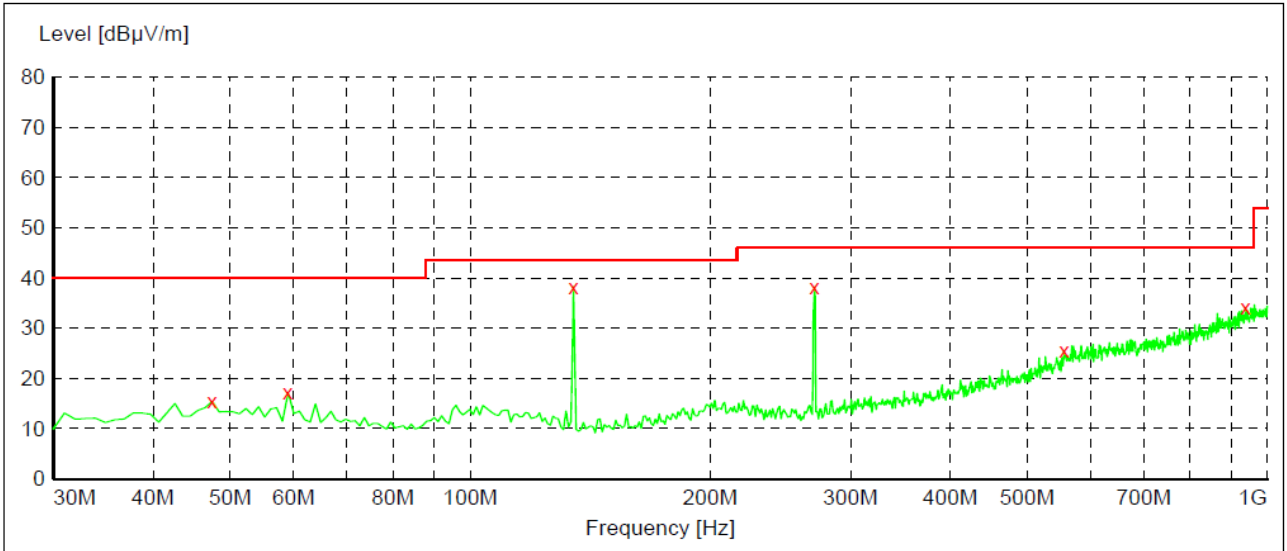

x x x	MES	GM04276125_red
—	MES	GM04276125_pre
—	LIM	FCC ClassB F QP/AV FCC ClassB, field strength 3m

Frequency MHz	Level dBµV/m	Transd dB	Limit dBµV/m	Margin dB	Det.	Height cm	Azimuth deg	Polarization
47.460000	15.40	-14.5	40.0	24.6	QP	100.0	7.00	VERTICAL
59.100000	17.20	-14.8	40.0	22.8	QP	100.0	45.00	VERTICAL
134.760000	38.30	-17.7	43.5	5.2	QP	100.0	27.00	VERTICAL
270.560000	38.30	-14.7	46.0	7.7	QP	100.0	27.00	VERTICAL
555.740000	25.60	-4.6	46.0	20.4	QP	100.0	280.00	VERTICAL
938.890000	34.10	3.5	46.0	11.9	QP	100.0	106.00	VERTICAL

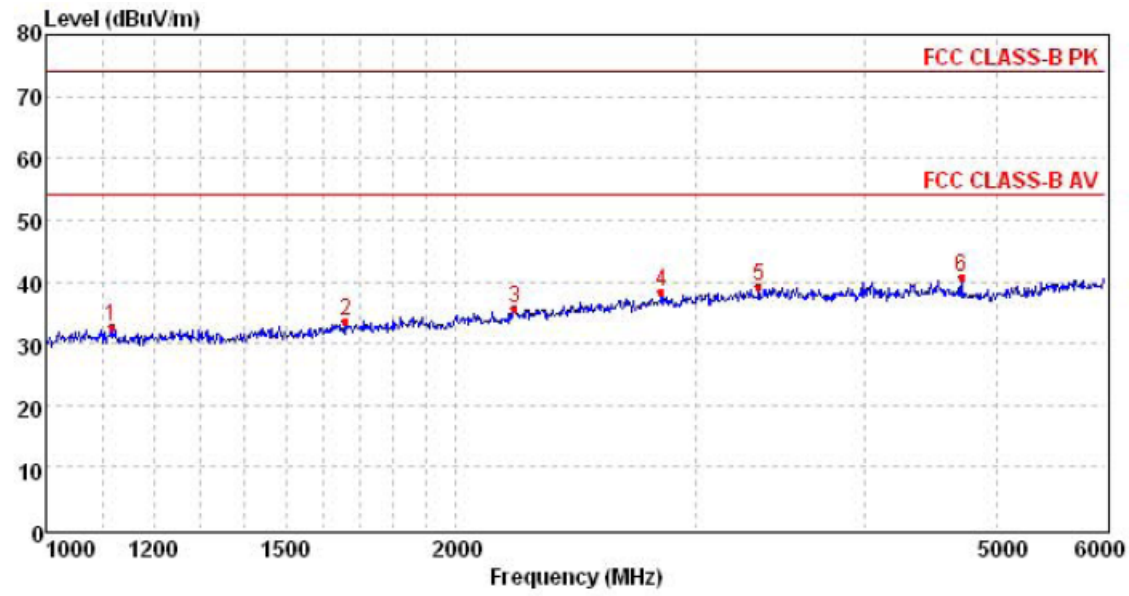

Mark	Frequency MHz	Reading dBuV/m	Antenna dB	Cable dB	Preamp dB	Level dBuV/m	Limit dBuV/m	Over limit	Remark
1	1117.50	40.31	24.34	4.33	36.41	32.57	74.00	-41.43	Peak
2	1660.42	40.00	25.19	5.53	36.98	33.74	74.00	-40.26	Peak
3	2207.71	39.81	26.89	6.52	37.43	35.79	74.00	-38.21	Peak
4	2832.08	40.08	28.31	7.79	37.88	38.30	74.00	-35.70	Peak
5	3339.61	39.97	28.64	8.62	37.99	39.24	74.00	-34.76	Peak
6	4702.43	39.02	31.03	9.13	38.47	40.71	74.00	-33.29	Peak

Op 3

Test Frequency: 156.8MHz Polarity: Horizontal

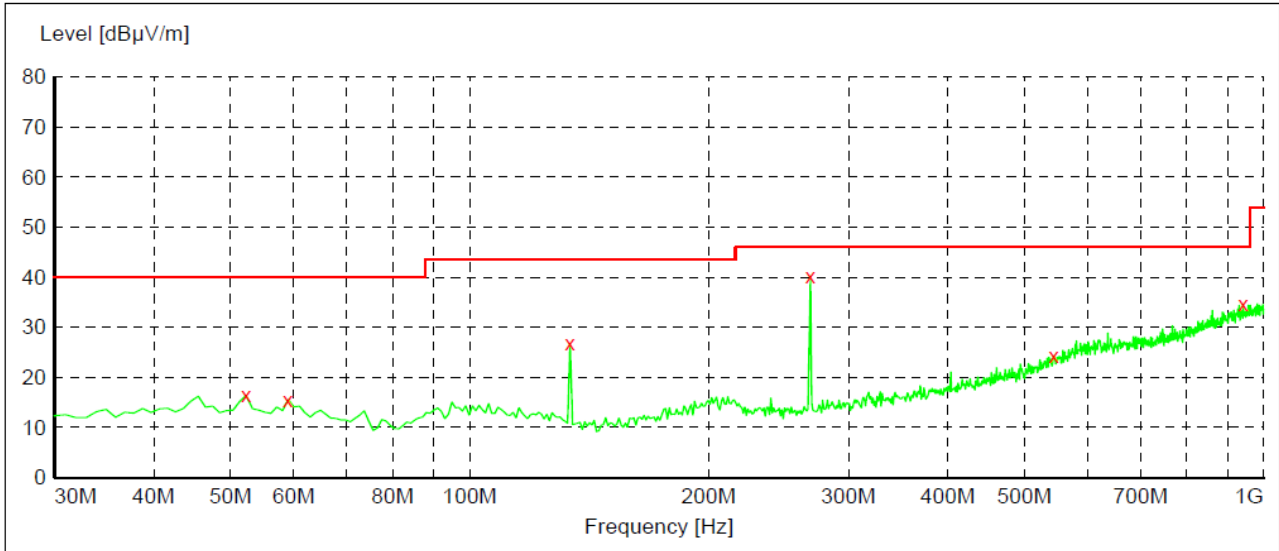

x x x MES GM04276127_red
 — MES GM04276127_pre
 — LIM FCC ClassB F QP/AV FCC ClassB, field strength 3m

Frequency MHz	Level dBµV/m	Transd dB	Limit dBµV/m	Margin dB	Det.	Height cm	Azimuth deg	Polarization
52.310000	16.40	-14.4	40.0	23.6	QP	300.0	33.00	HORIZONTAL
59.100000	15.60	-14.8	40.0	24.4	QP	100.0	222.00	HORIZONTAL
133.790000	26.80	-17.6	43.5	16.7	QP	100.0	36.00	HORIZONTAL
268.620000	40.30	-14.8	46.0	5.7	QP	100.0	241.00	HORIZONTAL
544.100000	24.30	-5.1	46.0	21.7	QP	100.0	342.00	HORIZONTAL
941.800000	34.60	3.5	46.0	11.4	QP	300.0	332.00	HORIZONTAL

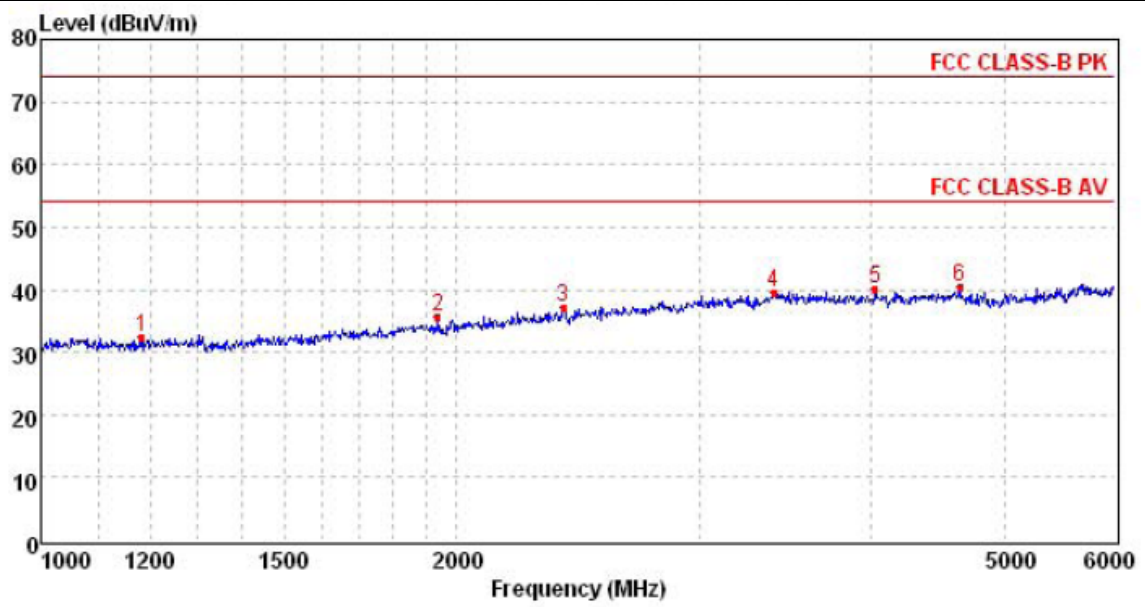

Mark	Frequency MHz	Reading dBuV/m	Antenna dB	Cable dB	Preamp dB	Level dBuV/m	Limit dBuV/m	Over limit	Remark
1	1183.44	40.09	24.41	4.49	36.49	32.50	74.00	-41.50	Peak
2	1940.51	40.96	25.95	6.05	37.20	35.76	74.00	-38.24	Peak
3	2393.09	40.53	27.55	6.81	37.58	37.31	74.00	-36.69	Peak
4	3393.90	40.19	28.66	8.68	37.99	39.54	74.00	-34.46	Peak
5	4023.68	39.94	29.57	8.63	38.01	40.13	74.00	-33.87	Peak
6	4635.51	38.70	30.99	9.08	38.43	40.34	74.00	-33.66	Peak

Op 3

Test Frequency: 156.8MHz Polarity: Vertical

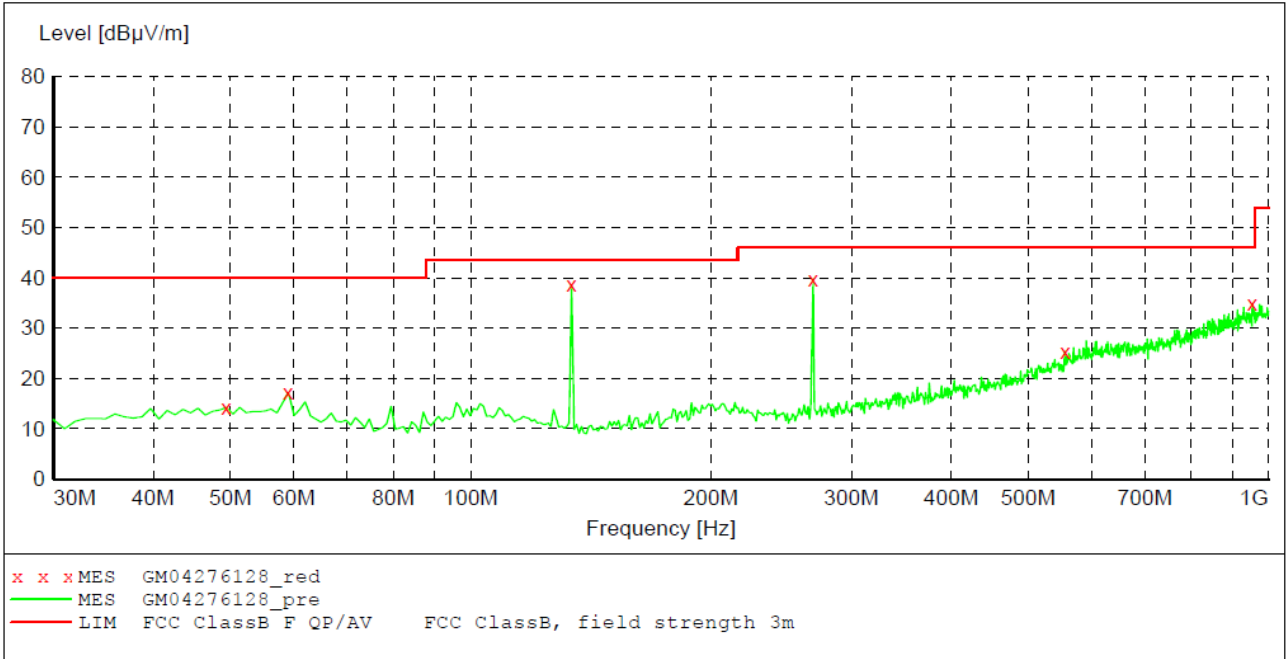

Frequency MHz	Level dBµV/m	Transd dB	Limit dBµV/m	Margin dB	Det.	Height cm	Azimuth deg	Polarization
49.400000	14.20	-14.4	40.0	25.8	QP	100.0	109.00	VERTICAL
59.100000	17.20	-14.8	40.0	22.8	QP	100.0	89.00	VERTICAL
133.790000	38.60	-17.6	43.5	4.9	QP	100.0	29.00	VERTICAL
268.620000	39.80	-14.8	46.0	6.2	QP	100.0	29.00	VERTICAL
555.740000	25.40	-4.6	46.0	20.6	QP	100.0	292.00	VERTICAL
954.410000	34.90	3.8	46.0	11.1	QP	100.0	252.00	VERTICAL

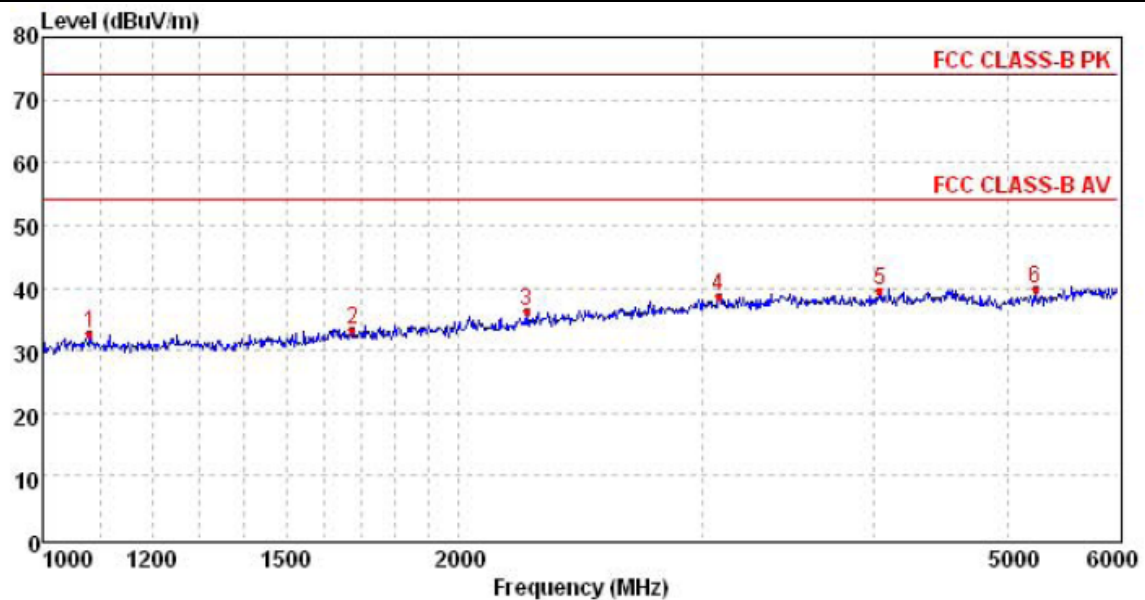

Mark	Frequency MHz	Reading dBuV/m	Antenna dB	Cable dB	Preamp dB	Level dBuV/m	Limit dBuV/m	Over limit	Remark
1	1082.03	40.55	24.30	4.22	36.36	32.71	74.00	-41.29	Peak
2	1675.36	39.61	25.25	5.55	37.00	33.41	74.00	-40.59	Peak
3	2239.59	40.17	27.01	6.57	37.46	36.29	74.00	-37.71	Peak
4	3086.44	39.73	28.54	8.29	37.99	38.57	74.00	-35.43	Peak
5	4038.13	39.36	29.60	8.64	38.02	39.58	74.00	-34.42	Peak
6	5226.77	37.02	31.75	9.48	38.47	39.78	74.00	-34.22	Peak

Op 3

Test Frequency: 157.425MHz Polarity: Horizontal

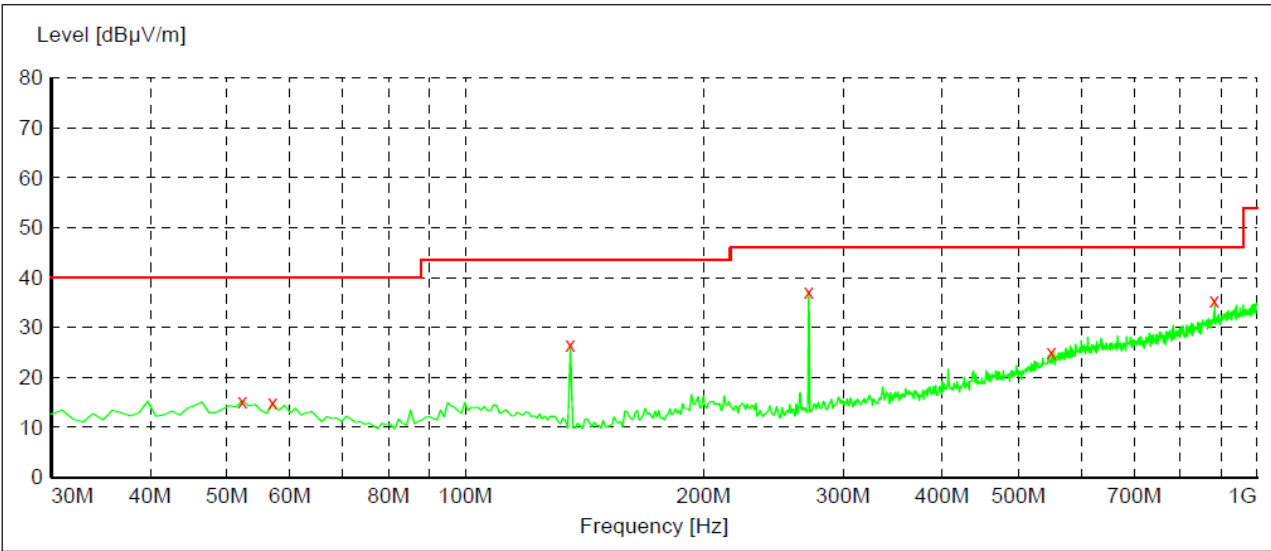

x x x MES GM04276130_red
 — MES GM04276130_pre
 — LIM FCC ClassB F QP/AV FCC ClassB, field strength 3m

Frequency MHz	Level dBµV/m	Transd dB	Limit dBµV/m	Margin dB	Det.	Height cm	Azimuth deg	Polarization
52.310000	15.30	-14.4	40.0	24.7	QP	300.0	0.00	HORIZONTAL
57.160000	15.00	-14.7	40.0	25.0	QP	100.0	94.00	HORIZONTAL
135.730000	26.70	-17.8	43.5	16.8	QP	300.0	27.00	HORIZONTAL
271.530000	37.30	-14.7	46.0	8.7	QP	100.0	134.00	HORIZONTAL
549.920000	25.10	-4.8	46.0	20.9	QP	100.0	114.00	HORIZONTAL
883.600000	35.50	2.3	46.0	10.5	QP	300.0	272.00	HORIZONTAL

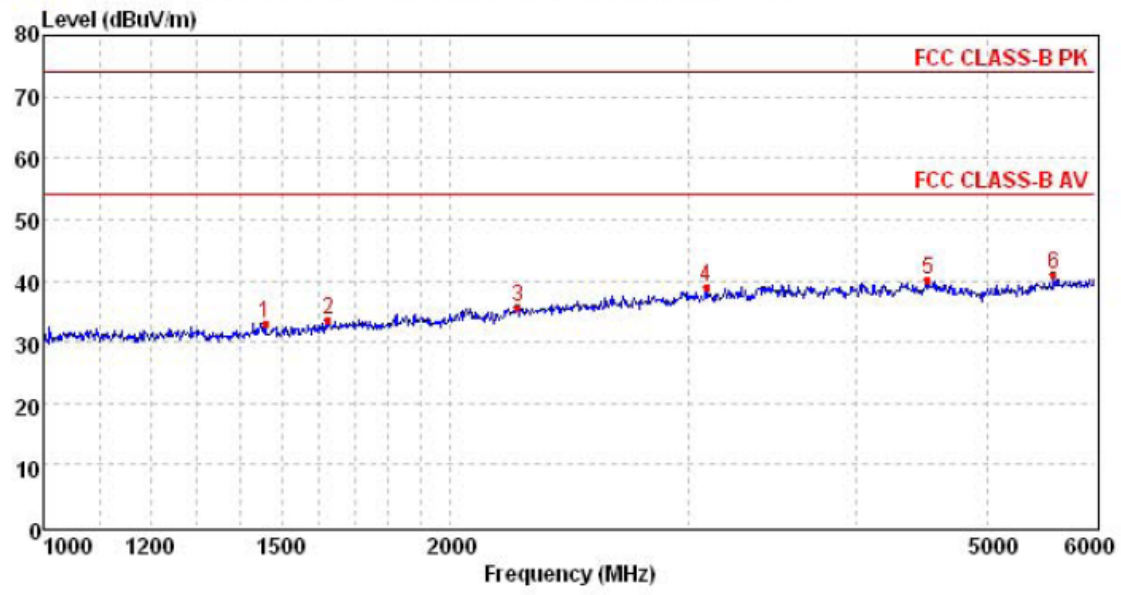

Mark	Frequency MHz	Reading dBuV/m	Antenna dB	Cable dB	Preamp dB	Level dBuV/m	Limit dBuV/m	Over limit	Remark
1	1459.45	40.04	24.67	5.10	36.80	33.01	74.00	-40.99	Peak
2	1625.10	39.96	25.09	5.45	36.95	33.55	74.00	-40.45	Peak
3	2243.60	39.45	27.04	6.58	37.46	35.61	74.00	-38.39	Peak
4	3091.97	40.17	28.54	8.30	37.99	39.02	74.00	-34.98	Peak
5	4512.58	38.47	30.91	8.99	38.34	40.03	74.00	-33.97	Peak
6	5595.04	36.91	32.56	9.65	38.19	40.93	74.00	-33.07	Peak

Op 3

Test Frequency: 157.425MHz Polarity: Vertical

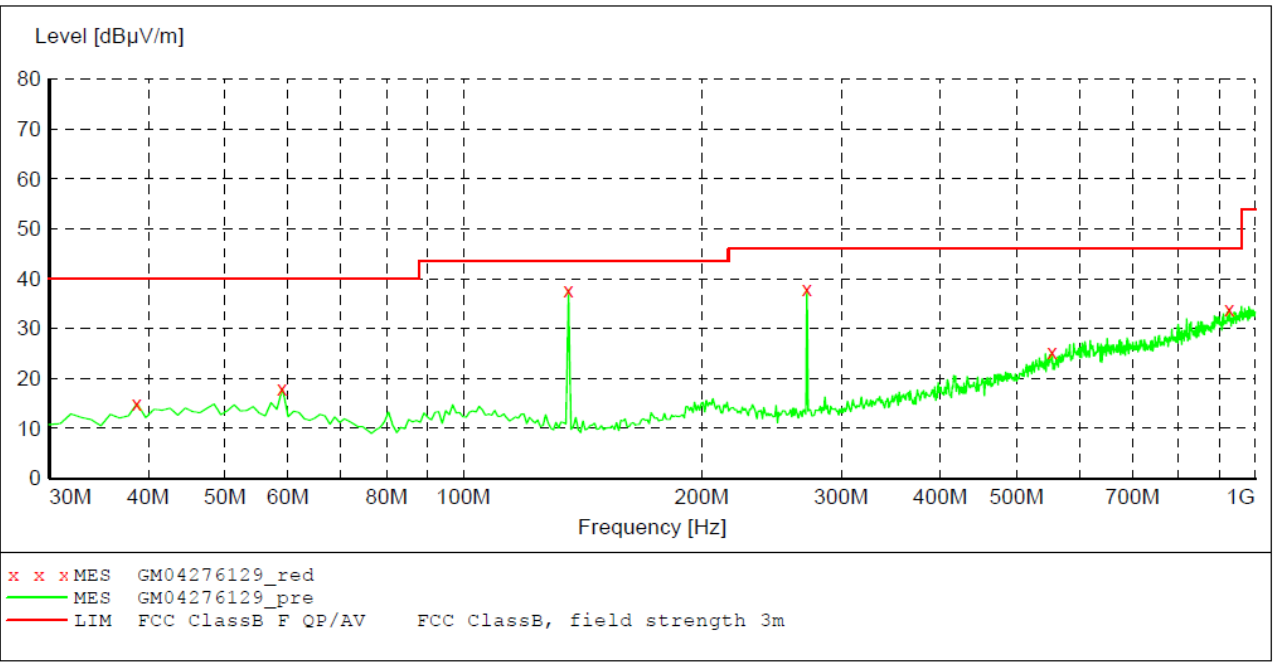

Frequency MHz	Level dBµV/m	Transd dB	Limit dBµV/m	Margin dB	Det.	Height cm	Azimuth deg	Polarization
38.730000	15.00	-15.5	40.0	25.0	QP	100.0	288.00	VERTICAL
59.100000	18.00	-14.8	40.0	22.0	QP	100.0	167.00	VERTICAL
135.730000	37.80	-17.8	43.5	5.7	QP	100.0	47.00	VERTICAL
271.530000	37.90	-14.7	46.0	8.1	QP	100.0	29.00	VERTICAL
553.800000	25.30	-4.7	46.0	20.7	QP	100.0	47.00	VERTICAL
928.220000	33.90	3.3	46.0	12.1	QP	100.0	360.00	VERTICAL

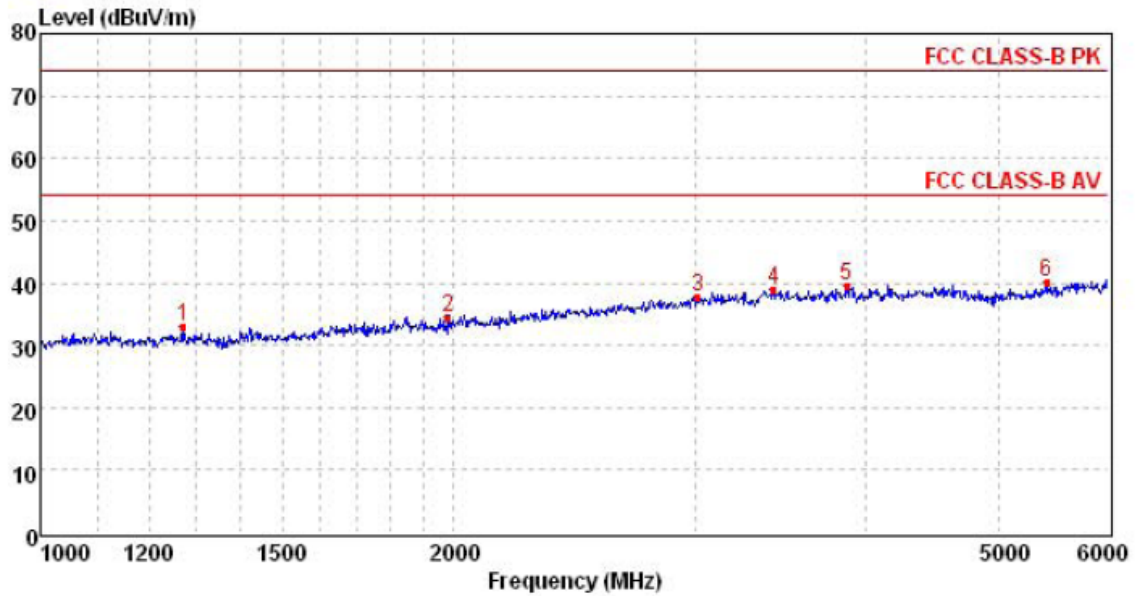

Mark	Frequency MHz	Reading dBuV/m	Antenna dB	Cable dB	Preamp dB	Level dBuV/m	Limit dBuV/m	Over limit	Remark
1	1271.37	40.47	24.50	4.70	36.60	33.07	74.00	-40.93	Peak
2	1982.69	39.66	26.06	6.13	37.24	34.61	74.00	-39.39	Peak
3	3015.37	39.03	28.51	8.20	37.99	37.75	74.00	-36.25	Peak
4	3424.44	39.59	28.67	8.71	37.99	38.98	74.00	-35.02	Peak
5	3868.16	39.64	29.30	8.66	37.99	39.61	74.00	-34.39	Peak
6	5407.77	36.60	32.18	9.57	38.33	40.02	74.00	-33.98	Peak

Op 4

Test Frequency: 1575.42MHz Polarity: Horizontal

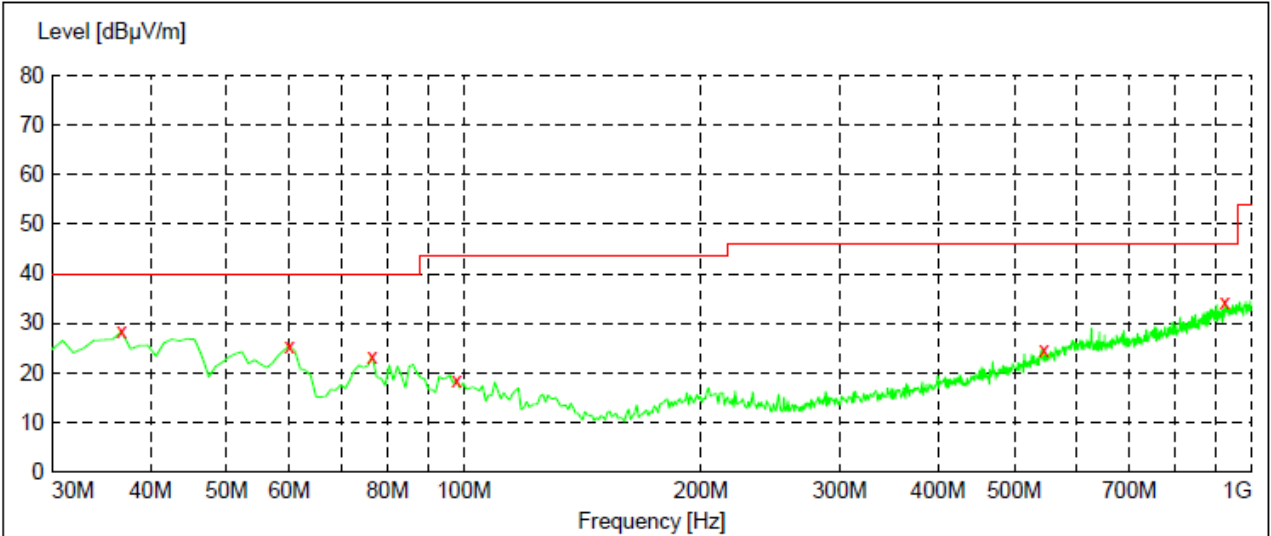

x x x MES GM0401673_red
 — MES GM0401673_pre
 — LIM FCC ClassB F QP/AV FCC ClassB, field strength 3m

Frequency MHz	Level dBµV/m	Transd dB	Limit dBµV/m	Margin dB	Det.	Height cm	Azimuth deg	Polarization
36.790000	28.30	-15.8	40.0	11.7	QP	100.0	175.00	HORIZONTAL
60.070000	25.50	-14.9	40.0	14.5	QP	100.0	0.00	HORIZONTAL
76.560000	23.30	-18.1	40.0	16.7	QP	100.0	356.00	HORIZONTAL
97.900000	18.70	-14.7	43.5	24.8	QP	100.0	299.00	HORIZONTAL
545.070000	24.80	-5.1	46.0	21.2	QP	100.0	314.00	HORIZONTAL
925.310000	34.30	3.2	46.0	11.7	QP	100.0	144.00	HORIZONTAL

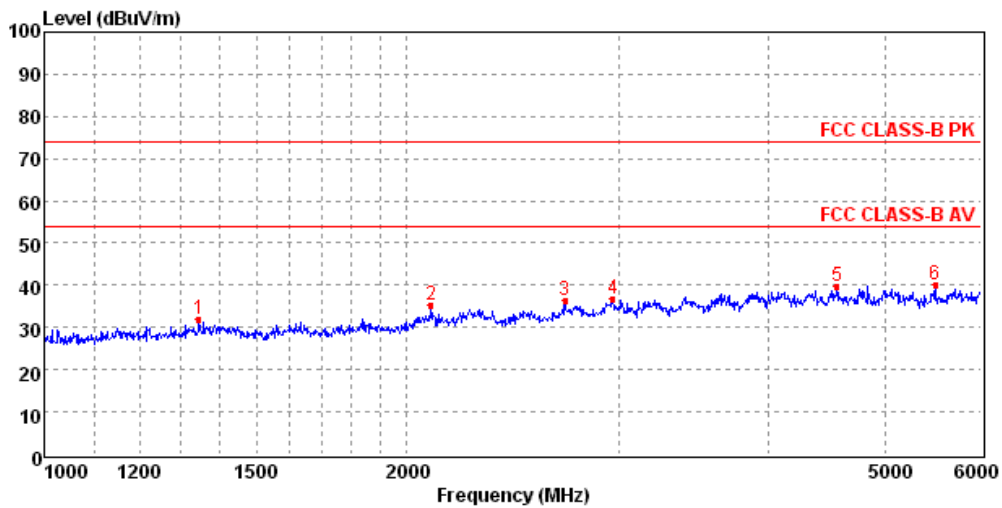

Mark	Frequency MHz	Level dBµV/m	Factor dB	Reading dBµV/m	Limit dBµV/m	Margin dB	Polarization	Det.
1	1343.99	31.91	-8.01	39.92	74.00	42.09	HORIZONTAL	Peak
2	2095.93	35.33	-5.95	41.28	74.00	38.67	HORIZONTAL	Peak
3	2708.02	36.29	-4.28	40.57	74.00	37.71	HORIZONTAL	Peak
4	2967.14	36.86	-3.34	40.20	74.00	37.14	HORIZONTAL	Peak
5	4553.19	39.74	1.26	38.48	74.00	34.26	HORIZONTAL	Peak
6	5495.69	40.18	3.46	36.72	74.00	33.82	HORIZONTAL	Peak

Op 4

Test Frequency: 1575.42MHz Polarity: Vertical

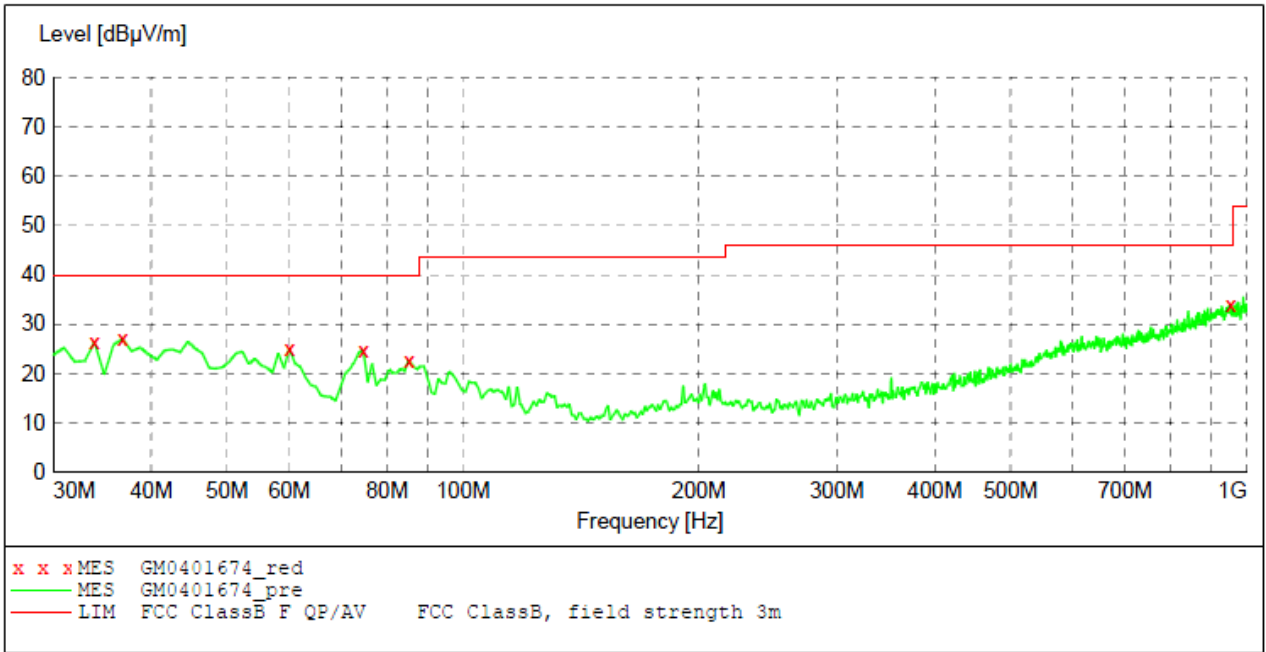

Frequency MHz	Level dBµV/m	Transd dB	Limit dBµV/m	Margin dB	Det.	Height cm	Azimuth deg	Polarization
33.880000	26.40	-16.2	40.0	13.6	QP	100.0	352.00	VERTICAL
36.790000	27.10	-15.8	40.0	12.9	QP	100.0	352.00	VERTICAL
60.070000	25.10	-14.9	40.0	14.9	QP	100.0	22.00	VERTICAL
74.620000	24.80	-17.8	40.0	15.2	QP	100.0	225.00	VERTICAL
85.290000	22.80	-17.3	40.0	17.2	QP	100.0	307.00	VERTICAL
954.410000	33.90	3.8	46.0	12.1	QP	100.0	0.00	VERTICAL

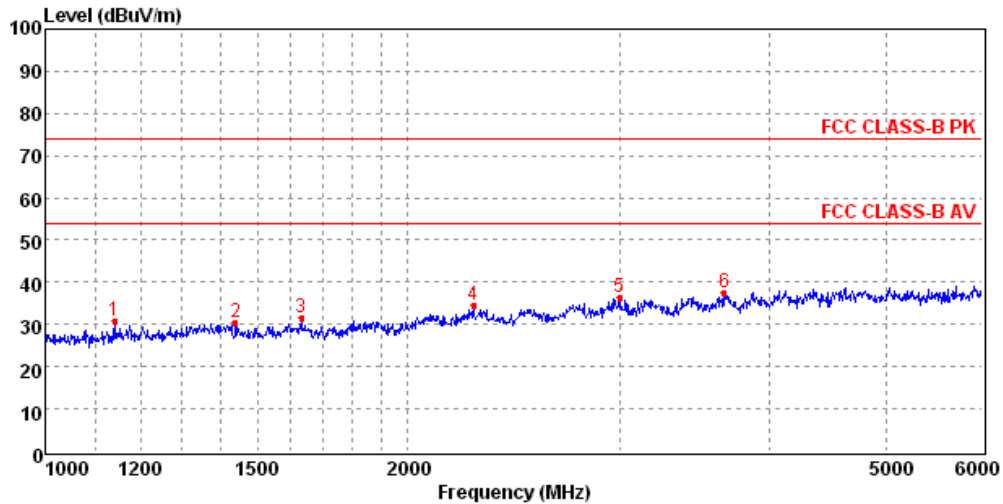

Mark	Frequency MHz	Level dBµV/m	Factor dB	Reading dBµV/m	Limit dBµV/m	Margin dB	Polarization	Det.
1	1141.78	30.77	-9.43	40.20	74.00	43.23	VERTICAL	Peak
2	1438.68	30.54	-8.19	38.73	74.00	43.46	VERTICAL	Peak
3	1630.93	31.44	-8.38	39.82	74.00	42.56	VERTICAL	Peak
4	2267.85	34.58	-4.97	39.55	74.00	39.42	VERTICAL	Peak
5	2999.21	36.50	-3.34	39.84	74.00	37.50	VERTICAL	Peak
6	3665.72	37.42	-1.54	38.96	74.00	36.58	VERTICAL	Peak

4.10. Receiver Conducted Spurious Emssion

TEST APPLICABLE

The same as Section 4.4

TEST PROCEDURE

The RF output of the EUT was connected to a spectrum analyzer through appropriate attenuation. The resolution bandwidth of the spectrum analyzer was set to 100 kHz. Sufficient scans were taken to show any out of band emission up to 10th. Harmonic for the lower and the highest frequency range. Set RBW 100 kHz, VBW 300 kHz in the frequency band 30MHz to 1GHz,while set RBW=1MHz.VBW=3MHz from the 1GHz to 10th Harmonic.

TEST CONFIGURATION

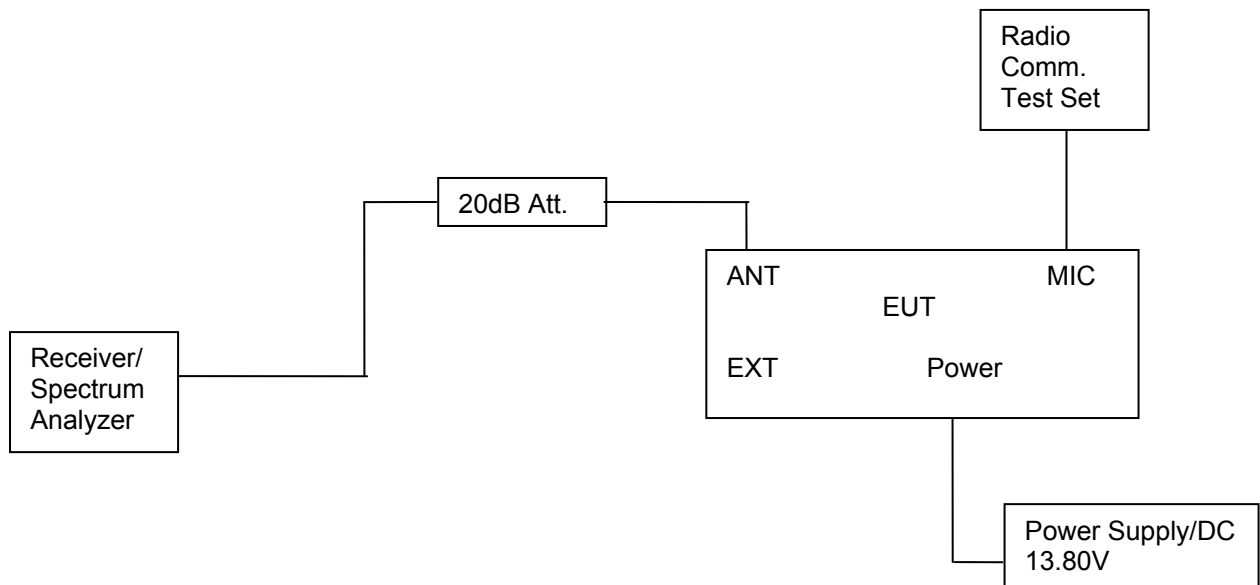

LIMIT

Receiver-spurious emissions at any discrete frequency shall not exceed 2 nW(-57dBm) in the band 30-1000 MHz, nor 5 nW(-53dBm) above 1000 MHz.

TEST RESULTS

Not applicable to this device

5. Test Setup Photos of the EUT

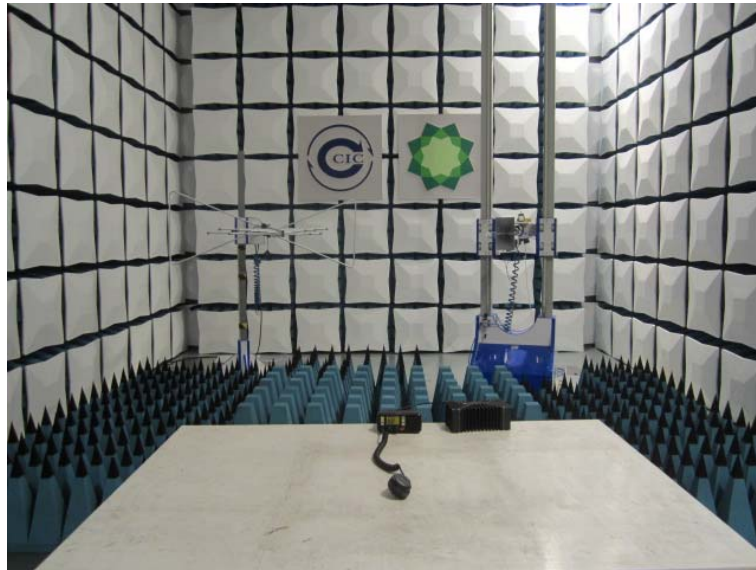

6. External and Internal Photos of the EUT

External Photos of the EUT



Internal Photos of the EUT

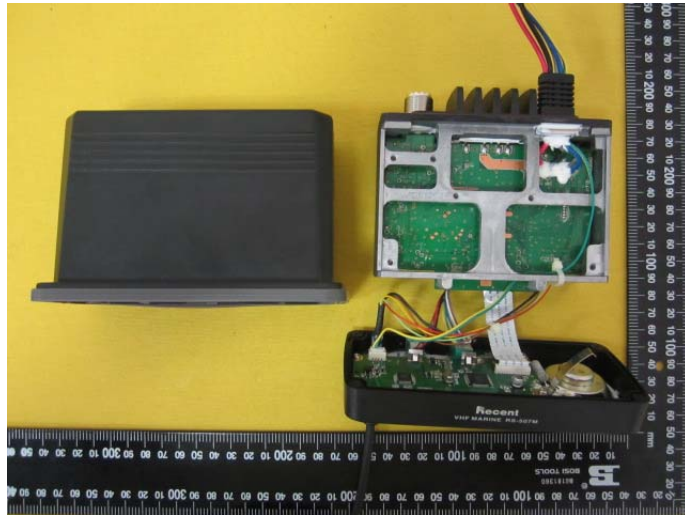

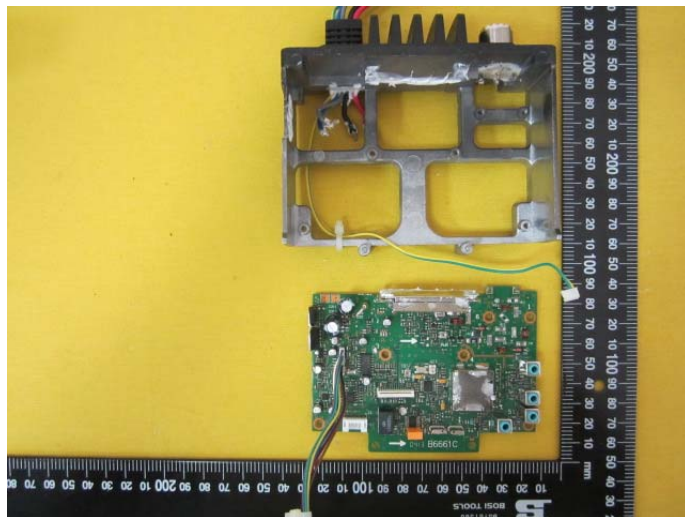
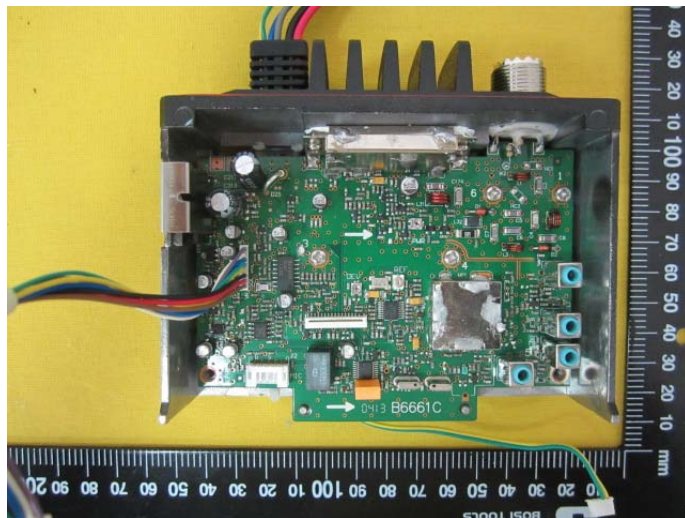
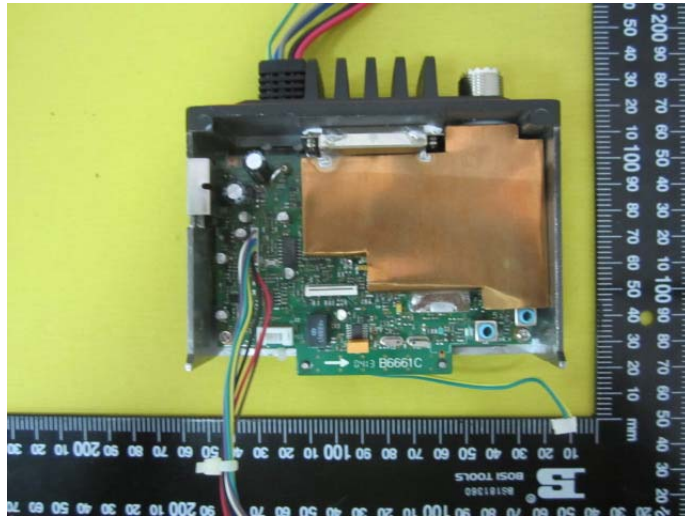

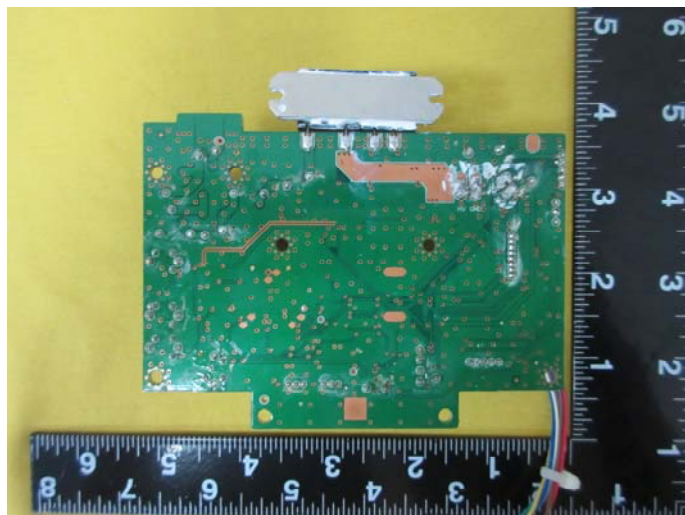
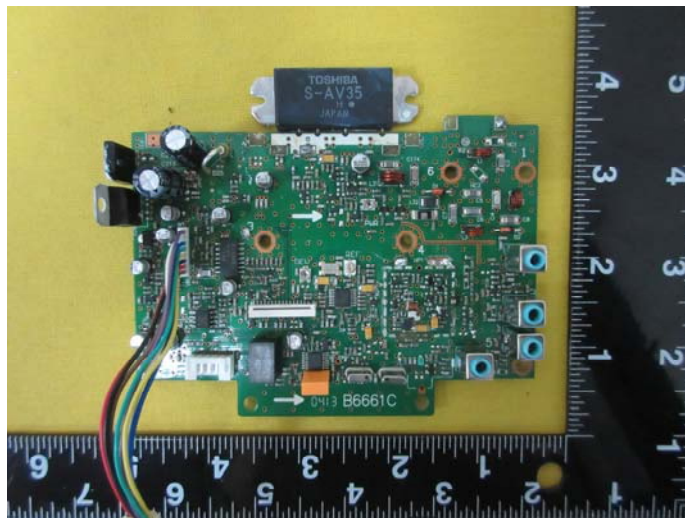
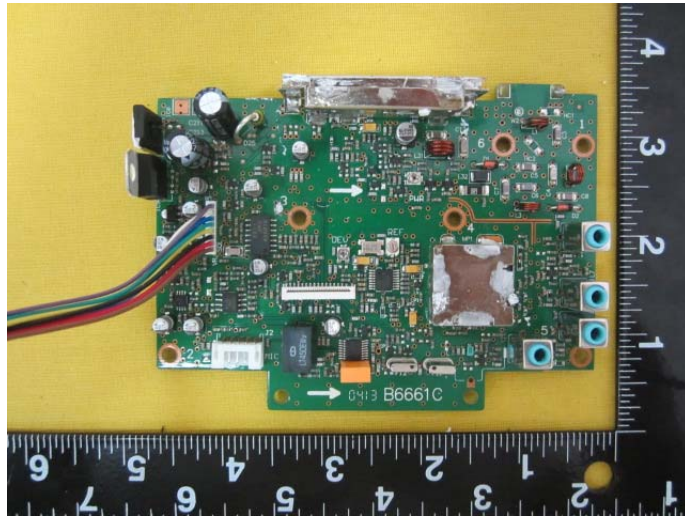

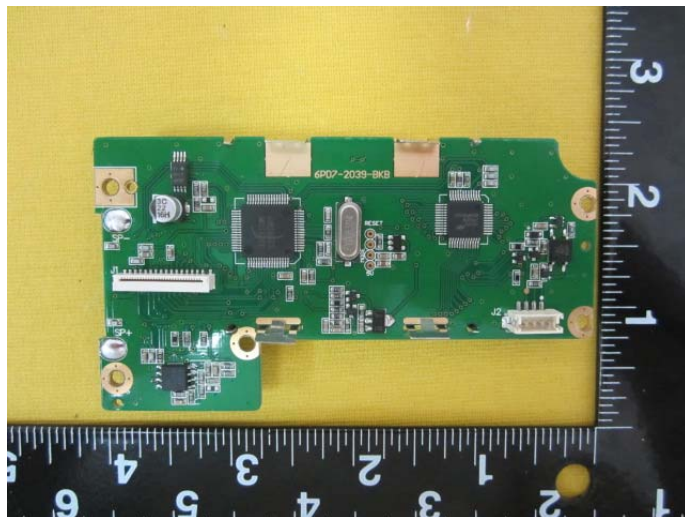
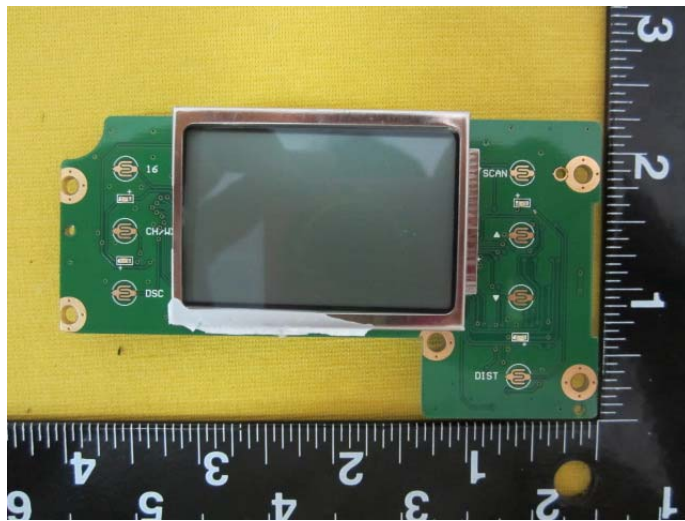
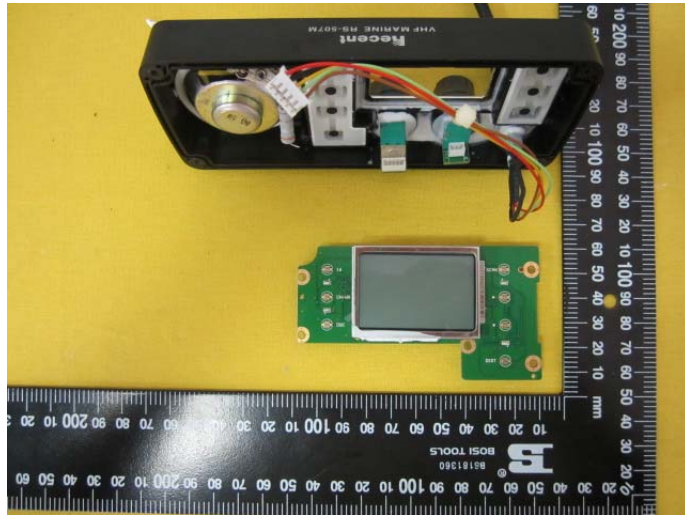

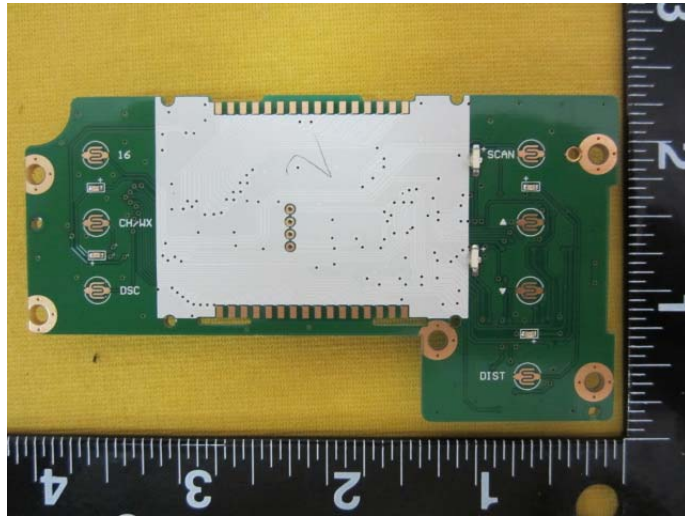

.....End of Report.....