

ELECTROMAGNETIC EMISSIONS COMPLIANCE REPORT**INTENTIONAL RADIATOR CERTIFICATION TO
FCC PART 15 SUBPART C REQUIREMENT**

OF

Product Name: AECO Combo module

Brand Name: N/A

Model Name: AWM-S0021M/H

Model Different: N/A

FCC ID: XVX-AWMS0021MH

Report No.: ER/2009/90014

Issue Date: Nov. 10, 2009

FCC Rule Part: §15.247, DSS

Prepared for: AECO TECHNOLOGY CO., LTD.
2FL., NO. 292. MINSHENG W. RD., DA-TUNG CHIU, TAIPEI CITY, Taiwan

Prepared by: SGS Taiwan Ltd.
Electronics & Communication Laboratory
No. 134, Wu Kung Rd., Wuku Industrial Zone, Taipei County, Taiwan.



Note: This report shall not be reproduced except in full, without the written approval of SGS Taiwan Ltd. This document may be altered or revised by SGS Taiwan Ltd. personnel only, and shall be noted in the revision section of the document.

Unless otherwise stated the results shown in this test report refer only to the sample(s) tested and such sample(s) are retained for 90 days only. This test report cannot be reproduced, except in full, without prior written permission of the Company. 除非另有說明，此報告結果僅對測試之樣品負責，同時此樣品僅保留 90 天。本報告未經本公司書面許可，不可部份複製。 This document is issued by the Company subject to its General Conditions of Service (www.sgs.com/terms_and_conditions.htm) and Terms and Conditions for Electronic Documents (www.sgs.com/terms_e-document.htm). Attention is drawn to the limitations of liability, indemnification and jurisdictional issues established therein. Even if printed this electronic document is to be treated as an original within the meaning of UCP 600 article 20b. The authenticity of this document may be verified at www.sgsonsite.com/authentication. Any holder of this document is advised that information contained hereon reflects the Company's findings at the time of its intervention only and within the limits of client's instructions, if any. The Company's sole responsibility is to its Client and this document does not exonerate parties to a transaction from exercising all their rights and obligations under the transaction documents.

CERTIFICATION OF COMPLIANCE

Applicant: AECO TECHNOLOGY CO., LTD.
2FL., NO. 292. MINSHENG W. RD., DATUNG CHIU, TAIPEI
CITY, Taiwan

Product Name: AECO Combo module

FCC ID: N/A

Brand Name: XVX-AWMS0021MH

Model No.: AWM-S0021M/H

Model Difference: N/A

File Number: ER/2009/90014

Date of test: Sep. 09, 2009 ~ Nov. 05, 2009

Date of EUT Received: Sep. 09, 2009

We hereby certify that:

The above equipment was tested by SGS Taiwan Ltd. The test data, data evaluation, test procedures, and equipment configurations shown in this report were made in accordance with the procedures given in ANSI C63.4 (2003), the energy emitted by the sample EUT tested as described in this report is in compliance with conducted and radiated emission limits of FCC Rules Part 15C:2007, §15.247. The test results of this report relate only to the tested sample identified in this report.

Test By:

Jazz Huang

Date:

Nov. 10, 2009

Jazz Huang / Engineer

Prepared By:

Eva Kao

Date:

Nov. 10, 2009

Eva Kao / Asst. Supervisor

Approved By:

Vincent Su

Date:

Nov. 10, 2009

Vincent Su / Manager

Unless otherwise stated the results shown in this test report refer only to the sample(s) tested and such sample(s) are retained for 90 days only. This test report cannot be reproduced, except in full, without prior written permission of the Company. 除非另有說明，此報告結果僅對測試之樣品負責，同時此樣品僅保留 90 天。本報告未經本公司書面許可，不可部份複製。 This document is issued by the Company subject to its General Conditions of Service (www.sgs.com/terms_and_conditions.htm) and Terms and Conditions for Electronic Documents (www.sgs.com/terms_e-document.htm). Attention is drawn to the limitations of liability, indemnification and jurisdictional issues established therein. Even if printed this electronic document is to be treated as an original within the meaning of UCP 600 article 20b. The authenticity of this document may be verified at www.sgsonsite.com/authentication. Any holder of this document is advised that information contained hereon reflects the Company's findings at the time of its intervention only and within the limits of client's instructions, if any. The Company's sole responsibility is to its Client and this document does not exonerate parties to a transaction from exercising all their rights and obligations under the transaction documents.

Version

Version No.	Date	Description
00	Nov. 10, 2009	Initial creation of document

Unless otherwise stated the results shown in this test report refer only to the sample(s) tested and such sample(s) are retained for 90 days only. This test report cannot be reproduced, except in full, without prior written permission of the Company. 除非另有說明，此報告結果僅對測試之樣品負責，同時此樣品僅保留 90 天。本報告未經本公司書面許可，不可部份複製。 This document is issued by the Company subject to its General Conditions of Service (www.sgs.com/terms_and_conditions.htm) and Terms and Conditions for Electronic Documents (www.sgs.com/terms_e-document.htm). Attention is drawn to the limitations of liability, indemnification and jurisdictional issues established therein. Even if printed this electronic document is to be treated as an original within the meaning of UCP 600 article 20b. The authenticity of this document may be verified at www.sgs.com/site/authentication. Any holder of this document is advised that information contained hereon reflects the Company's findings at the time of its intervention only and within the limits of client's instructions, if any. The Company's sole responsibility is to its Client and this document does not exonerate parties to a transaction from exercising all their rights and obligations under the transaction documents.

Table of Contents

1. GENERAL INFORMATION	7
1.1. Product Description	7
1.2. Related Submittal(s) / Grant (s)	8
1.3. Test Methodology	8
1.4. Test Facility	8
1.5. Special Accessories	8
1.6. Equipment Modifications	8
2. SYSTEM TEST CONFIGURATION	9
2.1. EUT Configuration	9
2.2. EUT Exercise	9
2.3. Test Procedure	9
2.4. Configuration of Tested System	10
3. SUMMARY OF TEST RESULTS	11
4. DESCRIPTION OF TEST MODES	11
5. AC POWER LINE CONDUCTED EMISSION TEST	12
5.1. Standard Applicable:	12
5.2. Measurement Equipment Used:	12
5.3. EUT Setup:	12
5.4. Measurement Procedure:	13
5.5. Measurement Result:	13
6. PEAK OUTPUT POWER MEASUREMENT	16
6.1. Standard Applicable:	16
6.2. Measurement Equipment Used:	16
6.3. Test Set-up:	16
6.4. Measurement Procedure:	16
6.5. Measurement Result:	17
7. 100KHz BANDWIDTH OF BAND EDGES MEASUREMENT	22
7.1. Standard Applicable:	22
7.2. Measurement Equipment Used:	22
7.3. Test SET-UP:	23
7.4. Measurement Procedure:	24
7.5. Field Strength Calculation	24
7.6. Measurement Result:	24

Unless otherwise stated the results shown in this test report refer only to the sample(s) tested and such sample(s) are retained for 90 days only. This test report cannot be reproduced, except in full, without prior written permission of the Company. 除非另有說明，此報告結果僅對測試之樣品負責，同時此樣品僅保留 90 天。本報告未經本公司書面許可，不可部份複製。 This document is issued by the Company subject to its General Conditions of Service (www.sgs.com/terms_and_conditions.htm) and Terms and Conditions for Electronic Documents (www.sgs.com/terms_e-document.htm). Attention is drawn to the limitations of liability, indemnification and jurisdictional issues established therein. Even if printed this electronic document is to be treated as an original within the meaning of UCP 600 article 20b. The authenticity of this document may be verified at www.sgsonsite.com/authentication. Any holder of this document is advised that information contained hereon reflects the Company's findings at the time of its intervention only and within the limits of client's instructions, if any. The Company's sole responsibility is to its Client and this document does not exonerate parties to a transaction from exercising all their rights and obligations under the transaction documents.

8. SPURIOUS EMISSION TEST	29
8.1. Standard Applicable:	29
8.2. Measurement Equipment Used:	29
8.3. Test SET-UP:.....	29
8.4. Measurement Procedure:	29
8.5. Field Strength Calculation	30
8.6. Measurement Result:	30
9. FREQUENCY SEPARATION	43
9.1. Standard Applicable:	43
9.2. Measurement Equipment Used:	43
9.3. Test Set-up:	43
9.4. Measurement Procedure:	43
9.5. Measurement Result:	43
10. NUMBER OF HOPPING FREQUENCY	45
10.1. Standard Applicable:	45
10.2. Measurement Equipment Used:	45
10.3. Test Set-up:	45
10.4. Measurement Procedure:	45
10.5. Measurement Result:	45
11. TIME OF OCCUPANCY (DWELL TIME)	47
11.1. Standard Applicable:	47
11.2. Measurement Equipment Used:	47
11.3. Test Set-up:	47
11.4. Measurement Procedure:	47
11.5. Measurement Result:	48
12. Peak Power Spectral Density	54
12.1. Standard Applicable:	54
12.2. Measurement Equipment Used:	54
12.3. Test Set-up:	54
12.4. Measurement Procedure:	54
12.5. Measurement Result:	54

Unless otherwise stated the results shown in this test report refer only to the sample(s) tested and such sample(s) are retained for 90 days only. This test report cannot be reproduced, except in full, without prior written permission of the Company. 除非另有說明，此報告結果僅對測試之樣品負責，同時此樣品僅保留 90 天。本報告未經本公司書面許可，不可部份複製。 This document is issued by the Company subject to its General Conditions of Service (www.sgs.com/terms_and_conditions.htm) and Terms and Conditions for Electronic Documents (www.sgs.com/terms_e-document.htm). Attention is drawn to the limitations of liability, indemnification and jurisdictional issues established therein. Even if printed this electronic document is to be treated as an original within the meaning of UCP 600 article 20b. The authenticity of this document may be verified at www.sgsonsite.com/authentication. Any holder of this document is advised that information contained hereon reflects the Company's findings at the time of its intervention only and within the limits of client's instructions, if any. The Company's sole responsibility is to its Client and this document does not exonerate parties to a transaction from exercising all their rights and obligations under the transaction documents.

13. 20dB Bandwidth.....57

13.1. Standard Applicable:57

13.2. Measurement Equipment Used:57

13.3. Test Set-up:57

13.4. Measurement Procedure:57

13.5. Measurement Result:58

14. ANTENNA REQUIREMENT63

14.1. Standard Applicable:63

14.2. Antenna Connected Construction:63

Unless otherwise stated the results shown in this test report refer only to the sample(s) tested and such sample(s) are retained for 90 days only. This test report cannot be reproduced, except in full, without prior written permission of the Company. 除非另有說明，此報告結果僅對測試之樣品負責，同時此樣品僅保留 90 天。本報告未經本公司書面許可，不可部份複製。 This document is issued by the Company subject to its General Conditions of Service (www.sgs.com/terms_and_conditions.htm) and Terms and Conditions for Electronic Documents (www.sgs.com/terms_e-document.htm). Attention is drawn to the limitations of liability, indemnification and jurisdictional issues established therein. Even if printed this electronic document is to be treated as an original within the meaning of UCP 600 article 20b. The authenticity of this document may be verified at www.sgs.com/site/authentication. Any holder of this document is advised that information contained hereon reflects the Company's findings at the time of its intervention only and within the limits of client's instructions, if any. The Company's sole responsibility is to its Client and this document does not exonerate parties to a transaction from exercising all their rights and obligations under the transaction documents.

1. GENERAL INFORMATION

1.1. Product Description

General:

Product Name:	AECO Combo module
Brand Name:	N/A
Model Name:	AWM-S0021M/H
Model Difference:	N/A
Power Supply	3.3Vdc

WLAN:

Frequency Range & Channel number:	802.11 b/g: 2412 – 2462 MHz, 11 channels
Rated Power:	802.11 b: 17.09 dBm 802.11 g: 15.15 dBm
Modulation type:	CCK, DQPSK, DBPSK for DSSS 64QAM, 16QAM, QPSK, BPSK for OFDM
Transmission Rate:	802.11 b: 1/2/5.5/11 Mbps; 802.11 g: 6/9/12/18/24/36/48/54 Mbps
Antenna Designation:	PIFA Antenna / 2dBi.

Bluetooth:

Bluetooth Version	V2.0 + EDR (GFSK + π /4DQPSK + 8DPSK)
Frequency Range	2402 – 2480MHz
Channel number	79 channels max.
Rated Power	14.51 dBm (Peak)
Modulation type	Frequency Hopping Spread Spectrum
Antenna Designation	PIFA Antenna / 2dBi.

This report applies for Bluetooth

Unless otherwise stated the results shown in this test report refer only to the sample(s) tested and such sample(s) are retained for 90 days only. This test report cannot be reproduced, except in full, without prior written permission of the Company. 除非另有說明，此報告結果僅對測試之樣品負責，同時此樣品僅保留 90 天。本報告未經本公司書面許可，不可部份複製。 This document is issued by the Company subject to its General Conditions of Service (www.sgs.com/terms_and_conditions.htm) and Terms and Conditions for Electronic Documents (www.sgs.com/terms_e-document.htm). Attention is drawn to the limitations of liability, indemnification and jurisdictional issues established therein. Even if printed this electronic document is to be treated as an original within the meaning of UCP 600 article 20b. The authenticity of this document may be verified at www.sgsonsite.com/authentication. Any holder of this document is advised that information contained hereon reflects the Company's findings at the time of its intervention only and within the limits of client's instructions, if any. The Company's sole responsibility is to its Client and this document does not exonerate parties to a transaction from exercising all their rights and obligations under the transaction documents.

1.2. Related Submittal(s) / Grant (s)

This submittal(s) (test report) is intended for FCC ID: XVX-AWMS0021MH filing to comply with Section 15.247 of the FCC Part 15C, Subpart C Rules.

1.3. Test Methodology

Both conducted and radiated testing were performed according to the procedures in ANSI C63.4 (2003). Radiated testing was performed at an antenna to EUT distance 3 meters.

1.4. Test Facility

The measurement facilities used to collect the 3m Radiated Emission and AC power line conducted data are located on the address of SGS Taiwan Ltd. No. 134, Wu Kung Rd., Wuku Industrial Zone, Taipei Country, Taiwan which are constructed and calibrated to meet the FCC requirements in documents ANSI C63.4: 2003. FCC Registration Number are: 990257 and 236194, Canada Registration Number: 4620A-1.

The 10 m Open Area Test Sites located on the address of SGS Taiwan Ltd. No. 29, Pau-Tou-Tsuo Valley Chia-Pau Tsuen, Linkou Hsiang, Taipei county, which is constructed and calibrated to meet the CISPR 22/EN 55022 requirements. SGS Site No. 1(3 & 10 meters) and FCC Registration Number: 94644.

1.5. Special Accessories

Not available for this EUT intended for grant.

1.6. Equipment Modifications

Not available for this EUT intended for grant.

2. SYSTEM TEST CONFIGURATION

2.1. EUT Configuration

The EUT configuration for testing is installed on RF field strength measurement to meet the Commissions requirement and operating in a manner which intends to maximize its emission characteristics in a continuous normal application.

2.2. EUT Exercise

The EUT (Transmitter) was tested with a test program to fix the Tx/RX frequency that was for the purpose of the measurements. For more information please see test data and APPENDIX 1 for set-up photographs.

2.3. Test Procedure

2.3.1 Conducted Emissions

The EUT is a placed on as turn table which is 0.8 m above ground plane. According to the requirements in Section 7, 13 of ANSI C63.4-2003. Conducted emissions from the EUT measured in the frequency range between 0.15 MHz and 30MHz using CISPR Quasi-Peak and Average detector mode.

2.3.2 Radiated Emissions

The EUT is a placed on as turn table which is 0.8 m above ground plane. The turn table shall rotate 360 degrees to determine the position of maximum emission level. EUT is set 3m away from the receiving antenna which varied from 1m to 4m to find out the highest emission. And also, each emission was to be maximized by changing the polarization of receiving antenna both horizontal and vertical. In order to find out the max. emission, the relative positions of this hand-held transmitter (EUT) was rotated through three orthogonal axes and measurement procedures for electric field radiated emissions above 1 GHz the EUT measurement is to be made “while keeping the antenna in the ‘cone of radiation’ from that area and pointed at the area both in azimuth and elevation, with polarization oriented for maximum response.” is still within the 3dB illumination BW of the measurement antenna. according to the requirements in Section 8 and 13 of ANSI C63.4-2003.

2.4. Configuration of Tested System

Fig. 2-1 Configuration of Tested System (Fixed channel)

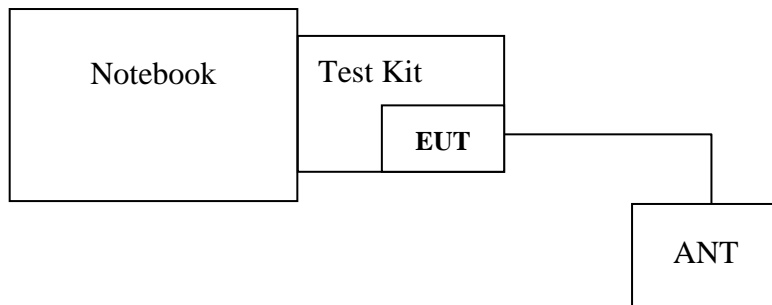

Table 2-1 Equipment Used in Tested System

Item	Equipment	Mfr/Brand	Model/ Type No.	Series No.	Data Cable	Power Cord
1.	Notebook	IBM	T60	L3DK794	Un-Shielding	Un-Shielding
2.	Test Kit	N/A	N/A	N/A	N/A	N/A

3. SUMMARY OF TEST RESULTS

FCC Rules	Description Of Test	Result
§15.207(a)	AC Power line Conducted Emission	Compliant
§15.247(b)(1)	Peak Output Power	Compliant
§15.247(d)	100 KHz Bandwidth Of Frequency Band Edges	Compliant
§15.247(c)	TX Spurious Emission	Compliant
§15.247(a)(1)	Frequency Separation	Compliant
§15.247(a)(1)(iii)	Number of hopping frequency	Compliant
§15.247(a)(1)(ii)	Time of Occupancy	Compliant
§15.247	Peak Power Density	Compliant
§15.247(a)(1)	20dB Bandwidth	No Limit
§15.203, §15.247(c)	Antenna Requirement	Compliant

4. DESCRIPTION OF TEST MODES

The EUT has been tested under operating condition.

Test program used to control the EUT for staying in continuous transmitting and receiving mode is programmed.

Channel low (2402MHz)、mid (2441MHz) and high (2480MHz) with highest data rate are chosen for full testing.

5. AC POWER LINE CONDUCTED EMISSION TEST

5.1. Standard Applicable:

According to §15.207, frequency range within 150KHz to 30MHz shall not exceed the Limit table as below.

Frequency range MHz	Limits dB(uV)	
	Quasi-peak	Average
0.15 to 0.50	66 to 56	56 to 46
0.50 to 5	56	46
5 to 30	60	50

Note

- The lower limit shall apply at the transition frequencies
- The limit decreases linearly with the logarithm of the frequency in the range 0.15 MHz to 0.50 MHz.

5.2. Measurement Equipment Used:

AC Power Line Conducted Emission Test Site					
EQUIPMENT TYPE	MFR	MODEL NUMBER	SERIAL NUMBER	LAST CAL.	CAL DUE.
EMI Test Receiver	R&S	ESCS30	828985/004	09/16/2009	09/15/2010
LISN	Rolf-Heine	NNB-2/16Z	99012	02/02/2009	02/01/2010
LISN	FCC	FCC-LISN-50/250-25-2-01	04034	02/02/2009	02/01/2010
Coaxial Cables	N/A	WK CE Cable	N/A	10/30/2009	10/29/2010

5.3. EUT Setup:

- The conducted emission tests were performed in the test site, using the setup in accordance with the ANSI C63.4-2003.
- The AC/DC Power adaptor of EUT was plug-in LISN. The EUT was placed flushed with the rear of the table.
- The LISN was connected with 120Vac/60Hz power source.

5.4. Measurement Procedure:

1. The EUT was placed on a table which is 0.8m above ground plane.
2. Maximum procedure was performed on the six highest emissions to ensure EUT compliance.
3. Repeat above procedures until all frequency measured were complete.

5.5. Measurement Result:

The initial step in collecting conducted data is a spectrum analyzer peak scan of the measurement range. Significant peaks are then marked as shown on the following data page, and these signals are then quasi-peaked.

Note: Refer to next page for measurement data and plots.

AC POWER LINE CONDUCTED EMISSION TEST DATA

Operation Mode:	Bluetooth Mode	Test Date:	Nov. 05, 2009
		Test By:	Jazz

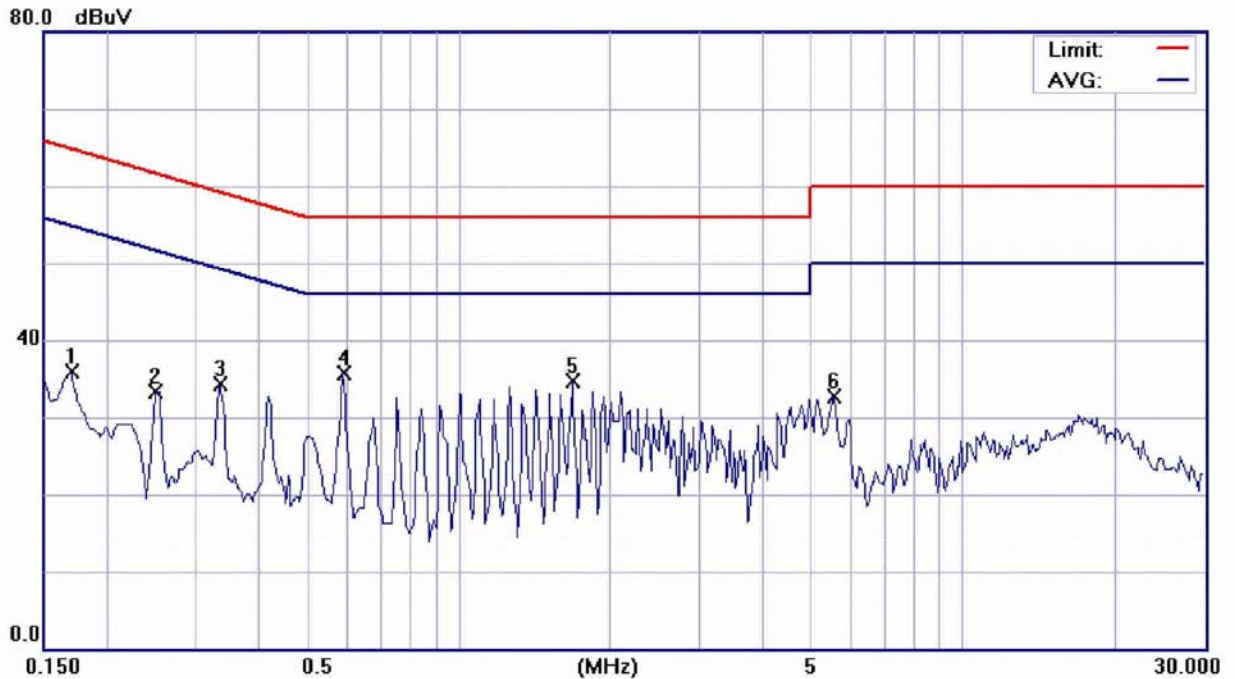

Site	SGS CONDUCTED #1	Phase:	L1	Temperature:	25 °C
Limit:	CISPR22/11/EN55022 Class B	Power:	AC 120V/60Hz	Humidity:	62 %
EUT:	AECO Combo module	Distance:		Air Pressure:	hpa
M/N:	AWM-S0021M/H				
Note:	BT LINK MODE				

No. Mk.	Freq. MHz	Reading Level dBuV	Factor dB	Measurement dBuV	Limit dBuV	Over dB	Detector	Comment
1	0.1700	35.57	0.31	35.88	64.96	-29.08	peak	
2	0.2500	33.17	0.14	33.31	61.76	-28.45	peak	
3	0.3350	34.20	0.11	34.31	59.33	-25.02	peak	
4 *	0.5900	35.70	0.06	35.76	56.00	-20.24	peak	
5	1.6850	34.61	0.04	34.65	56.00	-21.35	peak	
6	5.5600	32.67	0.07	32.74	60.00	-27.26	peak	

Unless otherwise stated the results shown in this test report refer only to the sample(s) tested and such sample(s) are retained for 90 days only. This test report cannot be reproduced, except in full, without prior written permission of the Company. 除非另有說明，此報告結果僅對測試之樣品負責，同時此樣品僅保留 90 天。本報告未經本公司書面許可，不可部份複製。 This document is issued by the Company subject to its General Conditions of Service (www.sgs.com/terms_and_conditions.htm) and Terms and Conditions for Electronic Documents (www.sgs.com/terms_e-document.htm). Attention is drawn to the limitations of liability, indemnification and jurisdictional issues established therein. Even if printed this electronic document is to be treated as an original within the meaning of UCP 600 article 20b. The authenticity of this document may be verified at www.sgsonsite.com/authentication. Any holder of this document is advised that information contained hereon reflects the Company's findings at the time of its intervention only and within the limits of client's instructions, if any. The Company's sole responsibility is to its Client and this document does not exonerate parties to a transaction from exercising all their rights and obligations under the transaction documents.

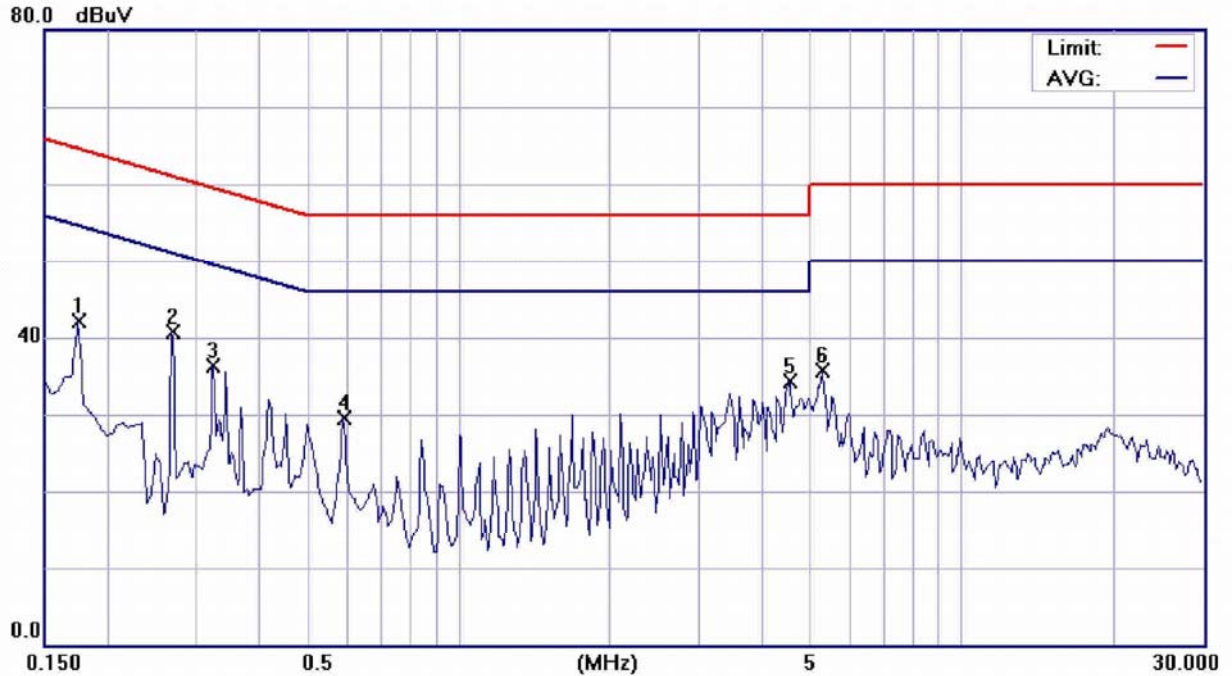

Site SGS CONDUCTED #1

Phase: **N**

Temperature: 25 °C

Limit: CISPR22/11/EN55022 Class B

Power: AC 120V/60Hz

Humidity: 62 %

EUT: AECO Combo module

Distance:

Air Pressure: hpa

M/N: AWM-S0021M/H

Note: BT LINK MODE

No.	Mk.	Freq. MHz	Reading Level dBuV	Factor dB	Measure- ment dBuV	Limit dBuV	Over dB	Detector	Comment
1		0.1750	41.84	0.27	42.11	64.72	-22.61	peak	
2	*	0.2700	40.66	0.12	40.78	61.12	-20.34	peak	
3		0.3250	36.26	0.10	36.36	59.58	-23.22	peak	
4		0.5900	29.51	0.05	29.56	56.00	-26.44	peak	
5		4.5500	34.19	0.05	34.24	56.00	-21.76	peak	
6		5.3000	35.72	0.07	35.79	60.00	-24.21	peak	

Unless otherwise stated the results shown in this test report refer only to the sample(s) tested and such sample(s) are retained for 90 days only. This test report cannot be reproduced, except in full, without prior written permission of the Company. 除非另有說明，此報告結果僅對測試之樣品負責，同時此樣品僅保留 90 天。本報告未經本公司書面許可，不可部份複製。 This document is issued by the Company subject to its General Conditions of Service (www.sgs.com/terms_and_conditions.htm) and Terms and Conditions for Electronic Documents (www.sgs.com/terms_e-document.htm). Attention is drawn to the limitations of liability, indemnification and jurisdictional issues established therein. Even if printed this electronic document is to be treated as an original within the meaning of UCP 600 article 20b. The authenticity of this document may be verified at www.sgsonsite.com/authentication. Any holder of this document is advised that information contained hereon reflects the Company's findings at the time of its intervention only and within the limits of client's instructions, if any. The Company's sole responsibility is to its Client and this document does not exonerate parties to a transaction from exercising all their rights and obligations under the transaction documents.

6. PEAK OUTPUT POWER MEASUREMENT

6.1. Standard Applicable:

According to §15.247(b)(1), For frequency hopping systems operating in the 2400-2483.5 MHz band employing at least 75 hopping channels, and all frequency hopping systems in the 5725-5850MHz band: 1Watt. For all other frequency hopping systems in the 2400 – 2483.5MHz band: 0.125 Watts.

6.2. Measurement Equipment Used:

Conducted Emission Test Site					
EQUIPMENT TYPE	MFR	MODEL NUMBER	SERIAL NUMBER	LAST CAL.	CAL DUE.
Spectrum Analyzer	Agilent	E4446A	MY43360126	04/19/2008	04/18/2010
Spectrum Analyzer	Agilent	E4440A	MY45304525	01/23/2008	01/22/2010
DC Block	Agilent	BLK-18	155452	07/05/2009	07/04/2010
Low Loss Cable	HUBER+SUHNER	SUCOFLEX 104PEA	N/A	01/05/2009	01/04/2010
Attenuator	Mini-Circuit	BW-S6W5	001	07/05/2009	07/04/2010
Attenuator	Mini-Circuit	BW-S10W5	001	07/05/2009	07/04/2010
Attenuator	Mini-Circuit	BW-S20W5	001	07/05/2009	07/04/2010
Splitter	Agilent	11636B	N/A	07/05/2009	07/04/2010

6.3. Test Set-up:

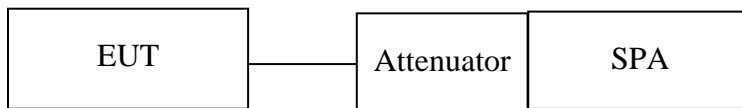

6.4. Measurement Procedure:

1. Place the EUT on the table and set it in transmitting mode.
2. Remove the antenna from the EUT and then connect a low loss RF cable from the antenna port to the power meter or spectrum. (Channel power function, BDR model: RBW = 1MHz, VBW = 3MHz / EDR model: RBW = 1.5MHz, VBW = 5MHz)
3. Record the max. reading.
4. Repeat above procedures until all frequency measured were complete.

Unless otherwise stated the results shown in this test report refer only to the sample(s) tested and such sample(s) are retained for 90 days only. This test report cannot be reproduced, except in full, without prior written permission of the Company. 除非另有說明，此報告結果僅對測試之樣品負責，同時此樣品僅保留 90 天。本報告未經本公司書面許可，不可部份複製。 This document is issued by the Company subject to its General Conditions of Service (www.sgs.com/terms_and_conditions.htm) and Terms and Conditions for Electronic Documents (www.sgs.com/terms_e-document.htm). Attention is drawn to the limitations of liability, indemnification and jurisdictional issues established therein. Even if printed this electronic document is to be treated as an original within the meaning of UCP 600 article 20b. The authenticity of this document may be verified at www.sgs.com/authentication. Any holder of this document is advised that information contained hereon reflects the Company's findings at the time of its intervention only and within the limits of client's instructions, if any. The Company's sole responsibility is to its Client and this document does not exonerate parties to a transaction from exercising all their rights and obligations under the transaction documents.

6.5. Measurement Result:

BDR Mode

Frequency (MHz)	Reading Power (dBm)	Cable Loss	Output Power (dBm)	Output Power (W)	Limit (W)
2402.00	14.51	0.00	14.51	0.02825	1
2441.00	14.41	0.00	14.41	0.02761	1
2480.00	14.28	0.00	14.28	0.02679	1

EDR Mode

Frequency (MHz)	Reading Power (dBm)	Cable Loss	Output Power (dBm)	Output Power (W)	Limit (W)
2402.00	14.46	0.00	14.46	0.02793	1
2441.00	14.34	0.00	14.34	0.02716	1
2480.00	14.20	0.00	14.20	0.02630	1

offset: 0.2dB

Note: Refer to next page for plots.

Peak Power Output Data Plot (CH Low) (BDR mode)

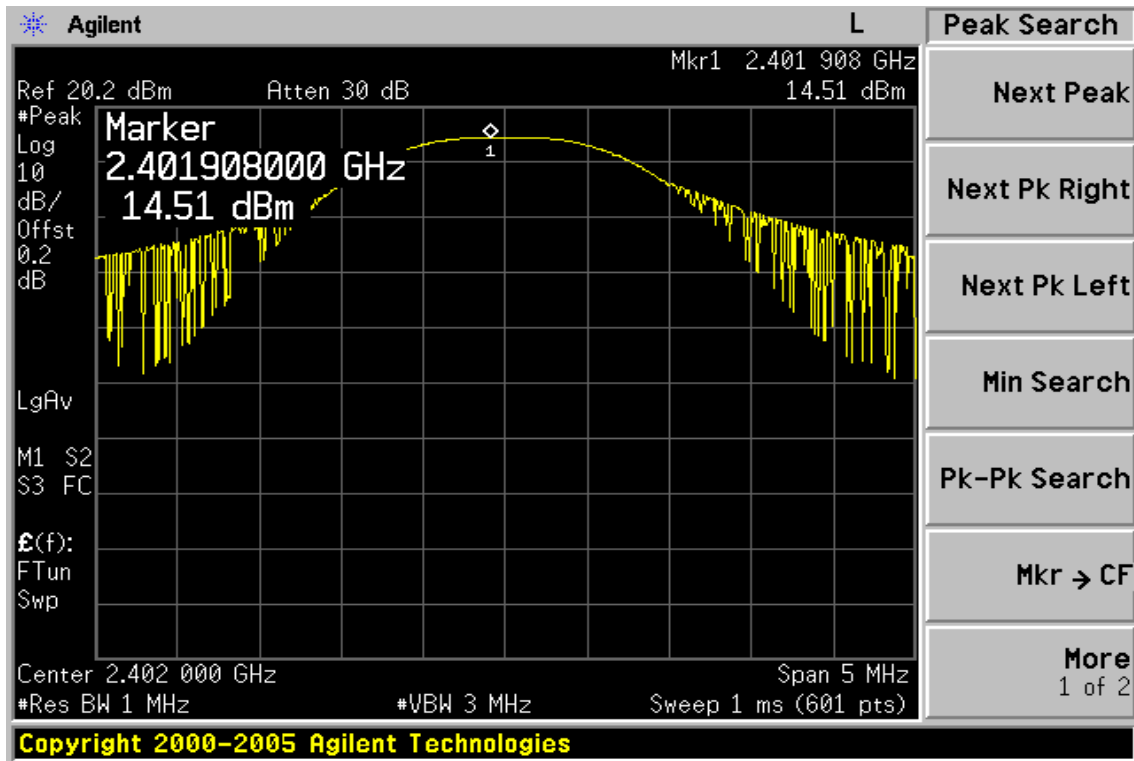

Peak Power Output Data Plot (CH Mid) (BDR mode)

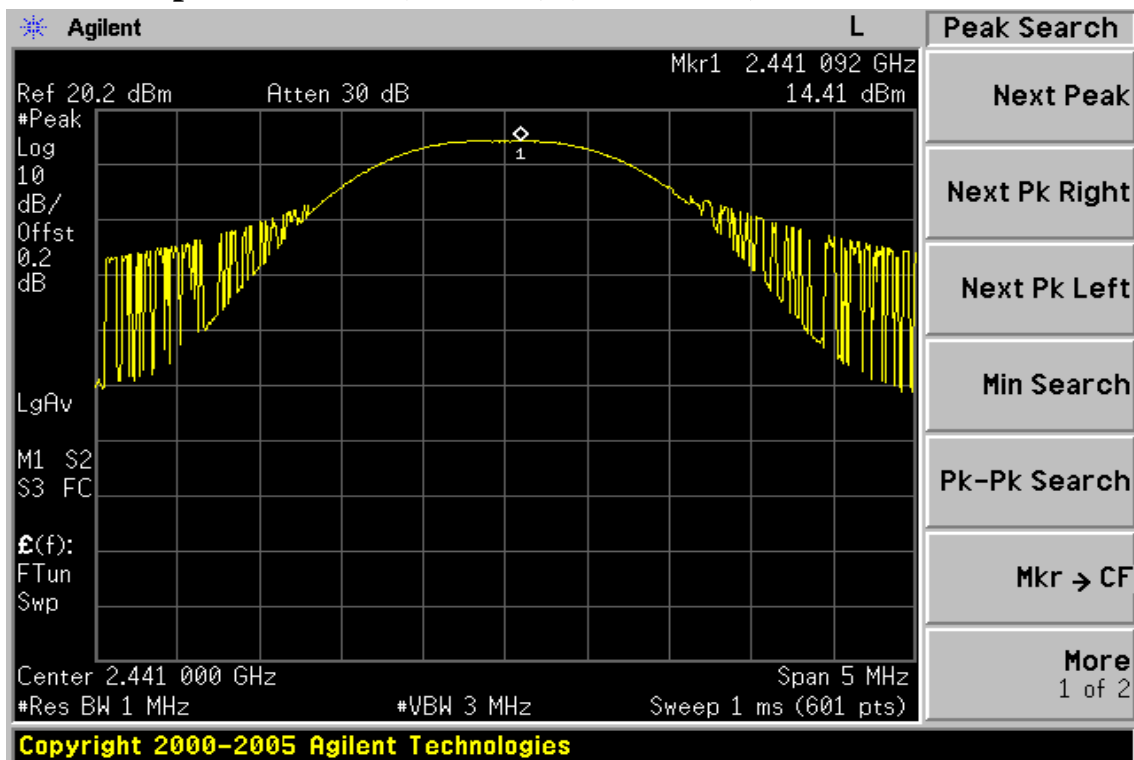

Unless otherwise stated the results shown in this test report refer only to the sample(s) tested and such sample(s) are retained for 90 days only. This test report cannot be reproduced, except in full, without prior written permission of the Company. 除非另有說明，此報告結果僅對測試之樣品負責，同時此樣品僅保留 90 天。本報告未經本公司書面許可，不可部份複製。 This document is issued by the Company subject to its General Conditions of Service (www.sgs.com/terms_and_conditions.htm) and Terms and Conditions for Electronic Documents (www.sgs.com/terms_e-document.htm). Attention is drawn to the limitations of liability, indemnification and jurisdictional issues established therein. Even if printed this electronic document is to be treated as an original within the meaning of UCP 600 article 20b. The authenticity of this document may be verified at www.sgs.com/authentication. Any holder of this document is advised that information contained hereon reflects the Company's findings at the time of its intervention only and within the limits of client's instructions, if any. The Company's sole responsibility is to its Client and this document does not exonerate parties to a transaction from exercising all their rights and obligations under the transaction documents.

Peak Power Output Data Plot (CH High) (BDR mode)

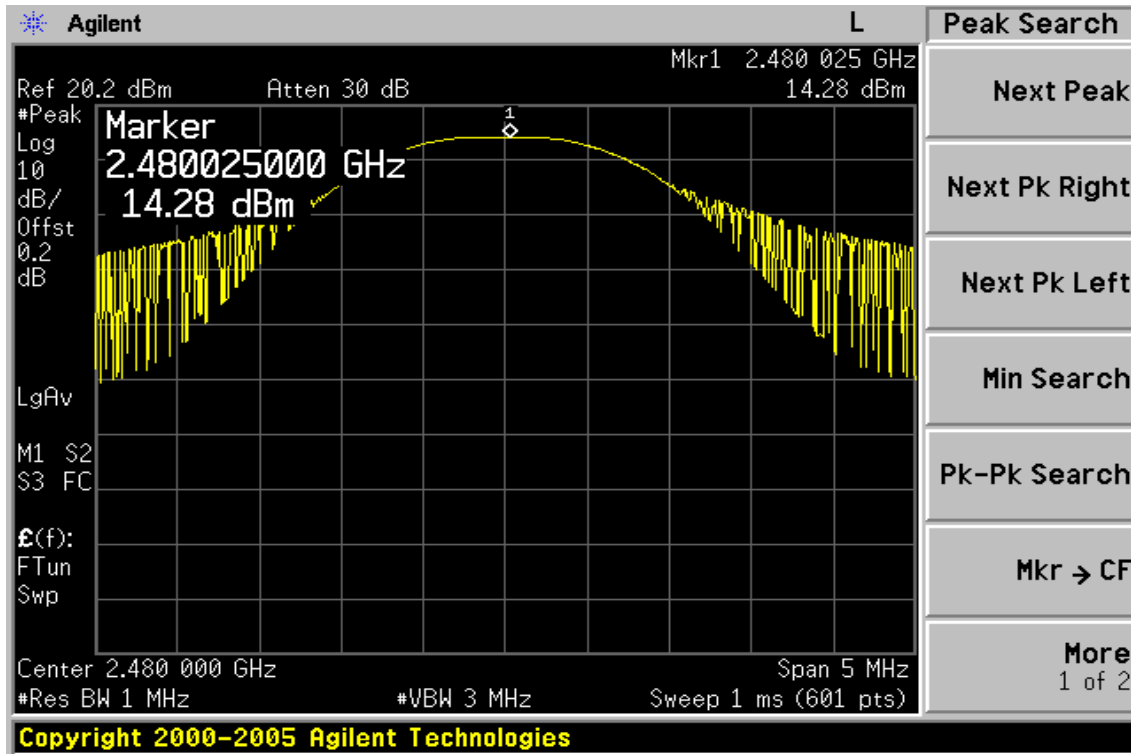

Unless otherwise stated the results shown in this test report refer only to the sample(s) tested and such sample(s) are retained for 90 days only. This test report cannot be reproduced, except in full, without prior written permission of the Company. 除非另有說明，此報告結果僅對測試之樣品負責，同時此樣品僅保留 90 天。本報告未經本公司書面許可，不可部份複製。 This document is issued by the Company subject to its General Conditions of Service (www.sgs.com/terms_and_conditions.htm) and Terms and Conditions for Electronic Documents (www.sgs.com/terms_e-document.htm). Attention is drawn to the limitations of liability, indemnification and jurisdictional issues established therein. Even if printed this electronic document is to be treated as an original within the meaning of UCP 600 article 20b. The authenticity of this document may be verified at www.sgs.com/authentication. Any holder of this document is advised that information contained hereon reflects the Company's findings at the time of its intervention only and within the limits of client's instructions, if any. The Company's sole responsibility is to its Client and this document does not exonerate parties to a transaction from exercising all their rights and obligations under the transaction documents.

Peak Power Output Data Plot (CH Low) (EDR mode)

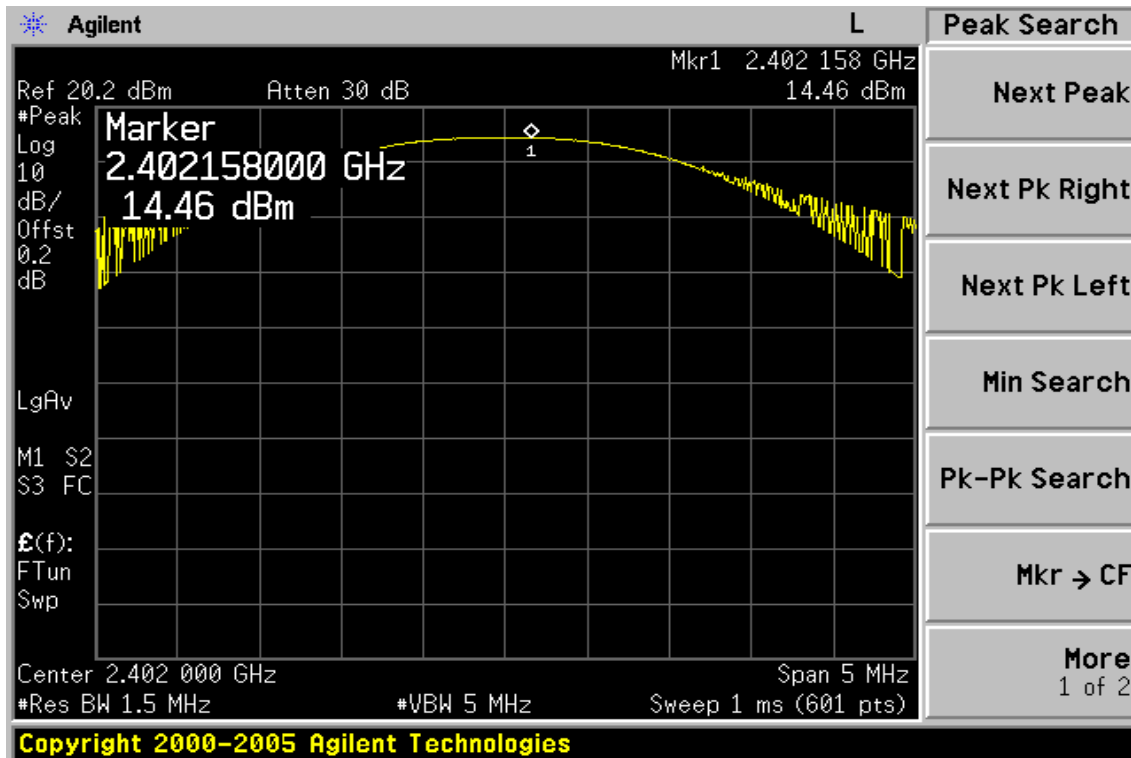

Peak Power Output Data Plot (CH Mid) (EDR mode)

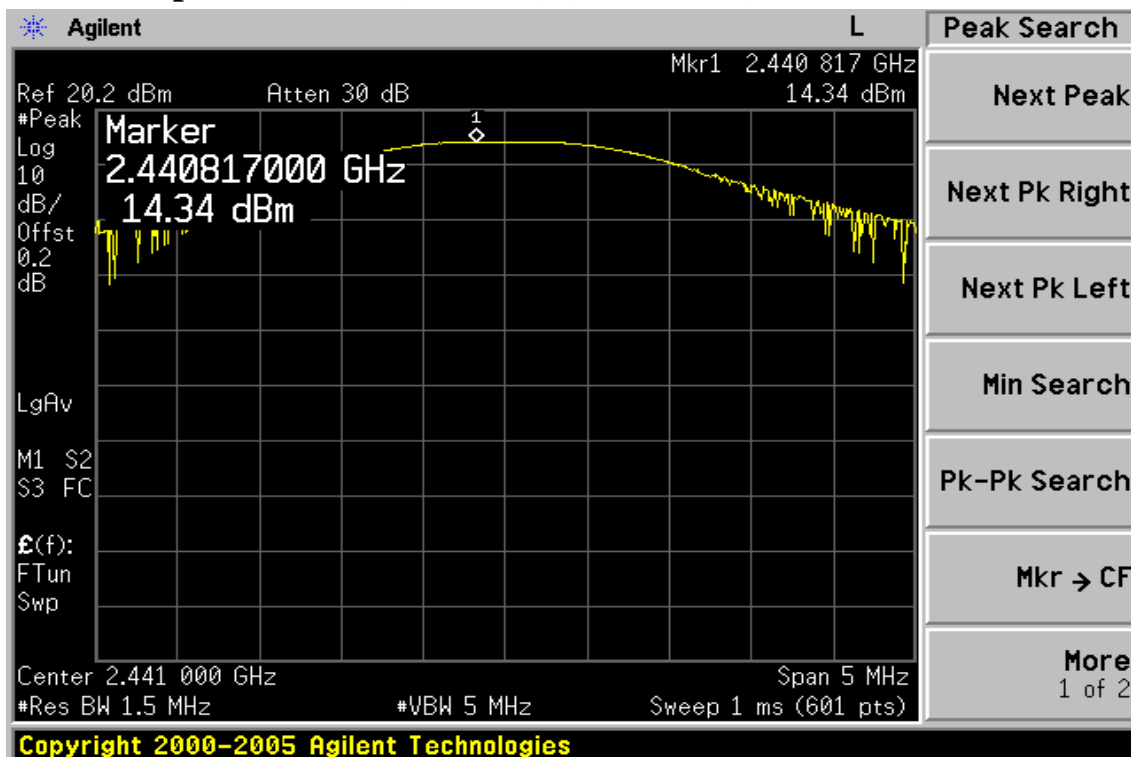

Unless otherwise stated the results shown in this test report refer only to the sample(s) tested and such sample(s) are retained for 90 days only. This test report cannot be reproduced, except in full, without prior written permission of the Company. 除非另有說明，此報告結果僅對測試之樣品負責，同時此樣品僅保留 90 天。本報告未經本公司書面許可，不可部份複製。 This document is issued by the Company subject to its General Conditions of Service (www.sgs.com/terms_and_conditions.htm) and Terms and Conditions for Electronic Documents (www.sgs.com/terms_e-document.htm). Attention is drawn to the limitations of liability, indemnification and jurisdictional issues established therein. Even if printed this electronic document is to be treated as an original within the meaning of UCP 600 article 20b. The authenticity of this document may be verified at www.sgs.com/authentication. Any holder of this document is advised that information contained hereon reflects the Company's findings at the time of its intervention only and within the limits of client's instructions, if any. The Company's sole responsibility is to its Client and this document does not exonerate parties to a transaction from exercising all their rights and obligations under the transaction documents.

Peak Power Output Data Plot (CH High) (EDR mode)

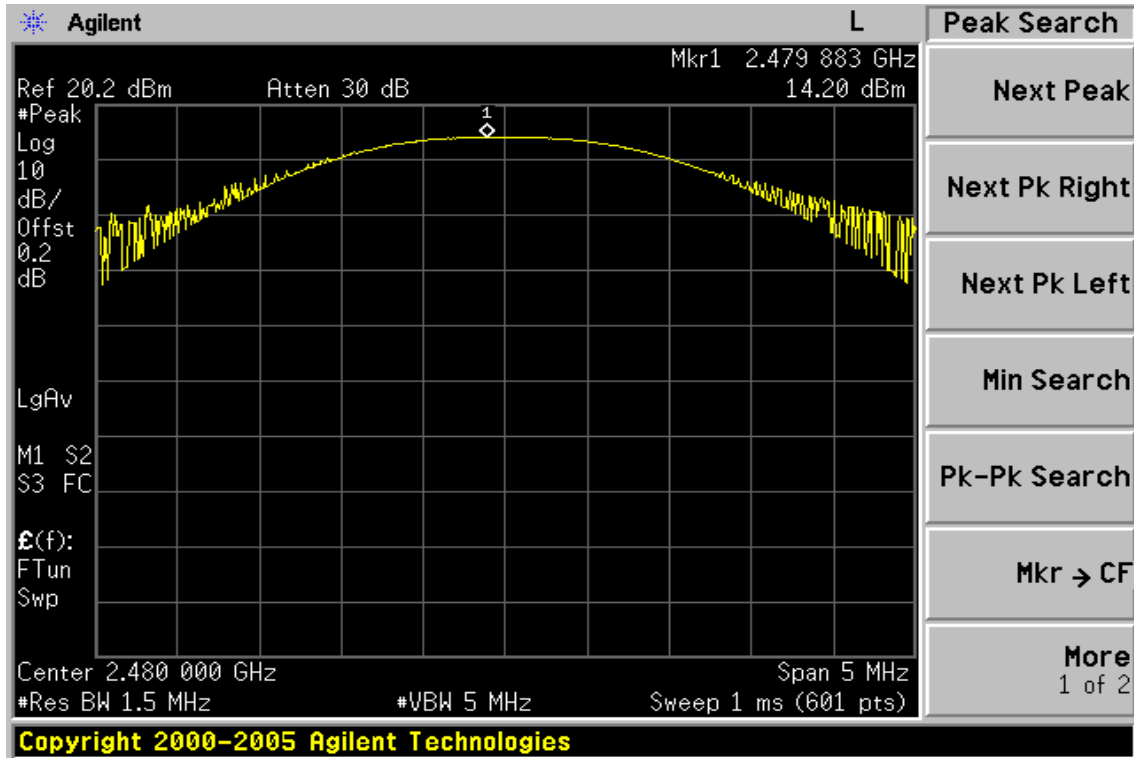

Unless otherwise stated the results shown in this test report refer only to the sample(s) tested and such sample(s) are retained for 90 days only. This test report cannot be reproduced, except in full, without prior written permission of the Company. 除非另有說明，此報告結果僅對測試之樣品負責，同時此樣品僅保留 90 天。本報告未經本公司書面許可，不可部份複製。 This document is issued by the Company subject to its General Conditions of Service (www.sgs.com/terms_and_conditions.htm) and Terms and Conditions for Electronic Documents (www.sgs.com/terms_e-document.htm). Attention is drawn to the limitations of liability, indemnification and jurisdictional issues established therein. Even if printed this electronic document is to be treated as an original within the meaning of UCP 600 article 20b. The authenticity of this document may be verified at www.sgs.com/site/authentication. Any holder of this document is advised that information contained hereon reflects the Company's findings at the time of its intervention only and within the limits of client's instructions, if any. The Company's sole responsibility is to its Client and this document does not exonerate parties to a transaction from exercising all their rights and obligations under the transaction documents.

7. 100KHz BANDWIDTH OF BAND EDGES MEASUREMENT

7.1. Standard Applicable:

According to §15.247(d), in any 100 KHz bandwidth outside the frequency bands in which the spread spectrum intentional radiator is operating, the radio frequency power that is produced by the intentional radiator shall be at least 20dB below that in the 100KHz bandwidth within the band that contains the highest level of the desired power, In addition, radiated emissions which fall in the restricted bands, as defined in §15.205(a), must also comply with the radiated emission limits specified in 15.209(a).

7.2. Measurement Equipment Used:

7.2.1. Conducted Emission at antenna port:

Refer to section 6.2 for details.

7.2.2. Radiated emission:

966 Chamber					
EQUIPMENT TYPE	MFR	MODEL NUMBER	SERIAL NUMBER	LAST CAL.	CAL DUE.
Spectrum Analyzer	R&S	FSP 40	100034	02/12/2009	02/11/2010
Loop antenna	MESSTEC	FLA30	03/10086	07/08/2009	07/07/2011
Bilog Antenna	SCHWAZBECK	VULB9160	9160-3136	11/15/2008	11/14/2009
Horn antenna	SCHWAZBECK	BBHA 9120D	9120D-673	05/09/2008	05/08/2010
Pre-Amplifier	Agilent	8447D	1937A02834	11/30/2008	11/29/2009
Pre-Amplifier	Agilent	8449B	3008A01973	01/05/2009	01/04/2010
Turn Table	HD	DT420	N/A	N.C.R	N.C.R
Antenna Tower	HD	MA240-N	240/657	N.C.R	N.C.R
Controller	HD	HD100	N/A	N.C.R	N.C.R
Low Loss Cable	HUBER+SUHNER	SUCOFLEX 104PEA-10M	10m	01/05/2009	01/04/2010
Low Loss Cable	HUBER+SUHNER	SUCOFLEX 104PEA-3M	3m	01/05/2009	01/04/2010
3m Site	SGS	966 chamber	N/A	11/08/2008	11/09/2009

7.3. Test SET-UP:

7.3.1. Conducted Emission at antenna port:

Refer to section 6.3 for details.

7.3.2. Radiated emission:

(A) Radiated Emission Test Set-Up, Frequency Below 1000MHz

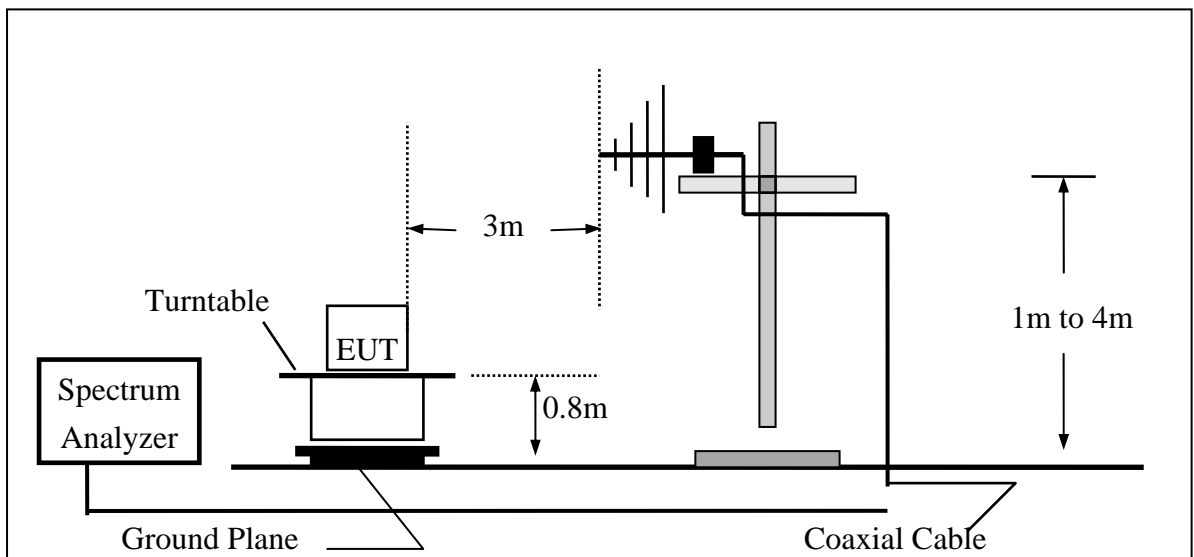

(B) Radiated Emission Test Set-UP Frequency Over 1 GHz

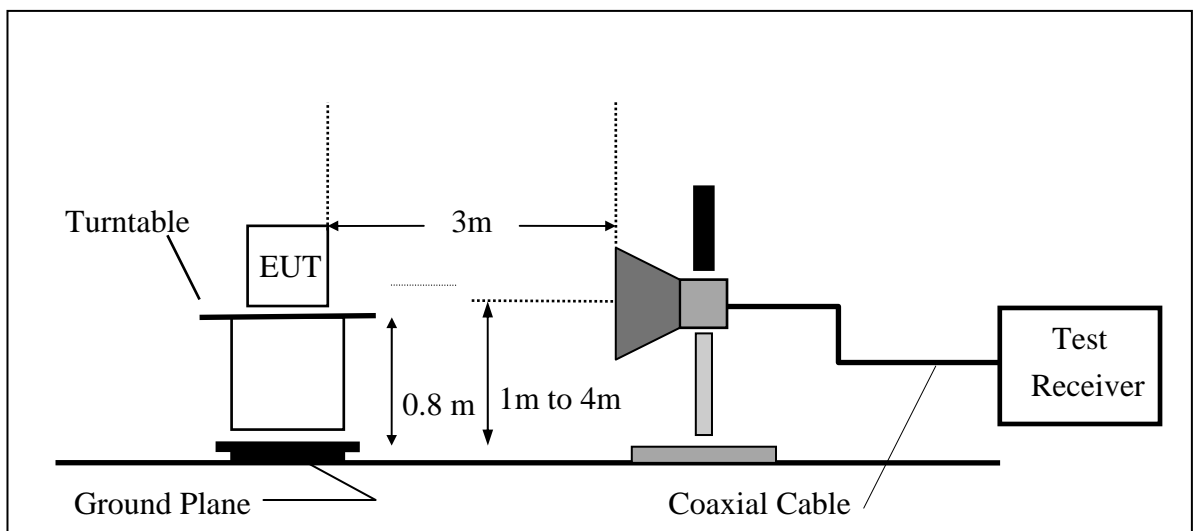

Unless otherwise stated the results shown in this test report refer only to the sample(s) tested and such sample(s) are retained for 90 days only. This test report cannot be reproduced, except in full, without prior written permission of the Company. 除非另有說明，此報告結果僅對測試之樣品負責，同時此樣品僅保留 90 天。本報告未經本公司書面許可，不可部份複製。 This document is issued by the Company subject to its General Conditions of Service (www.sgs.com/terms_and_conditions.htm) and Terms and Conditions for Electronic Documents (www.sgs.com/terms_e-document.htm). Attention is drawn to the limitations of liability, indemnification and jurisdictional issues established therein. Even if printed this electronic document is to be treated as an original within the meaning of UCP 600 article 20b. The authenticity of this document may be verified at www.sgsonsite.com/authentication. Any holder of this document is advised that information contained hereon reflects the Company's findings at the time of its intervention only and within the limits of client's instructions, if any. The Company's sole responsibility is to its Client and this document does not exonerate parties to a transaction from exercising all their rights and obligations under the transaction documents.

7.4. Measurement Procedure:

1. Place the EUT on the table and set it in transmitting mode.
2. Remove the antenna from the EUT and then connect a low loss RF cable from the antenna port to the spectrum analyzer.
3. Set center frequency of spectrum analyzer = operating frequency.
4. Set the spectrum analyzer as RBW, VBW=100KHz, Span=25MHz, Sweep = auto
5. Mark Peak, 2.390GHz and 2.4835GHz and record the max. level.
6. Repeat above procedures until all frequency measured were complete.

7.5. Field Strength Calculation

The field strength is calculated by adding the Antenna Factor and Cable Factor and subtracting the Amplifier Gain and Duty Cycle Correction Factor(if any) from the measured reading. The basic equation with a sample calculation is as follows:

$$FS = RA + AF + CL - AG$$

Where	FS = Field Strength	CL = Cable Attenuation Factor (Cable Loss)
	RA = Reading Amplitude	AG = Amplifier Gain
	AF = Antenna Factor	

7.6. Measurement Result:

Note: Refer to next page spectrum analyzer data chart and tabular data sheets.

BDR Mode
Band Edges Test Data CH-Low

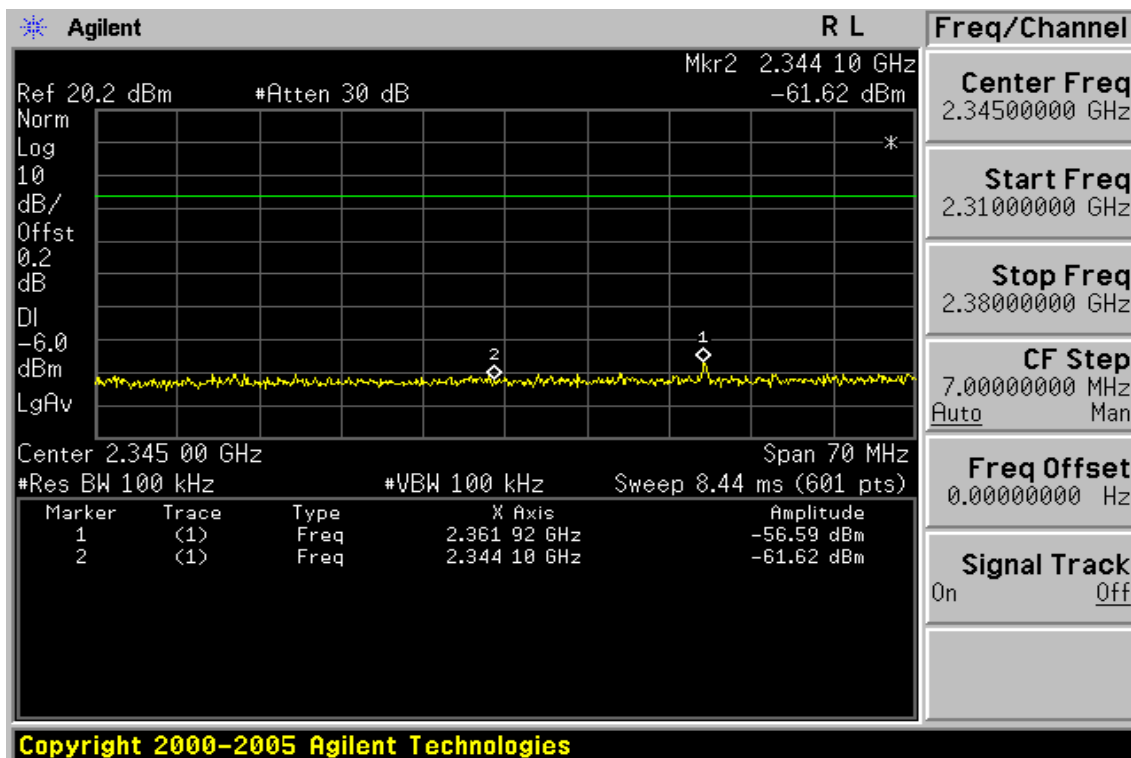
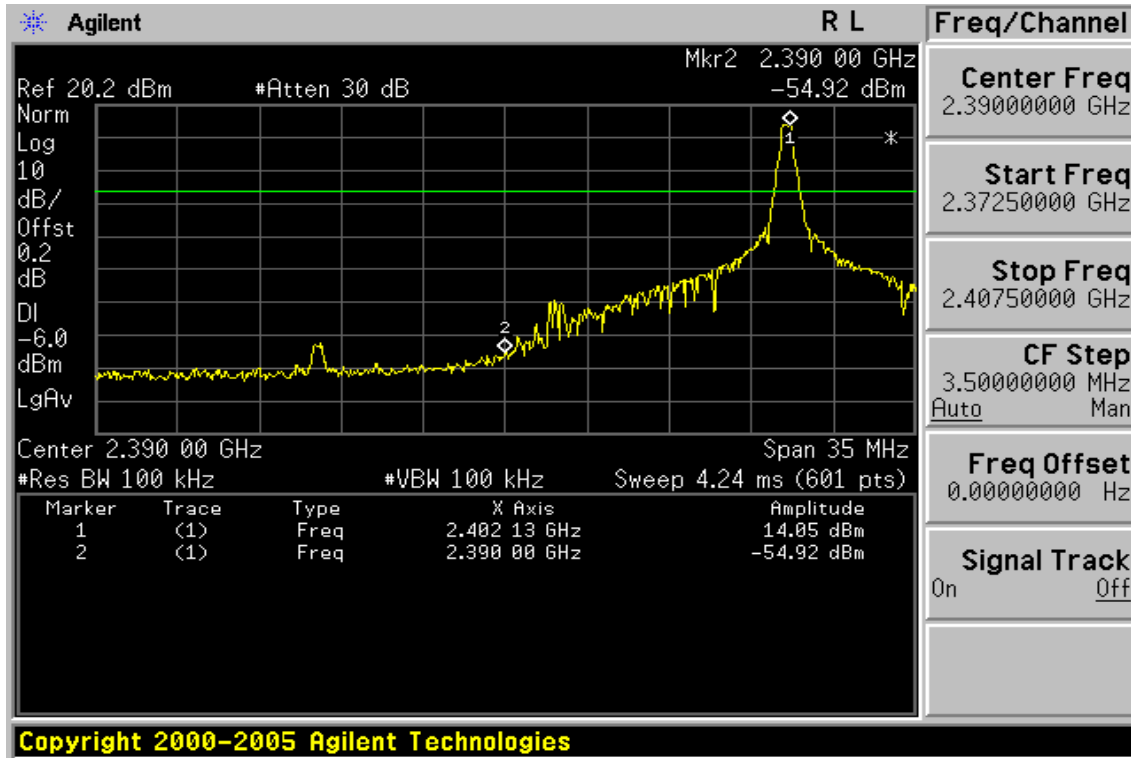

Unless otherwise stated the results shown in this test report refer only to the sample(s) tested and such sample(s) are retained for 90 days only. This test report cannot be reproduced, except in full, without prior written permission of the Company. 除非另有說明，此報告結果僅對測試之樣品負責，同時此樣品僅保留 90 天。本報告未經本公司書面許可，不可部份複製。 This document is issued by the Company subject to its General Conditions of Service (www.sgs.com/terms_and_conditions.htm) and Terms and Conditions for Electronic Documents (www.sgs.com/terms_e-document.htm). Attention is drawn to the limitations of liability, indemnification and jurisdictional issues established therein. Even if printed this electronic document is to be treated as an original within the meaning of UCP 600 article 20b. The authenticity of this document may be verified at www.sgs.com/authentication. Any holder of this document is advised that information contained hereon reflects the Company's findings at the time of its intervention only and within the limits of client's instructions, if any. The Company's sole responsibility is to its Client and this document does not exonerate parties to a transaction from exercising all their rights and obligations under the transaction documents.

Band Edges Test Data CH-High

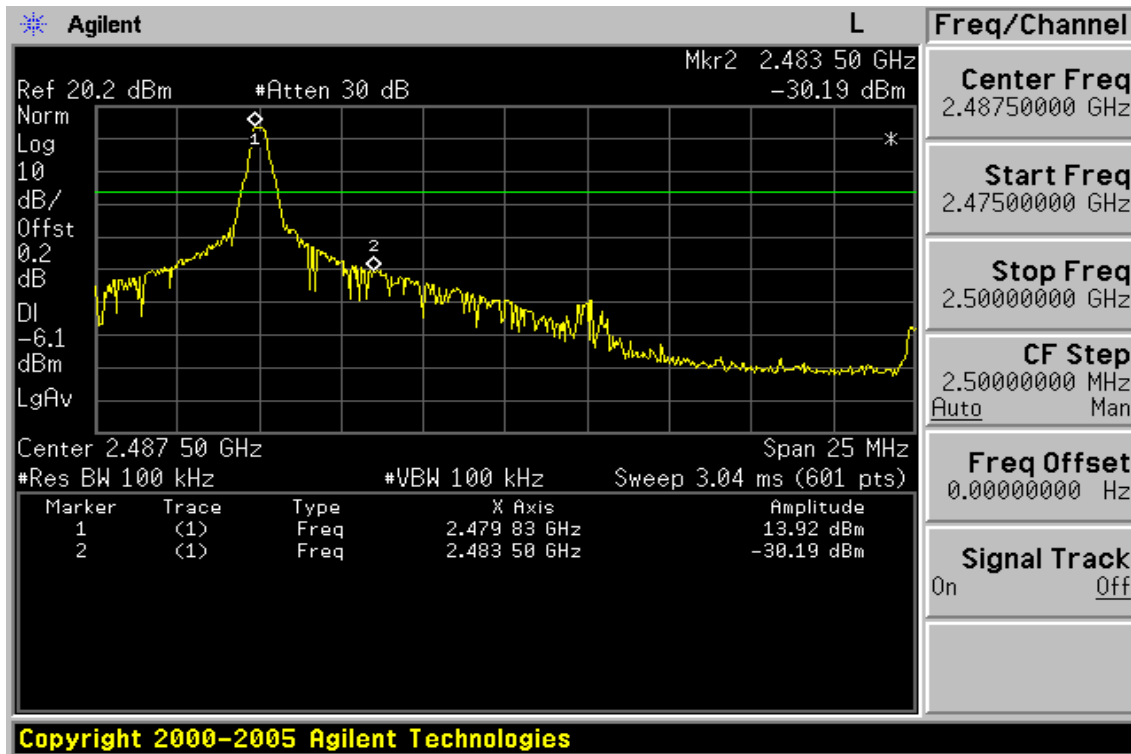

Unless otherwise stated the results shown in this test report refer only to the sample(s) tested and such sample(s) are retained for 90 days only. This test report cannot be reproduced, except in full, without prior written permission of the Company. 除非另有說明，此報告結果僅對測試之樣品負責，同時此樣品僅保留 90 天。本報告未經本公司書面許可，不可部份複製。 This document is issued by the Company subject to its General Conditions of Service (www.sgs.com/terms_and_conditions.htm) and Terms and Conditions for Electronic Documents (www.sgs.com/terms_e-document.htm). Attention is drawn to the limitations of liability, indemnification and jurisdictional issues established therein. Even if printed this electronic document is to be treated as an original within the meaning of UCP 600 article 20b. The authenticity of this document may be verified at www.sgs.com/site/authentication. Any holder of this document is advised that information contained hereon reflects the Company's findings at the time of its intervention only and within the limits of client's instructions, if any. The Company's sole responsibility is to its Client and this document does not exonerate parties to a transaction from exercising all their rights and obligations under the transaction documents.

Radiated Emission: (BDR mode)

Operation Mode TX CH Low
 Fundamental Frequency 2402 MHz
 Temperature 25 °C
 Humidity 65 %

Test Date Nov. 05, 2009
 Test By Jazz
 Pol Ver.

Freq. (MHz)	Peak	AV	Ant./CL CF (dB)	Actual FS		Peak	AV	Margin (dB)	Remark
	Reading (dBuV)	Reading (dBuV)		Peak (dBuV/m)	AV (dBuV/m)	Limit (dBuV/m)	Limit (dBuV/m)		
2390.00	45.44	---	-1.39	44.05	---	74.00	54.00	-9.95	Peak
2400.00	52.75	---	-1.35	51.40	---	74.00	54.00	-2.60	Peak

Operation Mode TX CH Low
 Fundamental Frequency 2402 MHz
 Temperature 25 °C
 Humidity 65 %

Test Date Nov. 05, 2009
 Test By Jazz
 Pol Hor.

Freq. (MHz)	Peak	AV	Ant./CL CF (dB)	Actual FS		Peak	AV	Margin (dB)	Remark
	Reading (dBuV)	Reading (dBuV)		Peak (dBuV/m)	AV (dBuV/m)	Limit (dBuV/m)	Limit (dBuV/m)		
2390.00	45.35	---	-1.39	43.96	---	74.00	54.00	-10.04	Peak
2400.00	64.94	52.96	-1.35	63.59	51.61	74.00	54.00	-2.39	AV

Remark :

- (1) Data of measurement within this frequency range shown “ - ” in the table above means the reading of emissions are attenuated more than 20dB below the permissible limits or the field strength is too small to be measured.
- (2) Radiated emissions measured in frequency above 1000MHz were made with an instrument using Peak detector mode and average detector mode of the emission shown in Actual FS column ◦
- (3) Spectrum Peak Setting : 1GHz- 26GHz, RBW= 1MHz, VBW= 3MHz, Sweep time= 200 ms.
- (4) Spectrum AV Setting : 1GHz- 26GHz, RBW= 1MHz, VBW= 10Hz, Sweep time= 200 ms.

Unless otherwise stated the results shown in this test report refer only to the sample(s) tested and such sample(s) are retained for 90 days only. This test report cannot be reproduced, except in full, without prior written permission of the Company. 除非另有說明，此報告結果僅對測試之樣品負責，同時此樣品僅保留 90 天。本報告未經本公司書面許可，不可部份複製。 This document is issued by the Company subject to its General Conditions of Service (www.sgs.com/terms_and_conditions.htm) and Terms and Conditions for Electronic Documents (www.sgs.com/terms_e-document.htm). Attention is drawn to the limitations of liability, indemnification and jurisdictional issues established therein. Even if printed this electronic document is to be treated as an original within the meaning of UCP 600 article 20b. The authenticity of this document may be verified at www.sgsonsite.com/authentication. Any holder of this document is advised that information contained hereon reflects the Company's findings at the time of its intervention only and within the limits of client's instructions, if any. The Company's sole responsibility is to its Client and this document does not exonerate parties to a transaction from exercising all their rights and obligations under the transaction documents.

Radiated Emission:

Operation Mode	TX CH High	Test Date	Nov. 05, 2009
Fundamental Frequency	2480 MHz	Test By	Jazz
Temperature	25 °C	Pol	Ver.
Humidity	65 %		

Freq. (MHz)	Peak	AV	Ant./CL CF (dB)	Actual FS		Peak	AV	Margin (dB)	Remark
	Reading (dBuV)	Reading (dBuV)		Peak (dBuV/m)	AV (dBuV/m)	Limit (dBuV/m)	Limit (dBuV/m)		
2483.56	47.50	---	-0.92	46.58	---	74.00	54.00	-7.42	Peak

Operation Mode	TX CH High	Test Date	Nov. 05, 2009
Fundamental Frequency	2480 MHz	Test By	Jazz
Temperature	25 °C	Pol	Hor.
Humidity	65 %		

Freq. (MHz)	Peak	AV	Ant./CL CF (dB)	Actual FS		Peak	AV	Margin (dB)	Remark
	Reading (dBuV)	Reading (dBuV)		Peak (dBuV/m)	AV (dBuV/m)	Limit (dBuV/m)	Limit (dBuV/m)		
2483.56	64.22	54.39	-0.92	63.30	53.47	74.00	54.00	-0.53	AV

Remark :

- (1) Data of measurement within this frequency range shown “ - ” in the table above means the reading of emissions are attenuated more than 20dB below the permissible limits or the field strength is too small to be measured.
- (2) Radiated emissions measured in frequency above 1000MHz were made with an instrument using Peak detector mode and average detector mode of the emission shown in Actual FS column ◦
- (3) Spectrum Peak Setting : 1GHz- 26GHz, RBW= 1MHz, VBW= 3MHz, Sweep time= 200 ms.
- (4) Spectrum AV Setting : 1GHz- 26GHz, RBW= 1MHz, VBW= 10Hz, Sweep time= 200 ms.

8. SPURIOUS EMISSION TEST

8.1. Standard Applicable:

According to §15.247(c), all other emissions outside these bands shall not exceed the general radiated emission limits specified in §15.209(a). And according to §15.33(a)(1), for an intentional radiator operates below 10GHz, the frequency range of measurements: to the tenth harmonic of the highest fundamental frequency or to 40GHz, whichever is lower.

8.2. Measurement Equipment Used:

8.2.1. Conducted Emission at antenna port:

Refer to section 6.2 for details.

8.2.2. Radiated emission:

Refer to section 7.2 for details.

8.3. Test SET-UP:

8.3.1. Conducted Emission at antenna port:

Refer to section 6.3 for details.

8.3.2. Radiated emission:

Refer to section 7.3 for details.

8.4. Measurement Procedure:

1. The EUT was placed on a turn table which is 0.8m above ground plane.
2. The turn table shall rotate 360 degrees to determine the position of maximum emission level.
3. EUT is set 3m away from the receiving antenna which varied from 1m to 4m to find out the highest emissions.
4. When measurement procedures for electric field radiated emissions above 1 GHz the EUT measurement is to be made "while keeping the antenna in the 'cone of radiation' from that area and pointed at the area both in azimuth and elevation, with polarization oriented for maximum response." is still within the 3dB illumination BW of the measurement antenna.
5. Maximum procedure was performed on the six highest emissions to ensure EUT compliance.
6. And also, each emission was to be maximized by changing the polarization of receiving antenna both horizontal and vertical.
7. Repeat above procedures until all frequency measured were complete.

8.5. Field Strength Calculation

The field strength is calculated by adding the Antenna Factor and Cable Factor and subtracting the Amplifier Gain and Duty Cycle Correction Factor(if any) from the measured reading. The basic equation with a sample calculation is as follows:

$$FS = RA + AF + CL - AG$$

Where	FS = Field Strength	CL = Cable Attenuation Factor (Cable Loss)
	RA = Reading Amplitude	AG = Amplifier Gain
	AF = Antenna Factor	

8.6. Measurement Result:

Note: Refer to next page spectrum analyzer data chart and tabular data sheets.

BDR Mode Conducted Spurious Emission Measurement Result
Ch Low 30MHz – 3GHz

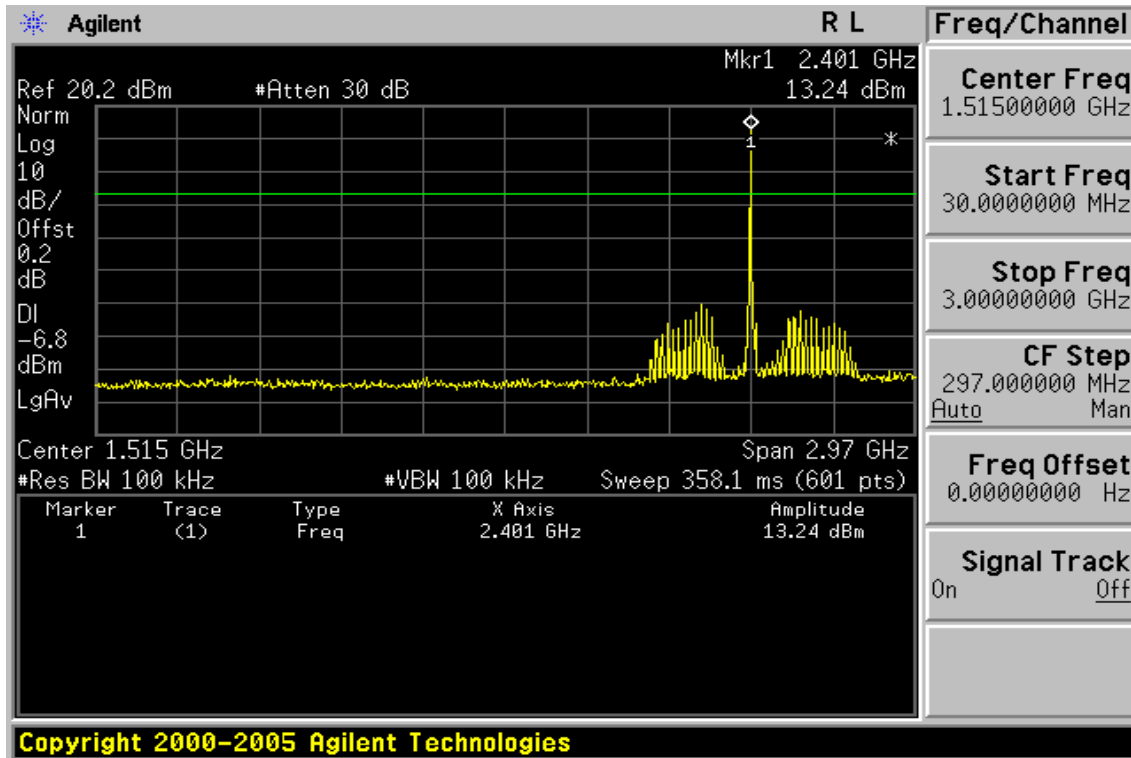

Ch Low 3GHz – 26.5GHz

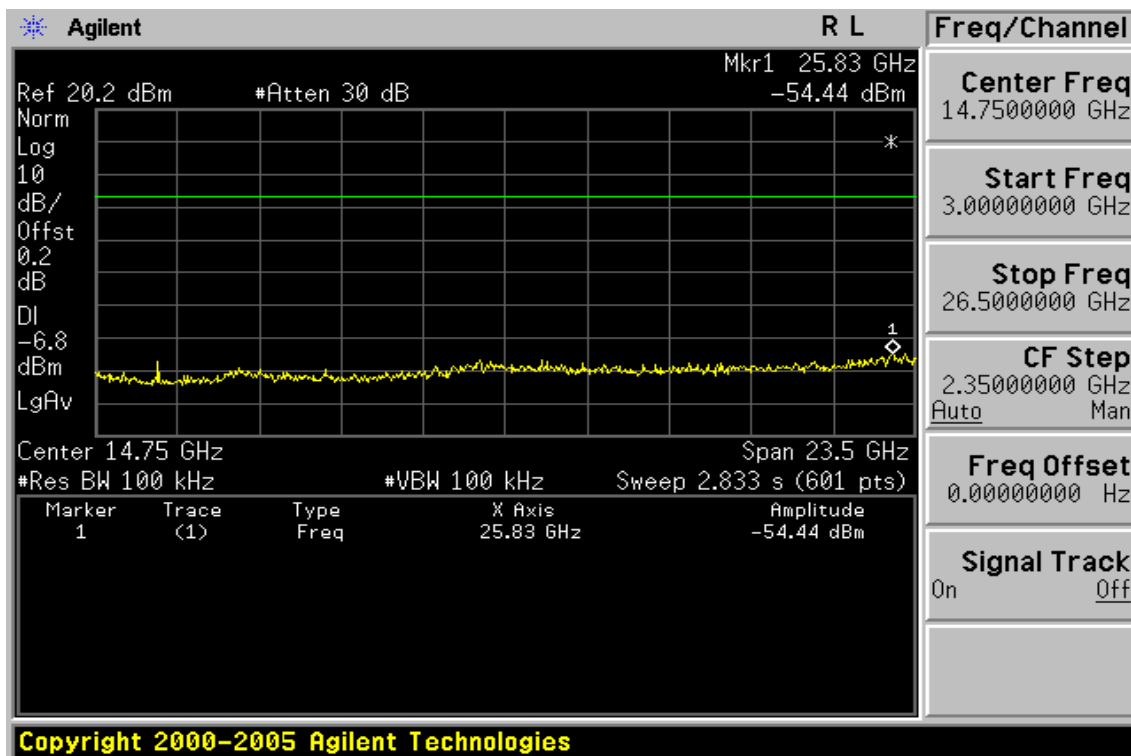

Unless otherwise stated the results shown in this test report refer only to the sample(s) tested and such sample(s) are retained for 90 days only. This test report cannot be reproduced, except in full, without prior written permission of the Company. 除非另有說明，此報告結果僅對測試之樣品負責，同時此樣品僅保留 90 天。本報告未經本公司書面許可，不可部份複製。 This document is issued by the Company subject to its General Conditions of Service (www.sgs.com/terms_and_conditions.htm) and Terms and Conditions for Electronic Documents (www.sgs.com/terms_e-document.htm). Attention is drawn to the limitations of liability, indemnification and jurisdictional issues established therein. Even if printed this electronic document is to be treated as an original within the meaning of UCP 600 article 20b. The authenticity of this document may be verified at www.sgs.com/authentication. Any holder of this document is advised that information contained hereon reflects the Company's findings at the time of its intervention only and within the limits of client's instructions, if any. The Company's sole responsibility is to its Client and this document does not exonerate parties to a transaction from exercising all their rights and obligations under the transaction documents.

Ch Mid 30MHz – 3GHz

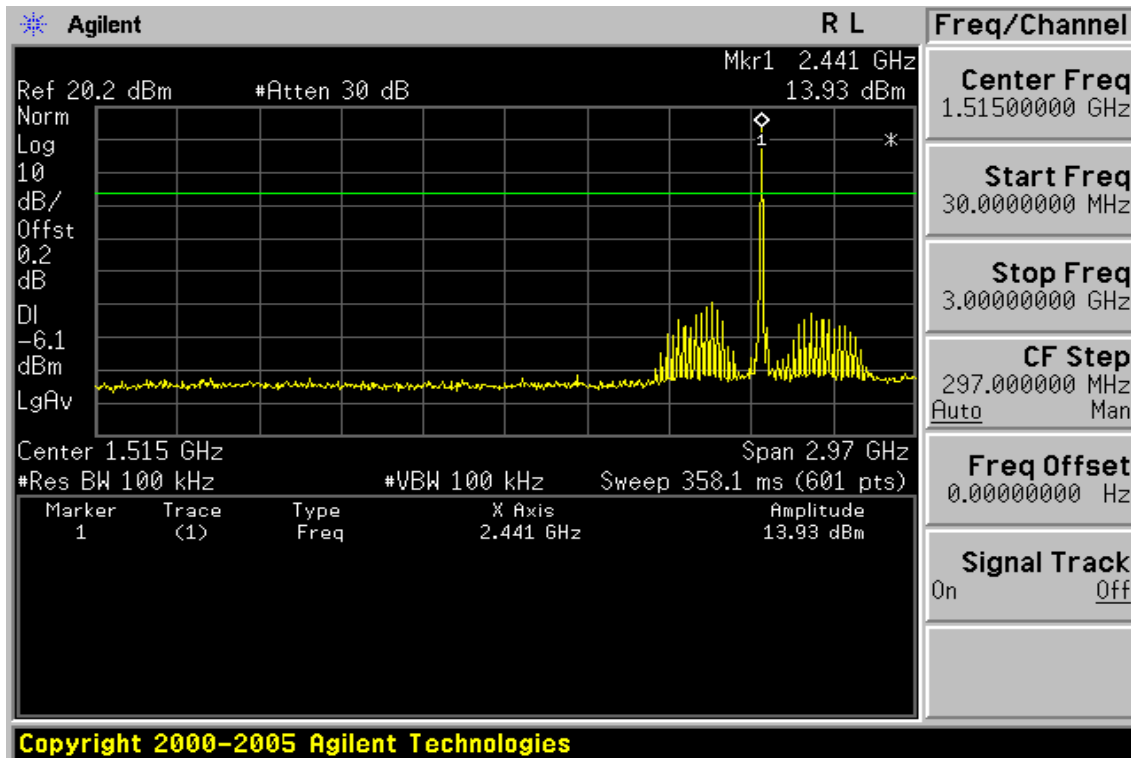

Ch Mid 3GHz – 26.5GHz

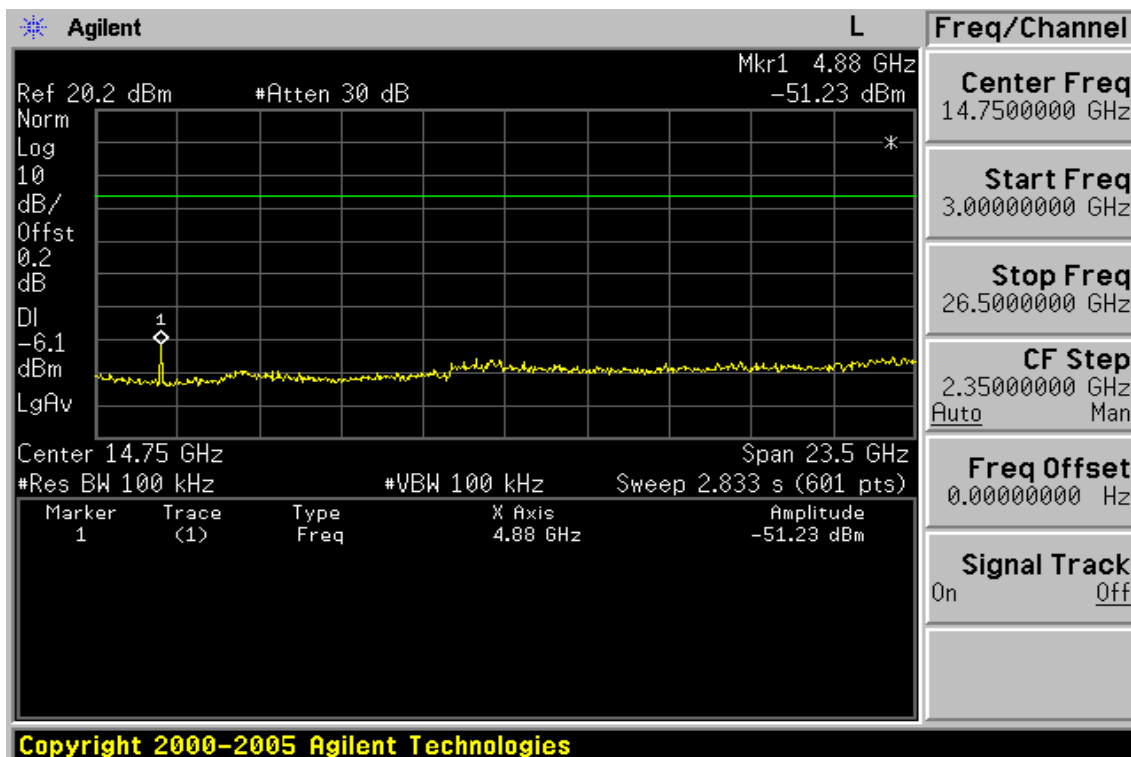

Unless otherwise stated the results shown in this test report refer only to the sample(s) tested and such sample(s) are retained for 90 days only. This test report cannot be reproduced, except in full, without prior written permission of the Company. 除非另有說明，此報告結果僅對測試之樣品負責，同時此樣品僅保留 90 天。本報告未經本公司書面許可，不可部份複製。 This document is issued by the Company subject to its General Conditions of Service (www.sgs.com/terms_and_conditions.htm) and Terms and Conditions for Electronic Documents (www.sgs.com/terms_e-document.htm). Attention is drawn to the limitations of liability, indemnification and jurisdictional issues established therein. Even if printed this electronic document is to be treated as an original within the meaning of UCP 600 article 20b. The authenticity of this document may be verified at www.sgs.com/authentication. Any holder of this document is advised that information contained hereon reflects the Company's findings at the time of its intervention only and within the limits of client's instructions, if any. The Company's sole responsibility is to its Client and this document does not exonerate parties to a transaction from exercising all their rights and obligations under the transaction documents.

Ch High 30MHz – 3GHz

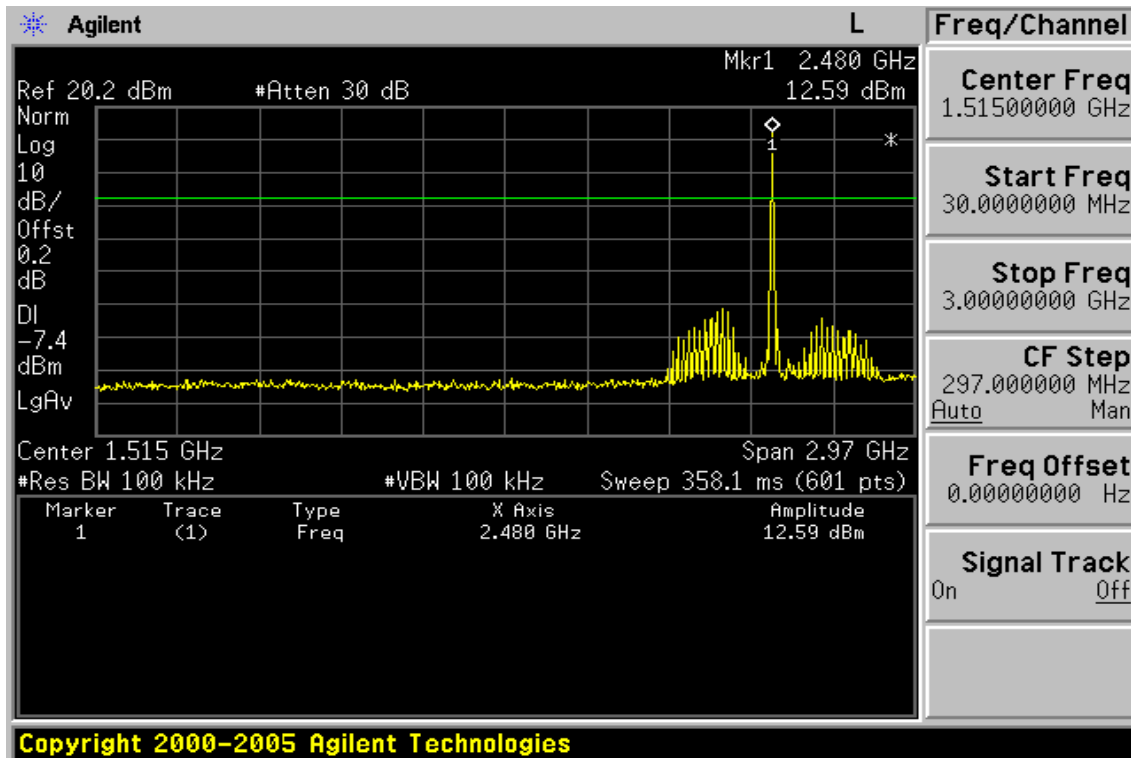

Ch High 3GHz – 26.5GHz

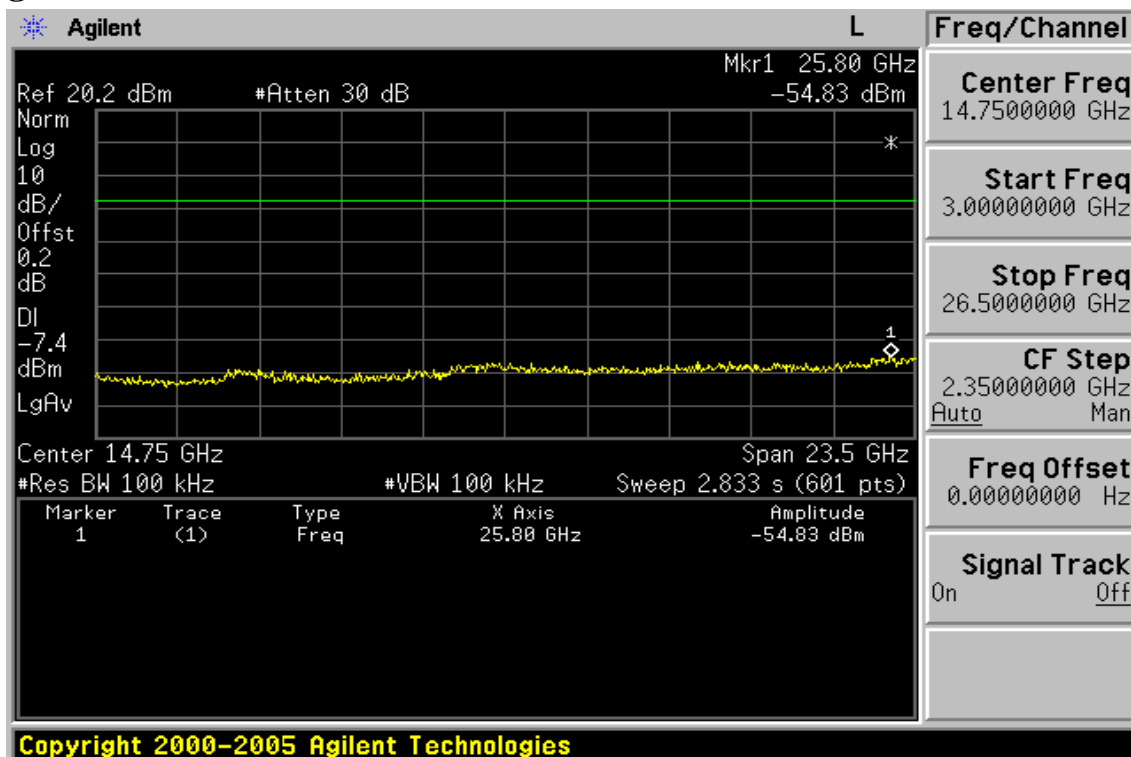

Unless otherwise stated the results shown in this test report refer only to the sample(s) tested and such sample(s) are retained for 90 days only. This test report cannot be reproduced, except in full, without prior written permission of the Company. 除非另有說明，此報告結果僅對測試之樣品負責，同時此樣品僅保留 90 天。本報告未經本公司書面許可，不可部份複製。 This document is issued by the Company subject to its General Conditions of Service (www.sgs.com/terms_and_conditions.htm) and Terms and Conditions for Electronic Documents (www.sgs.com/terms_e-document.htm). Attention is drawn to the limitations of liability, indemnification and jurisdictional issues established therein. Even if printed this electronic document is to be treated as an original within the meaning of UCP 600 article 20b. The authenticity of this document may be verified at www.sgs.com/authentication. Any holder of this document is advised that information contained hereon reflects the Company's findings at the time of its intervention only and within the limits of client's instructions, if any. The Company's sole responsibility is to its Client and this document does not exonerate parties to a transaction from exercising all their rights and obligations under the transaction documents.

Radiated Spurious Emission Measurement Result (below 1GHz) (EDR mode)

Operation Mode	TX CH Low	Test Date	Nov. 05, 2009
Fundamental Frequency	2402MHz	Test By	Jazz
Temperature	25 °C	Pol	Ver./Hor.
Humidity	65 %		

Freq. (MHz)	Ant.Pol. H/V	Detector Mode (PK/QP)	Reading (dBuV)	Factor (dB)	Actual FS (dBuV/m)	Limit3m (dBuV/m)	Safe Margin (dB)
67.83	V	Peak	44.94	-15.60	29.34	40.00	-10.66
104.69	V	Peak	49.00	-16.63	32.37	43.50	-11.13
67.83	H	Peak	42.11	-15.60	26.51	40.00	-13.49

Remark :

- 1 Measuring frequencies from 30 MHz to the 1GHz ◦
- 2 Radiated emissions measured in frequency range from 30 MHz to 1000MHz were made with an instrument using Peak/QP detector mode.
- 3 Data of measurement within this frequency range shown “ - ” in the table above means the reading of emissions are attenuated more than 20dB below the permissible limits or the field strength is too small to be measured.
- 4 The IF bandwidth of SPA between 30MHz to 1GHz was 100KHz.

Radiated Spurious Emission Measurement Result (below 1GHz)

Operation Mode	TX CH Mid	Test Date	Nov. 05, 2009
Fundamental Frequency	2441MHz	Test By	Jazz
Temperature	25 °C	Pol	Ver./Hor.
Humidity	65 %		

Freq. (MHz)	Ant.Pol. H/V	Detector Mode (PK/QP)	Reading (dBuV)	Factor (dB)	Actual FS (dBuV/m)	Limit3m (dBuV/m)	Safe Margin (dB)
62.98	V	Peak	43.09	-14.85	28.24	40.00	-11.76
104.69	V	Peak	48.37	-16.63	31.74	43.50	-11.76
41.64	H	Peak	44.79	-13.76	31.03	40.00	-8.97

Remark :

- 1 Measuring frequencies from 30 MHz to the 1GHz ◦
- 2 Radiated emissions measured in frequency range from 30 MHz to 1000MHz were made with an instrument using Peak/QP detector mode.
- 3 Data of measurement within this frequency range shown “ - ” in the table above means the reading of emissions are attenuated more than 20dB below the permissible limits or the field strength is too small to be measured.
- 4 The IF bandwidth of SPA between 30MHz to 1GHz was 100KHz.

Radiated Spurious Emission Measurement Result (below 1GHz)

Operation Mode	TX CH High	Test Date	Nov. 05, 2009
Fundamental Frequency	2480MHz	Test By	Jazz
Temperature	25 °C	Pol	Ver./Hor.
Humidity	65 %		

Freq. (MHz)	Ant.Pol. H/V	Detector Mode (PK/QP)	Reading (dBuV)	Factor (dB)	Actual FS (dBuV/m)	Limit3m (dBuV/m)	Safe Margin (dB)
104.69	V	Peak	49.55	-16.63	32.92	43.50	-10.58
38.73	H	Peak	44.88	-13.84	31.04	40.00	-8.96

Remark :

- 1 Measuring frequencies from 30 MHz to the 1GHz °
- 2 Radiated emissions measured in frequency range from 30 MHz to 1000MHz were made with an instrument using Peak/QP detector mode.
- 3 Data of measurement within this frequency range shown “ - ” in the table above means the reading of emissions are attenuated more than 20dB below the permissible limits or the field strength is too small to be measured.
- 4 The IF bandwidth of SPA between 30MHz to 1GHz was 100KHz.

Radiated Spurious Emission Measurement Result (above 1GHz)

Operation Mode	TX CH Low	Test Date	Nov. 05, 2009
Fundamental Frequency	2402 MHz	Test By	Jazz
Temperature	25 °C	Pol	Ver.
Humidity	65 %		

Freq. (MHz)	Peak	AV	Ant./CL CF(dB)	Actual FS		Peak	AV	Margin (dB)	Remark
	Reading (dBuV)	Reading (dBuV)		Peak (dBuV/m)	AV (dBuV/m)	Limit (dBuV/m)	Limit (dBuV/m)		
4804.0	39.04	----	5.99	45.03	----	74.00	54.00	-8.97	Peak
7206.0	----					74.00	54.00		
9608.0	----					74.00	54.00		
12010.0	----					74.00	54.00		
14412.0	----					74.00	54.00		
16814.0	----					74.00	54.00		
19216.0	----					74.00	54.00		
21618.0	----					74.00	54.00		
24020.0	----					74.00	54.00		

Remark:

- 1 Measuring frequencies from 1GHz to the 10th harmonic of highest fundamental frequency.
- 2 Data of measurement within this frequency range shown “ - ” in the table above means the reading of emissions are attenuated more than 20dB below the permissible limits or the field strength is too small to be measured.
- 3 Radiated emissions measured in frequency above 1000MHz were made with an instrument using Peak detector mode and average detector mode of the emission shown in Actual FS column.
- 4 Spectrum Peak Setting : 1GHz- 26GHz, RBW= 1MHz, VBW= 3MHz, Sweep time= 200 ms.
- 5 Spectrum AV Setting : 1GHz- 26GHz, RBW= 1MHz, VBW= 10Hz, Sweep time= 200 ms.

Radiated Spurious Emission Measurement Result (above 1GHz)

Operation Mode	TX CH Low	Test Date	Nov. 05, 2009
Fundamental Frequency	2402 MHz	Test By	Jazz
Temperature	25 °C	Pol	Hor.
Humidity	65 %		

Freq. (MHz)	Peak	AV	Ant./CL CF(dB)	Actual FS		Peak	AV	Margin (dB)	Remark
	Reading (dBuV)	Reading (dBuV)		Peak (dBuV/m)	AV (dBuV/m)	Limit (dBuV/m)	Limit (dBuV/m)		
4804.0	38.67	----	5.99	44.66	----	74.00	54.00	-9.34	Peak
7206.0	----					74.00	54.00		
9608.0	----					74.00	54.00		
12010.0	----					74.00	54.00		
14412.0	----					74.00	54.00		
16814.0	----					74.00	54.00		
19216.0	----					74.00	54.00		
21618.0	----					74.00	54.00		
24020.0	----					74.00	54.00		

Remark:

- 1 Measuring frequencies from 1GHz to the 10th harmonic of highest fundamental frequency.
- 2 Data of measurement within this frequency range shown “ - ” in the table above means the reading of emissions are attenuated more than 20dB below the permissible limits or the field strength is too small to be measured.
- 3 Radiated emissions measured in frequency above 1000MHz were made with an instrument using Peak detector mode and average detector mode of the emission shown in Actual FS column.
- 4 Spectrum Peak Setting : 1GHz- 26GHz, RBW= 1MHz, VBW= 3MHz, Sweep time= 200 ms.
- 5 Spectrum AV Setting : 1GHz- 26GHz, RBW= 1MHz, VBW= 10Hz, Sweep time= 200 ms.

Radiated Spurious Emission Measurement Result (above 1GHz)

Operation Mode	TX CH Mid	Test Date	Nov. 05, 2009
Fundamental Frequency	2441 MHz	Test By	Jazz
Temperature	25 °C	Pol	Ver.
Humidity	65 %		

(MHz)	Peak	AV	Actual FS		Peak	AV	Margin (dB)	Remark	
	(dBuV)	(dBuV)	CF(dB)	(dBuV/m)	(dBuV/m)	(dBuV/m)			
4882.0	38.40	----	6.17	44.57	----	74.00	54.00	-9.43	Peak
7323.0	----					74.00	54.00		
9764.0	----					74.00	54.00		
12205.0	----					74.00	54.00		
14646.0	----					74.00	54.00		
17087.0	----					74.00	54.00		
19528.0	----					74.00	54.00		
21969.0	----					74.00	54.00		
24410.0	----					74.00	54.00		

Remark:

- 1 Measuring frequencies from 1GHz to the 10th harmonic of highest fundamental frequency.
- 2 Data of measurement within this frequency range shown “ - ” in the table above means the reading of emissions are attenuated more than 20dB below the permissible limits or the field strength is too small to be measured.
- 3 Radiated emissions measured in frequency above 1000MHz were made with an instrument using Peak detector mode and average detector mode of the emission shown in Actual FS column.
- 4 Spectrum Peak Setting : 1GHz- 26GHz, RBW= 1MHz, VBW= 3MHz, Sweep time= 200 ms.
- 5 Spectrum AV Setting : 1GHz- 26GHz, RBW= 1MHz, VBW= 10Hz, Sweep time= 200 ms.

Radiated Spurious Emission Measurement Result (above 1GHz)

Operation Mode	TX CH Mid	Test Date	Nov. 05, 2009
Fundamental Frequency	2441 MHz	Test By	Jazz
Temperature	25 °C	Pol	Hor.
Humidity	65 %		

(MHz)	Peak	AV	CF(dB)	Actual FS		Peak	AV	Margin (dB)	Remark
	(dBuV)	(dBuV)		(dBuV/m)	(dBuV/m)	(dBuV/m)	(dBuV/m)		
4882.0	39.57	----	6.17	45.74	----	74.00	54.00	-8.26	Peak
7323.0	----					74.00	54.00		
9764.0	----					74.00	54.00		
12205.0	----					74.00	54.00		
14646.0	----					74.00	54.00		
17087.0	----					74.00	54.00		
19528.0	----					74.00	54.00		
21969.0	----					74.00	54.00		
24410.0	----					74.00	54.00		

Remark:

- 1 Measuring frequencies from 1GHz to the 10th harmonic of highest fundamental frequency.
- 2 Data of measurement within this frequency range shown “ - ” in the table above means the reading of emissions are attenuated more than 20dB below the permissible limits or the field strength is too small to be measured.
- 3 Radiated emissions measured in frequency above 1000MHz were made with an instrument using Peak detector mode and average detector mode of the emission shown in Actual FS column.
- 4 Spectrum Peak Setting : 1GHz- 26GHz, RBW= 1MHz, VBW= 3MHz, Sweep time= 200 ms.
- 5 Spectrum AV Setting : 1GHz- 26GHz, RBW= 1MHz, VBW= 10Hz, Sweep time= 200 ms.

Unless otherwise stated the results shown in this test report refer only to the sample(s) tested and such sample(s) are retained for 90 days only. This test report cannot be reproduced, except in full, without prior written permission of the Company. 除非另有說明，此報告結果僅對測試之樣品負責，同時此樣品僅保留 90 天。本報告未經本公司書面許可，不可部份複製。 This document is issued by the Company subject to its General Conditions of Service (www.sgs.com/terms_and_conditions.htm) and Terms and Conditions for Electronic Documents (www.sgs.com/terms_e-document.htm). Attention is drawn to the limitations of liability, indemnification and jurisdictional issues established therein. Even if printed this electronic document is to be treated as an original within the meaning of UCP 600 article 20b. The authenticity of this document may be verified at www.sgsonsite.com/authentication. Any holder of this document is advised that information contained hereon reflects the Company's findings at the time of its intervention only and within the limits of client's instructions, if any. The Company's sole responsibility is to its Client and this document does not exonerate parties to a transaction from exercising all their rights and obligations under the transaction documents.

Radiated Spurious Emission Measurement Result (above 1GHz)

Operation Mode	TX CH High	Test Date	Nov. 05, 2009
Fundamental Frequency	2480 MHz	Test By	Jazz
Temperature	25 °C	Pol	Ver.
Humidity	65 %		

(MHz)	Peak	AV	Actual FS		Peak	AV	Margin (dB)	Remark	
	(dBuV)	(dBuV)	CF(dB)	(dBuV/m)	(dBuV/m)	(dBuV/m)			
4960.0	39.71	----	6.36	46.07	----	74.00	54.00	-7.93	Peak
7440.0	----					74.00	54.00		
9920.0	----					74.00	54.00		
12400.0	----					74.00	54.00		
14880.0	----					74.00	54.00		
17360.0	----					74.00	54.00		
19840.0	----					74.00	54.00		
22320.0	----					74.00	54.00		
24800.0	----					74.00	54.00		

Remark:

- 1 Measuring frequencies from 1GHz to the 10th harmonic of highest fundamental frequency.
- 2 Data of measurement within this frequency range shown “ - ” in the table above means the reading of emissions are attenuated more than 20dB below the permissible limits or the field strength is too small to be measured.
- 3 Radiated emissions measured in frequency above 1000MHz were made with an instrument using Peak detector mode and average detector mode of the emission shown in Actual FS column.
- 4 Spectrum Peak Setting : 1GHz- 26GHz, RBW= 1MHz, VBW= 3MHz, Sweep time= 200 ms.
- 5 Spectrum AV Setting : 1GHz- 26GHz, RBW= 1MHz, VBW= 10Hz, Sweep time= 200 ms.

Radiated Spurious Emission Measurement Result (above 1GHz)

Operation Mode	TX CH High	Test Date	Nov. 05, 2009
Fundamental Frequency	2480 MHz	Test By	Jazz
Temperature	25 °C	Pol	Hor.
Humidity	65 %		

(MHz)	Peak	AV	CF(dB)	Actual FS		Peak	AV	Margin (dB)	Remark
	(dBuV)	(dBuV)		(dBuV/m)	(dBuV/m)	(dBuV/m)	(dBuV/m)		
4960.0	41.17	----	6.36	47.53	----	74.00	54.00	-6.47	Peak
7440.0	----					74.00	54.00		
9920.0	----					74.00	54.00		
12400.0	----					74.00	54.00		
14880.0	----					74.00	54.00		
17360.0	----					74.00	54.00		
19840.0	----					74.00	54.00		
22320.0	----					74.00	54.00		
24800.0	----					74.00	54.00		

Remark:

- 1 Measuring frequencies from 1GHz to the 10th harmonic of highest fundamental frequency.
- 2 Data of measurement within this frequency range shown “ - ” in the table above means the reading of emissions are attenuated more than 20dB below the permissible limits or the field strength is too small to be measured.
- 3 Radiated emissions measured in frequency above 1000MHz were made with an instrument using Peak detector mode and average detector mode of the emission shown in Actual FS column.
- 4 Spectrum Peak Setting : 1GHz- 26GHz, RBW= 1MHz, VBW= 3MHz, Sweep time= 200 ms.
- 5 Spectrum AV Setting : 1GHz- 26GHz, RBW= 1MHz, VBW= 10Hz, Sweep time= 200 ms.

9. FREQUENCY SEPARATION

9.1. Standard Applicable:

According to §15.247(a)(1), Frequency hopping systems shall have hopping channel carrier frequencies separated by minimum of 25KHz or the 20dB bandwidth of the hopping channel, whichever is greater.

9.2. Measurement Equipment Used:

Refer to section 6.2 for details.

9.3. Test Set-up:

Refer to section 6.3 for details.

9.4. Measurement Procedure:

1. Place the EUT on the table and set it in transmitting mode.
2. Remove the antenna from the EUT and then connect a low loss RF cable from the antenna port to the spectrum analyzer.
3. Set center frequency of spectrum analyzer = middle of hopping channel .
4. Set the spectrum analyzer as RBW,VBW=100kHz, Adjust Span to 3.0 MHz, Sweep = auto.
5. Max hold. Mark 3 Peaks of hopping channel and record the 3 peaks frequency.

9.5. Measurement Result:

Channel separation (MHz)	Limit	Result
1	$\geq 25\text{KHz}$ or 2/3 times 20dB bandwidth	PASS

Note: Refer to next page for plots.

Frequency Separation Test Data

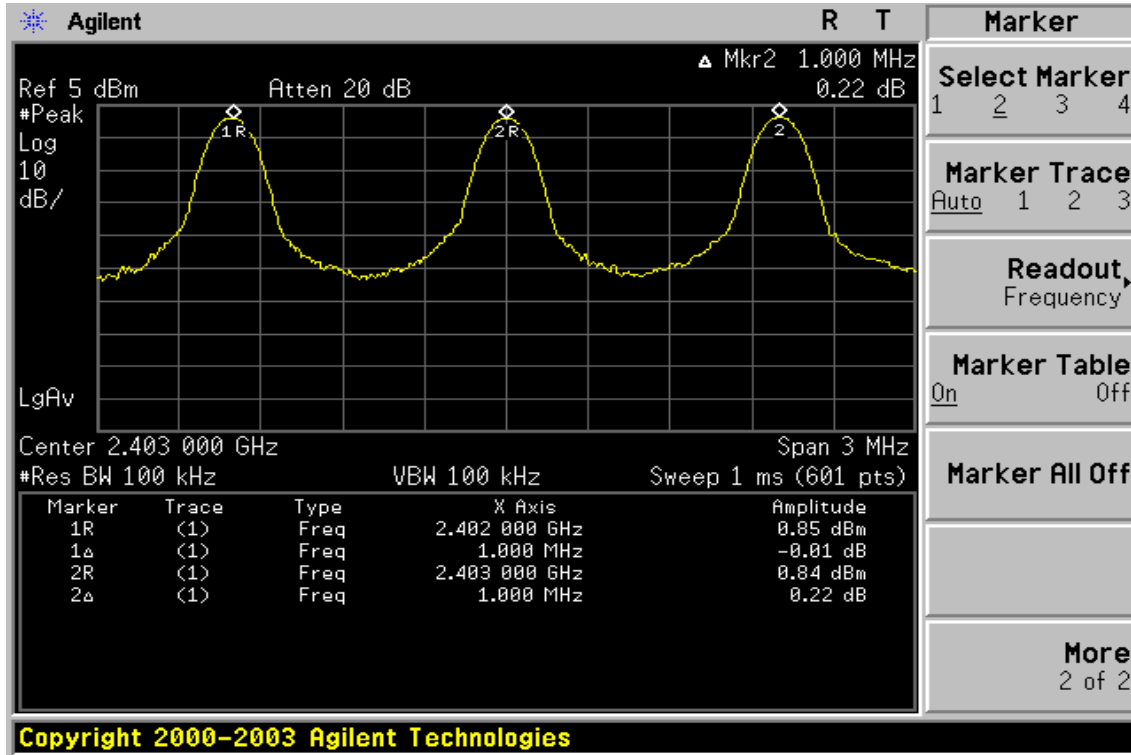

Unless otherwise stated the results shown in this test report refer only to the sample(s) tested and such sample(s) are retained for 90 days only. This test report cannot be reproduced, except in full, without prior written permission of the Company. 除非另有說明，此報告結果僅對測試之樣品負責，同時此樣品僅保留 90 天。本報告未經本公司書面許可，不可部份複製。 This document is issued by the Company subject to its General Conditions of Service (www.sgs.com/terms_and_conditions.htm) and Terms and Conditions for Electronic Documents (www.sgs.com/terms_e-document.htm). Attention is drawn to the limitations of liability, indemnification and jurisdictional issues established therein. Even if printed this electronic document is to be treated as an original within the meaning of UCP 600 article 20b. The authenticity of this document may be verified at www.sgs.com/site/authentication. Any holder of this document is advised that information contained hereon reflects the Company's findings at the time of its intervention only and within the limits of client's instructions, if any. The Company's sole responsibility is to its Client and this document does not exonerate parties to a transaction from exercising all their rights and obligations under the transaction documents.

10. NUMBER OF HOPPING FREQUENCY

10.1. Standard Applicable:

According to §15.247(a)(1)(iii), Frequency hopping systems operating in the 2400MHz-2483.5 MHz bands shall use at least 15 hopping frequencies.

10.2. Measurement Equipment Used:

Refer to section 6.2 for details.

10.3. Test Set-up:

Refer to section 6.3 for details.

10.4. Measurement Procedure:

1. Place the EUT on the table and set it in transmitting mode.
2. Remove the antenna from the EUT and then connect a low loss RF cable from the antenna port to the spectrum analyzer.
3. Set spectrum analyzer Start=2400MHz, Stop = 2483.5MHz, Sweep = auto.
4. Set the spectrum analyzer as RBW=430kHz, VBW=1.3MHz,
5. Max hold, view and count how many channel in the band.

10.5. Measurement Result:

Note: Refer to next page for plots.

Channel Number
2.4 GHz – 2.441GHz

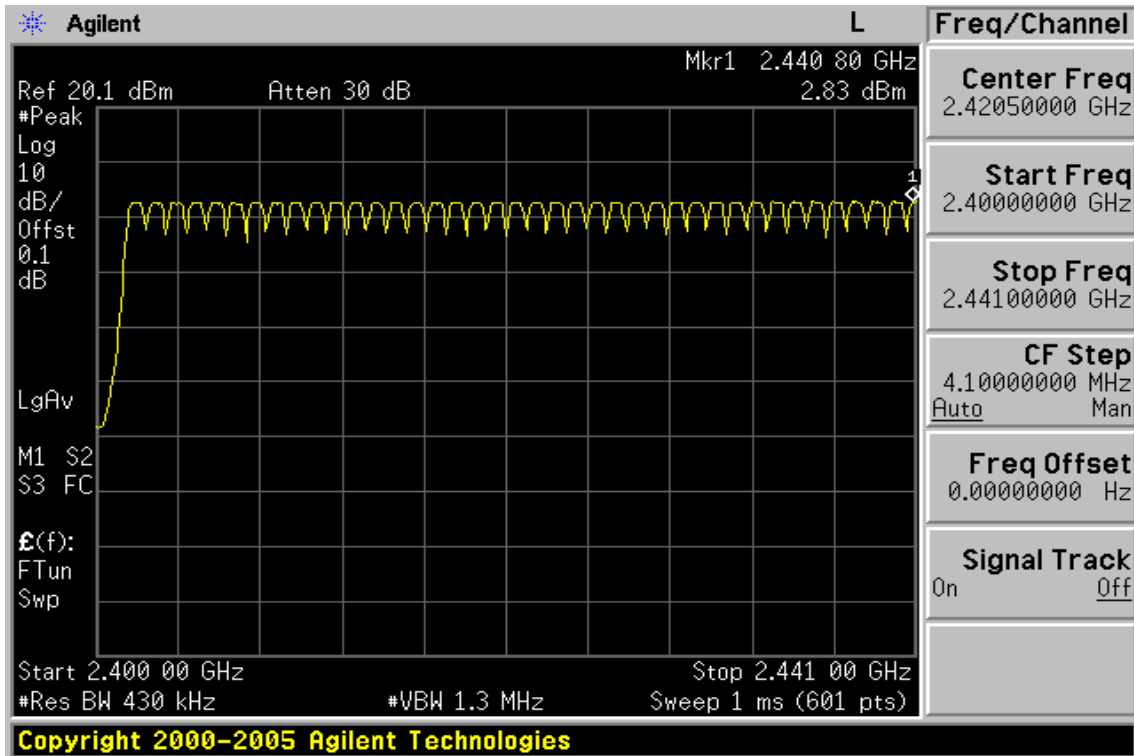

2.441 GHz – 2.4835GHz

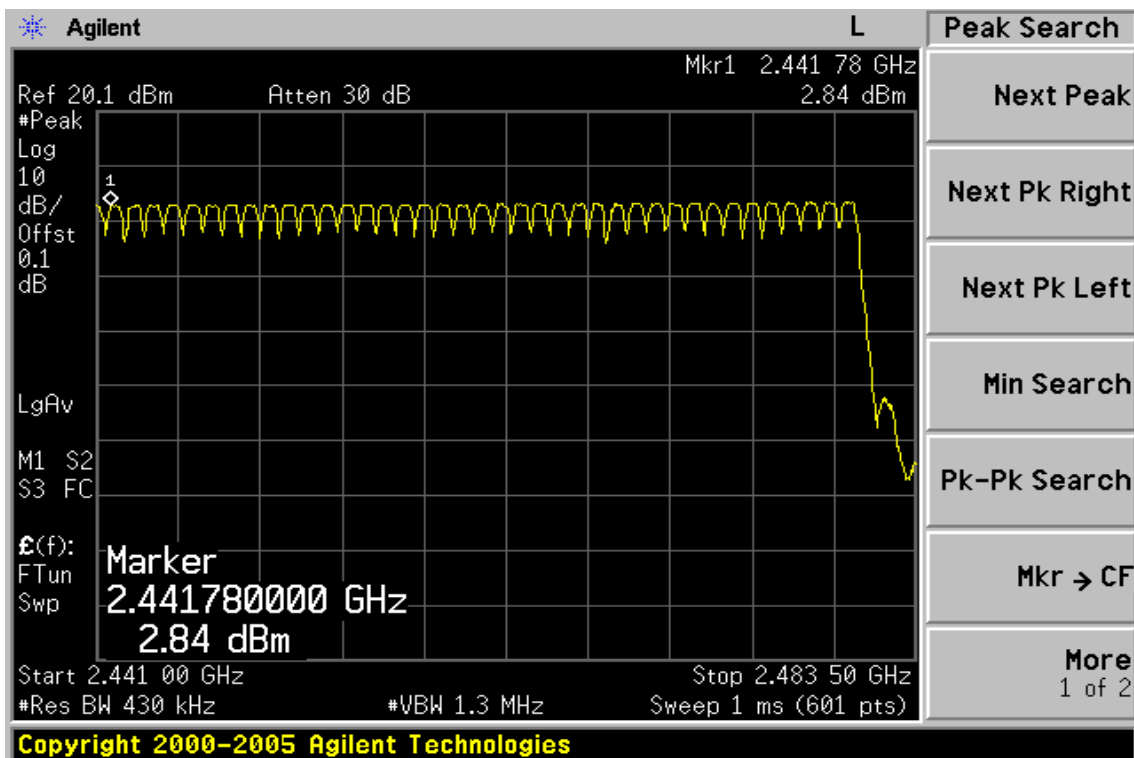

Unless otherwise stated the results shown in this test report refer only to the sample(s) tested and such sample(s) are retained for 90 days only. This test report cannot be reproduced, except in full, without prior written permission of the Company. 除非另有說明，此報告結果僅對測試之樣品負責，同時此樣品僅保留 90 天。本報告未經本公司書面許可，不可部份複製。 This document is issued by the Company subject to its General Conditions of Service (www.sgs.com/terms_and_conditions.htm) and Terms and Conditions for Electronic Documents (www.sgs.com/terms_e-document.htm). Attention is drawn to the limitations of liability, indemnification and jurisdictional issues established therein. Even if printed this electronic document is to be treated as an original within the meaning of UCP 600 article 20b. The authenticity of this document may be verified at www.sgs.com/site/authentication. Any holder of this document is advised that information contained hereon reflects the Company's findings at the time of its intervention only and within the limits of client's instructions, if any. The Company's sole responsibility is to its Client and this document does not exonerate parties to a transaction from exercising all their rights and obligations under the transaction documents.

11. TIME OF OCCUPANCY (DWELL TIME)

11.1. Standard Applicable:

According to §15.247(a)(1)(iii), Frequency hopping systems operating in the 2400MHz-2483.5 MHz. The average time of occupancy on any frequency shall not greater than 0.4 s within period of 0.4 seconds multiplied by the number of hopping channel employed.

11.2. Measurement Equipment Used:

Refer to section 6.2 for details.

11.3. Test Set-up:

Refer to section 6.3 for details.

11.4. Measurement Procedure:

1. Place the EUT on the table and set it in transmitting mode.
2. Remove the antenna from the EUT and then connect a low loss RF cable from the antenna port to the spectrum analyzer.
3. Set center frequency of spectrum analyzer = operating frequency.
4. Set the spectrum analyzer as RBW=1MHz, VBW=3MHz, Span = 0Hz , Adjust Sweep = 15ms.
5. Repeat above procedures until all frequency measured were complete.

11.5. Measurement Result:

A period time = 0.4 (ms) * 79 = 31.6 (s)

CH Low: DH1 time slot = 0.417 (ms) * (1600/(2*79)) * 31.6 = 133.44 (ms)

DH3 time slot = 1.667 (ms) * (1600/(4*79)) * 31.6 = 266.72 (ms)

DH5 time slot = 2.925 (ms) * (1600/(6*79)) * 31.6 = 312.00 (ms)

CH Mid: DH1 time slot = 0.417 (ms) * (1600/(2*79)) * 31.6 = 133.44 (ms)

DH3 time slot = 1.667 (ms) * (1600/(4*79)) * 31.6 = 266.72 (ms)

DH5 time slot = 2.925 (ms) * (1600/(6*79)) * 31.6 = 312.00 (ms)

CH High: DH1 time slot = 0.417 (ms) * (1600/(2*79)) * 31.6 = 133.44 (ms)

DH3 time slot = 1.667 (ms) * (1600/(4*79)) * 31.6 = 266.72 (ms)

DH5 time slot = 2.925 (ms) * (1600/(6*79)) * 31.6 = 312.00 (ms)

Note: Refer to next page for plots.

CH-Low
DH1

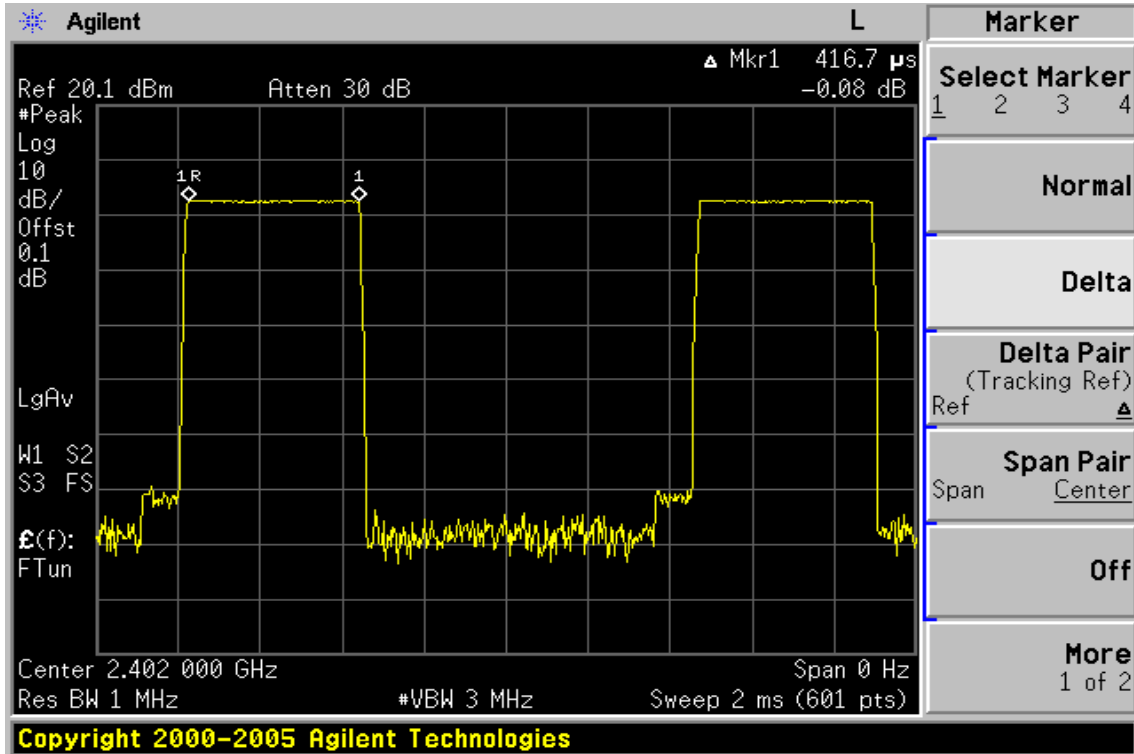

DH3

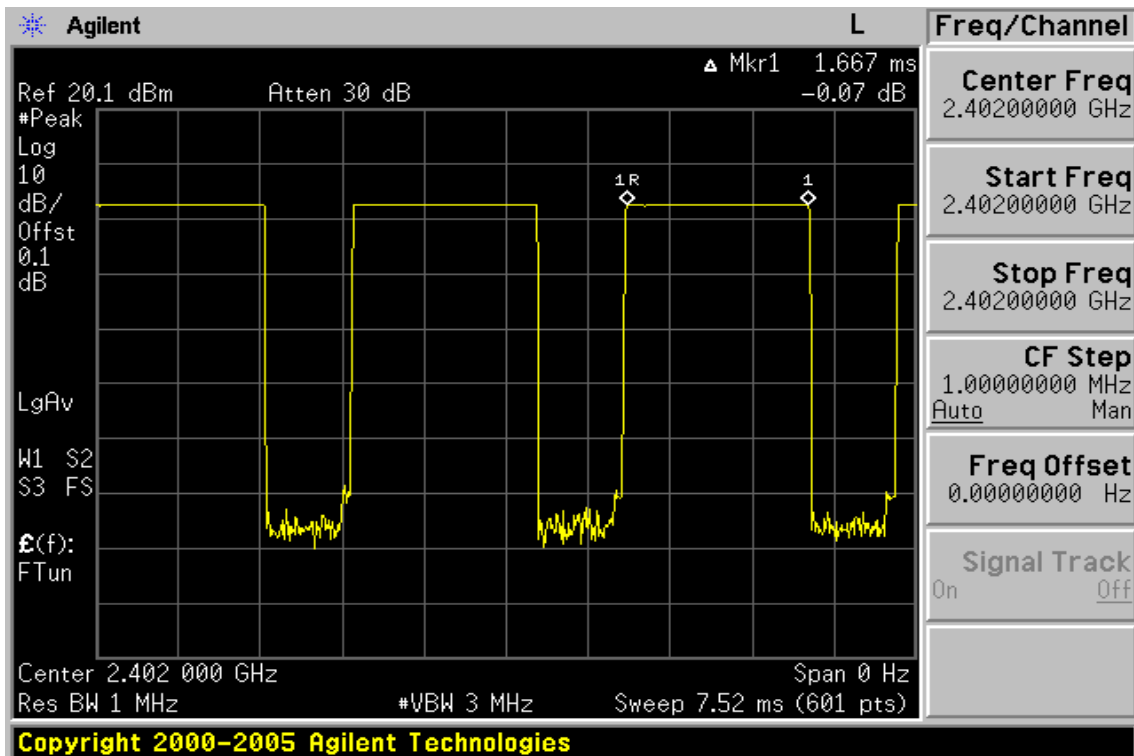

Unless otherwise stated the results shown in this test report refer only to the sample(s) tested and such sample(s) are retained for 90 days only. This test report cannot be reproduced, except in full, without prior written permission of the Company. 除非另有說明，此報告結果僅對測試之樣品負責，同時此樣品僅保留 90 天。本報告未經本公司書面許可，不可部份複製。 This document is issued by the Company subject to its General Conditions of Service (www.sgs.com/terms_and_conditions.htm) and Terms and Conditions for Electronic Documents (www.sgs.com/terms_e-document.htm). Attention is drawn to the limitations of liability, indemnification and jurisdictional issues established therein. Even if printed this electronic document is to be treated as an original within the meaning of UCP 600 article 20b. The authenticity of this document may be verified at www.sgs.com/site/authentication. Any holder of this document is advised that information contained hereon reflects the Company's findings at the time of its intervention only and within the limits of client's instructions, if any. The Company's sole responsibility is to its Client and this document does not exonerate parties to a transaction from exercising all their rights and obligations under the transaction documents.

DH5

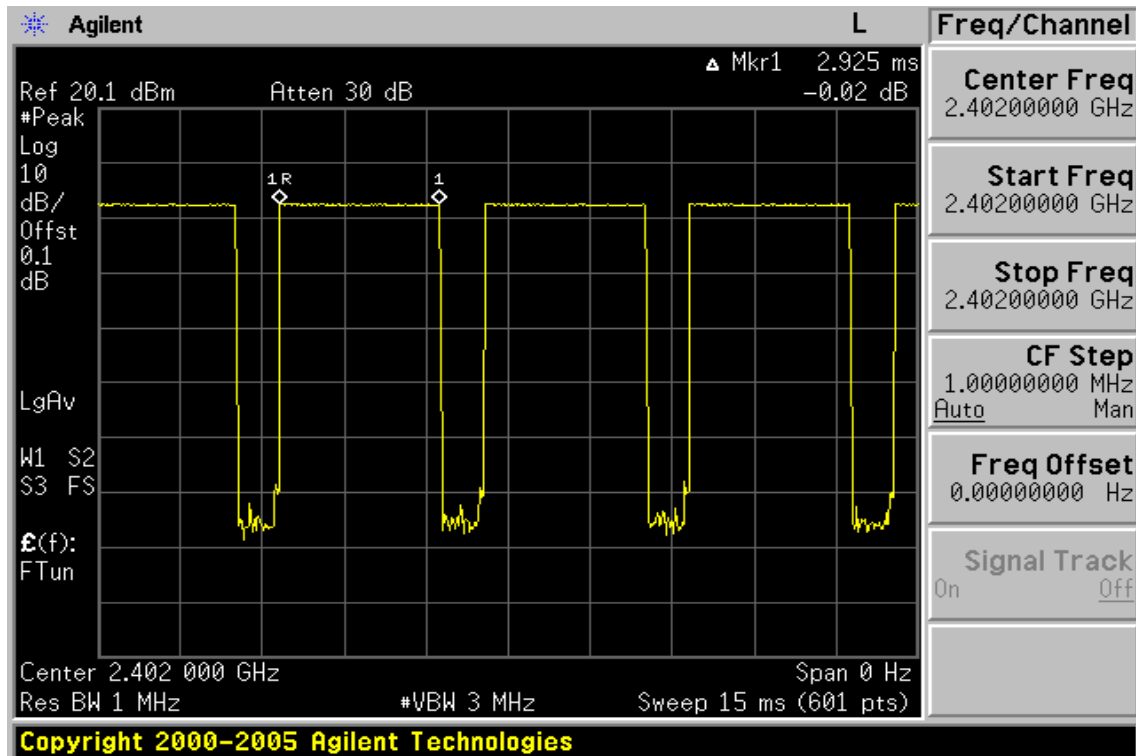

CH-Mid

DH1

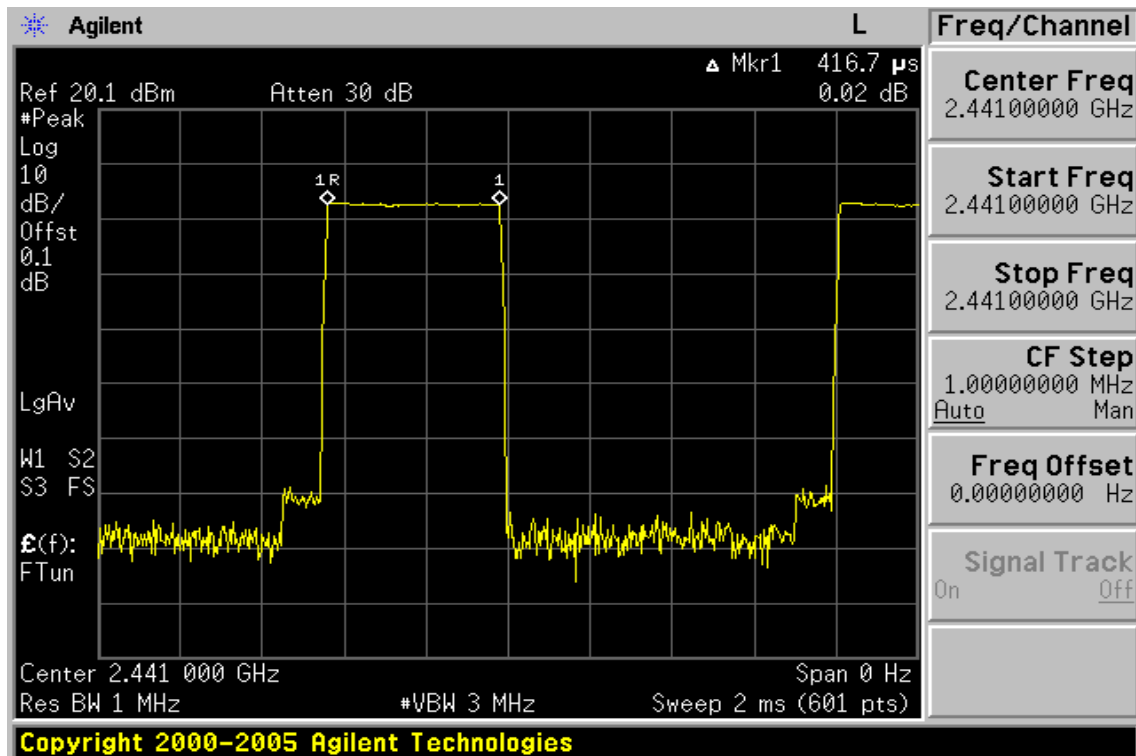

Unless otherwise stated the results shown in this test report refer only to the sample(s) tested and such sample(s) are retained for 90 days only. This test report cannot be reproduced, except in full, without prior written permission of the Company. 除非另有說明，此報告結果僅對測試之樣品負責，同時此樣品僅保留 90 天。本報告未經本公司書面許可，不可部份複製。 This document is issued by the Company subject to its General Conditions of Service (www.sgs.com/terms_and_conditions.htm) and Terms and Conditions for Electronic Documents (www.sgs.com/terms_e-document.htm). Attention is drawn to the limitations of liability, indemnification and jurisdictional issues established therein. Even if printed this electronic document is to be treated as an original within the meaning of UCP 600 article 20b. The authenticity of this document may be verified at www.sgs.com/authentication. Any holder of this document is advised that information contained hereon reflects the Company's findings at the time of its intervention only and within the limits of client's instructions, if any. The Company's sole responsibility is to its Client and this document does not exonerate parties to a transaction from exercising all their rights and obligations under the transaction documents.

DH3

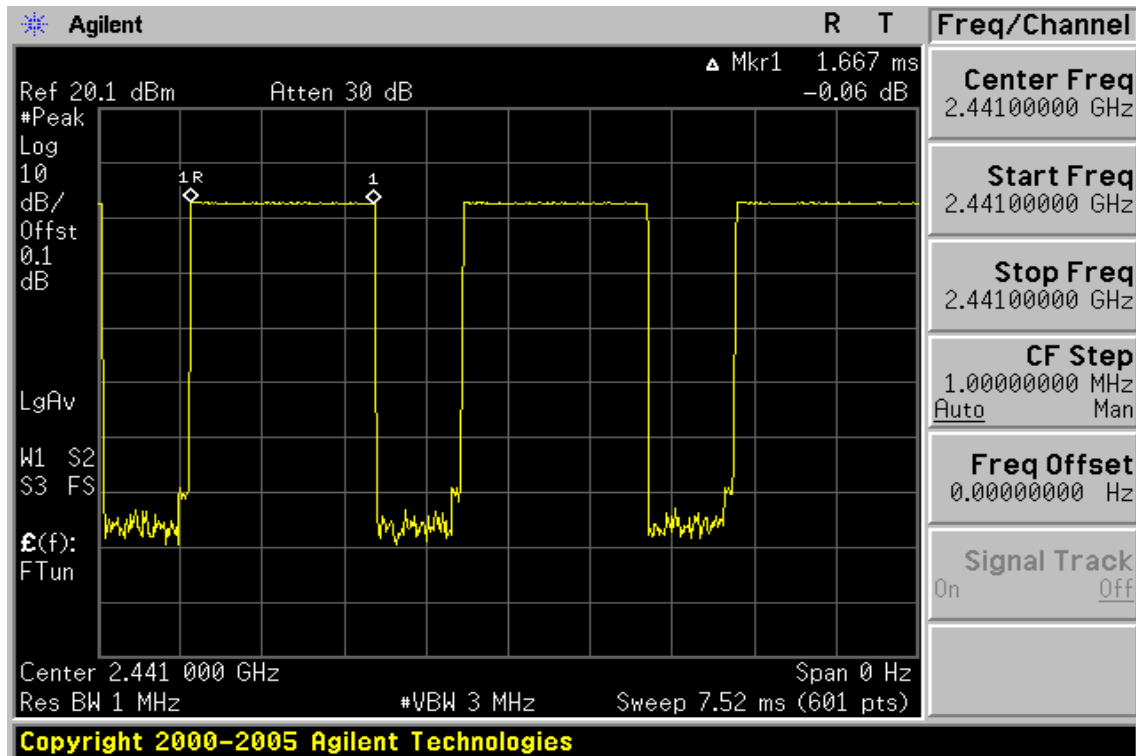

DH5

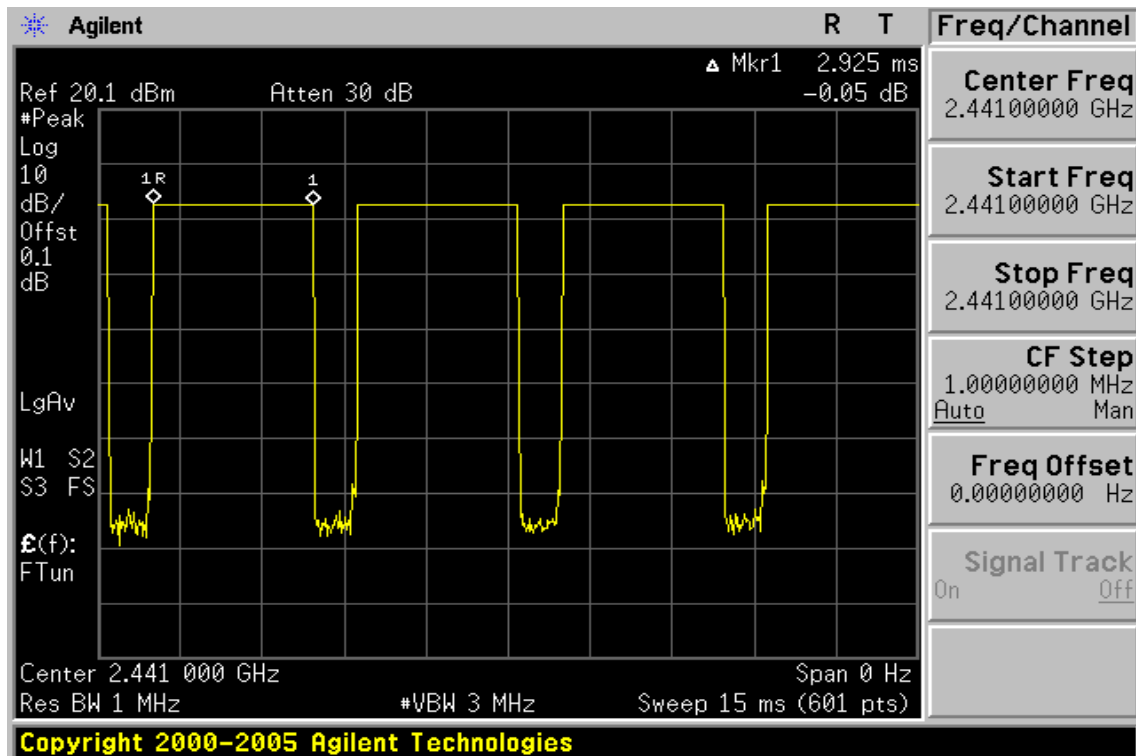

Unless otherwise stated the results shown in this test report refer only to the sample(s) tested and such sample(s) are retained for 90 days only. This test report cannot be reproduced, except in full, without prior written permission of the Company. 除非另有說明，此報告結果僅對測試之樣品負責，同時此樣品僅保留 90 天。本報告未經本公司書面許可，不可部份複製。 This document is issued by the Company subject to its General Conditions of Service (www.sgs.com/terms_and_conditions.htm) and Terms and Conditions for Electronic Documents (www.sgs.com/terms_e-document.htm). Attention is drawn to the limitations of liability, indemnification and jurisdictional issues established therein. Even if printed this electronic document is to be treated as an original within the meaning of UCP 600 article 20b. The authenticity of this document may be verified at www.sgs.com/authentication. Any holder of this document is advised that information contained hereon reflects the Company's findings at the time of its intervention only and within the limits of client's instructions, if any. The Company's sole responsibility is to its Client and this document does not exonerate parties to a transaction from exercising all their rights and obligations under the transaction documents.

**CH-High
DH1**

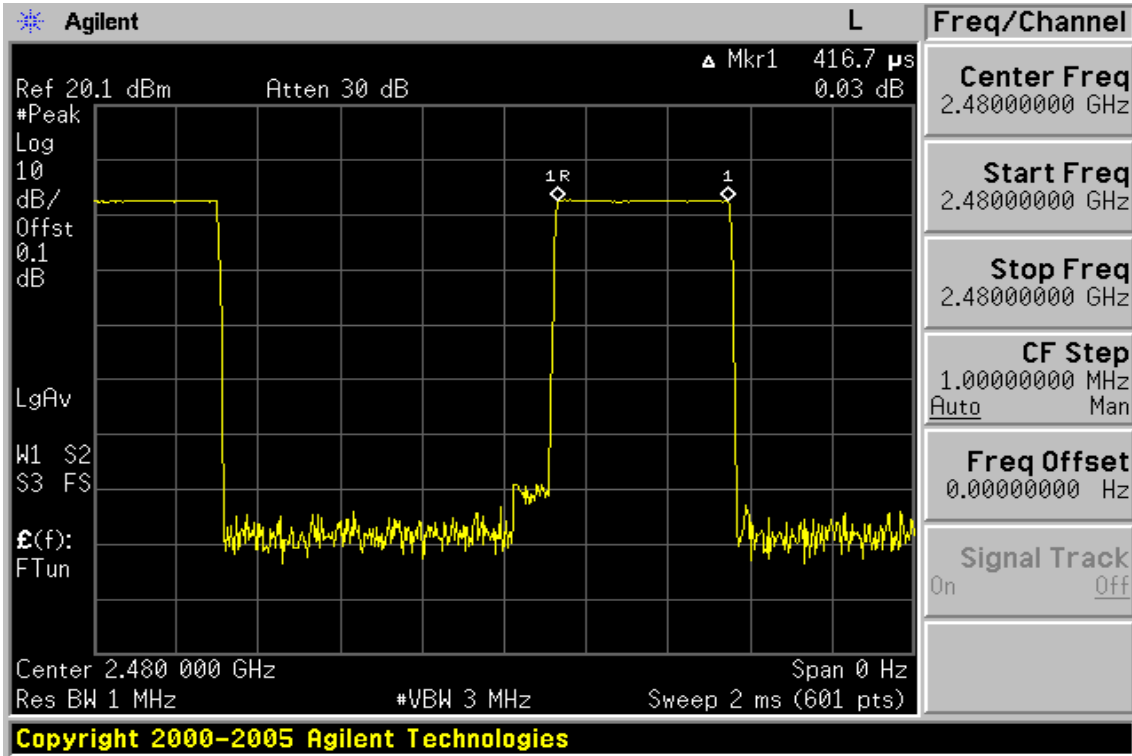

DH3

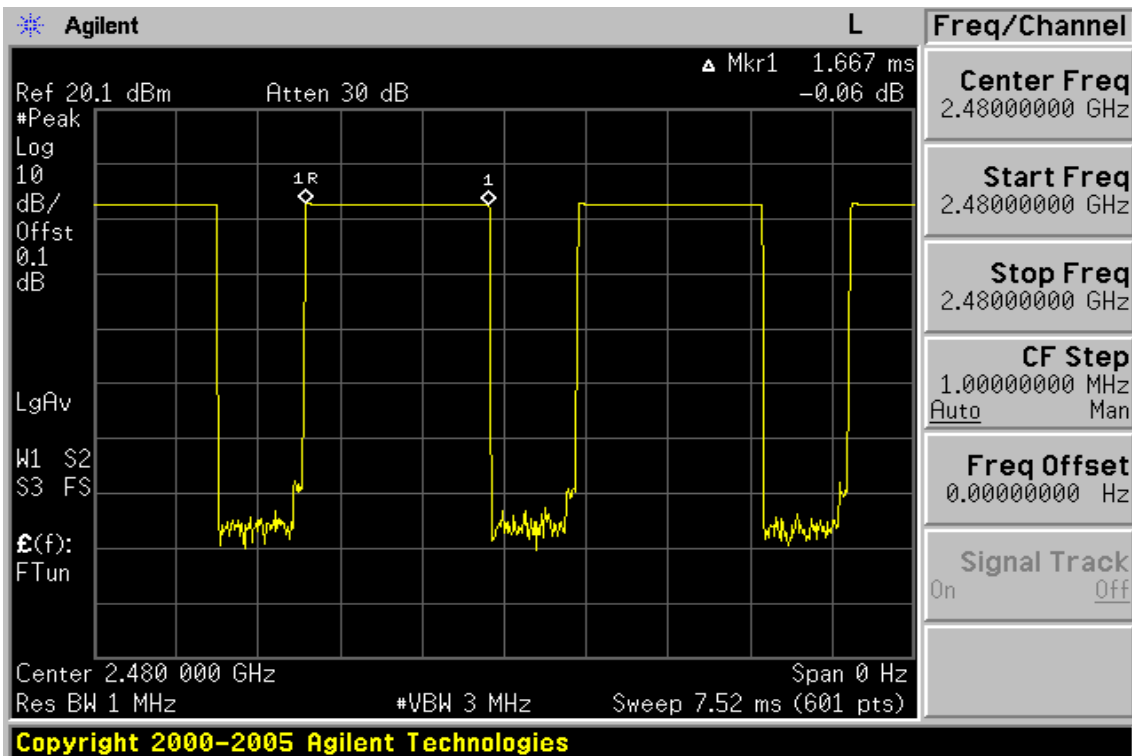

Unless otherwise stated the results shown in this test report refer only to the sample(s) tested and such sample(s) are retained for 90 days only. This test report cannot be reproduced, except in full, without prior written permission of the Company. 除非另有說明，此報告結果僅對測試之樣品負責，同時此樣品僅保留 90 天。本報告未經本公司書面許可，不可部份複製。 This document is issued by the Company subject to its General Conditions of Service (www.sgs.com/terms_and_conditions.htm) and Terms and Conditions for Electronic Documents (www.sgs.com/terms_e-document.htm). Attention is drawn to the limitations of liability, indemnification and jurisdictional issues established therein. Even if printed this electronic document is to be treated as an original within the meaning of UCP 600 article 20b. The authenticity of this document may be verified at www.sgs.com/authentication. Any holder of this document is advised that information contained hereon reflects the Company's findings at the time of its intervention only and within the limits of client's instructions, if any. The Company's sole responsibility is to its Client and this document does not exonerate parties to a transaction from exercising all their rights and obligations under the transaction documents.

DH5

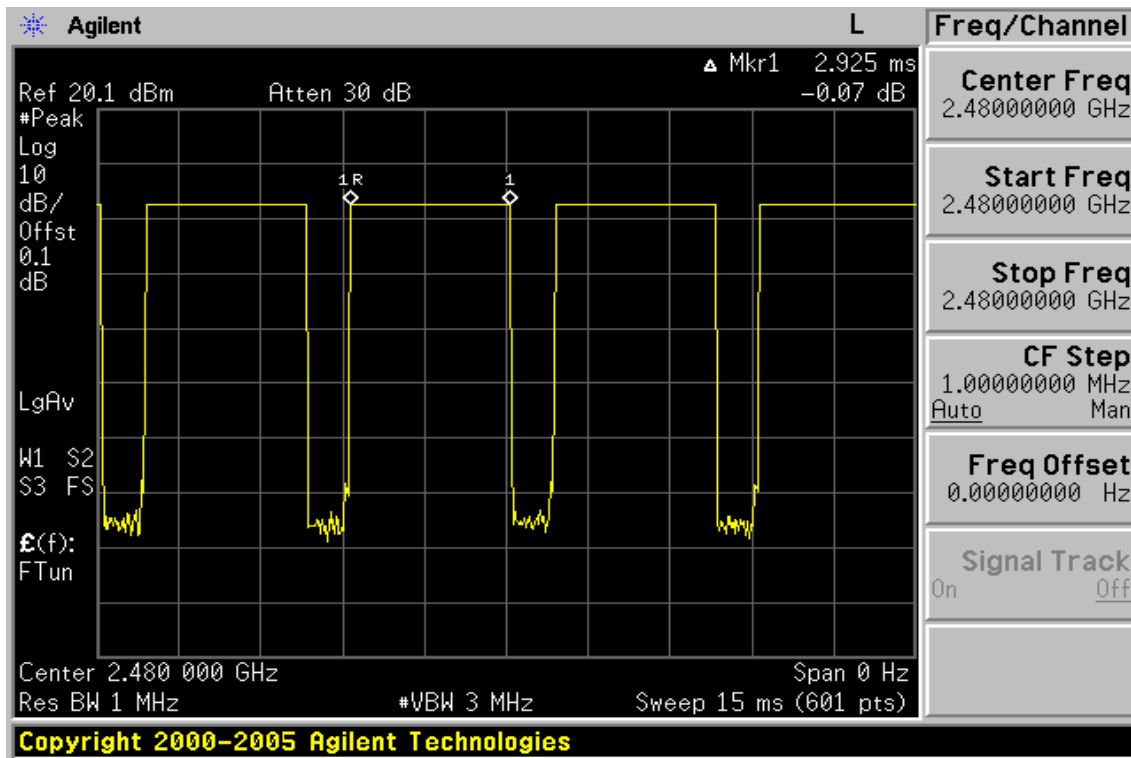

Unless otherwise stated the results shown in this test report refer only to the sample(s) tested and such sample(s) are retained for 90 days only. This test report cannot be reproduced, except in full, without prior written permission of the Company. 除非另有說明，此報告結果僅對測試之樣品負責，同時此樣品僅保留 90 天。本報告未經本公司書面許可，不可部份複製。 This document is issued by the Company subject to its General Conditions of Service (www.sgs.com/terms_and_conditions.htm) and Terms and Conditions for Electronic Documents (www.sgs.com/terms_e-document.htm). Attention is drawn to the limitations of liability, indemnification and jurisdictional issues established therein. Even if printed this electronic document is to be treated as an original within the meaning of UCP 600 article 20b. The authenticity of this document may be verified at www.sgs.com/site/authentication. Any holder of this document is advised that information contained hereon reflects the Company's findings at the time of its intervention only and within the limits of client's instructions, if any. The Company's sole responsibility is to its Client and this document does not exonerate parties to a transaction from exercising all their rights and obligations under the transaction documents.

12. Peak Power Spectral Density

12.1. Standard Applicable:

According to §15.247(d), for direct sequence systems, the peak power spectral density conducted from the intentional radiator to the antenna shall not be greater than 8 dBm in any 3kHz band during any time interval of continuous transmission.

12.2. Measurement Equipment Used:

Refer to section 6.2 for details.

12.3. Test Set-up:

Refer to section 6.3 for details.

12.4. Measurement Procedure:

1. Place the EUT on the table and set it in transmitting mode.
2. Remove the antenna from the EUT and then connect a low loss RF cable from the antenna port to the spectrum analyzer.
3. Set the spectrum analyzer as RBW = 3KHz, VBW = 10KHz, Span = 1.5MHz, Sweep=100s
4. Record the max. reading.
5. Repeat above procedures until all frequency measured were complete.

12.5. Measurement Result:

BDR Mode

CH	RF Power Density Reading (dBm)	Cable loss (dB)	RF Power Density Level (dBm)	Maximum Limit (dBm)
Low	3.73	0.00	3.73	8
Mid	3.99	0.00	3.99	8
High	3.64	0.00	3.64	8

offset 0.2dB

Note: Refer to next page for plots.

Power Spectral Density Test Plot (CH-Low) (BDR)

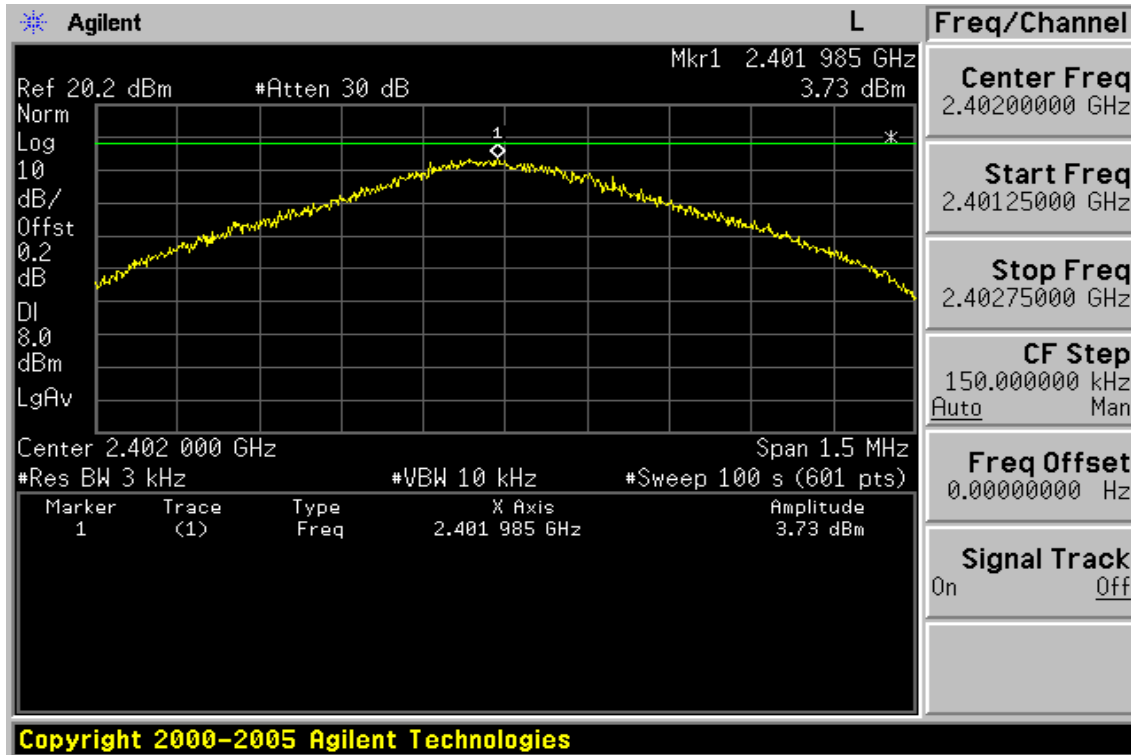

Power Spectral Density Test Plot (CH-Mid) (BDR)

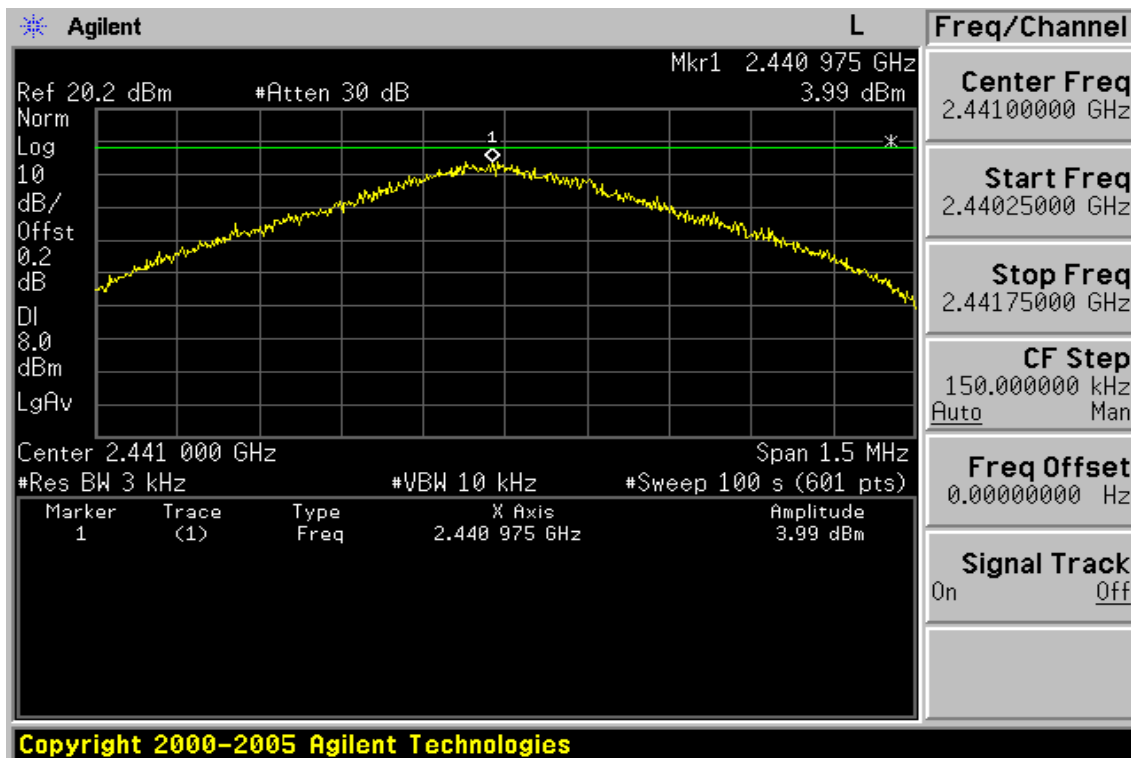

Unless otherwise stated the results shown in this test report refer only to the sample(s) tested and such sample(s) are retained for 90 days only. This test report cannot be reproduced, except in full, without prior written permission of the Company. 除非另有說明，此報告結果僅對測試之樣品負責，同時此樣品僅保留 90 天。本報告未經本公司書面許可，不可部份複製。 This document is issued by the Company subject to its General Conditions of Service (www.sgs.com/terms_and_conditions.htm) and Terms and Conditions for Electronic Documents (www.sgs.com/terms_e-document.htm). Attention is drawn to the limitations of liability, indemnification and jurisdictional issues established therein. Even if printed this electronic document is to be treated as an original within the meaning of UCP 600 article 20b. The authenticity of this document may be verified at www.sgs.com/authentication. Any holder of this document is advised that information contained hereon reflects the Company's findings at the time of its intervention only and within the limits of client's instructions, if any. The Company's sole responsibility is to its Client and this document does not exonerate parties to a transaction from exercising all their rights and obligations under the transaction documents.

Power Spectral Density Test Plot (CH-High) (BDR)

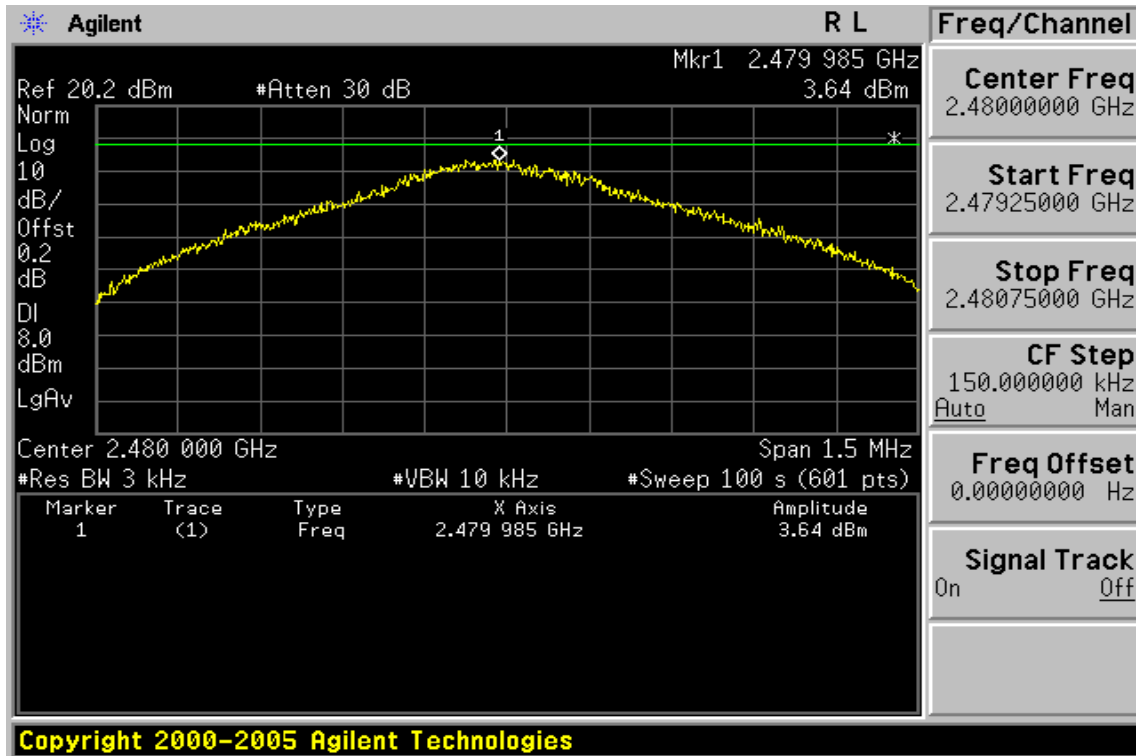

Unless otherwise stated the results shown in this test report refer only to the sample(s) tested and such sample(s) are retained for 90 days only. This test report cannot be reproduced, except in full, without prior written permission of the Company. 除非另有說明，此報告結果僅對測試之樣品負責，同時此樣品僅保留 90 天。本報告未經本公司書面許可，不可部份複製。 This document is issued by the Company subject to its General Conditions of Service (www.sgs.com/terms_and_conditions.htm) and Terms and Conditions for Electronic Documents (www.sgs.com/terms_e-document.htm). Attention is drawn to the limitations of liability, indemnification and jurisdictional issues established therein. Even if printed this electronic document is to be treated as an original within the meaning of UCP 600 article 20b. The authenticity of this document may be verified at www.sgs.com/site/authentication. Any holder of this document is advised that information contained hereon reflects the Company's findings at the time of its intervention only and within the limits of client's instructions, if any. The Company's sole responsibility is to its Client and this document does not exonerate parties to a transaction from exercising all their rights and obligations under the transaction documents.

13. 20dB Bandwidth

13.1. Standard Applicable:

According to §15.247(a)(1), for frequency hopping systems operating in the 2400MHz-2483.5 MHz no limit for 20dB bandwidth.

13.2. Measurement Equipment Used:

Refer to section 6.2 for details.

13.3. Test Set-up:

Refer to section 6.3 for details.

13.4. Measurement Procedure:

1. Place the EUT on the table and set it in transmitting mode.
2. Remove the antenna from the EUT and then connect a low loss RF cable from the antenna port to the spectrum analyzer.
3. Set the spectrum analyzer as RBW=10KHz (1 % of Bandwidth.), Span= 3MHz, Sweep=auto
4. Mark the peak frequency and -20dB (upper and lower) frequency.
5. Repeat above procedures until all frequency measured were complete.

13.5. Measurement Result:

BDR Mode

CH	Bandwidth (MHz)
Lower	0.777
Mid	0.887
Higher	0.927

EDR Mode

CH	Bandwidth (MHz)	2/3 Bandwidth (MHz)
Lower	1.481	0.987
Mid	1.482	0.988
Higher	1.495	0.997

Unless otherwise stated the results shown in this test report refer only to the sample(s) tested and such sample(s) are retained for 90 days only. This test report cannot be reproduced, except in full, without prior written permission of the Company. 除非另有說明，此報告結果僅對測試之樣品負責，同時此樣品僅保留 90 天。本報告未經本公司書面許可，不可部份複製。 This document is issued by the Company subject to its General Conditions of Service (www.sgs.com/terms_and_conditions.htm) and Terms and Conditions for Electronic Documents (www.sgs.com/terms_e-document.htm). Attention is drawn to the limitations of liability, indemnification and jurisdictional issues established therein. Even if printed this electronic document is to be treated as an original within the meaning of UCP 600 article 20b. The authenticity of this document may be verified at www.sgsonsite.com/authentication. Any holder of this document is advised that information contained hereon reflects the Company's findings at the time of its intervention only and within the limits of client's instructions, if any. The Company's sole responsibility is to its Client and this document does not exonerate parties to a transaction from exercising all their rights and obligations under the transaction documents.

BDR Mode
20dB Bandwidth Test Data CH-Low

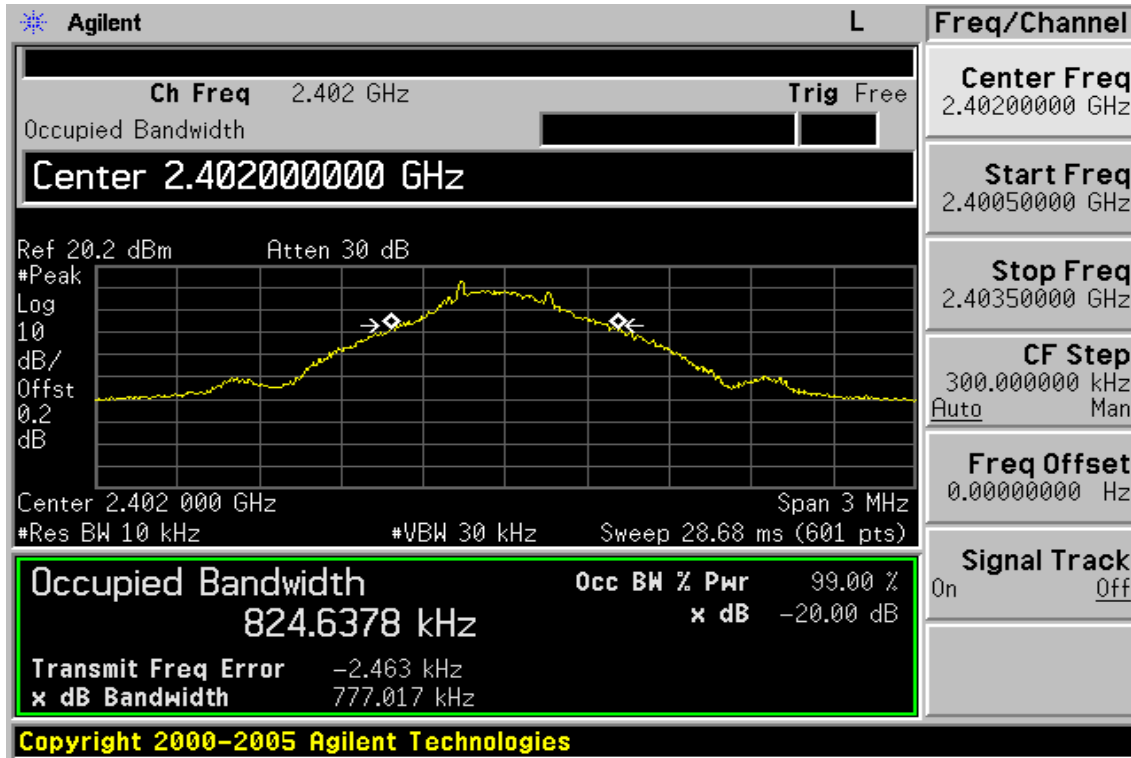

20dB Bandwidth Test Data CH-Mid

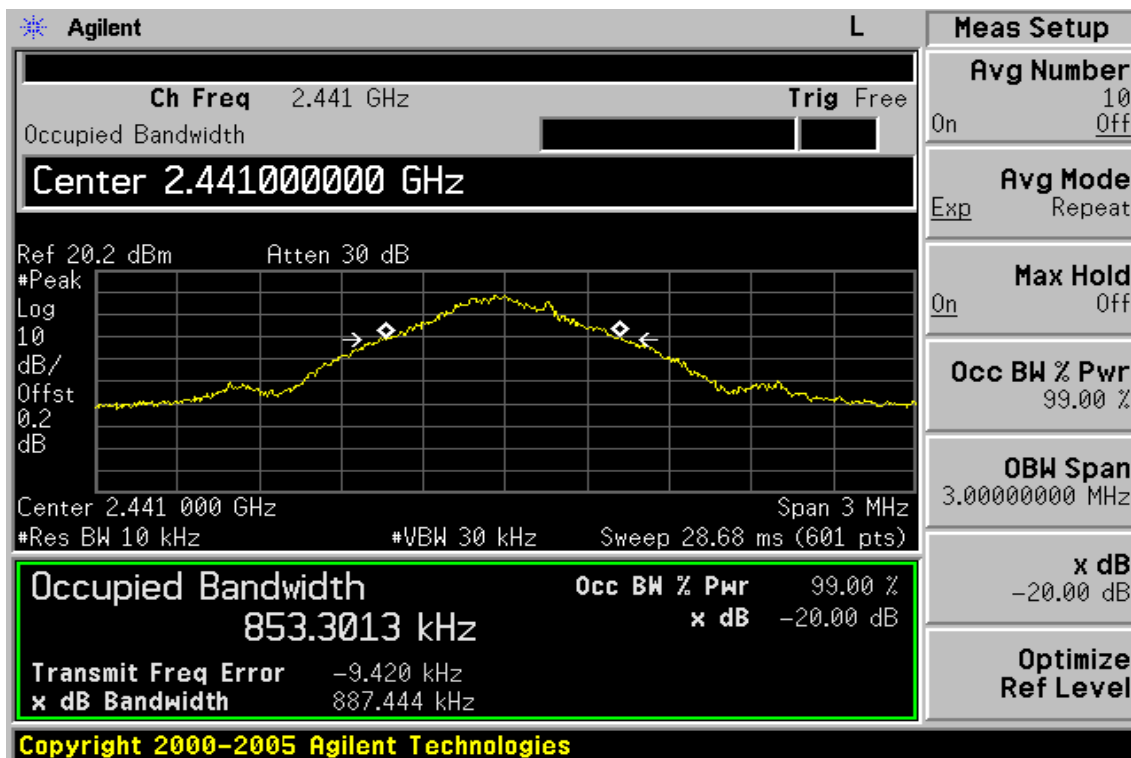

Unless otherwise stated the results shown in this test report refer only to the sample(s) tested and such sample(s) are retained for 90 days only. This test report cannot be reproduced, except in full, without prior written permission of the Company. 除非另有說明，此報告結果僅對測試之樣品負責，同時此樣品僅保留 90 天。本報告未經本公司書面許可，不可部份複製。 This document is issued by the Company subject to its General Conditions of Service (www.sgs.com/terms_and_conditions.htm) and Terms and Conditions for Electronic Documents (www.sgs.com/terms_e-document.htm). Attention is drawn to the limitations of liability, indemnification and jurisdictional issues established therein. Even if printed this electronic document is to be treated as an original within the meaning of UCP 600 article 20b. The authenticity of this document may be verified at www.sgs.com/authentication. Any holder of this document is advised that information contained hereon reflects the Company's findings at the time of its intervention only and within the limits of client's instructions, if any. The Company's sole responsibility is to its Client and this document does not exonerate parties to a transaction from exercising all their rights and obligations under the transaction documents.

20dB Bandwidth Test Data CH-High

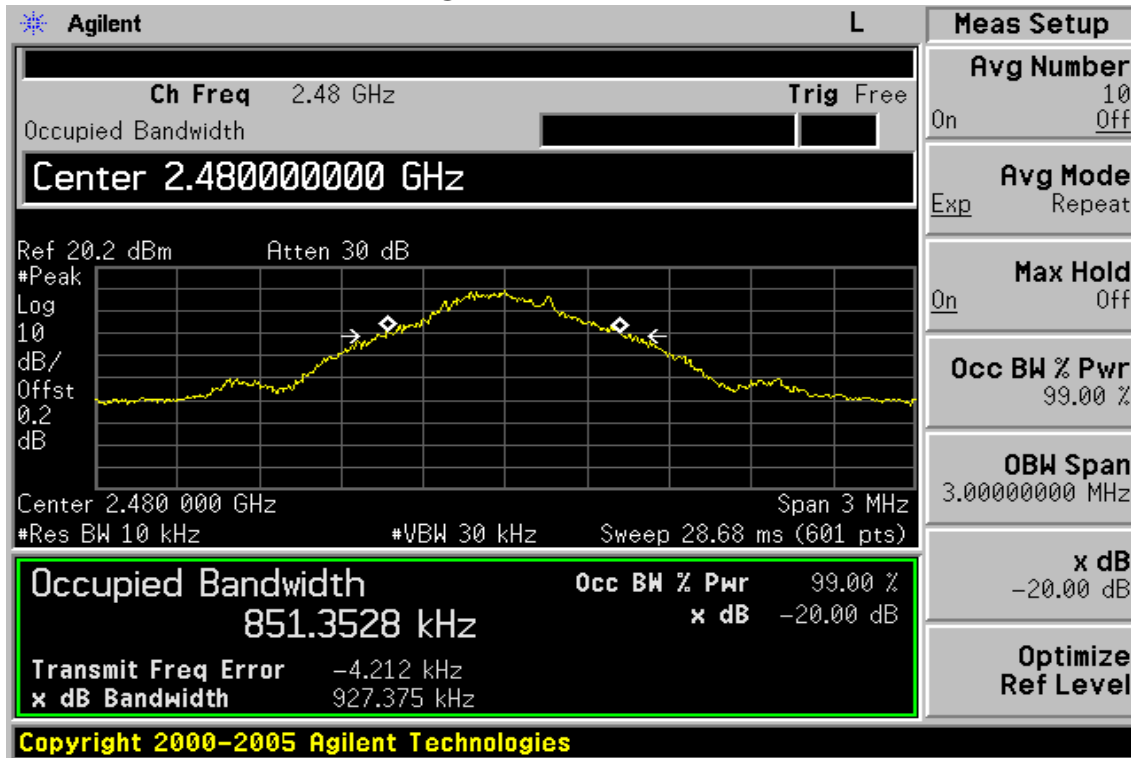

Unless otherwise stated the results shown in this test report refer only to the sample(s) tested and such sample(s) are retained for 90 days only. This test report cannot be reproduced, except in full, without prior written permission of the Company. 除非另有說明，此報告結果僅對測試之樣品負責，同時此樣品僅保留 90 天。本報告未經本公司書面許可，不可部份複製。 This document is issued by the Company subject to its General Conditions of Service (www.sgs.com/terms_and_conditions.htm) and Terms and Conditions for Electronic Documents (www.sgs.com/terms_e-document.htm). Attention is drawn to the limitations of liability, indemnification and jurisdictional issues established therein. Even if printed this electronic document is to be treated as an original within the meaning of UCP 600 article 20b. The authenticity of this document may be verified at www.sgs.com/authentication. Any holder of this document is advised that information contained hereon reflects the Company's findings at the time of its intervention only and within the limits of client's instructions, if any. The Company's sole responsibility is to its Client and this document does not exonerate parties to a transaction from exercising all their rights and obligations under the transaction documents.

EDR Mode

20dB Bandwidth Test Data CH-Low

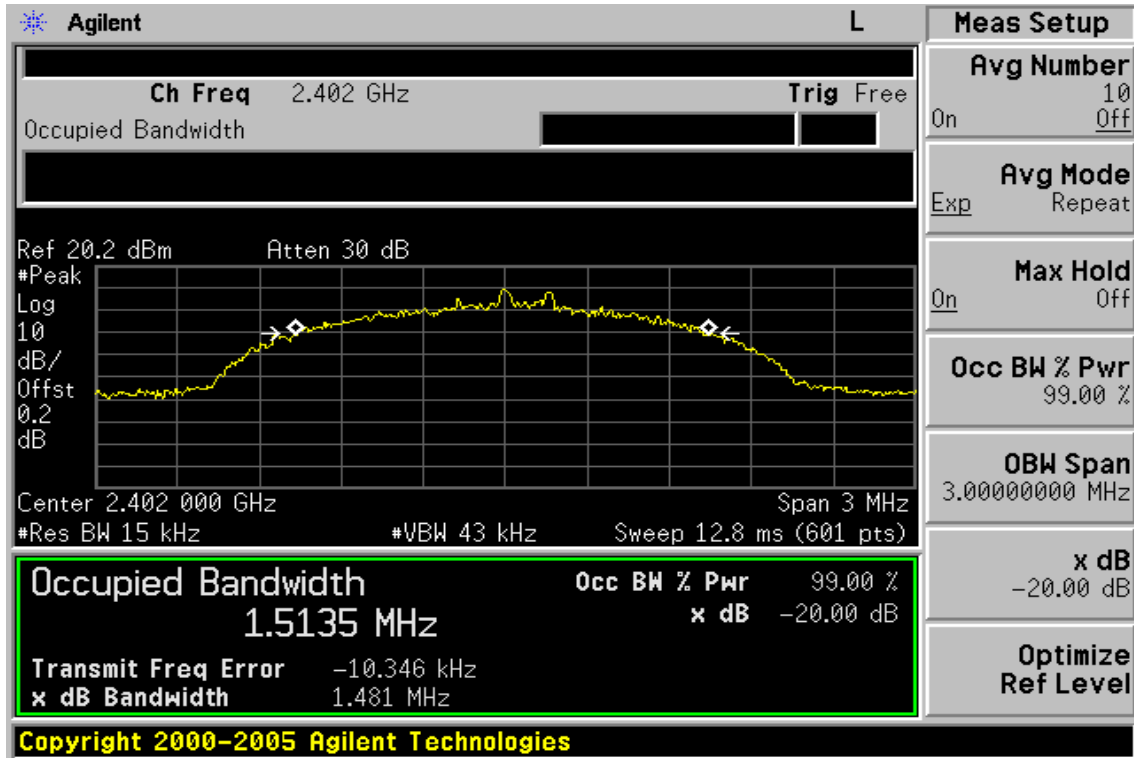

20dB Bandwidth Test Data CH-Mid

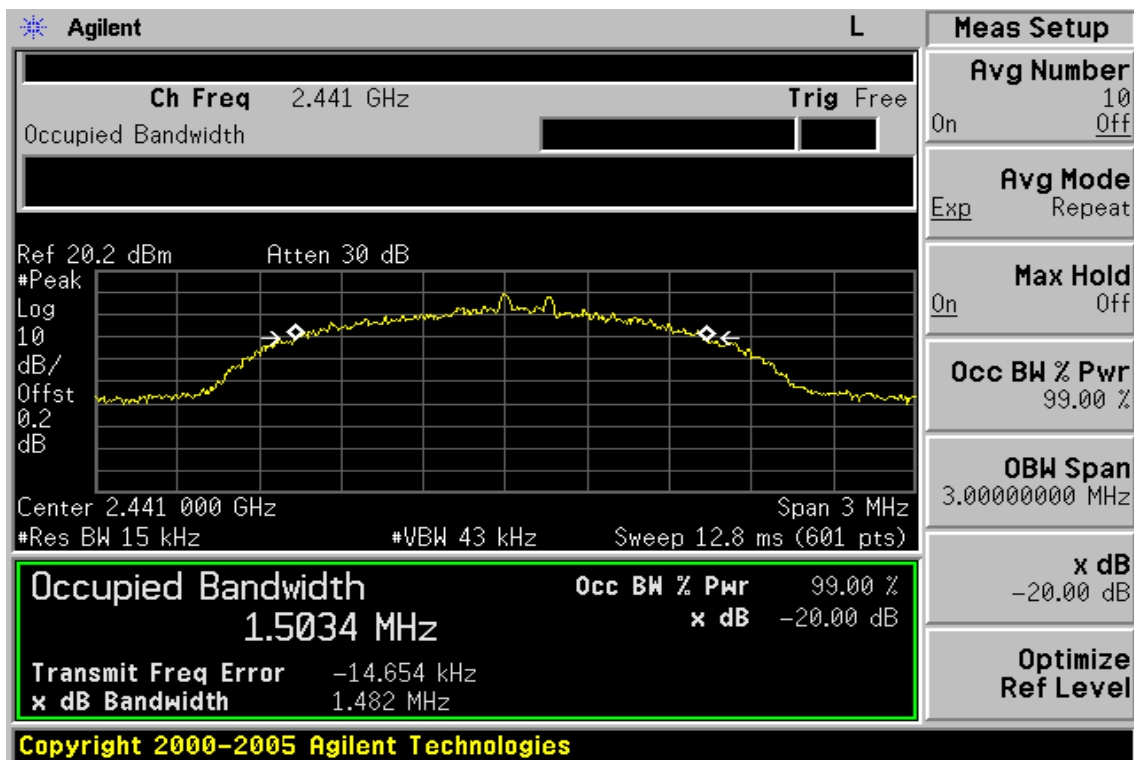

Unless otherwise stated the results shown in this test report refer only to the sample(s) tested and such sample(s) are retained for 90 days only. This test report cannot be reproduced, except in full, without prior written permission of the Company. 除非另有說明，此報告結果僅對測試之樣品負責，同時此樣品僅保留 90 天。本報告未經本公司書面許可，不可部份複製。 This document is issued by the Company subject to its General Conditions of Service (www.sgs.com/terms_and_conditions.htm) and Terms and Conditions for Electronic Documents (www.sgs.com/terms_e-document.htm). Attention is drawn to the limitations of liability, indemnification and jurisdictional issues established therein. Even if printed this electronic document is to be treated as an original within the meaning of UCP 600 article 20b. The authenticity of this document may be verified at www.sgs.com/site/authentication. Any holder of this document is advised that information contained hereon reflects the Company's findings at the time of its intervention only and within the limits of client's instructions, if any. The Company's sole responsibility is to its Client and this document does not exonerate parties to a transaction from exercising all their rights and obligations under the transaction documents.

20dB Bandwidth Test Data CH-High

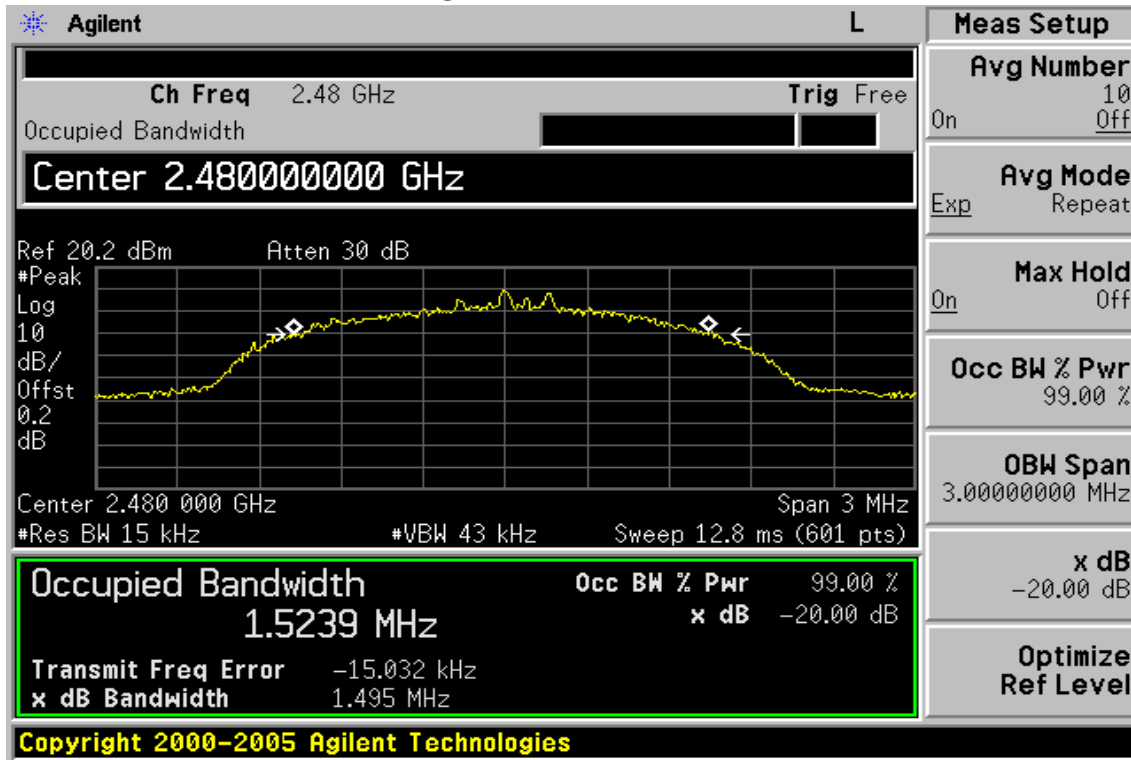

Unless otherwise stated the results shown in this test report refer only to the sample(s) tested and such sample(s) are retained for 90 days only. This test report cannot be reproduced, except in full, without prior written permission of the Company. 除非另有說明，此報告結果僅對測試之樣品負責，同時此樣品僅保留 90 天。本報告未經本公司書面許可，不可部份複製。 This document is issued by the Company subject to its General Conditions of Service (www.sgs.com/terms_and_conditions.htm) and Terms and Conditions for Electronic Documents (www.sgs.com/terms_e-document.htm). Attention is drawn to the limitations of liability, indemnification and jurisdictional issues established therein. Even if printed this electronic document is to be treated as an original within the meaning of UCP 600 article 20b. The authenticity of this document may be verified at www.sgs.com/site/authentication. Any holder of this document is advised that information contained hereon reflects the Company's findings at the time of its intervention only and within the limits of client's instructions, if any. The Company's sole responsibility is to its Client and this document does not exonerate parties to a transaction from exercising all their rights and obligations under the transaction documents.

14. ANTENNA REQUIREMENT

14.1. Standard Applicable:

According to §15.203, an intentional radiator shall be designed to ensure that no antenna other than furnished by the responsible party shall be used with the device.

And according to §15.246(1), if transmitting antennas of directional gain greater than 6dBi are used the power shall be reduced by the amount in dB that the directional gain of the antenna exceeds 6 dBi.

14.2. Antenna Connected Construction:

The directional gains of antenna used for transmitting is 2 dBi, and the antenna connector is designed with permanent attachment and no consideration of replacement. Please see EUT photo for details.