



A Test Lab Techno Corp.

No.140-1, Chang-an St., Bade City, Tao-Yuan County 334, Taiwan (R.O.C.)
Tel : +886-3-2710188 / Fax : +886-3-2710190

Part 15 C Measurement Report



Report No.	: 0910FR11-01
Applicant	: PERFECT TECH R&D CO., LTD
Product Type	: NANO USB DONGLE
Trade Mark	: PERFECT
Model No.	: BT 06K
FCC ID	: XSK-BT06K
Dates of Test	: Oct. 05 ~ 06, 2009
Test Specification	: FCC CFR Title 47 Part 15 Subpart C (15.247) (2008-10) PUBLIC NOTICE :DA 00-705 Filing and Measurement Guidelines for Frequency Hopping Spread Spectrum Systems
Location of Test Lab.	: Chang-an Lab.

1. The test operations have to be performed with cautious behavior, the test results are as attached.
2. The test results are under chamber environment of A Test Lab Techno Corp. A Test Lab Techno Corp. does not assume responsibility for any conclusions and generalizations drawn from the test results with regard to other specimens or samples.
3. The measurement report has to be written approval of A Test Lab Techno Corp. It may only be reproduced or published in full. This report shall not be reproduced except in full, without the written approval of A Test Lab Techno Corp.
4. This document may be altered or revised by A Test Lab Techno. Corp. personnel only, and shall be noted in the revision section of the document.



Miller Lee **20091013**
Approve Signer

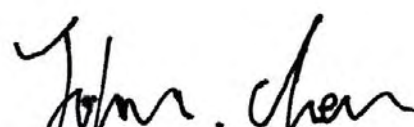

John Cheng **20091013**
Testing Engineer



CERTIFICATION

We hereby verify that:

The test data, data evaluation, test procedures and equipment configurations shown in this report were made in accordance with the procedures given in ANSI C63.4:2003. All test were conducted by A Test Lab Techno Corp. No.140-1, Chang-an St., Bade City, Tao-Yuan County 334, Taiwan (R.O.C.) Also, we attest to the accuracy of each.

We further submit that the energy emitted by the sample EUT tested as described in the report is in compliance with Class B radiated and conducted emission limit of FCC Rules Part 15 Subpart C (15.247).

Product Name : NANO USB DONGLE
Applicant : PERFECT TECH R&D CO., LTD
Applicant Address : NO. 6-20, OUFENG STREET, LUJHU TOWNSHIP 338,
TAOYUAN COUNTY, TAIWAN
Manufacturer : PERFECT TECH R&D CO., LTD
Manufacturer Address : NO. 6-20, OUFENG STREET, LUJHU TOWNSHIP 338,
TAOYUAN COUNTY, TAIWAN
Trade Name : PERFECT
Model No. : BT 06K
FCC ID : XSK-BT06K
EUT Voltage : 5 Vdc (USB Interface)
Applicable Standard : FCC CFR Title 47 Part 15 Subpart C (15.247) (2008-10)
Classification : B
Test Result : Complied

Approved by : 
Miller Lee 2009/10/13

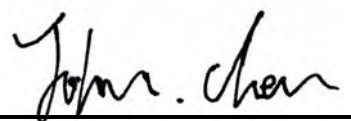
Prepared by : 
John Cheng 2009/10/13

A Test Lab Techno Corp.

No.140-1, Chang-an St., Bade City, Tao-Yuan County 334, Taiwan (R.O.C.)
Tel : 03-2710188 / Fax : 03-2710190



Contents

1. General.....	4
2. Conducted Emissions Requirements	8
3. Radiated Emissions Requirements	12
4. Maximum Conducted Output Power Requirements.....	33
5. Minimum 20dB RF Bandwidth Requirements	43
6. Carrier Frequency Separation Requirements	49
7. Number of Hopping Requirements.....	55
8. Time of Occupancy (Dwell Time) Requirements	59
9. Out of Band Conducted Emissions Requirements.....	66
10. Band Edges Requirements	74
11. Antenna Requirements.....	84



1. General

1.1 Description of Equipment under Test (EUT)

Applicant	:	PERFECT TECH R&D CO., LTD
Applicant Address	:	NO. 6-20, OUFENG STREET, LUJHU TOWNSHIP 338, TAOYUAN COUNTY, TAIWAN
Manufacturer	:	PERFECT TECH R&D CO., LTD
Manufacturer Address	:	NO. 6-20, OUFENG STREET, LUJHU TOWNSHIP 338, TAOYUAN COUNTY, TAIWAN
Product Name	:	NANO USB DONGLE
Trade Name	:	PERFECT
Model No.	:	BT 06K
Frequency Range	:	2402-2480 MHz
Type of Modulation	:	GFSK, $\pi/4$ -DPSK, 8DPSK
Hardware Version	:	BM20R_V1.0
Software Version	:	BM20R_V1
Antenna Type	:	Internal
Antenna Gain	:	2 dBi

1.2 Introduction

The following measurement report is submitted on behalf of **PERFECT TECH R&D CO., LTD** In support of a Class B Digital Device certification in accordance with Part 2 Subpart J and Part 15 Subpart A and B&C of the Commission's and Regulations.



1.3 Summary of Tests

FCC CFR Title 47 Part 15 Subpart C (15.247)			
Reference	Test	Results	Note
15.207	AC Power Conducted Emission	PASS	-----
15.247(c)	Transmitter Radiated Emissions	PASS	-----
15.247(b)	Max. Output Power	PASS	-----
15.247(a)(1)	20dB RF Bandwidth	PASS	-----
15.247(a)(1)(ii)	Carrier Frequency Separation	PASS	-----
15.247(a)(1)(i)	Number of Hopping	PASS	-----
15.247(a)(1)(i)	Time of Occupancy (Dwell Time)	PASS	-----
15.247(c)	Out of Band Conducted Spurious Emission	PASS	-----
15.247(c)	Band Edge Measurement	PASS	-----
15.203	Antenna Requirement	PASS	-----

1.4 Description of Support Equipment

Describe	Manufacturer	Model	Serial Number	Calibration	
				Cal. Date	Due Date
Bluetooth Tester	R&S	CBT	100350	Mar. 11, 2009	Mar. 11, 2010

1.5 Configuration of System under Test

Conducted Emission

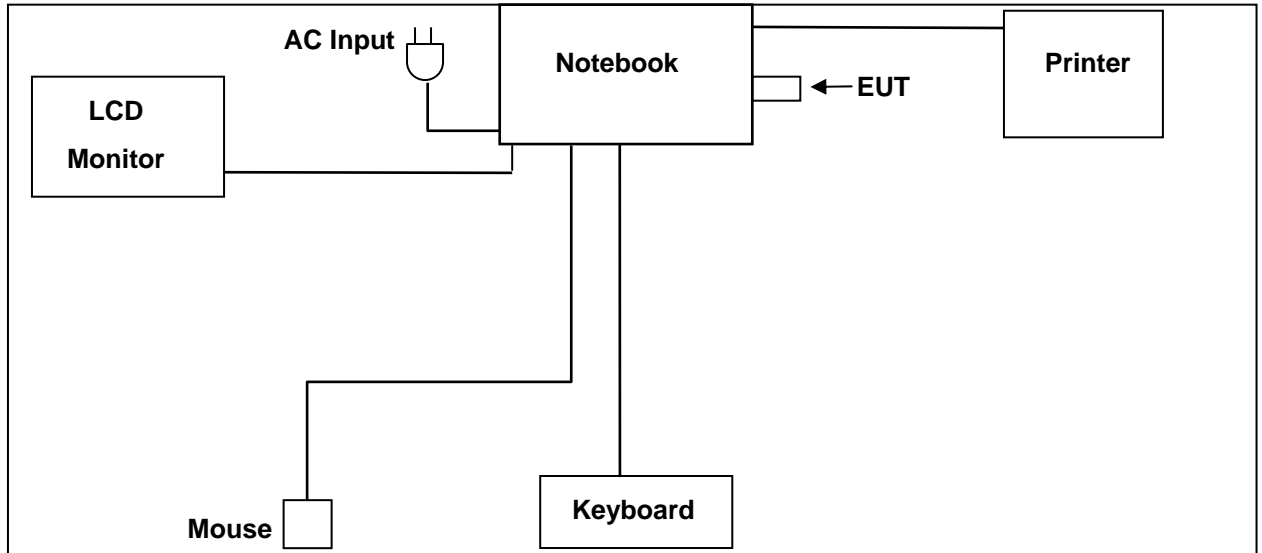

During testing the EUT's USB port connected to the USB port of Notebook. A mouse was connected to the mouse port of Notebook. And a keyboard was connected to the keyboard port of Notebook. And a printer was connected to the parallel port.

Radiated Emission

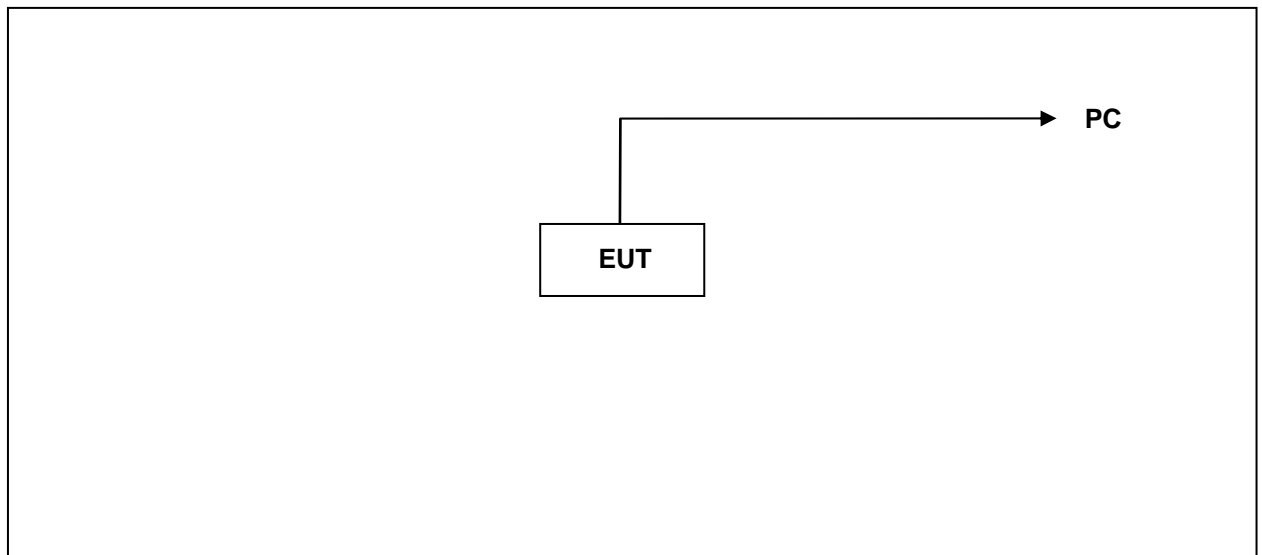

During testing the EUT's USB port connected to the PC.



1.6 Test Facility

Ambient conditions in the laboratory:

Items	Test Item	Required (IEC 68-1)	Actual
Temperature (°C)	ANSI C63.4 CE	15-35	25
Humidity (%RH)		30-60	50
Barometric pressure (mbar)		860-1060	950-1000
Temperature (°C)	ANSI C63.4 RE	15-35	25
Humidity (%RH)		30-60	50
Barometric pressure (mbar)		860-1060	950-1000

Registration Number : 854525

Designation Number : TW1330

Test Site Name: A Test Lab Techno Corp.

Test Site Location: No. 140 -1, Changan Street, Bade City, Taoyuan County, Taiwan R.O.C.

TEL: 886-3-271-0188 FAX: 886-3-271-0190

The chamber meets the characteristics of ANSI C63.4-2003. This site is on file with the FCC.



2. Conducted Emissions Requirements

2.1 Test Procedure

The EUT and simulators are connected to the main power through a line impedance stabilization network (L.I.S.N.). This provides a 50 ohm /50uH coupling impedance for the measuring equipment. The peripheral devices are also connected to the main power through a LISN that provides a 50ohm /50uH coupling impedance with 50ohm termination. (Please refer to the block diagram of the test setup and photographs.)

Both sides of A.C. line are checked for maximum conducted interference. In order to find the maximum emission, the relative positions of equipment and all of the interface cables must be changed according to ANSI C63.4: 2003 on conducted measurement.

Conducted emissions were investigated over the frequency range from 0.15MHz to 30MHz using a receiver bandwidth of 9 kHz.

2.2 Limits

Frequency range (MHz)	Limits (dBuV)	
	Quasi-peak	Average
0.15 to 0.50	66 to 56	56 to 46
0.50 to 5.0	56	46
5.0 to 30	60	50

2.3 Test Equipment List

Describe	Manufacturer	Model	Serial Number	Calibration	
				Cal. Date	Due Date
Spectrum Analyzer	Advantest	R3132	160300103	Mar. 10, 2009	Mar. 10, 2010
Test Receiver	R&S	ESCI	100367	Jul. 01, 2009	Jul. 01, 2010
LISN	EMCO	3816/2 SH	00060110	Jun. 17, 2009	Jun. 17, 2010
LISN	EMCO	3816/2 SH	00060111	Jun. 29, 2009	Jun. 29, 2010
Transient Limiter	ELECTRO-METRICS	EM-7600	777	Sep. 22, 2009	Sep. 22, 2010

2.4 Test Instruments Configuration

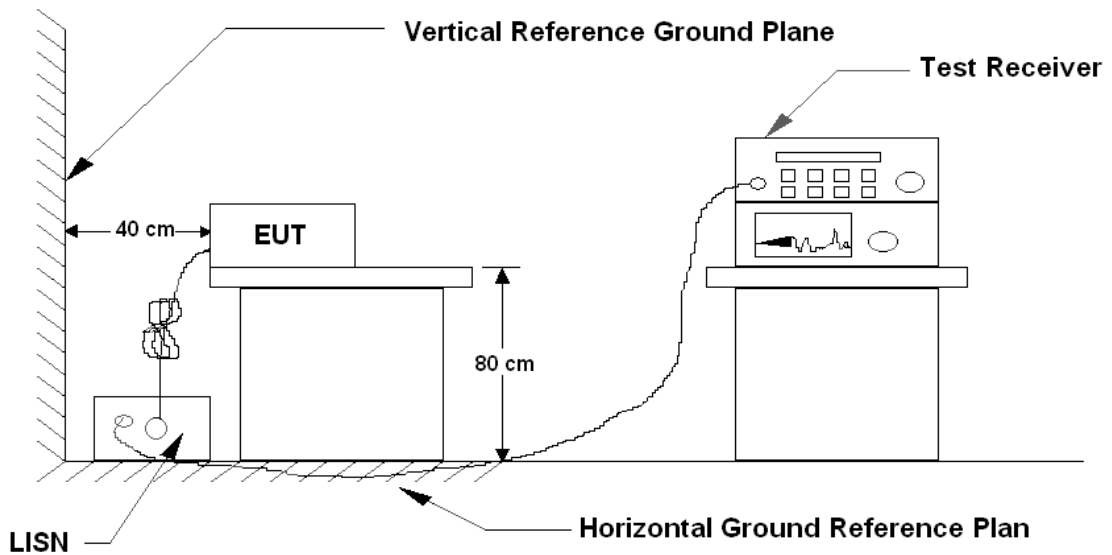

2.5 Test Results

EUT : NANO USB DONGLE

Model No. : BT 06K

Test Mode : Normal Link

Test Date : 10/06/2009

Please refer to next page of detail testing data.

Notes:

1. L1: One end & Ground L2: The other end & Ground
2. Height of table on which the EUT was placed: 0.8 m.
3. The Quasi-Peak Value have already met the Average Value Limit showed on above limits.
4. The above test results are obtained under the normal condition.



File :USB
80.0 dBuV

Data :#1

Date: 2009/10/06

Time: 上午 02:02:03

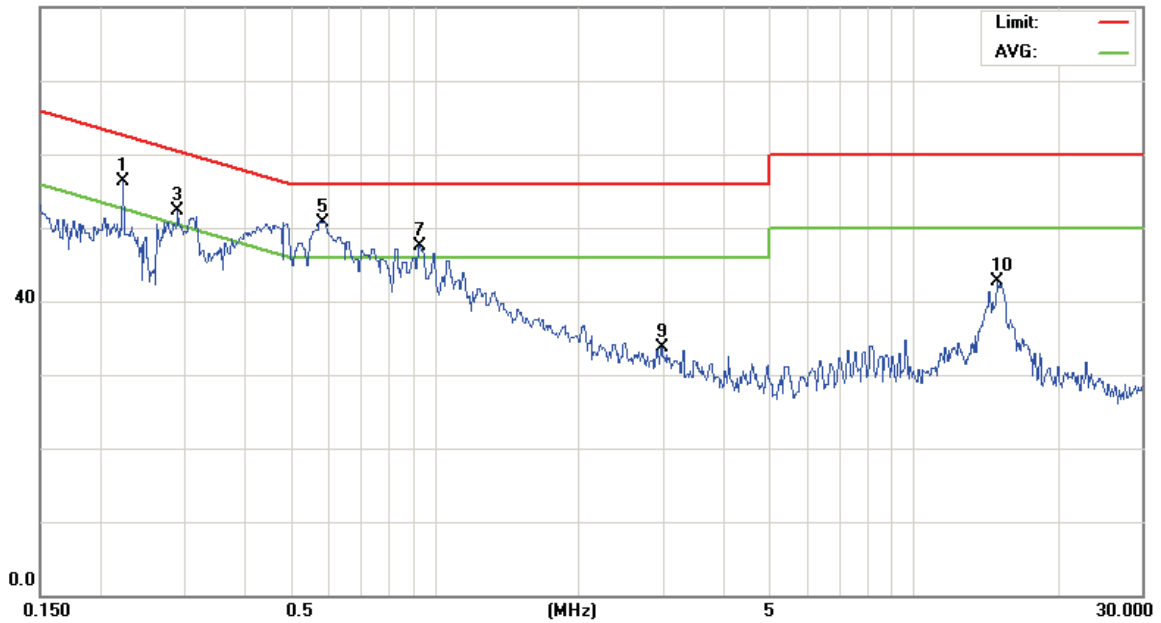

Site site#1 Phase: **L1** Temperature: 26 °C
 Limit: CISPR22 Class B Conduction(QP) Power: AC 120V/60Hz Humidity: 55 %
 EUT:
 M/N: 09-0239-EO
 Mode: Normal Link
 Note:

No.	Mk.	Freq. MHz	Reading Level dBuV	Correct Factor dB	Measure- ment dBuV	Limit dBuV	Over dB	Detector	Comment
1		0.2228	46.44	9.84	56.28	62.71	-6.43	peak	
2		0.2228	26.76	9.84	36.60	52.71	-16.11	AVG	
3		0.2907	42.37	9.86	52.23	60.50	-8.27	peak	
4		0.2907	34.54	9.86	44.40	50.50	-6.10	AVG	
5	*	0.5810	40.87	9.90	50.77	56.00	-5.23	peak	
6		0.5810	27.20	9.90	37.10	46.00	-8.90	AVG	
7		0.9320	37.65	9.92	47.57	56.00	-8.43	peak	
8		0.9320	22.58	9.92	32.50	46.00	-13.50	AVG	
9		2.9660	23.63	10.04	33.67	56.00	-22.33	peak	
10		14.9500	32.17	10.56	42.73	60.00	-17.27	peak	

*:Maximum data x:Over limit !:over margin

●Reference Only



File :USB
80.0 dBuV

Data :#2

Date: 2009/10/06

Time: 上午 02:07:09

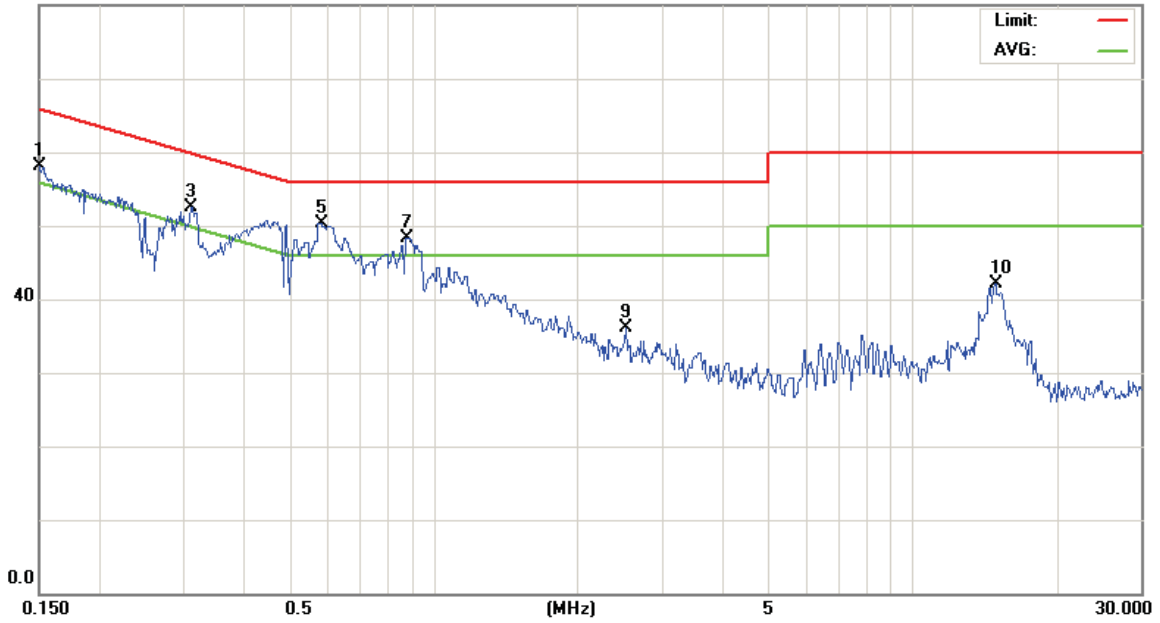

Site site#1 Phase: **L2** Temperature: 26 °C
 Limit: CISPR22 Class B Conduction(QP) Power: AC 120V/60Hz Humidity: 55 %
 EUT:
 M/N: 09-0239-EO
 Mode: Normal Link
 Note:

No.	Mk.	Freq. MHz	Reading Level dBuV	Correct Factor dB	Measure- ment dBuV	Limit dBuV	Over dB	Detector	Comment
1		0.1500	48.23	9.83	58.06	65.99	-7.93	peak	
2		0.1500	27.97	9.83	37.80	55.99	-18.19	AVG	
3		0.3116	42.63	9.87	52.50	59.93	-7.43	peak	
4		0.3116	34.33	9.87	44.20	49.93	-5.73	AVG	
5	*	0.5810	40.48	9.90	50.38	56.00	-5.62	peak	
6		0.5810	27.60	9.90	37.50	46.00	-8.50	AVG	
7		0.8780	38.40	9.91	48.31	56.00	-7.69	peak	
8		0.8780	22.59	9.91	32.50	46.00	-13.50	AVG	
9		2.5159	26.07	10.04	36.11	56.00	-19.89	peak	
10		14.8500	31.63	10.56	42.19	60.00	-17.81	peak	

*:Maximum data x:Over limit !:over margin

●Reference Only



3. Radiated Emissions Requirements

3.1 Test Procedure

The EUT and its simulators are placed on a turn table which is 0.8 meter above ground. The turn table can rotate 360 degrees to determine the position of the maximum emission level.

The antenna can move up and down between 1 meter and 4 meters to find out the maximum emission level.

Both horizontal and vertical polarizations of the antenna are set on measurement. In order to find the maximum emission, all of the interface cables must be manipulated according to ANSI C63.4:2003 on radiated measurement.

The EUT was positioned such that the distance from antenna to the EUT was 10 meters for the frequency under 1GHz and 3 meters for the frequency above 1GHz.

The bandwidth below 1GHz setting on the field strength meter (R&S Test Receiver ESCI) is 120 kHz and above 1GHz is 1MHz.

3.2 Radiated Emissions Limits

Frequency range (MHz)	Field strength (microvolts/meter)	Measure-ment dis-tance (meters)
0.009 to 0.490	2400/F(kHz)	300
0.490 to 1.705	24000/F(kHz)	30
1.705 to 30.0	30	30
30 to 88	100**	3
88 to 216	150**	3
216 to 960	200**	3
Above 960	500**	3

**Except as provided in paragraph (g), fundamental emissions from intentional radiators operating under this section shall not be located in the frequency bands 54–72 MHz, 76– 88 MHz, 174–216 MHz or 470–806 MHz. However, operation within these frequency bands is permitted under other sections of this part, e.g., §§15.231 and 15.241.

3.3 Test Equipment List

Describe	Manufacturer	Model	Serial Number	Calibration	
				Cal. Date	Due Date
Spectrum Analyzer	Agilent	E4408B	MY46181421	Mar. 13, 2009	Mar. 13, 2010
Pre Amplifier	Agilent	8449B	3008A02457	Mar. 04, 2009	Mar. 04, 2010
Pre Amplifier	Agilent	8447D	2944A11119	Jan. 19, 2009	Jan. 19, 2010
Test Receiver	R&S	ESCI	100367	Jul. 01, 2009	Jul. 01, 2010
Biconilog Antenna	SCHWARZBECK MESS-ELEKTRONIK	VULB9163	9163-270	Aug. 04, 2009	Aug. 04, 2010
Horn Antenna	SCHWARZBECK MESS-ELEKTRONIK	BBHA9120D	9120D-550	Jul. 01, 2009	Jul. 01, 2010
Horn Antenna	SCHWARZBECK MESS-ELEKTRONIK	BBHA9170	9170-320	Jun. 30, 2009	Jun. 30, 2010
Horn Antenna	SCHWARZBECK MESS-ELEKTRONIK	BBHA9120E	0899	Jun. 23, 2009	Jun. 23, 2010

3.4 Test Instruments Configuration

30 MHz ~ 1 GHz

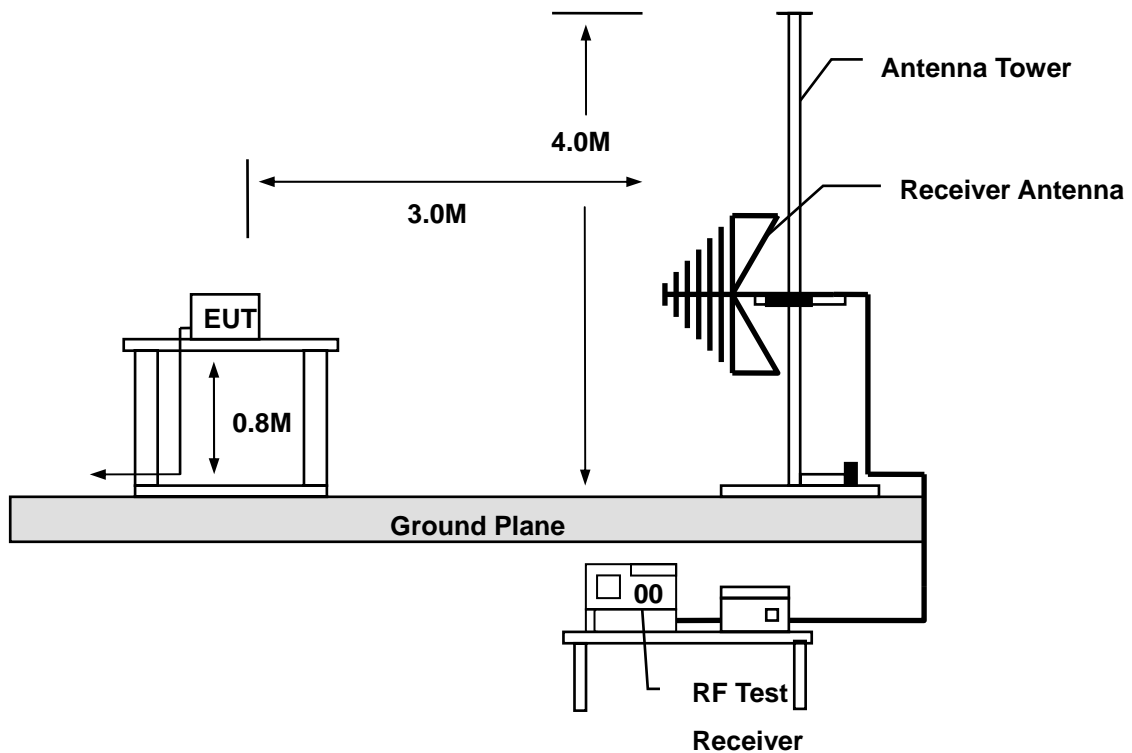

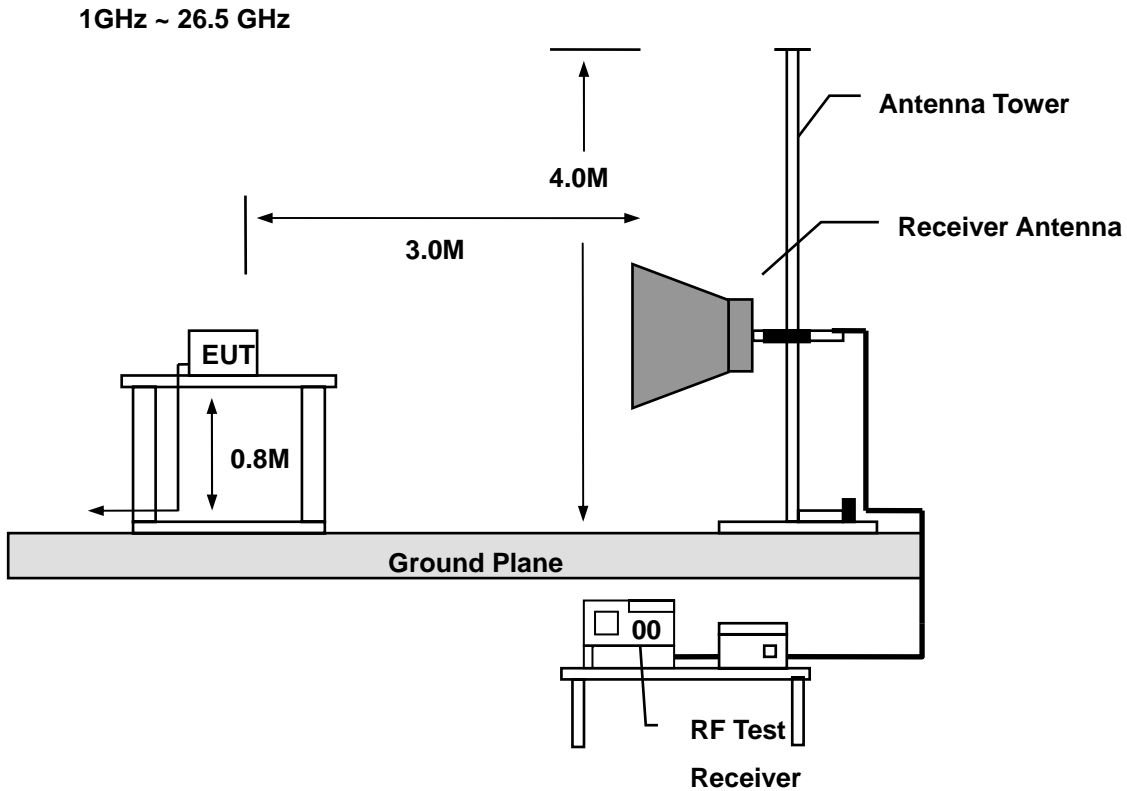

3.5 Test Results

EUT : NANO USB DONGLE

Model No. : BT 06K

Test Mode : Normal Link (30 MHz – 1 GHz)

2.1(GFSK) Link (1 GHz – 26.5 GHz, CH Low / CH Middle / CH High)

EDR(8DPSK) Link (1 GHz – 26.5 GHz, CH Low / CH Middle / CH High)

Test Date : 10/05/2009

Please refer to next page of detail testing data.

Notes:

1. Margin= Amplitude - Limits
2. Distance of Measurement: 3 Meter (30MHz-26.5GHz)
3. Height of table for EUT placed: 0.8 Meter.
4. ANT= Antenna height.
5. Amplitude= Reading Amplitude – Amplifier gain + Cable loss + Antenna factor
(Auto calculate in spectrum analyzer)



File :BT 06K(BT)

Data :#1

Date: 2009/10/5

Time: 上午 11:30:21

80.0 dBuV

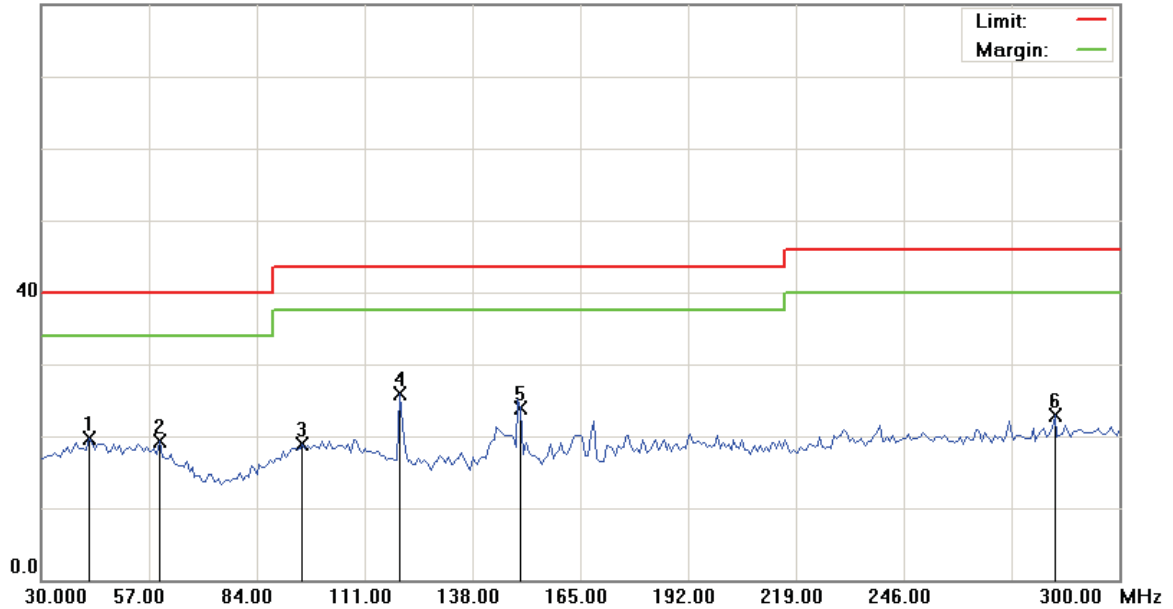

Site: site #1

Limit: FCC Class B 3M Radiation

EUT:

M/N: 09-0239-EO

Mode: Normal link

Note:

Polarization: *Vertical*

Power:

Distance: 3m

Temperature: 22 °C

Humidity: 60 %

No.	Mk.	Freq. MHz	Reading Level dBuV	Correct Factor dB	Measure- ment dBuV	Limit dBuV	Over dB	Antenna Height cm	Table Degree degree	Detector	Comment
1		42.1500	31.57	-11.86	19.71	40.00	-20.29			peak	
2		59.7000	31.81	-12.52	19.29	40.00	-20.71			peak	
3		95.4750	30.83	-12.01	18.82	43.50	-24.68			peak	
4	*	119.7750	40.09	-14.16	25.93	43.50	-17.57			peak	
5		150.1500	39.98	-16.00	23.98	43.50	-19.52			peak	
6		283.8000	33.17	-10.33	22.84	46.00	-23.16			peak	

*:Maximum data x:Over limit !:over margin



File :BT 06K(BT)

Data :#3

Date: 2009/10/5

Time: 上午 11:37:44

80.0 dBuV

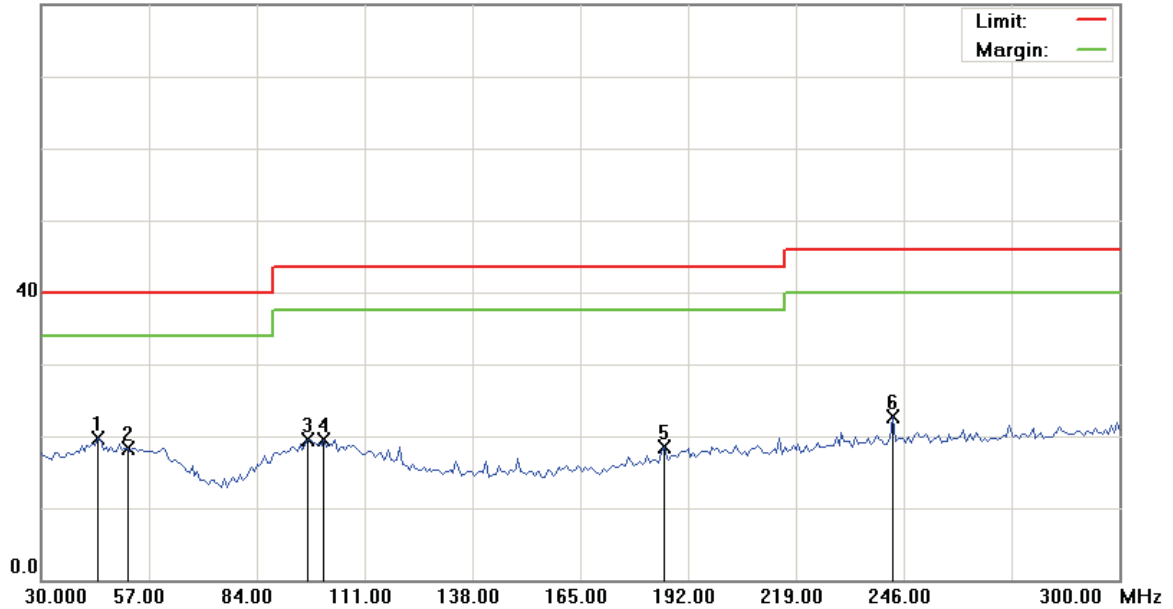

Site: site #1

Limit: FCC Class B 3M Radiation

EUT:

M/N: 09-0239-EO

Mode: Normal link

Note:

Polarization: *Horizontal*

Power:

Distance: 3m

Temperature: 22 °C

Humidity: 60 %

No.	Mk.	Freq. MHz	Reading Level dBuV	Correct Factor dB	Measure- ment dBuV	Limit dBuV	Over dB	Antenna Height cm	Table Degree degree	Detector	Comment
1	*	44.1750	31.46	-11.84	19.62	40.00	-20.38			peak	
2		51.6000	30.52	-12.17	18.35	40.00	-21.65			peak	
3		96.8250	31.46	-11.93	19.53	43.50	-23.97			peak	
4		100.8750	31.38	-11.82	19.56	43.50	-23.94			peak	
5		185.9250	32.28	-13.73	18.55	43.50	-24.95			peak	
6		243.3000	34.05	-11.32	22.73	46.00	-23.27			peak	

*:Maximum data x:Over limit !:over margin



File :BT 06K(BT)

Data :#2

Date: 2009/10/5

Time: 下午 12:44:35

80.0 dBuV

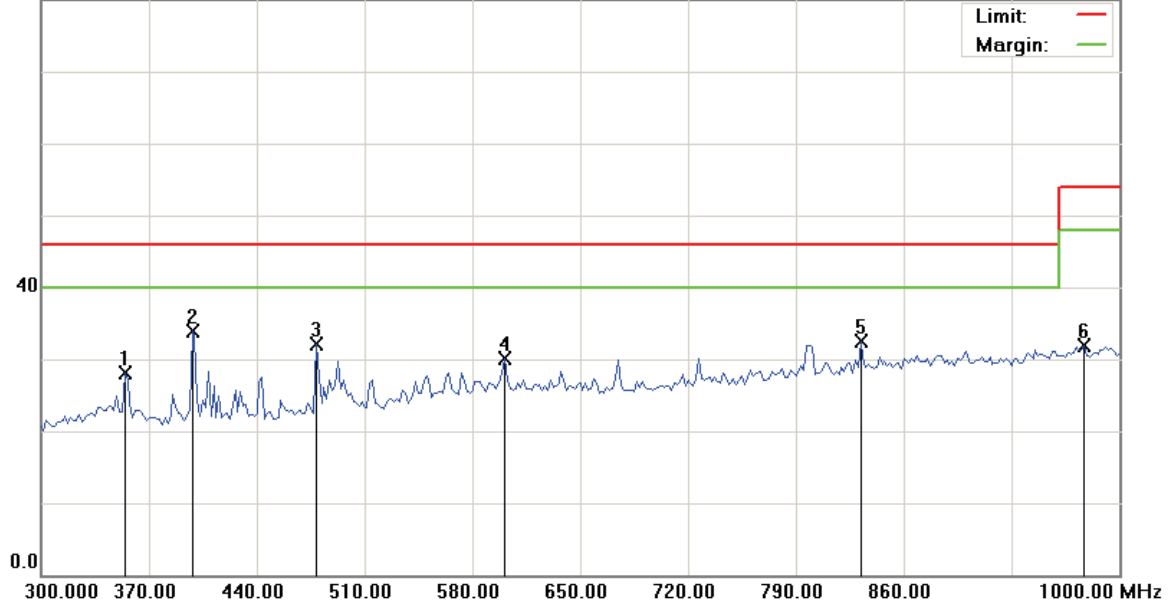

Site: site #1

Polarization: **Vertical**

Temperature: 22 °C

Limit: FCC Class B 3M Radiation

Power:

Humidity: 60 %

EUT:

Distance: 3m

M/N: 09-0239-EO

Mode: Normal link

Note:

No.	Mk.	Freq. MHz	Reading Level dBuV	Correct Factor dB	Measure- ment dBuV	Limit dBuV	Over dB	Antenna Height cm	Table Degree degree	Detector	Comment
1		354.2500	36.92	-8.84	28.08	46.00	-17.92			peak	
2	*	398.0000	42.33	-8.39	33.94	46.00	-12.06			peak	
3		478.5000	39.85	-7.67	32.18	46.00	-13.82			peak	
4		601.0000	34.88	-4.85	30.03	46.00	-15.97			peak	
5		832.0000	34.12	-1.53	32.59	46.00	-13.41			peak	
6		977.2500	31.34	0.55	31.89	54.00	-22.11			peak	

*:Maximum data x:Over limit !:over margin



File :BT 06K(BT)

Data :#4

Date: 2009/10/5

Time: 下午 12:42:06

80.0 dBuV

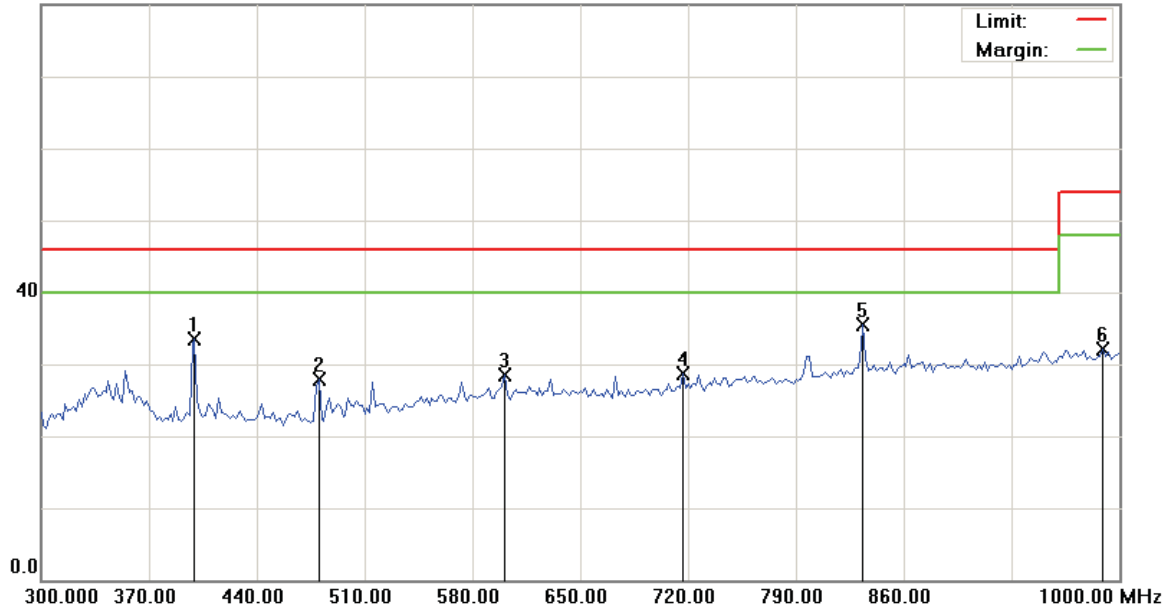

Site: site #1

Polarization: *Horizontal*

Temperature: 22 °C

Limit: FCC Class B 3M Radiation

Power:

Humidity: 60 %

EUT:

Distance: 3m

M/N: 09-0239-EO

Mode: Normal link

Note:

No.	Mk.	Freq. MHz	Reading Level dBuV	Correct Factor dB	Measure- ment dBuV	Limit dBuV	Over dB	Antenna Height cm	Table Degree degree	Degree Comment
1		399.7500	41.79	-8.34	33.45	46.00	-12.55	peak		
2		480.2500	35.39	-7.51	27.88	46.00	-18.12	peak		
3		601.0000	33.44	-4.85	28.59	46.00	-17.41	peak		
4		716.5000	32.28	-3.58	28.70	46.00	-17.30	peak		
5	*	833.7500	36.97	-1.43	35.54	46.00	-10.46	peak		
6		989.5000	31.14	0.89	32.03	54.00	-21.97	peak		

*:Maximum data x:Over limit !:over margin



File :BT 06K(2402MHz)

Data :#17

Date: 2009/10/5

Time: 下午 10:38:24

95.0 dBuV

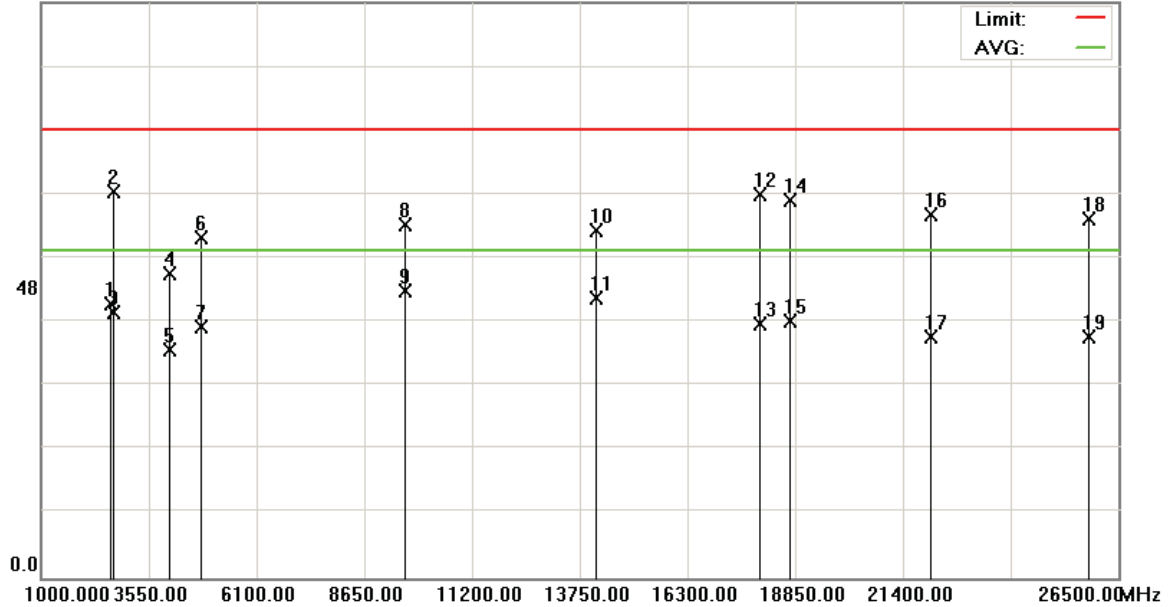

Site: site #1
 Limit: FCC part 15 (PK)
 EUT:
 M/N: 09-0239-EO
 Mode: BT 2.1(GFSK) Link
 Note: 2402MHz

Polarization: **Vertical**
 Power:
 Distance: 3m

Temperature: 22 °C
 Humidity: 60 %

No.	Mk.	Freq. MHz	Reading Level dBuV	Correct Factor dB	Measure- ment dBuV	Limit dBuV	Over dB	Antenna Height cm	Table Degree degree	Degree Comment
1		2643.900	44.28	0.97	45.25	74.00	-28.75	peak		
2		2700.000	41.27	22.58	63.85	74.00	-10.15	peak		
3		2700.000	21.23	22.58	43.81	54.00	-10.19	AVG		
4		4014.000	45.22	5.13	50.35	74.00	-23.65	peak		
5		4014.000	32.49	5.13	37.62	54.00	-16.38	AVG		
6		4798.750	48.87	7.29	56.16	74.00	-17.84	peak		
7		4798.750	34.17	7.29	41.46	54.00	-12.54	AVG		
8		9616.750	40.98	17.25	58.23	74.00	-15.77	peak		
9	*	9616.750	30.19	17.25	47.44	54.00	-6.56	AVG		
10		14120.000	38.39	18.87	57.26	74.00	-16.74	peak		
11		14120.000	27.23	18.87	46.10	54.00	-7.90	AVG		
12		18000.000	37.83	25.57	63.40	74.00	-10.60	peak		
13		18000.000	16.36	25.57	41.93	54.00	-12.07	AVG		
14		18701.250	39.19	23.11	62.30	74.00	-11.70	peak		
15		18701.250	19.40	23.11	42.51	54.00	-11.49	AVG		
16		22058.750	38.94	21.09	60.03	74.00	-13.97	peak		
17		22058.750	18.74	21.09	39.83	54.00	-14.17	AVG		
18		25798.750	40.48	18.72	59.20	74.00	-14.80	peak		
19		25798.750	21.07	18.72	39.79	54.00	-14.21	AVG		

*:Maximum data x:Over limit !:over margin



File :BT 06K(2402MHz)

Data :#18

Date: 2009/10/5

Time: 下午 10:54:40

95.0 dBuV

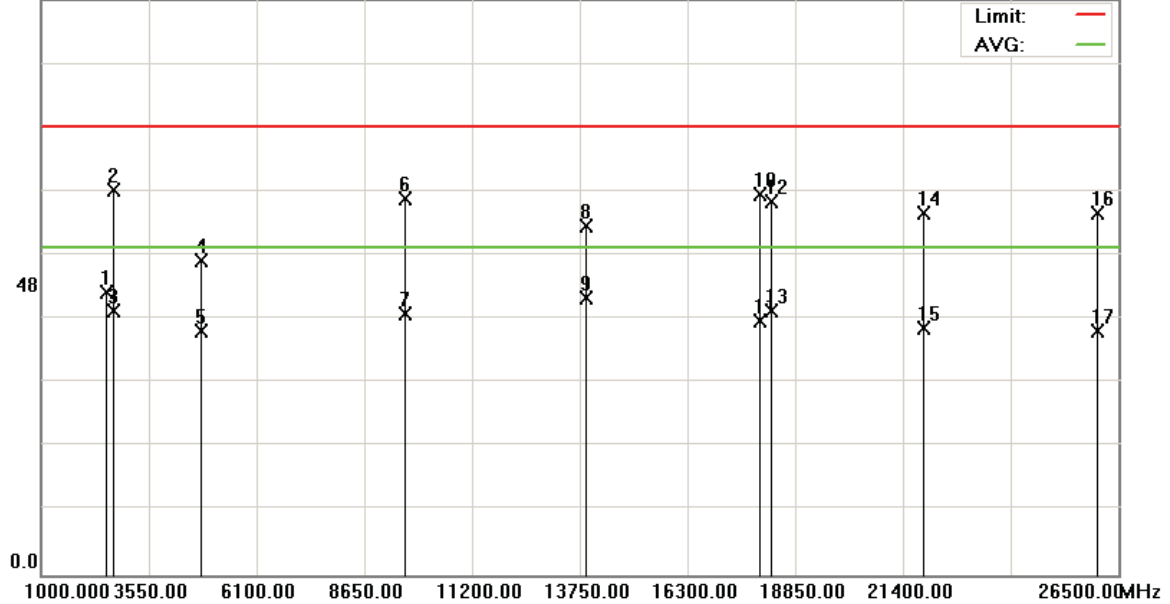

Site: site #1
 Limit: FCC part 15 (PK)
 EUT:
 M/N: 09-0239-EO
 Mode: BT 2.1(GFSK) Link
 Note: 2402MHz

Polarization: **Horizontal**
 Power:
 Distance: 3m

Temperature: 22 °C
 Humidity: 60 %

No.	Mk.	Freq. MHz	Reading Level dBuV	Correct Factor dB	Measure- ment dBuV	Limit dBuV	Over dB	Antenna Height cm	Table Degree degree	Detector	Comment
1		2531.700	46.13	0.45	46.58	74.00	-27.42			peak	
2		2700.000	40.84	22.58	63.42	74.00	-10.58			peak	
3		2700.000	21.09	22.58	43.67	54.00	-10.33			AVG	
4		4798.750	44.64	7.29	51.93	74.00	-22.07			peak	
5		4798.750	33.04	7.29	40.33	54.00	-13.67			AVG	
6		9616.750	44.74	17.25	61.99	74.00	-12.01			peak	
7		9616.750	25.93	17.25	43.18	54.00	-10.82			AVG	
8		13900.000	39.04	18.53	57.57	74.00	-16.43			peak	
9	*	13900.000	27.28	18.53	45.81	54.00	-8.19			AVG	
10		18000.000	37.25	25.57	62.82	74.00	-11.18			peak	
11		18000.000	16.34	25.57	41.91	54.00	-12.09			AVG	
12		18276.250	38.45	23.21	61.66	74.00	-12.34			peak	
13		18276.250	20.34	23.21	43.55	54.00	-10.45			AVG	
14		21867.500	38.57	21.19	59.76	74.00	-14.24			peak	
15		21867.500	19.57	21.19	40.76	54.00	-13.24			AVG	
16		25990.000	41.24	18.56	59.80	74.00	-14.20			peak	
17		25990.000	21.59	18.56	40.15	54.00	-13.85			AVG	

*:Maximum data x:Over limit !:over margin



File :BT 06K(2441MHz)

Data :#17

Date: 2009/10/5

Time: 下午 10:41:36

95.0 dBuV

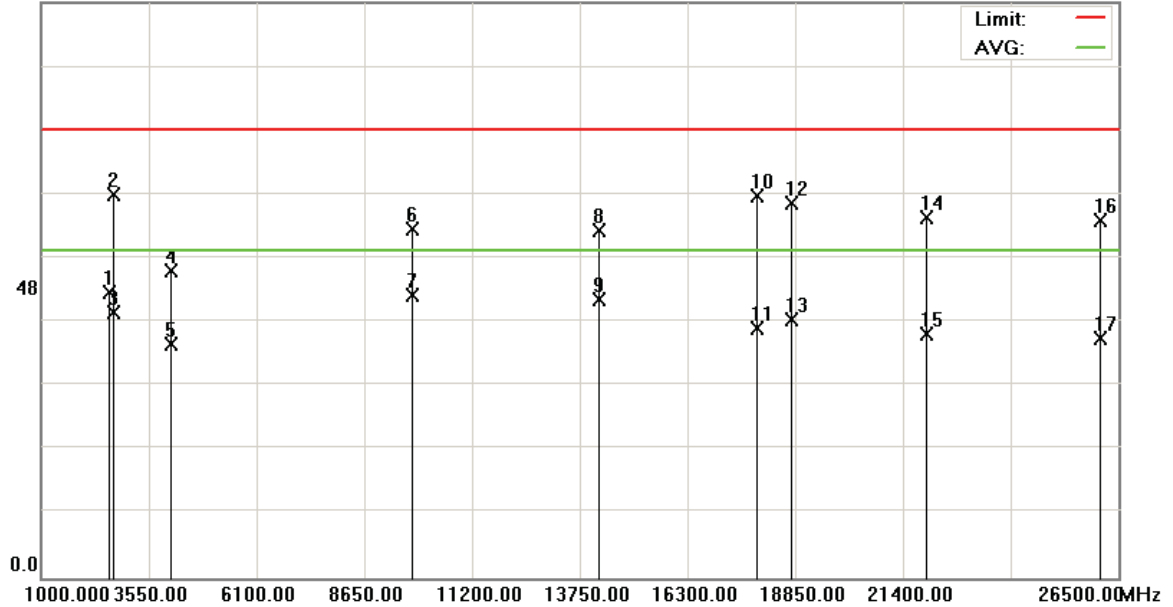

Site: site #1
 Limit: FCC part 15 (PK)
 EUT:
 M/N: 09-0239-EO
 Mode: BT 2.1(GFSK) Link
 Note: 2441MHz

Polarization: **Vertical**
 Power:
 Distance: 3m

Temperature: 22 °C
 Humidity: 60 %

No.	Mk.	Freq. MHz	Reading Level dBuV	Correct Factor dB	Measure- ment dBuV	Limit dBuV	Over dB	Antenna Height cm	Table Degree degree	Comment
1		2606.500	46.61	0.65	47.26	74.00	-26.74	peak		
2		2700.000	40.60	22.58	63.18	74.00	-10.82	peak		
3		2700.000	21.27	22.58	43.85	54.00	-10.15	AVG		
4		4068.750	45.51	5.13	50.64	74.00	-23.36	peak		
5		4068.750	33.56	5.13	38.69	54.00	-15.31	AVG		
6		9762.750	39.96	17.70	57.66	74.00	-16.34	peak		
7	*	9762.750	28.93	17.70	46.63	54.00	-7.37	AVG		
8		14200.000	38.42	18.86	57.28	74.00	-16.72	peak		
9		14200.000	27.20	18.86	46.06	54.00	-7.94	AVG		
10		17920.000	38.22	24.84	63.06	74.00	-10.94	peak		
11		17920.000	16.32	24.84	41.16	54.00	-12.84	AVG		
12		18743.750	38.79	23.13	61.92	74.00	-12.08	peak		
13		18743.750	19.59	23.13	42.72	54.00	-11.28	AVG		
14		21952.500	38.33	21.15	59.48	74.00	-14.52	peak		
15		21952.500	19.16	21.15	40.31	54.00	-13.69	AVG		
16		26053.750	40.57	18.52	59.09	74.00	-14.91	peak		
17		26053.750	21.04	18.52	39.56	54.00	-14.44	AVG		

*:Maximum data x:Over limit !:over margin



File :BT 06K(2441MHz)

Data :#18

Date: 2009/10/5

Time: 下午 10:51:24

95.0 dBuV

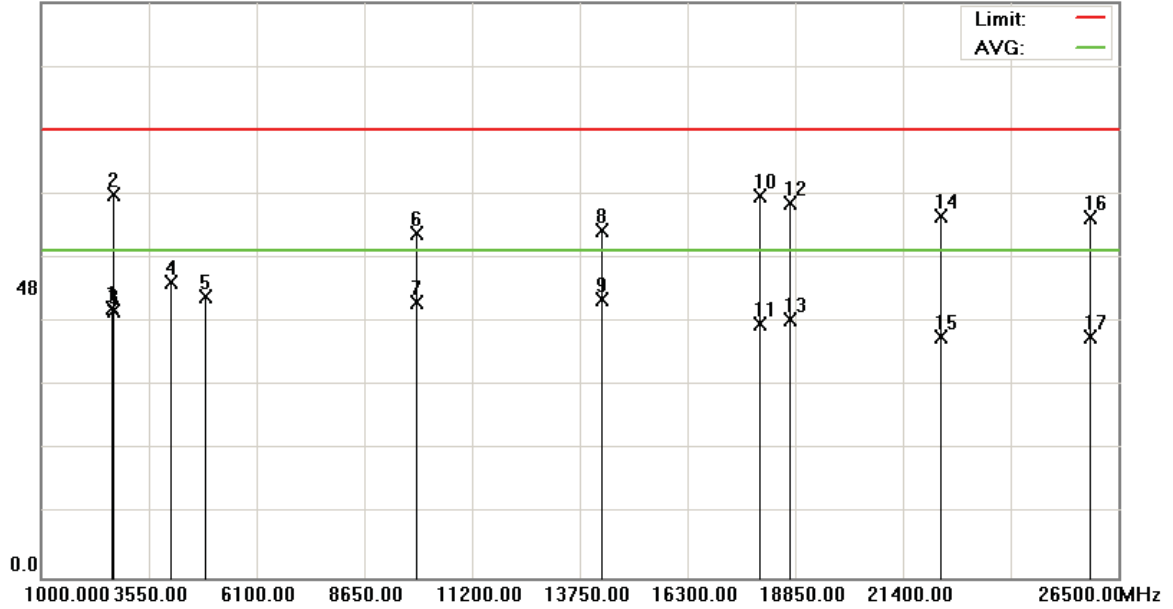

Site: site #1
 Limit: FCC part 15 (PK)
 EUT:
 M/N: 09-0239-EO
 Mode: BT 2.1(GFSK) Link
 Note: 2441MHz

Polarization: **Horizontal**
 Power:
 Distance: 3m

Temperature: 22 °C
 Humidity: 60 %

No.	Mk.	Freq. MHz	Reading Level dBuV	Correct Factor dB	Measure- ment dBuV	Limit dBuV	Over dB	Antenna Height cm	Table Degree degree	Comment
1		2669.400	43.50	1.02	44.52	74.00	-29.48	peak		
2		2700.000	40.71	22.58	63.29	74.00	-10.71	peak		
3		2700.000	21.53	22.58	44.11	54.00	-9.89	AVG		
4		4068.750	43.58	5.13	48.71	74.00	-25.29	peak		
5		4882.000	38.67	7.74	46.41	74.00	-27.59	peak		
6		9854.000	38.98	17.89	56.87	74.00	-17.13	peak		
7		9854.000	27.60	17.89	45.49	54.00	-8.51	AVG		
8		14240.000	38.74	18.71	57.45	74.00	-16.55	peak		
9	*	14240.000	27.30	18.71	46.01	54.00	-7.99	AVG		
10		18000.000	37.41	25.57	62.98	74.00	-11.02	peak		
11		18000.000	16.27	25.57	41.84	54.00	-12.16	AVG		
12		18701.250	38.82	23.11	61.93	74.00	-12.07	peak		
13		18701.250	19.62	23.11	42.73	54.00	-11.27	AVG		
14		22292.500	38.66	20.98	59.64	74.00	-14.36	peak		
15		22292.500	18.82	20.98	39.80	54.00	-14.20	AVG		
16		25820.000	40.88	18.71	59.59	74.00	-14.41	peak		
17		25820.000	20.96	18.71	39.67	54.00	-14.33	AVG		

*:Maximum data x:Over limit !:over margin



File :BT 06K(2480MHz)

Data :#17

Date: 2009/10/5

Time: 下午 10:44:59

95.0 dBuV

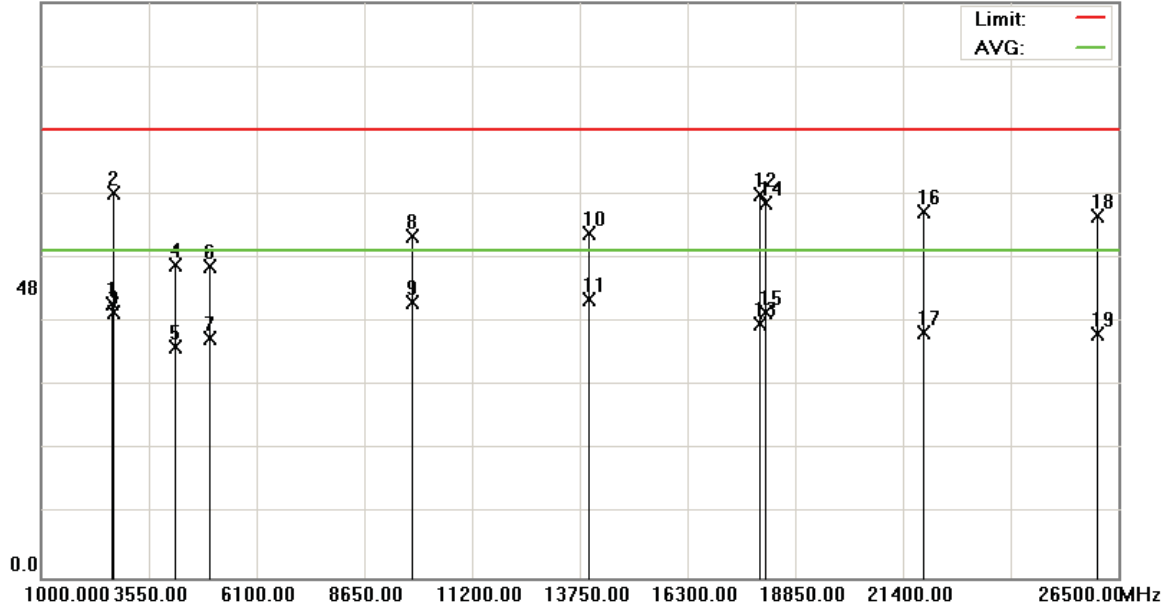

Site: site #1
 Limit: FCC part 15 (PK)
 EUT:
 M/N: 09-0239-EO
 Mode: BT 2.1(GFSK) Link
 Note: 2480MHz

Polarization: **Vertical**
 Power:
 Distance: 3m

Temperature: 22 °C
 Humidity: 60 %

No.	Mk.	Freq. MHz	Reading Level dBuV	Correct Factor dB	Measure- ment dBuV	Limit dBuV	Over dB	Antenna Height cm	Table Degree degree	Comment
1		2679.600	44.20	1.00	45.20	74.00	-28.80	peak		
2		2700.000	41.07	22.58	63.65	74.00	-10.35	peak		
3		2700.000	21.33	22.58	43.91	54.00	-10.09	AVG		
4		4141.750	46.75	5.01	51.76	74.00	-22.24	peak		
5		4141.750	33.21	5.01	38.22	54.00	-15.78	AVG		
6		4963.000	43.65	7.82	51.47	74.00	-22.53	peak		
7		4963.000	31.66	7.82	39.48	54.00	-14.52	AVG		
8		9781.000	38.74	17.69	56.43	74.00	-17.57	peak		
9		9781.000	27.85	17.69	45.54	54.00	-8.46	AVG		
10		13960.000	38.35	18.57	56.92	74.00	-17.08	peak		
11	*	13960.000	27.30	18.57	45.87	54.00	-8.13	AVG		
12		18000.000	37.61	25.57	63.18	74.00	-10.82	peak		
13		18000.000	16.29	25.57	41.86	54.00	-12.14	AVG		
14		18148.750	38.70	23.22	61.92	74.00	-12.08	peak		
15		18148.750	20.51	23.22	43.73	54.00	-10.27	AVG		
16		21867.500	39.21	21.19	60.40	74.00	-13.60	peak		
17		21867.500	19.22	21.19	40.41	54.00	-13.59	AVG		
18		25990.000	41.07	18.56	59.63	74.00	-14.37	peak		
19		25990.000	21.79	18.56	40.35	54.00	-13.65	AVG		

*:Maximum data x:Over limit !:over margin



File :BT 06K(2480MHz)

Data :#18

Date: 2009/10/5

Time: 下午 10:48:07

95.0 dBuV

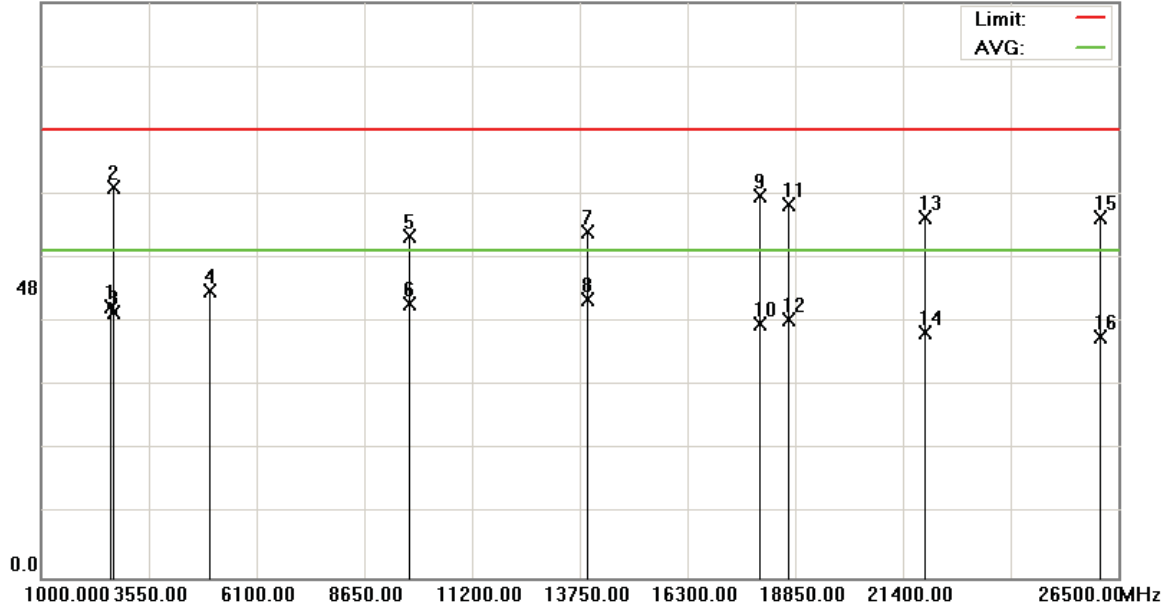

Site: site #1
 Limit: FCC part 15 (PK)
 EUT:
 M/N: 09-0239-EO
 Mode: BT 2.1(GFSK) Link
 Note: 2480MHz

Polarization: **Horizontal**
 Power:
 Distance: 3m

Temperature: 22 °C
 Humidity: 60 %

No.	Mk.	Freq. MHz	Reading Level dBuV	Correct Factor dB	Measure- ment dBuV	Limit dBuV	Over dB	Antenna Height cm	Table Degree degree	Detector	Comment
1		2615.000	44.08	0.73	44.81	74.00	-29.19			peak	
2		2700.000	41.95	22.58	64.53	74.00	-9.47			peak	
3		2700.000	21.18	22.58	43.76	54.00	-10.24			AVG	
4		4960.000	39.55	7.80	47.35	74.00	-26.65			peak	
5		9708.000	38.82	17.49	56.31	74.00	-17.69			peak	
6	*	9708.000	27.82	17.49	45.31	54.00	-8.69			AVG	
7		13920.000	38.69	18.54	57.23	74.00	-16.77			peak	
8		13920.000	27.30	18.54	45.84	74.00	-28.16			peak	
9		18000.000	37.51	25.57	63.08	74.00	-10.92			peak	
10		18000.000	16.38	25.57	41.95	74.00	-32.05			peak	
11		18680.000	38.45	23.09	61.54	74.00	-12.46			peak	
12		18680.000	19.64	23.09	42.73	54.00	-11.27			AVG	
13		21910.000	38.23	21.16	59.39	74.00	-14.61			peak	
14		21910.000	19.32	21.16	40.48	54.00	-13.52			AVG	
15		26053.750	40.95	18.52	59.47	74.00	-14.53			peak	
16		26053.750	21.18	18.52	39.70	54.00	-14.30			AVG	

*:Maximum data x:Over limit !:over margin



File :BT 06K(2402MHz)

Data :#17

Date: 2009/10/5

Time: 下午 10:35:00

95.0 dBuV

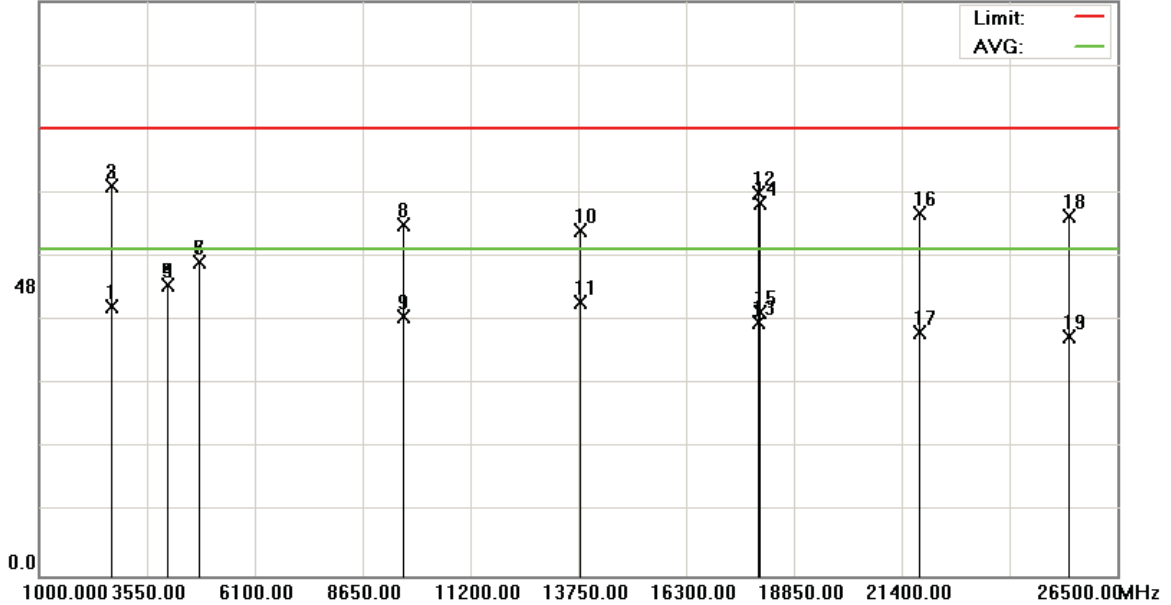

Site site #1

Polarization: *Vertical*

Temperature: 22 °C

Limit: FCC part 15 (PK)

Power:

Humidity: 60 %

EUT:

Distance: 3m

M/N: 09-0239-EO

Mode: BT EDR(8DPSK) Link

Note: 2402MHz

No.	Mk.	Freq.	Reading Level	Correct Factor	Measurement	Limit	Over	Antenna	Table	
		MHz	dBuV	dB	dBuV	dBuV	dB	Height	Table	
								cm	degree	Comment
1		2691.500	43.63	1.00	44.63	74.00	-29.37			peak
2		2700.000	41.82	22.58	64.40	74.00	-9.60			peak
3	*	2700.000	41.82	22.58	64.40	54.00	10.40			AVG
4		4014.000	42.85	5.13	47.98	74.00	-26.02			peak
5		4014.000	42.85	5.13	47.98	74.00	-26.02			peak
6		4798.750	44.51	7.29	51.80	74.00	-22.20			peak
7		4798.750	44.51	7.29	51.80	54.00	-2.20			AVG
8		9616.750	40.73	17.25	57.98	74.00	-16.02			peak
9		9616.750	25.52	17.25	42.77	54.00	-11.23			AVG
10		13800.00	39.27	17.85	57.12	74.00	-16.88			peak
11		13800.00	27.30	17.85	45.15	54.00	-8.85			AVG
12		18000.00	37.72	25.57	63.29	74.00	-10.71			peak
13		18000.00	16.41	25.57	41.98	54.00	-12.02			AVG

*:Maximum data x:Over limit !:over margin

●Reference Only



Site site #1 Polarization: *Vertical* Temperature: 22 °C
Limit: FCC part 15 (PK) Power: Humidity: 60 %
EUT: Distance: 3m
M/N: 09-0239-EO
Mode: BT EDR(8DPSK) Link
Note: 2402MHz

No.	Mk.	Freq.	Reading Level	Correct Factor	Measurement	Limit	Over	Antenna Height	Table Degree		
		MHz	dBuV	dB	dBuV	dBuV	dB	Detector	cm	degree	Comment
14		18042.50	38.33	23.27	61.60	74.00	-12.40	peak			
15		18042.50	20.43	23.27	43.70	54.00	-10.30	AVG			
16		21825.00	38.82	21.20	60.02	74.00	-13.98	peak			
17		21825.00	19.13	21.20	40.33	54.00	-13.67	AVG			
18		25331.25	40.33	19.09	59.42	74.00	-14.58	peak			
19		25331.25	20.55	19.09	39.64	54.00	-14.36	AVG			

*:Maximum data x:Over limit !:over margin

●Reference Only



File :BT 06K(2402MHz)

Data :#18

Date: 2009/10/5

Time: 下午 10:57:47

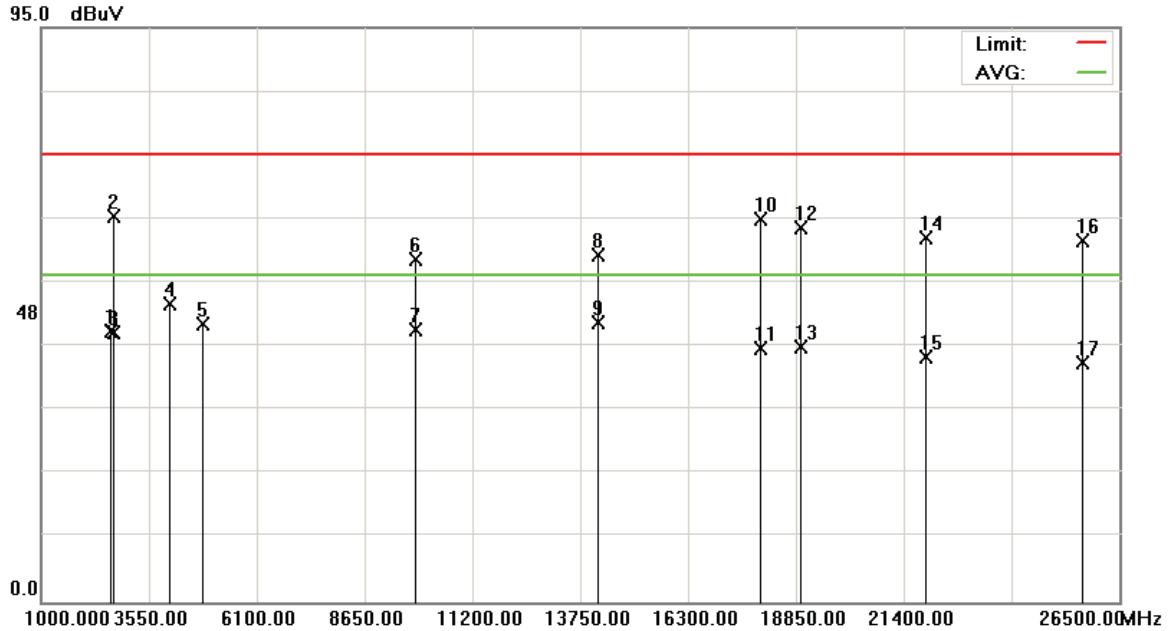

Site site #1 Polarization: **Horizontal** Temperature: 22 °C
 Limit: FCC part 15 (PK) Power: Humidity: 60 %
 EUT: Distance: 3m
 M/N: 09-0239-EO
 Mode: BT EDR(8DPSK) Link
 Note: 2402MHz

No.	Mk.	Freq.	Reading Level	Correct Factor	Measurement	Limit	Over	Antenna Height	Table Degree	
		MHz	dBuV	dB	dBuV	dBuV	dB	cm	degree	Comment
1		2654.100	43.91	0.94	44.85	74.00	-29.15			peak
2		2700.000	41.27	22.58	63.85	74.00	-10.15			peak
3		2700.000	21.85	22.58	44.43	54.00	-9.57			AVG
4		4014.000	44.04	5.13	49.17	74.00	-24.83			peak
5		4804.000	38.62	7.32	45.94	74.00	-28.06			peak
6		9835.750	38.84	17.83	56.67	74.00	-17.33			peak
7		9835.750	27.25	17.83	45.08	54.00	-8.92			AVG
8		14140.00	38.62	18.84	57.46	74.00	-16.54			peak
9	*	14140.00	27.33	18.84	46.17	54.00	-7.83			AVG
10		18000.00	37.73	25.57	63.30	74.00	-10.70			peak
11		18000.00	16.35	25.57	41.92	54.00	-12.08			AVG
12		18935.00	38.73	23.13	61.86	74.00	-12.14			peak
13		18935.00	19.07	23.13	42.20	54.00	-11.80			AVG

*:Maximum data x:Over limit !:over margin ●Reference Only



Site site #1	Polarization: <i>Horizontal</i>	Temperature: 22 °C
Limit: FCC part 15 (PK)	Power:	Humidity: 60 %
EUT:	Distance: 3m	
M/N: 09-0239-EO		
Mode: BT EDR(8DPSK) Link		
Note: 2402MHz		

No.	Mk.	Freq.	Reading Level	Correct Factor	Measurement	Limit	Over	Antenna Height	Table Degree	
		MHz	dBuV	dB	dBuV	dBuV	dB	cm	degree	Comment
14		21910.00	38.98	21.16	60.14	74.00	-13.86			peak
15		21910.00	19.26	21.16	40.42	54.00	-13.58			AVG
16		25628.75	40.96	18.89	59.85	74.00	-14.15			peak
17		25628.75	20.56	18.89	39.45	54.00	-14.55			AVG

*:Maximum data x:Over limit !:over margin

●Reference Only



File :BT 06K(2441MHz)

Data :#17

Date: 2009/10/5

Time: 下午 10:31:44

95.0 dBuV

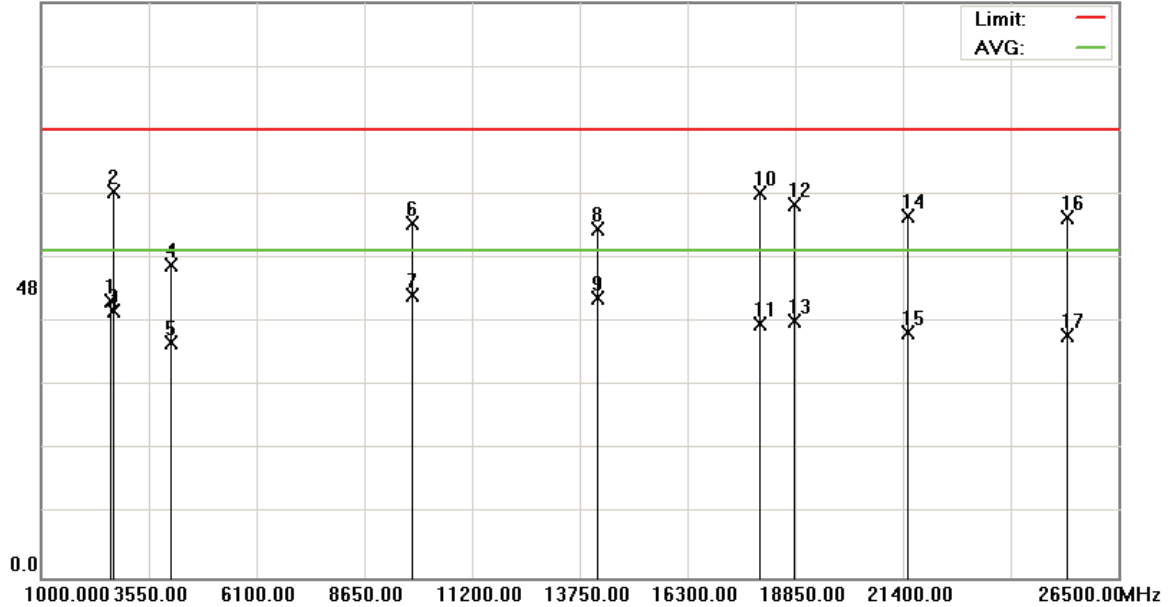

Site: site #1
 Limit: FCC part 15 (PK)
 EUT:
 M/N: 09-0239-EO
 Mode: BT EDR(8DPSK) Link
 Note: 2441MHz

Polarization: **Vertical**
 Power:
 Distance: 3m

Temperature: 22 °C
 Humidity: 60 %

No.	Mk.	Freq. MHz	Reading Level dBuV	Correct Factor dB	Measure- ment dBuV	Limit dBuV	Over dB	Antenna Height cm	Table Degree degree	Comment
1		2613.300	45.10	0.72	45.82	74.00	-28.18	peak		
2		2700.000	41.29	22.58	63.87	74.00	-10.13	peak		
3		2700.000	21.37	22.58	43.95	54.00	-10.05	AVG		
4		4068.750	46.60	5.13	51.73	74.00	-22.27	peak		
5		4068.750	33.61	5.13	38.74	54.00	-15.26	AVG		
6		9762.750	40.74	17.70	58.44	74.00	-15.56	peak		
7	*	9762.750	29.08	17.70	46.78	54.00	-7.22	AVG		
8		14180.000	38.71	18.85	57.56	74.00	-16.44	peak		
9		14180.000	27.25	18.85	46.10	54.00	-7.90	AVG		
10		18000.000	38.04	25.57	63.61	74.00	-10.39	peak		
11		18000.000	16.36	25.57	41.93	54.00	-12.07	AVG		
12		18807.500	38.59	23.16	61.75	74.00	-12.25	peak		
13		18807.500	19.18	23.16	42.34	54.00	-11.66	AVG		
14		21506.250	38.31	21.35	59.66	74.00	-14.34	peak		
15		21506.250	19.20	21.35	40.55	54.00	-13.45	AVG		
16		25288.750	40.36	19.11	59.47	74.00	-14.53	peak		
17		25288.750	20.81	19.11	39.92	54.00	-14.08	AVG		

*:Maximum data x:Over limit !:over margin



File :BT 06K(2441MHz)

Data :#18

Date: 2009/10/5

Time: 下午 11:00:54

95.0 dBuV

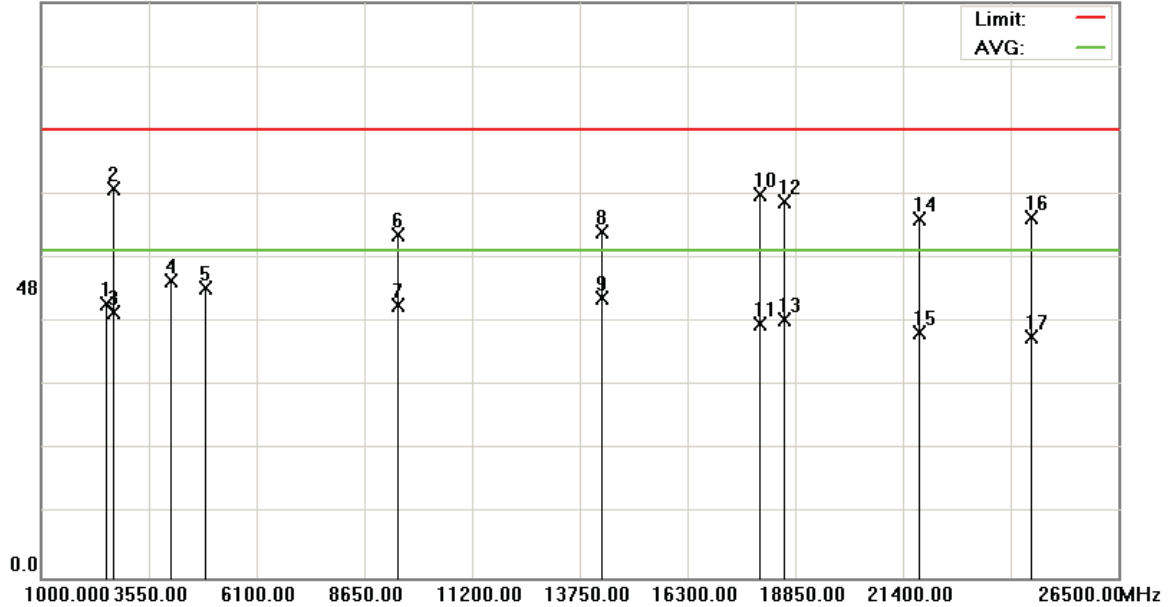

Site: site #1
 Limit: FCC part 15 (PK)
 EUT:
 M/N: 09-0239-EO
 Mode: BT EDR(8DPSK) Link
 Note: 2441MHz

Polarization: **Horizontal**
 Power:
 Distance: 3m

Temperature: 22 °C
 Humidity: 60 %

No.	Mk.	Freq. MHz	Reading Level dBuV	Correct Factor dB	Measure- ment dBuV	Limit dBuV	Over dB	Antenna Height cm	Table Degree degree	Degree Comment
1		2530.000	44.69	0.45	45.14	74.00	-28.86	peak		
2		2700.000	41.67	22.58	64.25	74.00	-9.75	peak		
3		2700.000	21.30	22.58	43.88	54.00	-10.12	AVG		
4		4068.750	43.85	5.13	48.98	74.00	-25.02	peak		
5		4882.000	40.08	7.74	47.82	74.00	-26.18	peak		
6		9416.000	39.50	17.07	56.57	74.00	-17.43	peak		
7		9416.000	27.89	17.07	44.96	54.00	-9.04	AVG		
8		14240.000	38.35	18.71	57.06	74.00	-16.94	peak		
9	*	14240.000	27.39	18.71	46.10	54.00	-7.90	AVG		
10		18000.000	37.69	25.57	63.26	74.00	-10.74	peak		
11		18000.000	16.40	25.57	41.97	54.00	-12.03	AVG		
12		18595.000	39.08	23.07	62.15	74.00	-11.85	peak		
13		18595.000	19.62	23.07	42.69	54.00	-11.31	AVG		
14		21761.250	38.00	21.23	59.23	74.00	-14.77	peak		
15		21761.250	19.22	21.23	40.45	54.00	-13.55	AVG		
16		24417.500	39.73	19.71	59.44	74.00	-14.56	peak		
17		24417.500	19.99	19.71	39.70	54.00	-14.30	AVG		

*:Maximum data x:Over limit !:over margin



File :BT 06K(2480MHz)

Data :#18

Date: 2009/10/5

Time: 下午 11:03:44

95.0 dBuV

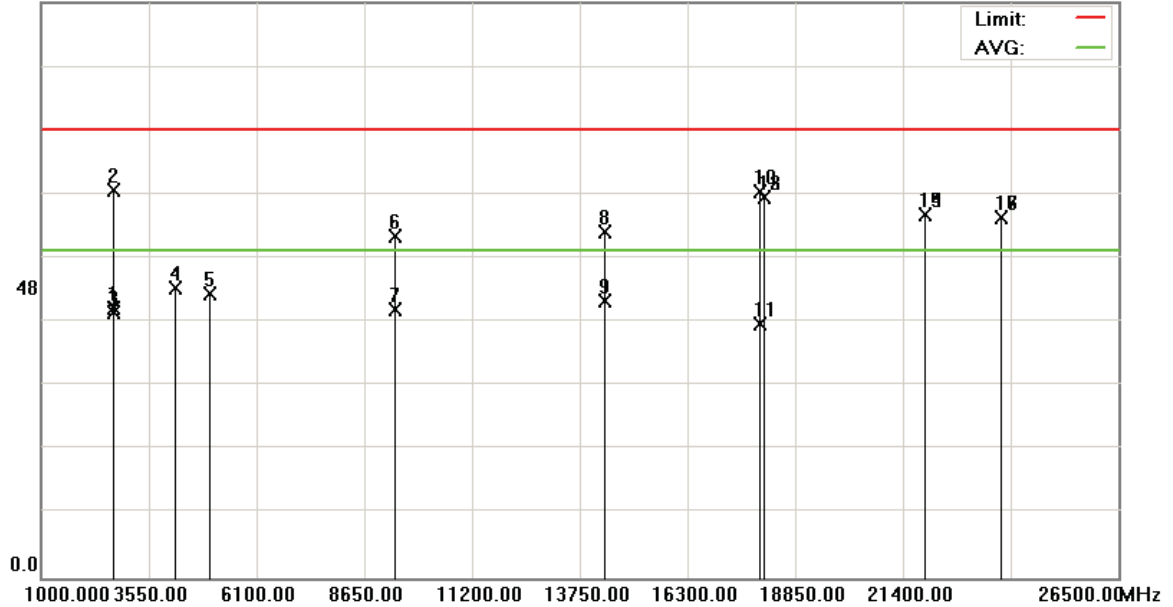

Site: site #1
 Limit: FCC part 15 (PK)
 EUT:
 M/N: 09-0239-EO
 Mode: BT EDR(8DPSK) Link
 Note: 2480MHz

Polarization: **Horizontal**
 Power:
 Distance: 3m

Temperature: 22 °C
 Humidity: 60 %

No.	Mk.	Freq. MHz	Reading Level dBuV	Correct Factor dB	Measure- ment dBuV	Limit dBuV	Over dB	Antenna Height cm	Table Degree degree	Comment
1		2693.200	43.57	0.96	44.53	74.00	-29.47	peak		
2		2700.000	41.45	22.58	64.03	74.00	-9.97	peak		
3		2700.000	21.32	22.58	43.90	54.00	-10.10	AVG		
4		4141.750	42.73	5.01	47.74	74.00	-26.26	peak		
5		4960.000	39.16	7.80	46.96	74.00	-27.04	peak		
6		9361.250	39.46	16.98	56.44	74.00	-17.56	peak		
7		9361.250	27.33	16.98	44.31	54.00	-9.69	AVG		
8		14320.000	38.51	18.57	57.08	74.00	-16.92	peak		
9	*	14320.000	27.20	18.57	45.77	54.00	-8.23	AVG		
10		18000.000	38.13	25.57	63.70	74.00	-10.30	peak		
11		18000.000	16.35	25.57	41.92	54.00	-12.08	AVG		
12		18106.250	39.52	23.23	62.75	74.00	-11.25	peak		
13		18106.250	39.52	23.23	62.75	74.00	-11.25	peak		
14		21888.750	38.70	21.18	59.88	74.00	-14.12	peak		
15		21888.750	38.70	21.18	59.88	74.00	-14.12	peak		
16		23716.250	39.08	20.31	59.39	74.00	-14.61	peak		
17		23716.250	39.08	20.31	59.39	74.00	-14.61	peak		

*:Maximum data x:Over limit !:over margin



File :BT 06K(2480MHz)

Data :#17

Date: 2009/10/5

Time: 下午 10:27:24

95.0 dBuV

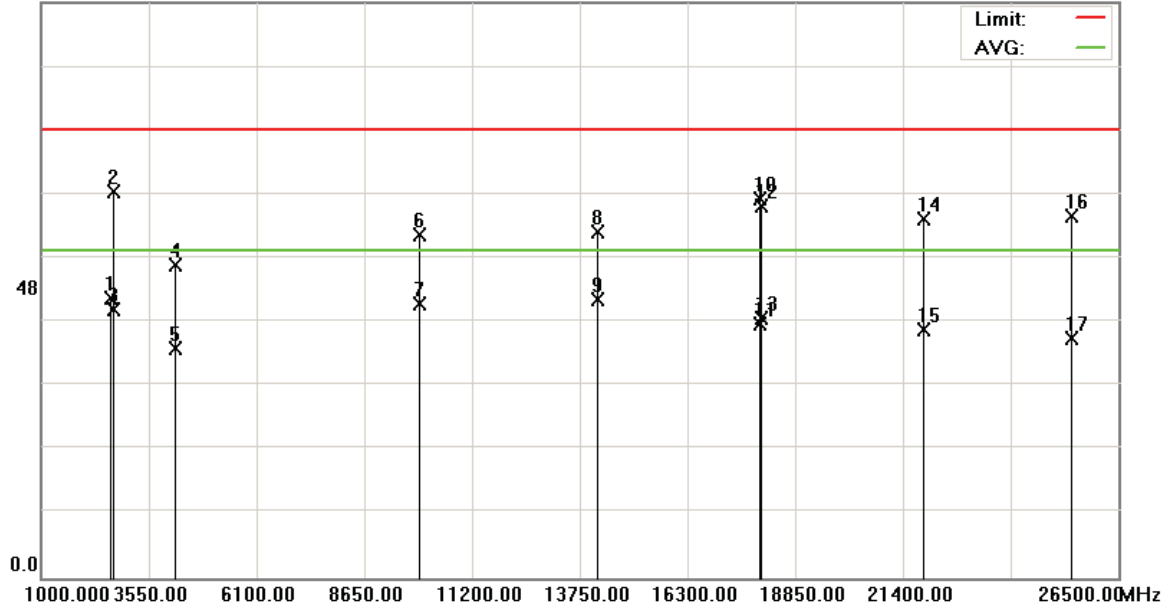

Site: site #1
 Limit: FCC part 15 (PK)
 EUT:
 M/N: 09-0239-EO
 Mode: BT EDR(8DPSK) Link
 Note: 2480MHz

Polarization: **Vertical**
 Power:
 Distance: 3m

Temperature: 22 °C
 Humidity: 60 %

No.	Mk.	Freq. (MHz)	Reading Level (dBuV)	Correct Factor (dB)	Measurement (dBuV)	Limit (dBuV)	Over (dB)	Antenna Height (cm)	Table Degree (degree)	Comment
1		2657.500	45.16	0.93	46.09	74.00	-27.91			peak
2		2700.000	41.16	22.58	63.74	74.00	-10.26			peak
3		2700.000	21.78	22.58	44.36	54.00	-9.64			AVG
4		4141.750	46.71	5.01	51.72	74.00	-22.28			peak
5		4141.750	32.82	5.01	37.83	54.00	-16.17			AVG
6		9945.250	38.75	17.79	56.54	74.00	-17.46			peak
7		9945.250	27.48	17.79	45.27	54.00	-8.73			AVG
8		14160.000	38.29	18.83	57.12	74.00	-16.88			peak
9	*	14160.000	27.23	18.83	46.06	54.00	-7.94			AVG
10		18000.000	37.04	25.57	62.61	74.00	-11.39			peak
11		18000.000	16.30	25.57	41.87	54.00	-12.13			AVG
12		18042.500	38.24	23.27	61.51	74.00	-12.49			peak
13		18042.500	19.59	23.27	42.86	54.00	-11.14			AVG
14		21867.500	38.05	21.19	59.24	74.00	-14.76			peak
15		21867.500	19.78	21.19	40.97	54.00	-13.03			AVG
16		25373.750	40.63	19.05	59.68	74.00	-14.32			peak
17		25373.750	20.57	19.05	39.62	54.00	-14.38			AVG

*:Maximum data x:Over limit !:over margin



4. Maximum Conducted Output Power Requirements

4.1 Test Procedure

The tests below are run with the EUT's transmitter set at high power in TX mode. The EUT is needed to force selection of output power level and channel number. While testing, EUT was set to transmit continuously. Remove the Subjective device's antenna and connect the RF output port to spectrum analyzer. The maximum peak output power shall not exceed 1 watt.

Use a direct connection between the antenna port of transmitter and the spectrum Analyzer, for prevent the spectrum analyzer input attenuation 40-50 dB. Set the RBW Bandwidth of the emission or use a channel power meter mode.

For antennas with gains of 6 dBi or less, maximum allowed transmitter output is 1 watt (+30 dBm). For antennas with gains greater than 6 dBi, transmitter output level must be decreased by an amount equal to (GAIN - 6)/3 dBm.

The antenna port of the EUT was connected to the input of a spectrum analyzer. Power was read directly and cable loss correction was added to the reading to obtain power at the EUT antenna terminals.

4.2 Limits

For frequency hopping systems in the 2400–2483.5 MHz band < 0.125 watts.

4.3 Test Equipment List

Describe	Manufacturer	Model	Serial Number	Calibration	
				Cal. Date	Due Date
Spectrum Analyzer	Agilent	E4445A	MY46181986	May 14, 2009	May 14, 2010
Attenuator	RADIALL	R415710000	0603033065	NA	NA

4.4 Test Instruments Configuration

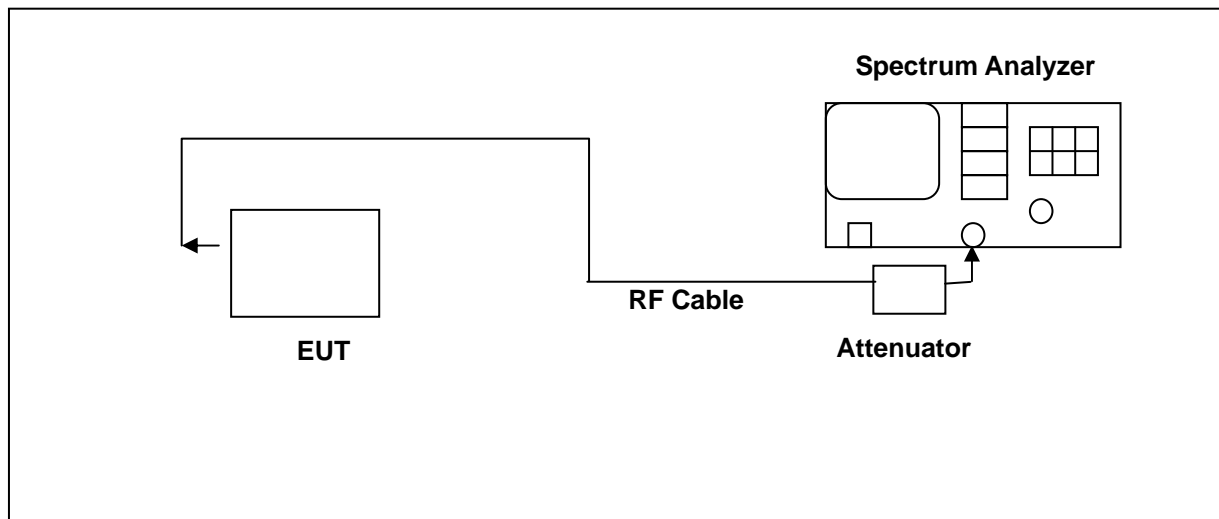

4.5 Test Result

EUT : NANO USB DONGLE
 Model No. : BT 06K
 Test Mode : Bluetooth 2.1(GFSK) Link Mode
 Test Date : 10/05/2009

Frequency (MHz)	RF Output Power		Required Limit
	Average (dBm)	Peak (dBm)	
2402	7.349	7.500	< 20.97 dBm
2441	7.673	7.740	< 20.97 dBm
2480	7.166	7.222	< 20.97 dBm

EUT : NANO USB DONGLE
 Model No. : BT 06K
 Test Mode : Bluetooth EDR(8DPSK) Link Mode
 Test Date : 10/05/2009

Frequency (MHz)	RF Output Power		Required Limit
	Average (dBm)	Peak (dBm)	
2402	8.054	8.873	< 20.97 dBm
2441	8.440	8.843	< 20.97 dBm
2480	7.710	8.292	< 20.97 dBm



4.6 Test Graphs

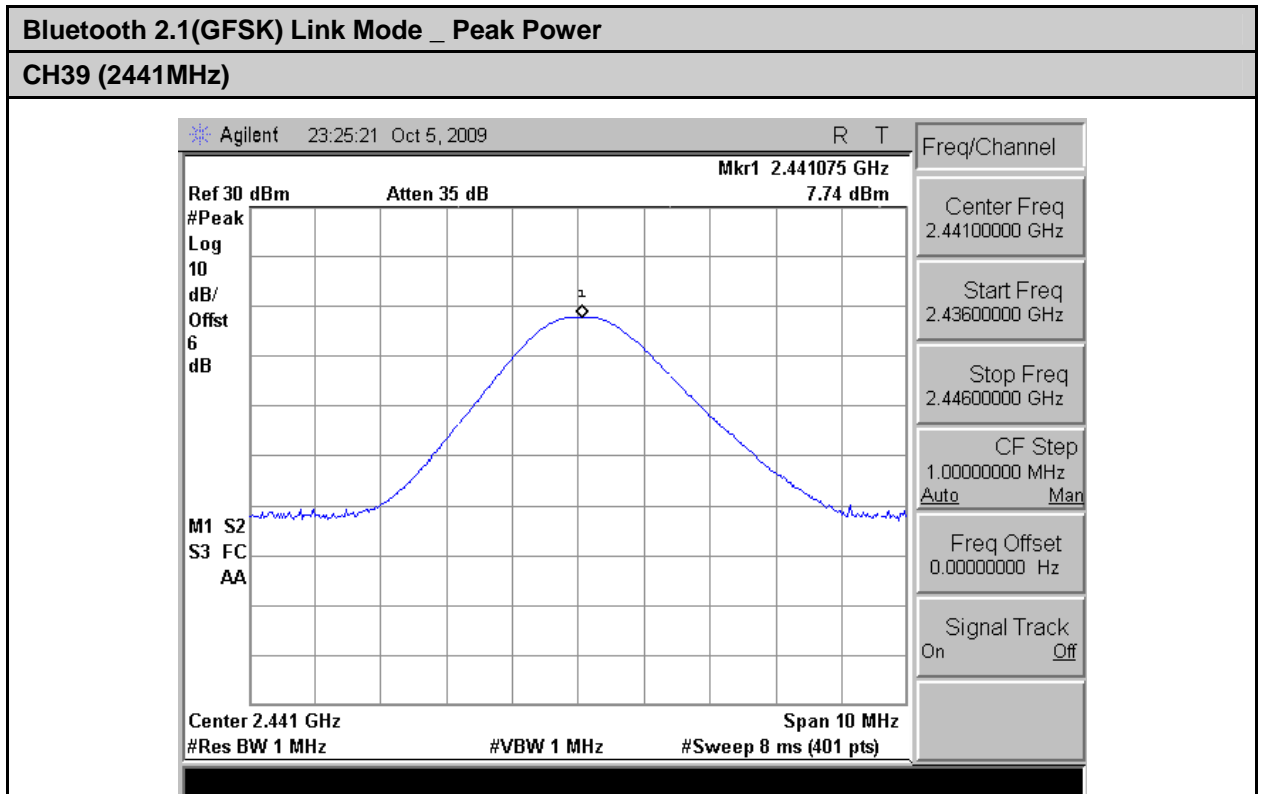
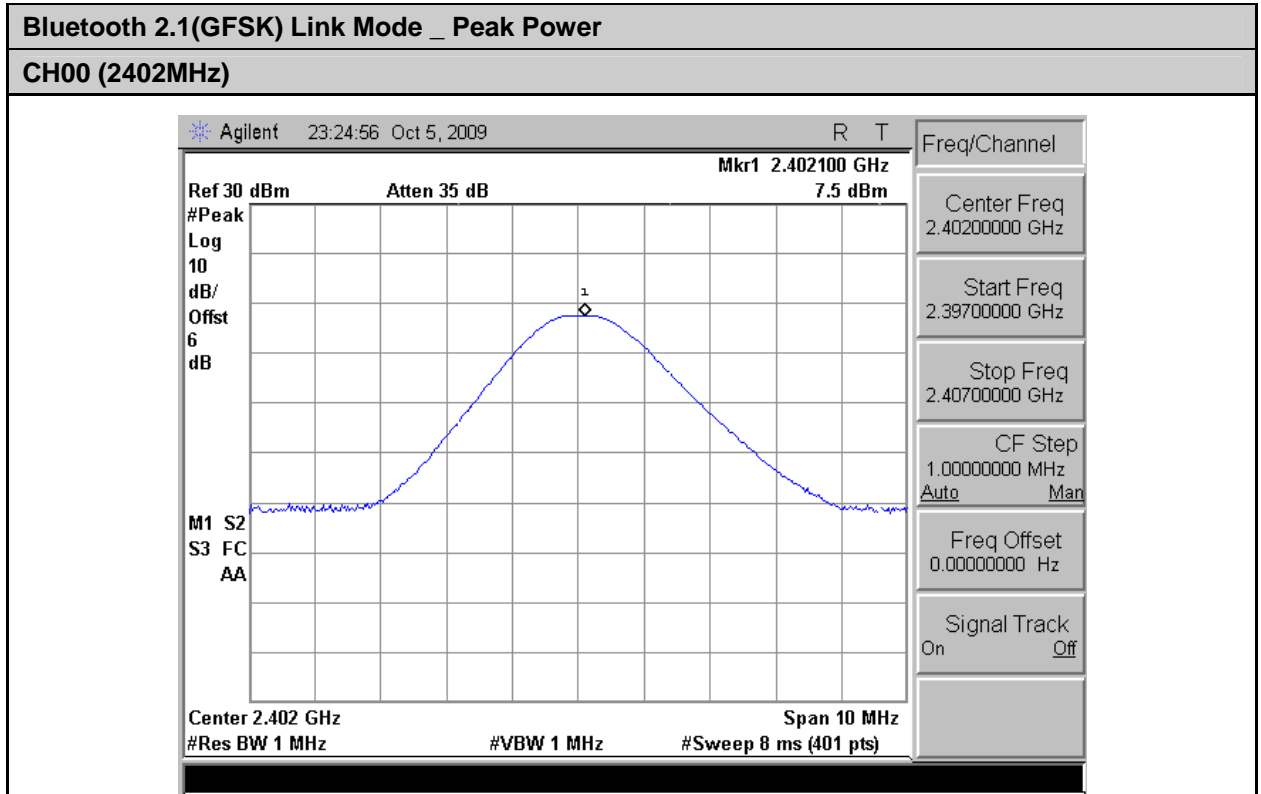



Bluetooth 2.1(GFSK) Link Mode _ Peak Power

CH78 (2480MHz)

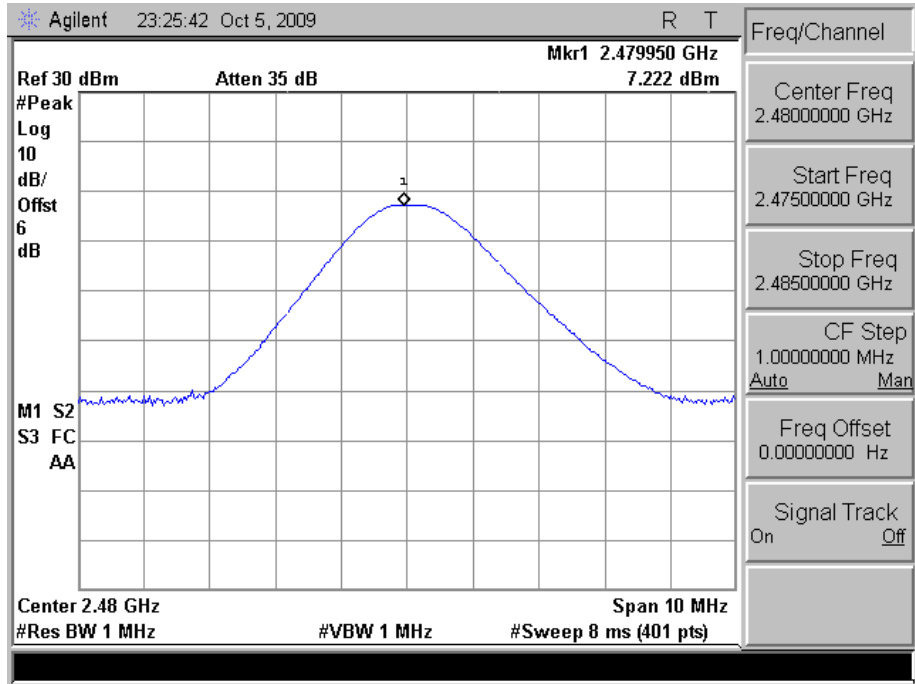



Bluetooth 2.1(GFSK) Link Mode _ Average Power

CH00 (2402MHz)

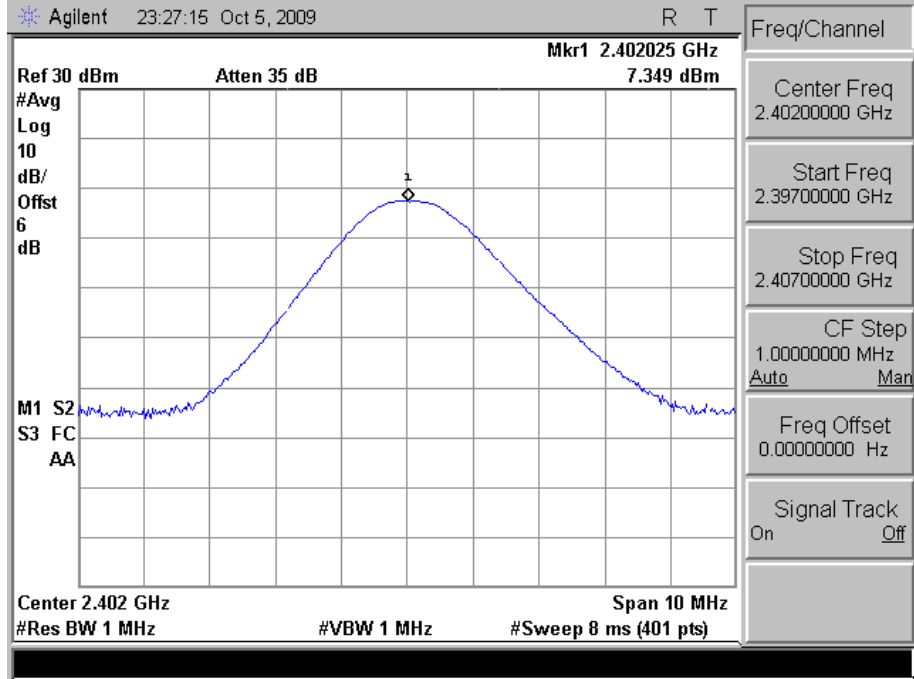

Bluetooth 2.1(GFSK) Link Mode _ Average Power

CH39 (2441MHz)

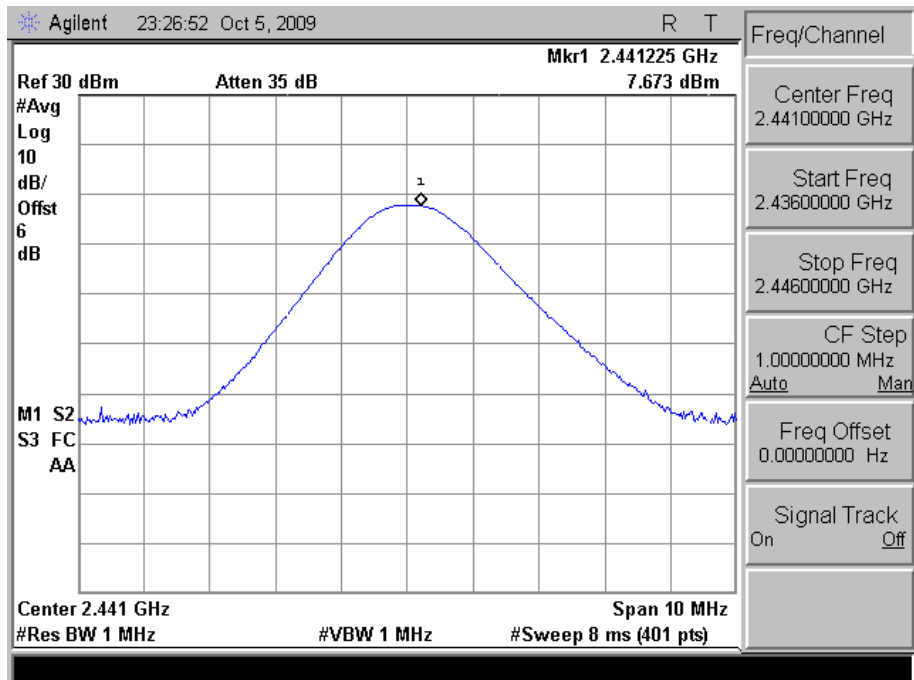



Bluetooth 2.1(GFSK) Link Mode _ Average Power

CH78 (2480MHz)

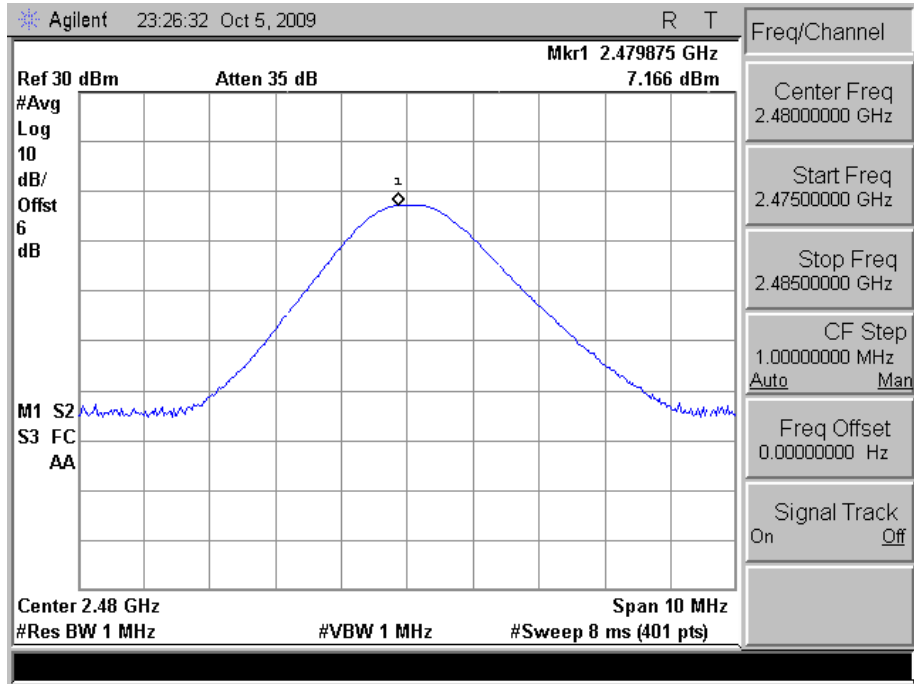



Bluetooth EDR(8DPSK) Link Mode _ Peak Power

CH00 (2402MHz)

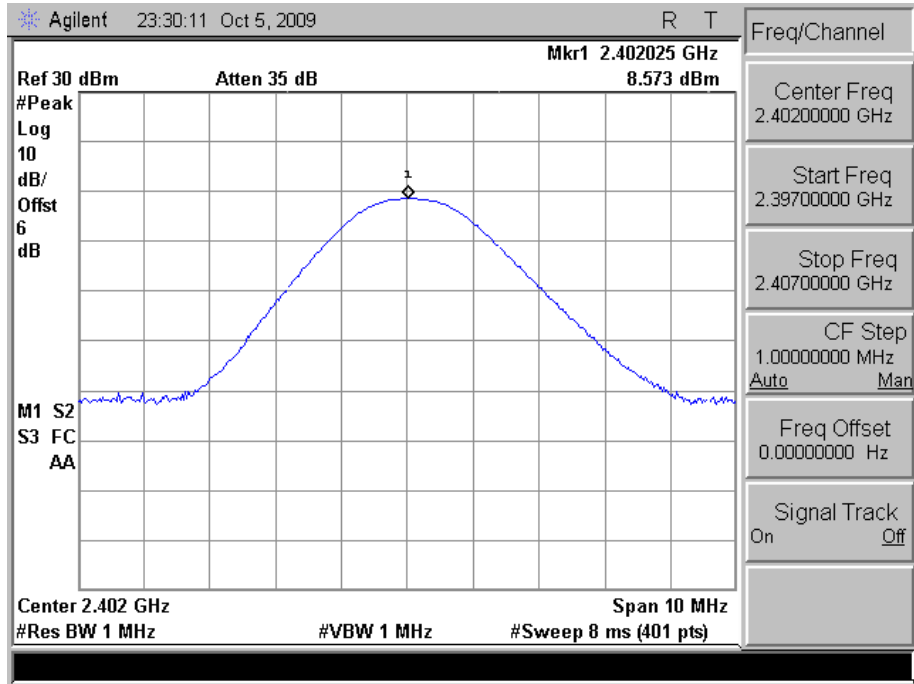

Bluetooth EDR(8DPSK) Link Mode _ Peak Power

CH39 (2441MHz)

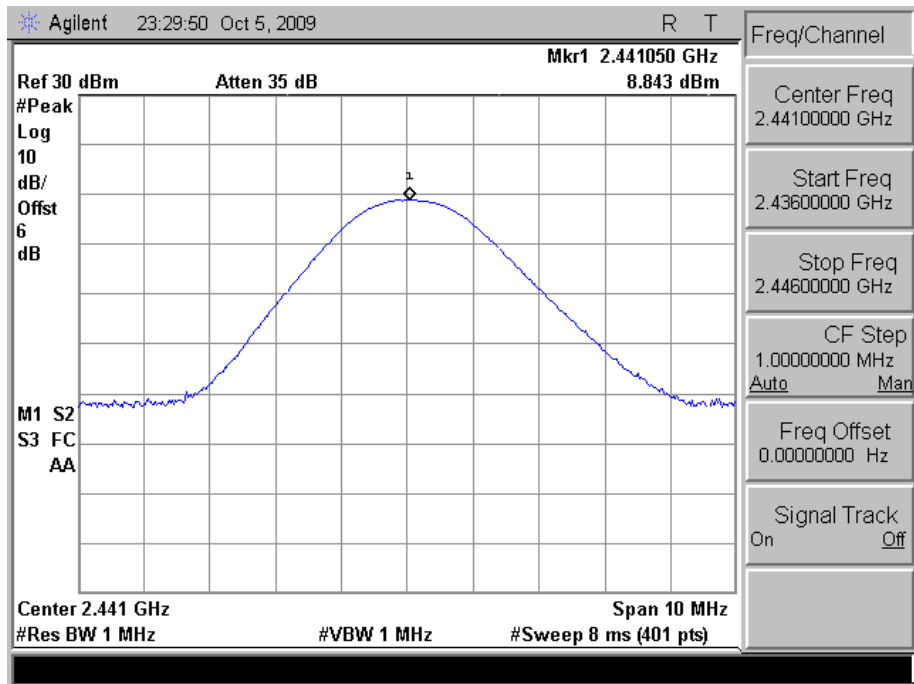



Bluetooth EDR(8DPSK) Link Mode _ Peak Power

CH78 (2480MHz)

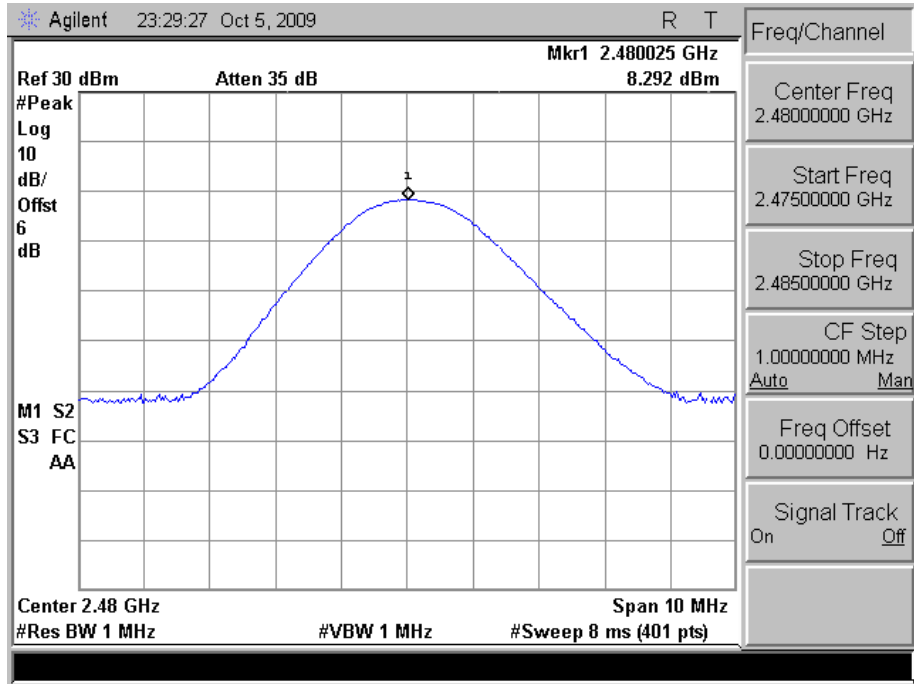



Bluetooth EDR(8DPSK) Link Mode _ Average Power

CH00 (2402MHz)

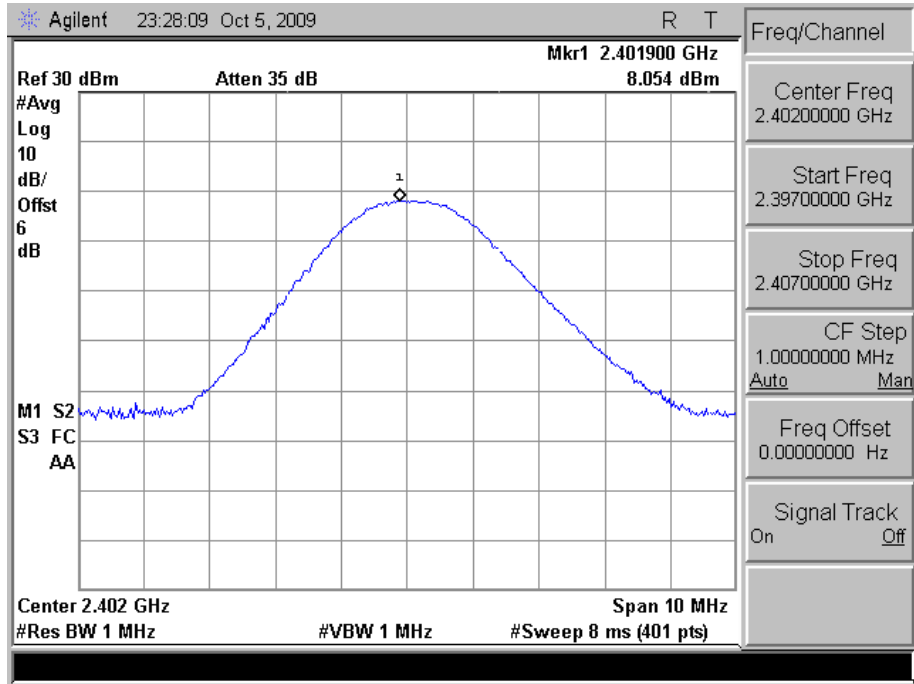

Bluetooth EDR(8DPSK) Link Mode _ Average Power

CH39 (2441MHz)

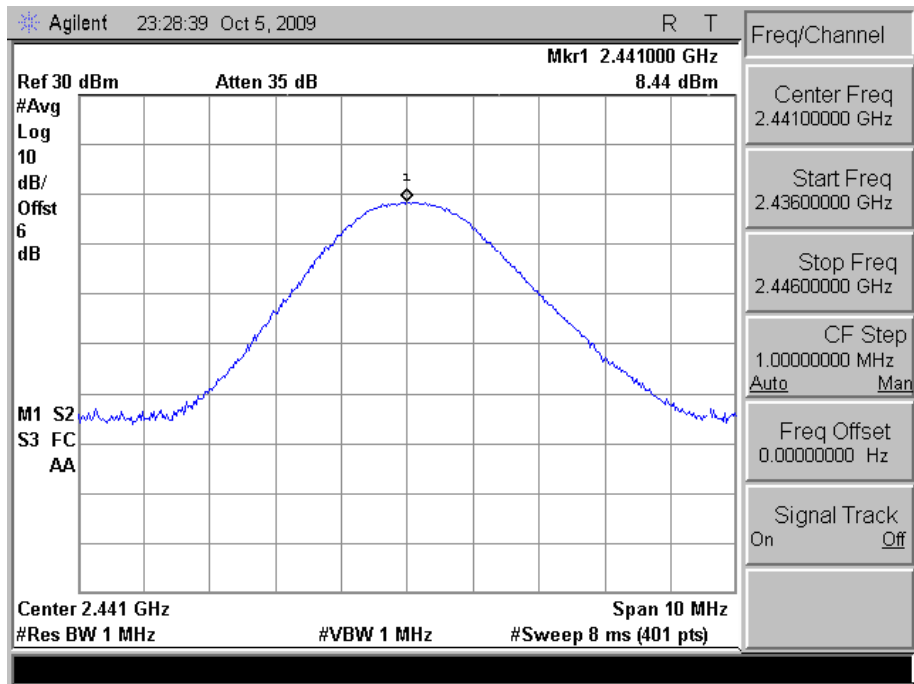



Bluetooth EDR(8DPSK) Link Mode _ Average Power

CH78 (2480MHz)

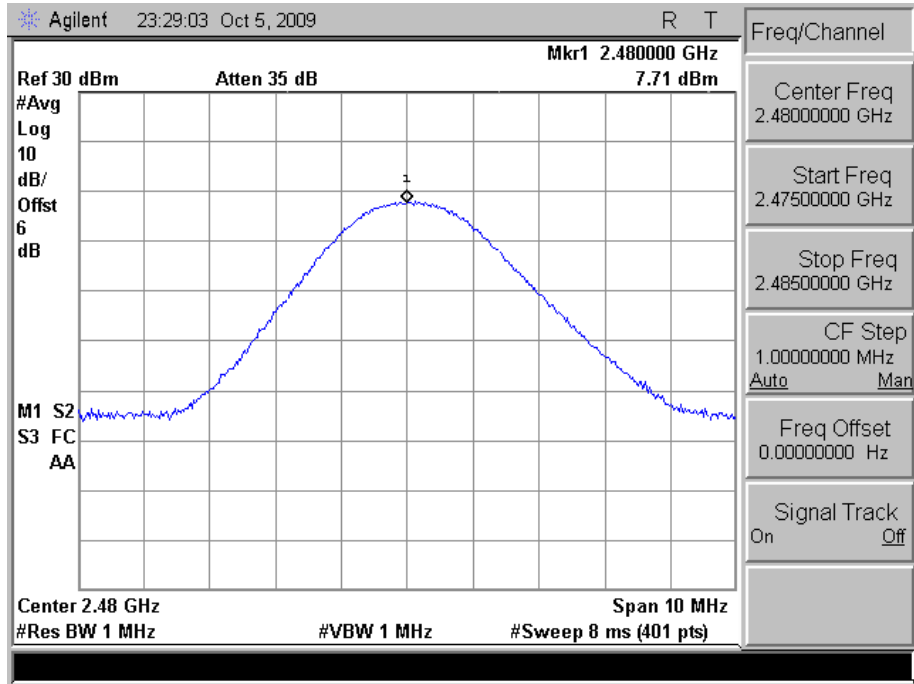



5. Minimum 20dB RF Bandwidth Requirements

5.1 Test Procedure

The RF output port of the Equipment-Under-Test is directly coupled to the input of the EMC analyzer through a specialized RF connector and a 10dB passive attenuator. A fully charged battery was used for the supply voltage. The Bluetooth frequency hopping function of the EUT was enabled. The spectrum analyzer used the following settings:

1. Span = approx. 2 to 3 times the 20dB bandwidth, centered on a hopping frequency
2. RBW \geq 1% of the 20dB span
3. VBW \geq RBW
4. Sweep = auto
5. Detector function = peak
6. Trace = max hold

The trace was allowed to stabilize. The EUT was transmitting at its maximum data rate. The marker-to-peak function was used to set the marker to the peak of the emission. The marker-delta function was used to measure 20dB down one side of the emission. The marker-delta function and marker was moved to the other side of the emission until it was even with the reference marker. The marker-delta reading at this point was the 20dB bandwidth of the emission.

5.2 Limits

N/A

5.3 Test Equipment List

Describe	Manufacturer	Model	Serial Number	Calibration	
				Cal. Date	Due Date
Spectrum Analyzer	Agilent	E4445A	MY46181986	May 14, 2009	May 14, 2010

5.4 Test Instruments Configuration

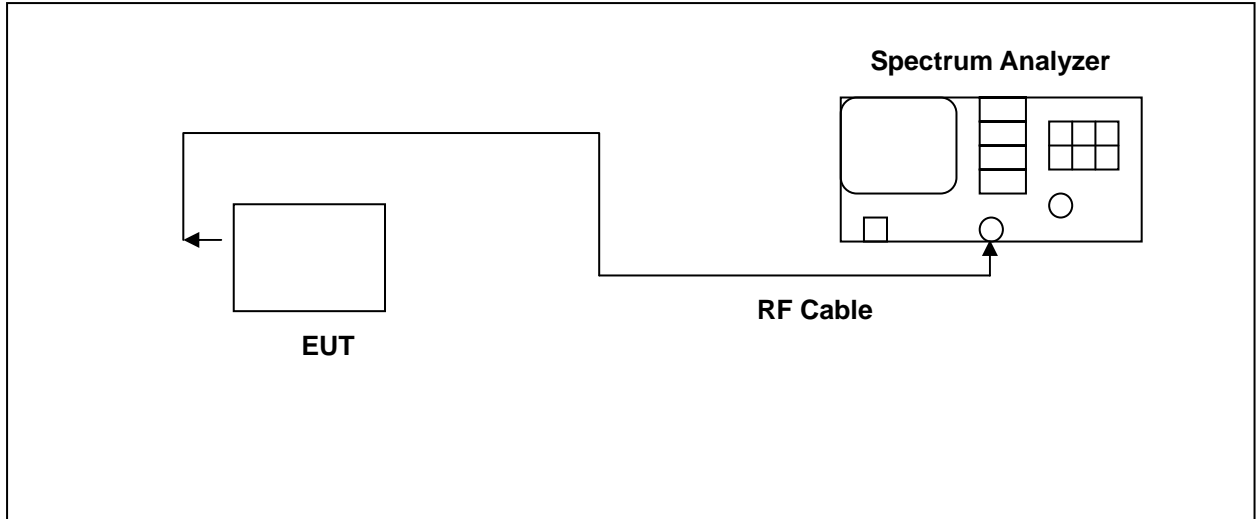

5.5 Test Result

EUT : NANO USB DONGLE
 Model No. : BT 06K
 Test Mode : Bluetooth 2.1(GFSK) Link Mode
 Test Date : 10/05/2009

Frequency (MHz)	Max 20dB Bandwidth (MHz)
2402	915
2441	865
2480	800

EUT : NANO USB DONGLE
 Model No. : BT 06K
 Test Mode : Bluetooth EDR(8DPSK) Link Mode
 Test Date : 10/05/2009

Frequency (MHz)	Max 20dB Bandwidth (MHz)
2402	1.270
2441	1.280
2480	1.280



5.6 Test Graphs

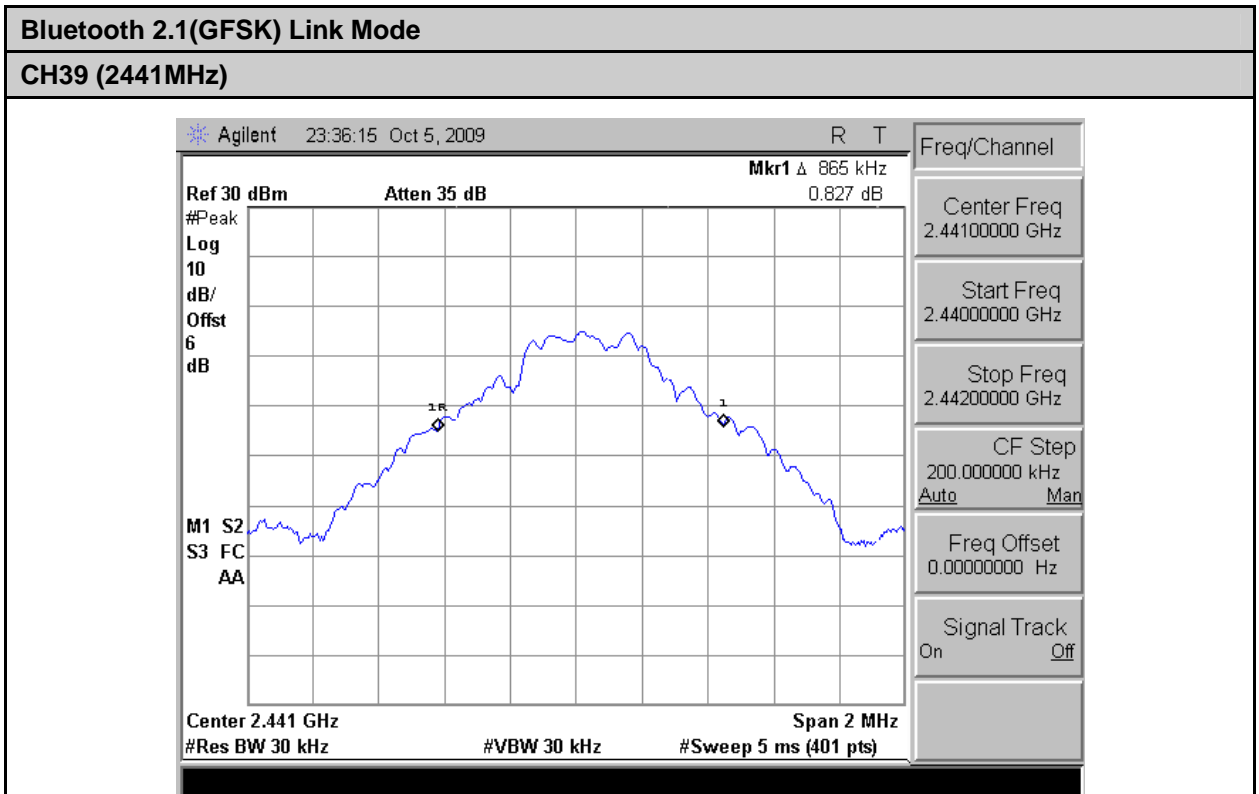
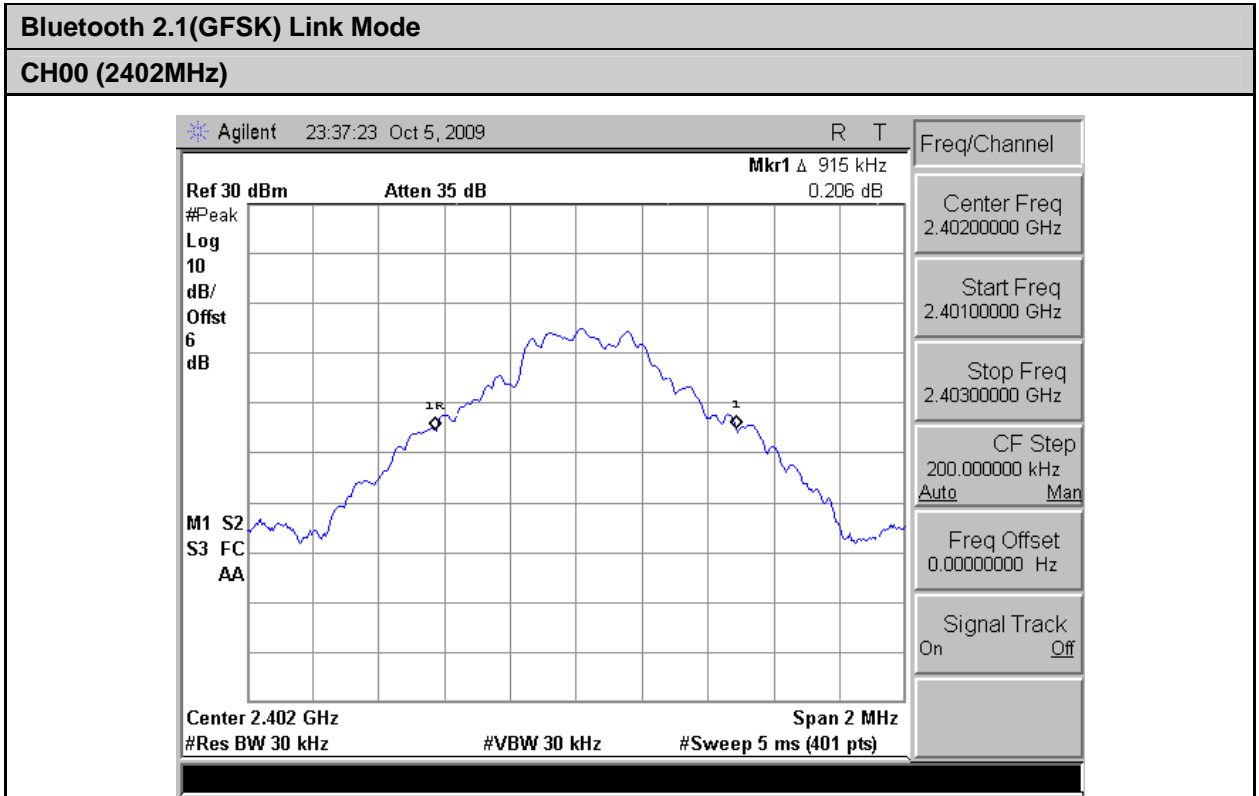



Bluetooth 2.1(GFSK) Link Mode

CH78 (2480MHz)

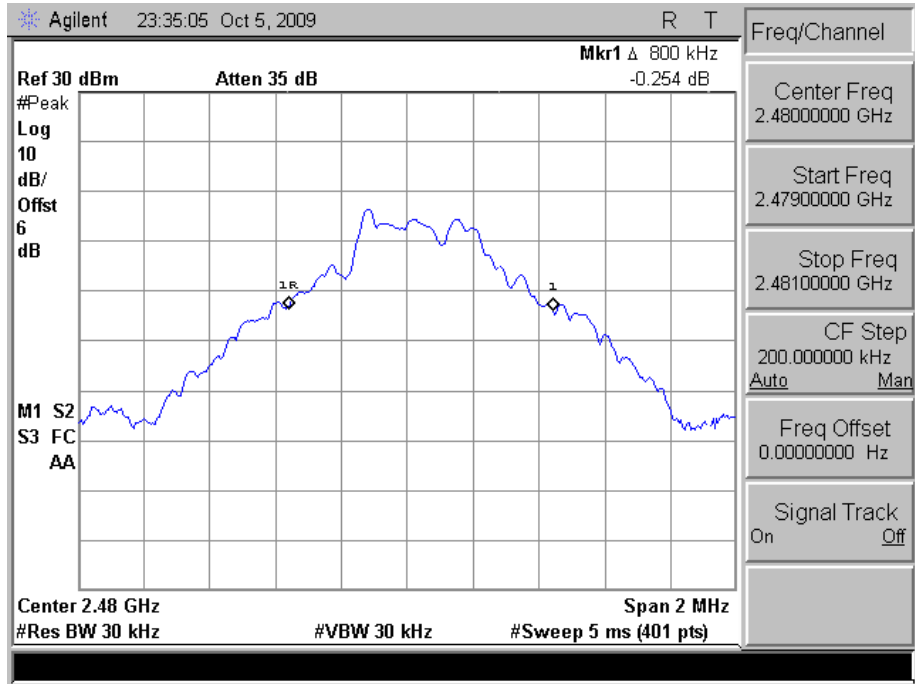



Bluetooth EDR(8DPSK) Link Mode

CH00 (2402MHz)

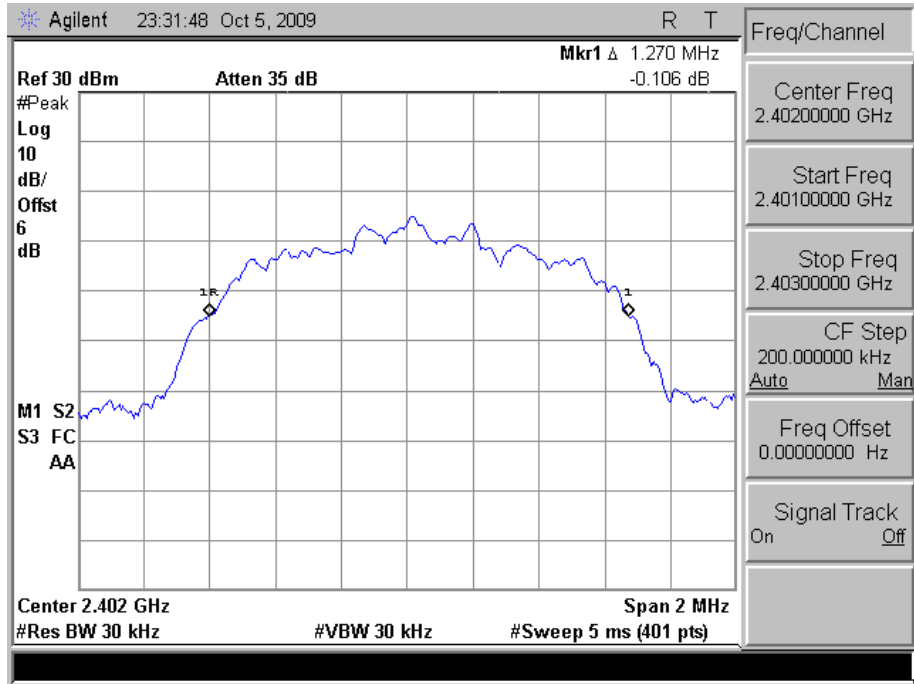

Bluetooth EDR(8DPSK) Link Mode

CH39 (2441MHz)

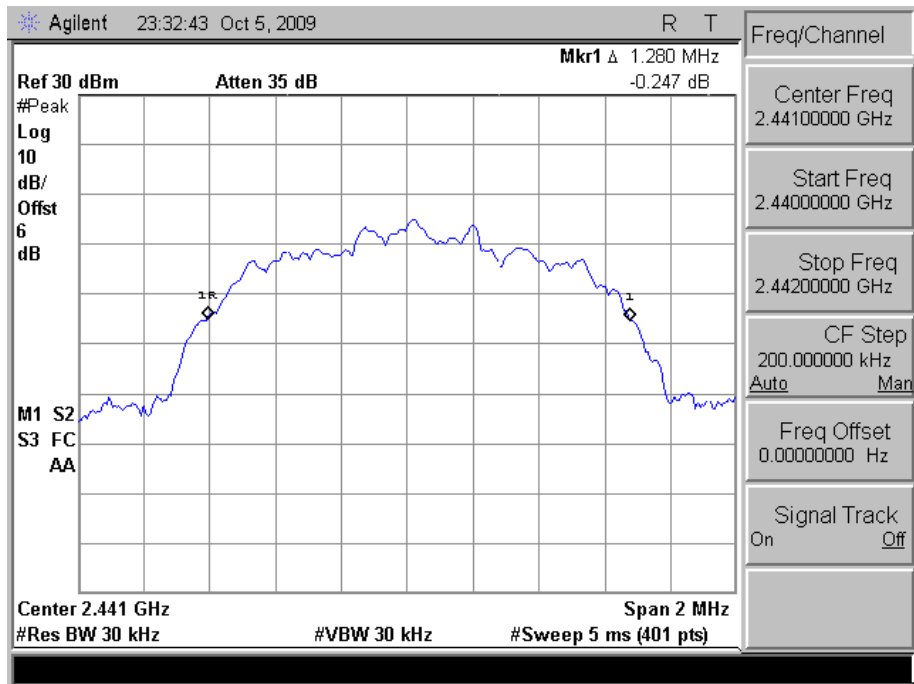



Bluetooth EDR(8DPSK) Link Mode

CH78 (2480MHz)

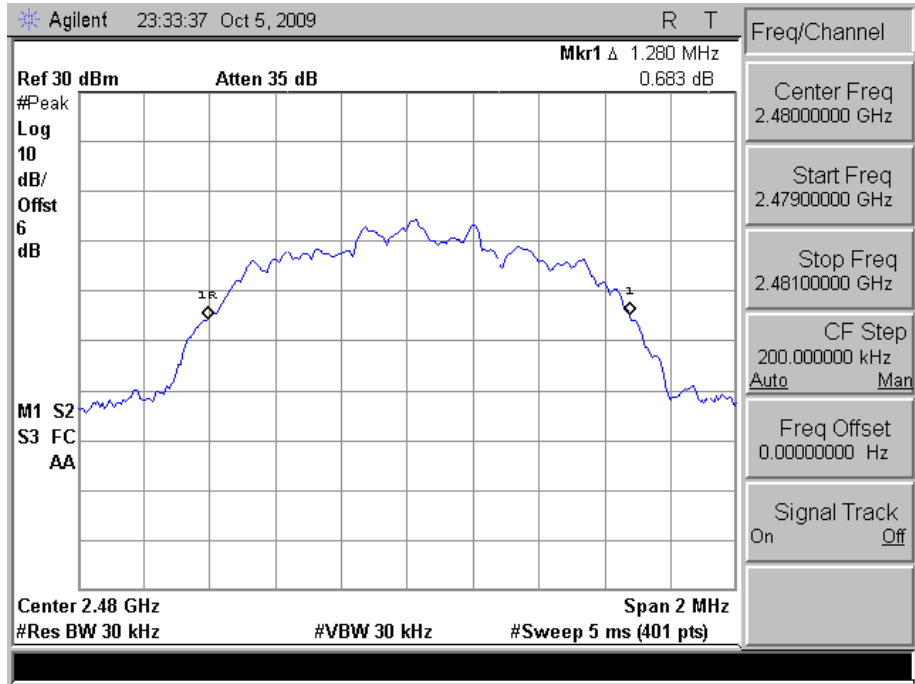



6. Carrier Frequency Separation Requirements

6.1 Test Procedure

The RF output port of the Equipment-Under-Test is directly coupled to the input of the EMC analyzer through a specialized RF connector and a 10dB passive attenuator. A fully charged battery was used for the supply voltage. The Bluetooth transmitter of the V6 had its hopping function enabled. The following spectrum analyzer settings were used:

1. Span = wide enough to capture the peaks of two adjacent channels
2. Resolution (or IF) Bandwidth (RBW) \geq 1% of the span
3. Video (or Average) Bandwidth (VBW) \geq RBW
4. Sweep = auto
5. Detector function = peak
6. Trace = max hold

The trace was allowed to stabilize. The marker-delta function was used to determine the separation between the peaks of the adjacent channels.

6.2 Limits

Frequency hopping systems operating in the 2400-2483.5 MHz band may have hopping channel carrier frequencies that are separated by 25 kHz or two-thirds of the 20 dB bandwidth of the hopping channel, whichever is greater, provided the systems operate with an output power no greater than 125 mW.

6.3 Test Equipment List

Describe	Manufacturer	Model	Serial Number	Calibration	
				Cal. Date	Due Date
Spectrum Analyzer	Agilent	E4445A	MY46181986	May 14, 2009	May 14, 2010
Attenuator	RADIALL	R41572000	0603033073	NA	NA

6.4 Test Instruments Configuration

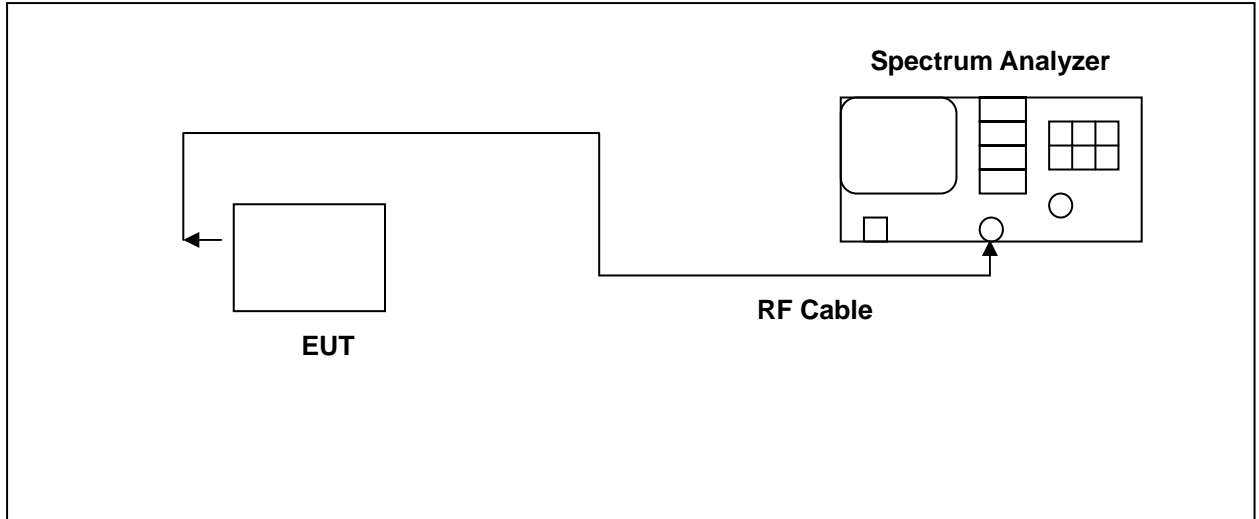

6.5 Test Result

EUT : NANO USB DONGLE
 Model No. : BT 06K
 Test Mode : Bluetooth 2.1(GFSK) Link Mode
 Test Date : 10/05/2009

Frequency (MHz)	Frequency Separation (MHz)
2402	1
2441	1
2480	1

EUT : NANO USB DONGLE
 Model No. : BT 06K
 Test Mode : Bluetooth EDR(8DPSK) Link Mode
 Test Date : 10/05/2009

Frequency (MHz)	Frequency Separation (MHz)
2402	1
2441	1
2480	1



6.6 Test Graphs

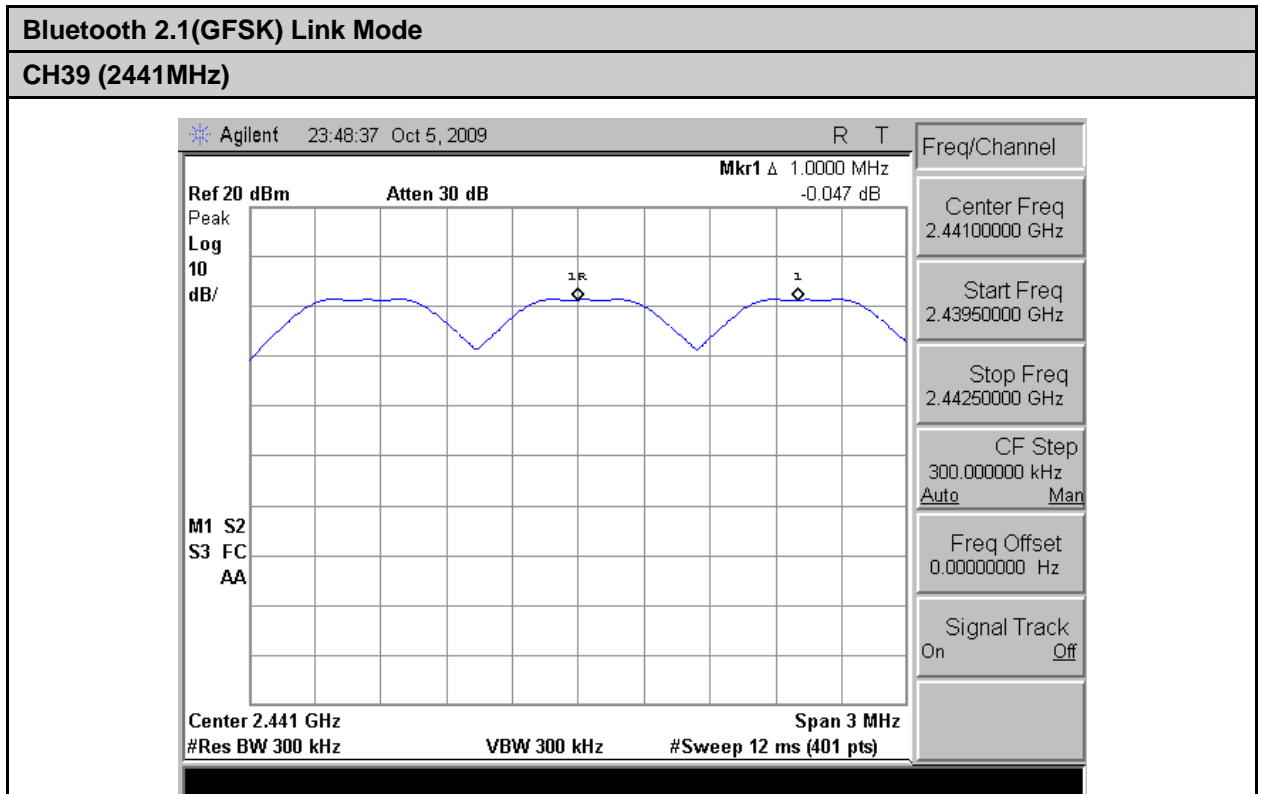
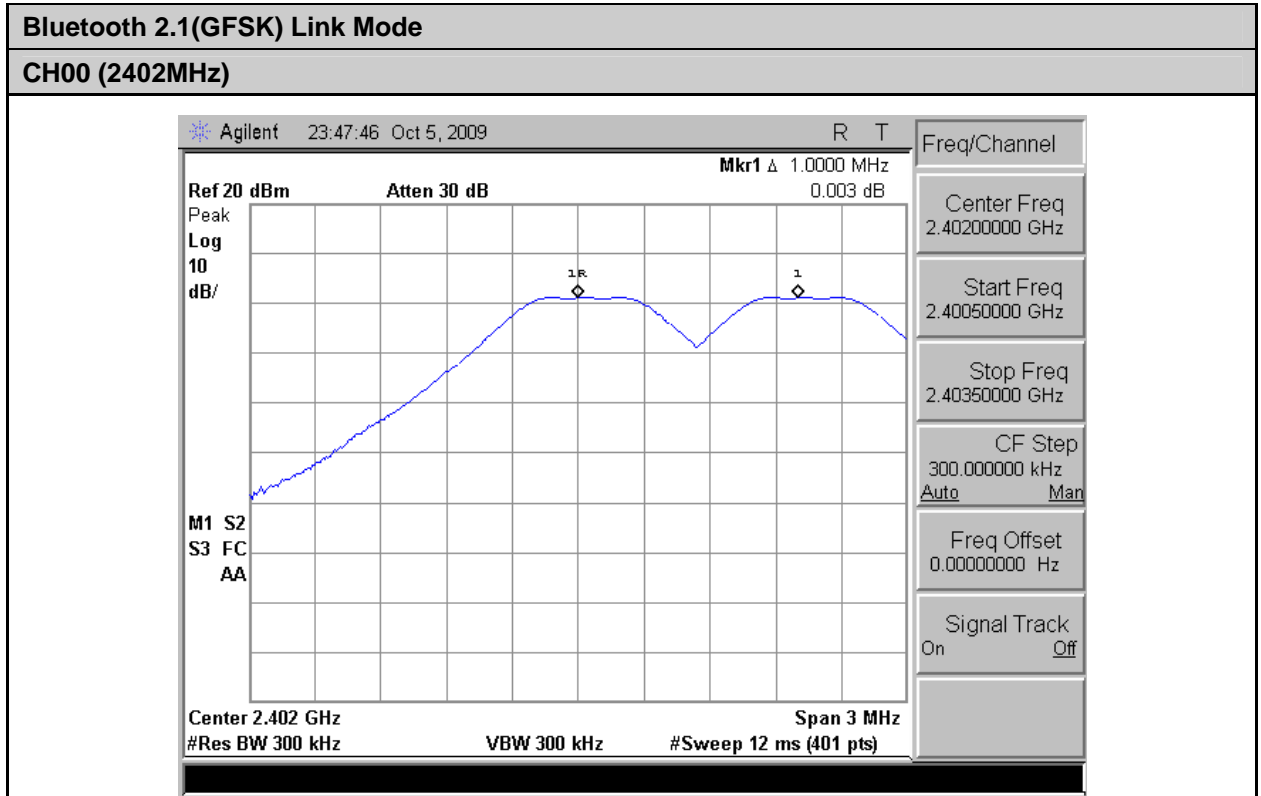



Bluetooth 2.1(GFSK) Link Mode

CH78 (2480MHz)

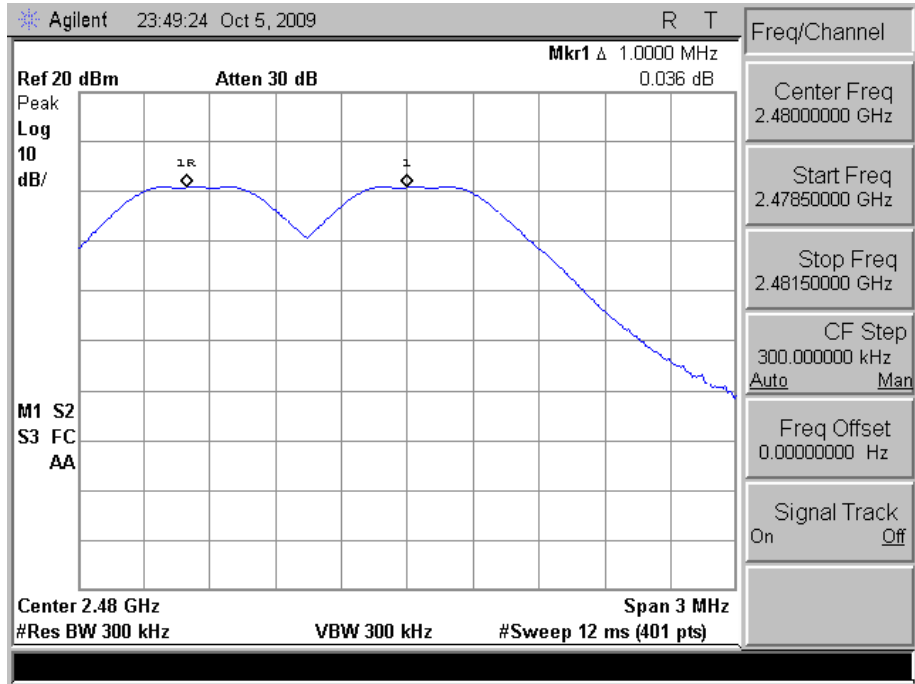



Bluetooth EDR(8DPSK) Link Mode

CH00 (2402MHz)

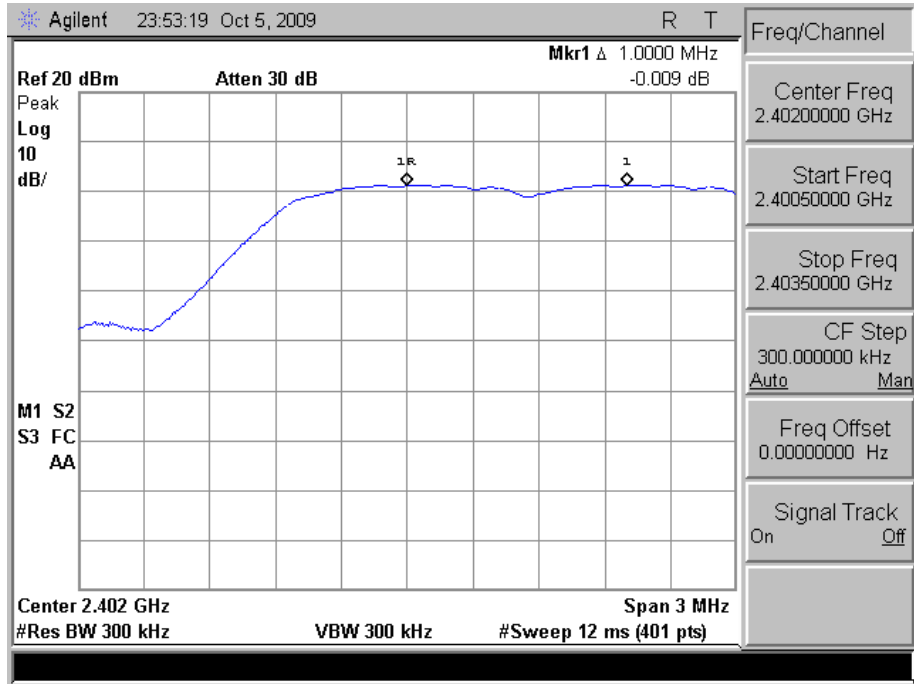

Bluetooth EDR(8DPSK) Link Mode

CH39 (2441MHz)

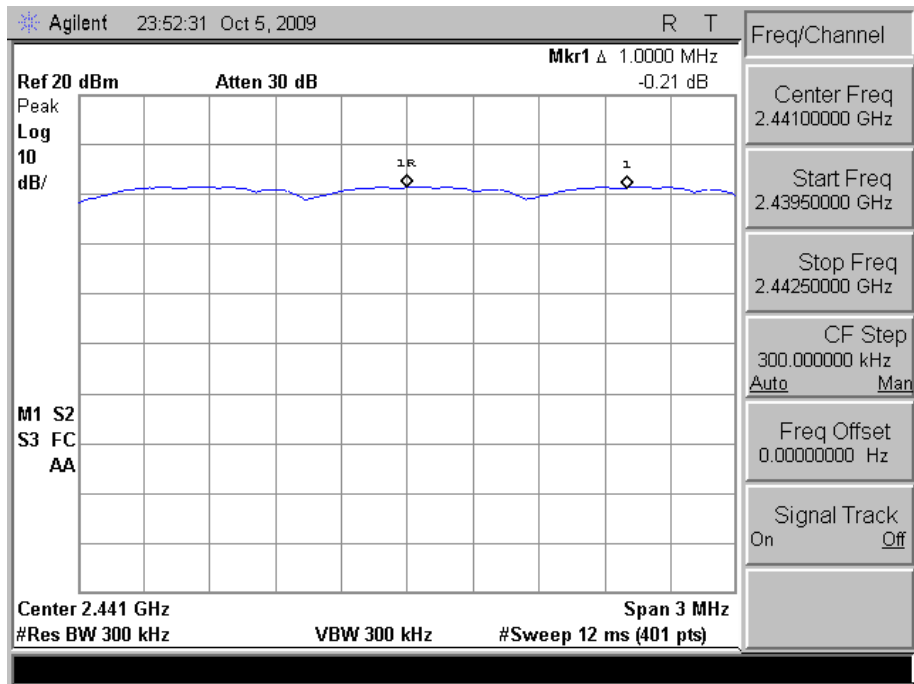



Bluetooth EDR(8DPSK) Link Mode

CH78 (2480MHz)

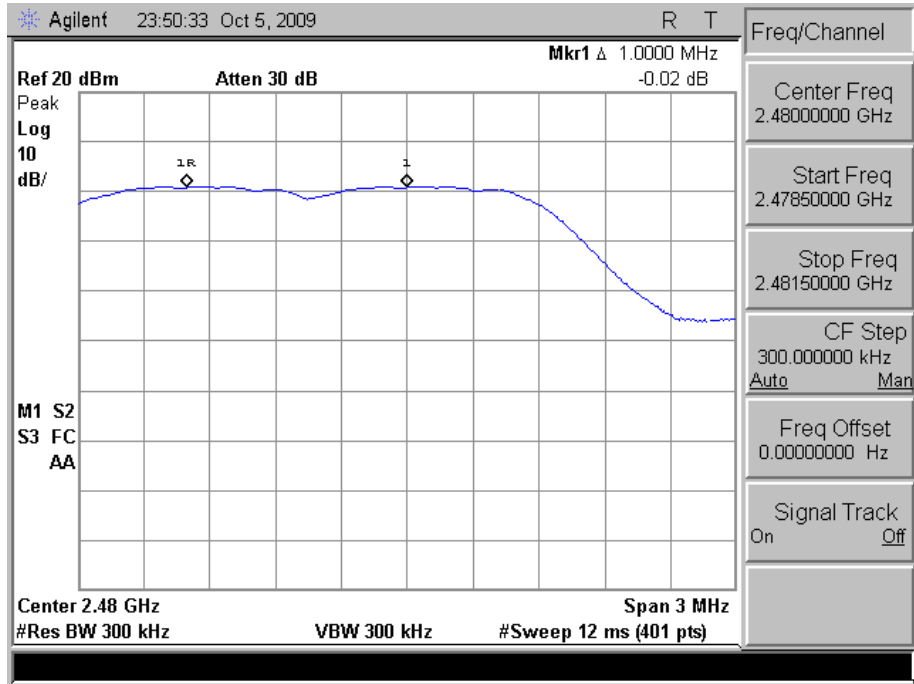



7. Number of Hopping Requirements

7.1 Test Procedure

The RF output port of the Equipment-Under-Test is directly coupled to the input of the EMC analyzer through a specialized RF connector and a 10dB passive attenuator. A fully charged battery was used for the supply voltage. The Bluetooth frequency hopping function of the EUT was enabled. The spectrum analyzer used the following settings:

1. Span = the frequency band of operation
2. RBW \geq 1% of the span
3. VBW \geq RBW
4. Sweep = auto
5. Detector function = peak
6. Trace = max hold

The trace was allowed to stabilize.

7.2 Limits

Frequency hopping systems in the 2400-2483.5 MHz band shall use at least 15 channels.

7.3 Test Equipment List

Describe	Manufacturer	Model	Serial Number	Calibration	
				Cal. Date	Due Date
Spectrum Analyzer	Agilent	E4445A	MY46181986	May 14, 2009	May 14, 2010
Attenuator	RADIALL	R41572000	0603033073	NA	NA

7.4 Test Instruments Configuration

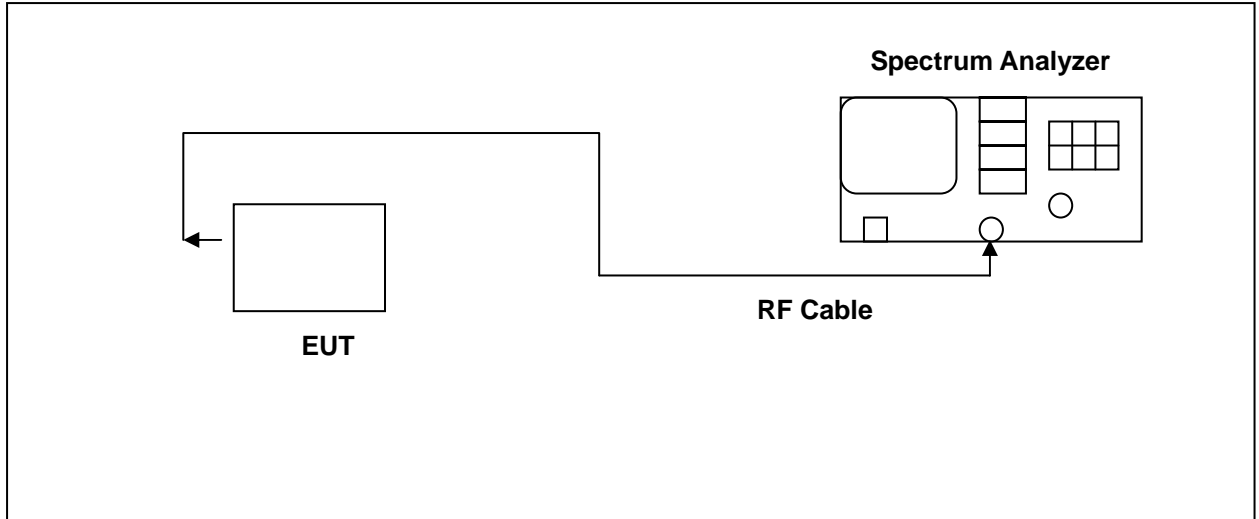

7.5 Test Result

EUT : NANO USB DONGLE
 Model No. : BT 06K
 Test Mode : Bluetooth 2.1(GFSK) Link Mode
 Test Date : 10/05/2009

Number of Hopping Channels	Limits
79	> 15

EUT : NANO USB DONGLE
 Model No. : BT 06K
 Test Mode : Bluetooth EDR(8DPSK) Link Mode
 Test Date : 10/05/2009

Number of Hopping Channels	Limits
79	> 15



7.6 Test Graphs

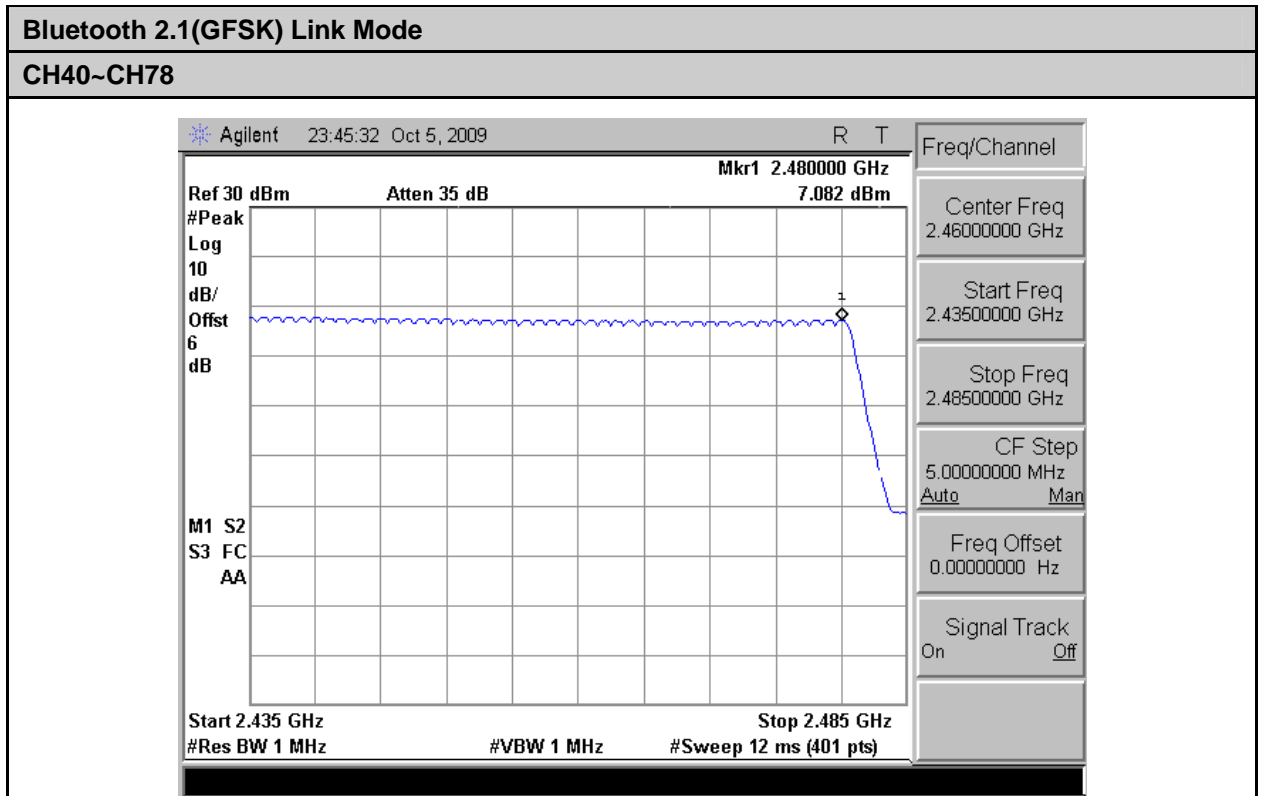
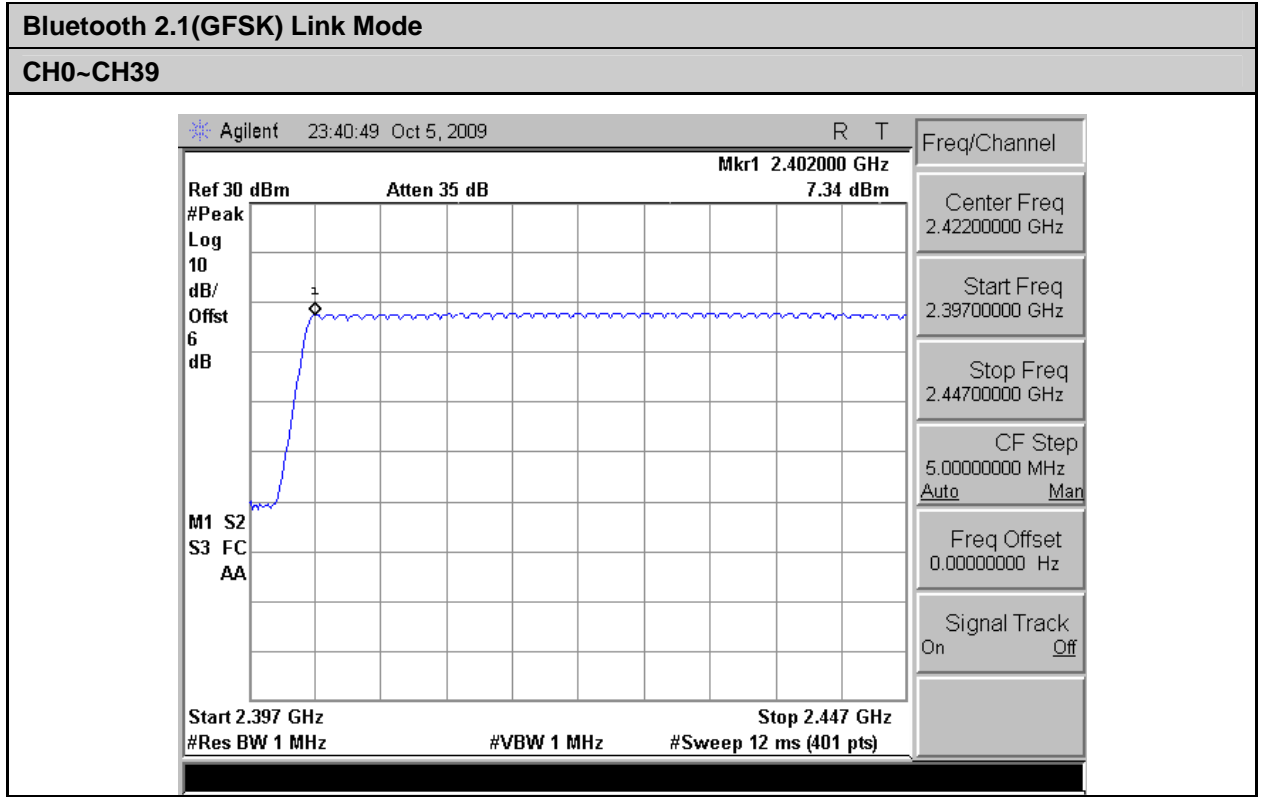



Bluetooth EDR(8DPSK) Link Mode

CH0~CH39

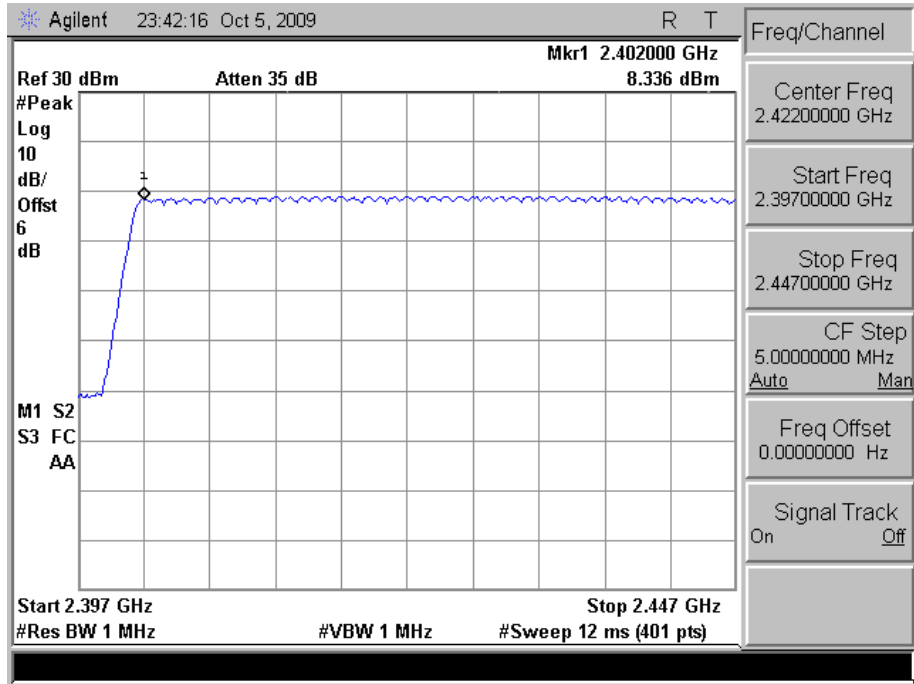

Bluetooth EDR(8DPSK) Link Mode

CH40~CH78

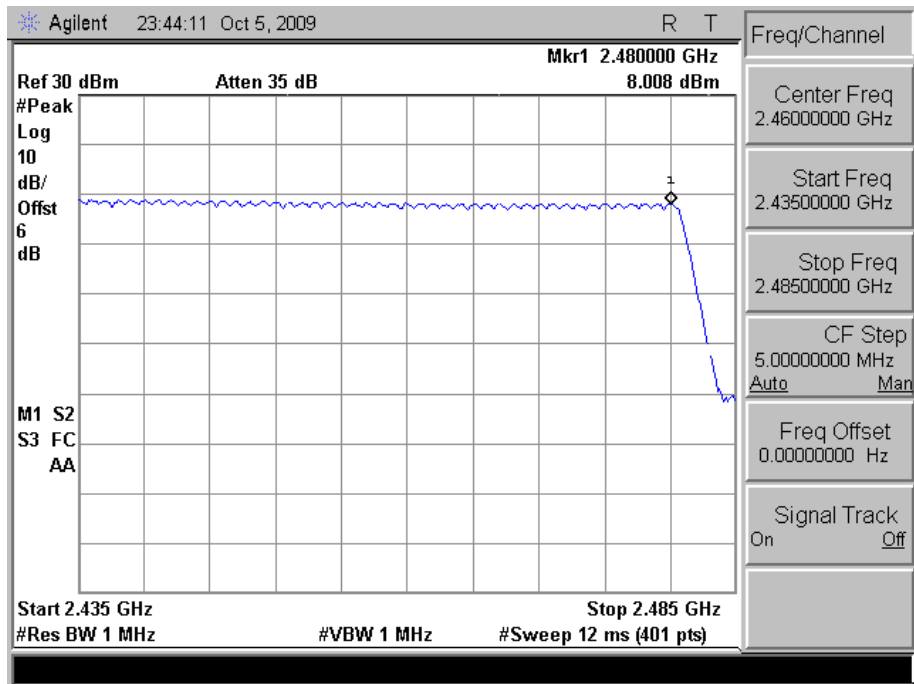

8. Time of Occupancy (Dwell Time) Requirements

8.1 Test Procedure

The RF output port of the Equipment-Under-Test is directly coupled to the input of the EMC analyzer through a specialized RF connector and a 10dB passive attenuator. A fully charged battery was used for the supply voltage. The Bluetooth hopping function of the EUT was enabled. The following spectrum analyzer settings were used:

1. Span = zero span, centered on a hopping channel
2. RBW = 1 MHz
3. VBW \geq RBW
4. Sweep = as necessary to capture the entire dwell time per hopping channel
5. Detector function = peak
6. Trace = max hold

The marker-delta function was used to determine the dwell time.

8.2 Limits

The average time of occupancy on any channel shall not be greater than 0.4 seconds within a period of 0.4 seconds multiplied by the number of hopping channels employed.

8.3 Test Equipment List

Describe	Manufacturer	Model	Serial Number	Calibration	
				Cal. Date	Due Date
Spectrum Analyzer	Agilent	E4445A	MY46181986	May 14, 2009	May 14, 2010
Attenuator	RADIALL	R41572000	0603033073	NA	NA

8.4 Test Instruments Configuration

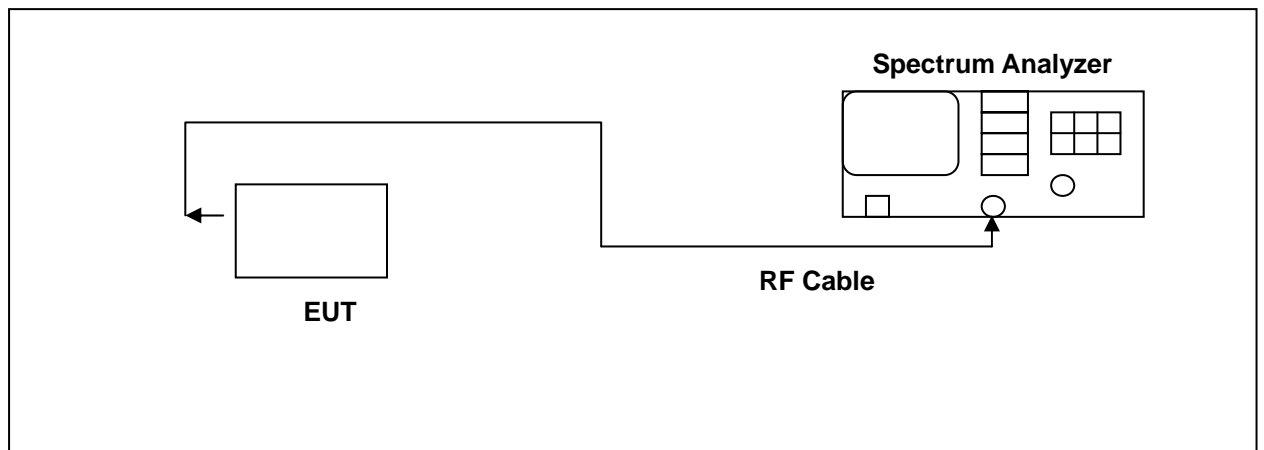



8.5 Test Result

EUT : NANO USB DONGLE
 Model No. : BT 06K
 Test Mode : Bluetooth 2.1(GFSK) Link Mode
 Test Date : 10/05/2009

DH1 Mode	
Cycle Calculate	$79CH * 0.4 = 31.6$ (sec)
The EUT Hopping Number per Sec	1600 times/sec
Each Channel Dwell Times per Sec	$800/79CH = 10.13$ (times/sec)
Each Channel Dwell Times (1)	0.37 ms (sec)
Each Channel Dwell Times on Cycle(2)	$31.6 * 10.13 = 320.108$ (times)
Dwell Times on Cycle (1) * (2)	118.43996 ms (sec)
LIMIT(msec)	< = 400

DH3 Mode	
Cycle Calculate	$79CH * 0.4 = 31.6$ (sec)
The EUT Hopping Number per Sec	1600 times/sec
Each Channel Dwell Times per Sec	$400/79CH=5.1$ (times/sec)
Each Channel Dwell Times (1)	1.60 ms (sec)
Each Channel Dwell Times on Cycle(2)	$31.6*5.1=161.16$ (times)
Dwell Times on Cycle (1) * (2)	257.856 ms (sec)
LIMIT(msec)	< = 400

DH5 Mode	
Cycle Calculate	$79CH * 0.4 = 31.6$ (sec)
The EUT Hopping Number per Sec	1600 times/sec
Each Channel Dwell Times per Sec	$266.7/79CH=3.37$ (times/sec)
Each Channel Dwell Times (1)	2.88 ms (sec)
Each Channel Dwell Times on Cycle(2)	$31.6*3.37=106.492$ (times)
Dwell Times on Cycle (1) * (2)	306.69696 ms (sec)
LIMIT(msec)	< = 400

Note: RB=1MHz; VB=1MHz; SPAN=0MHz; Sweep Time=20msec



EUT : NANO USB DONGLE
 Model No. : BT 06K
 Test Mode : Bluetooth EDR(8DPSK) Link Mode
 Test Date : 10/05/2009

DH1 Mode	
Cycle Calculate	$79CH * 0.4 = 31.6$ (sec)
The EUT Hopping Number per Sec	1600 times/sec
Each Channel Dwell Times per Sec	$800/79CH = 10.13$ (times/sec)
Each Channel Dwell Times (1)	0.39 ms (sec)
Each Channel Dwell Times on Cycle(2)	$31.6 * 10.13 = 320.108$ (times)
Dwell Times on Cycle (1) * (2)	124.84212 ms (sec)
LIMIT(msec)	$< = 400$

DH3 Mode	
Cycle Calculate	$79CH * 0.4 = 31.6$ (sec)
The EUT Hopping Number per Sec	1600 times/sec
Each Channel Dwell Times per Sec	$400/79CH=5.1$ (times/sec)
Each Channel Dwell Times (1)	1.64 ms (sec)
Each Channel Dwell Times on Cycle(2)	$31.6*5.1=161.16$ (times)
Dwell Times on Cycle (1) * (2)	264.3024 ms (sec)
LIMIT(msec)	$< = 400$

DH5 Mode	
Cycle Calculate	$79CH * 0.4 = 31.6$ (sec)
The EUT Hopping Number per Sec	1600 times/sec
Each Channel Dwell Times per Sec	$266.7/79CH=3.37$ (times/sec)
Each Channel Dwell Times (1)	2.88 ms (sec)
Each Channel Dwell Times on Cycle(2)	$31.6*3.37=106.492$ (times)
Dwell Times on Cycle (1) * (2)	306.69696 ms (sec)
LIMIT(msec)	$< = 400$

Note: RB=1MHz; VB=1MHz; SPAN=0MHz; Sweep Time=20msec



8.6 Test Graphs

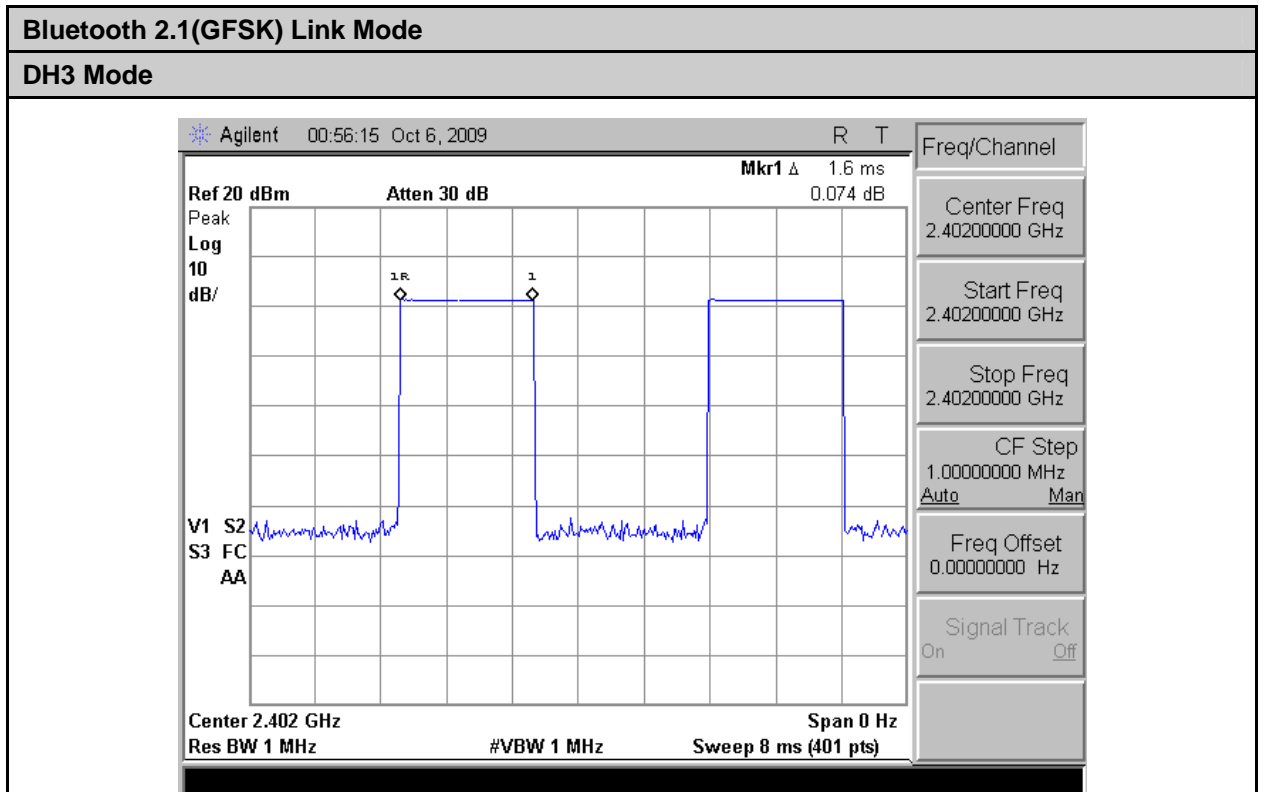
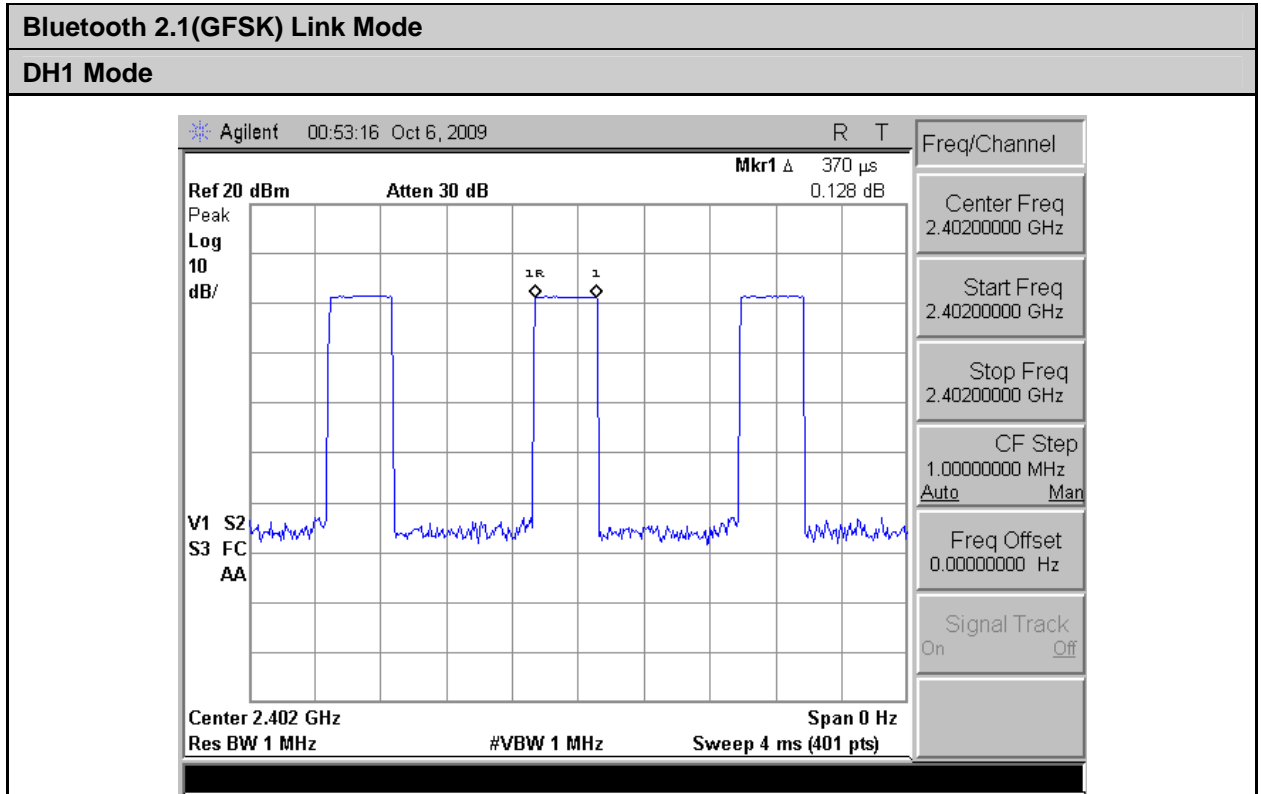



Bluetooth 2.1(GFSK) Link Mode

DH5 Mode

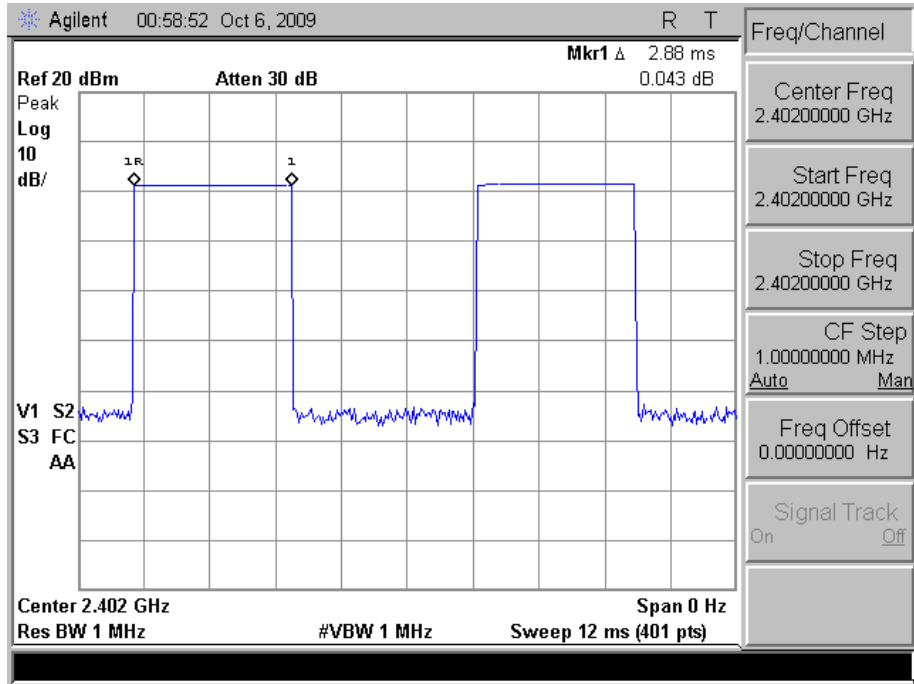



Bluetooth EDR(8DPSK) Link Mode

3DH1 Mode

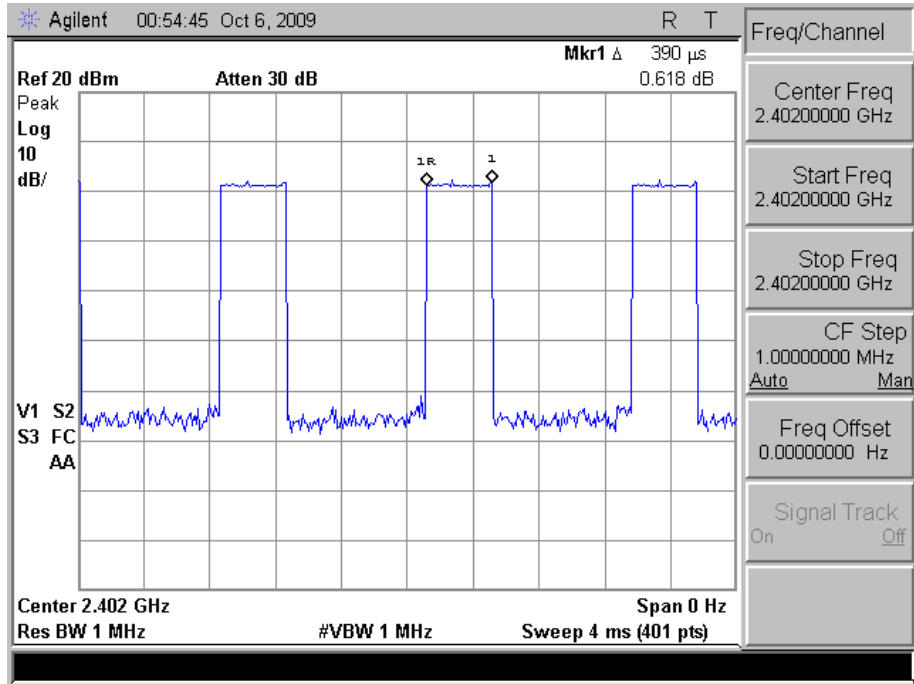

Bluetooth EDR(8DPSK) Link Mode

3DH3 Mode

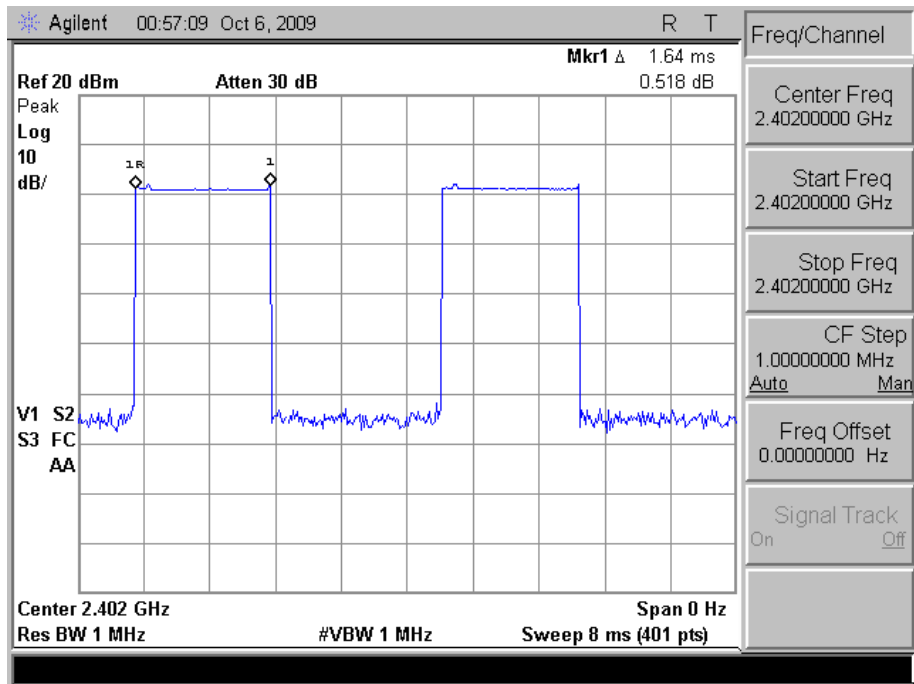



Bluetooth EDR(8DPSK) Link Mode

3DH5 Mode

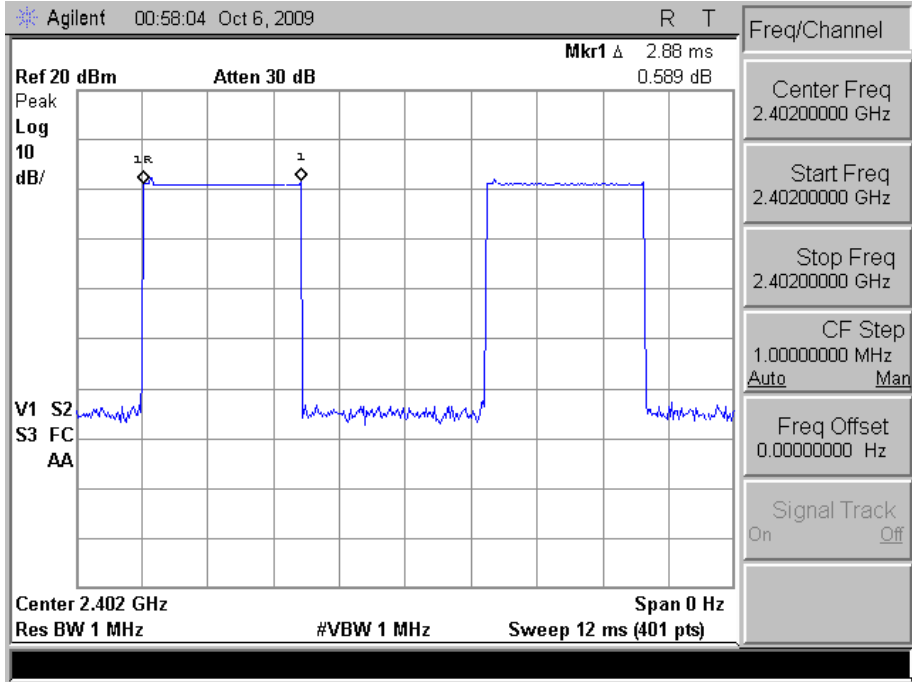

9. Out of Band Conducted Emissions Requirements

9.1 Test Procedure

In any 100 kHz bandwidth outside the EUT pass band, the RF power produced by the modulation products of the spreading sequence, the information sequence, and the carrier frequency shall be at least 20 dB below that of the maximum in-band 100 kHz emission, antenna output of the EUT was coupled directly to spectrum analyzer; if an external attenuator and/or cable was used, these losses are compensated for with the analyzer OFFSET function.

All other types of emissions from the EUT shall meet the general limits for radiated frequencies outside the pass band. The test was performed at 3 channels (Channel 0, 39, 79)

9.2 Limits

Data shows out of band emissions are suppressed well below the -20 dBc minimum required by the Rules

9.3 Test Equipment List

Describe	Manufacturer	Model	Serial Number	Calibration	
				Cal. Date	Due Date
Spectrum Analyzer	Agilent	E4445A	MY46181986	May 14, 2009	May 14, 2010

9.4 Test Instruments Configuration

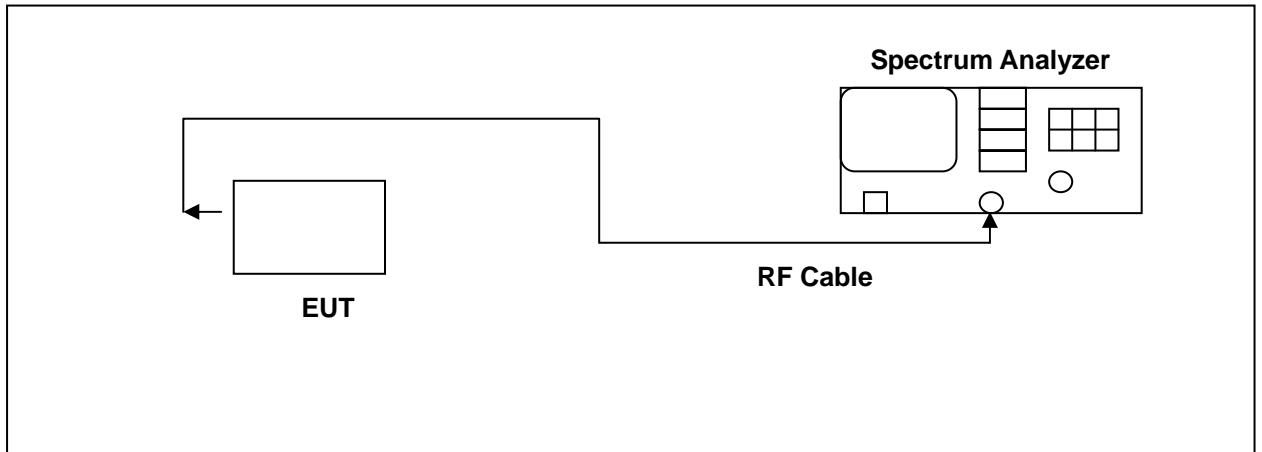



9.5 Test Result

EUT : NANO USB DONGLE

Model No. : BT 06K

Test Mode : Link Mode

Test Date : 10/06/2009

Please refer to next page of detail testing data.



File :BT 06K(BT)20dB

Data :#16

Date: 2009/10/6

Time: 上午 01:18:50

20.0 dBm

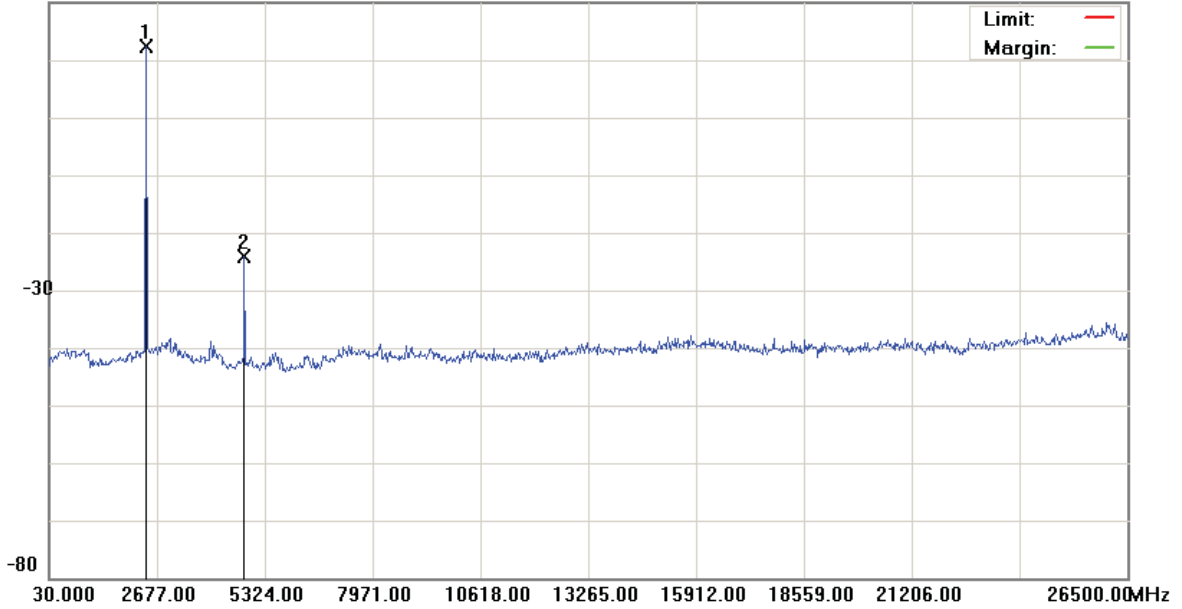

Site: site #1	Polarization:	Temperature: 22 °C
Limit:	Power:	Humidity: 60 %
EUT:	Distance:	RBW: 100 KHz VBW: 100 KHz
M/N: 09-0239-EO		
Mode: BT 2.1(GFSK)		
Note: 2402MHz		

No.	Mk.	Freq. MHz	Reading Level dBm	Correct Factor dB	Measure- ment dBm	Limit dBm	Over dB	Antenna Height cm	Table Degree degree	Detector	Comment
1	*	2402.000	6.27	6.09	12.36					peak	
2		4800.000	-30.25	6.18	-24.07					peak	

*:Maximum data x:Over limit !:over margin



File :BT 06K(BT)20dB

Data :#17

Date: 2009/10/6

Time: 上午 01:20:31

20.0 dBm

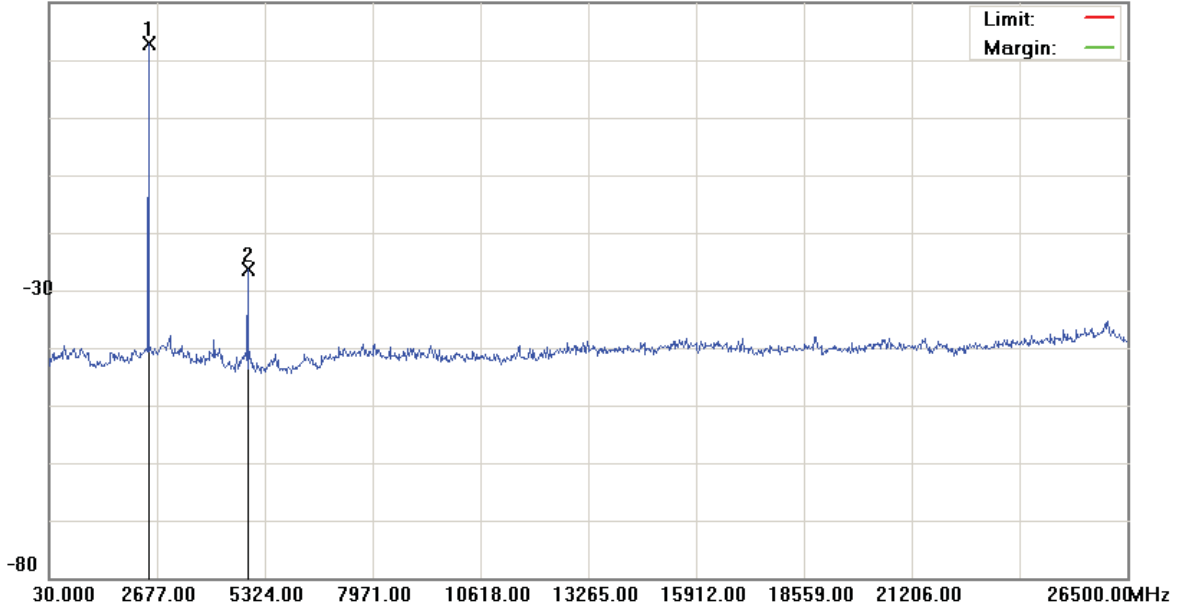

Site: site #1	Polarization:	Temperature: 22 °C
Limit:	Power:	Humidity: 60 %
EUT:	Distance:	RBW: 100 KHz VBW: 100 KHz
M/N: 09-0239-EO		
Mode: BT 2.1(GFSK)		
Note: 2441MHz		

No.	Mk.	Freq. MHz	Reading Level dBm	Correct Factor dB	Measure- ment dBm	Limit dBm	Over dB	Antenna Height cm	Table Degree degree	Detector	Comment
1	*	2441.000	6.86	6.09	12.95					peak	
2		4880.000	-32.44	6.18	-26.26					peak	

*:Maximum data x:Over limit !:over margin



File :BT 06K(BT)20dB

Data :#18

Date: 2009/10/6

Time: 上午 01:22:04

20.0 dBm

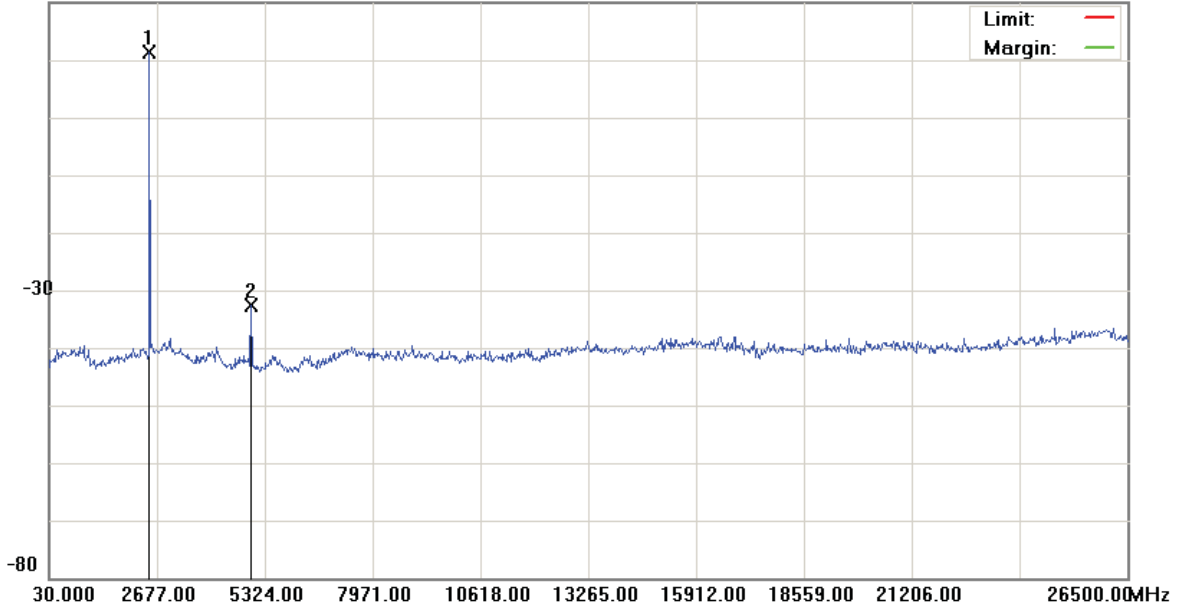

Site: site #1	Polarization:	Temperature: 22 °C
Limit:	Power:	Humidity: 60 %
EUT:	Distance:	RBW: 100 KHz VBW: 100 KHz
M/N: 09-0239-EO		
Mode: BT 2.1(GFSK)		
Note: 2480MHz		

No.	Mk.	Freq. MHz	Reading Level dBm	Correct Factor dB	Measure- ment dBm	Limit dBm	Over dB	Antenna Height cm	Table Degree degree	Detector	Comment
1	*	2480.000	5.21	6.09	11.30					peak	
2		4960.000	-38.85	6.19	-32.66					peak	

*:Maximum data x:Over limit !:over margin



File :BT 06K(BT+EDR)20dB

Data :#16

Date: 2009/10/6

Time: 上午 01:23:48

20.0 dBm

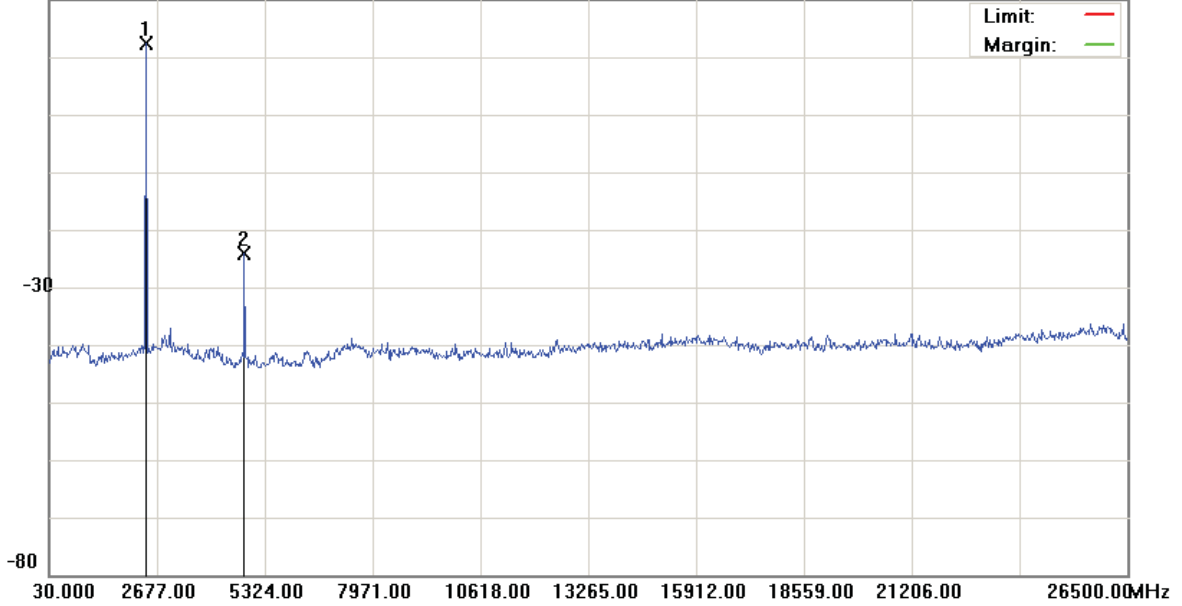

Site: site #1	Polarization:	Temperature: 22 °C
Limit:	Power:	Humidity: 60 %
EUT:	Distance:	RBW: 100 KHz VBW: 100 KHz
M/N: 09-0239-EO		
Mode: BT EDR(8DPSK)		
Note: 2402MHz		

No.	Mk.	Freq. MHz	Reading Level dBm	Correct Factor dB	Measure- ment dBm	Limit dBm	Over dB	Antenna Height cm	Table Degree degree	Detector	Comment
1	*	2402.000	6.32	6.09	12.41					peak	
2		4800.000	-30.31	6.18	-24.13					peak	

*:Maximum data x:Over limit !:over margin



File :BT 06K(BT+EDR)20dB

Data :#17

Date: 2009/10/6

Time: 上午 01:25:15

20.0 dBm

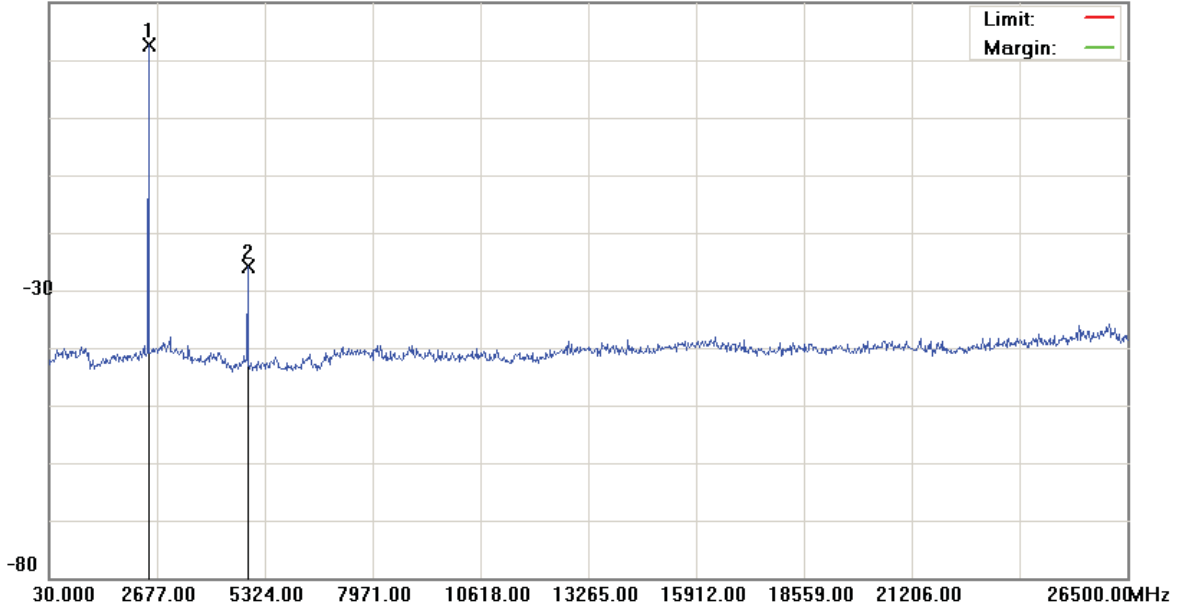

Site: site #1	Polarization:	Temperature: 22 °C
Limit:	Power:	Humidity: 60 %
EUT:	Distance:	RBW: 100 KHz VBW: 100 KHz
M/N: 09-0239-EO		
Mode: BT EDR(8DPSK)		
Note: 2441MHz		

No.	Mk.	Freq. MHz	Reading Level dBm	Correct Factor dB	Measure- ment dBm	Limit dBm	Over dB	Antenna Height cm	Table Degree degree	Detector	Comment
1	*	2441.000	6.63	6.09	12.72					peak	
2		4880.000	-32.17	6.18	-25.99					peak	

*:Maximum data x:Over limit !:over margin



File :BT 06K(BT+EDR)20dB

Data :#18

Date: 2009/10/6

Time: 上午 01:26:37

20.0 dBm

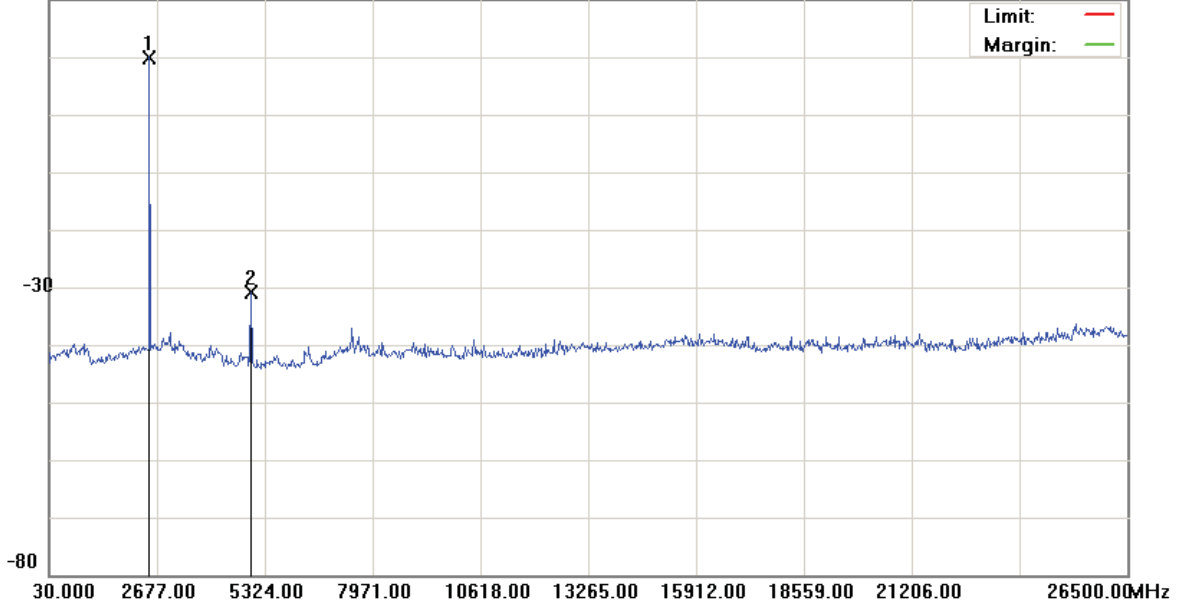

Site: site #1	Polarization:	Temperature: 22 °C
Limit:	Power:	Humidity: 60 %
EUT:	Distance:	RBW: 100 KHz VBW: 100 KHz
M/N: 09-0239-EO		
Mode: BT EDR(8DPSK)		
Note: 2480MHz		

No.	Mk.	Freq. MHz	Reading Level dBm	Correct Factor dB	Measure- ment dBm	Limit dBm	Over dB	Antenna Height cm	Table Degree degree	Detector	Comment
1	*	2480.000	3.91	6.09	10.00					peak	
2		4960.000	-37.18	6.19	-30.99					peak	

*:Maximum data x:Over limit !:over margin



10. Band Edges Requirements

10.1 Test Procedure

The emissions on the harmonics frequencies, the limits, and the margin of compliance are presented. These tests were made when the transmitter was in full radiated power. The additional test was performed to show compliance with the requirement at the band-edge frequency 2483.5 MHz and up to 2500 MHz and at 2390.0 MHz.

The transmitter was configured with the worst case antenna and setup to transmit at the highest channel. Then the field strength was measured at 2483.5 MHz.

The transmitter was then configured with the worst case antenna and setup to transmit at the lowest channel. Then the field strength was measured at 2390.0 MHz. These tests were performed at 4 different bit rates.

10.2 Limits

In any 100 kHz bandwidth outside the intentional radiation frequency band, the radio frequency power shall be at least 20 dB below the highest level of the radiated power. In addition, radiated emissions which fall in the restricted bands must also comply with the radiated emission limits.

10.3 Test Equipment List

Describe	Manufacturer	Model	Serial Number	Calibration	
				Cal. Date	Due Date
Spectrum Analyzer	Agilent	E4408B	MY45107753	Jun. 23, 2009	Jun. 23, 2010
Pre Amplifier	Agilent	8449B	3008A02456	Feb. 19, 2009	Feb. 19, 2010
Horn Antenna	SCHWARZBECK MESS-ELEKTRONIK	BBHA9120D	9120D-550	Jul. 01, 2009	Jul. 01, 2010

10.4 Test Instruments Configuration

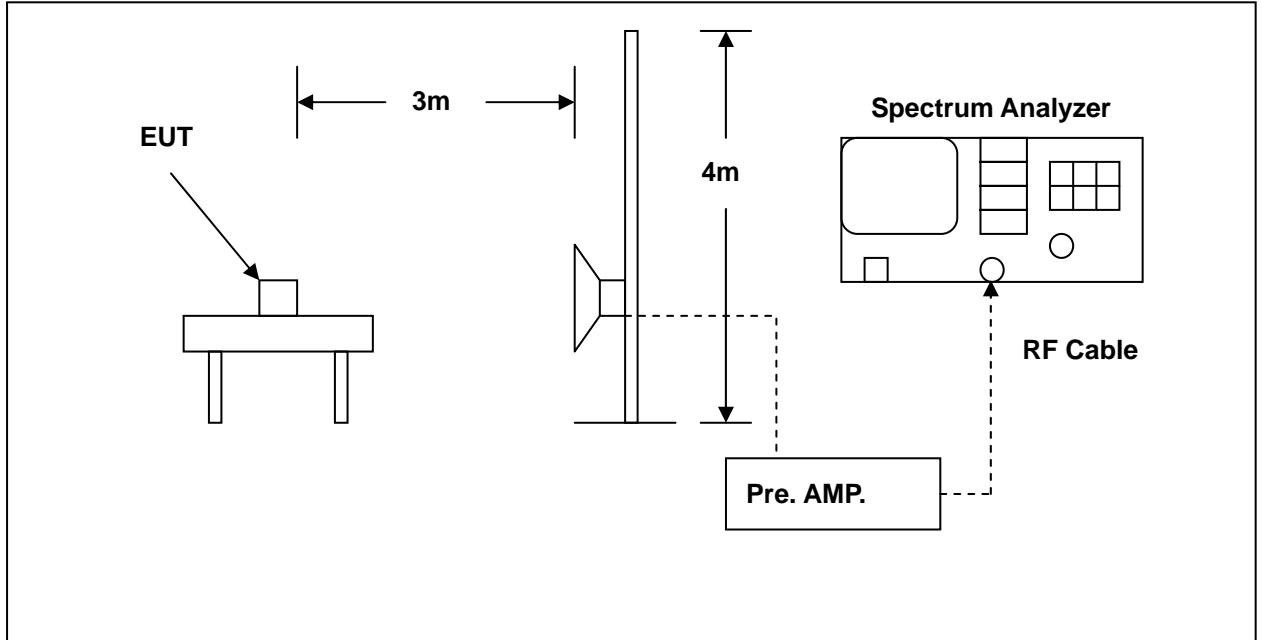

10.5 Test Result

EUT : NANO USB DONGLE

Model No. : BT 06K

Test Mode : Link Mode

Test Date : 10/05/2009

Please refer to next page of detail testing data.

Notes:

1. Margin= Amplitude - Limits
2. Height of table for EUT placed: 0.8 Meter.
3. ANT= Antenna height.
4. Duty= Duty cycle correction factor.
5. Dis= Distance extrapolation factor.
6. Amplitude= Reading Amplitude – Amplifier gain + Cable loss + Antenna factor
(Auto calculate in spectrum analyzer)
7. Actual Amp= Amplitude – Duty – Dis.



File :BT 06K(BAND EDGE)

Data :#1

Date: 2009/10/5

Time: 下午 06:20:04

112.0 dBuV

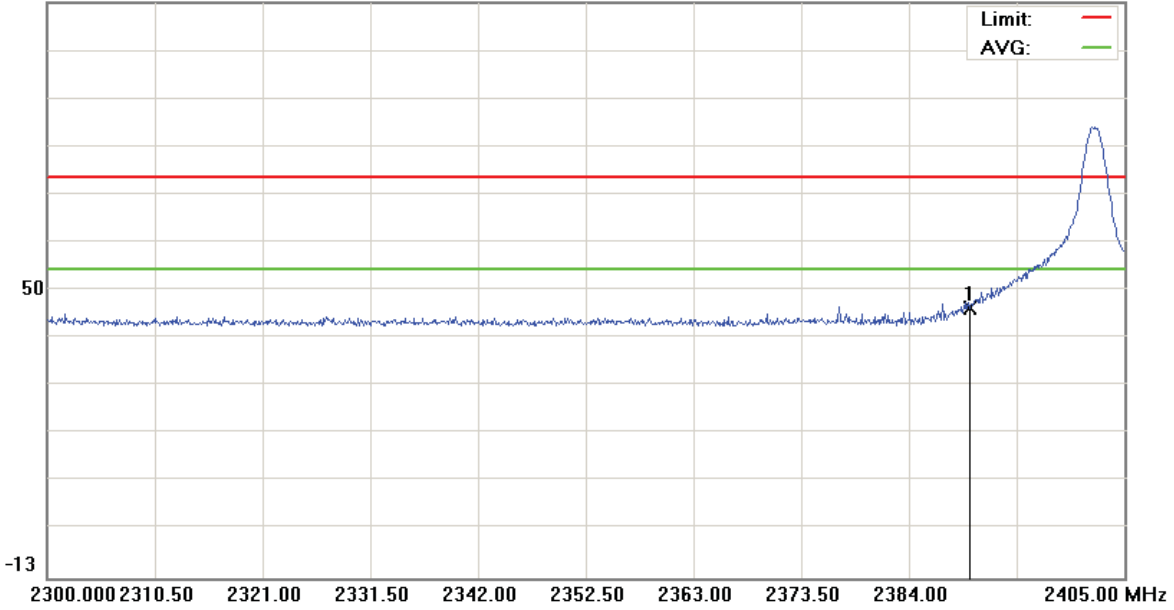

Site: site #1	Polarization: <i>Vertical</i>	Temperature: 22 °C
Limit: FCC part 15 (PK)	Power:	Humidity: 60 %
EUT:	Distance: 3m	RB:1M
M/N: 09-0239-EO		VB:1M
Mode: BT 2.1(GFSK)		
Note: 2402MHz · Antenna100cm		

No.	Mk.	Freq. MHz	Reading Level dBuV	Correct Factor dB	Measure- ment dBuV	Limit dBuV	Over dB	Antenna Height cm	Table Degree degree	Comment
1	*	2389.800	45.40	0.19	45.59	74.00	-28.41	peak		

*:Maximum data x:Over limit !:over margin



File :BT 06K(BAND EDGE)

Data :#5

Date: 2009/10/5

Time: 下午 06:34:18

112.0 dBuV

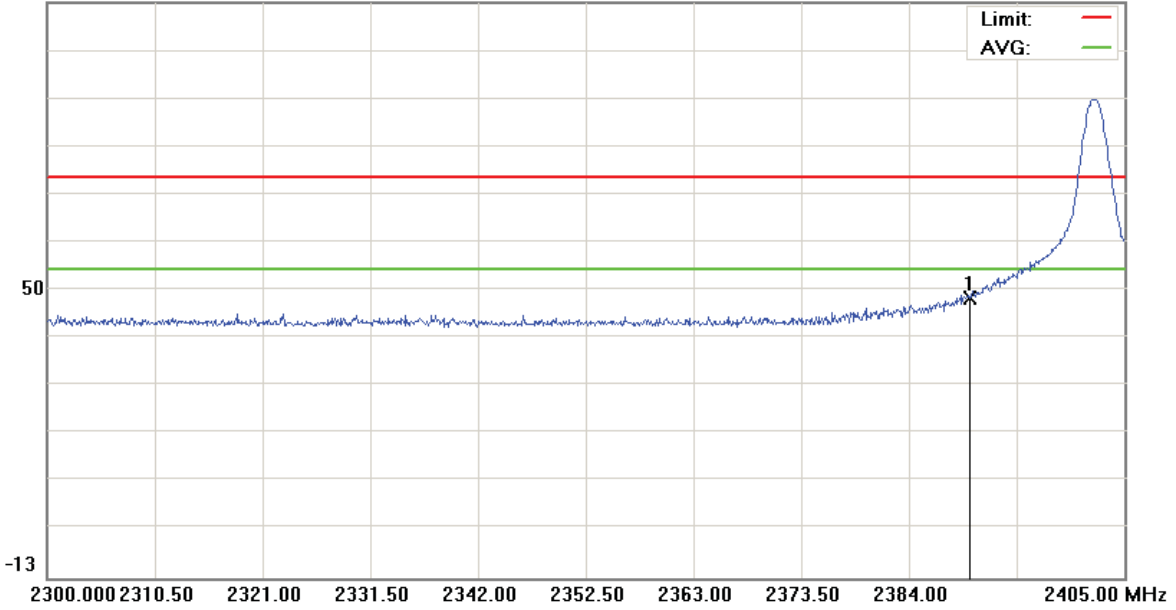

Site: site #1	Polarization: <i>Horizontal</i>	Temperature: 22 °C
Limit: FCC part 15 (PK)	Power:	Humidity: 60 %
EUT:	Distance: 3m	RB:1M
M/N: 09-0239-EO		VB:1M
Mode: BT 2.1(GFSK)		
Note: 2402MHz · Antenna100cm		

No.	Mk.	Freq. MHz	Reading Level dBuV	Correct Factor dB	Measure- ment dBuV	Limit dBuV	Over dB	Antenna Height cm	Table Degree degree	Comment
1	*	2389.800	47.72	0.19	47.91	74.00	-26.09	peak		

*:Maximum data x:Over limit !:over margin



File :BT 06K(BAND EDGE)

Data :#3

Date: 2009/10/5

Time: 下午 06:26:11

112.0 dBuV

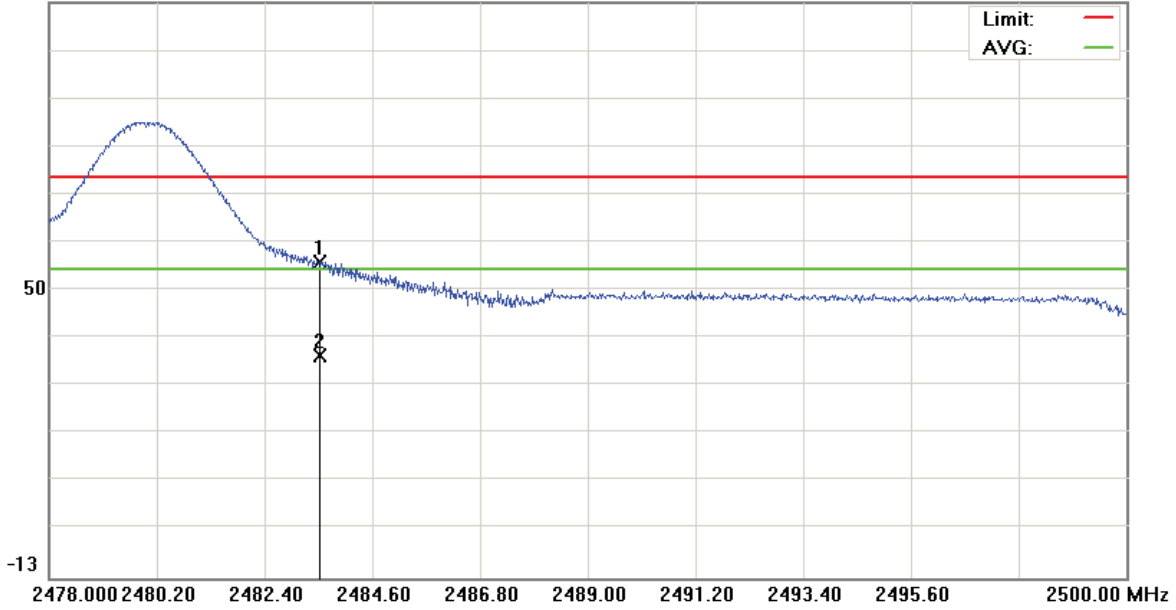

Site: site #1	Polarization: <i>Vertical</i>	Temperature: 22 °C
Limit: FCC part 15 (PK)	Power:	Humidity: 60 %
EUT:	Distance: 3m	RB:1M
M/N: 09-0239-EO		VB:1M
Mode: BT 2.1(GFSK)		
Note: 2480MHz , Antenna100cm		

No.	Mk.	Freq. MHz	Reading Level dBuV	Correct Factor dB	Measure- ment dBuV	Limit dBuV	Over dB	Detector	Antenna Height cm	Table Degree degree	Comment
1	*	2483.510	55.28	0.25	55.53	74.00	-18.47	peak			
2		2483.510	35.12	0.25	35.37	54.00	-18.63	AVG			

*:Maximum data x:Over limit !:over margin



File :BT 06K(BAND EDGE)

Data :#7

Date: 2009/10/5

Time: 下午 06:40:32

112.0 dBuV

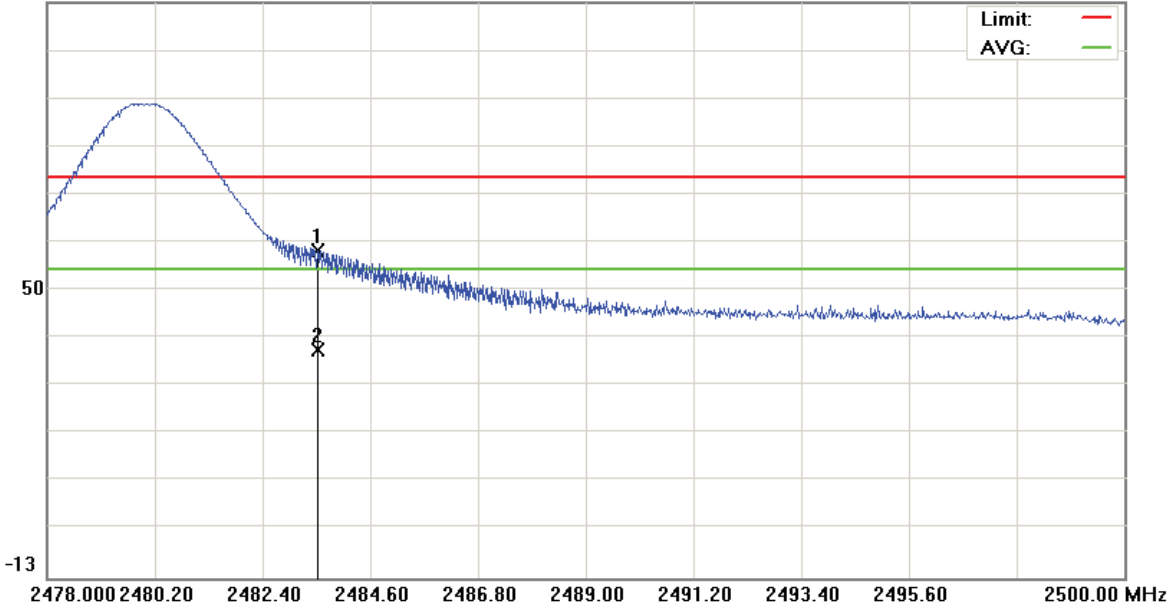

Site: site #1	Polarization: <i>Horizontal</i>	Temperature: 22 °C
Limit: FCC part 15 (PK)	Power:	Humidity: 60 %
EUT:	Distance: 3m	RB:1M
M/N: 09-0239-EO		VB:1M
Mode: BT 2.1(GFSK)		
Note: 2480MHz · Antenna100cm		

No.	Mk.	Freq. MHz	Reading Level dBuV	Correct Factor dB	Measure- ment dBuV	Limit dBuV	Over dB	Antenna Height cm	Table Degree degree	Comment
1	*	2483.510	57.87	0.25	58.12	74.00	-15.88	peak		
2		2483.510	36.20	0.25	36.45	54.00	-17.55	AVG		

*:Maximum data x:Over limit !:over margin



File :BT 06K(BAND EDGE)

Data :#1

Date: 2009/10/5

Time: 下午 06:45:51

112.0 dBuV

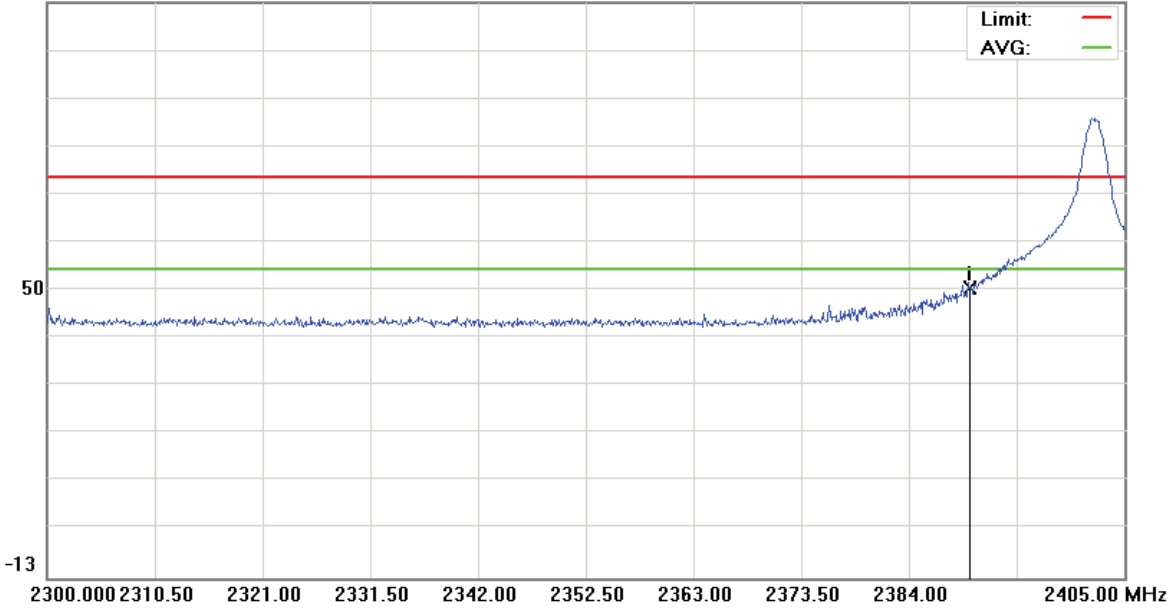

Site: site #1	Polarization: <i>Vertical</i>	Temperature: 22 °C
Limit: FCC part 15 (PK)	Power:	Humidity: 60 %
EUT:	Distance: 3m	RB:1M
M/N: 09-0239-EO		VB:1M
Mode: BT EDR (8DPSK)		
Note: 2402MHz · Antenna100cm		

No.	Mk.	Freq. MHz	Reading Level dBuV	Correct Factor dB	Measure- ment dBuV	Limit dBuV	Over dB	Antenna Height cm	Table Degree degree	Comment
1	*	2389.800	49.73	0.19	49.92	74.00	-24.08	peak		

*:Maximum data x:Over limit !:over margin



File :BT 06K(BAND EDGE)

Data :#5

Date: 2009/10/5

Time: 下午 06:55:06

112.0 dBuV

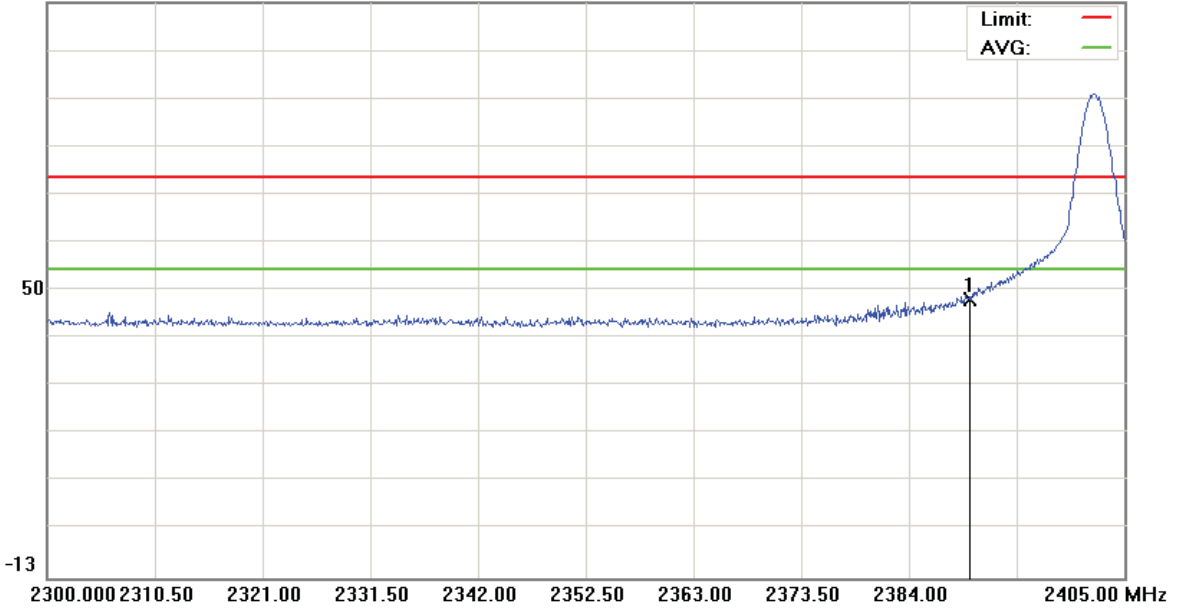

Site: site #1	Polarization: <i>Horizontal</i>	Temperature: 22 °C
Limit: FCC part 15 (PK)	Power:	Humidity: 60 %
EUT:	Distance: 3m	RB:1M
M/N: 09-0239-EO		VB:1M
Mode: BT EDR (8DPSK)		
Note: 2402MHz · Antenna100cm		

No.	Mk.	Freq. MHz	Reading Level dBuV	Correct Factor dB	Measure- ment dBuV	Limit dBuV	Over dB	Antenna Height cm	Table Degree degree	Comment
1	*	2389.800	47.40	0.19	47.59	74.00	-26.41	peak		

*:Maximum data x:Over limit !:over margin



File :BT 06K(BAND EDGE)

Data :#3

Date: 2009/10/5

Time: 下午 06:49:10

112.0 dBuV

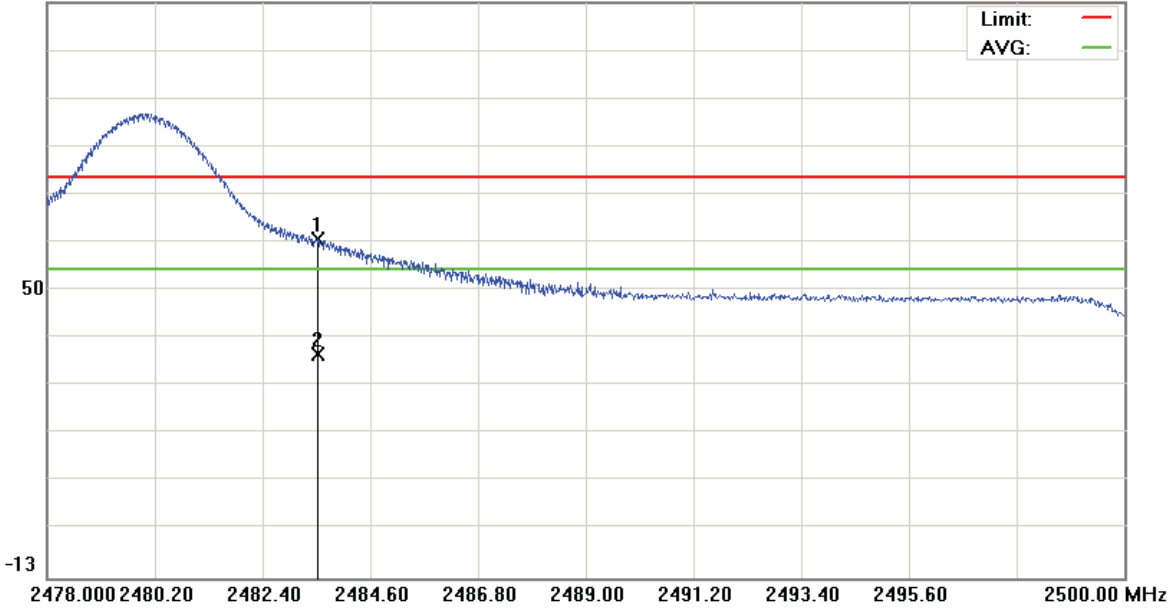

Site: site #1	Polarization: <i>Vertical</i>	Temperature: 22 °C
Limit: FCC part 15 (PK)	Power:	Humidity: 60 %
EUT:	Distance: 3m	RB:1M
M/N: 09-0239-EO		VB:1M
Mode: BT EDR (8DPSK)		
Note: 2480MHz , Antenna100cm		

No.	Mk.	Freq. MHz	Reading Level dBuV	Correct Factor dB	Measure- ment dBuV	Limit dBuV	Over dB	Antenna Height cm	Table Degree degree	Comment
1	*	2483.510	60.40	0.25	60.65	74.00	-13.35	peak		
2		2483.510	35.34	0.25	35.59	54.00	-18.41	AVG		

*:Maximum data x:Over limit !:over margin



File :BT 06K(BAND EDGE)

Data :#7

Date: 2009/10/5

Time: 下午 06:58:29

112.0 dBuV

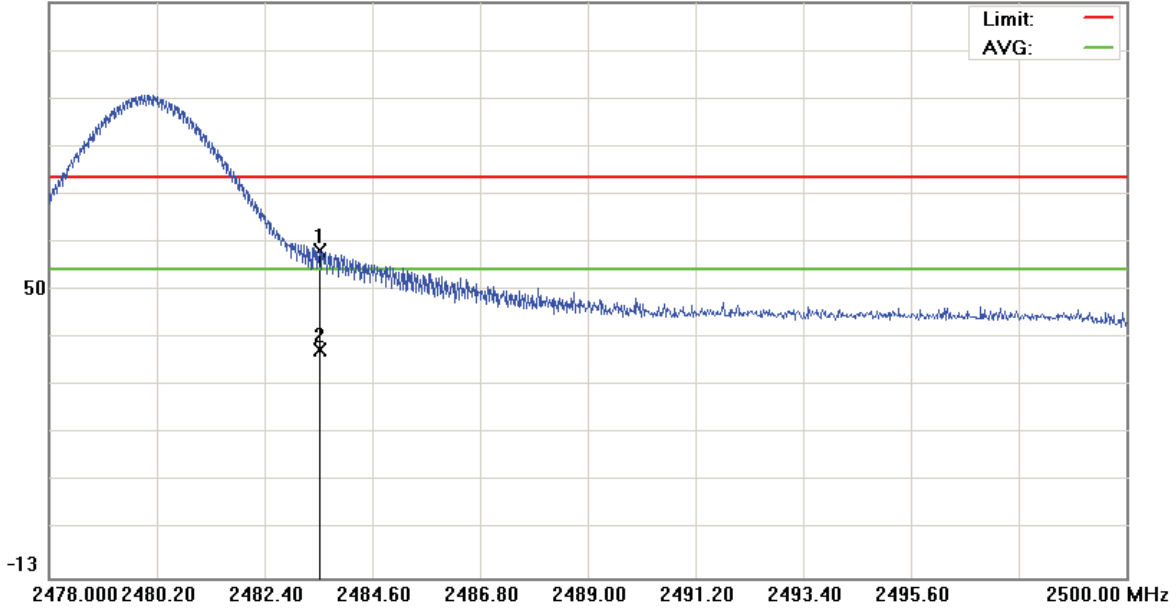

Site: site #1	Polarization: <i>Horizontal</i>	Temperature: 22 °C
Limit: FCC part 15 (PK)	Power:	Humidity: 60 %
EUT:	Distance: 3m	RB:1M
M/N: 09-0239-EO		VB:1M
Mode: BT EDR (8DPSK)		
Note: 2480MHz , Antenna100cm		

No.	Mk.	Freq. MHz	Reading Level dBuV	Correct Factor dB	Measure- ment dBuV	Limit dBuV	Over dB	Antenna Height cm	Table Degree degree	Comment
1	*	2483.510	57.90	0.25	58.15	74.00	-15.85	peak		
2		2483.510	36.16	0.25	36.41	54.00	-17.59	AVG		

*:Maximum data x:Over limit !:over margin



11. Antenna Requirements

11.1 Standard Applicable

For intentional device, according to 15.203, an intentional radiator shall be designed to ensure that no antenna other than that furnished by the responsible party shall be used with the device.

And According to 15.247 (b), if transmitting antennas of directional gain greater than 6 dBi are used, the power shall be reduced by the amount in dB that the directional gain of the antenna exceeds 6dBi.

11.2 Antenna Connector Construction

The antenna used in this product is **Internal Antenna**. And the maximum Gain of this antenna is only **2** dBi.