

NORA-W30 series

Stand-alone dual-band Wi-Fi and Bluetooth modules System integration manual



Abstract

This manual provides a functional overview combined with best-practice design guidelines for integrating NORA-W30 series stand-alone, dual-band Wi-Fi and Bluetooth Low Energy modules in customer applications. It also describes open CPU application development solutions using the Realtek SDK. The multi-radio modules are ultra-compact, cost-efficient, and designed in the NORA form factor for a wide range of industrial applications. The module series also includes variants with or without an internal antenna.

Document information

Title	NORA-W30 series	
Subtitle	Stand-alone dual-band Wi-Fi and Bluetooth modules	
Document type	System integration manual	
Document number	UBX-22021119	
Revision and date	R07_cert	20-May-2024
Disclosure restriction	C1-Public	

Product status	Corresponding content status	
Functional sample	Draft	For functional testing. Revised and supplementary data will be published later.
In development / Prototype	Objective specification	Target values. Revised and supplementary data will be published later.
Engineering sample	Advance information	Data based on early testing. Revised and supplementary data will be published later.
Initial production	Early production information	Data from product verification. Revised and supplementary data may be published later.
Mass production / End of life	Production information	Document contains the final product specification.

This document applies to the following products:

Product name	Document status	Comment
NORA-W300	Early production information	
NORA-W301	Early production information	
NORA-W306	Early production information	

 For information about the related hardware, software, and status of listed product types, refer to the data sheet [\[2\]](#).

u-blox or third parties may hold intellectual property rights in the products, names, logos, and designs included in this document. Copying, reproduction, or modification of this document or any part thereof is only permitted with the express written permission of u-blox. Disclosure to third parties is permitted for clearly public documents only. The information contained herein is provided "as is" and u-blox assumes no liability for its use. No warranty, either express or implied, is given, including but not limited to, with respect to the accuracy, correctness, reliability, and fitness for a particular purpose of the information. This document may be revised by u-blox at any time without notice. For the most recent documents, visit www.u-blox.com.
Copyright © u-blox AG.

Contents

Document information	2
Contents	3
1 Module overview	7
1.1 Module architecture.....	7
1.1.1 Block diagram.....	7
2 Module integration	8
2.1 CPU and memory.....	8
2.2 Power management.....	8
2.2.1 System supply (VDD) and digital I/O reference.....	8
2.2.2 Power supply configuration.....	8
2.2.3 VDD application circuits.....	8
2.3 Module reset.....	9
2.4 Power saving modes.....	9
2.4.1 Power on.....	9
2.4.2 Tickless.....	9
2.4.3 Sleep.....	9
2.4.4 Deep sleep.....	9
2.4.5 nRESET pin.....	10
2.5 Bootstrap pins.....	10
2.6 Peripheral assignments.....	10
2.7 Pin multiplexing.....	11
2.8 Real-time clock.....	12
2.8.1 External low-frequency clock source.....	12
2.9 Antenna integration.....	13
2.9.1 External antenna interface.....	13
2.9.2 Internal antenna.....	13
2.10 Data interfaces.....	13
2.10.1 Universal Asynchronous Receiver Transmitter (UART).....	14
2.10.2 Serial Peripheral Interface (SPI).....	14
2.10.3 Inter-IC (I2C) interface.....	14
2.10.4 Inter-IC Sound (I2S).....	14
2.10.5 Universal Serial Interface (USI).....	15
2.11 Digital interfaces.....	15
2.11.1 Pulse Width Modulation (PWM).....	15
2.11.2 Key-scan.....	15
2.11.3 Quadrature Decoder (Q-Decoder or QDEC).....	15
2.12 Analog.....	15
2.13 Debug.....	15
2.14 No-connect pins (n/c).....	15
2.15 Ground (GND) pins.....	15

3	Design-in	16
3.1	Overview	16
3.2	Antenna interface	16
3.2.1	RF transmission line design (NORA-W301)	17
3.2.2	Antenna design (NORA-W301)	18
3.2.3	NORA-W301 U.FL reference design	21
3.2.4	On-board antenna design (NORA-W306)	22
3.3	Data communication interfaces	23
3.3.1	Asynchronous serial interface (UART) design	23
3.4	General high-speed layout guidelines	23
3.4.1	Considerations for schematic design and PCB floor-planning	23
3.4.2	Component placement	24
3.4.3	Layout and manufacturing	24
3.5	Module footprint and paste mask	25
3.6	Thermal guidelines	25
3.7	ESD guidelines	25
3.8	Design-in checklists	27
3.8.1	Schematic checklist	27
3.8.2	Layout checklist	27
4	Open CPU software	28
4.1	Realtek SDK	28
4.1.1	Standard SDK	28
4.1.3	Arduino IDE	28
4.1.4	Matter support	28
4.1.5	Flashing open CPU software	29
4.2	Wi-Fi MAC and Bluetooth device addresses and calibration data	30
4.3	Set regulatory domain channel plan	30
4.4	Output power limit configuration	30
5	Handling and soldering	31
5.1	ESD handling precautions	31
5.2	Packaging, shipping, storage, and moisture preconditioning	31
5.3	Reflow soldering process	32
5.3.1	Cleaning	33
5.3.2	Other notes	33
6	Regulatory compliance	34
6.1	General requirements	34
6.2	European Union regulatory compliance (pending)	36
6.2.1	CE end-product regulatory compliance	36
6.2.2	Compliance with the RoHS directive	37
6.3	Great Britain regulatory compliance (pending)	37
6.3.1	UK Conformity Assessed (UKCA)	37
6.4	FCC/ISED End-product regulatory compliance (pending)	37

6.4.1	United States compliance statement (FCC).....	39
6.4.2	Canada compliance statement (ISED)	39
6.4.3	Referring to the u-blox FCC/ISED certification ID	40
6.4.4	Obtaining own FCC/ISED certification ID	41
6.4.5	Antenna requirements	41
6.4.6	Software configuration and control.....	42
6.4.7	Operating frequencies	43
6.4.8	End product labeling requirements	43
6.5	Japan radio equipment compliance (pending)	45
6.5.1	Compliance statement	45
6.5.2	End product labelling requirement.....	45
6.5.3	End product user manual requirement	45
6.6	KCC South Korea compliance (pending)	45
6.7	NCC Taiwan compliance	46
6.7.1	Taiwan NCC warning statement	46
6.7.2	Labeling requirements for end product	46
6.8	Brazil compliance (pending)	47
6.9	Australia and New Zealand regulatory compliance (pending)	47
6.10	South Africa regulatory compliance (pending)	48
6.11	Approved antennas	49
6.11.1	Antenna accessories.....	49
6.11.2	Pre-approved antenna list.....	49
7	Product testing	51
7.1	u-blox in-line production test.....	51
7.2	OEM manufacturer production test	52
7.2.1	“Go/No go” tests for integrated devices	52
	Appendix	53
A	Wi-Fi transmit output power limits.....	53
A.1	FCC / ISED regulatory domain	53
A.1.1	Wi-Fi output power for 2.4 GHz band	53
A.1.2	FCC Wi-Fi output power for 5 GHz band	53
A.1.3	ISED Wi-Fi output power for 5 GHz band.....	54
A.1.4	FCC Wi-Fi output power for 5 GHz band	54
A.1.5	FCC Wi-Fi output power for 5 GHz band	55
A.2	RED and UKCA regulatory domains	56
A.2.1	Wi-Fi output power for 2.4 GHz band	56
A.2.2	Wi-Fi output power for 5 GHz band.....	56
B	Reference trace design (NORA-W3x1 only).....	57
B.1	Floor plan	58
B.2	RF trace specification and PCB stack-up	59
B.2.1	Ground stitching vias	59
B.2.2	Keep out areas.....	59

B.2.3 Component placement62

C Glossary 63

Related documentation 65

Revision history 66

Contact..... 66

1 Module overview

NORA-W30 series are small, stand-alone dual-band Wi-Fi and Bluetooth Low Energy microcontroller unit (MCU) modules, perfect for integrating wireless connectivity in end products.

With Wi-Fi 4 (802.11a/b/g/n) in the 2.4 and 5 GHz bands it can be a Wi-Fi station connecting to a remote access point or act as an access point. NORA-W30 is Bluetooth 5.3 qualified and can assume peripheral or central roles, or both simultaneously. It can be a GATT client or server.

The module embeds a dual-core MCU with a powerful Arm Cortex-M33 compatible processor for the main application and an Arm Cortex-M23 compatible core for low power operation.

The NORA-W30 series include hardware security features like secure boot, trusted execution environment with Arm TrustZone™, encrypted flash, protection of debug port, and a crypto acceleration engine. Wireless communication is secure with WPA2/WPA3 authentication, TLS 1.2/1.3 encryption, Bluetooth LE secure connection pairing, and HTTPS.

NORA-W30 modules have the same size and position of critical pads and interfaces as other NORA modules. This offers maximum flexibility for the development of similar end-devices with different radio technologies. The modules support operation in an extended temperature range of -40°C to $+105^{\circ}\text{C}$ and are qualified for professional grade applications.

1.1 Module architecture

NORA-W30 series modules are based on the Realtek RTL8720DF chip. Module variants allow developers to select either an external antenna with NORA-W301 or an on-module antenna with NORA-W306.

These compact modules include the MCU, flash memory, crystal, and other components for matching, filtering, antenna, decoupling, and antenna operation.

The two variants of NORA-W30 series are described in [Table 1](#).

Variant / Ordering code	Antenna configuration	Antenna type
NORA-W300-00B	U.FL: 2.4 GHz / 5 GHz Wi-Fi, 2.4 GHz Bluetooth LE	U.FL connector
NORA-W301-00B	RF_ANT0: 2.4 GHz / 5 GHz Wi-Fi, 2.4 GHz Bluetooth LE	Antenna pad
NORA-W306-00B	Combined 2.4 GHz / 5 GHz Wi-Fi, 2.4 GHz Bluetooth LE	Single embedded PCB antenna

Table 1: Supported configurations of the NORA-W30 series

1.1.1 Block diagram

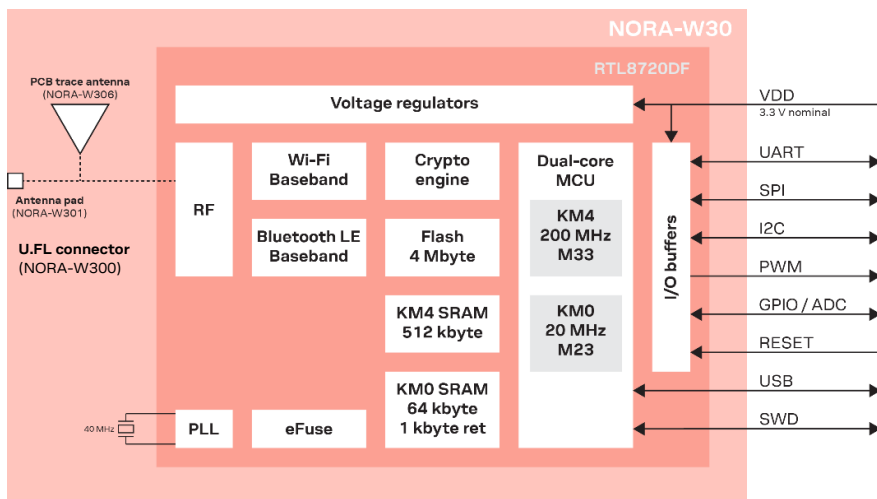

Figure 1: NORA-W30 series block diagram

2 Module integration

2.1 CPU and memory

NORA-W30 series modules embed a dual-core MCU with a powerful Arm Cortex-M33 compatible processor for the main application (KM4 core) and an Arm Cortex-M23 compatible core for low power operation (KM0 core). The open CPU architecture allows custom, advanced applications running on the CPU.

The NORA-W30 architecture includes the following memories:

- RAM – main core: 512 kB
- RAM – low-power core: 64 kB
- Flash – accessible to both cores: 4 MB
- 512-byte eFuse (non-erasable memory) for MAC addresses, Wi-Fi calibration, module configuration, flash encryption, and chip ID

2.2 Power management

2.2.1 System supply (VDD) and digital I/O reference

NORA-W30 series have a single power supply input – **VDD** – which is also the I/O voltage reference. Nominal voltage is 3.3 VDC \pm 10%.

2.2.2 Power supply configuration

The RTL8720DF within NORA-W30 series can be configured for operating the MCU cores in switch mode power supply (SMPS, or SPS) or low drop-out (LDO) linear mode. Default is SPS. LDO may be selected by changing the strapping, though is not recommended for normal operation. See also [Bootstrap pins](#).

2.2.3 VDD application circuits

The power for NORA-W30 series modules is applied through the **VDD** pins. These supplies are taken from either of the following sources:

- Switch Mode Power Supply (SMPS)
- Low dropout linear regulator (LDO)

An SMPS is the ideal design choice when the available primary supply source is significantly higher than the operating supply voltage of the module. This offers the best power efficiency for the application design and minimizes the amount of current drawn from the main supply source.

 When taking **VDD** supplies from an SMPS make sure that the AC ripple voltage is kept as low as possible at the switching frequency. Design layouts should focus on minimizing the impact of any high-frequency ringing.

Use an LDO linear regulator for primary VDD supplies that have a relatively low voltage. As LDO regulators dissipate power linearly related to the step-down voltage, LDOs are not recommended for step down of high voltages.

DC-DC efficiency should be regarded as a trade-off between the active and idle duty cycles of an application. Although some DC-DC devices achieve high efficiency at light loads, these efficiencies typically degrade as soon as the idle current drops below a few milliamps. This can have a negative impact on the life of a battery.

If decoupling capacitors are needed on the supply rails, it is best practice to position these as close as possible to the NORA-W30 series module. The power routing of some host system designs makes decoupling capacitance unnecessary.

For electrical specifications, see also the appropriate NORA-W30 series data sheet [2].

2.3 Module reset

NORA-W30 series modules can be reset (rebooted) with a low-level input on the **nRESET** pin. The logic level of this pin is normally set high using an internal pull-up resistor. The low-level input triggers a “hardware reset” of the module. The **nRESET** signal should be driven by an open drain, open collector, or contact switch. The chip works at the minimum power when **nRESET** is low (off). **Table 2** shows the reset pin characteristics.

2.4 Power saving modes

NORA-W30 series modules are power efficient devices capable of operating in different power saving modes and configurations. Different sections of the module can be powered off when they are not needed, and complex wake up events can be generated from different external and internal inputs.

For more information about power modes, see the Realtek RTL8720DF data sheet [3] and application note [5].

2.4.1 Power on

This is the normal operating mode when running applications.

2.4.2 Tickless

Tickless is a FreeRTOS™ low-power feature which halts the CPU when no task is scheduled.

2.4.3 Sleep

The dual-core design of KM0 and KM4 is largely for saving power. KM4 is used for the main application while KM0 is used for power-save, Wi-Fi firmware, and power/clock control. There are two sleep modes, clock-gating (CG) and power-gating (PG). CG will disable the generation or routing of certain clocks. PG will turn off select power domains of the NORA-W30 module. All RAM is retained.

2.4.3.1 Wake sources from sleep

NORA-W30 can be awakened from sleep mode by the following sources:

- Analog comparator or ADC
- Low-power I2C address match (I2C slave mode only)
- Low-power or high-speed UART activity
- Brown-out detector
- Wi-Fi beacon interval
- GPIO input
- Timers

2.4.4 Deep sleep

Deep sleep mode enables power only to the AON power domain (deep sleep wake sources). MCU clocks are turned off. Real-time clock (RTC) is on. 1 kB of RAM is retained.

See also [Real-time clock](#).

2.4.4.1 Wake sources from deep sleep

NORA-W30 can be awakened from deep sleep mode by the following sources:

- Power-down event
- Real-time clock
- Key press
- Low-power timers
- GPIO input

2.4.5 nRESET pin

Pin name	Parameter	Min	Typ	Max	Unit
nRESET	Low-level input	0		0.2*VDD	V
	Internal pull-up resistance		10		kΩ
t _{RESET}	Minimum nRESET low pulse	1	1		ms

Table 2: nRESET pin characteristics

2.5 Bootstrap pins

Several module pins related to the boot configuration can be configured as shown in [Table 3](#). Internal pull-up values are the default states for NORA-W30 on boot.

 Use of boot strap pins as I/O should be avoided if other GPIO pins can be used instead.

Pin	State during boot	Internal pull-up/down	Behavior	Description
B1 (PA30)	0		Internal regulator operates in LDO mode	Internal power selection
	1	10 kΩ pull-up	Internal regulator operates in SPS mode	
H2 (SWD_DATA)	0		Boot to test mode	Test Mode
	1	50 kΩ pull-up	Normal boot	
A5 (PA7)	0		Bootloader – download image from UART	Bootling Mode
	1	50 kΩ pull-up	Boot from internal flash	

Table 3: NORA-W30 series boot strap pins

2.6 Peripheral assignments

Peripheral assignments are performed through the e-fuse and application loaded onto the module. When a pin is assigned to one function, it cannot be used for another function. For functions not selected through the eFuse, changing assignments on-the-fly is available. Assignments cannot conflict with other existing assignments (e.g., **LP_UART** and **LP_I2C** can use the same pins. Both functions cannot be active at the same time unless the **LP_UART** is assigned to an alternate set of pins.)

Pin assignments and function descriptions are defined in the NORA-W30 data sheet [\[2\]](#). Only certain functions may be enabled at one time. See [Table 4](#).

2.7 Pin multiplexing

Only certain functions may be enabled at one time. [Table 4](#) describes the pin multiplexing options.

Port Name	Module pin	Module pin#	FUNC_ID0	FUNC_ID1	FUNC_ID2	FUNC_ID3	FUNC_ID4	FUNC_ID5	FUNC_ID6	FUNC_ID7	FUNC_ID8	FUNC_ID9	FUNC_ID10	FUNC_ID11	FUNC_ID12	FUNC_ID14	FUNC_ID15	FUNC_ID18	FUNC_ID20	FUNC_ID21	FUNC_ID22	FUNC_ID23	FUNC_ID28	FUNC_ID29	FUNC_ID30	FUNC_ID31	default function	shutdown33 group
			gpio	UART DATA	LOG UART RTS/CTS	SPI	RTC	IR	SPI Refresh	I2C	SDIO	HS_pwm	LP_pwm	SWD	RS/DMC	USB	HEADPHONE	Wifi only AFE control	Ext. BT	Combo AFE control	HS timer trig	Debug Port	Ext32K	key scan ROW	key scan COL	WAKEUP		
PA[7]	A5	50 kΩ pull-up	PA[7]	UART_LOG_TXD	UART_LOG_RXD													ANT_SEL_P								PA[7]	5	
PA[8]	A6		PA[8]	UART_LOG_TXD	UART_LOG_RXD													ANT_SEL_N								PA[8]	5	
PA[12]	J9		PA[12]	LP_UART_TXD		SPI_MOSI						HS_PWM0	LP_PWM0	RS_MCLK				ANT_SEL_N	GRANT_BT	EN_EXLNA			KEY_ROW1	LOGPD[0]		PA[12]	2	
PA[13]	J8		PA[13]	LP_UART_RXD		SPI_MISO						HS_PWM1	LP_PWM1	RS_SD_TX1				ANT_SEL_P	GRANT_BT_J1	EN_EXPA			KEY_ROW1	LOGPD[1]		PA[13]	2	
PA[14]	H9		PA[14]	LP_UART_RTS	SPI_CLK									RS_SD_TX2				ANT_SEL_N	BT_DIS			RTC_OUT	KEY_ROW1	LOGPD[2]		PA[14]	2	
PA[15]	H8		PA[15]	LP_UART_CTS	LP_UART_RTS													BT_WAKE_UPDT				RTC_EXT_DRP	KEY_ROW1	LOGPD[3]		PA[15]	2	
PA[25]	C2		PA[25]	LP_UART_RXD		HS_USL_SPL_MOSI	IR_TX		LP_JRC_SCL			HS_PWM4	LP_PWM4			HSDM			MBOX_JRC_INT			wfmac_atbgrp[0]				PA[25]	2	
PA[26]	C1		PA[26]	LP_UART_TXD		HS_USL_SPL_MISO	IR_RX		LP_JRC_SDA			HS_PWM5	LP_PWM5			HSDP			BT_ACT			wfmac_atbgrp[1]		KEY_COL1		PA[26]	2	
PA[27]	H2	50 kΩ pull-up	PA[27]	LP_UART_RTS									SWD_DATA						WLAN_ACT			wfmac_atbgrp[2]				SWD_DATA when fuse enable	5	
PA[28]	B3		PA[28]	LP_UART_CTS		HS_USL_SPL_CS						HS_PWM6	LP_PWM6			RRF			BT_OK			wfmac_atbgrp[3]				PA[28]	5	
PA[30]	B1	10 kΩ pull-up	PA[30]			HS_USL_SPL_CLK						HS_PWM7	LP_PWM1						EXTBT_UART_RTS			wfmac_atbgrp[4]				PA[30]	5	
PB[1]	D8		PB[1]	LP_UART_TXD										DMIC_CLK				ANT_SEL_N	BT_STE	EN_EXLNA	HS_TM4_THR	wfmac_atbgrp[5]				PB[1]	5	
PB[2]	E8		PB[2]	LP_UART_RXD										SMIC_DATA				ANT_SEL_P	PCM_CLK	EN_EXPA	HS_TM5_THR	wfmac_atbgrp[6]				PB[2]	5	
PB[3]	J2		PB[3]										SWD_CLK						PCM_SYNC			wfmac_atbgrp[7]				SWD_CLK when fuse enable	5	
PB[18]	Q9		PB[18]	HS_UART0_RXD	HS_USL_UART_RTS	SPI_MOSI			SPL_CS		SD_D0	HS_PWM10	LP_PWM4	SWD_CLK													SWD_CLK when fuse enable, or SD_CS	1
PB[19]	Q8		PB[19]	HS_UART0_TXD	HS_USL_UART_CTS	SPI_MISO			SPL_DATA1		SD_D1	HS_PWM11	LP_PWM5	SWD_DATA	RS_SD_TX0												SWD_DATA when fuse enable, or SD_D3 when fuse enable, SDCI	1
PB[20]	F9		PB[20]	HS_USL_UART_TXD	HS_USL_UART_CTS	SPI_CLK			SPL_DATA0	HS_USL_JRC_SDA	SD_CMD	HS_PWM12	LP_PWM0		RS_CLK												SD_CMD when fuse enable, SDCI	1
PB[21]	F8		PB[21]	HS_USL_UART_RXD	HS_USL_UART_RTS	SPI_CS			SPL_CLK	HS_USL_JRC_SDA	SD_CLK	HS_PWM13	LP_PWM1		RS_WS		GDEC_IDR										SD_CLK when fuse enable, SDCI	1
PB[22]	E9		PB[22]				LP_TM4_THR	IR_RX	SPL_DATA3		SD_D0	HS_PWM14	LP_PWM2		RS_SD_TX1		GDEC_PHB		EXTBT_UART_CTS			wfmac_atbgrp[8]					SD_D0 when fuse enable, SDCI	1
PB[23]	C8		PB[23]				LP_TM5_THR	IR_TX	SPL_DATA2		SD_D1	HS_PWM15	LP_PWM3		RS_MCLK		GDEC_PHA		EXT_32K			wfmac_atbgrp[9]					SD_D1 when fuse enable, SDCI	1

Table 4: Pin multiplexing table

Table 5 describes the pin multiplexing for Always ON (AON) power domain – pins that can wake the module from deep sleep.

Port Name	Bootstrap	FUNC_ID0 gpio (default)	FUNC_ID28 Ext32K	FUNC_ID29 key scan row	FUNC_ID30 key scan col	FUNC_ID31 wakeup	default pull
PA[7]	UART download						UP
PA[8]							UP
PA[11]							
PA[12]	icfg0	GPIOC_LP[0]		KEY_ROW0		LGPIO[0]	
PA[13]	icfg1	GPIOC_LP[1]		KEY_ROW1		LGPIO[1]	
PA[14]	icfg2	GPIOC_LP[2]	RTC_OUT	KEY_ROW2		LGPIO[2]	
PA[15]	icfg3	GPIOC_LP[3]	RTC_EXT_32K	KEY_ROW3	KEY_COL6	LGPIO[3]	
PA[16]		GPIOC_LP[4]		KEY_ROW4	KEY_COL5	LGPIO[0]	
PA[25]		GPIOC_LP[10]			KEY_COL1	LGPIO[2]	
PA[26]		GPIOC_LP[11]			KEY_COL0	LGPIO[3]	

Table 5: AON pin multiplexing

Table 6 describes the external I2S multiplexing pins.

Symbol	Type	Pin name	Function ID	Description
I2S_MCLK	O	PB[12]	12	External I2S main clock
		PB[23]	12	
I2S_CLK	O	PB[20]	12	External I2S clock
I2S_WS	O	PB[21]	12	External I2S Word Select
I2S_SD_TX0	O	PB[19]	12	External I2S data Tx0
I2S_SD_TX1	O	PA[13]	12	External I2S data Tx1
I2S_SD_TX2	O	PA[14]	12	External I2S data Tx2
I2S_SD_RX	I	PB[22]	12	External I2S data Rx

Table 6: External I2S pin multiplexing

2.8 Real-time clock

The real-time clock (RTC) runs when NORA-W30 is powered, regardless of power mode. The RTC maintains time with seconds, minutes, hours, and days (12- or 24-hour format). Daylight saving compensation is programmable by the application. An alarm output on a GPIO may be enabled – **RTC_OUT**.

2.8.1 External low-frequency clock source

If additional power savings are required, an external low-frequency clock source – **EXT_32K** – can be provided on a GPIO pin. **EXT_32K** is a logic level input referenced to **VDD** and operates at 32.768 kHz.

2.9 Antenna integration

Antenna interfaces are different for each module variant in the NORA-W30 series. The modules support either an internal antenna (NORA-W306) or external antennas connected through a dedicated antenna pin (NORA-W301).

2.9.1 External antenna interface

The NORA-W301 module is equipped with an antenna signal (**ANT**) pin. The pin has a nominal characteristic impedance of $50\ \Omega$ and must be connected to the antenna through a $50\ \Omega$ transmission line.

The NORA-W300 module is equipped with a U.FL connector for connection to a $50\ \Omega$ transmission line.

Choose an antenna with optimal radiating characteristics for the best electrical performance and overall module functionality. An internal antenna, integrated on the application board or an external antenna connected to the application board through a proper $50\ \Omega$ connector, can be used.

When using an external antenna, the PCB-to-RF-cable transition must be implemented using either a suitable $50\ \Omega$ connector, or an RF-signal solder pad (including GND) that is optimized for $50\ \Omega$ characteristic impedance.

2.9.1.1 Antenna matching

The antenna return loss should be as low as possible across both | bands to provide optimal performance. The enclosure, shields, other components, and surrounding environment might impact the return loss that is seen at the antenna port. Matching components are often required to retune the antenna to $50\ \Omega$ characteristic impedance.

It is difficult to predict the actual matching values for the antenna in the final form factor. Therefore, it is good practice to have a placeholder in the circuit with a “pi” network, with two shunt components and a series component in the middle. This allows maximum flexibility while tuning the matching to the antenna feed.

2.9.1.2 Approved antenna designs

NORA-W301 modules come with a pre-certified design that utilizes a U.FL connector for an external antenna. The certification can be used to save costs and time during the certification process. See [Antenna interface](#) and [Reference trace design \(NORA-W3x1 only\)](#).

The designer integrating a u-blox reference design into an end-product is solely responsible for any unintentional RF emission generated by the end product.

 The module may be integrated with other antennas. In which case, the OEM installer must certify the design with respective regulatory agencies.

2.9.2 Internal antenna

NORA-W306 modules have an internal antenna that is specifically designed and optimized for u-blox Wi-Fi, and Bluetooth LE modules. With NORA-W306, host-product manufacturers only need to consider the module placement and GND clearance in antenna area.

2.10 Data interfaces

NORA-W30 modules have 20 I/O pins. The pins can be assigned to the data interfaces listed below; however, assignments cannot be in conflict. To visualize the available pin assignments for the interfaces, see [Table 4](#).

2.10.1 Universal Asynchronous Receiver Transmitter (UART)

NORA-W30 modules have up to five UART interfaces for data communication and firmware upgrade:

- HS_UART0: high-speed UART with a maximum baud rate of 6 Mbps.
- HS_USI_UART: high-speed UART with a maximum baud rate of 6 Mbps . See also [Universal Serial Interface \(USI\)](#).
- IR_UART: high-speed UART capable of transmitting and decoding modulated infrared signals compatible with the Infrared Data Association (IrDA) specification.
- LP_UART1: low-power UART with a maximum baud rate of 6 Mbps . Can wake MCU from sleep.
- LP_UART0: low power UART with a maximum baud rate of 6 Mbps . Can wake MCU from sleep. Used for firmware updates and debug logging.

Each interface provides asynchronous communication support for RS232, RS485 standards (with external drivers). Each UART supports the following signals:

- Data lines (**RXD** as input, **TXD** as output)
- Hardware flow control lines (**CTS** as input, **RTS** as output)

You can use the UARTs in 4-wire mode with hardware flow control, or in 2-wire mode with **TXD** and **RXD** only.

 2-wire mode is not recommended at higher speeds (e.g., 115.2 kbps), because it is prone to buffer overruns.

When used in infrared mode, the maximum modulation frequency is 500 kHz.

The LP_UART0 interface can also be used for firmware upgrade. See also [Open CPU software](#). It is recommended that this UART is either connected to a header for firmware upgrade or made available with test points.

2.10.2 Serial Peripheral Interface (SPI)

NORA-W30 modules have up to three SPI interfaces. Each SPI interface consists of four signals – **SCLK**, **nSPI_CS**, **MOSI**, and **MISO**. The Motorola SPI protocol is supported. Data speeds and modes are:

- HS_SPI0: ≤50 Mbps, master or slave mode
- HS_SPI1: ≤25 Mbps, master mode only
- HS_USI_SPI: ≤25 Mbps, master or slave mode. See also [Universal Serial Interface \(USI\)](#).

2.10.3 Inter-IC (I2C) interface

NORA-W30 modules have up to two I2C interfaces. Each I2C interface consists of two signals – **SCL** and **SDA**. Data speeds and modes are:

- LP_I2C: standard (≤100 kbps), fast (≤400 kbps), master or slave mode
- HS_USI_I2C: standard (≤100 kbps), fast (≤400 kbps), high-speed (≤3.4 Mbps), master or slave mode. See also [Universal Serial Interface \(USI\)](#).

2.10.4 Inter-IC Sound (I2S)

NORA-W30 modules have up to one high-speed I2S interface for communication with digital audio devices. In mono or stereo mode, the interface consists of the following signals – **MCK**, **SCK**, **WS**, **SD_o**, and **SD_i**. In 5.1 channel (surround sound) mode, the interface consists of the following signals – **MCK**, **SCK**, **WS**, **SD0**, **SD1**, and **SD2**.

2.10.5 Universal Serial Interface (USI)

NORA-W30 modules have up to one USI. The USI can be used as a high-speed I2C, UART, or SPI interface – in addition other high-speed communications interfaces listed above. See also [Inter-IC \(I2C\) interface](#), [Serial Peripheral Interface \(SPI\)](#), and [Universal Asynchronous Receiver Transmitter \(UART\)](#).

2.11 Digital interfaces

NORA-W30 modules have 20 I/O pins. The pins can be assigned to the digital interfaces listed below; however, assignments cannot be in conflict. To visualize the available pin assignments for the interfaces, see [Table 4](#).

2.11.1 Pulse Width Modulation (PWM)

NORA-W30 modules support up to 18 PWM outputs. There are 12 high-speed outputs – **HS_PWM[0,1,4..7,10..15]** – and 6 low-power outputs – **LP_PWM[0..5]**. The PWM module enables the generation of pulse width modulated signals on GPIO. The module implements 16-bit up counters that drive assigned GPIOs.

2.11.2 Key-scan

NORA-W30 modules support a keypad interface, consisting of up to 5 row x 2 column or 4 row x 3 column matrices. The key-scan can be used to wake NORA-W30 from deep-sleep.

2.11.3 Quadrature Decoder (Q-Decoder or QDEC)

NORA-W30 modules have up to one Q-Decoder to determine the position and speed of a rotary device. The interface consists of the following signals – **IDX**, **PHA**, and **PHB**.

2.12 Analog

NORA-W30 modules have up to three analog inputs – **ADC_4**, **ADC_5**, and **ADC_6**. The pins assignments cannot be in conflict with data and digital interfaces. To visualize the available pin assignments for the interfaces, see [Table 4](#).

2.13 Debug

NORA-W30 series uses the Arm® Serial Wire Debug (SWD) interface – **SWD_DATA** and **SWD_CLK** – for programming and debugging both cores of the Realtek RTL8720DF within the module.

2.14 No-connect pins (n/c)

Do not connect **n/c** pins. No-Connect pins are allocated for future interfaces and functionality.

2.15 Ground (GND) pins

Good electrical connection of all module GND pins, using solid ground layer of the host application board, is required for correct RF performance. Firm connections provide a thermal heat sink for the module and significantly reduce EMC issues.

3 Design-in

Follow the design guidelines stated in this chapter to optimize the integration of NORA-W30 series modules in the final application board.

3.1 Overview

Although all application circuits must be properly designed, there are several points that require special attention during application design. A list of these points, in order of importance, follows:

- **Module antenna connection: ANT Pad (NORA-W301 only)**
Antenna circuits affect the RF compliance of all applications that include the certification schemes related to the module. To maintain compliance and subsequent certification of the application design, it is important to observe the applicable parts of antenna schematic and layout design described in [Antenna interface](#).
- **Module supply: VDD and GND pins.**
Supply circuits can affect the RF performance. It is important to observe the schematic and layout design for these supplies. See also [VDD application circuits](#). Modules normally include several supply pins described in the pin out of the NORA-W30 data sheet [2].
- **High-speed data interfaces: UART, SPI, and I2C pins.**
High-speed data interfaces are a potential source of radiated noise that can affect the regulatory compliance standards for radiated emissions. It is important to follow the schematic and layout design recommendations described in the [General high-speed layout guidelines](#).
- **System functions: nRESET, GPIO and other System input and output pins**
Careful utilization of these pins in the application design is required to guarantee correct boot up and system operation. Ensure that the voltage level is correctly defined during module boot. It is important to follow the schematic and layout design recommendations described in the [General high-speed layout guidelines](#).
- **Other pins: ADC and NC pins.**
Careful utilization of these pins is required to guarantee proper functionality. It is important to follow the schematic and layout design recommendations described in the [General high-speed layout guidelines](#).

3.2 Antenna interface

As the unit cannot be mounted arbitrarily, the placement should be chosen with consideration so that it does not interfere with radio communication. NORA-W306 modules that include an internal PCB trace antenna cannot be mounted in a metal enclosure. No metal casing or plastics using metal flakes should be used. Avoid metallic based paint or lacquer as well. NORA-W301 modules offer more freedom as an external antenna can be mounted further away from the module.

-  According to the FCC regulations, the transmission line from the module's antenna pin to the antenna or antenna connector on the host PCB is considered part of the approved antenna design. Therefore, module integrators must either follow exactly one of the antenna reference designs used in the module's FCC type approval or certify their own designs.

3.2.1 RF transmission line design (NORA-W301)

RF transmission lines, such as the ones from the **ANT** pad up to the related internal antenna pad, must be designed so that the characteristic impedance is as close as possible to 50 Ω .

Design options and the most important parameters for implementing a transmission line on a PCB are described below:

- Microstrip: track separated with dielectric material and coupled to a single ground plane.
- Coplanar microstrip: track separated with dielectric material and coupled to both the ground plane and side conductor.
- Stripline: track separated by dielectric material and sandwiched between two parallel ground planes.

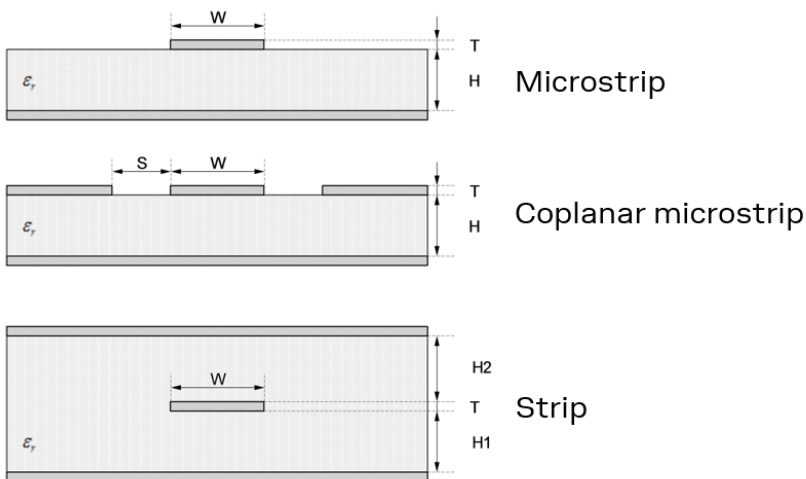

Figure 2: Transmission line trace design

Follow these recommendations to design a 50 Ω transmission line correctly:

- The designer should provide enough clearance from surrounding traces and ground in the same layer; in general, a trace to ground clearance of at least two times the trace width should be considered. The transmission line should also be 'guarded' by ground plane area on each side.
- The characteristic impedance can be calculated as first iteration using tools provided by the layout software. It is advisable to ask the PCB manufacturer to provide the final values that are usually calculated using dedicated software and available stack-ups from production. It could also be possible to request an impedance coupon on panel's side to measure the real impedance of the traces.
- FR-4 dielectric material, although it has high losses at high frequencies, can be considered in RF designs provided that:
 - RF trace length must be minimized to reduce dielectric losses.
 - If traces longer than a few centimeters are needed, it is recommended to use a coaxial connector and cable to reduce losses.
 - Stack-up should allow for thick 50 Ω traces and at least 200 μm trace width is recommended to assure good impedance control over the PCB manufacturing process.
 - FR-4 material exhibits poor thickness stability and thus less control of impedance over the trace length. Contact the PCB manufacturer for specific tolerance of controlled impedance traces.
- The transmission lines width and spacing to the GND must be uniform and routed as smoothly as possible: route RF lines in arcs (preferred) or 45° angles.
- Add GND stitching vias around transmission lines.

- Ensure solid metal connection of the adjacent metal layer on the PCB stack-up to main ground layer, providing enough vias on the adjacent metal layer.
- Route RF transmission lines far from any noise source (e.g., switching supplies and digital lines) and from any sensitive circuit to avoid crosstalk between RF traces and high impedance or analog signals.
- Avoid stubs on the transmission lines, any component on the transmission line should be placed with the connected pad over the trace. Also avoid any unnecessary components on RF traces.

3.2.2 Antenna design (NORA-W301)

NORA-W301 is suited for designs when an external antenna is needed due to mechanical integration or placement of the module.

Designers must take care of the antennas from all perspective at the beginning of the design phase when the physical dimensions of the application board are under analysis/decision, as the RF compliance of the device integrating NORA-W301 module with all the applicable required certification schemes heavily depends on the radiating performance of the antennas. The designer is encouraged to consider one of the u-blox suggested antenna part numbers and follow the layout requirements.

- External antennas such as those listed at [Antenna interface](#):
 - External antennas basically do not imply physical restriction to the design of the PCB where the module is mounted.
 - The radiation performance mainly depends on the antennas. It is required to select antennas with optimal radiating performance in the operating bands.
 - RF cables should carefully be selected with minimum insertion losses. Additional insertion loss will be introduced by low quality or long cable. Large insertion loss reduces radiation performance.
 - A high quality 50 Ω coaxial connector provides proper PCB-to-RF-cable transition.
- Integrated antennas such as patch-like antennas:
 - Internal integrated antennas imply physical restriction to the PCB design:

Integrated antenna excites RF currents on its counterpoise, typically the PCB ground plane of the device that becomes part of the antenna; its dimension defines the minimum frequency that can be radiated. Therefore, the ground plane can be reduced to a minimum size that should be similar to the quarter of the wavelength of the minimum frequency that has to be radiated, given that the orientation of the ground plane related to the antenna element must be considered.

The RF isolation between antennas in the system must be as high as possible and the correlation between the 3D radiation patterns of the two antennas has to be as low as possible. In general, an RF separation of at least a quarter wavelength between the two antennas is required to achieve a maximum isolation and low pattern correlation; increased separation should be considered, if possible, to maximize the performance and fulfil the requirements described in [Table 7](#). As a numerical example, the physical restriction to the PCB design can be considered as shown below:

$$\text{Frequency} = 2.4 \text{ GHz} \rightarrow \text{Wavelength} = 12.5 \text{ cm} \rightarrow \text{Quarter wavelength} = 3.125 \text{ cm}^1$$
 - Radiation performance depends on the whole product and antenna system design, including product mechanical design and usage. Antennas should be selected with optimal radiating performance in the operating bands according to the mechanical specifications of the PCB and the whole product.

¹ Wavelength referred to a signal propagating over the air.

Table 7 summarizes the requirements for the antenna RF interface:

Item	Requirements	Remarks
Impedance	50 Ω nominal characteristic impedance	The impedance of the antenna RF connection must match the 50 Ω impedance of the ANT pin.
Frequency Range	2400 – 2500 MHz 5150 – 5850 MHz	Wi-Fi and Bluetooth Wi-Fi
Return Loss	$S_{11} < -10$ dB (VSWR < 2:1) recommended $S_{11} < -6$ dB (VSWR < 3:1) acceptable	The Return loss or the S_{11} , as the VSWR, refers to the amount of reflected power, measuring how well the primary antenna RF connection matches the 50 Ω characteristic impedance of the ANT pin. The impedance of the antenna termination must match as much as possible the 50 Ω nominal impedance of the ANT pin over the operating frequency range, thus maximizing the amount of the power transferred to the antenna.
Efficiency	> -1.5 dB (> 70%) recommended > -3.0 dB (> 50%) acceptable	The radiation efficiency is the ratio of the radiated power to the power delivered to the antenna input; the efficiency is a measure of how well an antenna receives or transmits.
Maximum Gain	Refer to Data sheet	The maximum antenna gain must not exceed the value specified in type approval documentation to comply with the radiation exposure limits specified by regulatory agencies.

Table 7: Summary of antenna interface (ANT) requirements for NORA-W301

Observe the following recommendations while selecting external or internal antennas:

- Select antennas that provide optimal return loss (or VSWR) figure over all the operating frequencies.
- Select antennas that provide an optimal efficiency figure over all the operating frequencies.
- Select antennas that provide an appropriate gain figure (that is, combined antenna directivity and efficiency figure) so that the electromagnetic field radiation intensity does not exceed the regulatory limits specified in some countries (for example, by FCC in the United States).

3.2.2.1 RF connector design

If an external antenna is required, the designer should consider using a proper RF connector. It is the responsibility of the designer to verify the compatibility between plugs and receptacles used in the design.

Table 8 suggests several RF connectors that can be used by the designers to connect RF coaxial cables based on the declaration of the respective manufacturers. The Hirose U.FL-R-SMT RF receptacles (or similar parts) require a suitable mated RF plug from the same connector series. Due to wide usage of this connector, several manufacturers offer compatible equivalents.

Manufacturer	Series	Remarks
Hirose	U.FL® Ultra Small Surface Mount Coaxial Connector	Recommended
I-PEX	MHF® Micro Coaxial Connector	
Tyco	UMCC® Ultra-Miniature Coax Connector	
Amphenol RF	AMC® Amphenol Micro Coaxial	
Lighthouse Technologies, Inc.	IPX ultra micro-miniature RF connector	

Table 8: U.FL compatible connectors

Typically, the RF plug is available as a cable assembly. Different types of cable assembly are available; the user should select the cable assembly best suited to the application. The key characteristics are:

- RF plug type: select U.FL or equivalent
- Nominal impedance: 50 Ω
- Cable thickness: Typically, from 0.8 mm to 1.37 mm. Select thicker cables to minimize insertion loss.
- Cable length: Standard length is typically 100 mm or 200 mm; custom lengths may be available on request. Select shorter cables to minimize insertion loss.
- RF connector on the other side of the cable: For example, another U.FL (for board-to-board connection) or SMA (for panel mounting).

Consider that SMT connectors are typically rated for a limited number of insertion cycles. Additionally, the RF coaxial cable may be relatively fragile compared to other types of cables. To increase application ruggedness, connect U.FL connector to a more robust connector such as SMA fixed on panel.

 A de-facto standard for SMA connectors implies the usage of reverse polarity connectors (RP-SMA) on Wi-Fi and Bluetooth® end products to increase the difficulty for the end user to replace the antenna with higher gain versions and exceed regulatory limits.

The following recommendations apply for the proper layout of the connector:

- Strictly follow the connector manufacturer's recommended layout:
 - SMA Pin-Through-Hole connectors require GND keep-out (that is, clearance, a void area) on all the layers around the central pin up to annular pads of the four GND posts.
 - U.FL surface mounted connectors require no conductive traces (that is, clearance, a void area) in the area below the connector between the GND land pads.

If the connector's RF pad size is wider than the micro strip, remove the GND layer beneath the RF connector to minimize the stray capacitance thus keeping the RF line 50 Ω . For example, the active pad of the U.FL connector must have a GND keep-out (that is, clearance, a void area) at least on the first inner layer to reduce parasitic capacitance to ground.

3.2.2.2 Integrated antenna design

If integrated antennas are used, the transmission line is terminated by the integrated antennas themselves. Follow the guidelines mentioned below:

- The antenna design process should begin at the start of the whole product design process. Self-made PCBs and antenna assembly are useful in estimating overall efficiency and radiation path of the intended design.
- Use antennas designed by an antenna manufacturer providing the best possible return loss (or VSWR).
- Provide a ground plane large enough according to the related integrated antenna requirements. The ground plane of the application PCB may be reduced to a minimum size that must be similar to one quarter of wavelength of the minimum frequency that has to be radiated; however overall antenna efficiency may benefit from larger ground planes.
- Proper placement of the antenna and its surroundings is also critical for antenna performance. Avoid placing the antenna close to conductive or RF-absorbing parts such as metal objects, ferrite sheets and so on as they may absorb part of the radiated power or shift the resonant frequency of the antenna or affect the antenna radiation pattern.
- It is highly recommended to strictly follow the detailed and specific guidelines provided by the antenna manufacturer regarding correct installation and deployment of the antenna system, including PCB layout and matching circuitry.

- Further to the custom PCB and product restrictions, antennas may require tuning/matching to comply with all the applicable required certification schemes. It is recommended to consult the antenna manufacturer for the design-in guidelines and plan the validation activities on the final prototypes like tuning/matching and performance measures. See also [Table 7](#).
- RF section may be affected by noise sources like hi-speed digital buses. Avoid placing the antenna close to buses such as DDR or consider taking specific countermeasures like metal shields or ferrite sheets to reduce interference.

Take care of the interaction between co-located RF systems like LTE sidebands on 2.4 GHz band. Transmitted power may interact or disturb the performance of NORA-W30 modules.

3.2.3 NORA-W301 U.FL reference design

Figure 3 shows the U.FL connector (J13) for connecting an approved external antenna. A 10 pF 0201 size series capacitor, similar to C39 in Figure 3 should be used. C52 and C53 are not populated.

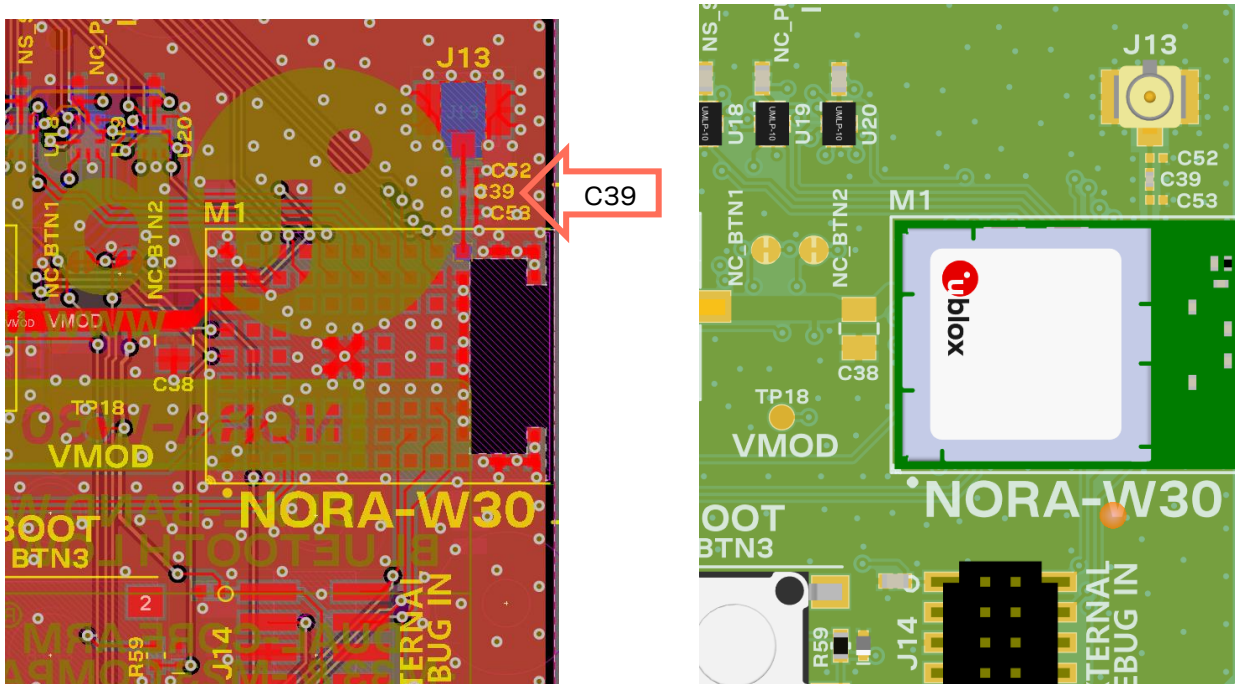

Figure 3: NORA-W301 approved U.FL antenna connection, 2D and 3D views.

The keep-out area under NORA-W300 or NORA-W301 is not required.

The layer stack-up is shown in Figure 4.

#	Name	Material	Type	Weight	Thickness	Dk
	Top Overlay		Overlay			
	Top Solder	Solder Resist	Solder Mask		0.0127mm	3.5
1	L1		Signal	1oz	0.035mm	
	Dielectric 1	Composite dielectric	Prepreg		0.11mm	4.29
2	L2		Signal	1oz	0.035mm	
	Core	Composite dielectric	Core		1.2mm	4.29
3	L3		Signal	1oz	0.035mm	
	Dielectric 3	Composite dielectric	Prepreg		0.11mm	4.29
4	L4		Signal	1oz	0.035mm	
	Bottom Solder	Solder Resist	Solder Mask		0.0127mm	3.5
	Bottom Overlay		Overlay			

Figure 4: NORA-W301 host board approved layer stack-up

See Appendix B: [Reference trace design \(NORA-W3x1 only\)](#) for full trace design details.

3.2.4 On-board antenna design (NORA-W306)

If a plastic enclosure is used, it is possible to use NORA-W306 with the embedded antenna. To reach optimum operating performance, follow the instructions in this section.

3.2.4.1 NORA-W306 – PCB trace antenna

- The module shall be placed in the center of an edge of the host PCB.
A large ground plane on the host PCB is a prerequisite for good antenna performance. It is recommended to have the ground plane extending at least 10 mm on the three non-edge sides of the module. See also [Figure 5](#).
- The host PCB shall include a full GND plane underneath the entire module, with a ground cut out under the PCB trace antenna according to the description in [Figure 6](#).
- The NORA-W3x6 has six extra GND pads under the antenna that need to be connected for a good antenna performance. Detailed measurements of the footprint including this extra GND pads can be found in the NORA-W30 series data sheet [2].
- High / large parts including metal shall not be placed closer than 10 mm to the module's antenna.
- At least 10 mm clearance between the antenna and the casing is recommended. If the clearance is less than 10 mm, the antenna performance can be adversely affected.
- The module shall be placed such that the antenna faces outwards from the product and is not obstructed by any external items in close vicinity of the products intended use case.
- Keep a minimum clearance of 5 mm between the antenna and any casing. Also, keep at least 10 mm of free space around the metal antenna including the area directly below it. If a metal enclosure is required, use NORA-W361 and an external antenna.
- It is beneficial to have a large solid ground plane on the host PCB with a good grounding on the module. Minimum ground plane size is 24x30 mm but more than 50x50 mm is recommended.

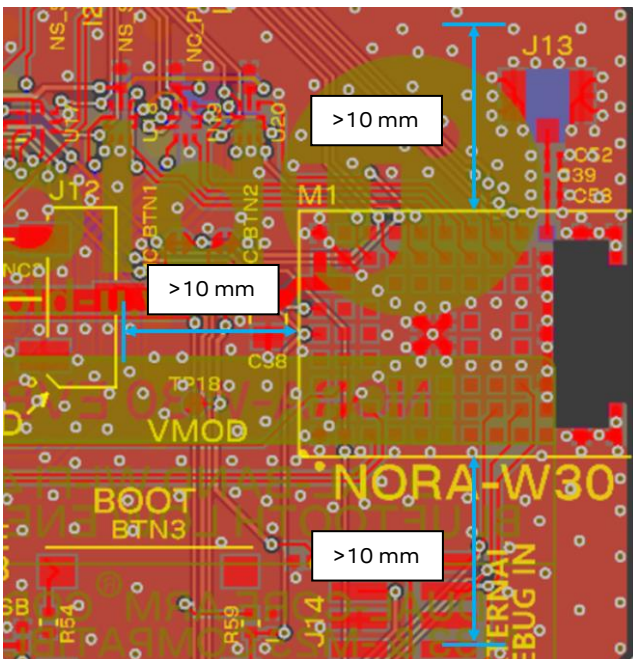

Figure 5: GND plane guard area enclosing NORA-W3x6

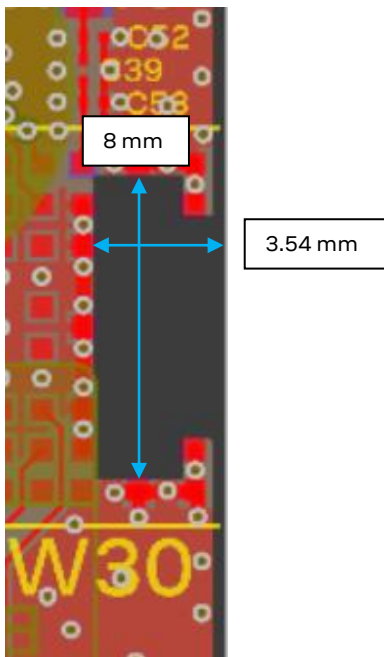

Figure 6: Size of the GND cut out for the NORA-W30x6 PCB trace antenna

3.3 Data communication interfaces

3.3.1 Asynchronous serial interface (UART) design

The layout of the UART bus should be done so that noise injection and cross talk are avoided. It is advisable to use the hardware flow control with RTS/CTS to prevent temporary UART buffer overrun.

The flow control signals **RTS/CTS** are active low. Consequently, 0 (ON state = low level) allows the UART to transmit.

- **CTS** is an input to the NORA-W30 module. If the host sets this input to 0 (ON state = low level) the module can transmit.
- **RTS** is an output of the NORA-W30 module. The module sets the output to 0 (ON state = low level) when it is ready to receive transmission.

3.4 General high-speed layout guidelines

These guidelines describe the best schematic and layout practices for integrating the module on a host PCB. Designers should prioritize the layout of higher speed buses. Low frequency signals, other than those with high-impedance traces, are generally not layout critical.

- ⚠ Low frequency signals with high-impedance traces (such as signals driven by weak pull resistors) may be affected by crosstalk. For these high-impedance traces, a supplementary isolation of $4*W$ from other buses is recommended.

3.4.1 Considerations for schematic design and PCB floor-planning

- Verify which signal bus requires termination and add series resistor terminations to the schematics.
- Carefully consider the placement of the module with respect to antenna position.
- Verify with PCB manufacturer allowable stack-ups and controlled impedance dimensioning.
- Verify that the power supply design and power sequence are compliant with the specification of NORA-W30 series module.

3.4.2 Component placement

- Accessory parts like bypass capacitors should be placed as close as possible to the module to improve filtering capability, prioritizing the placement of the smallest size capacitor close to module pads.
- Do not place components close to the antenna area. Follow the recommendations of the antenna manufacturer to determine distance of the antenna in relation to other parts of the system. Designers should also maximize the distance of the antenna to High-frequency busses, like DDRs and related components. Alternatively, consider an optional metal shield to reduce interference that might otherwise be picked up by the antenna and subsequently reduce module sensitivity.
- An optimized module placement allows better RF performance. For more information about the module placement and other antenna considerations, see also [Antenna requirements](#).

3.4.3 Layout and manufacturing

- Avoid stubs on high-speed signals. Test points or component pads should be placed over the PCB trace.
- Verify the recommended maximum signal skew for differential pairs and length matching of buses.
- Minimize the routing length; longer traces degrade signal performance. Ensure that the maximum allowable length for high-speed buses is not exceeded.
- Ensure to track your impedance matched traces. Consult early with your PCB manufacturer for proper stack-up definition.
- RF, analog, and digital sections should have dedicated and clearly separated areas on the board.
- No digital routing is allowed in the GND reference plane area of RF traces (**ANT** pin and antenna).
- Designers are strongly recommended to avoid digital routing beneath all layers of RF traces.
- Ground cuts or separation are not allowed under the module.
- As a first priority, minimize the length of the RF traces. Then, minimize bus length to reduce potential EMI issues related to the radiation of digital buses.
- All traces (Including low speed or DC traces) must couple with a reference plane (GND or power). High-speed buses should be referenced to the ground plane. If designers need to change the ground reference, some capacitors should be added and an adequate number of GND vias must be added in the area of transition. This facilitates a low-impedance path between the two GND layers for the return current.
- Trace routing should maintain a distance that is greater than $3*W$ from the edge of the ground plane routing.
- Do not route power planes or traces in loops.
- Route the power traces through both the bypass capacitor and bulk capacitor before connecting to the module's pin.
- Power planes should maintain a safe distance from the edge of the PCB. The distance must be sufficient to route a ground ring around the PCB, and the ground ring must then be stitched to other layers through vias.

3.5 Module footprint and paste mask

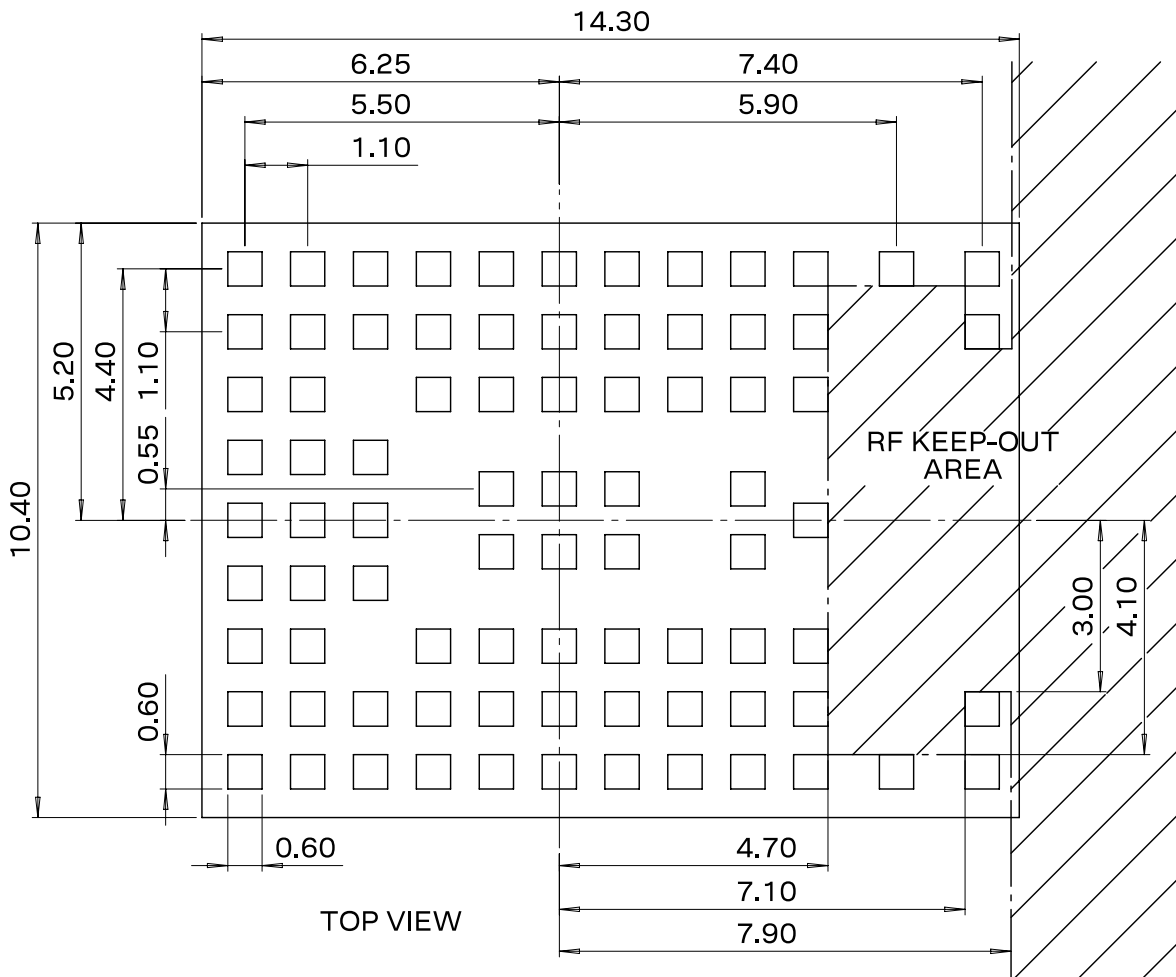

Figure 7: NORA-W30 mechanical outline

Figure 7 shows the pin layout of NORA-W30 series modules. The proposed land pattern layout complements the pin layout of the module. Both Solder Mask Defined (SMD) and Non-Solder Mask Defined (NSMD) pins can be used with adherence to the following considerations:

- All pins should be Non-Solder Mask Defined (NSMD)
- To help with the dissipation of the heat generated by the module, GND pads must have good thermal bonding to PCB ground planes.

The suggested stencil layout for the NORA-W30 module should follow the copper pad layout, as shown in Figure 7. The assembly house should determine the thickness of the solder paste stencil based on the entire host PCB, typically 100-120 μm .

3.6 Thermal guidelines

The NORA-W30 series modules have been successfully tested in $-40\text{ }^{\circ}\text{C}$ to $+105\text{ }^{\circ}\text{C}$. A good grounding should be observed for temperature relief during high ambient temperature.

3.7 ESD guidelines

The immunity of devices integrating NORA-W30 modules to Electro-Static Discharge (ESD) is part of the Electro-Magnetic Compatibility (EMC) conformity, which is required for products bearing the CE marking, compliant with the R&TTE Directive (99/5/EC), the EMC Directive (89/336/EEC) and the Low Voltage Directive (73/23/EEC) issued by the Commission of the European Community.

Compliance with these directives implies conformity to the following European Norms for device ESD immunity: ESD testing standard *CENELEC EN 61000-4-2* and the radio equipment standards *ETSI EN 301 489-1*, *ETSI EN 301 489-7*, *ETSI EN 301 489-24*, the requirements of which are summarized in [Table 9](#).

The ESD immunity test is performed at the enclosure port, defined by *ETSI EN 301 489-1* as the physical boundary through which the electromagnetic field radiates. If the device implements an integral antenna, the enclosure port is seen as all insulating and conductive surfaces housing the device. If the device implements a removable antenna, the antenna port can be separated from the enclosure port. The antenna port includes the antenna element and its interconnecting cable surfaces.

The applicability of ESD immunity test to the whole device depends on the device classification as defined by *ETSI EN 301 489-1*. Applicability of ESD immunity test to the related device ports or the related interconnecting cables to auxiliary equipment, depends on the device accessible interfaces and manufacturer requirements, as defined by the *ETSI EN 301 489-1*.

Contact discharges are performed at conductive surfaces, while air discharges are performed at insulating surfaces. Indirect contact discharges are performed on the measurement setup horizontal and vertical coupling planes as defined in the *CENELEC EN 61000-4-2*.

For the definition of integral antenna, removable antenna, antenna port, and device classification, refer to the *ETSI EN 301 489-1*. For the contact and air discharges definitions, refer to *CENELEC EN 61000-4-2*.

Parameter	Min.	Typical	Max.	Unit	Remarks
ESD immunity. All exposed surfaces of the radio equipment and ancillary equipment in a representative configuration			8*	kV	Indirect discharge according to IEC 61000-4-2
ESD sensitivity, tested for all pins			2.0	kV	Human body model according to JEDEC EIA/JESD22-A114

* EVK-NORA-W30 tests pending

Table 9: Electro-Magnetic Compatibility ESD immunity requirements as defined by CENELEC EN 61000-4-2, ETSI EN 301 489-1, ETSI EN 301 489-7, ETSI EN 301 489-24

NORA-W30 is manufactured with consideration to the specific standards for minimizing the occurrence of ESD events. The highly automated process complies with the IEC61340-5-1 (STM5.2-1999 Class M1 devices) standard. Consequently, the designer should implement proper measures to protect from ESD events on any pin that may be exposed to the end user.

Compliance with standard protection level specified in the EN61000-4-2 can be achieved by including the ESD protections in parallel to the line, close to areas accessible by the end user.

3.8 Design-in checklists

3.8.1 Schematic checklist

- All module pins have been properly numbered and designated in the schematic (including thermal pins).
- Power supply design complies with the specification.
- The power sequence has been properly implemented.
- Adequate bypassing has been included in front of each power pin.
- Each signal group is consistent with its own power rail supply or proper signal translation has been provided.
- Configuration pins are properly set at bootstrap.
- SDIO bus includes series resistors and pull-ups, if needed.
- Unused pins are properly terminated.
- A pi-filter is provided in front of each antenna for final matching (NORA-W301 only)
- Additional RF co-location filters have been considered in the design.

3.8.2 Layout checklist

- PCB stack-up and controlled impedance traces follow the recommendations given by the PCB manufacturer.
- All pins are properly connected, and the footprint follows u-blox pin design recommendations.
- Proper clearance has been provided between the RF and digital sections of the design.
- Proper isolation has been provided between antennas (RF co-location, diversity, or multi-antenna design).
- Bypass capacitors have been placed close to the module.
- Low impedance power path has been provided to the module.
- Controlled impedance traces have been properly implemented in the layout (both RF and digital) and the recommendations provided by the PCB manufacturer have been followed.
- 50 Ω RF traces and connectors follow the rules described in [RF connector design](#).
- Antenna design has been reviewed by the antenna manufacturer.
- Proper grounding has been provided to the module for the low impedance return path and heat sink.
- Reference plane skipping has been minimized for high frequency buses.
- All traces and planes are routed inside the area defined by the main ground plane.
- u-blox has reviewed and approved the PCB².

² This is applicable only for end-products based on u-blox reference designs.

4 Open CPU software

4.1 Realtek SDK

Realtek provides application development information and SDKs through the Ameba IoT website [16] and repositories on GitHub [17].

4.1.1 Standard SDK

NORA-W30 is supported through the standard Realtek SDK that covers the GNU Compiler Collection (GCC) and IAR development environments.

For GCC, see the Realtek GitHub Ameba IoT site [18] and Realtek Ameba-D application note [15], sections 3, 4, and 5. For IAR, see Realtek Ameba-D application note [15], section 6.

For GCC, see the Realtek GitHub Ameba-D standard SDK repository [18] and Realtek Ameba-D application note [15], sections 3, 4, and 5. For IAR, see [15], section 6

4.1.1.1 SDK support

Realtek provides SDK support through the GitHub repositories issues and pull requests. See Realtek GitHub Ameba IoT site [17], Realtek GitHub Ameba-D standard SDK repository [18], Realtek GitHub Ameba-D Arduino repository [19], and Ameba IoT support forum [20].

4.1.2 Install Cygwin 32-bit for Windows

When using GCC it is recommended to use the Realtek SDK in a Linux environment, but it is possible to use it in Windows. Please note that the 32-bit version of Cygwin x86, that is the only version that is supported by the Realtek SDK for Windows. It has been end-of-life and can no longer be downloaded from the official Cygwin web site [24]. Note that Cygwin is not used when using IAR development environments.

Follow this workaround to download and install the Cygwin version that is working with Realtek SDK:

Download latest 32-bit Cygwin application "setup-x86.exe" [a3f6a0823a1f1f609db5fb7131ac297b] from [here](#).

Open command prompt in administrator mode.

```
Type "start <setup-x86.exe location> --allow-unsupported-windows option -site
http://ctm.crouchingtigerhiddenfruitbat.org/pub/cygwin/circa/2022/11/23/063457"
```

During the install, add `Devel > Make` and `Math > bc` into the Cygwin package. You can use the Search function to find it.

4.1.3 Arduino IDE

NORA-W30 is supported through the Arduino IDE, version 2.1 and newer. See the Arduino site [21]. After installing the standard Arduino IDE, support for NORA-W30 can be added by following the instructions given in the Realtek GitHub Ameba-D Arduino repository [19]. Support for NORA-W30 was added in version 3.1.7.

 The UART on the debug interface on EVK-NORA-W30 supports baud rates up to 1 Mbps. The latest files at the Realtek GitHub site contain the necessary settings.

4.1.4 Matter support

NORA-W30 supports Matter using Bluetooth and Wi-Fi. The official Matter open source repository [22] should be used together with the Realtek SDK adaptation for Matter [23].

4.1.5 Flashing open CPU software

NORA-W30 includes a serial bootloader from Realtek to facilitate loading over UART. A SWD connection is available for debugging.

The EVK-NORA-W30 also includes a J-Link On board (LINK-OB) debug interface. No additional hardware is required for flash loading or interactive debugging.

A debug-in connection is available to connect more advanced debug probes.

To enter the Realtek ROM bootloader, the button BOOT (BTN3) must be pressed during power up or a reset. Figure 8 shows the location of the BOOT (BTN3) on the EVK-NORA-W30.

Realtek provides a flash tool for Windows called ImageTool.exe, make sure the AmebaD(8721D) is selected as chip. Note that the EVK-NORA-W30 is limited to 1000000 baudrate when using the Realtek ROM bootloader.

ImageTool.exe is located in the SDK: SDK\tools\AmebaD\Image_Tool\ImageTool.exe

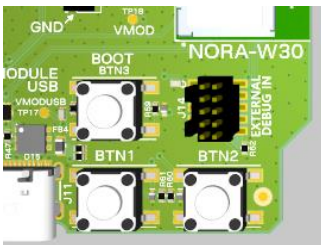

Figure 8: BOOT (BTN3) button to enter the bootloader

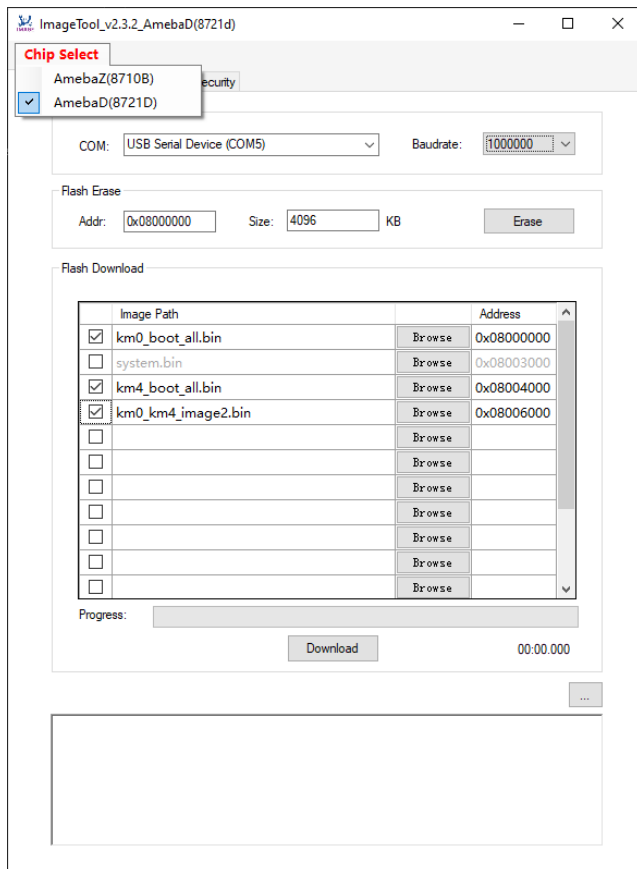

Figure 9: Realtek ImageTool.exe for Windows

4.2 Wi-Fi MAC and Bluetooth device addresses and calibration data

A block of four public MAC addresses is allocated to each NORA-W30 module. The base address is encoded in the data matrix. Addresses are intended to be allocated as follows:

- Base address = Wi-Fi station address
- Base address + 1 = Wi-Fi access point address
- Base address + 2 = Bluetooth LE device address
- Base address + 3 = unused

For data matrix details, see the NORA-W30 data sheet [2].

The base Wi-Fi and Bluetooth MAC addresses are programmed into the one-time programmable (OTP) eFuse locations during end-product production according to Realtek’s eFuse definitions.

Production calibration data is programmed into the eFuse, such as Wi-Fi channel/mode RF power calibration indexes, thermal meter references, crystal trim value, Bluetooth power calibration, and default Bluetooth power settings.

4.3 Set regulatory domain channel plan

A regulatory domain channel plan must be set during WLAN initialization to maintain regulatory compliance. The codes in Table 10 must be used for the appropriate regulatory domain to limit Wi-Fi channel selection and output power. The OEM integrator must not allow the channel plan to be changed.

Regulatory domain	Channel plan code
FCC	0x3F
ISED	0x4A
ETSI	0x5E
MKK	0x7D

Table 10: Approved regulatory domain codes

4.4 Output power limit configuration

The Realtek SDK must be configured to build using the updated RF channel plans and power limit tables provided by u-blox to maintain regulatory compliance. Channel plan and power table files and instructions are provided in the SHO-OpenCPU GitHub repository [25].

5 Handling and soldering

- ⚠** NORA-W30 series modules are Electrostatic Sensitive Devices that demand the observance of special handling precautions against static damage. Failure to observe these precautions can result in severe damage to the product.



5.1 ESD handling precautions

As the risk of electrostatic discharge in the RF transceivers and patch antennas of the module is of particular concern, standard ESD safety practices are prerequisite. See also [Figure 10](#).

Consider also:

- When connecting test equipment or any other electronics to the module (as a standalone or PCB-mounted device), the first point of contact must always be to local GND.
- Before mounting an antenna patch, connect the device to ground.
- When handling the RF pin, do not touch any charged capacitors. Be especially careful when handling materials like patch antennas (~10 pF), coaxial cables (~50-80 pF/m), soldering irons, or any other materials that can develop charges.
- To prevent electrostatic discharge through the RF input, do not touch any exposed antenna area. If there is any risk of the exposed antenna being touched in an unprotected ESD work area, be sure to implement proper ESD protection measures in the design.
- When soldering RF connectors and patch antennas to the RF pin on the receiver, be sure to use an ESD-safe soldering iron (tip).

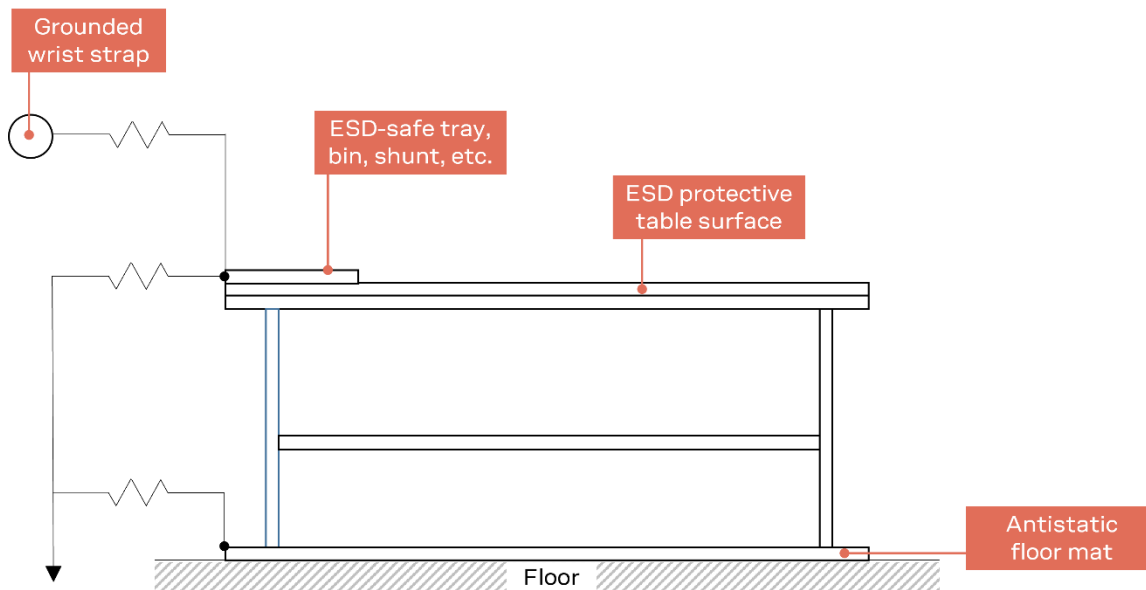

Figure 10: Standard workstation setup for safe handling of ESD-sensitive devices

5.2 Packaging, shipping, storage, and moisture preconditioning

For information pertaining to reels, tapes or trays, moisture sensitivity levels (MSL), shipment and storage, as well as drying for preconditioning, refer to the NORA-W30 series data sheet [\[2\]](#) and Packaging information reference guide [\[1\]](#).

5.3 Reflow soldering process

NORA-W30 series modules are surface mounted devices supplied in a Land Grid Array (LGA) package with gold-plated solder lands. The modules are manufactured in a lead-free process with lead-free soldering paste.

The thickness of solder resist between the host PCB top side and the bottom side of the NORA-W30 series module must be considered for the soldering process.

NORA-W30 modules are compatible with the industrial reflow profile for common SAC type RoHS solders. No-clean soldering paste is strongly recommended. The reflow profile is dependent on the thermal mass over the entire area of the fully populated host PCB, the heat transfer efficiency of the oven, and the type of solder paste that is used. The optimal soldering profile that is used must be trimmed for each case depending on the specific soldering process and PCB layout.

The target parameter values shown in [Table 11](#) are only general guidelines for a Pb-free process. The given values are tentative and subject to change. For further information, see also the JEDEC J-STD-020C standard [\[6\]](#).

Process parameter		Unit	Target
Pre-heat	Ramp up rate to T_{SMIN}	K/s	3
	T_{SMIN}	°C	150
	T_{SMAX}	°C	200
	t_s (from +25 °C)	s	150
	t_s (Pre-heat)	s	60 to 120
Peak	T_L	°C	217
	t_L (time above T_L)	s	40 to 60
	T_P (absolute max)	°C	245
Cooling	Ramp-down from T_L	K/s	4
	Allowed soldering cycles	-	1

Table 11: Recommended reflow profile

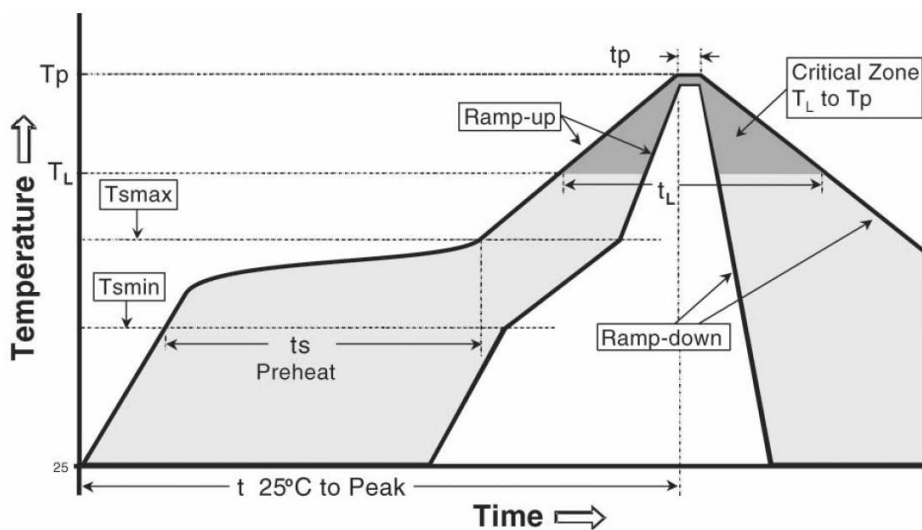



Figure 11: Reflow profile

Lower value of T_P and slower ramp down rate (2–3 °C/sec) is preferred.

-  After reflow soldering, optical inspection of the modules is recommended to verify proper alignment.

5.3.1 Cleaning

Cleaning the modules is not recommended. Residues underneath the modules cannot be easily removed with a washing process.

- Cleaning with water will lead to capillary effects where water is absorbed in the gap between the baseboard and the module. The combination of residues of soldering flux and encapsulated water leads to short circuits or resistor-like interconnections between neighboring pins. Water will also damage the sticker and the ink-jet printed text.
- Cleaning with alcohol or other organic solvents can result in soldering flux residues flooding into the housing, areas that are not accessible for post-wash inspections. The solvent will also damage the label and the ink-jet printed text.
- Ultrasonic cleaning will permanently damage the module and the crystal oscillators in particular.

For best results use a "no-clean" soldering paste and circumvent the need for a cleaning stage after the soldering process.

5.3.2 Other notes

- Only a single-reflow soldering process is allowed for boards with a module populated on it.
- Boards with combined through-hole technology (THT) components and surface-mount technology (SMT) devices may require wave soldering to solder the THT components. Only a single wave-soldering process is allowed for boards populated with the modules. Miniature Wave Selective Solder processes are preferred over traditional wave soldering processes.
- Hand-soldering is not recommended.
- Rework is not recommended.
- Conformal coating can affect the performance of the module, which means that it is important to prevent the liquid from flowing into the module. The RF shields do not provide protection for the module from coating liquids with low viscosity; therefore, care is required while applying the coating. Conformal Coating of the module will void the warranty.
- Grounding metal covers: Attempts to improve grounding by soldering ground cables, wick, or other forms of metal strips directly onto the EMI covers is done so at the customer's own risk and will void the module warranty. The numerous ground pins are adequate to provide optimal immunity to interferences.
- The modules contain components which are sensitive to Ultrasonic Waves. Use of any Ultrasonic Processes (cleaning, welding, etc.) may damage the module. The use of ultrasonic processes during the integration of the module into an end product will void the warranty.

6 Regulatory compliance

 All approvals currently pending

6.1 General requirements

NORA-W30 series modules are designed to comply with the regulatory demands of Federal Communications Commission (FCC), Innovation, Science, and Economic Development Canada (ISED)³ and the CE mark. This chapter contains instructions on the process needed for an integrator when including the NORA-W30 module into an end-product.

- Any deviation from the process described may cause the NORA-W30 series module not to comply with the regulatory authorizations of the module and thus void the user's authority to operate the equipment.
- Any changes to hardware, hosts or co-location configuration may require new radiated emission and RF exposure evaluation and/or testing.
- The regulatory compliance of NORA-W30 series module does not exempt the end-product from being evaluated against applicable regulatory demands; for example, FCC Part 15B criteria for unintentional radiators [7].
- The end-product manufacturer must follow all the engineering and operating guidelines as specified by the grantee (u-blox).
- The NORA-W30 is for OEM integrators only.
- Only authorized antenna(s) may be used. Refer to

³ Formerly known as IC (Industry Canada).

- [Approved](#) antennas for the list of authorized antennas. In the end-product, the NORA-W30 series module must be installed in such a way that only authorized antennas can be used.
- For end products using the NORA-W301, the end-product must use the specified antenna trace reference design, as described in the [Antenna interface](#). A custom trace design can be approved and submitted through a C2PC. See [Adding a new antenna for authorization](#).
- Any notification to the end user about how to install or remove the integrated radio module is NOT allowed.
- Electromagnetic interference compatibility (EMI / EMC) and spurious emissions tests are required for end-products targeted for most world regions.

 If these conditions cannot be met or any of the operating instructions are violated, the u-blox regulatory authorization will be considered invalid. Under these circumstances, the integrator is responsible to re-evaluate the end-product including the NORA-W30 series module and obtain their own regulatory authorization, or u-blox may be able to support updates of the u-blox regulatory authorization. See also [Antenna requirements](#).

6.2 European Union regulatory compliance (pending)

NORA-W30 series modules comply with the essential requirements and other relevant provisions of Radio Equipment Directive (RED) 2014/53/EU.

For information about the regulatory compliance of NORA-W30 series modules against requirements and provisions in the European Union, see the NORA-W3 Declaration of Conformity [13].



6.2.1 CE end-product regulatory compliance

6.2.1.1 Safety standard

To fulfill the safety standard EN 62368-1 [10], the NORA-W30 module must be supplied with a Class-2 Limited Power Source.

6.2.1.2 ETSI Equipment classes

In accordance with Article 1 of Commission Decision 2000/299/EC⁴, NORA-W30 is defined as either Class-1 or Class-2 radio equipment, the end-product integrating NORA-W30 inherits the equipment class of the module.

-  Guidance on end product marking, according to the RED can be found at: <http://ec.europa.eu/>
-  The restrictions while operating the NORA-W30 in Wi-Fi mode in the European countries are shown in section “European Union regulatory compliance” of the NORA-W30 data sheet [2].
-  The EIRP of the NORA-W30 module must not exceed the limits of the regulatory domain that the module operates in. Depending on the host platform’s implementation and antenna gain, integrators have to limit the maximum output power of the module through the application software. Refer to the NORA-W30 data sheet [2] and

⁴ 2000/299/EC: Commission Decision of 6 April 2000 establishing the initial classification of radio equipment and telecommunications terminal equipment and associated identifiers.

 **Approved** antennas for the module's approved antennas list and corresponding maximum transmit power levels.

6.2.2 Compliance with the RoHS directive

NORA-W30 series modules comply with the Directive 2011/65/EU (EU RoHS 2) and its amendment Directive (EU) 2015/863 (EU RoHS 3).

6.3 Great Britain regulatory compliance (pending)

For information about the regulatory compliance of NORA-W30 series modules against requirements and provisions in Great Britain, see also the NORA-W3 UKCA Declaration of Conformity [14].

6.3.1 UK Conformity Assessed (UKCA)

 The United Kingdom is made up of the Great Britain (including England, Scotland, and Wales) and the Northern Ireland. Northern Ireland continues to accept the CE marking. The following notice is applicable to Great Britain only.

NORA-W30 series modules have been evaluated against the essential requirements of the Radio Equipment Regulations 2017 (SI 2017 No. 1206, as amended by SI 2019 No. 696).

Guidance about using the UKCA marking: <https://www.gov.uk/guidance/using-the-ukca-marking>.

6.4 FCC/ISED End-product regulatory compliance (pending)

u-blox represents that the modular transmitter fulfills the FCC/ISED regulations when operating in authorized modes on any host-product given that the integrator follows the instructions as described in this document. Accordingly, the host-product manufacturer acknowledges that all host-products referring to the FCC ID or ISED certification number of the modular transmitter and placed on the market by the host-product manufacturer need to fulfil all of the requirements mentioned below. Non-compliance with these requirements may result in revocation of the FCC approval and removal of the host-products from the market. These requirements correspond to questions featured in the FCC guidance for software security requirements for U-NII devices, FCC OET KDB 594280 D02 [12].

 The modular transmitter approval of NORA-W30, or any other radio module, does not exempt the end product from being evaluated against applicable regulatory demands.

The evaluation of the end product shall be performed with the NORA-W30 module installed and operating in a way that reflects the intended end product use case. The upper frequency measurement range of the end product evaluation is the 5th harmonic of 5.8 GHz as described in KDB 996369 D04.

The following requirements apply to all products that integrate a radio module:

- **Subpart B - UNINTENTIONAL RADIATORS**
To verify that the composite device of host and module comply with the requirements of FCC part 15B, the integrator shall perform sufficient measurements using ANSI 63.4-2014.
- **Subpart C - INTENTIONAL RADIATORS**
It is required that the integrator carries out sufficient verification measurements using ANSI 63.10-2013 to validate that the fundamental and out of band emissions of the transmitter part of the composite device complies with the requirements of FCC part 15C.

When the items listed above are fulfilled, the end product manufacturer can use the authorization procedures as mentioned in Table 1 of 47 CFR Part 15.101, before marketing the end product. This means the customer has to either market the end product under a Suppliers Declaration of Conformity (SDoC) or to certify the product using an accredited test lab.

The description is a subset of the information found in applicable publications of FCC Office of Engineering and Technology (OET) Knowledge Database (KDB). We recommend the integrator to read the complete document of the referenced OET KDB's.

- KDB 178919 D01 Permissive Change Policy
- KDB 447498 D01 General RF Exposure Guidance
- KDB 594280 D01 Configuration Control
- KDB 594280 D02 U-NII Device Security
- KDB 784748 D01 Labelling Part 15 18 Guidelines
- KDB 996369 D01 Module certification Guide
- KDB 996369 D02 Module Q&A
- KDB 996369 D04 Module Integration Guide

6.4.1 United States compliance statement (FCC)

NORA-W30 series modules have modular approval and comply with Part 15 of the FCC Rules. Operation is subject to the following two conditions:

1. This device may not cause harmful interference, and
2. This device must accept any interference received, including interference that may cause undesired operation.

 Any changes or modifications NOT explicitly APPROVED by u-blox could cause the NORA-W30 series module to cease to comply with FCC rules part 15 thus void the user's authority to operate the equipment.

The internal / external antenna(s) used for this module must provide a separation distance of at least 20 cm from all persons and must not be co-located or operating in conjunction with any other antenna or transmitter.

Table 12 shows the FCC IDs allocated to NORA-W30 series modules.

Model	FCC ID
NORA-W300	XPYNORAW3
NORA-W301	XPYNORAW3
NORA-W306	XPYNORAW3

Table 12: FCC IDs for different variants of NORA-W30 series modules

For FCC end-product labeling requirements, see [End product labeling requirements](#).

6.4.2 Canada compliance statement (ISED)

NORA-W30 series modules are certified for use in accordance with Innovation, Science and Economic Development Canada (ISED) Radio Standards Specification (RSS) RSS-247 Issue 2 and RSS-Gen. Table 13 shows the ISED certification IDs allocated to NORA-W30 series modules.

Model	ISED certification ID
NORA-W300	8595A-NORAW3
NORA-W301	8595A-NORAW3
NORA-W306	8595A-NORAW3

Table 13: ISED IDs for different variants of NORA-W30 series modules

NORA-W30 complies with ISED (Innovation, Science and Economic Development Canada)⁵ license-exempt RSS(s). Operation is subject to the following two conditions:

1. This device may not cause interference, and
2. This device must accept any interference, including interference that may cause undesired operation of the device.



 Any notification to the end user of installation or removal instructions about the integrated radio module is NOT allowed. Unauthorized modification could void authority to use this equipment.

This equipment complies with ISED RSS-102 radiation exposure limits set forth for an uncontrolled environment. This equipment should be installed and operated with minimum distance 20 cm between the radiator and your body.

This radio transmitter IC: 8595A-NORAW3 has been approved by ISED to operate with the antenna types listed in the

⁵ Formerly known as IC (Industry Canada).

Approved antennas with the maximum permissible gain indicated. Antenna types not included in this list, having a gain greater than the maximum gain indicated for that type, are strictly prohibited for use with this device.



-  Operation in the band 5150–5250 MHz is only for indoor use to reduce the potential for harmful interference to co-channel mobile satellite systems.
-  Operation in the 5600-5650 MHz band is not allowed in Canada. High-power radars are allocated as primary users (i.e., priority users) of the bands 5250-5350 MHz and 5650-5850 MHz and that these radars could cause interference and/or damage to LE-LAN devices.

Le présent appareil est conforme aux CNR d'ISED applicables aux appareils radio exempts de licence. L'exploitation est autorisée aux deux conditions suivantes:

- (1) l'appareil ne doit pas produire de brouillage, et
- (2) l'utilisateur de l'appareil doit accepter tout brouillage radioélectrique subi, même si le brouillage est susceptible d'en compromettre le fonctionnement.

Cet équipement est conforme aux limites d'exposition de rayonnement d'ISED RSS-102 déterminées pour un environnement non contrôlé. Cet équipement devrait être installé et actionné avec la distance minimum 20 cm entre le radiateur et votre corps.

Cet émetteur radio, IC: 8595A-NORAW3 été approuvé par ISED pour fonctionner avec les types d'antenne énumérés ci-dessous avec le gain maximum autorisé et l'impédance nécessaire pour chaque type d'antenne indiqué. Les types d'antennes non inclus dans la liste des antennes approuvées et ayant un gain supérieur au gain maximum indiqué pour ce type sont strictement interdits pour une utilisation avec cet appareil.

-  Le dispositif de fonctionnement dans la bande 5150-5250 MHz est réservé à une utilisation en intérieur pour réduire le risque d'interférences nuisibles à la co-canal systèmes mobiles par satellite
-  Opération dans la bande 5600-5650 MHz n'est pas autorisée au Canada. Haute puissance radars sont désignés comme utilisateurs principaux (c.-à utilisateurs prioritaires) des bandes 5250-5350 MHz et 5650-5850 MHz et que ces radars pourraient causer des interférences et / ou des dommages à dispositifs LAN-EL.

The internal / external antenna(s) used for this module must provide a separation distance of at least 20 cm from all persons and must not be co-located or operating in conjunction with any other antenna or transmitter.

For ISED end-product labeling requirements, see [End product labeling requirements](#).

-  The approval type for all NORA-W30 series variants is a single modular approval. Due to ISED Modular Approval Requirements (Source: RSP-100 Issue 10), any application which includes the module must be approved by the module manufacturer (u-blox). The application manufacturer must provide design data for the review procedure.

6.4.3 Referring to the u-blox FCC/ISED certification ID

If the [General requirements](#), [FCC/ISED End-product regulatory compliance](#) and all [Antenna requirements](#) are met, the u-blox modular FCC/ISED regulatory authorization is valid and the end-product may refer to the u-blox FCC ID and ISED certification number. u-blox may be able to support updates to the u-blox regulatory authorization by adding new antennas to the u-blox authorization for example. See also [Antenna requirements](#).

-  To use the u-blox FCC / ISED grant and refer to the u-blox FCC ID / ISED certification ID, the integrator must confirm with u-blox that the all requirements associated with the software configuration and [Software configuration and control](#) are fulfilled.

6.4.4 Obtaining own FCC/ISED certification ID

Integrators who do not want to refer to the u-blox FCC/ISED certification ID, or who do not fulfil all requirements to do so may instead obtain their own certification. With their own certification, the integrator has full control of the grant to make changes.

Integrators who want to base their own certification on the u-blox certification can do so via a process called “Change in ID” (FCC) / “Multiple listing” (ISED). With this, the integrator becomes the grantee of a copy of the u-blox FCC/ISED certification. u-blox will support with an approval letter that shall be filed as a Cover Letter exhibit with the application.

-  It is the responsibility of the integrator to comply with any upcoming regulatory requirements.

6.4.5 Antenna requirements

In addition to the general requirement to use only authorized antennas, the u-blox grant also requires a separation distance of at least 20 cm from the antenna(s) to all persons. The antenna(s) must not be co-located with any other antenna or transmitter (simultaneous transmission) as well. If this cannot be met, a Permissive Change as described in [Adding a new antenna for authorization](#) must be made to the grant.

-  To support verification activities that may be required by certification laboratories, customers applying for Class-II Permissive changes must implement the setup described in [Software configuration and control](#).

6.4.5.1 Separation distance

If the required separation distance of 20 cm cannot be fulfilled, a SAR evaluation must be performed. This consists of additional calculations and/or measurements. The result must be added to the grant file as a Class II Permissive Change.

6.4.5.2 Co-location (simultaneous transmission)

If the module is to be co-located with another transmitter, additional measurements for simultaneous transmission are required. The results must be added to the grant file as a Class II Permissive Change.

6.4.5.3 Adding a new antenna for authorization

If the authorized antennas and/or antenna trace design cannot be used, the new antenna and/or antenna trace designs must be added to the grant file. This is done by a Class I Permissive Change or a Class II Permissive Change, depending on the specific antenna and antenna trace design.



- Antennas of the same type and with less or same gain as those included in the list of

- Approved antennas can be added under a Class I Permissive Change.
 - Antenna trace designs deviating from the u-blox reference design and new antenna types are added under a Class II Permissive Change.
 - For 5 GHz modules, the combined minimum gain of antenna trace and antenna must be greater than 0 dBi to comply with DFS testing requirements.
-  Integrators intending to refer to the u-blox FCC ID / ISED certification ID must [contact](#) their local support team to discuss the Permissive Change Process. Class II Permissive Changes are subject to NRE costs.

6.4.6 Software configuration and control

 “Modular transmitter” hereafter refers to NORA-W30 series (FCC ID XPYNORAW3).

As the end product must comply with the requirements addressed by the OET KDB 594280 [11], the host-product integrating the NORA-W30 must comply with the following requirements:

- Upon request from u-blox, the host-product manufacturer will provide all of the necessary information and documentation to demonstrate how the requirements listed below are met.
 - The host-product manufacturer will not modify the modular transmitter hardware.
 - The configuration of the modular transmitter when installed into the host-product must be within the authorization of the modular transmitter at all times and cannot be changed to include unauthorized modes of operation through accessible interfaces of the host-product. The [Wi-Fi transmit output power limits](#) must be followed. In particular, the modular transmitter installed in the host-product will not have the capability to operate on the operating channels/frequencies referred to in the section(s) below, namely the following channels: 12 (2467 MHz), 13 (2472 MHz)). The channels 120 (5600 MHz), 124 (5620 MHz), and 128 (5640 MHz) are allowed to be used in the US in client mode only. NORA-W30 use is certified as supporting DFS client functionality.
 - The host-product uses only authorized firmware images provided by the host-product manufacturer, u-blox, and/or by the manufacturer of the RF chipset used inside the modular transmitter.
 - The configuration of the modular transmitter must always follow the requirements specified in [Operating frequencies](#) and cannot be changed to include unauthorized modes of operation through accessible interfaces of the host-product.
 - The modular transmitter must when installed into the host-product have a regional setting that is compliant with authorized US modes and the host-product is protected from being modified by third parties to configure unauthorized modes of operation for the modular transmitter, including the country code.
 - The host-product into which the modular transmitter is installed does not provide any interface for the installer to enter configuration parameters into the end product that exceeds those authorized.
 - The host-product into which the modular transmitter is installed does not provide any interface to third parties to upload any unauthorized firmware images into the modular transmitter and prevents third parties from making unauthorized changes to all or parts of the modular transmitter device driver software and configuration.
-  OET KDB 594280 D01 [11] lists the topics that must be addressed to ensure that the end-product specific host meets the Configuration Control requirements.
-  OET KDB 594280 D02 [12] lists the topics that must be addressed to ensure that the end-product specific host meets the Software Security Requirements for U-NII Devices.

6.4.7 Operating frequencies

NORA-W30 802.11b/g/n operation outside the 2412–2462 MHz band is prohibited in the US and Canada and 802.11a/n operation in the 5600–5650 MHz band is prohibited in Canada. Configuration of the module to operate on channels 12–13 and 120–128 must be prevented accordingly.

The channels allowed while operating under the definition of a master or client device⁶ are described in [Table 14](#).

Channel number	Channel center frequency [MHz]	Master device	Client device	Remarks
1 – 11	2412 – 2462	Yes	Yes	
12 – 13	2467 – 2472	No	No	
36 – 48	5180 – 5240	Yes	Yes ⁷	Canada (ISED): Devices are restricted to indoor operation only and the end product must be labelled accordingly.
52 – 64	5260 – 5320	No	Yes	
100 – 116	5500 – 5580	No	Yes	
120 – 128	5600 – 5640	No	Yes	USA (FCC): Client device operation allowed under KDB 905462 Canada (ISED): Operation is prohibited in this band
132 – 144	5660 – 5720	No	Yes	
149 – 165	5745 – 5825	Yes	Yes ⁷	

Table 14: Allowed channel usage under FCC/ISED regulation

 15.407 (j) Operator Filing Requirement:
Before deploying an aggregate total of more than one thousand outdoor access points within the 5.15–5.25 GHz band, parties must submit a letter to the Commission acknowledging that, should harmful interference to licensed services in this band occur, they will be required to take corrective action. Corrective actions may include reducing power, turning off devices, changing frequency bands, and/or further reducing power radiated in the vertical direction. This material shall be submitted to Laboratory Division, Office of Engineering and Technology, Federal Communications Commission, 7435 Oakland Mills Road, Columbia, MD 21046. Attn: U-NII Coordination, or via Web site at <https://www.fcc.gov/labhelp> with the subject line: “U-NII-1 Filing”.

6.4.8 End product labeling requirements

For an end-product using the NORA-W30, there must be a label containing, at least, the following information:

This device contains
FCC ID: XPNORAW3
IC: 8595A-NORAW3

“XPY” represents the FCC “Grantee Code” for u-blox AG, this code may consist of Arabic numerals, capital letters, or other characters, the format for this code will be specified by the Commission's Office of Engineering and Technology⁸. “8595A” is the Company Number for u-blox AG registered at ISED. “NORAW3” is the Unique Product Number decided by the grant owner.

The label must be affixed to an exterior surface of the end product such that it will be visible upon inspection in compliance with the modular labeling requirements of OET KDB 784748. The host user

⁶ 47 CFR §15.202

⁷ DFS certification pending

⁸ 47 CFR 2.926

manual must also contain clear instructions on how end users can find and/or access the FCC ID of the end product.

The label on the NORA-W30 module containing the original FCC ID acquired by u-blox can be replaced with a new label stating the end-product's FCC/ISED ID in compliance with the modular labeling requirements of OET KDB 784748.

FCC end product labeling

In accordance with 47 CFR § 15.19, the end product shall bear the following statement in a conspicuous location on the device:

Contains FCC ID: XPNORAW3

This device complies with part 15 of the FCC rules. Operation is subject to the following two conditions:

1. This device may not cause harmful interference, and
2. This device must accept any interference received, including interference that may cause undesired operation.

The following statement must be included in the end-user manual or guide:

Changes or modifications to this unit not expressly approved by the party responsible for compliance could void the user's authority to operate the equipment.

This equipment has been tested and found to comply with the limits for a Class B digital device, pursuant to part 15 of the FCC Rules. These limits are designed to provide reasonable protection against harmful interference in a residential installation. This equipment generates uses and can radiate radio frequency energy and, if not installed and used in accordance with the instructions, may cause harmful interference to radio communications. However, there is no guarantee that interference will not occur in a particular installation. If this equipment does cause harmful interference to radio or television reception, which can be determined by turning the equipment off and on, the user is encouraged to try to correct the interference by one or more of the following measures:

- Reorient or relocate the receiving antenna.
- Increase the separation between the equipment and receiver.
- Connect the equipment into an outlet on a circuit different from that to which the receiver is connected.
- Consult the dealer or an experienced radio/TV technician for help.

ISED end product labeling

The end product shall bear the following statement in both English and French in a conspicuous location on the device:

Contains transmitter module IC: 8595A-NORAW3

This device contains licence-exempt transmitter(s)/receiver(s) that comply with Innovation, Science and Economic Development Canada's licence-exempt RSS(s). Operation is subject to the following two conditions:

1. This device may not cause interference.
2. This device must accept any interference, including interference that may cause undesired operation of the device.

Contient le module émetteur IC: 8595A-NORAW3

L'émetteur/récepteur exempt de licence contenu dans le présent appareil est conforme aux CNR d'Innovation, Sciences et Développement économique Canada applicables aux appareils radio exempts de licence. L'exploitation est autorisée aux deux conditions suivantes:

1. L'appareil ne doit pas produire de brouillage;
2. L'utilisateur de l'appareil doit accepter tout brouillage radioélectrique subi, même si le brouillage est susceptible d'en compromettre le fonctionnement.

Labels of end products capable of operating within the band 5150–5250 MHz shall also include:

For indoor use only

Pour usage intérieur seulement

When the device is so small or for such use that it is not practicable to place the statements above on it, the information shall be placed in a prominent location in the instruction manual or pamphlet supplied to the user or, alternatively, shall be placed on the container in which the device is marketed. However, the FCC/ISED ID label must be displayed on the device as described above.

In cases where the final product will be installed in locations where the end-consumer is unable to see the FCC/ISED ID and/or this statement, the FCC/ISED ID and the statement shall also be included in the end-product manual.

6.5 Japan radio equipment compliance (pending)

Use of 2.4 GHz channel 14 is supported for Japanese markets.

6.5.1 Compliance statement

NORA-W30 series modules comply with the Japanese Technical Regulation Conformity Certification of Specified Radio Equipment (ordinance of MPT N°. 37, 1981), Article 2, Paragraph 1:

- Item 19 "2.4 GHz band wide band low power data communication system".
- Item 19-3 "Low power data communications system in the 5.2/5.3 GHz band"
- Item 19-3-2 "Low power data communications system in the 5.6 GHz band"

The NORA-W30 series module is restricted on the Japanese market to be used indoors only if the product is operating in the 5.2/5.3 GHz band.

Table 15 shows the Giteki certification IDs allocated to NORA-W30 series modules.

Model	Giteki ID
NORA-W300	MIC ID: R xxx-xxxxxx, MIC ID: T yyyyyyyyyy
NORA-W301	MIC ID: R xxx-xxxxxx, MIC ID: T yyyyyyyyyy
NORA-W306	MIC ID: R xxx-xxxxxx, MIC ID: T yyyyyyyyyy

Table 15: Giteki IDs for different variants of NORA-W30 series modules

6.5.2 End product labelling requirement

End products based on NORA-W30 series modules and targeted for distribution in Japan must be affixed with a label with the "Giteki" marking, as shown in Figure 12. The "Indoor use only" information translated into Japanese below is mandatory if the product is operating in the 5.2/5.3 GHz band. The product marking must be visible for inspection.

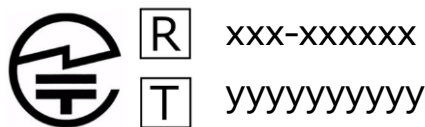

Figure 12: Giteki R and T marks with the NORA-W30 MIC certification numbers

6.5.3 End product user manual requirement

As the MIC ID is not included on the NORA-W30 marking, the end product manufacturer must include a copy of the NORA-W30 Japan Radio Certificate in the end product technical documentation.

6.6 KCC South Korea compliance (pending)

NORA-W30 series modules are certified by the Korea Communications Commission (KCC).

End products based on NORA-W30 series modules and targeted for distribution in South Korea must carry labels containing the KCC logo and certification number, as shown below. This information must also be included in the product user manuals.

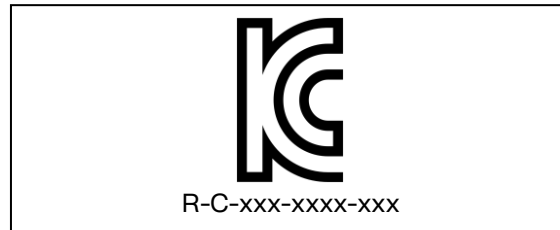

Figure 13: Sample label of an end product that includes NORA-W30

The height of the KCC logo must be at least 5 mm.

6.7 NCC Taiwan compliance

6.7.1 Taiwan NCC warning statement

[警語內容]

取得審驗證明之低功率射頻器材，非經核准，公司、商號或使用者均不得擅自變更頻率、加大功率或變更原設計之特性及功能。

低功率射頻器材之使用不得影響飛航安全及干擾合法通信；經發現有干擾現象時，應立即停用，並改善至無干擾時方得繼續使用。前述合法通信，指依電信管理法規定作業之無線電通信。低功率射頻器材須忍受合法通信或工業、科學及醫療用電波輻射性電機設備之干擾。

應避免影響附近雷達系統之操作。

系統廠商應於平台上標示「本產品內含射頻模組：CCXXXYYyyyZzW」字樣

Statement translation:

[Warning content]

- Without permission granted by the NCC, any company, enterprise, or user is not allowed to change frequency, enhance transmitting power, or alter original characteristic as well as performance to an approved low power radio-frequency device.
- The low power radio-frequency devices shall not influence aircraft security and interfere legal communications; If any interference is found or suspected, the user shall immediately cease operating the equipment until the interference has been prevented. The said legal communications means radio communications is operated in compliance with the Telecommunications Act. The low power radio-frequency devices must accept interference from legal communications or ISM radio wave radiated devices.
- When operating this device, avoid affecting the operation of nearby radar systems

6.7.2 Labeling requirements for end product

End products based on NORA-W30 series modules and targeted for distribution in Taiwan must carry labels with the textual and graphical elements shown below.

For NORA-W300:

Contains Transmitter Module

內含發射器模組:  CCXXXYYyyyZzW

Figure 14: Labeling for end-products containing NORA-W300

For NORA-W301:

Contains Transmitter Module

內含發射器模組:  CCXXXYYyyyZzW

Figure 15: Labeling for end-products containing NORA-W301

For NORA-W306:

Contains Transmitter Module

內含發射器模組:  CCXXXYYyyyZzW

Figure 16: Labeling for end-products containing NORA-W306

Other wording can be used, but only if the meaning of original messaging remains unchanged. The label must be physically attached to the product and made clearly visible for inspection.

6.8 Brazil compliance (pending)

End products based on NORA-W30 series modules and targeted for distribution in Brazil must carry labels that include the Anatel logo, NORA-W30 Homologation number 11149-22-05903 and a statement claiming that the device may not cause harmful interference but must accept it (Resolution No 506).



“Este equipamento opera em caráter secundário, isto é, não tem direito a proteção contra interferência prejudicial, mesmo de estações do mesmo tipo, e não pode causar interferência a sistemas operando em caráter primário.”

Statement translation:

“This equipment operates on a secondary basis and, consequently, must accept harmful interference, including from stations of the same kind, and may not cause harmful interference to systems operating on a primary basis.”

When the device is so small or for such use that it is not practicable to place the statement above on the label, the information shall be placed in a prominent location in the instruction manual or pamphlet supplied to the user or, alternatively, shall be placed on the packaging in which the device is marketed.

In cases where the final product is to be installed in locations where the end user is unable to see the Anatel logo, NORA-W30 Homologation number and/or statement, these graphical and textual elements must be included in the end product manual.

6.9 Australia and New Zealand regulatory compliance (pending)



NORA-W30 modules are compliant with the standards made by the Australian Communications and Media Authority (ACMA).

The modules are compliant with AS/NZS 4268:2012 standard – Radio equipment and systems – Short range devices – Limits and methods of standard measurement. The test reports for NORA-W30 modules can be used as part of the product certification and compliance folder. [Contact](#) your local support team for more information.

To meet the overall Australian and/or New Zealand end product compliance standards, the integrator must create a compliance folder containing all the relevant compliance test reports such as RF, EMC, electrical safety and DoC (Declaration of Conformity). It is the responsibility of the integrator to know what is required in the compliance folder for ACMA compliance.

For more information on Australia compliance, refer to the Australian Communications and Media Authority web site <http://www.acma.gov.au/>.

For more information on New Zealand compliance, refer to the New Zealand Radio Spectrum Management Group web site www.rsm.govt.nz.

6.10 South Africa regulatory compliance (pending)

NORA-W30 series modules are compliant and certified by the Independent Communications Authority of South Africa (ICASA). End products that are made available for sale or lease or supplied in any other manner in South Africa shall have a legible label permanently affixed to its exterior surface. The label shall include the ICASA logo and the ICASA issued license number, as shown in the figure below. The minimum width and height of the ICASA logo shall be 3 mm. The approval labels must be purchased by the customer's local representative directly from the approval authority ICASA.

A sample of a NORA-W30 ICASA label is shown below:



More information on registration as a Responsible Integrator and labeling requirements can be found at the following website:

Independent Communications Authority of South Africa (ICASA) web site - <https://www.icasa.org.za>

6.11 Approved antennas



6.11.1 Antenna accessories

Name	U.FL to Reverse Polarity SMA adapter cable	
Applicable modules	NORA-W361	
	For information about how to integrate the U.FL connector with the NORA-W361 ANT pin, see also NORA-W361 U.FL reference design . It is necessary to follow this reference design to comply with the NORA-B1 FCC/ISED modular approvals.	
Connector	U.FL and Reverse Polarity SMA jack (outer thread and pin)	
Impedance	50 Ω	
Minimum cable loss	0.5 dB, The cable loss must be above the minimum cable loss to meet the regulatory requirements. Minimum cable length 100 mm.	
Comment	The Reverse Polarity SMA connector can be mounted in a panel.	
Approval ⁹	FCC, ISED, RED, UKCA, MIC, KCC, ANATEL, RCM, NCC, and ICASA	

6.11.2 Pre-approved antenna list

The following antennas are approved for use with NORA-W36:

(Antennas and gain values are subject to change pending approvals)

NORA-W366		
Manufacturer	u-blox AG, licensed from Abracon	
Gain ¹⁰	+0.5 dBi (2.4 GHz), 2.4 dBi (5 GHz)	
Impedance	N/A	
Size (HxWxL)	1.1 x 3.4 x 10 mm	
Type	PCB trace	
Comment	PCB antenna on NORA-W366. Should not be mounted inside a metal enclosure.	
Approval ⁹	FCC, ISED, RED, UKCA, MIC, KCC, ANATEL, RCM, NCC, and ICASA	
GW.59.3153		
Manufacturer	Taoglas	
Gain ¹⁰	3.8 dBi (2.4 GHz), 3.2 dBi (5 GHz)	
Impedance	50 Ω	
Size (HxDIA)	156 x Ø13 mm	
Type	Hinged dipole whip	
Comment	This antenna must be mounted on a metal ground plane for best performance. It should be mounted on the U.FL to Reverse Polarity SMA adapter cable listed in Antenna accessories .	
Approval ⁹	FCC, ISED, RED, UKCA, MIC, KCC, ANATEL, RCM, NCC, and ICASA	

⁹ Approvals pending

¹⁰ Measured with EVK-NORA-W30

AFG4507W2S-0200S

Manufacturer	Abracon
Gain ¹¹	3.5 dBi (2.4 GHz), 5.3 dBi (5 GHz)
Impedance	50 Ω
Size (HxWxL)	45.0 x 7.8 x 0.2 mm
Type	Flat patch
Comment	For best performance, the antenna should be attached to a plastic enclosure or part. To be connected to a U.FL connector.
Approval ¹²	FCC, ISED, RED, UKCA, MIC, KCC, ANATEL, RCM, NCC, and ICASA

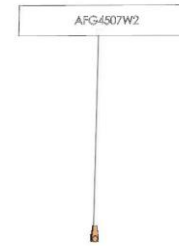
ANTX100P001B24553

Manufacturer	Pulse Electronics / Yageo
Gain ¹¹	5.3 dBi (2.4 GHz), 4.6 dBi (5 GHz)
Impedance	50 Ω
Size (HxWxL)	50 x 10 x 2.3 mm
Type	PCB patch
Comment	Should be attached to a plastic enclosure or part for best performance. To be connected to a U.FL connector.
Approval ¹²	FCC, ISED, RED, UKCA, MIC, KCC, ANATEL, RCM, NCC, and ICASA

ANT-DB1-RAF-RPS

Manufacturer	Linx Technologies, Inc.
Gain	4.1 dBi (2.4 GHz), 5.1 dBi (5 GHz)
Impedance	50 Ω
Size (HxDIA)	103.7 x Ø11.2 mm
Type	Hinged blade whip
Connector	RP-SMA
Comment	This antenna requires to be mounted on a metal ground plane for best performance. It should be mounted on the U.FL to Reverse Polarity SMA adapter cable listed in Antenna accessories .
Approval	FCC, ISED: approved for Bluetooth LE use only

¹¹ Measured with EVK-NORA-W30

¹² Approvals pending

7 Product testing

7.1 u-blox in-line production test

As part of our focus on high quality products, u-blox maintain stringent quality controls throughout the production process. This means that all units in our manufacturing facilities are fully tested and that any identified defects are carefully analyzed to improve future production quality.

The Automatic test equipment (ATE) deployed in u-blox production lines logs all production and measurement data – from which a detailed test report for each unit can be generated.

Figure 17 shows the ATE typically used during u-blox production.

u-blox in-line production testing includes:

- Digital self-tests (firmware download, MAC address programming)
- Measurement of voltages and currents
- Functional tests (host interface communication)
- Digital I/O tests
- Measurement and calibration of RF characteristics in all supported bands, including RSSI calibration, frequency tuning of reference clock, calibration of transmitter power levels, etc.
- Verification of Wi-Fi and Bluetooth RF characteristics after calibration, like modulation accuracy, power levels, and spectrum, are checked to ensure that all characteristics are within tolerance when the calibration parameters are applied.



Figure 17: Automatic test equipment for module test

7.2 OEM manufacturer production test

As all u-blox products undergo thorough in-series production testing prior to delivery, OEM manufacturers do not need to repeat any firmware tests or measurements that might otherwise be necessary to confirm RF performance. Testing over analog and digital interfaces is also unnecessary during an OEM production test.

OEM manufacturer testing should ideally focus on:

- Module assembly on the device; it should be verified that:
 - Soldering and handling process did not damage the module components
 - All module pins are well soldered on device board
 - There are no short circuits between pins
- Component assembly on the device; it should be verified that:
 - Communication with host controller can be established
 - The interfaces between module and device are working
 - Overall RF performance test of the device including antenna

In addition to this testing, OEMs can also perform other dedicated tests to check the device. For example, the measurement of module current consumption in a specified operating state can identify a short circuit if the test result deviates from that taken against a “Golden Device”.

The standard operational module firmware and test software on the host can be used to perform functional tests (communication with the host controller, check interfaces) and perform basic RF performance testing. Special manufacturing firmware can also be used to perform more advanced RF performance tests.

7.2.1 “Go/No go” tests for integrated devices

A “Go/No go” test compares the signal quality of the Device under Test (DUT) with that of “Golden Device” in a location with a known signal quality. This test can be performed after establishing a connection with an external device.

A very simple test can be performed by just scanning for a known Bluetooth low energy device and checking that the signal level (Received Signal Strength Indicator (RSSI)) is acceptable.

 Tests of this kind may be useful as a “go/no go” test but are not appropriate for RF performance measurements.

Go/No go tests are suitable for checking communication between the host controller and the power supply. The tests can also confirm that all components on the DUT are well soldered.

A basic RF functional test of the device that includes the antenna can be performed with standard Bluetooth low energy devices configured as remote stations. In this scenario, the device containing NORA-W30 and the antennas should be arranged in a fixed position inside an RF shield box. The shielding prevents interference from other possible radio devices to ensure stable test results.

Appendix

A Wi-Fi transmit output power limits

A.1 FCC / ISED regulatory domain

Table 16 through Table 20 list the maximum allowable conducted¹³ output power limits for operation in the FCC/ISED regulatory domains.

A.1.1 Wi-Fi output power for 2.4 GHz band

The output power limits are applicable with an external antenna gain of 5.3 dBi.

Mode	Channel(s)	Maximum power setting (NORA-W300 and NORA-W301)	Maximum power setting (NORA-W306)
802.11b, CCK/DSSS	1, 11	17.5 dBm	17.5 dBm
	2, 10	17.5 dBm	19 dBm
	3 - 9	20 dBm	20 dBm
802.11g, OFDM	1, 11	11.5 dBm	15 dBm
	2, 10	15 dBm	16.5 dBm
	3 - 9	18 dBm	19 dBm
802.11n, HT20	1, 11	11 dBm	13 dBm
	2, 10	15 dBm	16.5 dBm
	3 - 9	18 dBm	18 dBm
802.11n, HT40	3 - 4	10 dBm	11 dBm
	5 - 6	12 dBm	14 dBm
	7	11 dBm	13 dBm
	8 - 9	9 dBm	11 dBm

Table 16: FCC / ISED Wi-Fi power table for operation in the 2.4 GHz band

A.1.2 FCC Wi-Fi output power for 5 GHz band

The output power limits are applicable with an external antenna gain of 5.3 dBi.

Mode	Channel(s)	Maximum power setting
802.11a, OFDM	36, 64, 100, 104	16 dBm
	40, 56, 60	17 dBm
	44, 48, 149 - 165	18 dBm
	116 - 136	15.5 dBm
	140, 144	14 dBm
802.11n, HT20	36 - 48, 52 - 60, 108 - 112, 149 - 165	16 dBm
	64, 100, 104	15.5 dBm
	116 - 136	15 dBm
	140, 144	14.5 dBm
802.11n, HT40	38, 62, 142	14.5 dBm
	46, 54, 110 - 134, 151, 159	16 dBm
	102, 134	15.5 dBm

Table 17: FCC Wi-Fi power table for operation in the 5 GHz bands

¹³ Output power at the antenna connector, without antenna gain.

A.1.3 ISED Wi-Fi output power for 5 GHz band

The output power limits are applicable with an external antenna gain of 5.3 dBi.

Mode	Channel(s)	Maximum power setting
802.11a, OFDM	36 – 48, 64, 116, 144	13 dBm
	52 – 60	13.5 dBm
	100	12.5 dBm
	104 – 112, 128 - 140	14 dBm
	149 - 165	18 dBm
802.11n, HT20	36 – 48, 64, 116, 144	13 dBm
	52 – 60	13.5 dBm
	100	12.5 dBm
	104 – 112, 128 - 140	14 dBm
	149 - 165	18 dBm
802.11n, HT40	38, 46	16 dBm
	54, 62	13.5 dBm
	102	12.5 dBm
	110, 134, 142	14 dBm
	151, 159	16 dBm

Table 18: ISED Wi-Fi power table for operation in the 5 GHz bands

A.1.4 FCC Wi-Fi output power for 5 GHz band

Mode	Channel(s)	Maximum power setting
802.11a, OFDM	36 – 48, 52 – 60, 157	17 dBm
	64, 100, 136, 149, 153	16 dBm
	104 – 132, 161, 165	18 dBm
	140	14 dBm
802.11n, HT20	36 – 48, 52 – 60, 104 – 136, 149 – 165	16 dBm
	64, 100	15 dBm
	140	14 dBm
802.11n, HT40	38, 62	14 dBm
	46, 54, 110 – 126, 151, 159	16 dBm
	102, 134	13 dBm

Table 19: FCC Wi-Fi power table for operation in the 5 GHz bands

A.1.5 FCC Wi-Fi output power for 5 GHz band

Mode	Channel(s)	Maximum power setting
802.11a, OFDM	36 – 48, 52 – 60, 157	17 dBm
	64, 100, 136, 149, 153	16 dBm
	104 – 132, 161, 165	18 dBm
	140	14 dBm
802.11n, HT20	36 – 48, 52 – 60, 104 – 136, 149 – 165	16 dBm
	64, 100	15 dBm
	140	14 dBm
802.11n, HT40	38, 62	14 dBm
	46, 54, 110 – 126, 151, 159	16 dBm
	102, 134	13 dBm

Table 20: FCC Wi-Fi power table for operation in the 5 GHz bands

A.2 RED and UKCA regulatory domains

Table 21 and Table 22 list the maximum allowable conducted¹³ output power limits for operation in the RED and UKCA regulatory domains.

A.2.1 Wi-Fi output power for 2.4 GHz band

The output power limits are applicable with an external antenna gain of 3.5 dBi.

Mode	Channel(s)	Maximum power setting
802.11b, CCK/DSSS	1 – 13	12 dBm
802.11g, OFDM	1 – 13	15 dBm
802.11n, HT20	1 – 13	15 dBm
802.11n, HT40	3 – 11	17 dBm

Table 21: RED Wi-Fi power table for operation in the 2.4 GHz band

A.2.2 Wi-Fi output power for 5 GHz band

The output power limits are applicable with an external antenna gain of 5.3 dBi.

Mode	Channel(s)	Maximum power setting
802.11a, OFDM	36 – 64	14.5 dBm
	52 – 60, 124 – 140	14 dBm
	64, 100 – 120	13.5 dBm
	149 – 165	8 dBm
802.11n, HT20	36 – 64	14.5 dBm
	52 – 60, 124 – 140	14 dBm
	64, 100 – 120	13.5 dBm
	149 – 165	8 dBm
802.11n, HT40	38 – 46	14.5 dBm
	54, 62, 126, 134	14 dBm
	102 – 118	13.5 dBm
	151, 159	8 dBm

Table 22: RED Wi-Fi power table for operation in the 5 GHz bands

B Reference trace design (NORA-W3x1 only)

Designers can take full advantage of the NORA-W3 Single-Modular Transmitter certification approval for NORA-W3x1 by integrating the u-blox reference design described in this appendix into their products. This approach requires compliance with the following rules:

- Only listed antennas can be used. Refer to [Approved antennas](#) for the listed antennas.
- Schematics and parts used in the design must be identical to the reference design. Use only parts validated by u-blox for antenna matching.
- PCB layout of the RF section must be identical to the one provided by u-blox. The reference design described in this section must be used.
- The designer must use the four-layer PCB stack-up provided by u-blox. RF traces on the carrier PCB are part of the certified design.

The reference design uses a U.FL micro-coaxial connector to connect the external antenna via a 50 Ω coaxial cable. [Figure 18](#) shows the placement of the connector in relation and module footprint. The components connected to the RF trace must be kept as shown in the reference design.

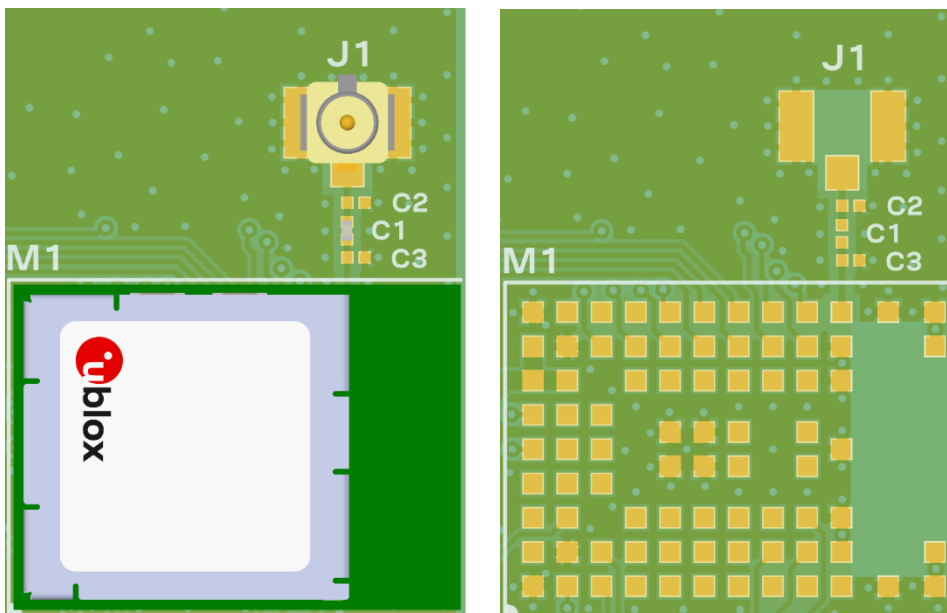

Figure 18: U.FL connector placement (left) and module footprint (right)

- The layout used for certification accommodated any of the variants of NORA-W3. A keep-out is present under the NORA-W3 module to accommodate the NORA-W3x6 variant. When used with a NORA-W3x1, the keep-out under the module is not required. See [Figure 19](#).

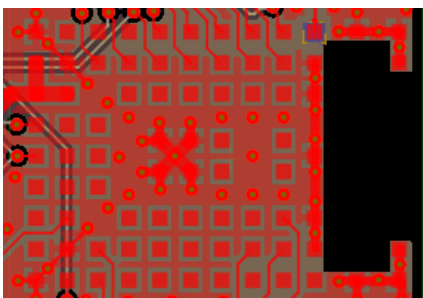

Figure 19: NORA-W3x6 keepout – not required for NORA-W3x1

B.1 Floor plan

Figure 20 shows the critical components and positioning of the copper traces in the reference design. The itemized references are described in Table 23.

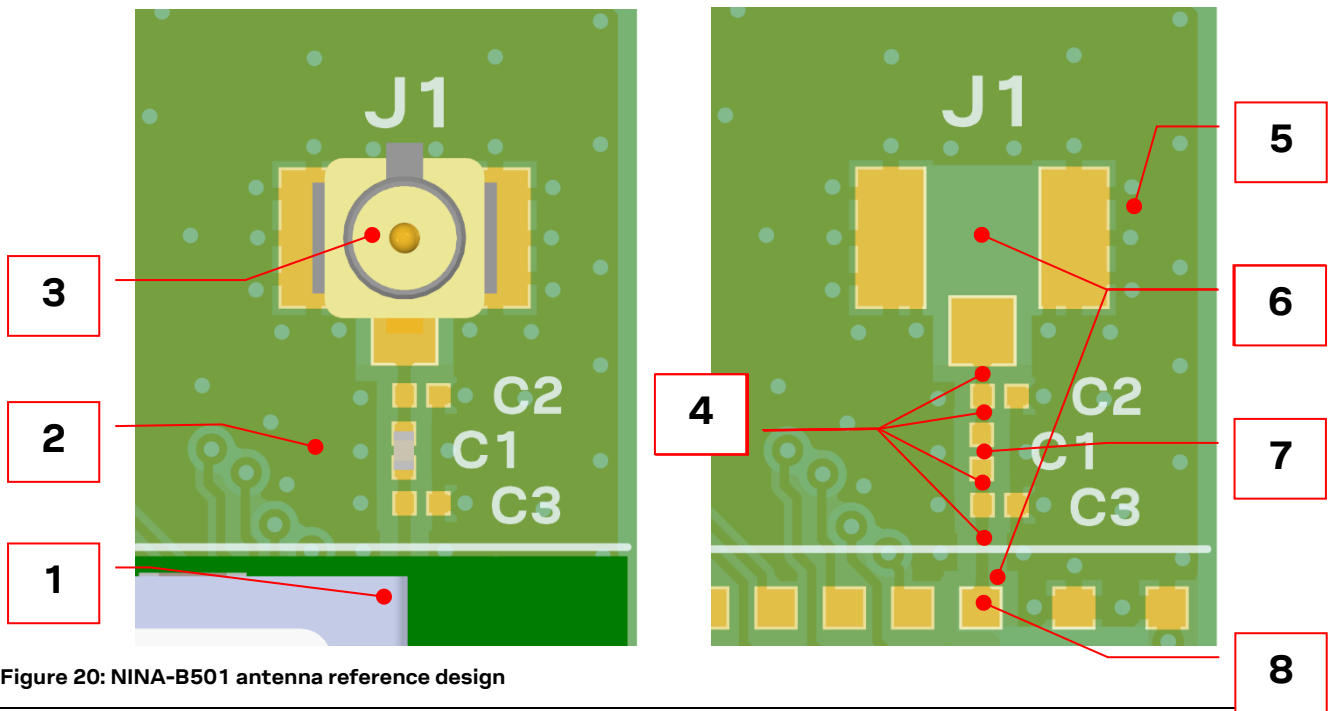

Figure 20: NINA-B501 antenna reference design

Reference	Part	Manufacturer	Description
1	NORA-W3x1	u-blox	NORA-W3 module with antenna pin
2	Carrier PCB		Must have a solid GND inner second and third layers underneath and around the RF components (vias and small openings are allowed). See Figure 22 and Figure 23 for copper keep-out requirements.
3	U.FL-R-SMT-1(10)	Hirose	Coaxial connector, 0 – 6 GHz, for external antenna
4	RF trace		Antenna coplanar microstrip, matched to 50 Ω
5	GND copper pour		Minimum required top layer ground pour. Minimum 1.3 mm surrounding U.FL connector and RF traces
6	Copper keep-out		Keep this area free from any copper on the top and second layers See Figure 22 and Figure 23 for additional requirements.
7	GRM0335C1H100GA01	Murata	C1: Size 0201, 10 pF COG RF matching capacitor  C2 and C3 are not populated
8	RF pin		RF pin on NORA-W3 footprint.

Table 23: Antenna reference design – item descriptions

B.2 RF trace specification and PCB stack-up

The RF trace is a 50 Ω coplanar micro-strip using the dimensions layer stack-up described in [Table 25](#).

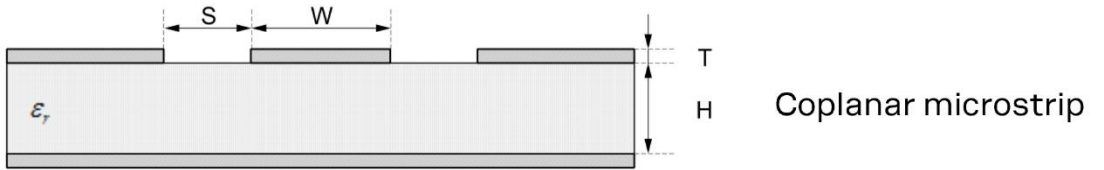

Figure 21: Coplanar micro-strip dimensions

Reference	Item	Value
S	Spacing	300 ± 50 μm
W	Conductor width	195 ± 30 μm (match as close to 50 Ω as possible)
T	Copper and plating/surface coating thickness	35 ± 15 μm
H	Conductor height	See Table 25
ϵ_r	Dielectric constant (relative permittivity)	See Table 25

Table 24: Coplanar micro-strip dimensions for top layer only

Layer	Name	Material	Type	Weight	Thickness (μm)	Dielectric constant
	Top overlay	Overlay	Overlay			
	Top soldermask	Solder resist	Solder mask		12.7	3.5
1	Layer 1	Copper	Signal	1 oz	35	
	Dielectric 1	Composite dielectric	Prepreg		110	4.29
2	Layer 2	Copper	Signal	1 oz	35	
	Core	Composite dielectric	Core		1200	4.29
3	Layer 3	Copper	Signal	1 oz	35	
	Dielectric 3	Composite dielectric	Prepreg		110	4.29
4	Layer 4	Copper	Signal	1 oz	35	
	Bottom soldermask	Solder resist	Solder mask		12.7	3.5
	Bottom overlay	Overlay	Overlay			

Table 25: Carrier PCB stack-up

B.2.1 Ground stitching vias

Immediately beyond the micro-strip spacing, a series of ground stitching vias is required directly surrounding RF components and traces. Figure 22 shows the minimum arrangement of stitching vias. Additional ground stitching vias are recommended.

B.2.2 Keep out areas

There are keep-out areas on layers 1 and 2, around the U.FL connector and RF pin of the NORA-W3x1 module. The micro-strip spacing accounts for the layer 1 keep-out around the module RF pin. The U.FL connector requires that there be no copper underneath. See [Figure 22](#).

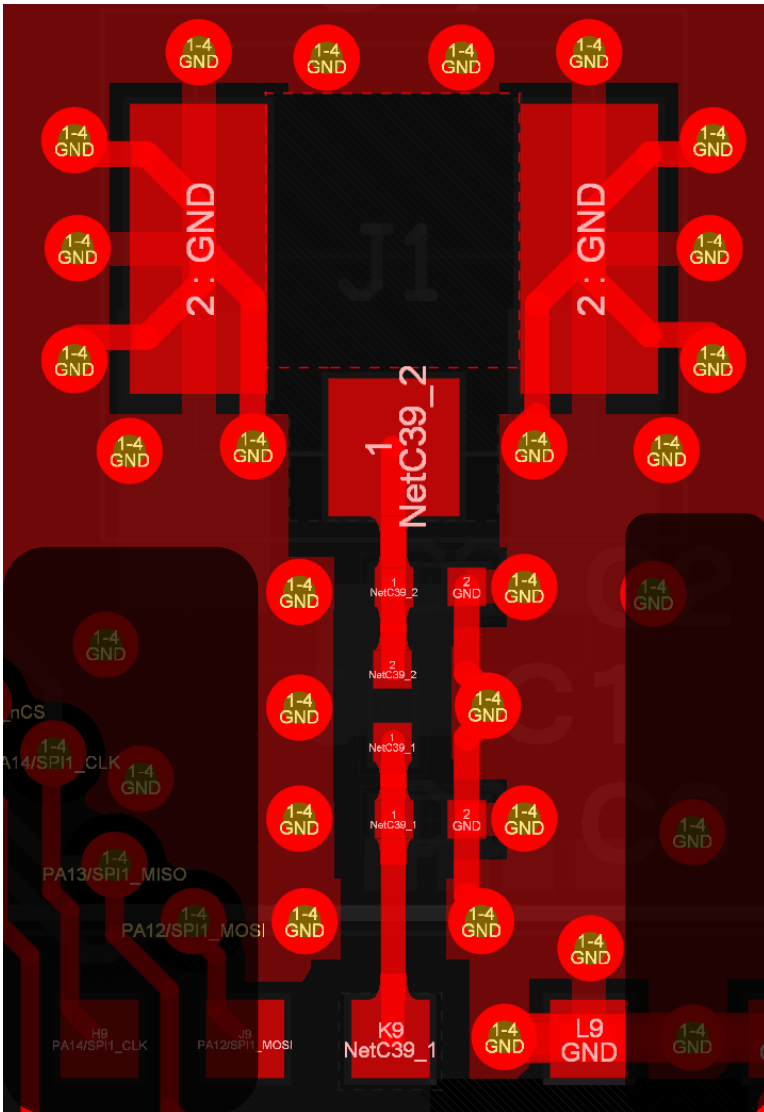

Figure 22: Layer 1 routing, keep-out, and ground stitching vias

On layer 2, the keep-out under the U.FL is duplicated, including the spacing around the U.FL RF pad on layer 1. Also on layer 2, a keep-out under the RF pad of the NORA-W3x1 module is required. See [Figure 23](#).

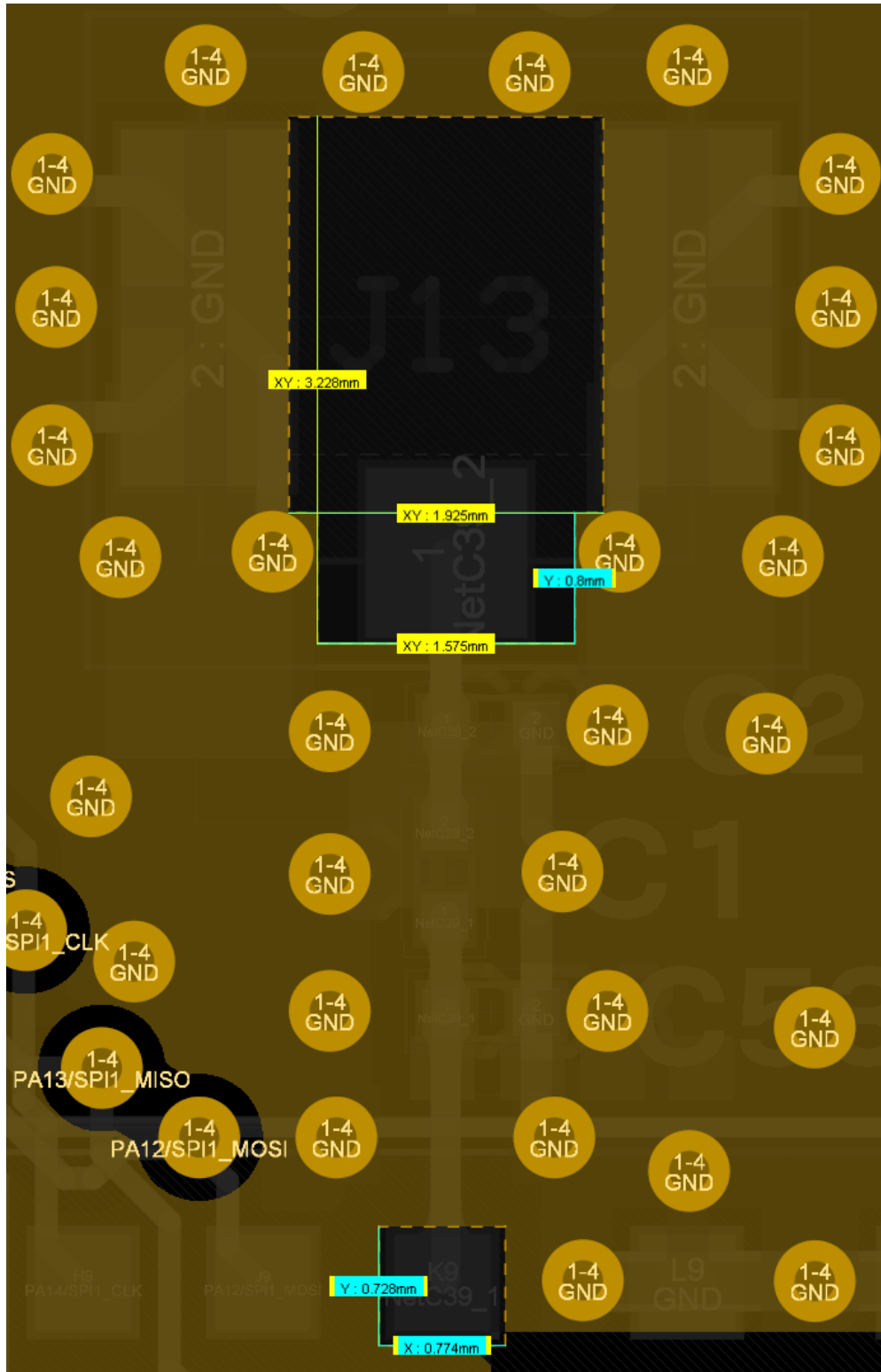

Figure 23: Layer 2 keep-out areas

Layer 3 must be a solid ground plane in this area.

Layer 4 is available for signal routing.

B.2.3 Component placement

In addition to the U.FL connector and module RF pin, three size 0201 component locations are included in the trace design, designated as C1, C2 and C3. Only C1, the series capacitor, is populated. The C2 and C3 locations are necessary to match the trace design as it was certified and are not to be populated. Figure 24 shows measurements between the centers of each of the pads in the RF path.

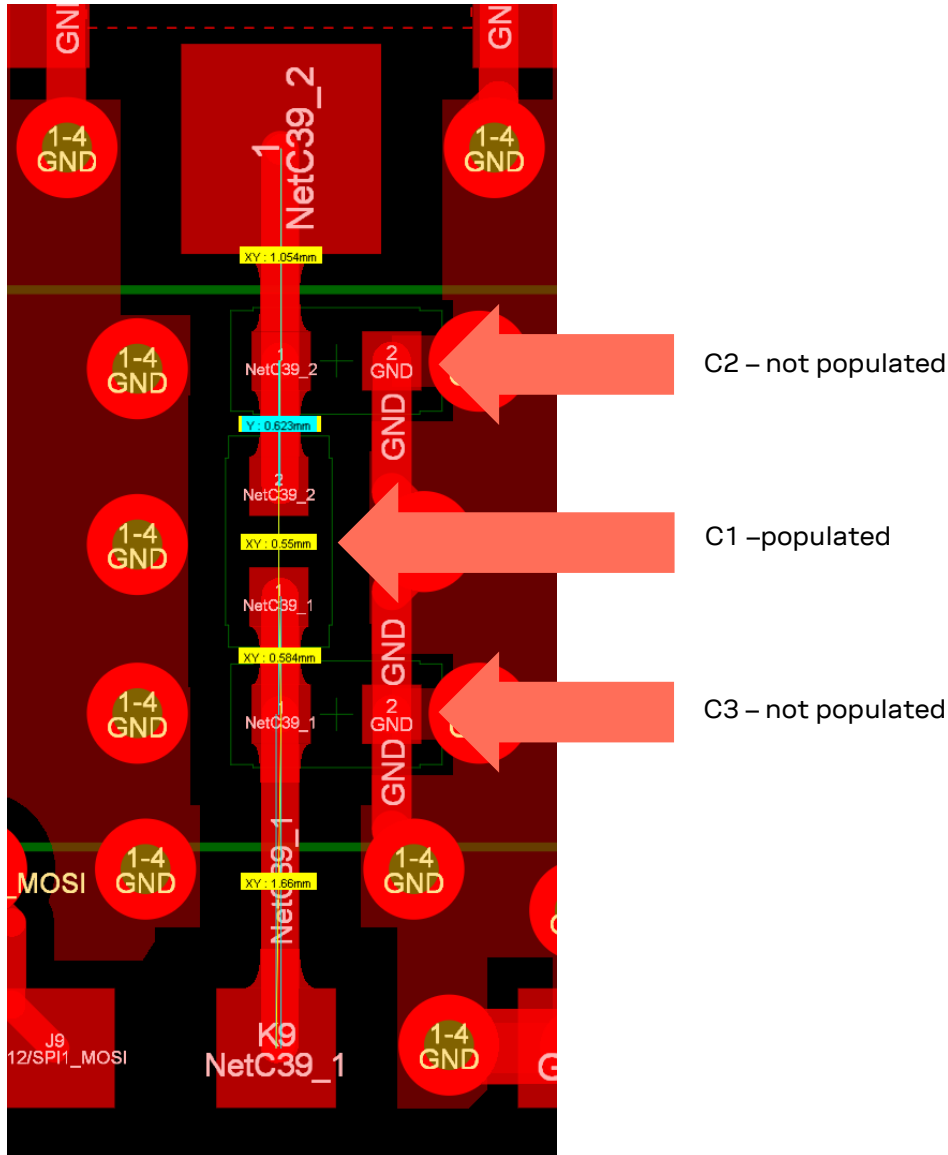

Figure 24: RF trace design component placement

C Glossary

Abbreviation	Definition
ASCII	American Standard Code for Information Interchange
ADC	Analog to Digital Converter
AON	Always ON
ARM	Arm (Advanced RISC Machines) Holdings
ATE	Automatic Test Equipment
CPU	Central Processing Unit
DCE	Data Circuit-terminating Equipment* / Data Communication Equipment*
DDR	Double Data Rate
DUT	Device Under Test
EMC	ElectroMagnetic Compatibility
EMI	ElectroMagnetic Interference
ESD	ElectroStatic Discharge
FCC	Federal Communications Commission (United States)
GATT	Generic Attribute
GPIO	General Purpose Input / Output
GUI	Graphical User Interface
I2C	Inter-Integrated Circuit
I2S	Inter-IC Sound
IDE	Integrated Development Environment
ISED	Innovation, Science, and Economic Development (Canada)
KDB	Knowledge DataBase (of the FCC)
KM0	RTL8720DF MCU low power Arm Cortex M23 compatible core
KM4	RTL8720DF MCU main application Arm Cortex M33 compatible core
LDO	Low Drop-Out
LE	Low Energy
LGA	Land Grid Array
MAC	Media Access Control
MCU	MicroController Unit
MSL	Moisture Sensitivity Level
NMSD	Non-Solder Mask Defined
OEM	Original Equipment Manufacturer
OET	Office of Engineering and Technology (of the FCC)
OTP	One-Time Programmable
PCB	Printed Circuit Board
PCBA	Printed Circuit Board Assembly
PWM	Pulse Width Modulation
Q-Decoder (also QDEC)	Quadrature Decoder
RAM	Random Access Memory
RF	Radio Frequency
RTC	Real-Time Clock
SDK	Software Development Kit
SMPS (also SPS)	Switch Mode Power Supply
SMA	SubMiniature version A connector

Abbreviation	Definition
SMT	Surface Mount Technology
SPI	Serial Peripheral Interface
TBC	To Be Confirmed
THT	Through-Hole Technology
TLS	Transport Layer Security
UART	Universal Asynchronous Receiver Transmitter
USI	Universal Serial Interface (see I2C, SPI, and UART)
VSWR	Voltage Standing Wave Ratio
WPA	Wi-Fi Protected Access

Table 26: Explanation of the abbreviations and terms used

Related documentation

- [1] Package information guide, [UBX-14001652](#)
- [2] NORA-W30 data sheet, [UBX-22021117](#)
- [3] Realtek [data sheet](#) (registration required)
- [4] Realtek user manual (registration required)
- [5] Realtek [application note](#) (registration required)
- [6] JEDEC: Moisture/Reflow Sensitivity Classification for Nonhermetic Solid State Surface Mount Devices, [J-STD-020E](#)
- [7] IEC: Electromagnetic compatibility (EMC) - Part 4-2: Testing and measurement techniques – Electrostatic discharge immunity test, [IEC 61000-4-2:2008](#)
- [8] IEC: Electrostatics - Part 5-1: Protection of electronic devices from electrostatic phenomena - General requirements, [IEC 61340-5-1:2016](#)
- [9] ETSI: Electromagnetic compatibility and Radio spectrum Matters (ERM); ElectroMagnetic Compatibility (EMC) standard for radio equipment and services; Part 1: Common technical requirements, [EN 301 489-1 v2.2.3](#)
- [10] ETSI: Audio/video, information, and communication technology equipment - Part 1: Safety requirements, [IEC 62368-1:2018](#)
- [11] FCC guidance [594280 D01 Configuration Control v02 r01](#),
- [12] FCC guidance [594280 D02 U-NII Device Security v01r03](#)
- [13] NORA-W3 ETSI Declaration of Conformity (TBC)
- [14] NORA-W3 UKCA Declaration of Conformity (TBC)
- [15] Realtek Ameba-D application note, [AN0400](#)
- [16] Realtek Ameba IoT [website](#)
- [17] Realtek GitHub [Ameba IoT site](#)
- [18] Realtek GitHub [Ameba-D standard SDK repository](#)
- [19] Realtek GitHub [Ameba-D Arduino repository](#)
- [20] Realtek Ameba IoT [support forum](#)
- [21] Arduino IDE [website](#)
- [22] Official Matter GitHub [Open Source repository](#)
- [23] Realtek GitHub [Matter adaptation repository](#)
- [24] Cygwin [website](#)
- [25] u-blox Github [NORA-W30-OutputPower](#) repository

 For product change notifications and regular updates of u-blox documentation, register on our website, www.u-blox.com.

Revision history

Revision	Date	Name	Comments
R01	23-Nov-2022	brec	Initial release
R02	24-Mar-2023	brec	Changed disclosure restriction to C1-Public, removed audio codec
R03	20-Oct-2023	brec	Updated product status in Document information, updated certification labeling requirements in Regulatory compliance , updated Software configuration and control, updated Bluetooth 5 to Bluetooth 5.3, moved antenna list to Approved antennas, updated design for Take care of the interaction between co-located RF systems like LTE sidebands on 2.4 GHz band. Transmitted power may interact or disturb the performance of NORA-W30 modules. NORA-W301 U.FL reference design including Figure 3 , updated keep-out area for NORA-W306 in Figure 5 and Figure 6 , removed pin assignment table, updated Table 4 to include pin number, added Wi-Fi transmit output power limits
R04	27-Mar-2024	brec, cnic	Added section Set regulatory domain . Added power settings tables to appendix, added GitHub link for SDK power settings [25] .
R04_cert	27-Mar-2024	brec	Included NORA-W300 for certification submissions
R05_cert	30-Apr-2024	brec	Added Reference trace design (NORA-W3x1 only)
R06_cert	01-May2024	brec	Included individual references for Taiwan certification numbers.
R07_cert	20-May-2024	brec	Included TE-Linx ANT-DB1-RAF-RPS antenna for FCC, ISED Bluetooth LE

Contact

u-blox AG

Address: Zürcherstrasse 68
8800 Thalwil
Switzerland

For further support and contact information, visit us at www.u-blox.com/support.