

CFR 47 FCC PART 15 SUBPART C**TEST REPORT***For***MAYA-W2 host-based multiradio modules****MODEL NUMBER: MAYA-W271-00B****REPORT NUMBER: 4791682450-1-RF-1****ISSUE DATE: May 12, 2025****FCC ID: XPYMAW2A***Prepared for***u-blox AG****Zuercherstrasse 68, Thalwil, Ch-8800 Switzerland***Prepared by***UL Verification Services (Guangzhou) Co., Ltd, Song Shan Lake Branch****Building 10, Innovation Technology Park, No. 1, Li Bin Road, Song Shan Lake Hi-Tech Development Zone Dongguan, 523808, People's Republic of China****Tel: +86 769 22038881****Fax: +86 769 33244054****Website: www.ul.com**

Revision History

<u>Rev.</u>	<u>Issue Date</u>	<u>Revisions</u>	<u>Revised By</u>
<u>V0</u>	<u>May 12, 2025</u>	<u>Initial Issue</u>	<u></u>

Summary of Test Results

Test Item	Clause	Limit/Requirement	Result
Antenna Requirement	N/A	FCC Part 15.203/15.247 (c)	Pass
AC Power Line Conducted Emission	ANSI C63.10-2013, Clause 6.2	FCC Part 15.207	Pass
Conducted Output Power	ANSI C63.10-2013, Clause 11.9.1.3	FCC Part 15.247 (b)(3)	Pass
6dB Bandwidth and 99% Occupied Bandwidth	ANSI C63.10-2013, Clause 11.8.1	FCC Part 15.247 (a)(2)	Pass
Power Spectral Density	ANSI C63.10-2013, Clause 11.10.2	FCC Part 15.247 (e)	Pass
Conducted Band edge and spurious emission	ANSI C63.10-2013, Clause 11.11	FCC Part 15.247(d)	Pass
Radiated Band edge and Spurious Emission	ANSI C63.10-2013, Clause 11.12 & Clause 11.13	FCC Part 15.247 (d) FCC Part 15.205/15.209	Pass
Duty Cycle	ANSI C63.10-2013, Clause 11.6	None; for reporting purposes only.	Pass

*This test report is only published to and used by the applicant, and it is not for evidence purpose in China.

*The measurement result for the sample received is <Pass> according to <CFR 47 FCC PART 15 SUBPART C> when <Simple Acceptance> decision rule is applied.

Note: This report is based on report No.: G0M-2302-1881-TFC247BL-W260-V03 which is issued by Eurofins Product Service GmbH on Jan. 10, 2024. The module has been certified for FCC ID, the antenna type and gain changed. The RF technical construction including circuit diagram, PCB Layout, components, component layout and performance does not change. The output power is verified close to the original report. Only radiated test item performed and reported in this report.

CONTENTS

1. ATTESTATION OF TEST RESULTS.....	5
2. TEST METHODOLOGY.....	6
3. FACILITIES AND ACCREDITATION.....	6
4. CALIBRATION AND UNCERTAINTY	7
4.1. <i>MEASURING INSTRUMENT CALIBRATION</i>	<i>7</i>
4.2. <i>MEASUREMENT UNCERTAINTY.....</i>	<i>7</i>
5. EQUIPMENT UNDER TEST	8
5.1. <i>DESCRIPTION OF EUT</i>	<i>8</i>
5.2. <i>CHANNEL LIST</i>	<i>8</i>
5.3. <i>TEST CHANNEL CONFIGURATION.....</i>	<i>8</i>
5.4. <i>THE WORSE CASE POWER SETTING PARAMETER.....</i>	<i>9</i>
5.5. <i>DESCRIPTION OF AVAILABLE ANTENNAS</i>	<i>9</i>
5.6. <i>SUPPORT UNITS FOR SYSTEM TEST</i>	<i>10</i>
6. MEASURING EQUIPMENT AND SOFTWARE USED.....	11
7. RADIATED TEST RESULTS.....	12
7.1. <i>RESTRICTED BANDEDGE</i>	<i>19</i>
7.2. <i>SPURIOUS EMISSIONS(1 GHZ~3 GHZ)</i>	<i>24</i>
7.3. <i>SPURIOUS EMISSIONS(3 GHZ~18 GHZ)</i>	<i>30</i>
7.4. <i>SPURIOUS EMISSIONS(9 KHZ~30 MHZ)</i>	<i>42</i>
7.5. <i>SPURIOUS EMISSIONS(18 GHZ~26 GHZ)</i>	<i>45</i>
7.6. <i>SPURIOUS EMISSIONS(30 MHZ~1 GHZ).....</i>	<i>47</i>
8. ANTENNA REQUIREMENT	49

1. ATTESTATION OF TEST RESULTS

Applicant Information

Company Name: u-blox AG
 Address: Zuercherstrasse 68, Thalwil, Ch-8800 Switzerland

Manufacturer Information

Company Name: u-blox AG
 Address: Zuercherstrasse 68, Thalwil, Ch-8800 Switzerland

EUT Information

EUT Name: MAYA-W2 host-based multiradio modules
 Model: MAYA-W271-00B
 Series Model: \
 Brand: \
 Sample Received Date: February 21, 2025
 Sample Status: Normal
 Sample ID: 8456961
 Date of Tested: February 24, 2025 to April 30, 2025

APPLICABLE STANDARDS	
STANDARD	TEST RESULTS
CFR 47 FCC PART 15 SUBPART C	Pass

Prepared By:

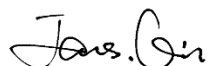

James Qin
 Project Engineer

Checked By:

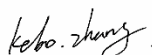

Kebo Zhang
 Senior Project Engineer

Approved By:



Stephen Guo
 Operations Manager

2. TEST METHODOLOGY

All tests were performed in accordance with the standard CFR 47 FCC PART 15 SUBPART C ISED RSS-247 Issue 3, KDB 558074 D01 15.247 Meas Guidance v05r02, 414788 D01 Radiated Test Site v01r01, CFR 47 FCC Part 2, ANSI C63.10-2013.

3. FACILITIES AND ACCREDITATION

Accreditation Certificate	<p>A2LA (Certificate No.: 4102.01) UL Verification Services (Guangzhou) Co., Ltd. Song Shan Lake Branch. has been assessed and proved to be in compliance with A2LA.</p> <p>FCC (FCC Designation No.: CN1187) UL Verification Services (Guangzhou) Co., Ltd. Song Shan Lake Branch. Has been recognized to perform compliance testing on equipment subject to the Commission's Declaration of Conformity (DoC) and Certification rules</p> <p>ISED (Company No.: 21320) UL Verification Services (Guangzhou) Co., Ltd. Song Shan Lake Branch. has been registered and fully described in a report filed with ISED. The Company Number is 21320 and the test lab Conformity Assessment Body Identifier (CABID) is CN0046.</p> <p>VCCI (Registration No.: G-20192, C-20153, T-20155 and R-20202) UL Verification Services (Guangzhou) Co., Ltd. Song Shan Lake Branch. has been assessed and proved to be in compliance with VCCI, the Membership No. is 3793. Facility Name: Chamber D, the VCCI registration No. is G-20192 and R-20202 Shielding Room B, the VCCI registration No. is C-20153 and T-20155</p>
---------------------------	--

Note 1:

All tests measurement facilities use to collect the measurement data are located at Building 10, Innovation Technology Park, No. 1, Li Bin Road, Song Shan Lake Hi-Tech Development Zone Dongguan, 523808, People's Republic of China.

Note 2:

The test anechoic chamber in UL Verification Services (Guangzhou) Co., Ltd. Song Shan Lake Branch had been calibrated and compared to the open field sites and the test anechoic chamber is shown to be equivalent to or worst case from the open field site.

Note 3:

For below 30 MHz, lab had performed measurements at test anechoic chamber and comparing to measurements obtained on an open field site. And these measurements below 30 MHz had been correlated to measurements performed on an OFS.

4. CALIBRATION AND UNCERTAINTY

4.1. MEASURING INSTRUMENT CALIBRATION

The measuring equipment utilized to perform the tests documented in this report has been calibrated in accordance with the manufacturer's recommendations and is traceable to recognized national standards.

4.2. MEASUREMENT UNCERTAINTY

Where relevant, the following measurement uncertainty levels have been estimated for tests performed on the apparatus:

Test Item	Uncertainty
Radiated Emission (Included Fundamental Emission) (9 kHz ~ 30 MHz)	2.2 dB
Radiated Emission (Included Fundamental Emission) (30 MHz ~ 1 GHz)	4.00 dB
Radiated Emission (Included Fundamental Emission) (1 GHz to 26 GHz)	5.78 dB (1 GHz ~ 18 GHz)
	5.23 dB (18 GHz ~ 26 GHz)
Note: This uncertainty represents an expanded uncertainty expressed at approximately the 95% confidence level using a coverage factor of k=2.	

5. EQUIPMENT UNDER TEST

5.1. DESCRIPTION OF EUT

EUT Name:	MAYA-W2 host-based multiradio modules
Model:	MAYA-W271-00B
Series Model:	\
Model Difference:	\

Frequency Range:	2402 MHz to 2480 MHz
Type of Modulation:	GFSK
Data Rate:	1 Mbps / 2 Mbps
Rated Input:	DC 5 V, 1 A

5.2. CHANNEL LIST

Channel	Frequency (MHz)	Channel	Frequency (MHz)	Channel	Frequency (MHz)	Channel	Frequency (MHz)
0	2402	11	2424	22	2446	33	2468
1	2404	12	2426	23	2448	34	2470
2	2406	13	2428	24	2450	35	2472
3	2408	14	2430	25	2452	36	2474
4	2410	15	2432	26	2454	37	2476
5	2412	16	2434	27	2456	38	2478
6	2414	17	2436	28	2458	39	2480
7	2416	18	2438	29	2460	/	/
8	2418	19	2440	30	2462	/	/
9	2420	20	2442	31	2464	/	/
10	2422	21	2444	32	2468	/	/

5.3. TEST CHANNEL CONFIGURATION

Test Mode	Test Channel	Frequency
LE 1M	CH 0(Low Channel), CH 19(MID Channel), CH 39(High Channel)	2402 MHz, 2440 MHz, 2480 MHz
LE 2M	CH 0(Low Channel), CH 19(MID Channel), CH 39(High Channel)	2402 MHz, 2440 MHz, 2480 MHz

5.4. THE WORSE CASE POWER SETTING PARAMETER

The Worst Case Power Setting Parameter under 2400 ~ 2483.5MHz Band				
Test Software Version		CMD		
Modulation Type	Transmit Antenna Number	Test Software setting value		
		CH 0	CH 19	CH 39
GFSK(1Mbps)	J21	default	default	default
GFSK(2Mbps)	J21	default	default	default

5.5. DESCRIPTION OF AVAILABLE ANTENNAS

Antenna	Frequency (MHz)	Antenna Type	MAX Antenna Gain (dBi)
J21	2402-2480	FPC	2.13

Test Mode	Transmit and Receive Mode	Description
LE 1M	<input checked="" type="checkbox"/> 1TX, 1RX	Antenna J21 can be used as transmitting/receiving antenna.
LE 2M	<input checked="" type="checkbox"/> 1TX, 1RX	Antenna J21 can be used as transmitting/receiving antenna.

5.6. SUPPORT UNITS FOR SYSTEM TEST

SUPPORT EQUIPMENT

Item	Equipment	Brand Name	Model Name	P/N
1	Adapter	/	FH12W-1201000C	Input: 100-240V ~50/60Hz, 0.6 A Output Voltage: 5Vdc, 1A
2	UART Serial Port	/	/	/

I/O CABLES

able No	Port	Connector Type	Cable Type	Cable Length(m)	Remarks
1	/	/	/	/	/

ACCESSORY

Item	Accessory	Brand Name	Model Name	Description
1	/	/	/	/

TEST SETUP

The EUT can work in an engineer mode by running with CMD command.

SETUP DIAGRAM FOR TESTS

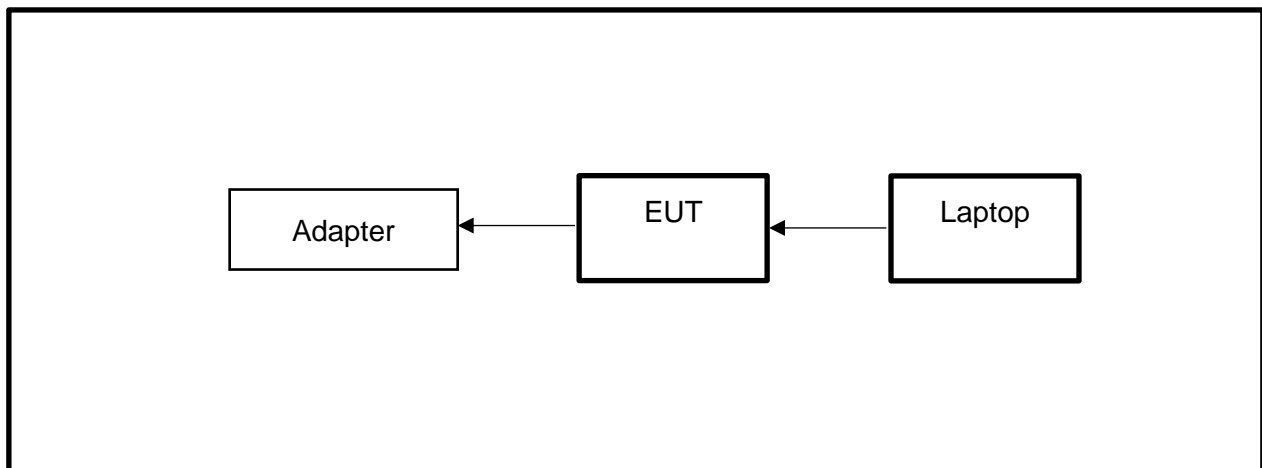

6. MEASURING EQUIPMENT AND SOFTWARE USED

Radiated Emissions					
Equipment	Manufacturer	Model No.	Serial No.	Last Cal.	Due Date
MXE EMI Receiver	KESIGHT	N9038A	MY56400036	Sep.28, 2024	Sep.27, 2025
Hybrid Log Periodic Antenna	TDK	HLP-3003C	130960	June 28, 2024	June.27 2027
Preamplifier	HP	8447D	2944A09099	Sep.28, 2024	Sep.27, 2025
EMI Measurement Receiver	R&S	ESR26	101377	Sep.28, 2024	Sep.27, 2025
Horn Antenna	TDK	HRN-0118	130939	Apr.29, 2022	Apr.28, 2025
Preamplifier	TDK	PA-02-0118	TRS-305-00067	Sep.28, 2024	Sep.27, 2025
Horn Antenna	Schwarzbeck	BBHA9170	697	Jun 30, 2024	Jun 29, 2027
Preamplifier	TDK	PA-02-2	TRS-307-00003	Sep.28, 2024	Sep.27, 2025
Preamplifier	TDK	PA-02-3	TRS-308-00002	Sep.28, 2024	Sep.27, 2025
Loop antenna	Schwarzbeck	1519B	00008	Dec.09, 2024	Dec.08, 2027
High Pass Filter	Wi	WHKX10-2700-3000-18000-40SS	23	Sep.28, 2024	Sep.27, 2025
Band Reject Filter	Wainwright	WRCJV8-2350-2400-2483.5-2533.5-40SS	4	Sep.28, 2024	Sep.27, 2025
Software					
Description			Manufacturer	Name	Version
Test Software for Radiated Emissions			Farad	EZ-EMC	Ver. UL-3A1

Other Instrument					
Equipment	Manufacturer	Model No.	Serial No.	Last Cal.	Due Date
Temperature humidity probe	OMEGA	ITHX-SD-5	18470007	Oct.8, 2024	Oct.7, 2025
Barometer	Yiyi	Baro	N/A	Oct.10, 2024	Oct.9, 2025
Attenuator	Agilent	8495B	2814a12853	Sep.28, 2024	Sep.27, 2025

7. RADIATED TEST RESULTS

LIMITS

Please refer to CFR 47 FCC §15.205 and §15.209.

Radiation Disturbance Test Limit for FCC (Class B) (9 kHz ~ 1 GHz)

Emissions radiated outside of the specified frequency bands above 30 MHz			
Frequency Range (MHz)	Field Strength Limit (uV/m) at 3 m	Field Strength Limit (dBuV/m) at 3 m	
		Quasi-Peak	
30 - 88	100	40	
88 - 216	150	43.5	
216 - 960	200	46	
Above 960	500	54	
Above 1000	500	Peak	Average
		74	54

FCC Emissions radiated outside of the specified frequency bands below 30 MHz		
Frequency (MHz)	Field strength (microvolts/meter)	Measurement distance (meters)
0.009-0.490	2400/F(kHz)	300
0.490-1.705	24000/F(kHz)	30
1.705-30.0	30	30

FCC Restricted bands of operation refer to FCC §15.205 (a):

MHz	MHz	MHz	GHz
0.090-0.110	16.42-16.423	399.9-410	4.5-5.15
¹ 0.495-0.505	16.69475-16.69525	608-614	5.35-5.46
2.1735-2.1905	16.80425-16.80475	960-1240	7.25-7.75
4.125-4.128	25.5-25.67	1300-1427	8.025-8.5
4.17725-4.17775	37.5-38.25	1435-1626.5	9.0-9.2
4.20725-4.20775	73-74.6	1645.5-1646.5	9.3-9.5
6.215-6.218	74.8-75.2	1660-1710	10.6-12.7
6.26775-6.26825	108-121.94	1718.8-1722.2	13.25-13.4
6.31175-6.31225	123-138	2200-2300	14.47-14.5
8.291-8.294	149.9-150.05	2310-2390	15.35-16.2
8.362-8.366	156.52475-156.52525	2483.5-2500	17.7-21.4
8.37625-8.38675	156.7-156.9	2690-2900	22.01-23.12
8.41425-8.41475	162.0125-167.17	3260-3267	23.6-24.0
12.29-12.293	167.72-173.2	3332-3339	31.2-31.8
12.51975-12.52025	240-285	3345.8-3358	36.43-36.5
12.57675-12.57725	322-335.4	3600-4400	(²)
13.36-13.41			

Note: ¹Until February 1, 1999, this restricted band shall be 0.490-0.510 MHz.

²Above 38.6c

TEST PROCEDURE

Below 30 MHz

The setting of the spectrum analyzer

RBW	200 Hz (From 9 kHz to 0.15 MHz)/ 9 kHz (From 0.15 MHz to 30 MHz)
VBW	200 Hz (From 9 kHz to 0.15 MHz)/ 9 kHz (From 0.15 MHz to 30 MHz)
Sweep	Auto

1. The testing follows the guidelines in ANSI C63.10-2013 clause 6.4.
2. The EUT was arranged to its worst case and then turntable (from 0 degree to 360 degrees) to find the maximum reading. A pre-amp and a high pass filter are used for the test in order to get better signal level. Both Horizontal, Face-on and Face-off polarizations of the antenna are set to make the measurement.
3. The EUT was placed on a turntable with 80 cm above ground.
4. The EUT was set 3 meters from the interference receiving antenna, which was mounted on the top of a 1 m height antenna tower.
5. The radiated emission limits are based on measurements employing a CISPR quasi-peak detector except for the frequency bands 9-90 kHz, 110-490 kHz and above 1000 MHz Radiated emission limits in these three bands are based on measurements employing an average detector.
6. For measurement below 1 GHz, the initial step in collecting conducted emission data is a spectrum analyzer peak detector mode pre-scanning the measurement frequency range. Significant peaks are then marked and then Quasi Peak and average detector mode re-measured. If the emission level of the EUT measured by the peak detector is 3 dB lower than the applicable limit, the peak emission level will be reported. Otherwise, the emission measurement will be repeated using the quasi-peak and average detector and reported.
7. Although these tests were performed other than open field site, adequate comparison measurements were confirmed against 30m open field site. Therefore sufficient tests were made to demonstrate that the alternative site produces results that correlate with the ones of tests made in an open field site based on KDB 414788.
8. The limits in CFR 47, Part 15, Subpart C, paragraph 15.209 (a), are identical to those in RSS-GEN Section 8.9, Table 6, since the measurements are performed in terms of magnetic field strength and converted to electric field strength levels (as reported in the table) using the free space impedance of 377Ω. For example, the measurement frequency X kHz resulted in a level of Y dBuV/m, which is equivalent to $Y - 51.5 = Z$ dBuA/m, which has the same margin, W dB, to the corresponding RSS-GEN Table 6 limit as it has to be 15.209(a) limit.

Below 1 GHz and above 30 MHz

The setting of the spectrum analyzer

RBW	120 kHz
VBW	300 kHz
Sweep	Auto
Detector	Peak/QP
Trace	Max hold

1. The testing follows the guidelines in ANSI C63.10-2013 clause 6.5.
2. The EUT was arranged to its worst case and then tune the antenna tower (from 1 m to 4 m) and turntable (from 0 degree to 360 degrees) to find the maximum reading. A pre-amp and a high pass filter are used for the test in order to get better signal level. Both horizontal and vertical polarizations of the antenna are set to make the measurement.
3. The EUT was placed on a turntable with 80 cm above ground.
4. The EUT was set 3 meters from the interference receiving antenna, which was mounted on the top of a variable height antenna tower.
5. For measurement below 1 GHz, the initial step in collecting conducted emission data is a spectrum analyzer peak detector mode pre-scanning the measurement frequency range. Significant peaks are then marked and then Quasi Peak detector mode re-measured. If the emission level of the EUT measured by the peak detector is 3 dB lower than the applicable limit, the peak emission level will be reported. Otherwise, the emission measurement will be repeated using the quasi-peak detector and reported.

Above 1 GHz

The setting of the spectrum analyzer

RBW	1 MHz
VBW	PEAK: 3 MHz AVG: see note 6
Sweep	Auto
Detector	Peak
Trace	Max hold

1. The testing follows the guidelines in ANSI C63.10-2013 clause 6.6.
2. The EUT was arranged to its worst case and then tune the antenna tower (from 1 m to 4 m) and turntable (from 0 degree to 360 degrees) to find the maximum reading. A pre-amp and a high pass filter are used for the test in order to get better signal level. Both horizontal and vertical polarizations of the antenna are set to make the measurement.
3. The EUT was placed on a turntable with 1.5 m above ground.
4. The EUT was set 3 meters from the interference receiving antenna, which was mounted on the top of a variable height antenna tower.
5. For measurement above 1 GHz, the emission measurement will be measured by the peak detector. This peak level, once corrected, must comply with the limit specified in Section 15.209.
6. For measurements above 1 GHz the resolution bandwidth is set to 1 MHz, then the video bandwidth is set to 3 MHz for peak measurements and 1 MHz resolution bandwidth with 1/T video bandwidth with peak detector for average measurements. For the Duty Cycle please refer to clause 7.5. ON TIME AND DUTY CYCLE.

X axis, Y axis, Z axis positions:

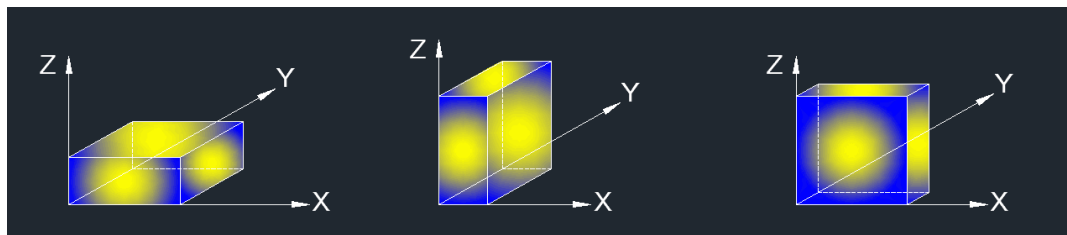

Note 1: For all radiated test, EUT in each of three orthogonal axis emissions had been tested, but only the worst case (X axis) data recorded in the report.

Note 2: The EUT was fully exercised with external accessories during the test. In the case of multiple accessory external ports, an external accessory shall be connected to one of each type of port.

For Restricted Bandedge:

Note:

1. Measurement = Reading Level + Correct Factor.
2. If the peak values are less than the average limit of 54 dBuV/m, the average result is deemed to comply with average limit.
3. PK=Peak: Peak detector.
4. AV=Average: VBW=1/Ton, where: Ton is the transmitting duration.
5. For the transmitting duration, please refer to clause 7.5.
6. Only the worst data was recorded, if it complies with the limit, the other emissions deemed to comply with the limit.
7. Both horizontal and vertical have been tested, only the worst data was recorded in the report.
8. All modes have been tested, but only the worst data was recorded in the report.

For Radiate Spurious emission (9 kHz ~ 30 MHz):

Note:

1. Measurement = Reading Level + Correct Factor.
2. If the peak values are less than the QP limit, the QP result is deemed to comply with QP limit.
3. All 3 polarizations (Horizontal, Face-on and Face-off) of the loop antenna had been tested, but only the worst data recorded in the report.
4. All modes have been tested, but only the worst data was recorded in the report.
5. $\text{dBuA/m} = \text{dBuV/m} - 20\text{Log}_{10}[120\pi] = \text{dBuV/m} - 51.5$

For Radiate Spurious Emission (30 MHz ~ 1 GHz):

Note:

1. Result Level = Read Level + Correct Factor.
2. If the peak values are less than the QP limit, the QP result is deemed to comply with QP limit.
3. All modes have been tested, but only the worst data was recorded in the report.

For Radiate Spurious Emission (1 GHz ~ 3 GHz):

Note:

1. Measurement = Reading Level + Correct Factor.
2. If the peak values are less than the average limit of 54 dBuV/m, the average result is deemed to comply with average limit.
3. Peak: Peak detector.
4. AVG: VBW=1/Ton, where: Ton is the transmitting duration.
5. For the transmitting duration, please refer to clause 7.5.
6. Filter losses were only considered in the spurious frequency bands and the authorized band was not corrected for Band reject filter losses.
7. Proper operation of the transmitter prior to adding the filter to the measurement chain.
8. All modes have been tested, but only the worst data was recorded in the report.

For Radiate Spurious Emission (3 GHz ~ 18 GHz):

Note:

1. Peak Result = Reading Level + Correct Factor.
2. If the peak values are less than the average limit of 54 dBuV/m, the average result is deemed to comply with average limit.
3. Peak: Peak detector.
4. AVG: $VBW=1/T_{on}$, where: T_{on} is the transmitting duration.
5. For the transmitting duration, please refer to clause 7.5.
6. Filter losses were only considered in the spurious frequency bands and the authorized band was not corrected for High Pass Filter losses.
7. Proper operation of the transmitter prior to adding the filter to the measurement chain.
8. All modes have been tested, but only the worst data was recorded in the report.

For Radiate Spurious emission (18 GHz ~ 26 GHz):

Note:

1. Measurement = Reading Level + Correct Factor.
2. If the peak values are less than the average limit of 54 dBuV/m, the average result is deemed to comply with average limit.
3. Peak: Peak detector.
4. All modes have been tested, but only the worst data was recorded in the report.

TEST SETUP

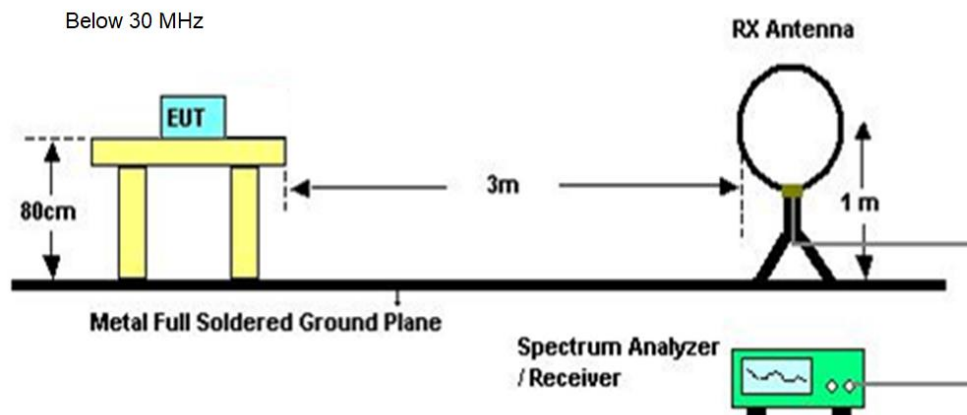

Below 1 GHz and above 30 MHz

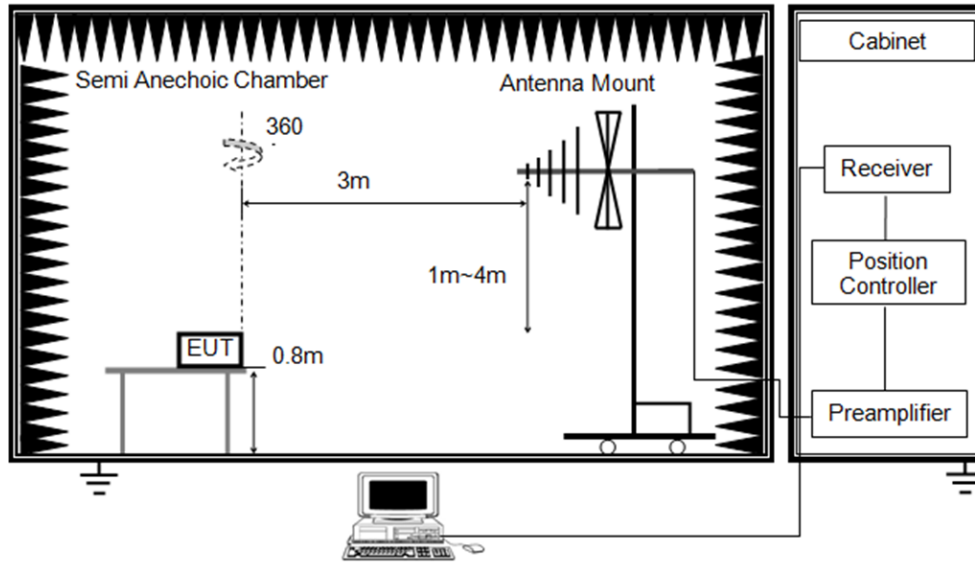

Above 1 GHz

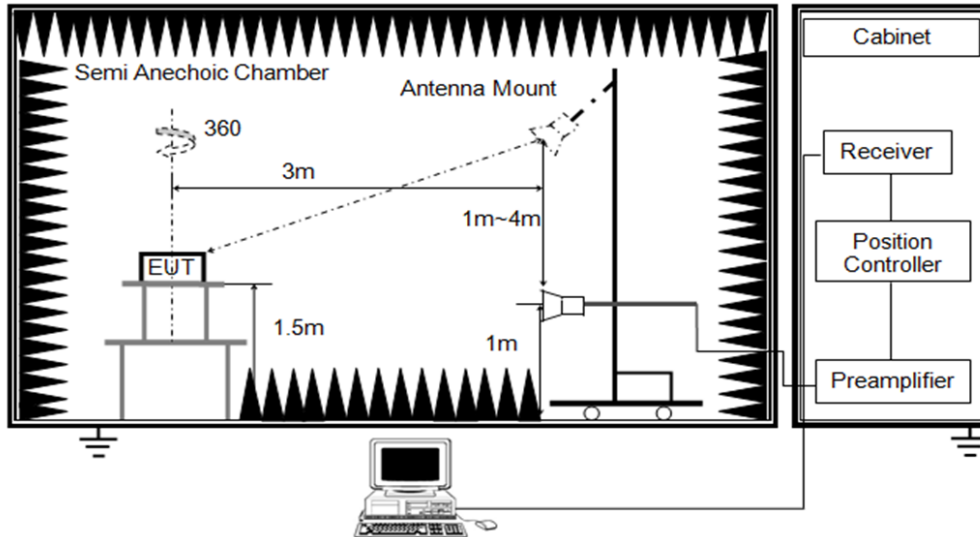

TEST ENVIRONMENT

Temperature	24.9°C	Relative Humidity	60%
Atmosphere Pressure	101kPa	Test Voltage	AC 120V_60Hz

TEST DATE / ENGINEER

Test Date	February 24, 2025 to April 30, 2025	Test By	Rex Huang
-----------	-------------------------------------	---------	-----------

TEST RESULTS

7.1. RESTRICTED BANDEDGE

Test Mode:	BLE 1M PK	Frequency(MHz):	2402
Polarity:	Horizontal	Test Voltage:	AC 120V_60Hz

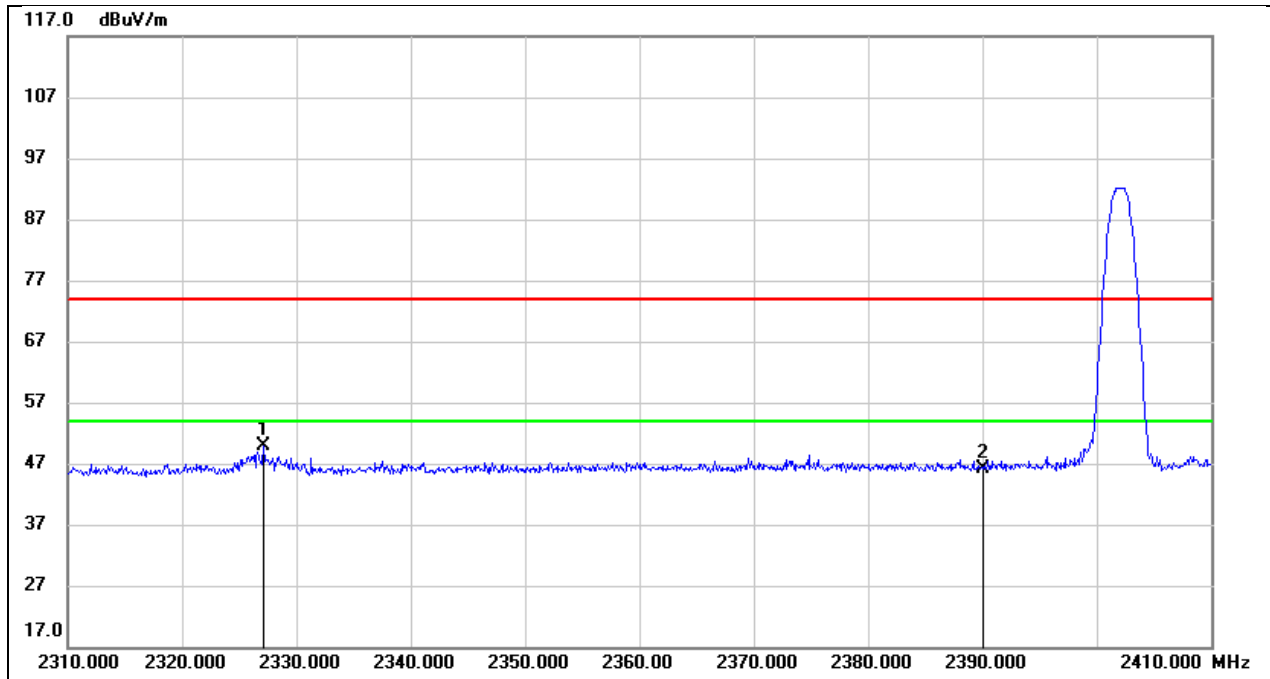

No.	Frequency (MHz)	Reading (dBuV)	Correct (dB/m)	Result (dBuV/m)	Limit (dBuV/m)	Margin (dB)	Remark
1	2327.100	18.28	31.49	49.77	74.00	-24.23	peak
2	2390.000	14.35	31.73	46.08	74.00	-27.92	peak

Test Mode:	BLE 1M PK	Frequency(MHz):	2402
Polarity:	Vertical	Test Voltage:	AC 120V_60Hz

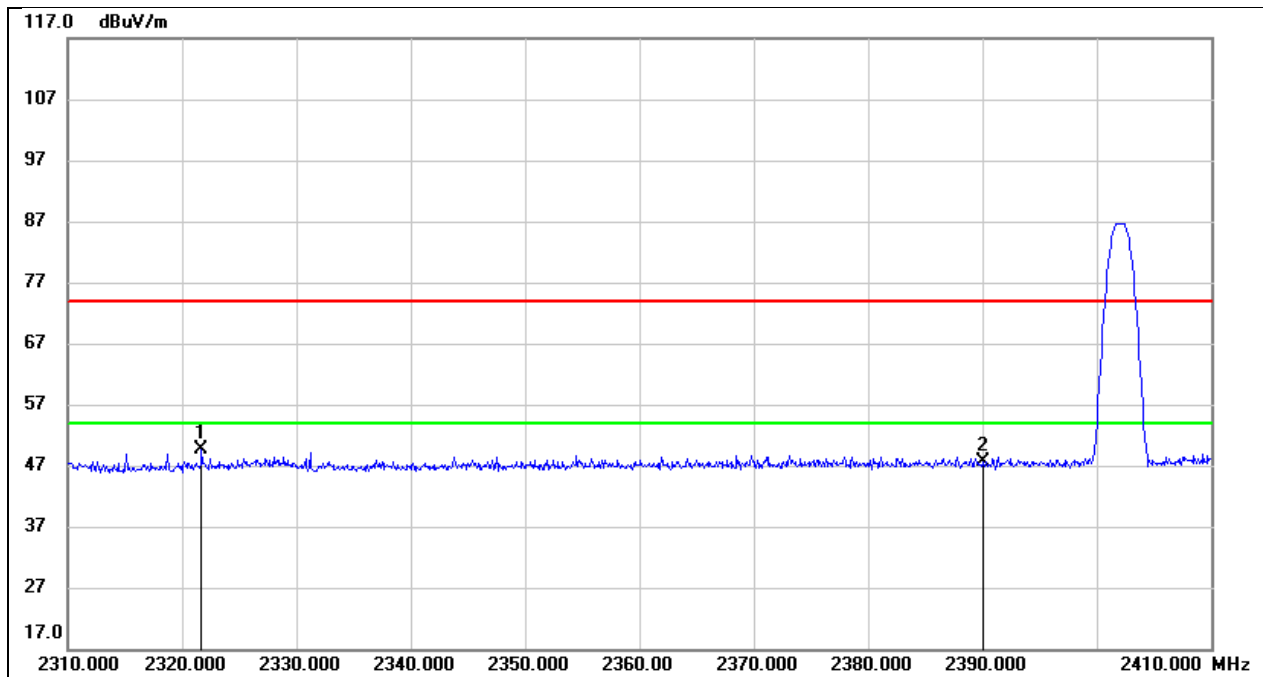

No.	Frequency (MHz)	Reading (dBuV)	Correct (dB/m)	Result (dBuV/m)	Limit (dBuV/m)	Margin (dB)	Remark
1	2321.700	17.32	32.31	49.63	74.00	-24.37	peak
2	2390.000	15.18	32.55	47.73	74.00	-26.27	peak

Test Mode:	BLE 1M PK	Frequency(MHz):	2480
Polarity:	Horizontal	Test Voltage:	AC 120V_60Hz

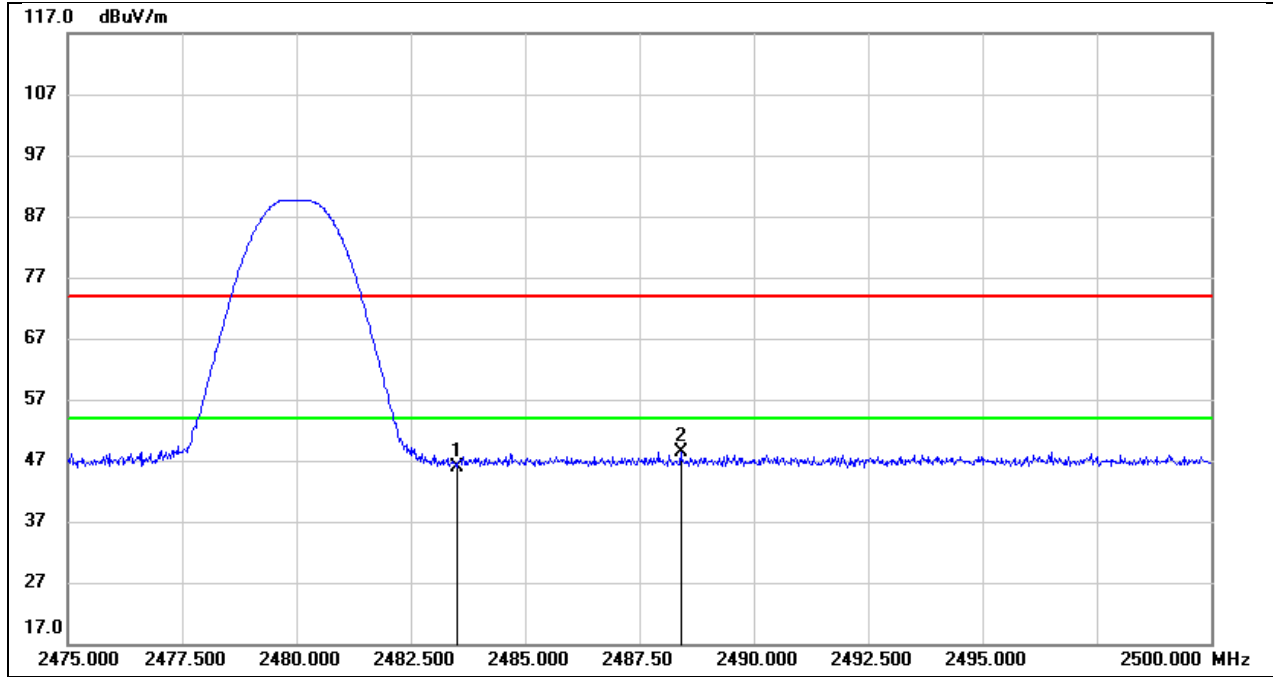

No.	Frequency (MHz)	Reading (dBuV)	Correct (dB/m)	Result (dBuV/m)	Limit (dBuV/m)	Margin (dB)	Remark
1	2483.500	13.82	32.00	45.82	74.00	-28.18	peak
2	2488.400	16.42	32.01	48.43	74.00	-25.57	peak

Test Mode:	BLE 2M PK	Frequency(MHz):	2402
Polarity:	Horizontal	Test Voltage:	AC 120V_60Hz

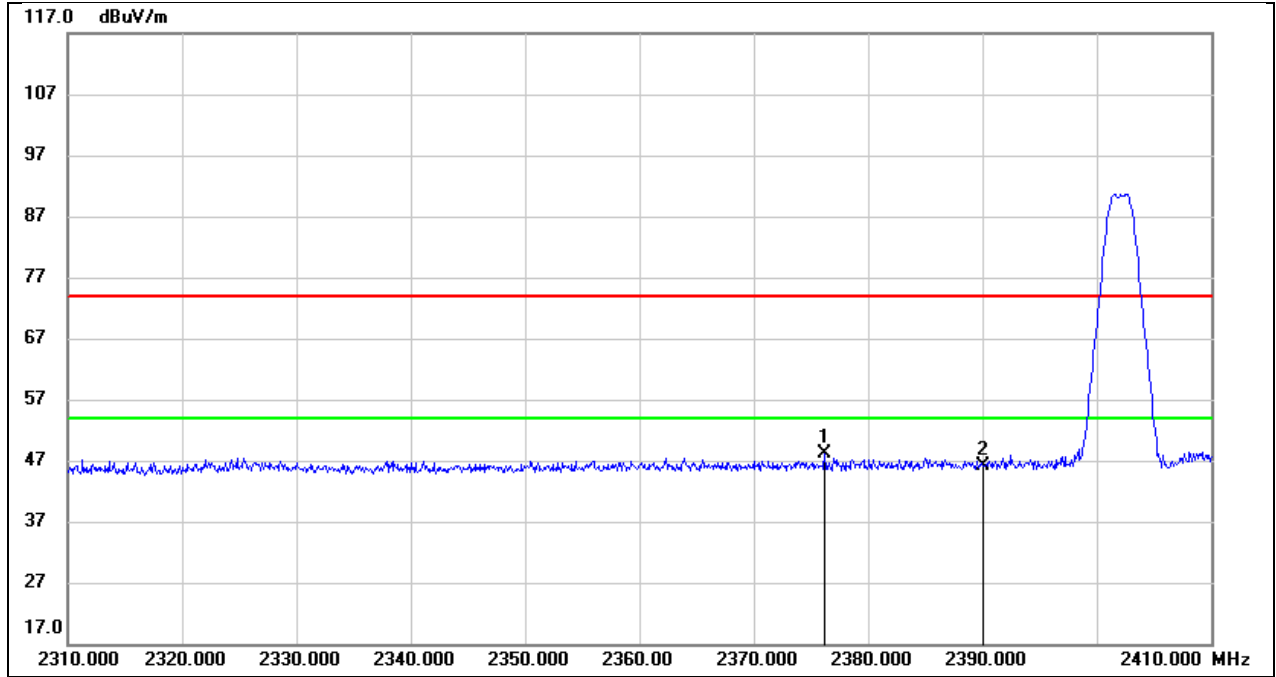

No.	Frequency (MHz)	Reading (dBuV)	Correct (dB/m)	Result (dBuV/m)	Limit (dBuV/m)	Margin (dB)	Remark
1	2376.200	16.45	31.68	48.13	74.00	-25.87	peak
2	2390.000	14.34	31.73	46.07	74.00	-27.93	peak

Test Mode:	BLE 2M PK	Frequency(MHz):	2480
Polarity:	Horizontal	Test Voltage:	AC 120V_60Hz

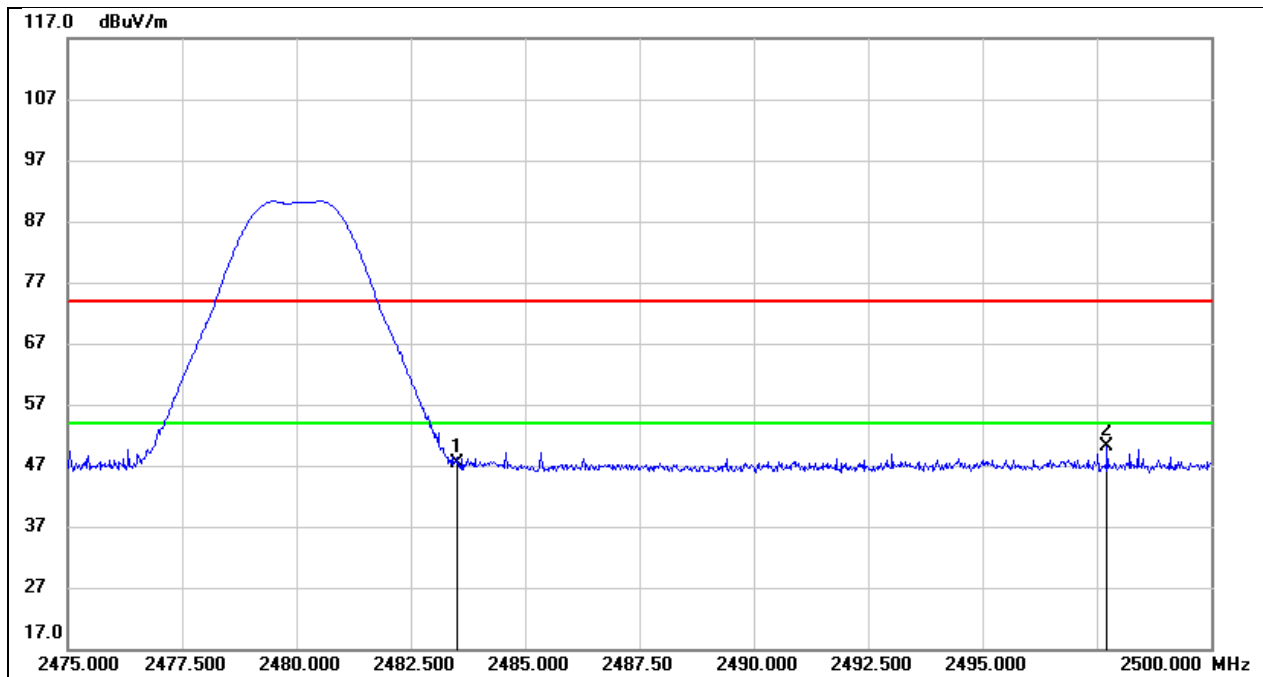

No.	Frequency (MHz)	Reading (dBuV)	Correct (dB/m)	Result (dBuV/m)	Limit (dBuV/m)	Margin (dB)	Remark
1	2483.500	15.29	32.00	47.29	74.00	-26.71	peak
2	2497.725	17.97	32.04	50.01	74.00	-23.99	peak

7.2. SPURIOUS EMISSIONS(1 GHZ~3 GHZ)

Test Mode:	BLE 1M	Frequency(MHz):	2402
Polarity:	Horizontal	Test Voltage:	AC 120V_60Hz

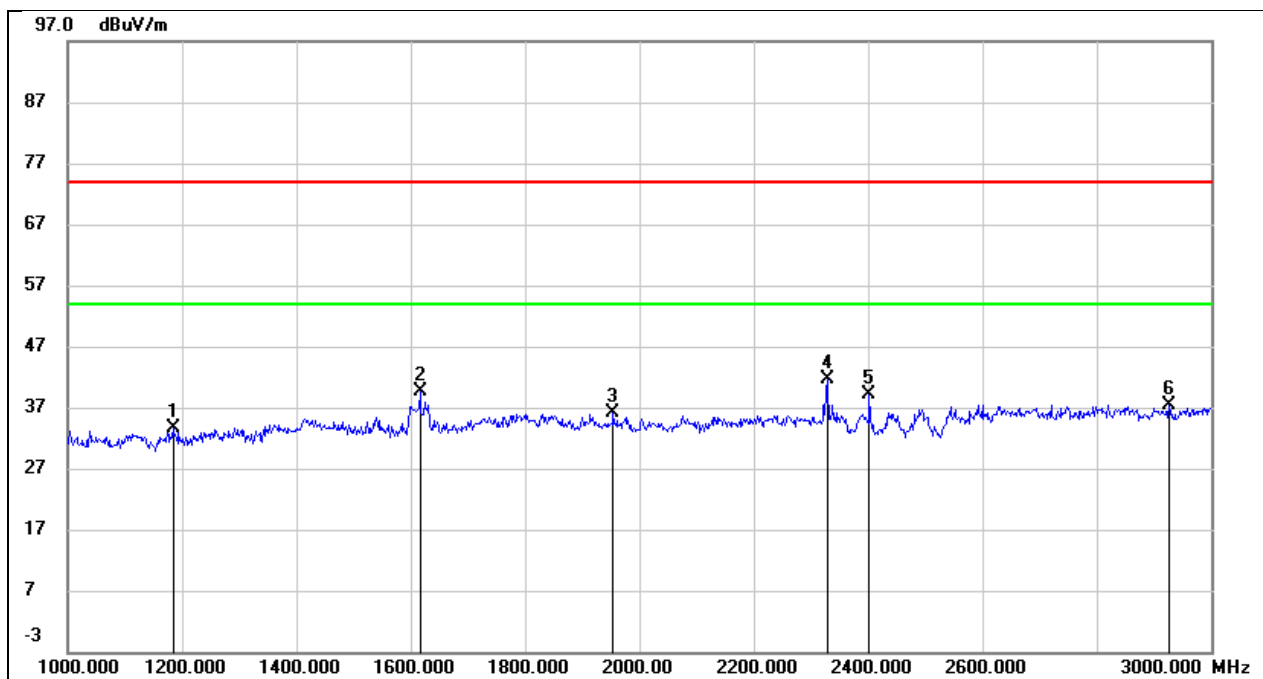

No.	Frequency (MHz)	Reading (dBuV)	Correct (dB/m)	Result (dBuV/m)	Limit (dBuV/m)	Margin (dB)	Remark
1	1184.000	47.10	-13.55	33.55	74.00	-40.45	peak
2	1616.000	50.78	-11.26	39.52	74.00	-34.48	peak
3	1954.000	46.09	-10.07	36.02	74.00	-37.98	peak
4	2328.000	50.59	-8.85	41.74	74.00	-32.26	peak
5	2402.000	47.69	-8.59	39.10	74.00	-34.90	peak
6	2926.000	43.64	-6.34	37.30	74.00	-36.70	peak

Test Mode:	BLE 1M	Frequency(MHz):	2402
Polarity:	Vertical	Test Voltage:	AC 120V_60Hz

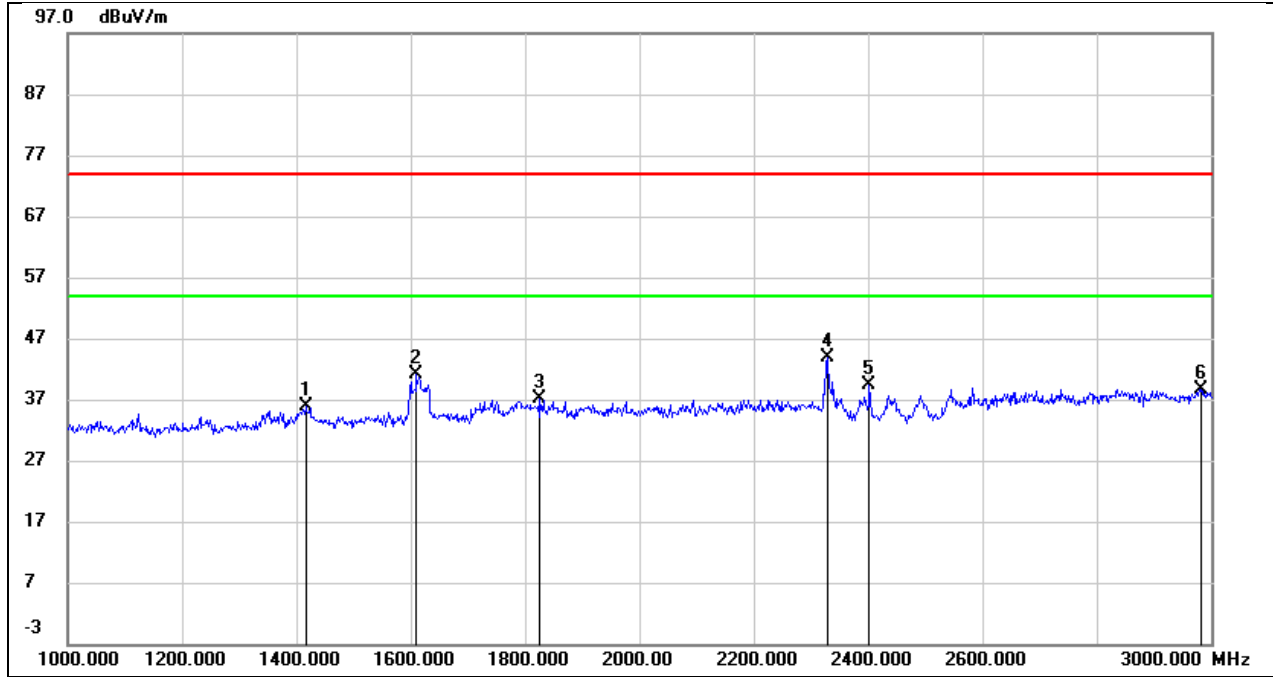

No.	Frequency (MHz)	Reading (dBuV)	Correct (dB/m)	Result (dBuV/m)	Limit (dBuV/m)	Margin (dB)	Remark
1	1416.000	48.10	-12.17	35.93	74.00	-38.07	peak
2	1610.000	52.09	-11.03	41.06	74.00	-32.94	peak
3	1826.000	46.39	-9.35	37.04	74.00	-36.96	peak
4	2328.000	52.00	-8.02	43.98	74.00	-30.02	peak
5	2402.000	47.05	-7.77	39.28	74.00	-34.72	peak
6	2982.000	43.51	-4.80	38.71	74.00	-35.29	peak

Test Mode:	BLE 1M	Frequency(MHz):	2440
Polarity:	Horizontal	Test Voltage:	AC 120V_60Hz

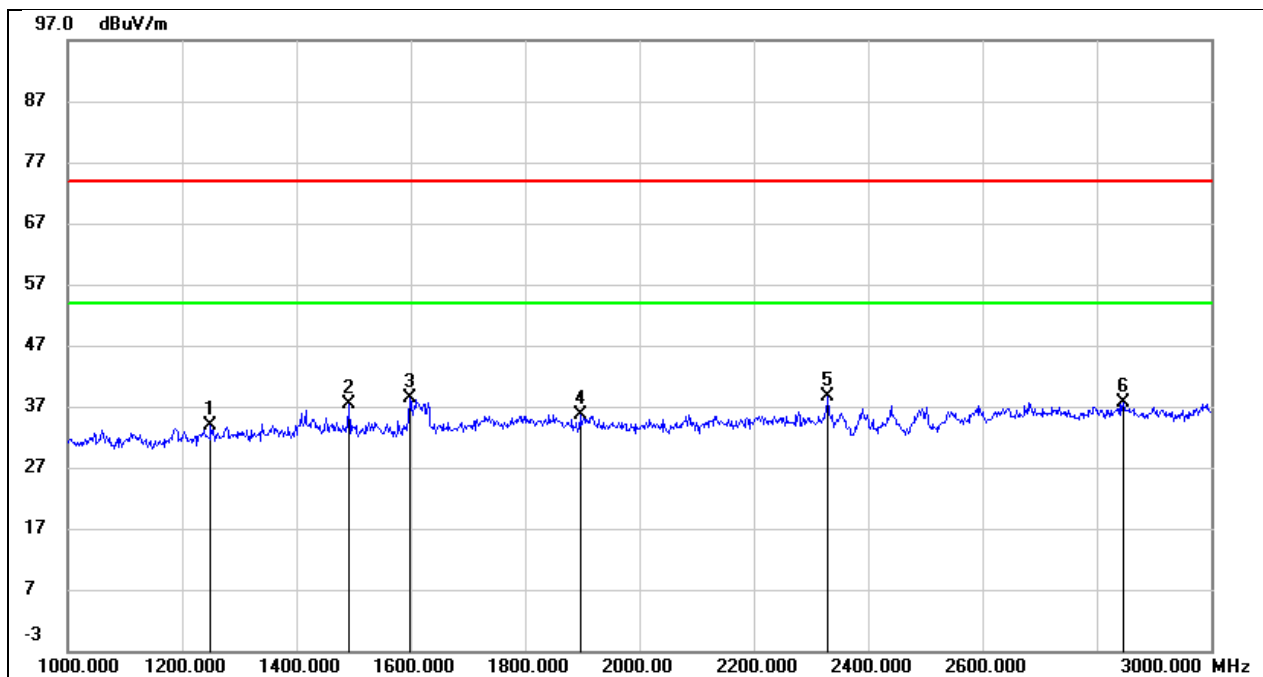

No.	Frequency (MHz)	Reading (dBuV)	Correct (dB/m)	Result (dBuV/m)	Limit (dBuV/m)	Margin (dB)	Remark
1	1250.000	47.02	-13.22	33.80	74.00	-40.20	peak
2	1492.000	49.37	-11.92	37.45	74.00	-36.55	peak
3	1598.000	49.70	-11.39	38.31	74.00	-35.69	peak
4	1896.000	45.70	-10.03	35.67	74.00	-38.33	peak
5	2330.000	47.57	-8.85	38.72	74.00	-35.28	peak
6	2846.000	44.37	-6.71	37.66	74.00	-36.34	peak

Test Mode:	BLE 1M	Frequency(MHz):	2440
Polarity:	Vertical	Test Voltage:	AC 120V_60Hz

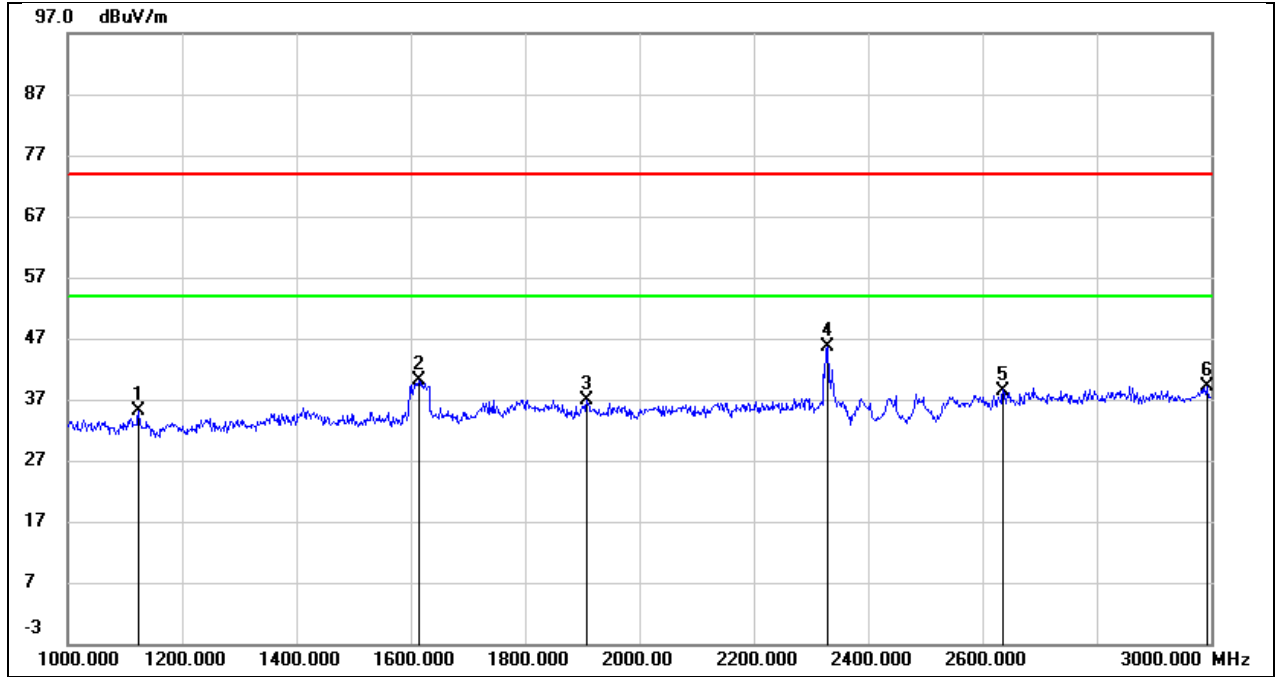

No.	Frequency (MHz)	Reading (dBuV)	Correct (dB/m)	Result (dBuV/m)	Limit (dBuV/m)	Margin (dB)	Remark
1	1124.000	48.47	-13.30	35.17	74.00	-38.83	peak
2	1614.000	51.07	-11.00	40.07	74.00	-33.93	peak
3	1908.000	46.12	-9.28	36.84	74.00	-37.16	peak
4	2330.000	53.57	-8.02	45.55	74.00	-28.45	peak
5	2636.000	45.17	-6.67	38.50	74.00	-35.50	peak
6	2992.000	43.95	-4.75	39.20	74.00	-34.80	peak

Test Mode:	BLE 1M	Frequency(MHz):	2480
Polarity:	Horizontal	Test Voltage:	AC 120V_60Hz

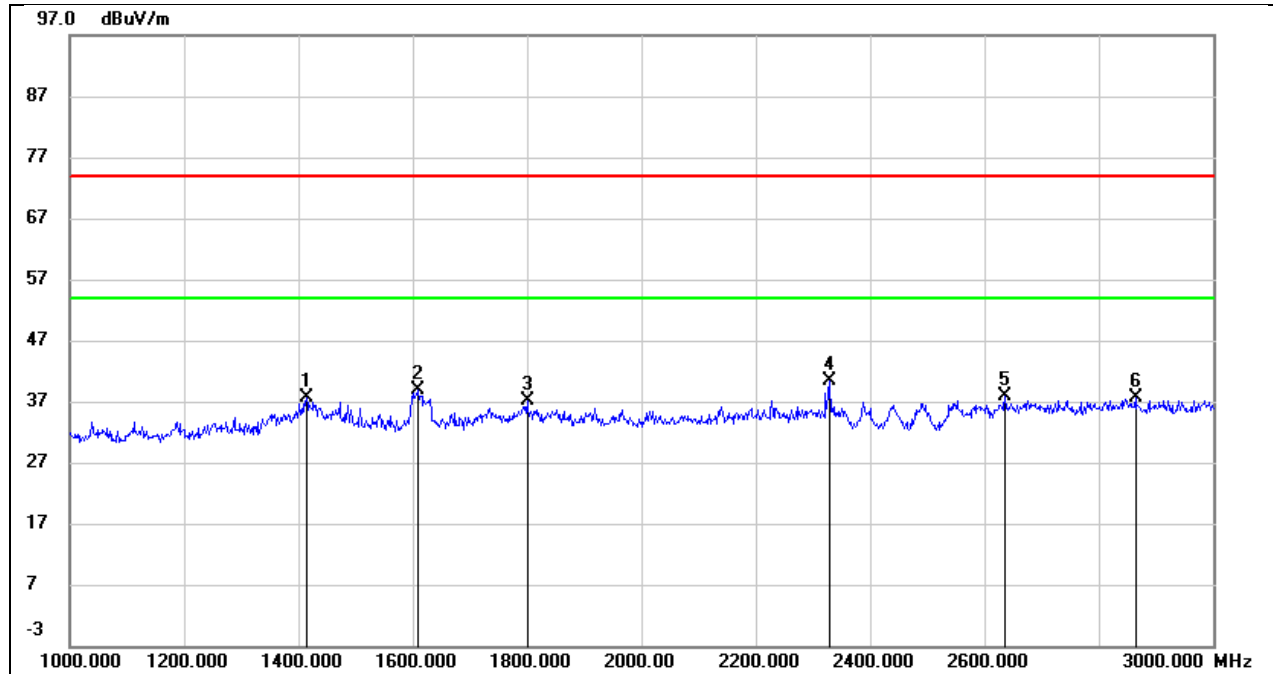

No.	Frequency (MHz)	Reading (dBuV)	Correct (dB/m)	Result (dBuV/m)	Limit (dBuV/m)	Margin (dB)	Remark
1	1414.000	50.05	-12.38	37.67	74.00	-36.33	peak
2	1610.000	50.26	-11.31	38.95	74.00	-35.05	peak
3	1800.000	47.18	-9.96	37.22	74.00	-36.78	peak
4	2328.000	49.14	-8.85	40.29	74.00	-33.71	peak
5	2636.000	45.53	-7.61	37.92	74.00	-36.08	peak
6	2864.000	44.24	-6.62	37.62	74.00	-36.38	peak

Test Mode:	BLE 1M	Frequency(MHz):	2480
Polarity:	Vertical	Test Voltage:	AC 120V_60Hz

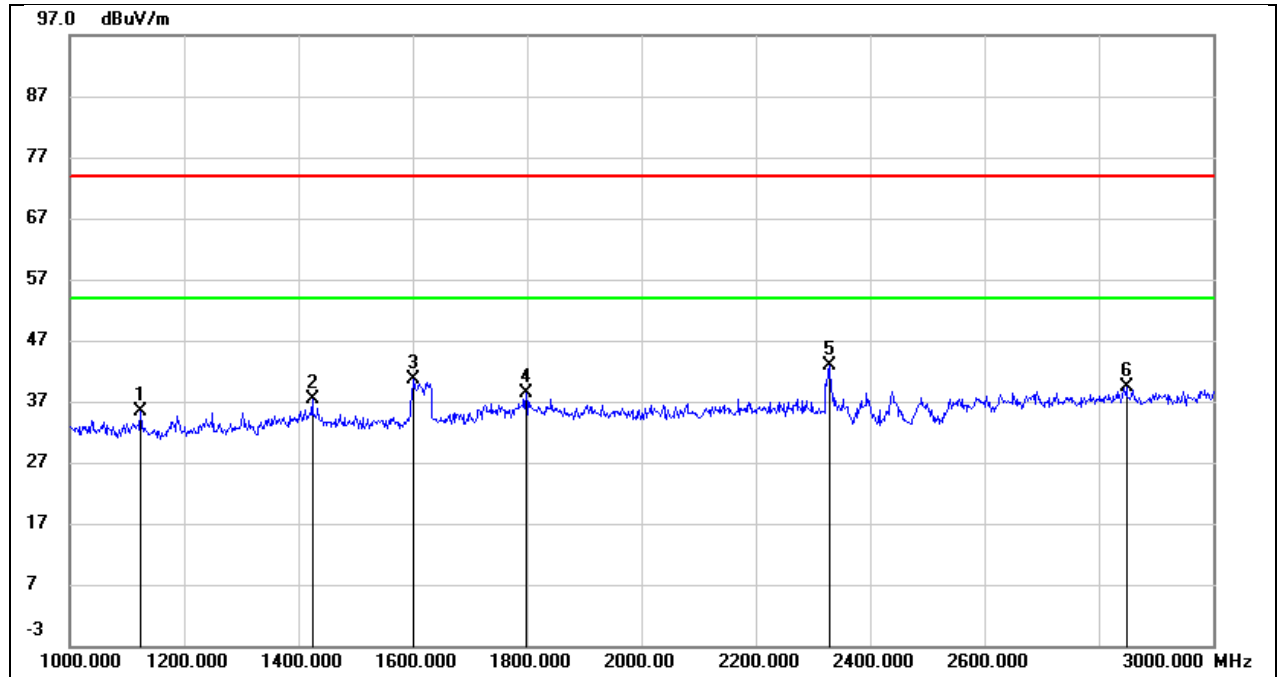

No.	Frequency (MHz)	Reading (dBuV)	Correct (dB/m)	Result (dBuV/m)	Limit (dBuV/m)	Margin (dB)	Remark
1	1124.000	48.80	-13.30	35.50	74.00	-38.50	peak
2	1424.000	49.55	-12.14	37.41	74.00	-36.59	peak
3	1602.000	51.70	-11.10	40.60	74.00	-33.40	peak
4	1798.000	47.73	-9.40	38.33	74.00	-35.67	peak
5	2328.000	50.81	-8.02	42.79	74.00	-31.21	peak
6	2848.000	44.83	-5.56	39.27	74.00	-34.73	peak

7.3. SPURIOUS EMISSIONS(3 GHZ~18 GHZ)

Test Mode:	BLE 1M	Frequency(MHz):	2402
Polarity:	Horizontal	Test Voltage:	AC 120V_60Hz

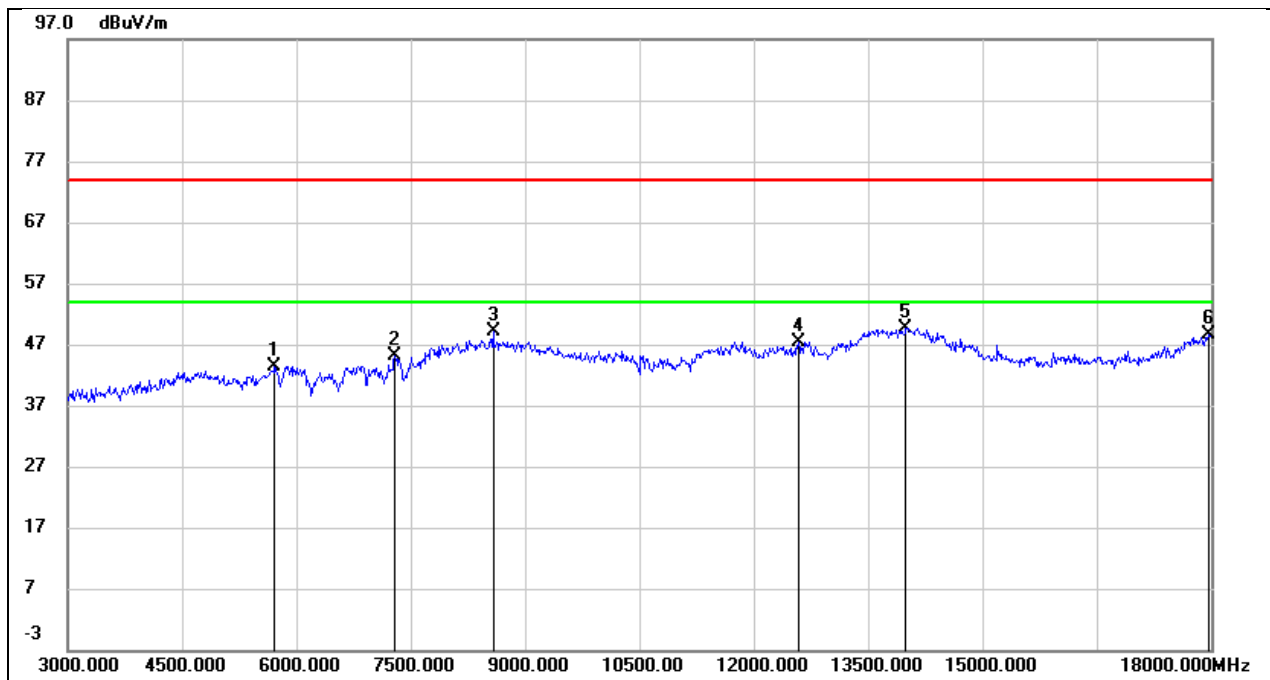

No.	Frequency (MHz)	Reading (dBuV)	Correct (dB/m)	Result (dBuV/m)	Limit (dBuV/m)	Margin (dB)	Remark
1	5715.000	40.87	2.55	43.42	74.00	-30.58	peak
2	7290.000	37.99	7.02	45.01	74.00	-28.99	peak
3	8580.000	39.76	9.26	49.02	74.00	-24.98	peak
4	12585.000	28.37	18.96	47.33	74.00	-26.67	peak
5	13995.000	25.96	23.78	49.74	74.00	-24.26	peak
6	17970.000	19.25	29.33	48.58	74.00	-25.42	peak

Test Mode:	BLE 1M	Frequency(MHz):	2402
Polarity:	Vertical	Test Voltage:	AC 120V_60Hz

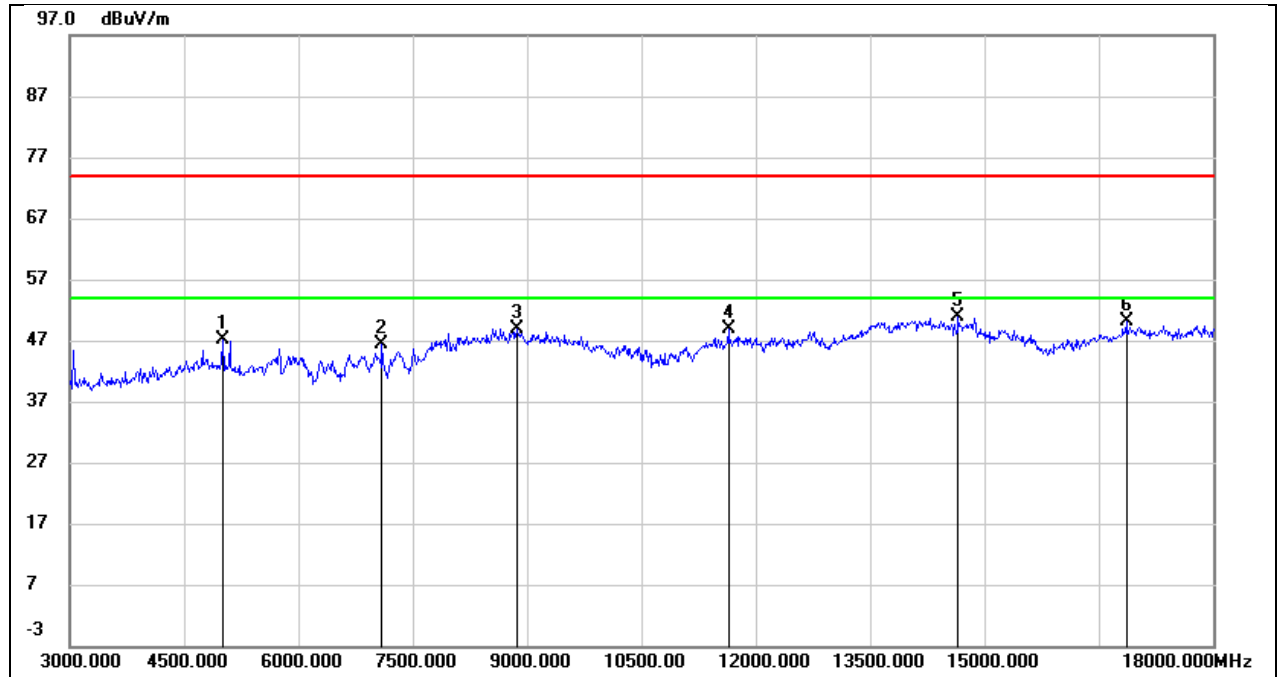

No.	Frequency (MHz)	Reading (dBuV)	Correct (dB/m)	Result (dBuV/m)	Limit (dBuV/m)	Margin (dB)	Remark
1	5010.000	44.90	2.16	47.06	74.00	-26.94	peak
2	7095.000	38.84	7.43	46.27	74.00	-27.73	peak
3	8865.000	38.75	10.21	48.96	74.00	-25.04	peak
4	11640.000	32.07	16.84	48.91	74.00	-25.09	peak
5	14655.000	29.53	21.26	50.79	74.00	-23.21	peak
6	16860.000	25.01	25.00	50.01	74.00	-23.99	peak

Test Mode:	BLE 1M	Frequency(MHz):	2440
Polarity:	Horizontal	Test Voltage:	AC 120V_60Hz

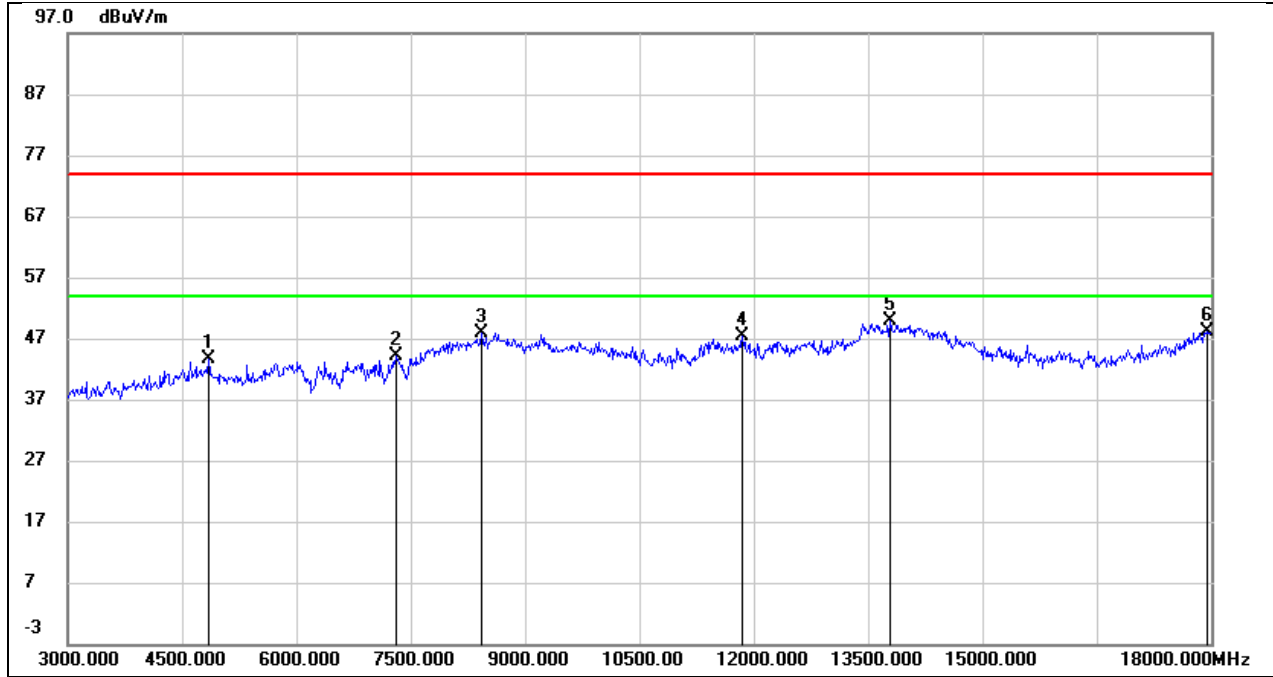

No.	Frequency (MHz)	Reading (dBuV)	Correct (dB/m)	Result (dBuV/m)	Limit (dBuV/m)	Margin (dB)	Remark
1	4845.000	43.09	0.58	43.67	74.00	-30.33	peak
2	7305.000	37.05	7.03	44.08	74.00	-29.92	peak
3	8430.000	39.02	8.93	47.95	74.00	-26.05	peak
4	11850.000	28.76	18.55	47.31	74.00	-26.69	peak
5	13785.000	26.88	22.90	49.78	74.00	-24.22	peak
6	17940.000	19.13	29.03	48.16	74.00	-25.84	peak

Test Mode:	BLE 1M	Frequency(MHz):	2440
Polarity:	Vertical	Test Voltage:	AC 120V_60Hz

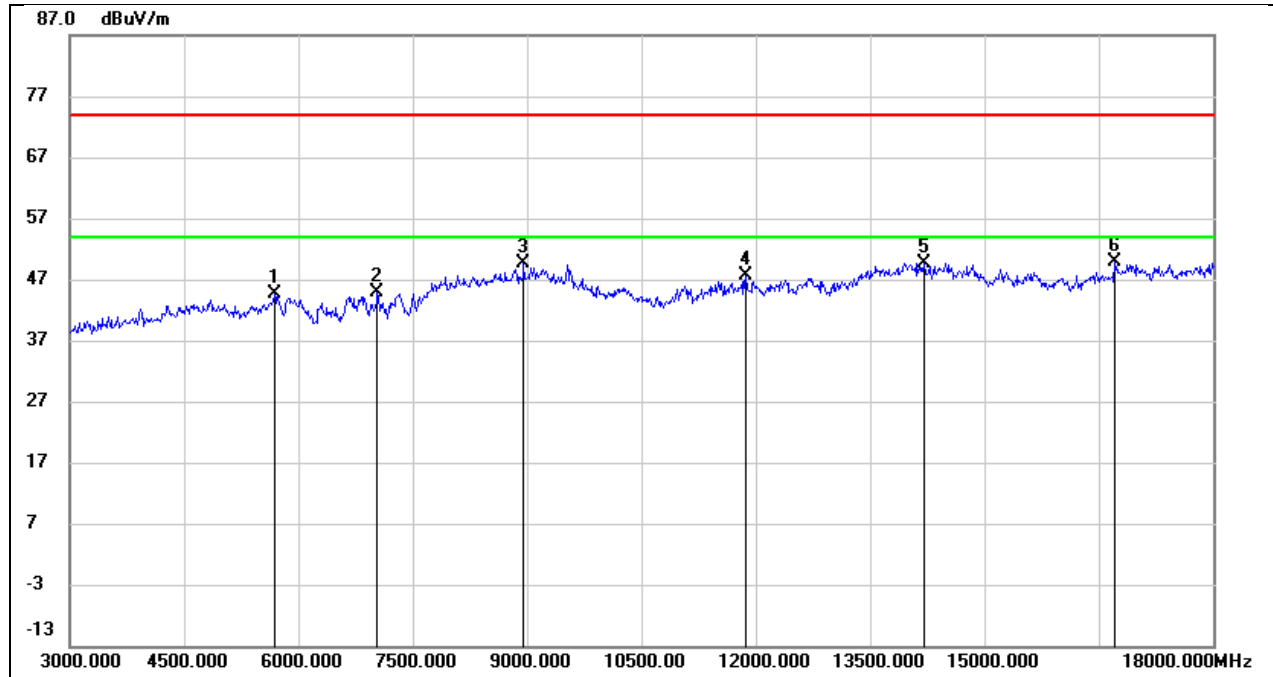

No.	Frequency (MHz)	Reading (dBuV)	Correct (dB/m)	Result (dBuV/m)	Limit (dBuV/m)	Margin (dB)	Remark
1	5685.000	40.96	3.63	44.59	74.00	-29.41	peak
2	7035.000	37.47	7.32	44.79	74.00	-29.21	peak
3	8955.000	39.13	10.45	49.58	74.00	-24.42	peak
4	11865.000	30.36	17.37	47.73	74.00	-26.27	peak
5	14205.000	27.46	22.26	49.72	74.00	-24.28	peak
6	16710.000	25.20	24.67	49.87	74.00	-24.13	peak

Test Mode:	BLE 1M	Frequency(MHz):	2480
Polarity:	Horizontal	Test Voltage:	AC 120V_60Hz

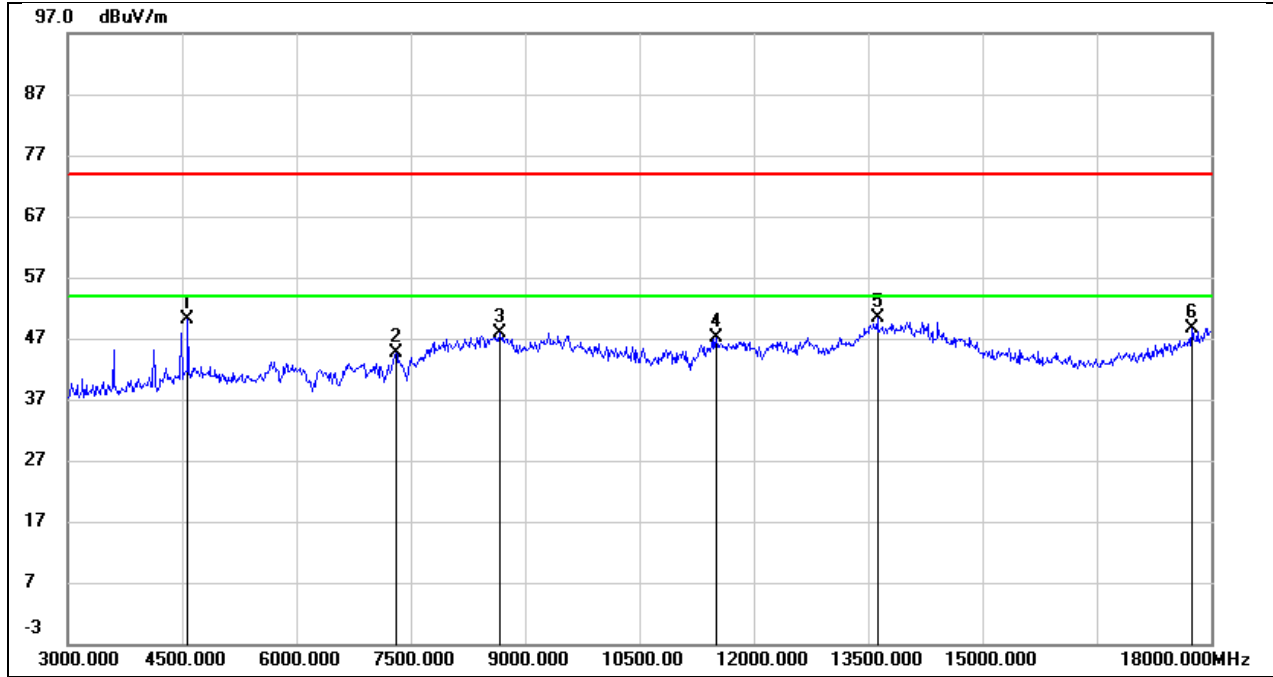

No.	Frequency (MHz)	Reading (dBuV)	Correct (dB/m)	Result (dBuV/m)	Limit (dBuV/m)	Margin (dB)	Remark
1	4575.000	50.36	-0.21	50.15	74.00	-23.85	peak
2	7305.000	37.53	7.03	44.56	74.00	-29.44	peak
3	8670.000	38.60	9.40	48.00	74.00	-26.00	peak
4	11505.000	29.06	17.99	47.05	74.00	-26.95	peak
5	13620.000	27.80	22.65	50.45	74.00	-23.55	peak
6	17745.000	21.43	27.20	48.63	74.00	-25.37	peak

Test Mode:	BLE 1M	Frequency(MHz):	2480
Polarity:	Vertical	Test Voltage:	AC 120V_60Hz

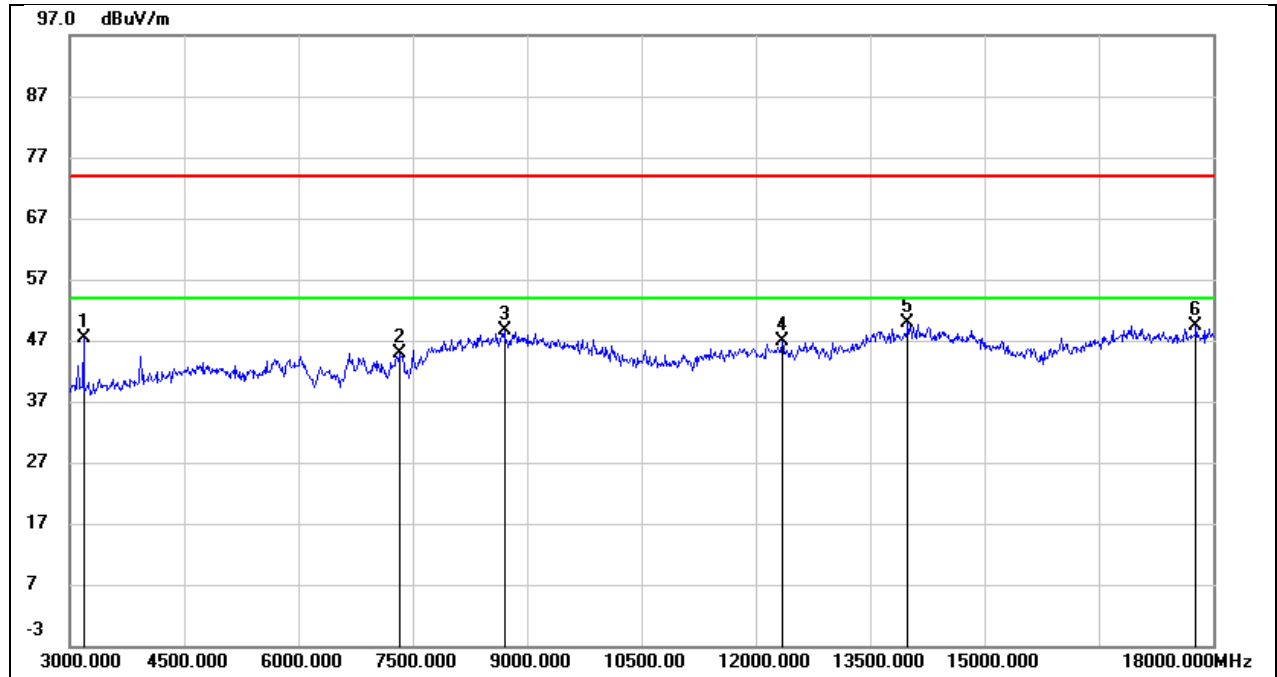

No.	Frequency (MHz)	Reading (dBuV)	Correct (dB/m)	Result (dBuV/m)	Limit (dBuV/m)	Margin (dB)	Remark
1	3180.000	50.37	-3.10	47.27	74.00	-26.73	peak
2	7320.000	37.14	7.69	44.83	74.00	-29.17	peak
3	8700.000	38.60	9.95	48.55	74.00	-25.45	peak
4	12345.000	28.94	17.94	46.88	74.00	-27.12	peak
5	13995.000	27.81	22.18	49.99	74.00	-24.01	peak
6	17775.000	23.06	26.21	49.27	74.00	-24.73	peak

Test Mode:	BLE 2M	Frequency(MHz):	2402
Polarity:	Horizontal	Test Voltage:	AC 120V_60Hz

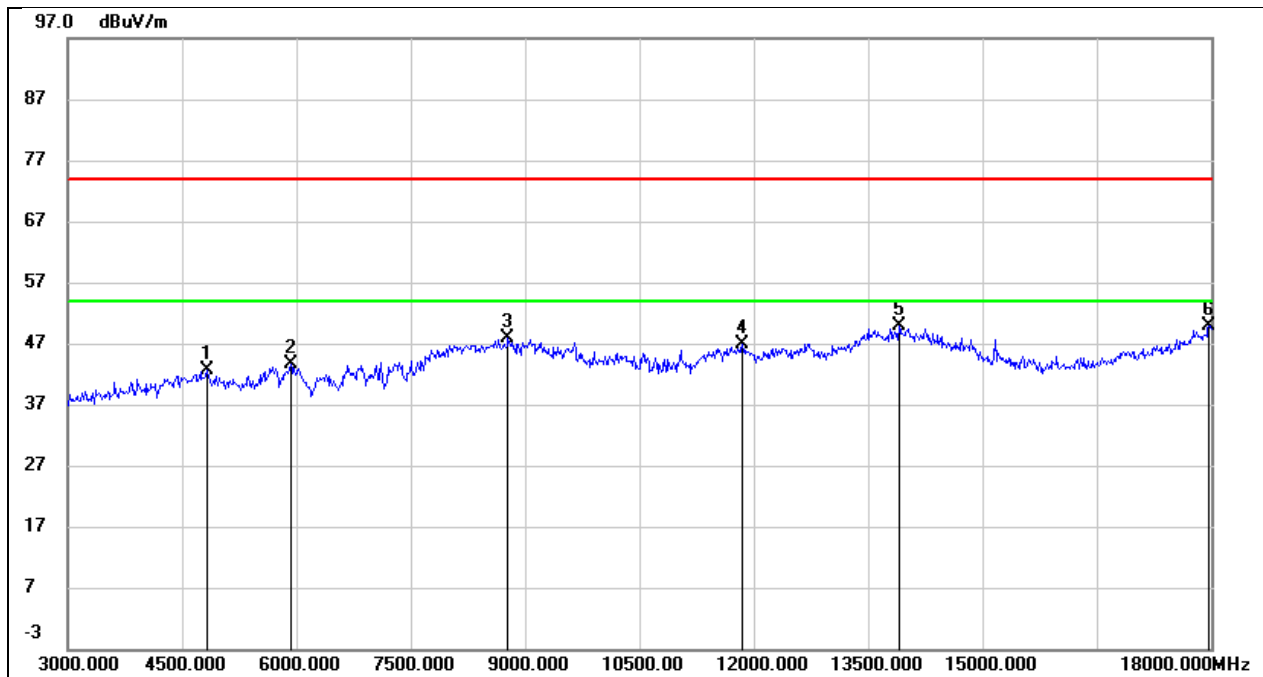

No.	Frequency (MHz)	Reading (dBuV)	Correct (dB/m)	Result (dBuV/m)	Limit (dBuV/m)	Margin (dB)	Remark
1	4830.000	42.18	0.54	42.72	74.00	-31.28	peak
2	5925.000	40.57	2.99	43.56	74.00	-30.44	peak
3	8775.000	38.37	9.53	47.90	74.00	-26.10	peak
4	11850.000	28.39	18.55	46.94	74.00	-27.06	peak
5	13905.000	26.48	23.38	49.86	74.00	-24.14	peak
6	17970.000	20.61	29.33	49.94	74.00	-24.06	peak

Test Mode:	BLE 2M	Frequency(MHz):	2402
Polarity:	Vertical	Test Voltage:	AC 120V_60Hz

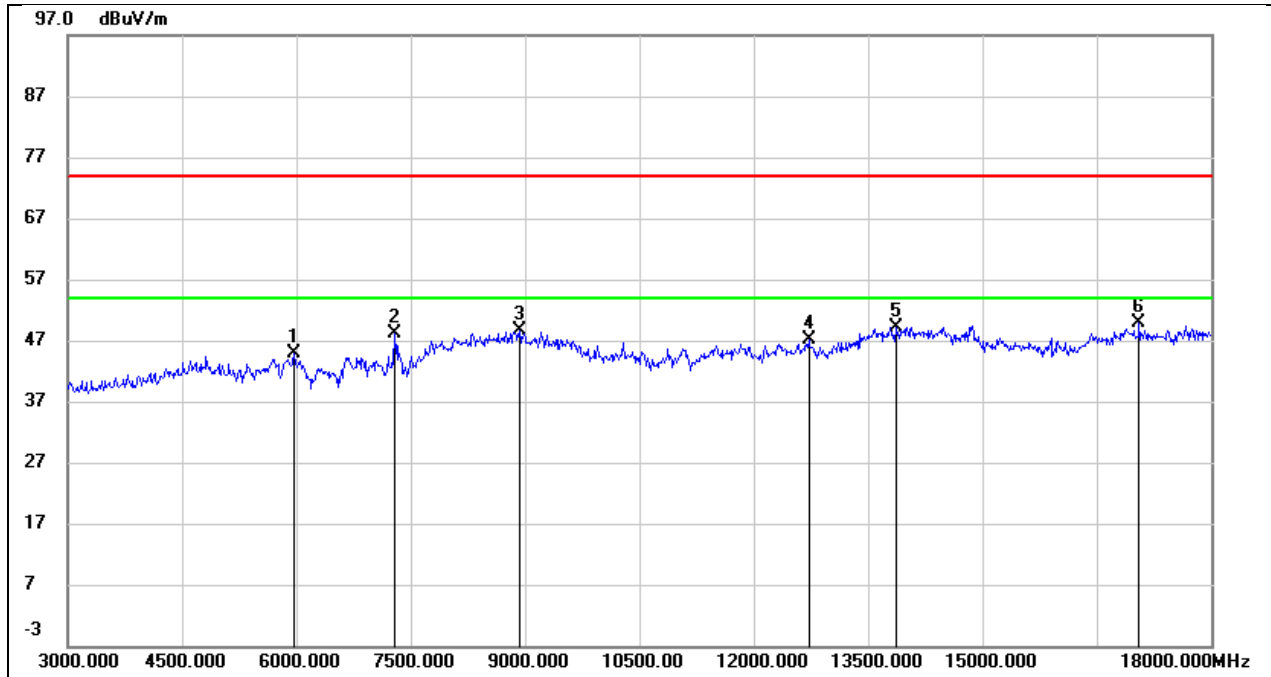

No.	Frequency (MHz)	Reading (dBuV)	Correct (dB/m)	Result (dBuV/m)	Limit (dBuV/m)	Margin (dB)	Remark
1	5970.000	40.74	4.08	44.82	74.00	-29.18	peak
2	7290.000	40.44	7.68	48.12	74.00	-25.88	peak
3	8925.000	38.35	10.37	48.72	74.00	-25.28	peak
4	12720.000	28.87	18.26	47.13	74.00	-26.87	peak
5	13860.000	27.69	21.56	49.25	74.00	-24.75	peak
6	17055.000	24.59	25.21	49.80	74.00	-24.20	peak

Test Mode:	BLE 2M	Frequency(MHz):	2440
Polarity:	Horizontal	Test Voltage:	AC 120V_60Hz

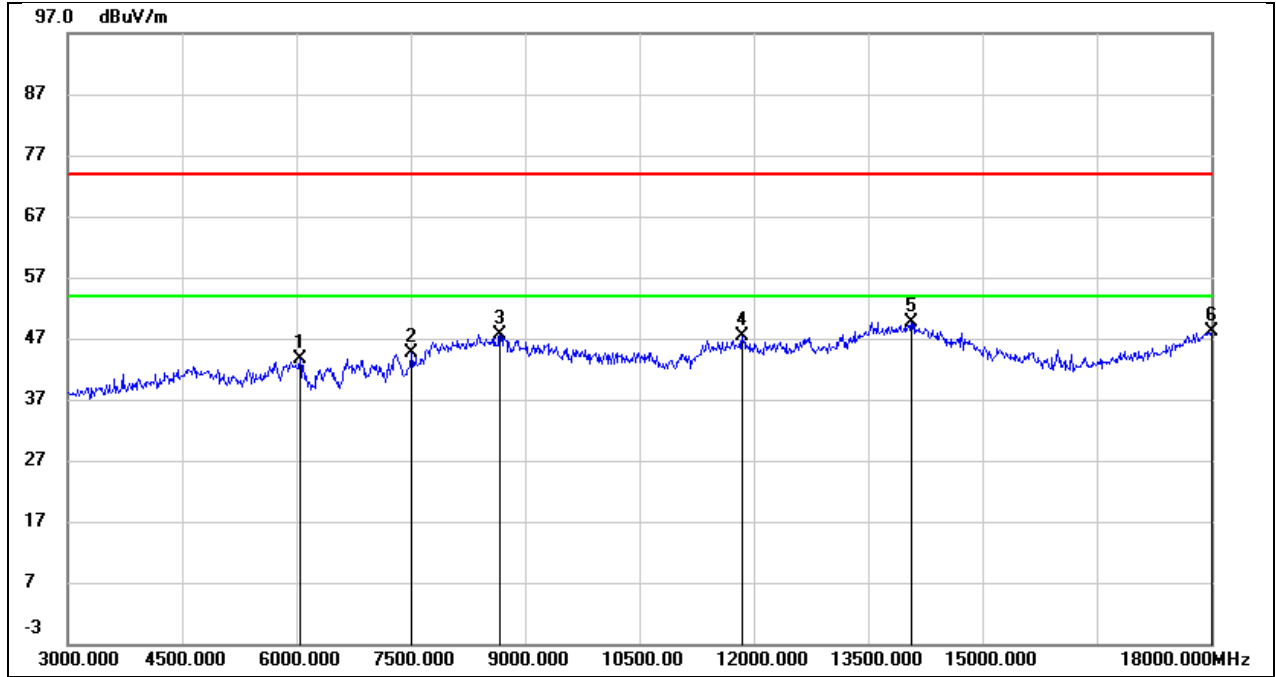

No.	Frequency (MHz)	Reading (dBuV)	Correct (dB/m)	Result (dBuV/m)	Limit (dBuV/m)	Margin (dB)	Remark
1	6045.000	40.27	3.33	43.60	74.00	-30.40	peak
2	7515.000	37.17	7.42	44.59	74.00	-29.41	peak
3	8670.000	38.32	9.40	47.72	74.00	-26.28	peak
4	11850.000	28.72	18.55	47.27	74.00	-26.73	peak
5	14070.000	26.05	23.65	49.70	74.00	-24.30	peak
6	18000.000	18.55	29.64	48.19	74.00	-25.81	peak

Test Mode:	BLE 2M	Frequency(MHz):	2440
Polarity:	Vertical	Test Voltage:	AC 120V_60Hz

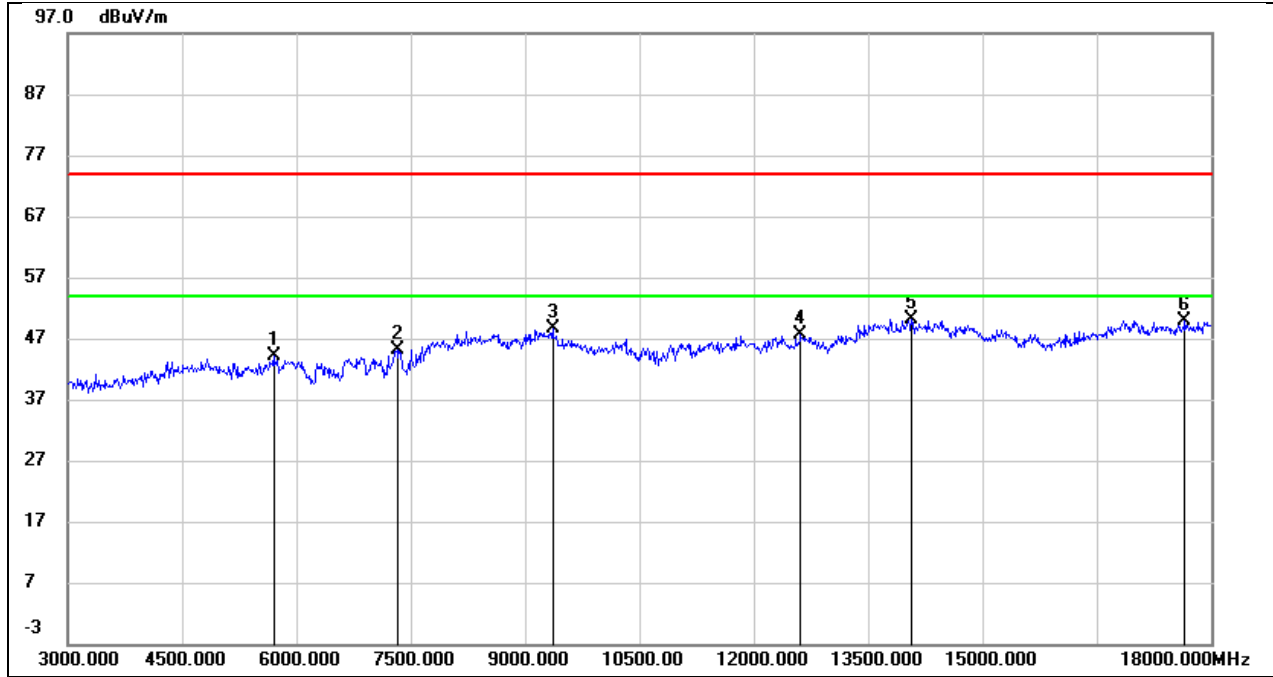

No.	Frequency (MHz)	Reading (dBuV)	Correct (dB/m)	Result (dBuV/m)	Limit (dBuV/m)	Margin (dB)	Remark
1	5700.000	40.39	3.65	44.04	74.00	-29.96	peak
2	7320.000	37.48	7.69	45.17	74.00	-28.83	peak
3	9360.000	36.83	11.89	48.72	74.00	-25.28	peak
4	12615.000	29.61	18.04	47.65	74.00	-26.35	peak
5	14070.000	27.92	22.23	50.15	74.00	-23.85	peak
6	17655.000	24.02	25.87	49.89	74.00	-24.11	peak

Test Mode:	BLE 2M	Frequency(MHz):	2480
Polarity:	Horizontal	Test Voltage:	AC 120V_60Hz

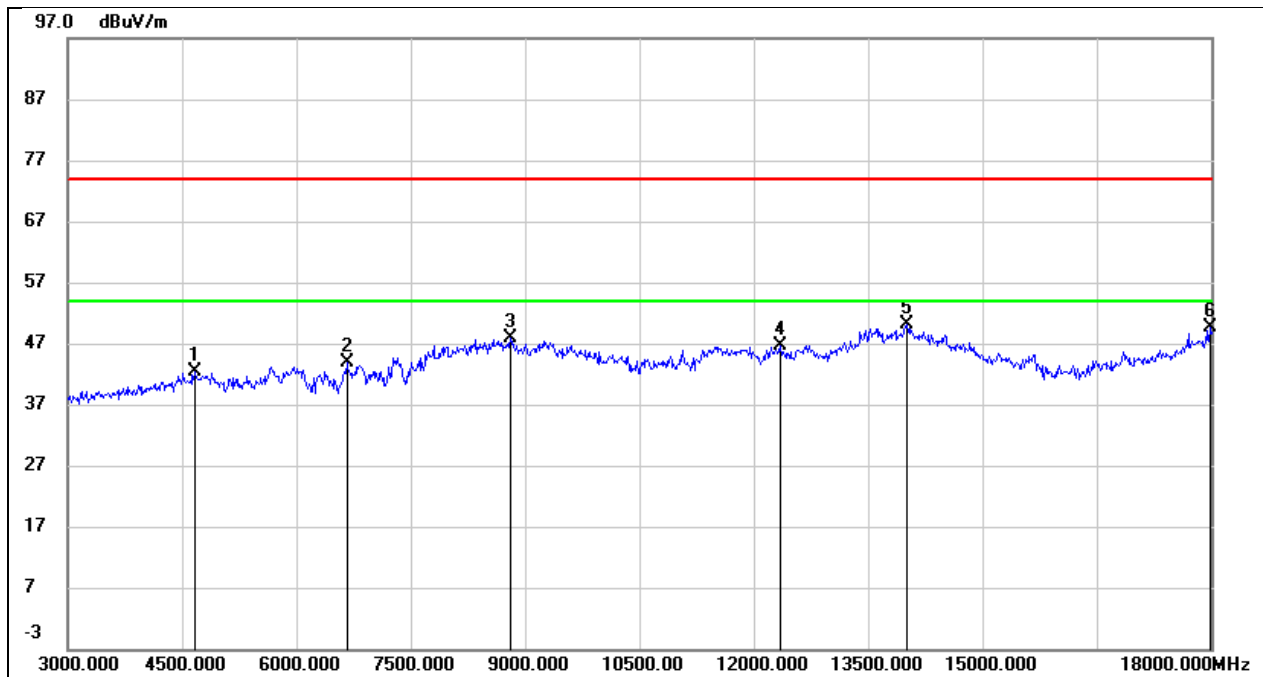

No.	Frequency (MHz)	Reading (dBuV)	Correct (dB/m)	Result (dBuV/m)	Limit (dBuV/m)	Margin (dB)	Remark
1	4665.000	42.42	0.06	42.48	74.00	-31.52	peak
2	6660.000	38.52	5.31	43.83	74.00	-30.17	peak
3	8805.000	38.42	9.58	48.00	74.00	-26.00	peak
4	12345.000	27.82	18.90	46.72	74.00	-27.28	peak
5	14010.000	26.39	23.78	50.17	74.00	-23.83	peak
6	17985.000	20.20	29.49	49.69	74.00	-24.31	peak

Test Mode:	BLE 2M	Frequency(MHz):	2480
Polarity:	Vertical	Test Voltage:	AC 120V_60Hz

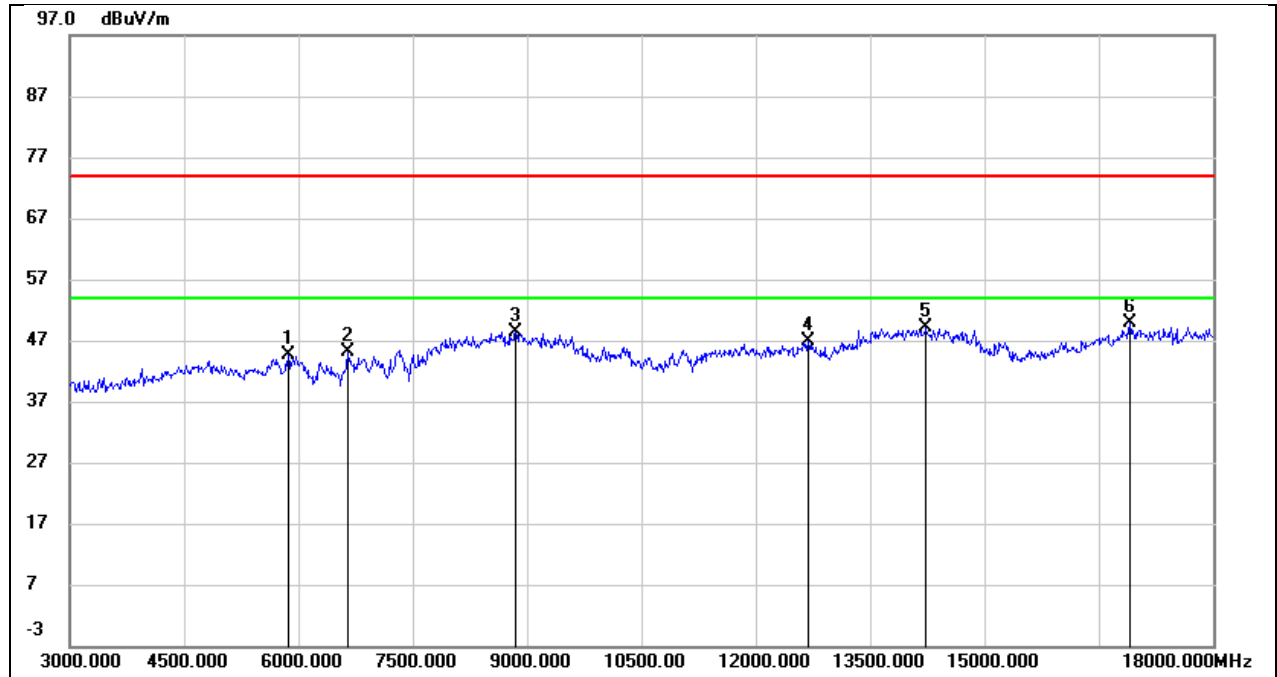

No.	Frequency (MHz)	Reading (dBuV)	Correct (dB/m)	Result (dBuV/m)	Limit (dBuV/m)	Margin (dB)	Remark
1	5865.000	40.67	3.92	44.59	74.00	-29.41	peak
2	6645.000	39.13	6.07	45.20	74.00	-28.80	peak
3	8850.000	38.20	10.18	48.38	74.00	-25.62	peak
4	12690.000	28.63	18.19	46.82	74.00	-27.18	peak
5	14235.000	26.84	22.17	49.01	74.00	-24.99	peak
6	16905.000	24.73	25.06	49.79	74.00	-24.21	peak

7.4. SPURIOUS EMISSIONS(9 KHZ~30 MHZ)

Test Mode:	BLE 1M	Frequency(MHz):	2402
Polarity:	Horizontal	Test Voltage:	AC 120V_60HZ

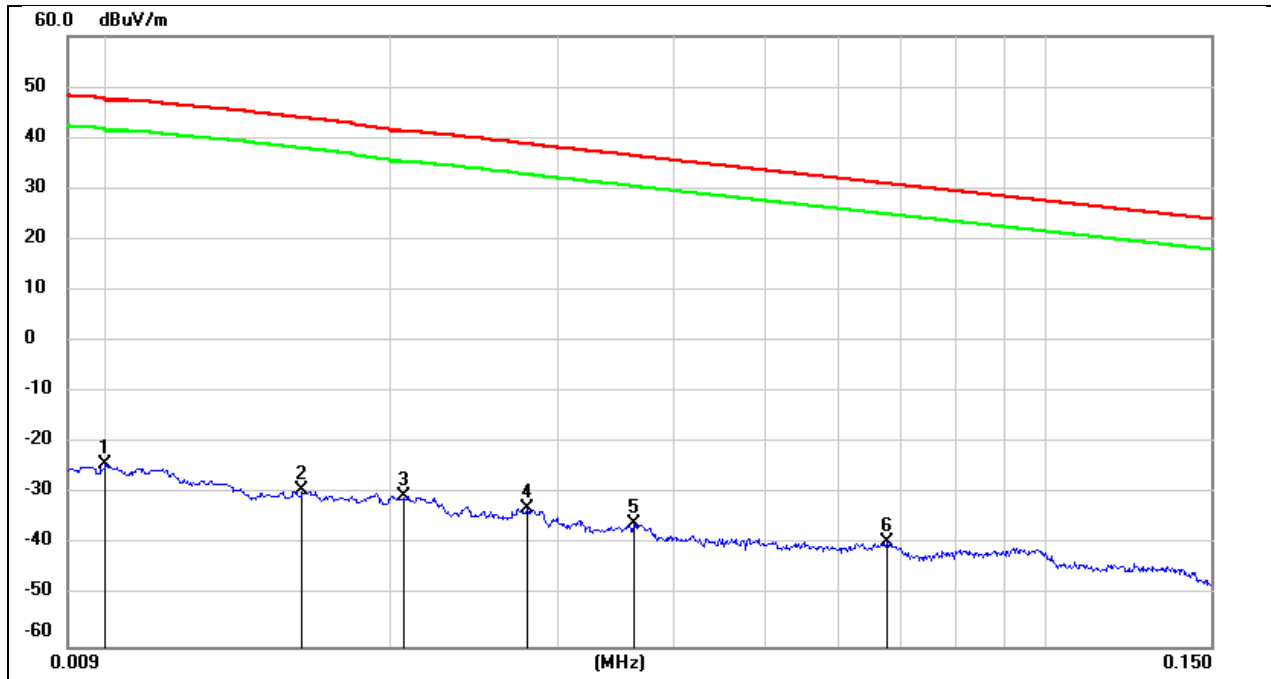

No.	Frequency (KHz)	Reading (dBuV)	Correct (dB/m)	Result (dBuV/m)	Limit (dBuV/m)	Margin (dB)	Remark
1	0.0100	77.22	-101.40	-24.18	47.60	-71.78	peak
2	0.0160	71.97	-101.37	-29.40	43.99	-73.39	peak
3	0.0206	70.92	-101.35	-30.43	41.37	-71.80	peak
4	0.0279	68.67	-101.38	-32.71	38.80	-71.51	peak
5	0.0362	65.51	-101.42	-35.91	36.51	-72.42	peak
6	0.0675	62.14	-101.56	-39.42	31.03	-70.45	peak

Test Mode:	BLE 1M	Frequency(MHz):	2402
Polarity:	Horizontal	Test Voltage:	AC 120V_60HZ

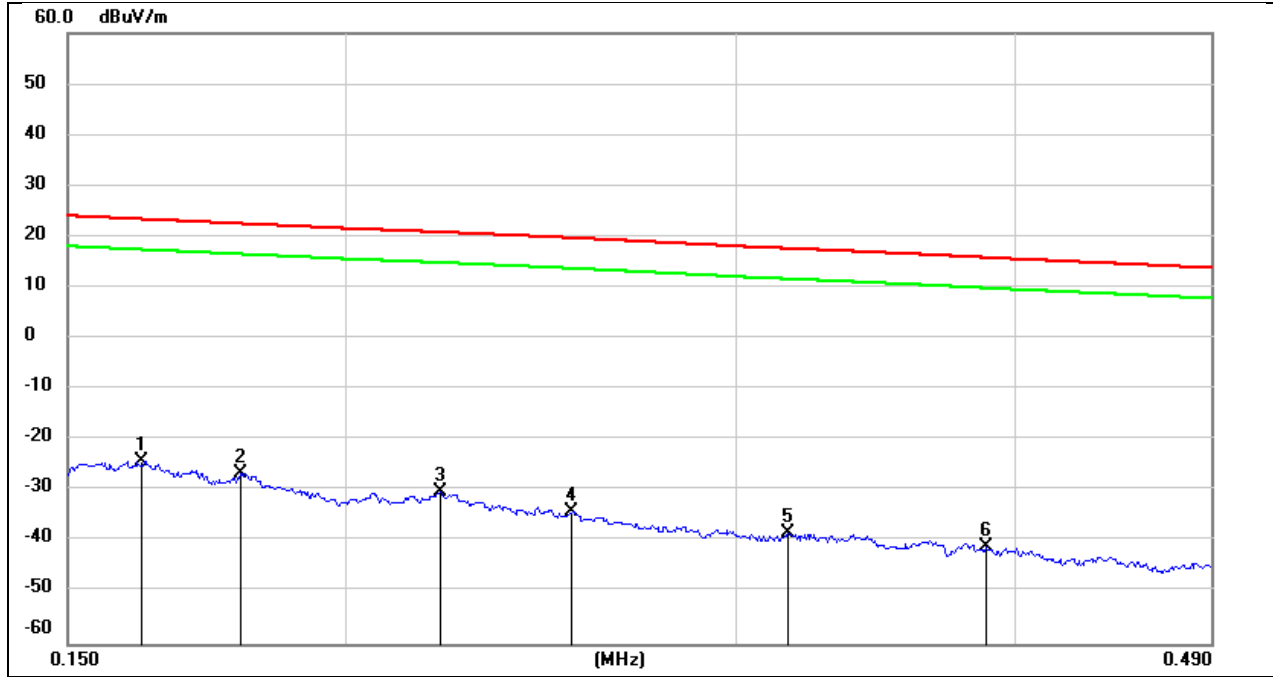

No.	Frequency (KHz)	Reading (dBuV)	Correct (dB/m)	Result (dBuV/m)	Limit (dBuV/m)	Margin (dB)	Remark
1	0.1621	77.42	-101.65	-24.23	23.41	-47.64	peak
2	0.1794	75.27	-101.68	-26.41	22.53	-48.94	peak
3	0.2207	71.52	-101.75	-30.23	20.85	-51.08	peak
4	0.2530	67.64	-101.80	-34.16	19.71	-53.87	peak
5	0.3163	63.70	-101.87	-38.17	17.65	-55.82	peak
6	0.3881	60.90	-101.95	-41.05	15.86	-56.91	peak

Test Mode:	BLE 1M	Frequency(MHz):	2402
Polarity:	Horizontal	Test Voltage:	AC 120V_60HZ

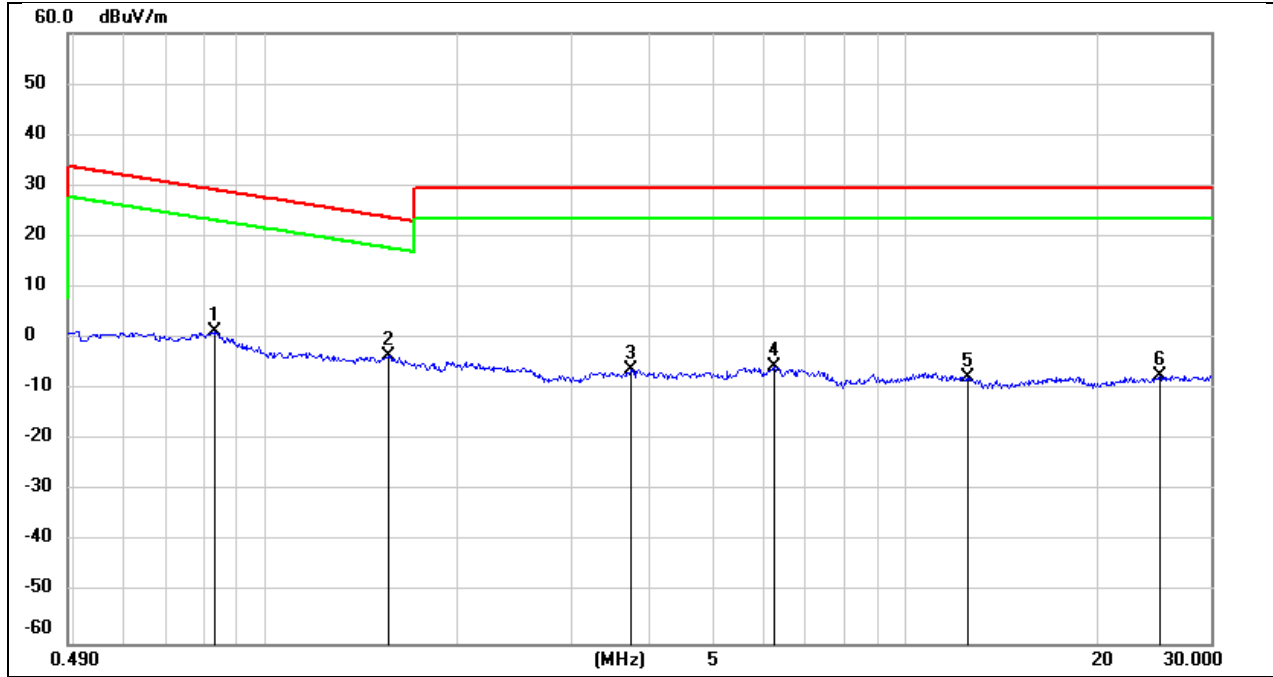

No.	Frequency (MHz)	Reading (dBuV)	Correct (dB/m)	Result (dBuV/m)	Limit (dBuV/m)	Margin (dB)	Remark
1	0.8296	63.44	-62.17	1.27	29.24	-27.97	peak
2	1.5564	58.68	-62.02	-3.34	23.76	-27.10	peak
3	3.7360	55.33	-61.40	-6.07	29.54	-35.61	peak
4	6.2445	55.63	-61.32	-5.69	29.54	-35.23	peak
5	12.5006	53.32	-60.91	-7.59	29.54	-37.13	peak
6	24.9832	53.11	-60.45	-7.34	29.54	-36.88	peak

7.5. SPURIOUS EMISSIONS(18 GHZ~26 GHZ)

Test Mode:	BLE 1M	Frequency(MHz):	2402
Polarity:	Horizontal	Test Voltage:	AC 120V_60HZ

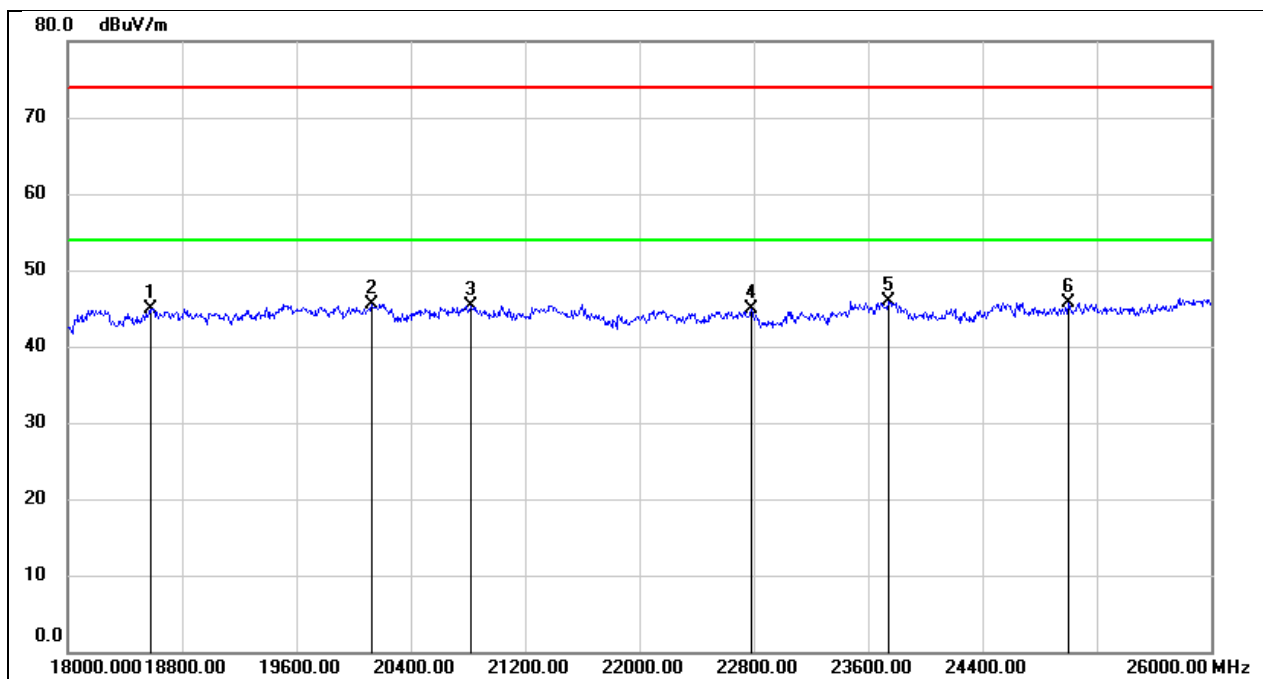

No.	Frequency (MHz)	Reading (dBuV)	Correct (dB/m)	Result (dBuV/m)	Limit (dBuV/m)	Margin (dB)	Remark
1	18576.000	50.22	-5.30	44.92	74.00	-29.08	peak
2	20128.000	51.12	-5.53	45.59	74.00	-28.41	peak
3	20824.000	50.33	-5.04	45.29	74.00	-28.71	peak
4	22784.000	48.48	-3.65	44.83	74.00	-29.17	peak
5	23744.000	49.15	-3.20	45.95	74.00	-28.05	peak
6	25000.000	47.86	-2.10	45.76	74.00	-28.24	peak

Test Mode:	BLE 1M	Frequency(MHz):	2402
Polarity:	Vertical	Test Voltage:	AC 120V_60HZ

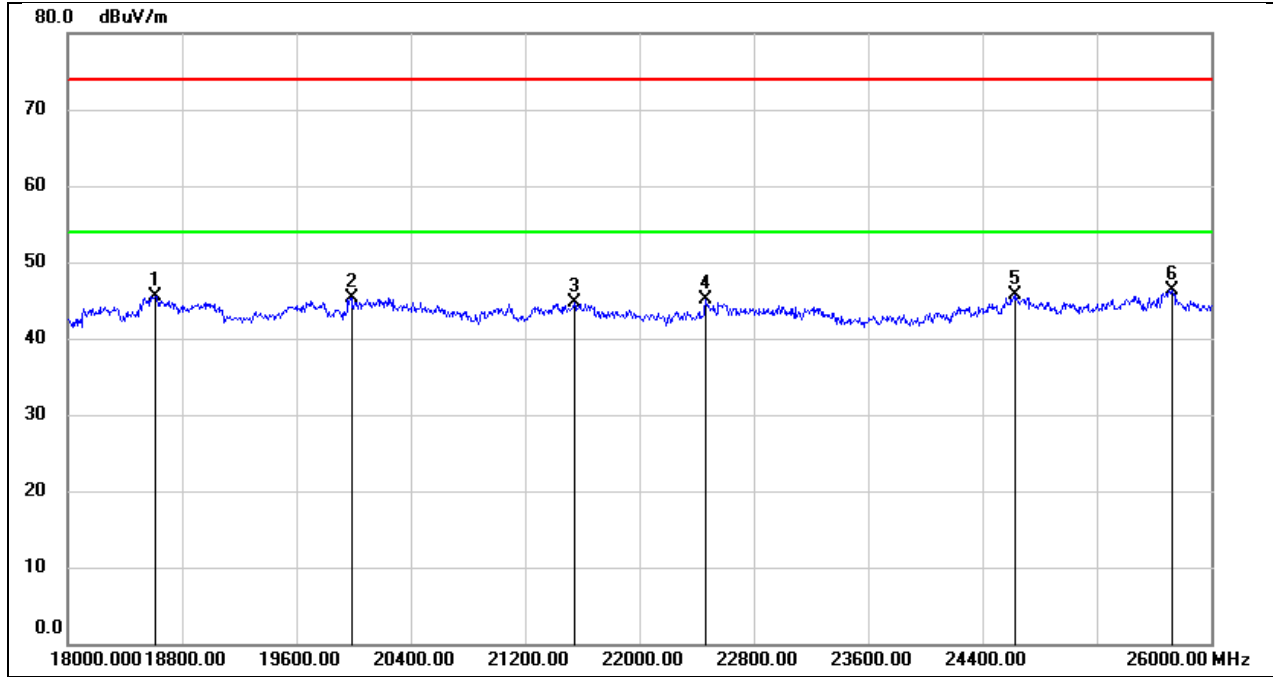

No.	Frequency (MHz)	Reading (dBuV)	Correct (dB/m)	Result (dBuV/m)	Limit (dBuV/m)	Margin (dB)	Remark
1	18616.000	50.89	-5.34	45.55	74.00	-28.45	peak
2	19984.000	50.71	-5.44	45.27	74.00	-28.73	peak
3	21544.000	49.26	-4.63	44.63	74.00	-29.37	peak
4	22464.000	48.97	-3.93	45.04	74.00	-28.96	peak
5	24624.000	47.99	-2.33	45.66	74.00	-28.34	peak
6	25728.000	47.11	-0.72	46.39	74.00	-27.61	peak

7.6. SPURIOUS EMISSIONS(30 MHZ~1 GHZ)

Test Mode:	BLE 1M	Frequency(MHz):	2402
Polarity:	Horizontal	Test Voltage:	AC120V_60Hz

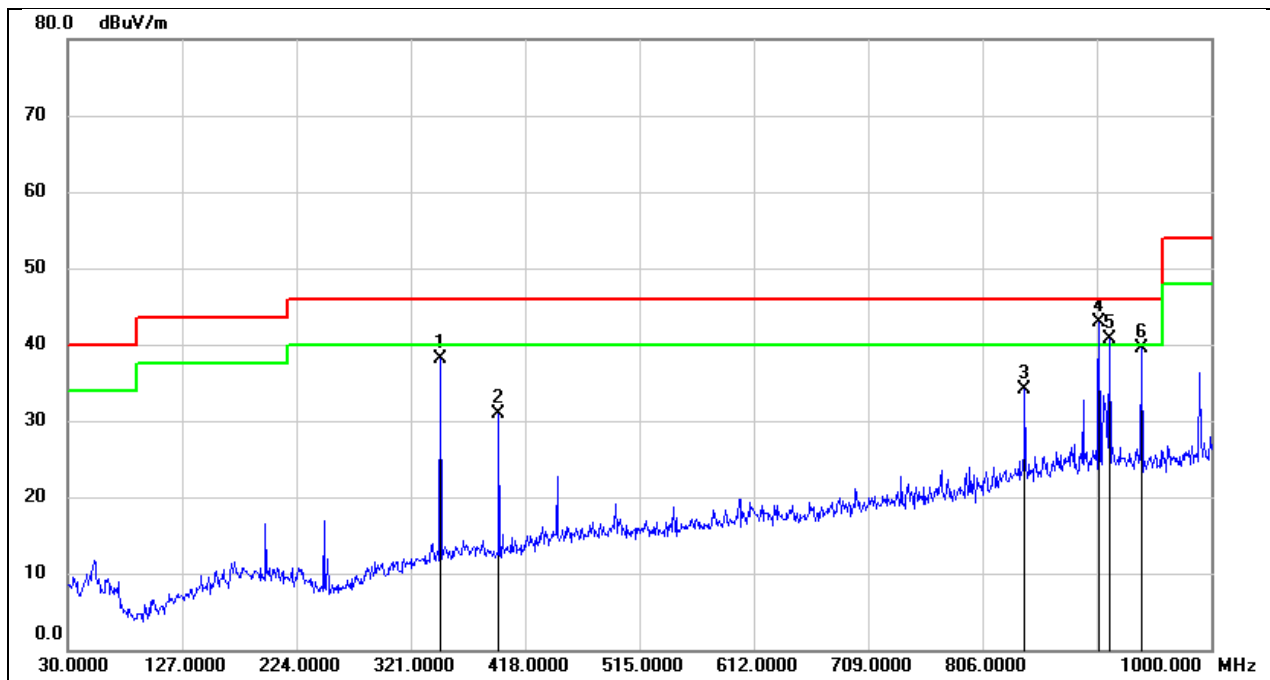

No.	Frequency (MHz)	Reading (dBuV)	Correct (dB/m)	Result (dBuV/m)	Limit (dBuV/m)	Margin (dB)	Remark
1	346.2200	47.84	-9.69	38.15	46.00	-7.85	QP
2	395.6900	40.53	-9.62	30.91	46.00	-15.09	QP
3	841.8900	35.66	-1.47	34.19	46.00	-11.81	QP
4	904.9400	43.41	-0.45	42.96	46.00	-3.04	QP
5	913.6700	41.26	-0.50	40.76	46.00	-5.24	QP
6	940.8300	40.28	-0.74	39.54	46.00	-6.46	QP

Test Mode:	BLE 1M	Frequency(MHz):	2402
Polarity:	Vertical	Test Voltage:	AC120V_60Hz

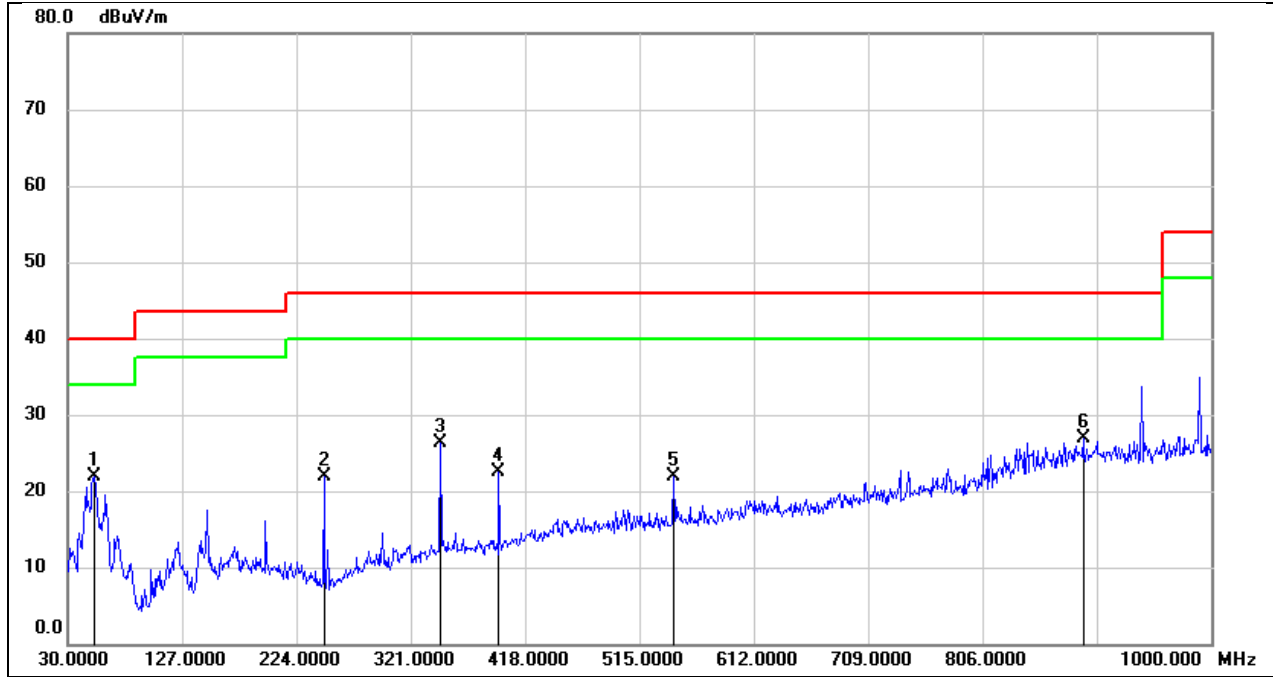

No.	Frequency (MHz)	Reading (dBuV)	Correct (dB/m)	Result (dBuV/m)	Limit (dBuV/m)	Margin (dB)	Remark
1	52.3100	36.89	-15.05	21.84	40.00	-18.16	QP
2	247.2800	36.34	-14.43	21.91	46.00	-24.09	QP
3	346.2200	36.08	-9.69	26.39	46.00	-19.61	QP
4	395.6900	32.14	-9.62	22.52	46.00	-23.48	QP
5	544.1000	28.95	-7.13	21.82	46.00	-24.18	QP
6	891.3600	27.41	-0.58	26.83	46.00	-19.17	QP

8. ANTENNA REQUIREMENT

REQUIREMENT

Please refer to FCC part 15.203

An intentional radiator shall be designed to ensure that no antenna other than that furnished by the responsible party shall be used with the device. The use of a permanently attached antenna or of an antenna that uses a unique coupling to the intentional radiator shall be considered sufficient to comply with the provisions of this section. The manufacturer may design the unit so that a broken antenna can be replaced by the user, but the use of a standard antenna jack or electrical connector is prohibited.

Please refer to FCC part 15.247(b)(4)

The conducted output power limit specified in paragraph (b) of this section is based on the use of antennas with directional gains that do not exceed 6 dBi. Except as shown in paragraph (c) of this section, if transmitting antennas of directional gain greater than 6 dBi are used, the conducted output power from the intentional radiator shall be reduced below the stated values in paragraphs (b)(1), (b)(2), and (b)(3) of this section, as appropriate, by the amount in dB that the directional gain of the antenna exceeds 6 dBi.

DESCRIPTION

Pass

END OF REPORT