

FCC Measurement/Technical Report on

JODY-W354-20A

WLAN and Bluetooth Module

FCC ID: XPYJODYW374
IC: 8595A-JODYW374

Test Report Reference: MDE_UBLOX_2220_FCC_03

Test Laboratory:

7layers GmbH
Borsigstrasse 11
40880 Ratingen
Germany



Deutsche
Akkreditierungsstelle
D-PL-12140-01-01
D-PL-12140-01-02
D-PL-12140-01-03

Note:

The following test results relate only to the devices specified in this document. This report shall not be reproduced in parts without the written approval of the test laboratory.

7layers GmbH

Borsigstraße 11
40880 Ratingen, Germany
T +49 (0) 2102 749 0
F +49 (0) 2102 749 350

Geschäftsführer/
Managing Directors:
Sebastian Doose
Stefan Kischka
Bernhard Retka

Registergericht/registered:
Düsseldorf HRB 75554
USt-Id.-Nr./VAT-No. DE203159652
Steuer-Nr./TAX-No. 147/5869/0385

*a Bureau Veritas
Group Company*

www.7layers.com

Table of Contents

1 Applied Standards and Test Summary	3
1.1 Applied Standards	3
1.2 FCC-IC Correlation Table	4
1.3 Measurement Summary	4
2 Revision History / Signatures	7
3 Administrative Data	8
3.1 Testing Laboratory	8
3.2 Project Data	8
3.3 Applicant Data	8
3.4 Manufacturer Data	9
4 Test object Data	10
4.1 General EUT Description	10
4.2 EUT Main components	10
4.3 Ancillary Equipment	11
4.4 Auxiliary Equipment	11
4.5 EUT Setups	12
4.6 Operating Modes / Test Channels	12
4.7 Product labelling	12
5 Test Results	13
5.1 Peak Power Output	13
5.2 Transmitter Spurious Radiated Emissions	18
5.3 Band Edge Compliance Radiated	23
6 Test Equipment	42
6.1 Test Equipment Hardware	42
6.2 Test Equipment Software	42
7 Antenna Factors, Cable Loss and Sample Calculations	45
7.1 LISN R&S ESH3-Z5 (150 kHz – 30 MHz)	45
7.2 Antenna R&S HFH2-Z2 (9 kHz – 30 MHz)	46
7.3 Antenna R&S HL562 (30 MHz – 1 GHz)	47
7.4 Antenna R&S HF907 (1 GHz – 18 GHz)	48
7.5 Antenna EMCO 3160-09 (18 GHz – 26.5 GHz)	49
7.6 Antenna EMCO 3160-10 (26.5 GHz – 40 GHz)	50
8 Measurement Uncertainties	51
9 Photo Report	52

1 APPLIED STANDARDS AND TEST SUMMARY

1.1 APPLIED STANDARDS

Type of Authorization

Certification for an Intentional Radiator.

Applicable FCC Rules

Prepared in accordance with the requirements of FCC Rules and Regulations as listed in 47 CFR Ch.1 Parts 2 and 15 (10-1-21 Edition). The following subparts are applicable to the results in this test report.

Part 2, Subpart J - Equipment Authorization Procedures, Certification

Part 15, Subpart C – Intentional Radiators

§ 15.201 Equipment authorization requirement

§ 15.207 Conducted limits

§ 15.209 Radiated emission limits; general requirements

§ 15.247 Operation within the bands 902-928 MHz, 2400-2483.5 MHz

Note:

The tests were selected and performed with reference to the FCC Public Notice "Guidance for Compliance Measurements on Digital Transmission System, Frequency Hopping Spread Spectrum System, and Hybrid System Devices Operating under Section 15.247 of the FCC Rules, 558074 D01 15.247 Meas Guidance v05r02, 2019-04-02". ANSI C63.10-2013 is applied.

1.2 FCC-IC CORRELATION TABLE

Correlation of measurement requirements for DTS (e.g. WLAN 2.4 GHz, BT LE) equipment from FCC and IC

DTS equipment

Measurement	FCC reference	IC reference
Conducted emissions on AC Mains	§ 15.207	RSS-Gen Issue 5: 8.8
Occupied bandwidth	§ 15.247 (a) (2)	RSS-247 Issue 2: 5.2 (a)
Peak conducted output power	§ 15.247 (b) (3), (4)	RSS-247 Issue 2: 5.4 (d)
Transmitter spurious RF conducted emissions	§ 15.247 (d)	RSS-Gen Issue 5: 6.13 / 8.9/8.10; RSS-247 Issue 2: 5.5
Transmitter spurious radiated emissions	§ 15.247 (d); § 15.209 (a)	RSS-Gen Issue 5: 6.13 / 8.9/8.10; RSS-247 Issue 2: 5.5
Band edge compliance	§ 15.247 (d)	RSS-247 Issue 2: 5.5
Power density	§ 15.247 (e)	RSS-247 Issue 2: 5.2 (b)
Antenna requirement	§ 15.203 / 15.204	RSS-Gen Issue 5: 8.3
Receiver spurious emissions	-	-

1.3 MEASUREMENT SUMMARY

47 CFR CHAPTER I FCC PART 15 § 15.247 (b) (3)
Subpart C §15.247

Peak Power Output
 The measurement was performed according to ANSI C63.10, chapter 11.9.1.3 **Final Result**

OP-Mode Radio Technology, Operating Frequency, Measurement method	Setup	Date	FCC	IC
WLAN ax 20 MHz, high, conducted	S01_354_20_BB01	2022-10-04	Passed	Passed
WLAN ax 20 MHz, low, conducted	S01_354_20_BB01	2022-10-04	Passed	Passed
WLAN ax 20 MHz, mid, conducted	S01_354_20_BB01	2022-10-04	Passed	Passed
WLAN ax 40 MHz, high, conducted	S01_354_20_BB01	2022-10-04	Passed	Passed
WLAN ax 40 MHz, low, conducted	S01_354_20_BB01	2022-10-04	Passed	Passed
WLAN ax 40 MHz, mid, conducted	S01_354_20_BB01	2022-10-04	Passed	Passed
WLAN b, high, conducted	S01_354_20_BB01	2022-10-04	Passed	Passed
WLAN b, low, conducted	S01_354_20_BB01	2022-10-04	Passed	Passed
WLAN b, mid, conducted	S01_354_20_BB01	2022-10-04	Passed	Passed
WLAN g, high, conducted	S01_354_20_BB01	2022-10-04	Passed	Passed
WLAN g, low, conducted	S01_354_20_BB01	2022-10-04	Passed	Passed
WLAN g, mid, conducted	S01_354_20_BB01	2022-10-04	Passed	Passed
WLAN n 20 MHz, high, conducted	S01_354_20_BB01	2022-10-04	Passed	Passed
WLAN n 20 MHz, low, conducted	S01_354_20_BB01	2022-10-04	Passed	Passed
WLAN n 20 MHz, mid, conducted	S01_354_20_BB01	2022-10-04	Passed	Passed
WLAN n 40 MHz, high, conducted	S01_354_20_BB01	2022-10-04	Passed	Passed
WLAN n 40 MHz, low, conducted	S01_354_20_BB01	2022-10-04	Passed	Passed
WLAN n 40 MHz, mid, conducted	S01_354_20_BB01	2022-10-04	Passed	Passed

47 CFR CHAPTER I FCC PART 15 § 15.247 (d)
Subpart C §15.247

Transmitter Spurious Radiated Emissions
 The measurement was performed according to ANSI C63.10, chapter 6.4, 6.5, 6.6.5 **Final Result**

OP-Mode Radio Technology, Operating Frequency, Measurement range	Setup	Date	FCC	IC
WLAN b, mid, 1 GHz - 26 GHz Remark: Conducted measurement at antenna port only	S01_354_20_BB01	2022-10-26	Passed	Passed
WLAN b, mid, 30 MHz - 1 GHz Remark: Conducted measurement at antenna port only	S01_354_20_BB01	2022-10-26	Passed	Passed
WLAN b, mid, 9 kHz - 30 MHz Remark: Conducted measurement at antenna port only	S01_354_20_BB01	2022-10-26	Passed	Passed

47 CFR CHAPTER I FCC PART 15
Subpart C §15.247

§ 15.247 (d)

Band Edge Compliance Radiated

The measurement was performed according to ANSI C63.10, chapter 6.6.5

Final Result

OP-Mode	Setup	Date	FCC	IC
Radio Technology, Operating Frequency				
WLAN ax 20 MHz, ch. 1, 11 Remark: conducted measurement	S01_354_20_BB01	2022-10-26	Passed	Passed
WLAN ax 20 MHz, ch. 8, 9, 10 Remark: conducted measurement	S01_354_20_BB01	2022-12-01	Passed	Passed
WLAN ax 40 MHz, ch. 3, 9 Remark: conducted measurement	S01_354_20_BB01	2022-10-26	Passed	Passed
WLAN ax 40 MHz, ch. 6 Remark: conducted measurement	S01_354_20_BB01	2022-12-01	Passed	Passed
WLAN b, ch. 1 Remark: conducted measurement	S01_354_20_BB01	2022-10-26	Passed	Passed
WLAN b, ch. 9, 11 Remark: conducted measurement	S01_354_20_BB01	2022-12-01	Passed	Passed
WLAN b, ch. 11 Remark: radiated measurement	S02_354_20_BA01	2022-10-04	Passed	Passed
WLAN g, ch. 11 Remark: conducted measurement	S01_354_20_BB01	2022-11-23	Passed	Passed
WLAN g, ch. 1, 8, 9, 10 Remark: conducted measurement	S01_354_20_BB01	2022-12-01	Passed	Passed
WLAN n 20 MHz, ch. 1 Remark: conducted measurement	S01_354_20_BB01	2022-10-26	Passed	Passed
WLAN n 20 MHz, ch. 11 Remark: conducted measurement	S01_354_20_BB01	2022-11-23	Passed	Passed
WLAN n 20 MHz, ch. 8, 9, 10 Remark: conducted measurement	S01_354_20_BB01	2022-12-01	Passed	Passed
WLAN n 40 MHz, ch. 9 Remark: conducted measurement	S01_354_20_BB01	2022-11-23	Passed	Passed
WLAN n 40 MHz, ch. 3, 8 Remark: conducted measurement	S01_354_20_BB01	2022-12-01	Passed	Passed

N/A: Not applicable

N/P: Not performed

2 REVISION HISTORY / SIGNATURES

Report version control			
Version	Release date	Change Description	Version validity
initial	2022-12-08	--	valid
--	--	--	--

COMMENT: According to the applicant the EUT is identical to the JODY-W354-00A except for an LTE coexistence filter in the 2.4 GHz WLAN antenna path. Due to this only spot checks have been performed. Reference to test report of variant JODY-W354-00A: MDE_UBLOX_2220_FCC_01



(responsible for accreditation scope)
 Dipl.-Ing. Daniel Gall

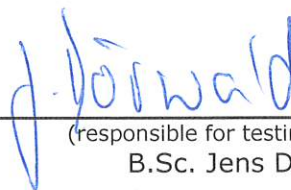

(responsible for testing and report)
 B.Sc. Jens Dörwald



7 layers GmbH, Borsigstr. 11
 40880 Ratingen, Germany
 Phone +49 (0)2102 749 0

3 ADMINISTRATIVE DATA

3.1 TESTING LABORATORY

Company Name: 7layers GmbH
Address: Borsigstr. 11
40880 Ratingen
Germany

The test facility is accredited by the following accreditation organisation:

Laboratory accreditation no: DAKKS D-PL-12140-01-01 | -02 | -03
FCC Designation Number: DE0015
FCC Test Firm Registration: 929146
ISED CAB Identifier: DE0007; ISED#: 3699A
Responsible for accreditation scope: Dipl.-Ing. Daniel Gall
Report Template Version: 2022-05-25

3.2 PROJECT DATA

Responsible for testing and report: B.Sc. Jens Dörwald
Employees who performed the tests: documented internally at 7Layers
Date of Report: 2022-12-08
Testing Period: 2022-10-04 to 2022-12-01

3.3 APPLICANT DATA

Company Name: u-blox AG
Address: Zürcherstrasse 68
8800 Thalwil
Switzerland
Contact Person: Filip Kruzela

3.4 MANUFACTURER DATA

Company Name: please see Applicant Data

Address:

Contact Person:

4 TEST OBJECT DATA

4.1 GENERAL EUT DESCRIPTION

Kind of Device product description	Host-based module with WLAN and Bluetooth technology.																																																																																											
Product name	JODY-W3																																																																																											
Type	JODY-W354-20A																																																																																											
Declared EUT data by the supplier																																																																																												
Voltage Type	DC																																																																																											
Voltage Level	1.8 V + 3.3 V																																																																																											
Antenna / Gain	External / 2 dBi (No antennas were provided for the tests, radiated measurements were performed with 50 Ohm terminations)																																																																																											
Tested Modulation Type	WLANb: DSSS WLANg/n/ax: OFDM																																																																																											
Specific product description for the EUT	The EUT is a Bluetooth and WLAN module. Supported technologies are Bluetooth Classic, Bluetooth Low Energy and WLAN b, g, n, ax 20 and 40 MHz bandwidth.																																																																																											
EUT ports (connected cables during testing):	Enclosure Data DC Antenna The EUT is a module with solder pads for surface mounting, so no cables were connected to the EUT itself.																																																																																											
Tested datarates	WLAN b: 1 Mbps, g: 6 Mbps, n: MCS 0 SISO, ax: MSC 0																																																																																											
Special software used for testing	Labtool 2.0.0.85-17.80.200.p204 on computer board provided by applicant.																																																																																											
Used output power	<p>WLAN:</p> <table border="1"> <thead> <tr> <th colspan="12">2.4 GHz</th> </tr> <tr> <th>Mode</th> <th>Ch.1</th> <th>Ch.2</th> <th>Ch.3</th> <th>Ch.4</th> <th>Ch.5</th> <th>Ch.6</th> <th>Ch.7</th> <th>Ch.8</th> <th>Ch.9</th> <th>Ch.10</th> <th>Ch.11</th> </tr> </thead> <tbody> <tr> <td>b</td> <td>19</td> <td colspan="6">21</td> <td colspan="2"></td> <td>16</td> <td>16</td> </tr> <tr> <td>g</td> <td>14</td> <td>16</td> <td colspan="6">17</td> <td>16</td> <td>15</td> <td>13</td> </tr> <tr> <td>n20</td> <td>14</td> <td>15</td> <td>16</td> <td colspan="4">17</td> <td>16</td> <td>14</td> <td>12</td> </tr> <tr> <td>n40</td> <td>N/A</td> <td>N/A</td> <td colspan="4">13</td> <td>12</td> <td>N/A</td> <td>N/A</td> </tr> <tr> <td>ax20</td> <td>13</td> <td>15</td> <td>15</td> <td>16</td> <td colspan="3">17</td> <td>16</td> <td>14</td> <td>12</td> </tr> <tr> <td>ax40</td> <td>N/A</td> <td>N/A</td> <td colspan="4">13</td> <td colspan="2">12</td> <td>N/A</td> <td>N/A</td> </tr> </tbody> </table> <p>■ = New output power setting compared to JODY-W354-00A due to Band Edge performance</p>	2.4 GHz												Mode	Ch.1	Ch.2	Ch.3	Ch.4	Ch.5	Ch.6	Ch.7	Ch.8	Ch.9	Ch.10	Ch.11	b	19	21								16	16	g	14	16	17						16	15	13	n20	14	15	16	17				16	14	12	n40	N/A	N/A	13				12	N/A	N/A	ax20	13	15	15	16	17			16	14	12	ax40	N/A	N/A	13				12		N/A	N/A
2.4 GHz																																																																																												
Mode	Ch.1	Ch.2	Ch.3	Ch.4	Ch.5	Ch.6	Ch.7	Ch.8	Ch.9	Ch.10	Ch.11																																																																																	
b	19	21								16	16																																																																																	
g	14	16	17						16	15	13																																																																																	
n20	14	15	16	17				16	14	12																																																																																		
n40	N/A	N/A	13				12	N/A	N/A																																																																																			
ax20	13	15	15	16	17			16	14	12																																																																																		
ax40	N/A	N/A	13				12		N/A	N/A																																																																																		

4.2 EUT MAIN COMPONENTS

Sample Name	Sample Code	Description
EUT 354 ba01	DE1015166ba01	JODY-W354-20A sample
Sample Parameter	Value	
Serial No.	AR66009C381643C0600	
HW Version	05	
SW Version	2.0.0.86-17.80.200.p207	
Comment		

Sample Name	Sample Code	Description
EUT 354 bb01	DE1015166bb01	JODY-W354-20A sample
Sample Parameter	Value	
Serial No.	AR66009C38163340600	
HW Version	05	
SW Version	2.0.0.86-17.80.200.p207	
Comment		

NOTE: The short description is used to simplify the identification of the EUT in this test report.

4.3 ANCILLARY EQUIPMENT

For the purposes of this test report, ancillary equipment is defined as equipment which is used in conjunction with the EUT to provide operational and control features to the EUT. It is necessary to configure the system in a typical fashion, as a customer would normally use it. But nevertheless Ancillary Equipment can influence the test results.

Device	Details (Manufacturer, Type Model, OUT Code)	Description
-	-	-

4.4 AUXILIARY EQUIPMENT

For the purposes of this test report, auxiliary equipment is defined as equipment which is used temporarily to enable operational and control features especially used for the tests of the EUT which is not used during normal operation or equipment that is used during the tests in combination with the EUT but is not subject of this test report. It is necessary to configure the system in a typical fashion, as a customer would normally use it. But nevertheless Auxiliary Equipment can influence the test results.

Device	Details (Manufacturer, Type Model, HW, SW, S/N)	Description
AUX1	UBLOX, JODY-Carrier Board, REV. C, -, 10000001898798019001	Evaluation Board for module providing ports
AUX21	Toradex, Ixora, -, -, -	Board Computer for setting modes

4.5 EUT SETUPS

This chapter describes the combination of EUTs and equipment used for testing. The rationale for selecting the EUTs, ancillary and auxiliary equipment and interconnecting cables, is to test a representative configuration meeting the requirements of the referenced standards.

Setup	Combination of EUTs	Description and Rationale
S02_354_20_BA01	EUT 354 ba01, AUX1,	Radiated Setup
S01_354_20_BB01	EUT 354 bb01, AUX21, AUX1,	Conducted Setup

4.6 OPERATING MODES / TEST CHANNELS

This chapter describes the operating modes of the EUTs used for testing.

WLAN

20 MHz Test Channels:

Channel:

Frequency [MHz]

2.4 GHz ISM 2400 - 2483.5 MHz		
low	mid	high
1	6	11
2412	2437	2462

40 MHz Test Channels:

Channel:

Frequency [MHz]

low	mid	high
3	6	9
2422	2437	2452

4.7 PRODUCT LABELLING

4.7.1 FCC ID LABEL

Please refer to the documentation of the applicant.

4.7.2 LOCATION OF THE LABEL ON THE EUT

Please refer to the documentation of the applicant.

5 TEST RESULTS

5.1 PEAK POWER OUTPUT

Standard **FCC Part 15 Subpart C**

The test was performed according to:

ANSI C63.10, chapter 11.9.1.3

5.1.1 TEST DESCRIPTION

DTS EQUIPMENT:

The Equipment Under Test (EUT) was set up to perform the output power measurements. The results recorded were measured with the modulation which produces the worst-case (highest) output power.

Maximum peak conducted output power (e.g. Bluetooth Low Energy):

The EUT was connected to the test system as described in the block diagram below. The complete attenuation of the measurement path is known and considered. The reference level of the spectrum analyser was set higher than the output power of the EUT.

Analyser settings:

- Resolution Bandwidth (RBW): \geq DTS bandwidth
- Video Bandwidth (VBW): \geq 3 times RBW or maximum of analyzer
- Span: \geq 3 times RBW
- Trace: Maxhold
- Sweeps: Till stable (min. 300, max. 15000)
- Sweptime: Auto
- Detector: Peak

Maximum conducted average output power (e.g. WLAN):

The EUT was connected to the test system as described in the block diagram below. The complete attenuation of the measurement path is known and considered. Measurement is performed using the gated RF average power meter integrated in the OSP 120 module OSP-B157W8 with signal bandwidth >300 MHz.

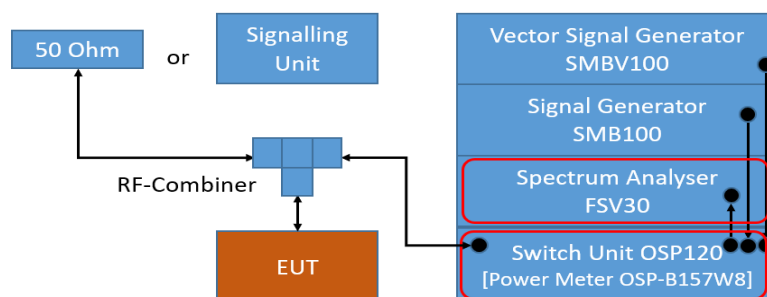

TS8997; Output Power

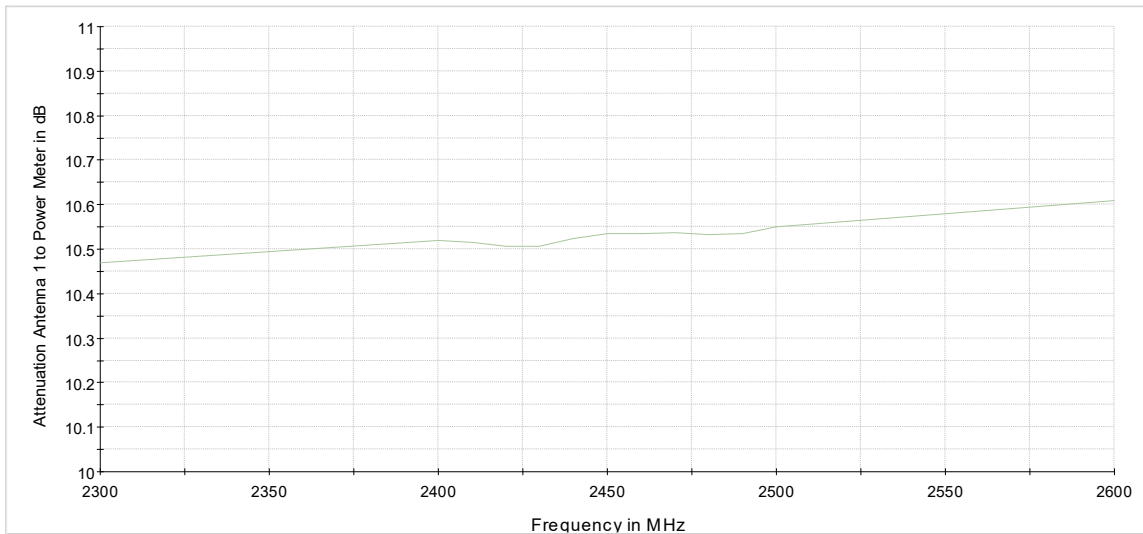

Attenuation of the measurement path to Power Meter

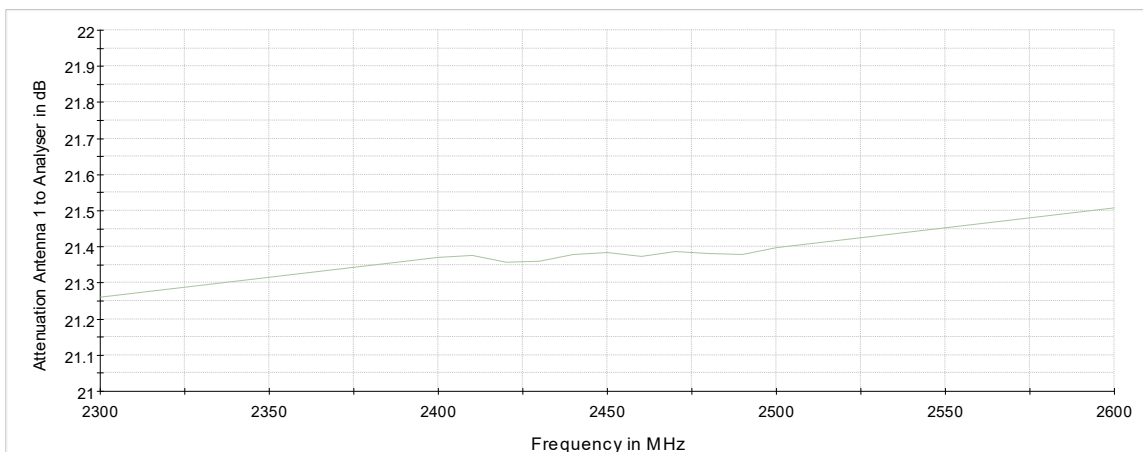

Attenuation of the measurement path to Analyser

5.1.2 TEST REQUIREMENTS / LIMITS

DTS devices:

FCC Part 15, Subpart C, §15.247 (b) (3)

For systems using digital modulation techniques in the 902-928 MHz, 2400-2483.5 MHz and 5725-5850 MHz bands: 1 watt.

==> Maximum conducted peak output power: 30 dBm (excluding antenna gain, if antennas with directional gains that do not exceed 6 dBi are used).

Frequency Hopping Systems:

FCC Part 15, Subpart C, §15.247 (b) (1)

For frequency hopping systems operating in the 2400-2483.5 MHz band employing at least 75 non-overlapping hopping channels, and all frequency hopping systems in the 5725-5850 MHz band: 1 watt. For all other frequency hopping systems in the 2400-2483.5 MHz band: 0.125 watts.

FCC Part 15, Subpart C, §15.247 (b) (2)

For frequency hopping systems operating in the 902-928 MHz band: 1 watt for systems employing at least 50 hopping channels; and, 0.25 watts for systems employing less than 50 hopping channels, but at least 25 hopping channels, as permitted under paragraph (a)(1)(i) of this section.

Used conversion factor: Limit (dBm) = 10 log (Limit (W)/1mW)

5.1.3 TEST PROTOCOL

Ambient temperature: 24 °C
 Air Pressure: 1022 hPa
 Humidity: 40 %
 WLAN b-Mode; 20 MHz; 1 Mbit/s

Band	Channel No.	Frequency [MHz]	Maximum Average Power [dBm]	Limit [dBm]	Margin to Limit [dB]	E.I.R.P [dBm]	Difference to W354-00A [dB]
2.4 GHz ISM	1	2412	19.3	30.0	10.7	21.3	0.5
	6	2437	20.6	30.0	9.4	22.6	0.0
	11	2462	16.9	30.0	13.1	18.9	-2.3

WLAN g-Mode; 20 MHz; 6 Mbit/s

Band	Channel No.	Frequency [MHz]	Maximum Average Power [dBm]	Limit [dBm]	Margin to Limit [dB]	E.I.R.P [dBm]	Difference to W354-00A [dB]
2.4 GHz ISM	1	2412	14.5	30.0	15.5	16.5	0.1
	6	2437	19.0	30.0	11.0	21.0	0.1
	11	2462	12.4	30.0	17.6	14.4	-0.9

WLAN n-Mode; 20 MHz; MCS0

Band	Channel No.	Frequency [MHz]	Maximum Average Power [dBm]	Limit [dBm]	Margin to Limit [dB]	E.I.R.P [dBm]	Difference to W354-00A [dB]
2.4 GHz ISM	1	2412	14.4	30.0	15.6	16.4	0.1
	6	2437	18.3	30.0	11.7	20.3	1.0
	11	2462	13.2	30.0	16.8	15.2	-0.1

WLAN n-Mode; 40 MHz; MCS0

Band	Channel No.	Frequency [MHz]	Maximum Average Power [dBm]	Limit [dBm]	Margin to Limit [dB]	E.I.R.P [dBm]	Difference to W354-00A [dB]
2.4 GHz ISM	3	2422	13.4	30.0	16.6	15.4	0.4
	6	2437	14.0	30.0	16.0	16.0	0.3
	9	2452	13.3	30.0	16.7	15.3	0.4

WLAN ax-Mode; 20 MHz; MCS0

Band	Channel No.	Frequency [MHz]	Maximum Average Power [dBm]	Limit [dBm]	Margin to Limit [dB]	E.I.R.P [dBm]	Difference to W354-00A [dB]
2.4 GHz ISM	1	2412	13.7	30.0	16.3	15.7	0.1
	6	2437	18.2	30.0	11.8	20.2	0.3
	11	2462	11.6	30.0	18.4	13.6	-1.4

WLAN ax-Mode; 40 MHz; MCS0

Band	Channel No.	Frequency [MHz]	Maximum Average Power [dBm]	Limit [dBm]	Margin to Limit [dB]	E.I.R.P [dBm]	Difference to W354-00A [dB]
2.4 GHz ISM	3	2422	13.9	30.0	16.1	15.9	0.2
	6	2437	14.4	30.0	15.6	16.4	0.4
	9	2452	13.7	30.0	16.3	15.7	0.5

Remark: For comparison purposes the higher output power setting of JODY-W374-00A was used for the test, not the yellow marked lowered power setting as given in chapter 4.1 (mode b high channel 19 instead of 16 and mode n 20 MHz high channel 13 instead of 12)

5.1.4 MEASUREMENT PLOT (EXAMPLE PLOT, SHOWING WORST CASE, IF APPLICABLE)

Power Meter Measurement, no plots provided.

5.1.5 TEST EQUIPMENT USED

- R&S TS8997

5.2 TRANSMITTER SPURIOUS RADIATED EMISSIONS

Standard **FCC Part 15 Subpart C**

The test was performed according to:
ANSI C63.10, chapter 6.4, 6.5, 6.6.5

5.2.1 TEST DESCRIPTION

Conducted Measurements at antenna ports

The Equipment Under Test (EUT) was set up to perform the spurious emissions measurements.

The EUT was connected to the test system as described in the block diagram below. The complete attenuation of the measurement path is known and considered.

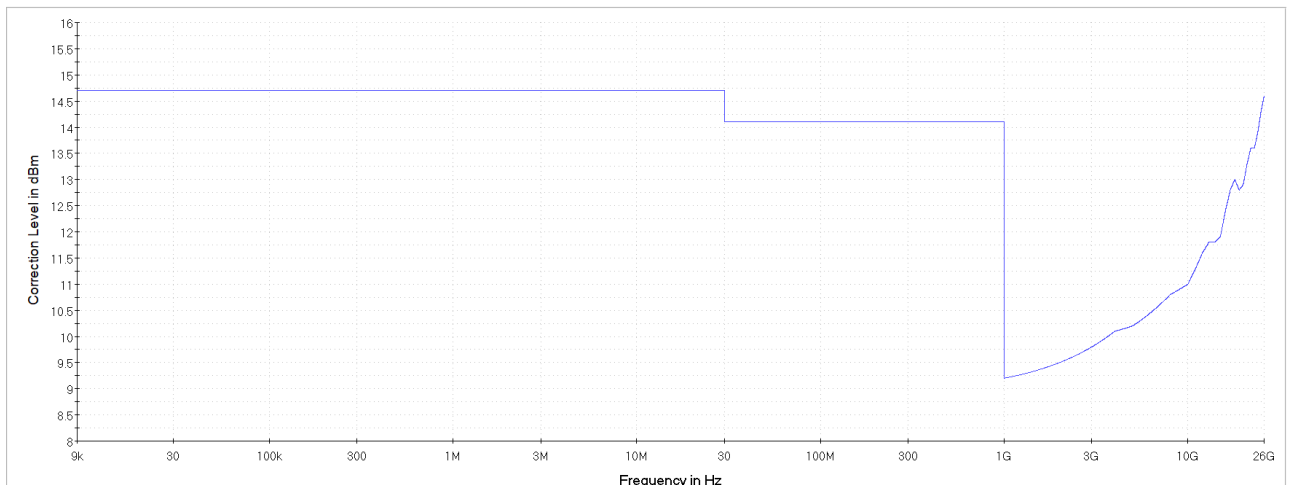
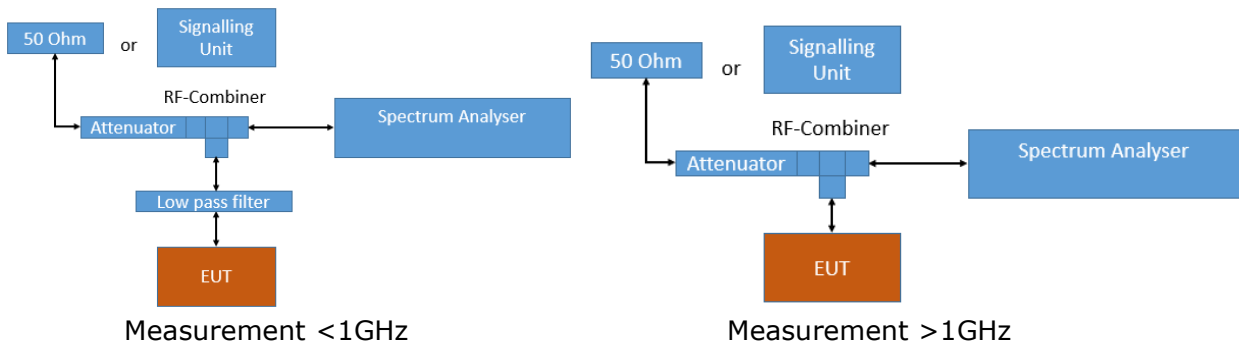

Analyser settings:

- Frequency range: 0.009 – 30 MHz
- Resolution Bandwidth (RBW): 10 kHz
- Video Bandwidth (VBW): 30 kHz
- Trace: Maxhold
- Sweeps: till stable
- Sweep Time: coupled
- Detector: Peak
- Frequency range: 30 – 1000 MHz

- Resolution Bandwidth (RBW): 100 kHz
 - Video Bandwidth (VBW): 300 kHz
 - Trace: Maxhold
 - Sweeps: till stable
 - Sweep Time: coupled
 - Detector: Peak
-
- Frequency range: 1000 – 26000 MHz
 - Resolution Bandwidth (RBW): 1000 kHz
 - Video Bandwidth (VBW): 3000 kHz
 - Trace: Maxhold, Average Power
 - Sweeps: 500
 - Sweep Time: coupled
 - Detector: Peak, RMS

For the conducted emissions in restricted bands the Value is measured in dBm and then converted to dB μ V/m as given in KDB 558074:

1. Measure the conducted output power in dBm.
2. Add the maximum antenna gain in dBi. (Included in measurement result by offset)
3. Add the appropriate ground reflection factor (included in measurement result by transducer factor)
 - 6 dB for frequencies \leq 30 MHz;
 - 4.7 dB for frequencies between 30 MHz and 1000 MHz, inclusive; and
 - 0 dB for frequencies $>$ 1000 MHz).
4. Convert the resultant EIRP level to an equivalent electric field strength level using the following relationship:
$$E = \text{EIRP} - 20 \log D + 104.8$$
Where E is the electric field strength in dB μ V/m,
EIRP is the equivalent isotropically radiated power in dBm
D is the specified measurement distance in m

Value [dB μ V/m] = Measured value [dBm] (including gain and ground reflection factor) – 20 log D + 104.8

5.2.2 TEST REQUIREMENTS / LIMITS

FCC Part 15, Subpart C, §15.247 (d)

... In addition, radiated emissions which fall in the restricted bands, as defined in Section 15.205(a), must also comply with the radiated emission limits specified in Section 15.209(a) (see Section 15.205(c)).

FCC Part 15, Subpart C, §15.209, Radiated Emission Limits

Frequency in MHz	Limit (µV/m)	Measurement distance (m)	Limits (dBµV/m)
0.009 – 0.49	2400/F(kHz)@300m	3	(48.5 – 13.8)@300m
0.49 – 1.705	24000/F(kHz)@30m	3	(33.8 – 23.0)@30m
1.705 – 30	30@30m	3	29.5@30m

The measured values are corrected with an inverse linear distance extrapolation factor (40 dB/decade) according FCC 15.31 (2).

Frequency in MHz	Limit (µV/m)	Measurement distance (m)	Limits (dBµV/m)
30 – 88	100@3m	3	40.0@3m
88 – 216	150@3m	3	43.5@3m
216 – 960	200@3m	3	46.0@3m
960 - 26000	500@3m	3	54.0@3m
26000 - 40000	500@3m	1	54.0@3m

The measured values above 26 GHz are corrected with an inverse linear distance extrapolation factor (20 dB/decade).

§15.35(b) ..., there is also a limit on the radio frequency emissions, as measured using instrumentation with a peak detector function, corresponding to 20 dB above the maximum permitted average limit....

Used conversion factor: Limit (dBµV/m) = 20 log (Limit (µV/m)/1µV/m)

5.2.3 TEST PROTOCOL

Ambient temperature: 24 °C
 Air Pressure: 1008 hPa
 Humidity: 40 %
 WLAN b-Mode; 20 MHz; 1 Mbit/s
 Applied duty cycle correction (AV): 0 dB

Ch. No.	Ch. Center Freq. [MHz]	Spurious Freq. [MHz]	Spurious Level [dBµV/m]	Detector	RBW [kHz]	Limit [dBµV/m]	Margin to Limit [dB]	Limit Type
6	2437	- - -	-	- - -	1000	- - -	- - -	RB

Remark: Please see next sub-clause for the measurement plot.

5.2.4 MEASUREMENT PLOT (EXAMPLE PLOT, SHOWING WORST CASE, IF APPLICABLE)

Radio Technology = WLAN b, Operating Frequency = mid, Measurement range = 9 kHz - 30 MHz
(S01_354_20_BB01)

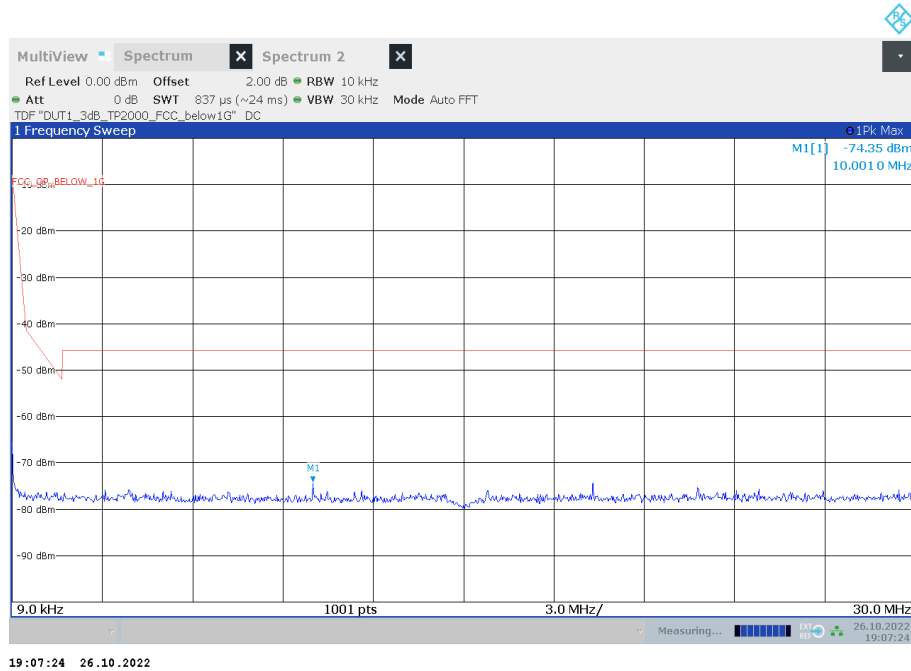

Radio Technology = WLAN b, Operating Frequency = mid, Measurement range = 30 MHz - 1 GHz
(S01_354_20_BB01)

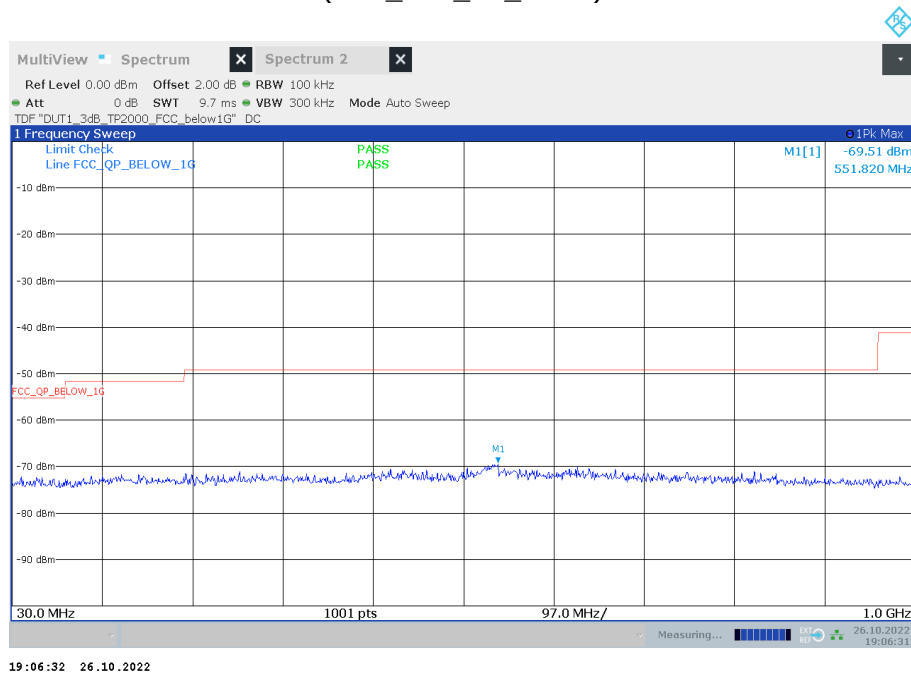

Radio Technology = WLAN b, Operating Frequency = mid, Measurement range = 1 GHz - 26 GHz
 (S01_354_20_BB01)

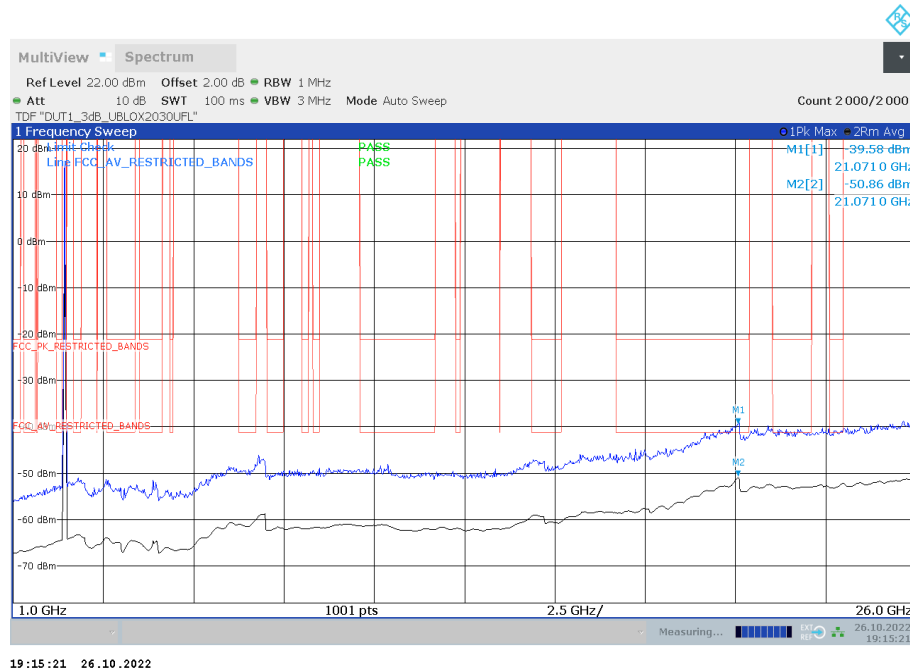

5.2.5 TEST EQUIPMENT USED

- R&S TS8997

5.3 BAND EDGE COMPLIANCE RADIATED

Standard **FCC Part 15 Subpart C**

The test was performed according to:

ANSI C63.10, chapter 6.6.5

5.3.1 TEST DESCRIPTION

Radiated Measurement with 50 Ohm termination at antenna ports

The test set-up was made in accordance to the general provisions of ANSI C63.10 in a typical installation configuration. The measurements were performed according the following sub-chapter of ANSI C63.10:

- Chapter 6.10.5

The Equipment Under Test (EUT) was set up on a non-conductive support (tilt device) at 1.5 m height in the fully-anechoic chamber.

All steps were performed with one height (1.5 m) of the receiving antenna only (procedure according ANSI C63.10, chapter 6.6.5).

3. Measurement above 1 GHz

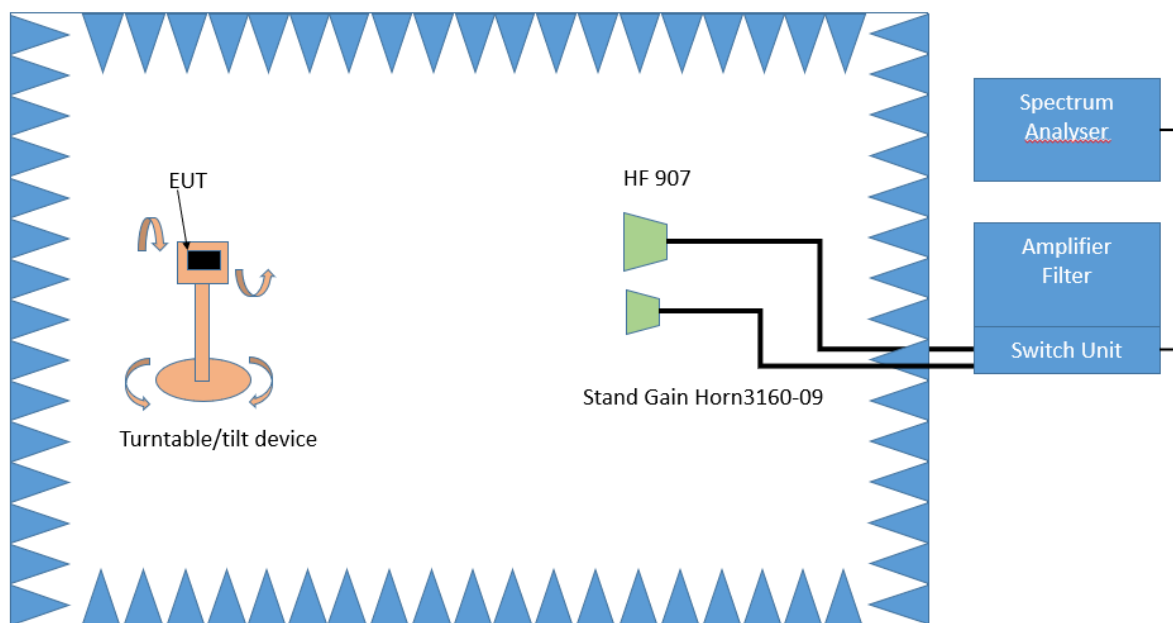

Test Setup; Spurious Emission Radiated (FAC), 1 GHz-26.5 GHz

Step 1:

The EUT is turned during the preliminary measurement across the elevation axis, with a step size of 90 °.

The turn table step size (azimuth angle) for the preliminary measurement is 45 °.

Spectrum analyser settings:

- Detector: Peak, Average
- RBW = 1 MHz
- VBW = 3 MHz

Step 2:

The turn table azimuth will slowly vary by $\pm 22.5^\circ$.

The elevation angle will slowly vary by $\pm 45^\circ$

Spectrum analyser settings:

- Detector: Peak

Step 3:

Spectrum analyser settings for step 3:

- Detector: Peak / CISPR Average
- Measured frequencies: in step 1 determined frequencies
- RBW = 1 MHz
- VBW = 3 MHz
- Measuring time: 1 s

Conducted Measurements at antenna ports

The Equipment Under Test (EUT) was set up to perform the spurious emissions measurements.

The EUT was connected to the test system as described in the block diagram below. The complete attenuation of the measurement path is known and considered.

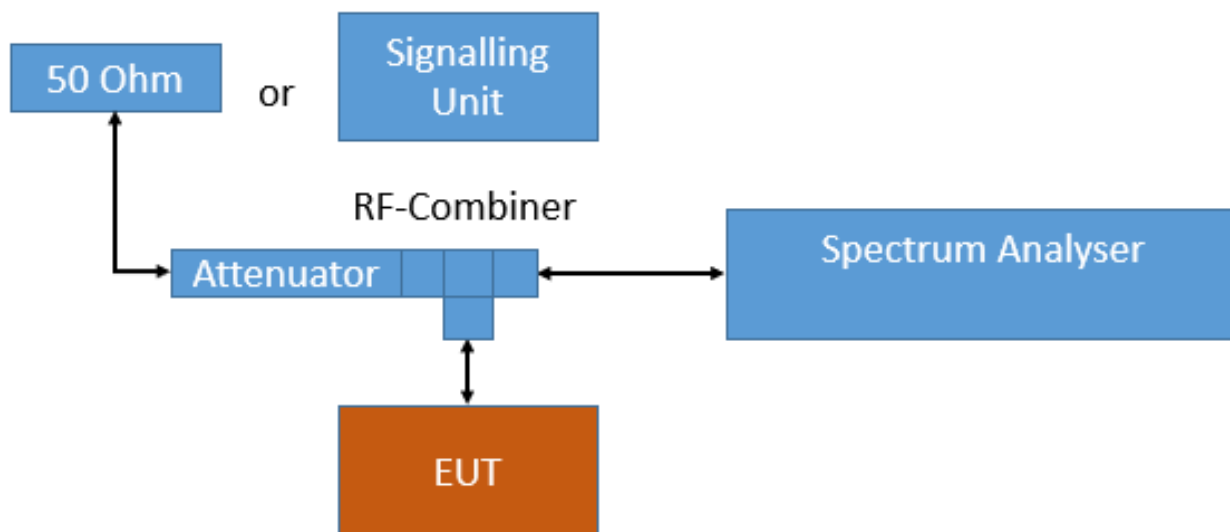

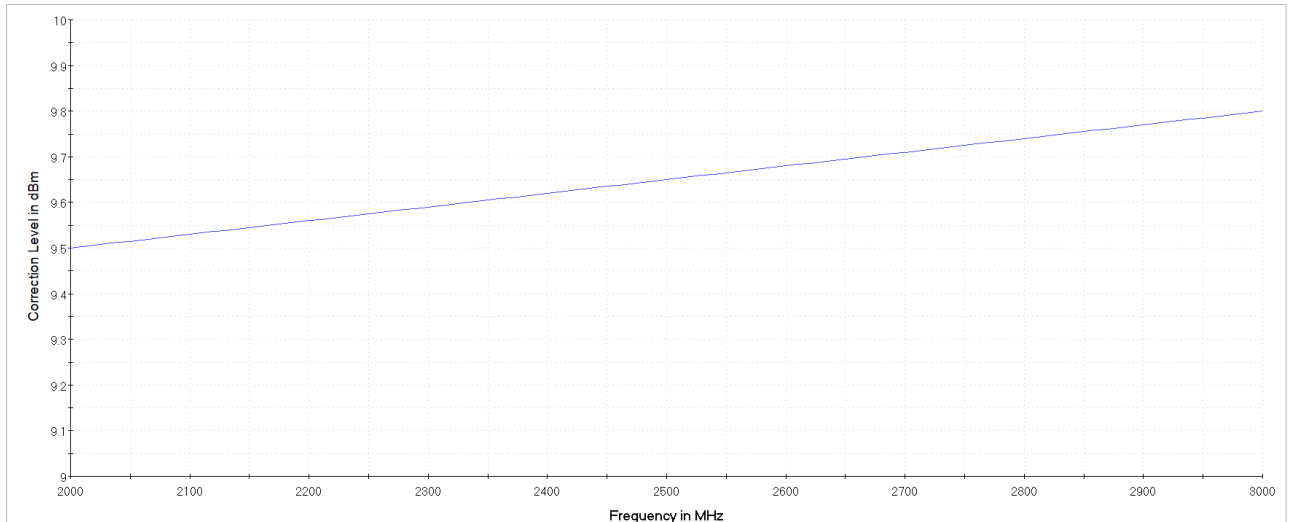

Analyser settings:

- Frequency range: 2350 – 2500 MHz
- Resolution Bandwidth (RBW): 1000 kHz
- Video Bandwidth (VBW): 3000 kHz
- Trace: Maxhold, Average Power
- Sweeps: 10000
- Sweep Time: coupled
- Detector: Peak, RMS

For the conducted emissions in restricted bands the Value is measured in dBm and then converted to dBµV/m as given in KDB 558074:

1. Measure the conducted output power in dBm.
2. Add the maximum antenna gain in dBi. (Included in measurement result by offset)
3. Add the appropriate ground reflection factor (0 for measured range)
 - 6 dB for frequencies ≤ 30 MHz;
 - 4.7 dB for frequencies between 30 MHz and 1000 MHz, inclusive; and
 - 0 dB for frequencies > 1000 MHz).
4. Convert the resultant EIRP level to an equivalent electric field strength level using the following relationship:

$$E = \text{EIRP} - 20 \log D + 104.8$$
 Where E is the electric field strength in dBµV/m,
 EIRP is the equivalent isotropically radiated power in dBm
 D is the specified measurement distance in m

$$\text{Value [dBµV/m]} = \text{Measured value [dBm]} \text{ (including gain and ground reflection factor)} - 20 \log D + 104.8$$

5.3.2 TEST REQUIREMENTS / LIMITS

For band edges connected to a restricted band, the limits are specified in Section 15.209(a)

FCC Part 15, Subpart C, §15.209, Radiated Emission Limits

Frequency in MHz	Limit (µV/m)	Measurement distance (m)	Limits (dBµV/m)
0.009 – 0.49	2400/F(kHz)@300m	3	(48.5 – 13.8)@300m
0.49 – 1.705	24000/F(kHz)@30m	3	(33.8 – 23.0)@30m
1.705 – 30	30@30m	3	29.5@30m

The measured values are corrected with an inverse linear distance extrapolation factor (40 dB/decade) according FCC 15.31 (2).

Frequency in MHz	Limit (µV/m)	Measurement distance (m)	Limits (dBµV/m)
30 – 88	100@3m	3	40.0@3m
88 – 216	150@3m	3	43.5@3m
216 – 960	200@3m	3	46.0@3m
960 - 26000	500@3m	3	54.0@3m
26000 - 40000	500@3m	1	54.0@3m

The measured values above 26 GHz are corrected with an inverse linear distance extrapolation factor (20 dB/decade).

§15.35(b) ..., there is also a limit on the radio frequency emissions, as measured using instrumentation with a peak detector function, corresponding to 20 dB above the maximum permitted average limit....

Used conversion factor: $\text{Limit (dB}\mu\text{V/m)} = 20 \log (\text{Limit } (\mu\text{V/m})/1\mu\text{V/m})$

5.3.3 TEST PROTOCOL

Ambient temperature: 22–25 °C
 Air Pressure: 991–1022 hPa
 Humidity: 40–47 %
 WLAN b-Mode; 20 MHz; 1 Mbit/s
 Applied duty cycle correction (AV): 0 dB

Test Method	Ch. Center Freq. [MHz]	Band Edge Freq. [MHz]	Spurious Level [dBµV/m]	Detector	RBW [kHz]	Limit [dBµV/m]	Margin to Limit [dB]
Radiated	2462	2483.5	47.9	PEAK	1000	74.0	26.1
Radiated	2462	2483.5	34.8	AV	1000	54.0	19.2
Conducted	2412	2390.0	55.4	PEAK	1000	74.0	18.6
Conducted	2412	2390.0	48.3	AV	1000	54.0	5.7
Conducted	2452	2483.5	57.2	PEAK	1000	74.0	16.8
Conducted	2452	2483.5	50.9	AV	1000	54.0	3.1
Conducted	2462	2483.5	52.8	PEAK	1000	74.0	21.2
Conducted	2462	2483.5	44.4	AV	1000	54.0	9.6

WLAN g-Mode; 20 MHz; 6 Mbit/s
 Applied duty cycle correction (AV): 0 dB

Test Method	Ch. Center Freq. [MHz]	Band Edge Freq. [MHz]	Spurious Level [dBµV/m]	Detector	RBW [kHz]	Limit [dBµV/m]	Margin to Limit [dB]
Conducted	2412	2390.0	62.1	PEAK	1000	74.0	11.9
Conducted	2412	2390.0	44.0	AV	1000	54.0	10.0
Conducted	2447	2483.5	66.6	PEAK	1000	74.0	7.4
Conducted	2447	2483.5	50.0	AV	1000	54.0	4.0
Conducted	2452	2483.5	67.0	PEAK	1000	74.0	7.0
Conducted	2452	2483.5	50.2	AV	1000	54.0	3.8
Conducted	2457	2483.5	68.2	PEAK	1000	74.0	5.8
Conducted	2457	2483.5	52.4	AV	1000	54.0	1.6
Conducted	2462	2483.5	71.7	PEAK	1000	74.0	2.3
Conducted	2462	2483.5	51.5	AV	1000	54.0	2.5

WLAN n-Mode; 20 MHz; MCS0
 Applied duty cycle correction (AV): 0 dB

Test Method	Ch. Center Freq. [MHz]	Band Edge Freq. [MHz]	Spurious Level [dBµV/m]	Detector	RBW [kHz]	Limit [dBµV/m]	Margin to Limit [dB]
Conducted	2412	2390.0	66.5	PEAK	1000	74.0	7.5
Conducted	2412	2390.0	44.8	AV	1000	54.0	9.2
Conducted	2447	2483.5	66.7	PEAK	1000	74.0	7.3
Conducted	2447	2483.5	51.1	AV	1000	54.0	2.9
Conducted	2452	2483.5	67.2	PEAK	1000	74.0	6.8
Conducted	2452	2483.5	51.5	AV	1000	54.0	2.5
Conducted	2457	2483.5	69.8	PEAK	1000	74.0	4.2
Conducted	2457	2483.5	50.4	AV	1000	54.0	3.6
Conducted	2462	2483.5	67.9	PEAK	1000	74.0	6.1
Conducted	2462	2483.5	45.8	AV	1000	54.0	8.2

WLAN n-Mode; 40 MHz; MCS0
 Applied duty cycle correction (AV): 0 dB

Test Method	Ch. Center Freq. [MHz]	Band Edge Freq. [MHz]	Spurious Level [dBµV/m]	Detector	RBW [kHz]	Limit [dBµV/m]	Margin to Limit [dB]
Conducted	2422	2390.0	64.5	PEAK	1000	74.0	9.5
Conducted	2422	2390.0	42.7	AV	1000	54.0	11.3
Conducted	2447	2483.5	71.7	PEAK	1000	74.0	2.3
Conducted	2447	2483.5	53.5	AV	1000	54.0	0.5
Conducted	2452	2483.5	72.1	PEAK	1000	74.0	1.9
Conducted	2452	2483.5	48.8	AV	1000	54.0	5.2

WLAN ax-Mode; 20 MHz; MCS0
 Applied duty cycle correction (AV): 0 dB

Test Method	Ch. Center Freq. [MHz]	Band Edge Freq. [MHz]	Spurious Level [dB μ V/m]	Detector	RBW [kHz]	Limit [dB μ V/m]	Margin to Limit [dB]
Conducted	2412	2390.0	65.8	PEAK	1000	74.0	8.2
Conducted	2412	2390.0	42.6	AV	1000	54.0	11.4
Conducted	2462	2483.5	72.4	PEAK	1000	74.0	1.6
Conducted	2462	2483.5	50.0	AV	1000	54.0	4.0
Conducted	2447	2483.5	68.7	PEAK	1000	74.0	5.3
Conducted	2447	2483.5	52.7	AV	1000	54.0	1.3
Conducted	2452	2483.5	68.8	PEAK	1000	74.0	5.2
Conducted	2452	2483.5	53.1	AV	1000	54.0	0.9
Conducted	2457	2483.5	68.1	PEAK	1000	74.0	5.9
Conducted	2457	2483.5	52.6	AV	1000	54.0	1.4

WLAN ax-Mode; 40 MHz; MCS0
 Applied duty cycle correction (AV): 0 dB

Test Method	Ch. Center Freq. [MHz]	Band Edge Freq. [MHz]	Spurious Level [dB μ V/m]	Detector	RBW [kHz]	Limit [dB μ V/m]	Margin to Limit [dB]
Conducted	2422	2390.0	65.2	PEAK	1000	74.0	8.8
Conducted	2422	2390.0	43.6	AV	1000	54.0	10.4
Conducted	2452	2483.5	73.9	PEAK	1000	74.0	0.1
Conducted	2452	2483.5	52.5	AV	1000	54.0	1.5
Conducted	2437	2483.5	67.6	PEAK	1000	74.0	6.4
Conducted	2437	2483.5	51.0	AV	1000	54.0	3.0

Remark: Please see next sub-clause for the measurement plot.

5.3.4 MEASUREMENT PLOT (EXAMPLE PLOT, SHOWING WORST CASE, IF APPLICABLE)

Radio Technology = WLAN b, Operating Frequency = high, Band Edge = high (S02_354_20_BA01)

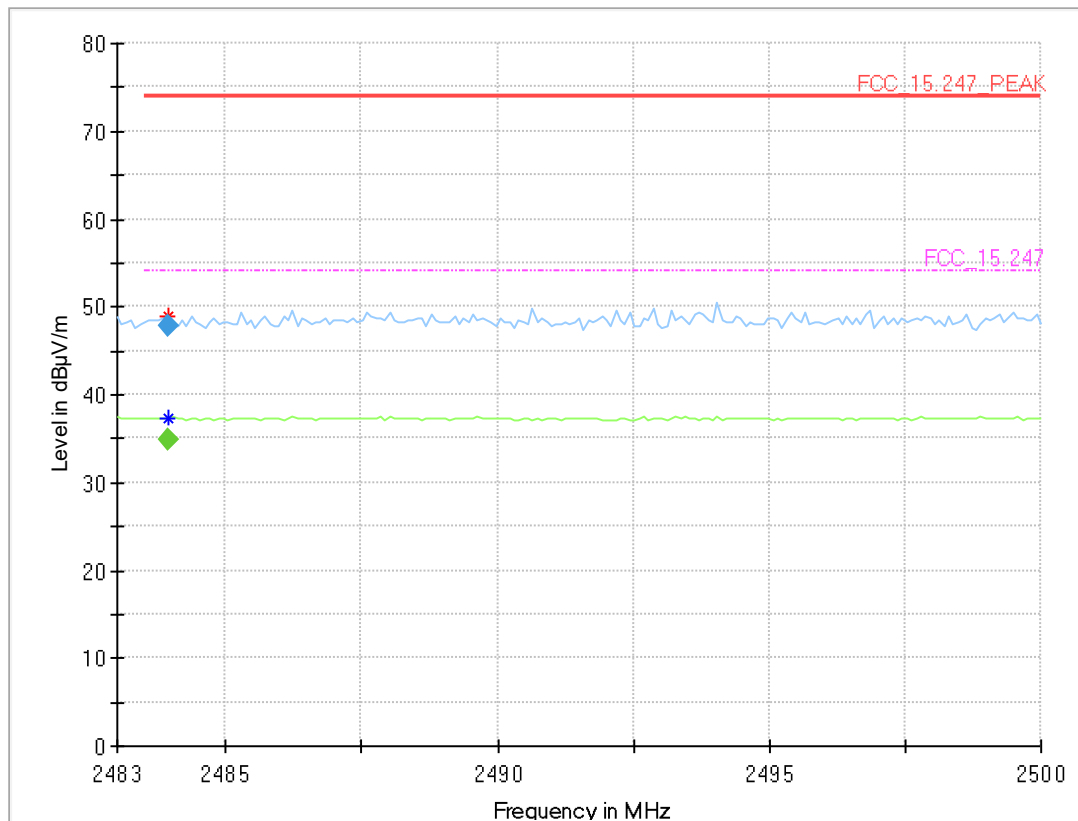

Critical_Freqs

Frequency (MHz)	MaxPeak (dBµV/m)	Average (dBµV/m)	Limit (dBµV/m)	Margin (dB)	Meas. Time (ms)	Bandwidth (kHz)	Height (cm)	Pol	Azimuth (deg)	Elevation (deg)	Corr. (dB/m)
2483.935	49.0	37.3	74.00	24.98	---	---	150.0	H	68.0	102.0	5.3

Final_Result

Frequency (MHz)	MaxPeak (dBµV/m)	CAverage (dBµV/m)	Limit (dBµV/m)	Margin (dB)	Meas. Time (ms)	Bandwidth (kHz)	Height (cm)	Pol	Azimuth (deg)	Elevation (deg)	Corr. (dB/m)
2483.935	---	34.8	54.00	19.16	1000.0	1000.000	150.0	H	68.0	102.0	5.3
2483.935	47.9	---	74.00	26.10	1000.0	1000.000	150.0	H	68.0	102.0	5.3

Radio Technology = WLAN b, Operating Frequency = low + high, Band Edge = low + high (S01_354_20_BB01)

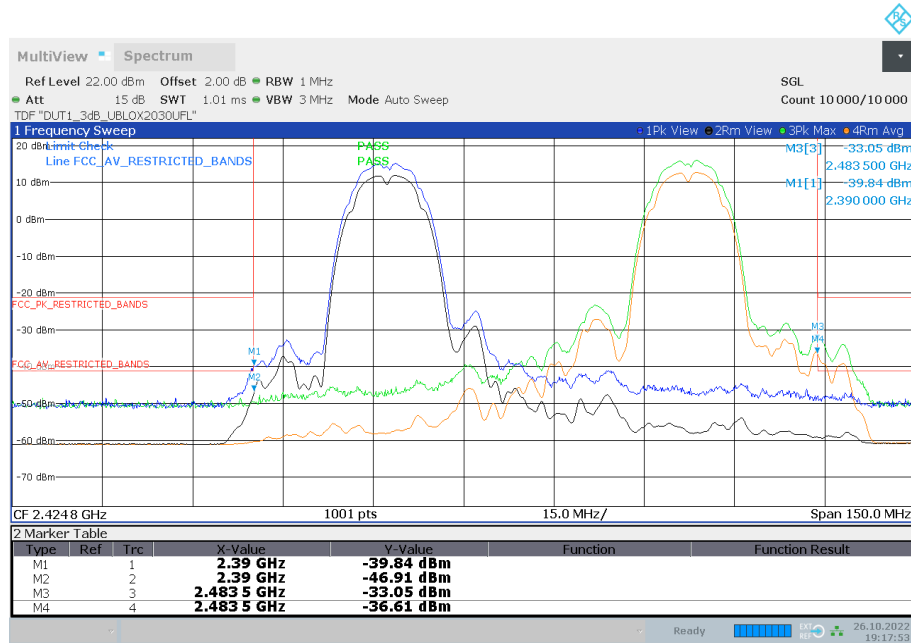

19:17:53 26.10.2022

Lowest and highest channel at power setting 19 dBm

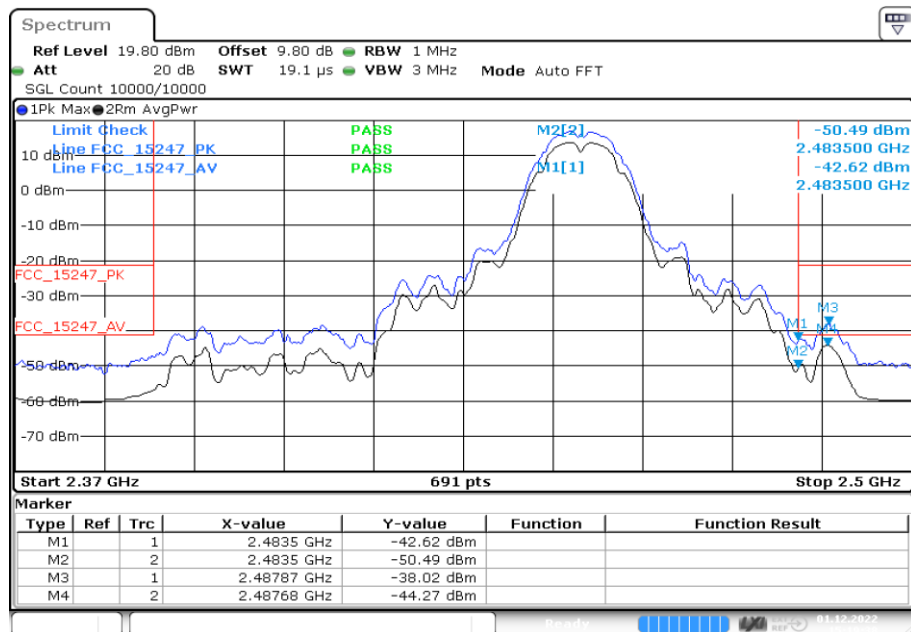

Date: 1.DEC.2022 15:19:39

Channel 9 at power setting 21 dBm

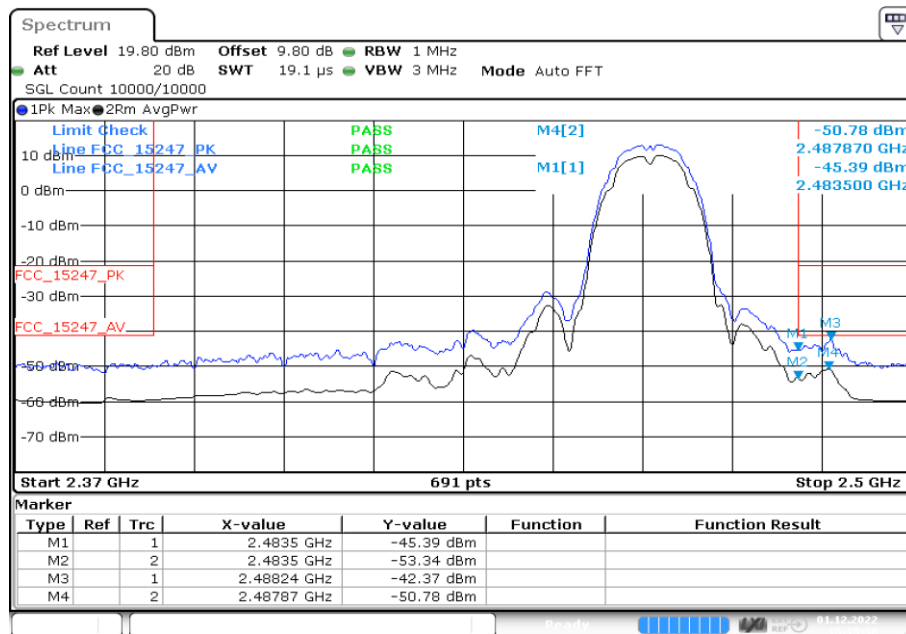

Date: 1.DEC.2022 15:15:39

Highest channel at power setting 16 dBm

Radio Technology = WLAN g, Operating Frequency = high, Band Edge = high
(S01_354_20_BB01)



Date: 1.DEC.2022 19:37:10

Lowest channel at power setting 14 dBm

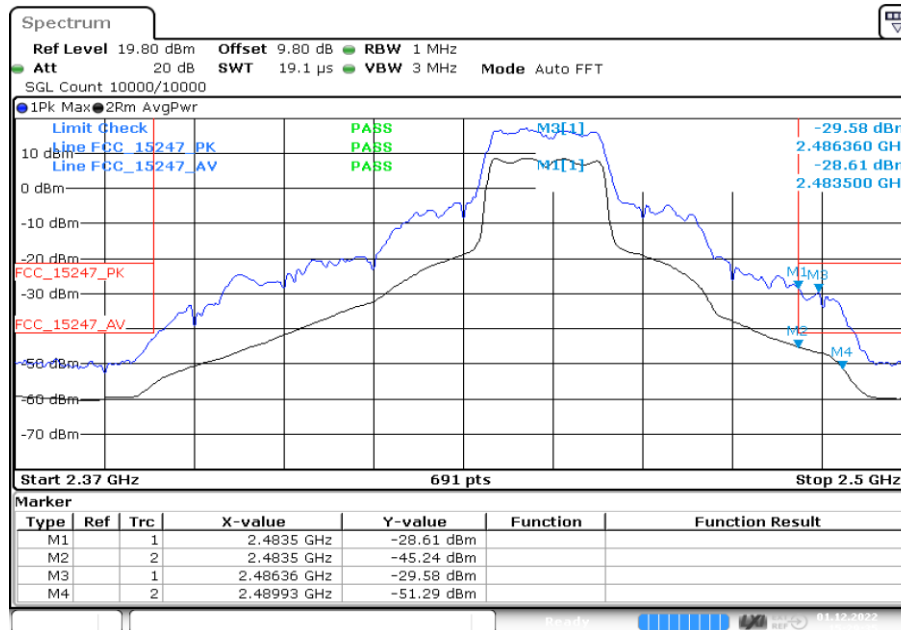

Date: 1.DEC.2022 15:29:35

Channel 8 at power setting 17 dBm

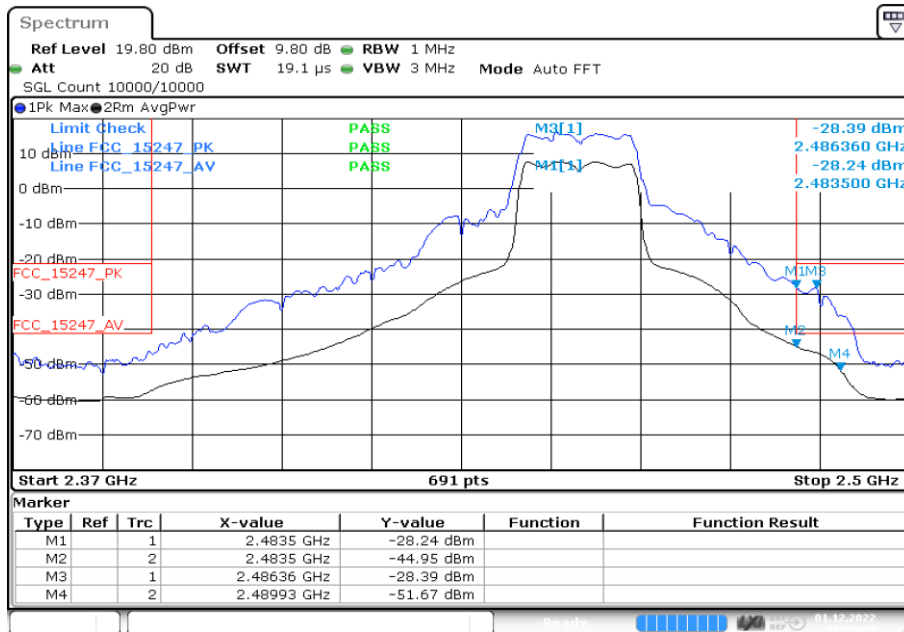

Date: 1.DEC.2022 15:26:54

Channel 9 at power setting 16 dBm

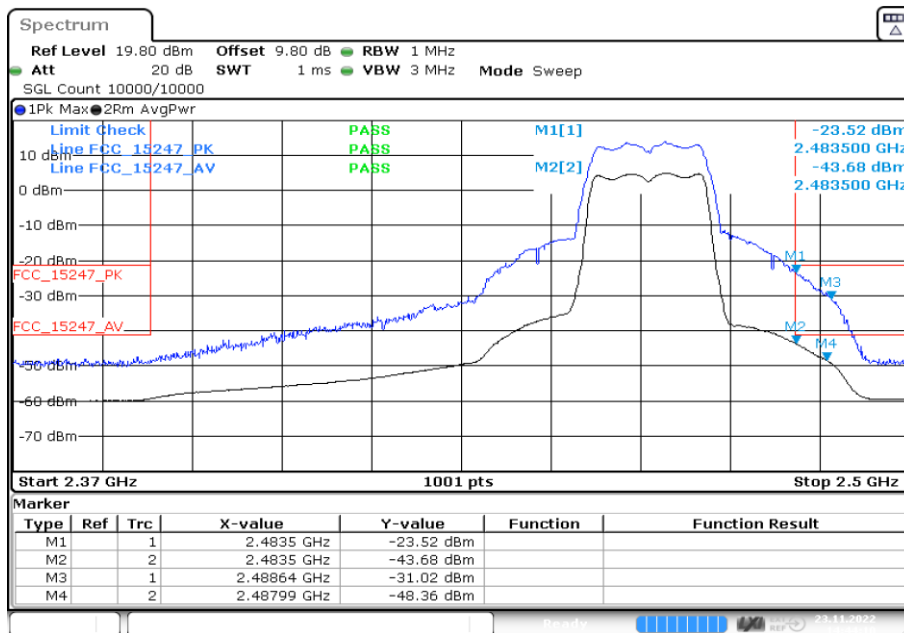

Date: 23.NOV.2022 14:44:10

Channel 10 at power setting 15 dBm

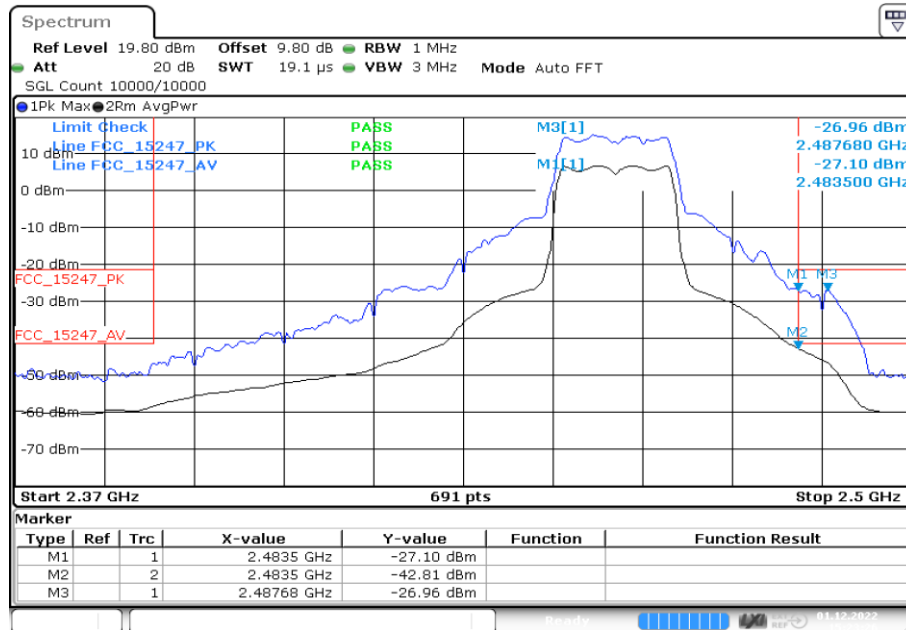

Date: 1.DEC.2022 15:23:26

highest channel at power setting 13 dBm

Radio Technology = WLAN n 20 MHz, Operating Frequency = low + high, Band Edge = low + high
(S01_354_20_BB01)

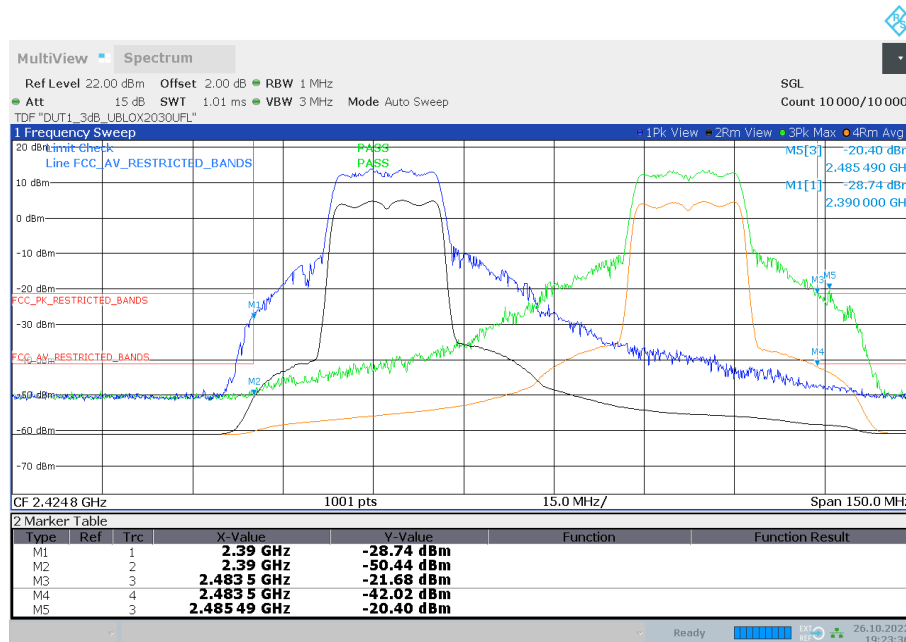

19:23:37 26.10.2022

Lowest channel at power setting 14 dBm, highest channel at power setting 13 dBm

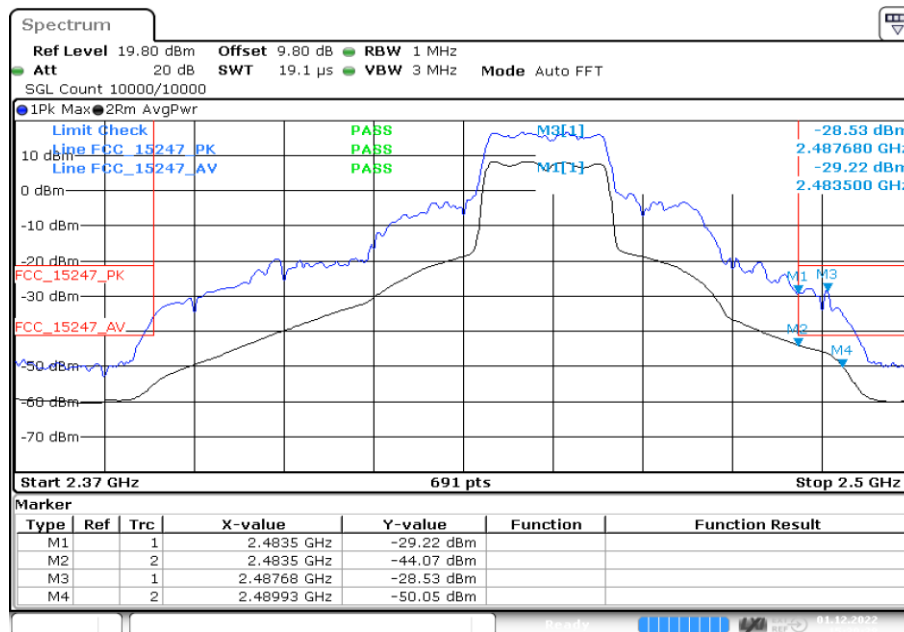

Date: 1.DEC.2022 15:39:38

Channel 8 at power setting 17 dBm

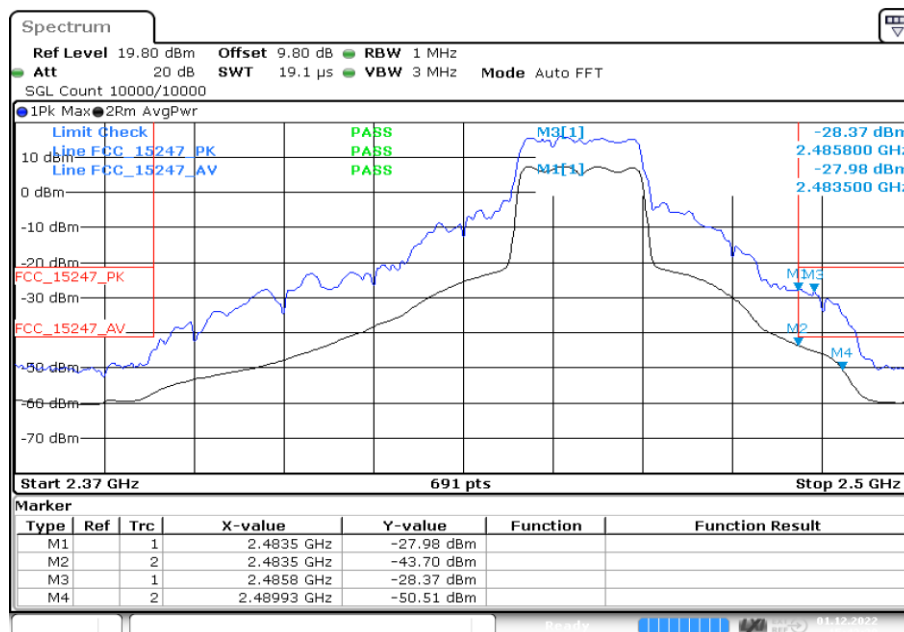

Date: 1.DEC.2022 15:42:39

Channel 9 at power setting 16 dBm

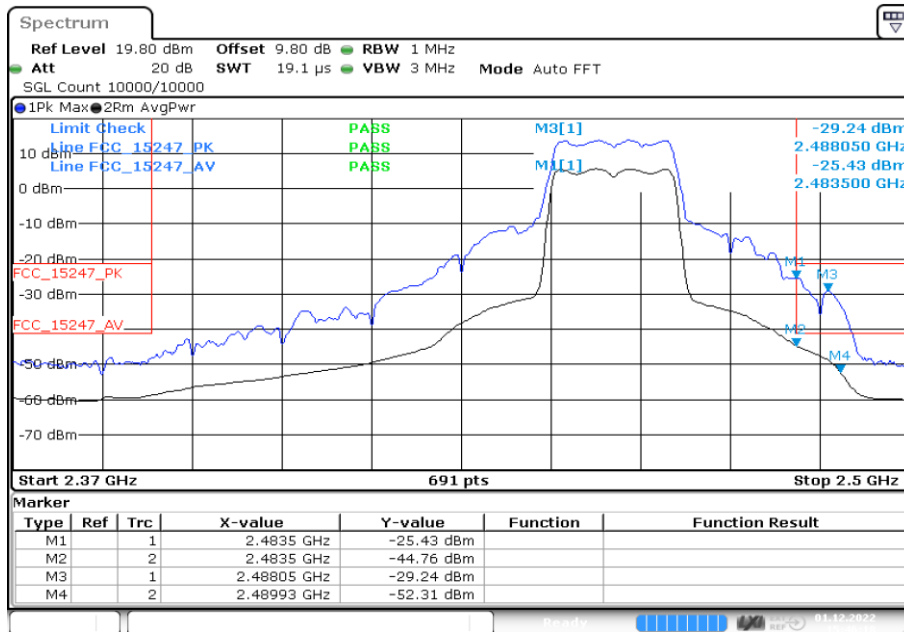

Date: 1.DEC.2022 15:46:17

Channel 10 at power setting 14 dBm

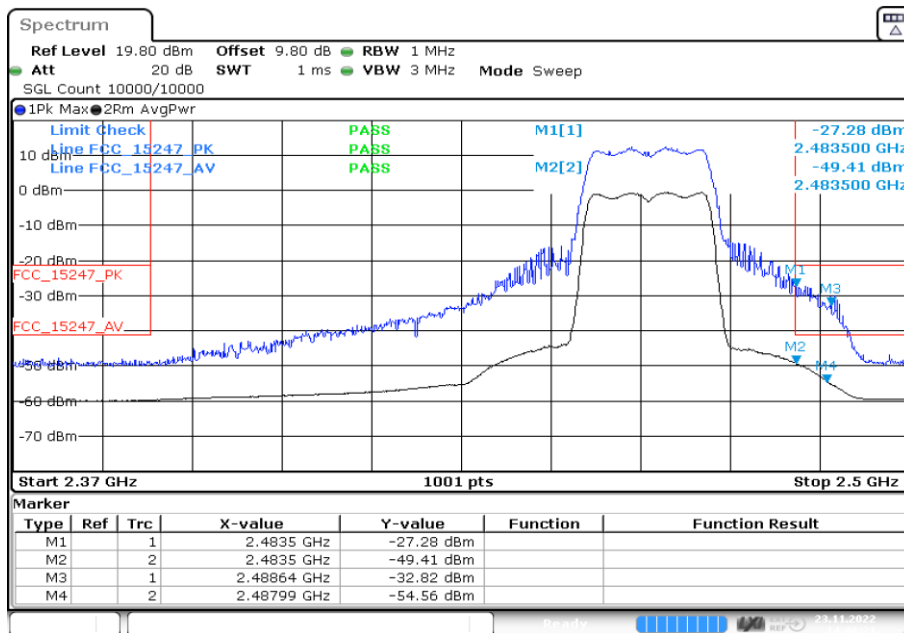

Date: 23.NOV.2022 14:48:21

Channel 11 at power setting 12 dBm

Radio Technology = WLAN n 40 MHz, Operating Frequency = low + high, Band Edge = low + high
(S01_354_20_BB01)

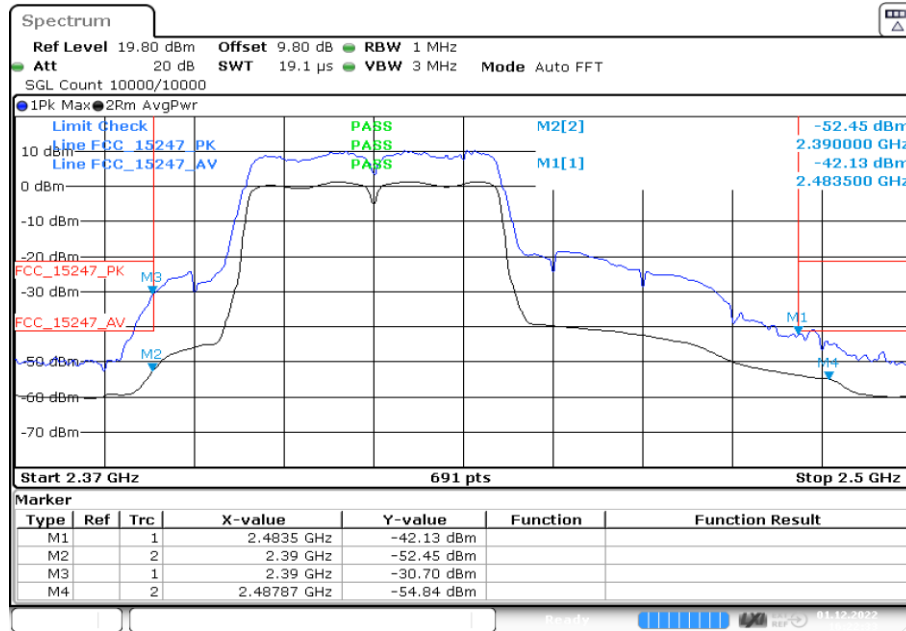

Date: 1.DEC.2022 16:22:33

Lowest channel at power setting 13 dBm

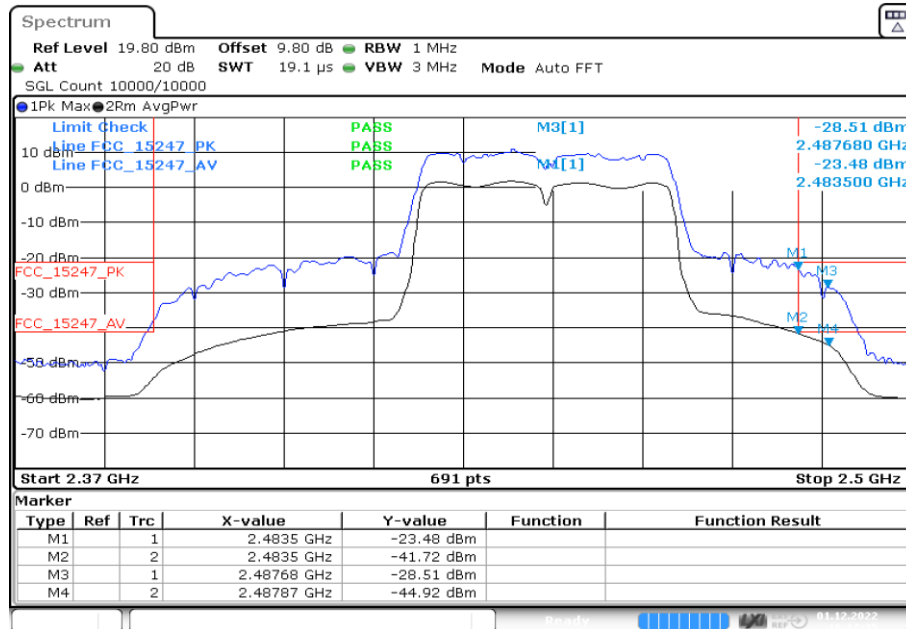

Date: 1.DEC.2022 16:17:35

Channel 8 at power setting 13 dBm

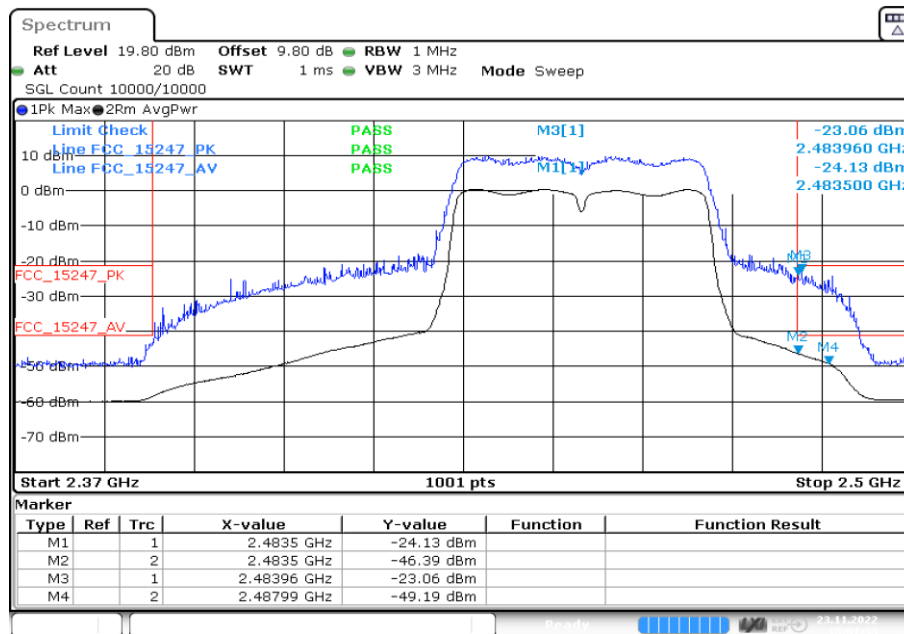

Date: 23.NOV.2022 15:01:33

Highest channel at power setting 12 dBm

Radio Technology = WLAN ax 20 MHz, Operating Frequency = low + high, Band Edge = low + high
(S01_354_20_BB01)

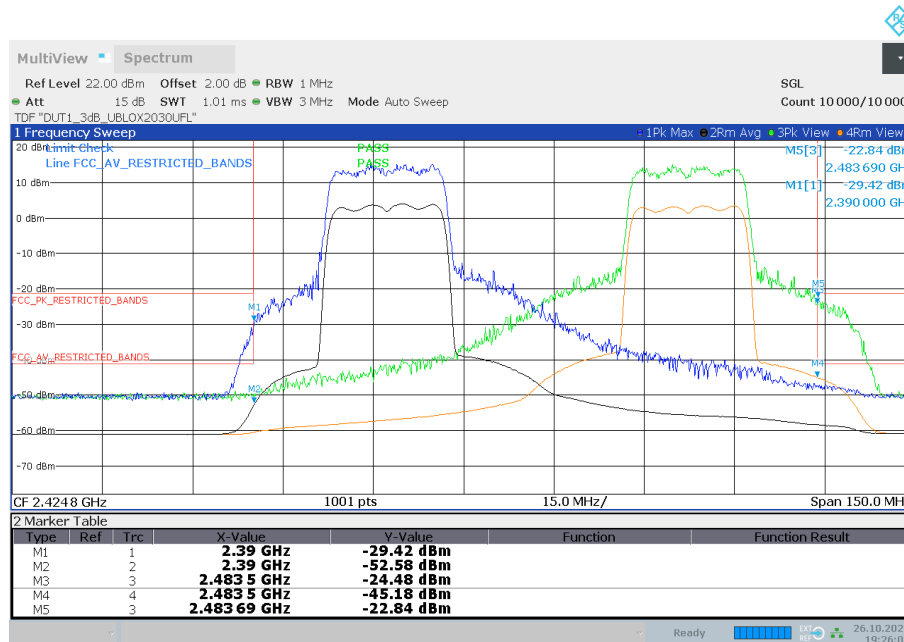

19:26:05 26.10.2022

Lowest channel at power setting 13 dBm, highest channel at power setting 12 dBm

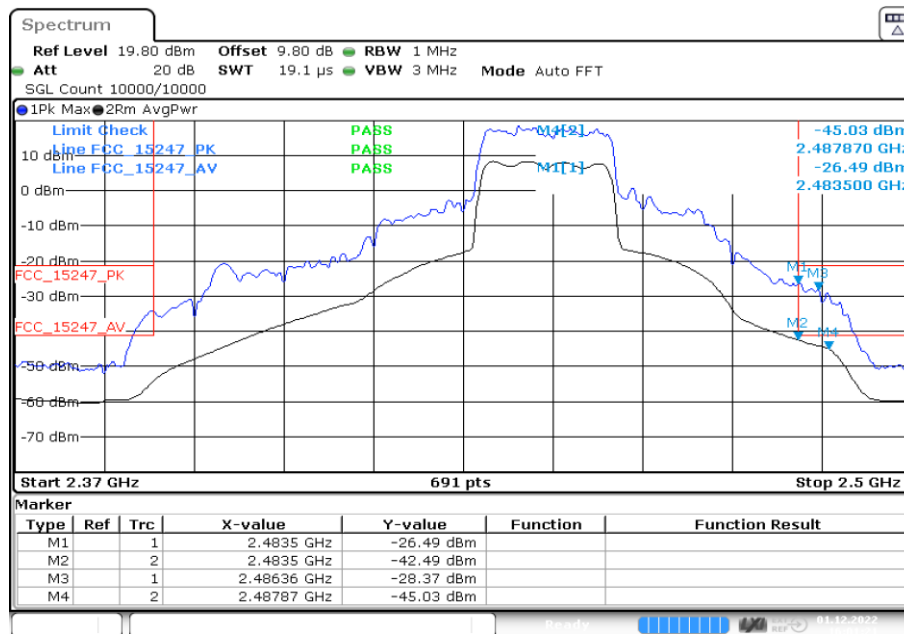

Date: 1.DEC.2022 16:01:21

Channel 8 at power setting 17 dBm

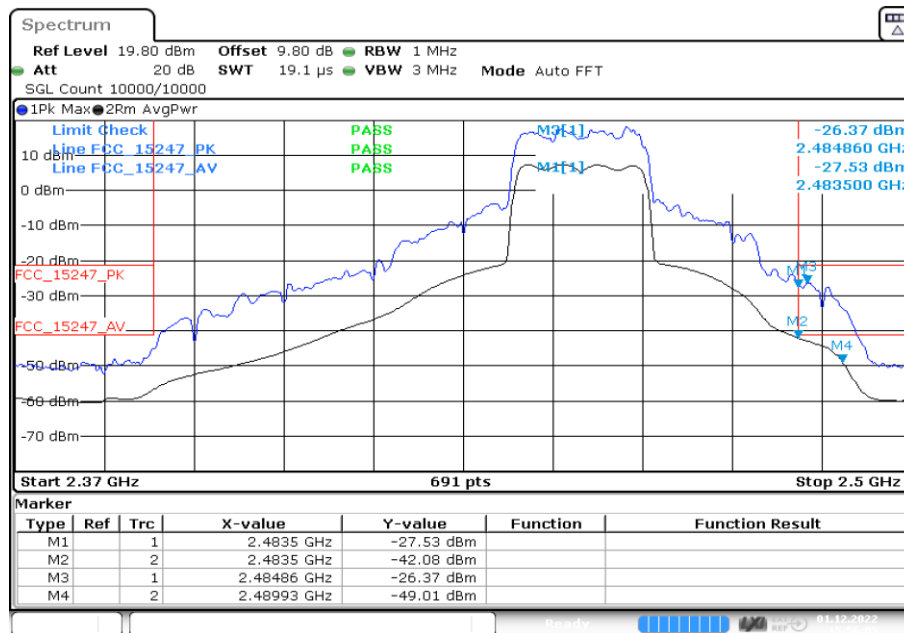

Date: 1.DEC.2022 15:56:05

Channel 9 at power setting 16 dBm

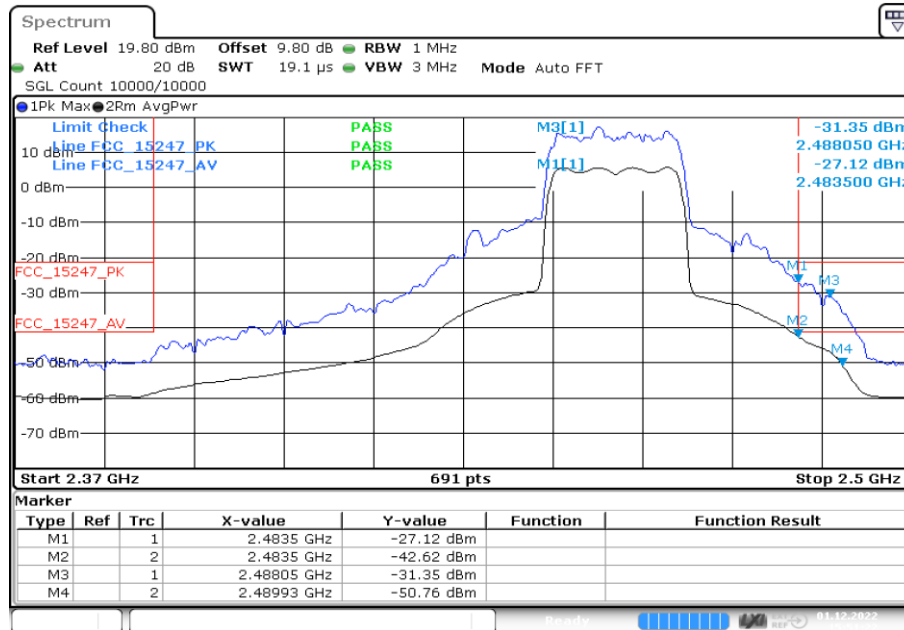

Date: 1.DEC.2022 15:51:22

Channel 10 at power setting 14 dBm

Radio Technology = WLAN ax 40 MHz, Operating Frequency = low + high, Band Edge = low + high
(S01_354_20_BB01)

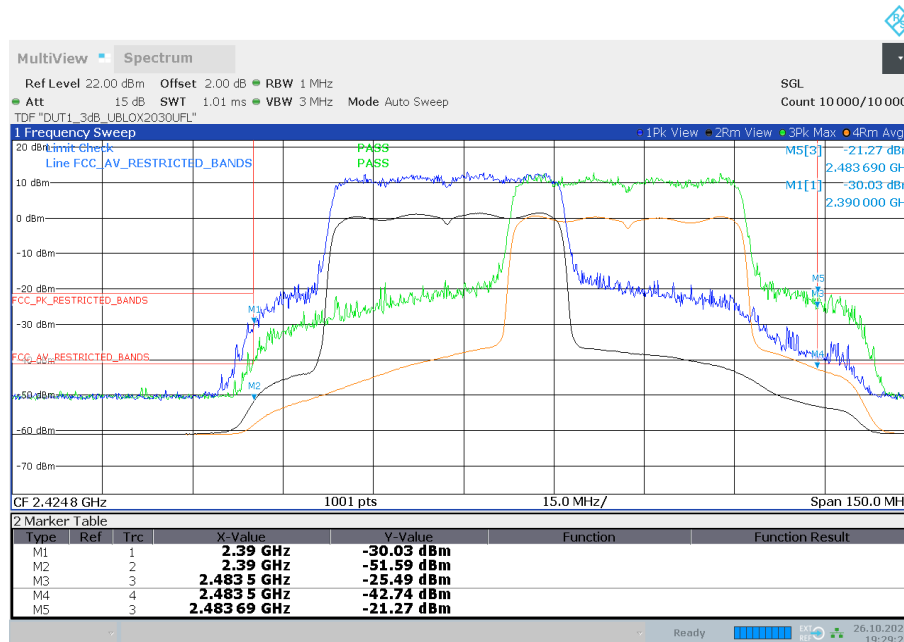

19:29:26 26.10.2022

Lowest channel at power setting 13 dBm, highest channel at power setting 12 dBm

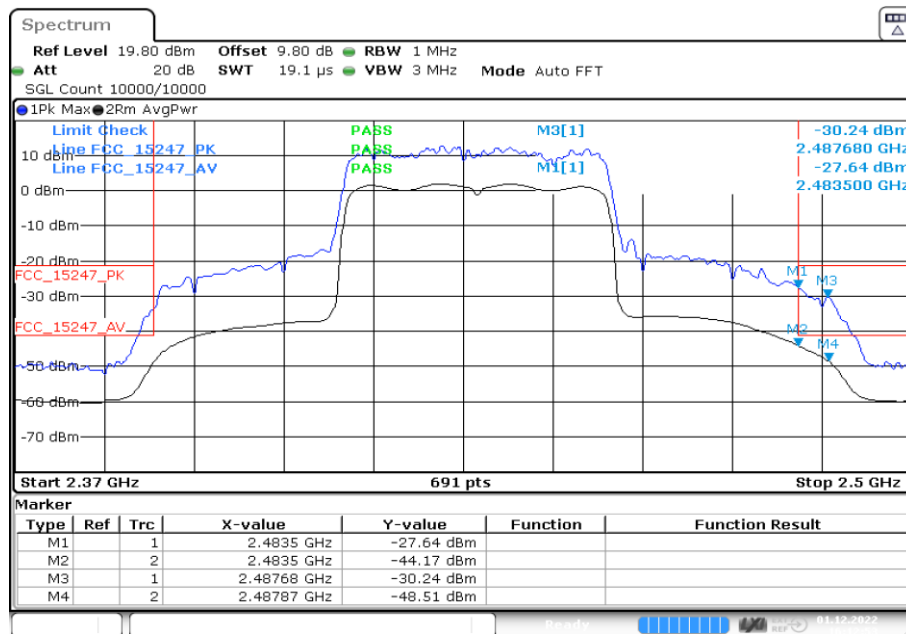

Date: 1.DEC.2022 16:12:53

Channel 6 at power setting 13 dBm

5.3.5 TEST EQUIPMENT USED

- Radiated Emissions FAR 2.4 GHz FCC
- R&S TS8997

6 TEST EQUIPMENT

6.1 TEST EQUIPMENT HARDWARE

- 1 R&S TS8997
2.4 and 5 GHz Bands Conducted Test Lab

Ref.No.	Device Name	Description	Manufacturer	Serial Number	Last Calibration	Calibration Due
1.1	MFS	Rubidium Frequency Normal	Datum GmbH	002	2021-11	2022-11
1.2	Opus10 TPR (8253.00)	T/P Logger 13	Lufft Mess- und Regeltechnik GmbH	13936	2021-10	2023-10
1.3	SMB100A	Signal Generator 9 kHz - 6 GHz	Rohde & Schwarz	107695	2021-06	2024-06
1.4	EX520	Digital Multimeter 12	Extech Instruments Corp	05157876	2022-06	2024-06
1.5	FSV30	Signal Analyzer 10 Hz - 30 GHz	Rohde & Schwarz	103005	2022-06	2024-06
1.6	NGSM 32/10	Power Supply	Rohde & Schwarz GmbH & Co. KG	3456	2022-01	2024-01
1.7	Temperature Chamber KWP 120/70	Temperature Chamber Weiss 01	Weiss	59226012190010	2022-05	2024-05
1.8	Temperature Chamber VT 4002	Temperature Chamber Vötsch 03	Vötsch	58566002150010	2022-05	2024-05
1.9	FSW43	Signal analyser	Rohde & Schwarz GmbH & Co. KG	102013	2021-06	2023-06
1.10	Opus10 THI (8152.00)	T/H Logger 14	Lufft Mess- und Regeltechnik GmbH	13993	2021-08	2023-08
1.11	SMBV100A	Vector Signal Generator 9 kHz - 6 GHz	Rohde & Schwarz	259291	2019-11	2022-11
1.12	OSP120	Contains Power Meter and Switching Unit OSP-B157W8 PLUS	Rohde & Schwarz	101158	2021-08	2024-08
1.13	CMX500	Radio Communication Tester New Radio 5G	Rohde & Schwarz GmbH & Co. KG	101305-LP	2020-04	2023-04

- 2 Radiated Emissions FAR 2.4 GHz FCC
Radiated emission tests for 2.4 GHz ISM devices in a fully anechoic room

Ref.No.	Device Name	Description	Manufacturer	Serial Number	Last Calibration	Calibration Due
1.1	Opus10 TPR (8253.00)	T/P Logger 13	Lufft Mess- und Regeltechnik GmbH	13936	2021-10	2023-10
1.2	AMF-7D00101800-30-10P-R	Broadband Amplifier 100 MHz - 18 GHz	Miteq			

Ref.No.	Device Name	Description	Manufacturer	Serial Number	Last Calibration	Calibration Due
1.3	Anechoic Chamber 03	FAR, 8.80m x 4.60m x 4.05m (l x w x h)	Albatross Projects	P26971-647-001-PRB	2021-04	2023-04
1.4	Fluke 177	Digital Multimeter 03 (Multimeter)	Fluke Europe B.V.	86670383	2022-06	2024-06
1.5	JS4-18002600-32-5P	Broadband Amplifier 18 GHz - 26 GHz	Miteq	849785		
1.6	FSW 43	Spectrum Analyzer	Rohde & Schwarz GmbH & Co. KG	103779	2021-06	2023-06
1.7	EP 1200/B, NA/B1	AC Source, Amplifier with integrated variable Oscillator	Spitzenberger & Spies GmbH & Co. KG	B6278		
1.8	3160-09	Standard Gain / Pyramidal Horn Antenna 26.5 GHz	EMCO Elektronik GmbH	00083069		
1.9	WHKX 7.0/18G-8SS	High Pass Filter	Wainwright Instruments GmbH	09		
1.10	TT 1.5 WI	Turn Table	Maturo GmbH	-		
1.11	5HC3500/18000-1.2-KK	High Pass Filter	Trilithic	200035008		
1.12	Opus 20 THI (8120.00)	ThermoHygro Datalogger	Lufft Mess- und Regeltechnik GmbH	115.0318.0802.033	2020-10	2022-10
1.13	TD1.5-10kg	EUT Tilt Device (Rohacell)	Maturo GmbH	TD1.5-10kg/024/3790709		
1.14	PAS 2.5 - 10 kg	Antenna Mast	Maturo GmbH	-		
1.15	AFS42-00101800-25-S-42	Broadband Amplifier 25 MHz - 18 GHz	Miteq	2035324		
1.16	HF 907	Double-ridged horn	Rohde & Schwarz	102444	2021-09	2024-09

The calibration interval is the time interval between "Last Calibration" and "Calibration Due"

6.2 TEST EQUIPMENT SOFTWARE

Semi-Anechoic Chamber:	
Software	Version
EMC32 Measurement Software	10.60.10
INNCO Mast Controller	1.02.62
MATURO Mast Controller	12.19
MATURO Turn-Table Controller	30.10
Fully-Anechoic Chamber:	
Software	Version
EMC32 Measurement Software	10.60.10
MATURO Turn-Unit Controller	11.10
MATURO Mast Controller	12.10
MATURO Turntable Controller	12.11
Conducted AC Emissions:	
Software	Version
EMC32 Measurement Software	10.60.20

7 ANTENNA FACTORS, CABLE LOSS AND SAMPLE CALCULATIONS

This chapter contains the antenna factors with their corresponding path loss of the used measurement path for all antennas as well as the insertion loss of the LISN.

7.1 LISN R&S ESH3-Z5 (150 KHZ – 30 MHZ)

Frequency MHz	Corr. dB	LISN insertion loss ESH3- Z5 dB	cable loss (incl. 10 dB atten- uator) dB
0.15	10.1	0.1	10.0
5	10.3	0.1	10.2
7	10.5	0.2	10.3
10	10.5	0.2	10.3
12	10.7	0.3	10.4
14	10.7	0.3	10.4
16	10.8	0.4	10.4
18	10.9	0.4	10.5
20	10.9	0.4	10.5
22	11.1	0.5	10.6
24	11.1	0.5	10.6
26	11.2	0.5	10.7
28	11.2	0.5	10.7
30	11.3	0.5	10.8

Sample calculation

$$U_{\text{LISN}} (\text{dB } \mu\text{V}) = U (\text{dB } \mu\text{V}) + \text{Corr. (dB)}$$

U = Receiver reading

LISN Insertion loss = Voltage Division Factor of LISN

Corr. = sum of single correction factors of used LISN, cables, switch units (if used)

Linear interpolation will be used for frequencies in between the values in the table.

7.2 ANTENNA R&S HFH2-Z2 (9 KHZ – 30 MHZ)

Frequency MHz	AF HFH-Z2) dB (1/m)	Corr. dB	cable loss 1 (inside chamber) dB	cable loss 2 (outside chamber) dB	cable loss 3 (switch unit) dB	cable loss 4 (to receiver) dB	distance corr. (-40 dB/ decade) dB	d _{Limit} (meas. distance (limit) m	d _{used} (meas. distance (used) m
0.009	20.50	-79.6	0.1	0.1	0.1	0.1	-80	300	3
0.01	20.45	-79.6	0.1	0.1	0.1	0.1	-80	300	3
0.015	20.37	-79.6	0.1	0.1	0.1	0.1	-80	300	3
0.02	20.36	-79.6	0.1	0.1	0.1	0.1	-80	300	3
0.025	20.38	-79.6	0.1	0.1	0.1	0.1	-80	300	3
0.03	20.32	-79.6	0.1	0.1	0.1	0.1	-80	300	3
0.05	20.35	-79.6	0.1	0.1	0.1	0.1	-80	300	3
0.08	20.30	-79.6	0.1	0.1	0.1	0.1	-80	300	3
0.1	20.20	-79.6	0.1	0.1	0.1	0.1	-80	300	3
0.2	20.17	-79.6	0.1	0.1	0.1	0.1	-80	300	3
0.3	20.14	-79.6	0.1	0.1	0.1	0.1	-80	300	3
0.49	20.12	-79.6	0.1	0.1	0.1	0.1	-80	300	3
0.490001	20.12	-39.6	0.1	0.1	0.1	0.1	-40	30	3
0.5	20.11	-39.6	0.1	0.1	0.1	0.1	-40	30	3
0.8	20.10	-39.6	0.1	0.1	0.1	0.1	-40	30	3
1	20.09	-39.6	0.1	0.1	0.1	0.1	-40	30	3
2	20.08	-39.6	0.1	0.1	0.1	0.1	-40	30	3
3	20.06	-39.6	0.1	0.1	0.1	0.1	-40	30	3
4	20.05	-39.5	0.2	0.1	0.1	0.1	-40	30	3
5	20.05	-39.5	0.2	0.1	0.1	0.1	-40	30	3
6	20.02	-39.5	0.2	0.1	0.1	0.1	-40	30	3
8	19.95	-39.5	0.2	0.1	0.1	0.1	-40	30	3
10	19.83	-39.4	0.2	0.1	0.2	0.1	-40	30	3
12	19.71	-39.4	0.2	0.1	0.2	0.1	-40	30	3
14	19.54	-39.4	0.2	0.1	0.2	0.1	-40	30	3
16	19.53	-39.3	0.3	0.1	0.2	0.1	-40	30	3
18	19.50	-39.3	0.3	0.1	0.2	0.1	-40	30	3
20	19.57	-39.3	0.3	0.1	0.2	0.1	-40	30	3
22	19.61	-39.3	0.3	0.1	0.2	0.1	-40	30	3
24	19.61	-39.3	0.3	0.1	0.2	0.1	-40	30	3
26	19.54	-39.3	0.3	0.1	0.2	0.1	-40	30	3
28	19.46	-39.2	0.3	0.1	0.3	0.1	-40	30	3
30	19.73	-39.1	0.4	0.1	0.3	0.1	-40	30	3

Sample calculation

$$E \text{ (dB } \mu\text{V/m)} = U \text{ (dB } \mu\text{V)} + AF \text{ (dB 1/m)} + Corr. \text{ (dB)}$$

U = Receiver reading

AF = Antenna factor

Corr. = sum of single correction factors of used cables, switch unit, distance correction, amplifier (if applicable)

distance correction = $-40 * \text{LOG} (d_{\text{Limit}} / d_{\text{used}})$

Linear interpolation will be used for frequencies in between the values in the table.

Table shows an extract of values

7.3 ANTENNA R&S HL562 (30 MHZ – 1 GHZ)

($d_{Limit} = 3\text{ m}$)

Frequency	AF R&S HL562	Corr.
MHz	dB (1/m)	dB
30	18.6	0.6
50	6.0	0.9
100	9.7	1.2
150	7.9	1.6
200	7.6	1.9
250	9.5	2.1
300	11.0	2.3
350	12.4	2.6
400	13.6	2.9
450	14.7	3.1
500	15.6	3.2
550	16.3	3.5
600	17.2	3.5
650	18.1	3.6
700	18.5	3.6
750	19.1	4.1
800	19.6	4.1
850	20.1	4.4
900	20.8	4.7
950	21.1	4.8
1000	21.6	4.9

cable loss 1 (inside chamber)	cable loss 2 (outside chamber)	cable loss 3 (switch unit)	cable loss 4 (to receiver)	distance corr. (-20 dB/decade)	d_{Limit} (meas. distance (limit))	d_{used} (meas. distance (used))
dB	dB	dB	dB	dB	m	m
0.29	0.04	0.23	0.02	0.0	3	3
0.39	0.09	0.32	0.08	0.0	3	3
0.56	0.14	0.47	0.08	0.0	3	3
0.73	0.20	0.59	0.12	0.0	3	3
0.84	0.21	0.70	0.11	0.0	3	3
0.98	0.24	0.80	0.13	0.0	3	3
1.04	0.26	0.89	0.15	0.0	3	3
1.18	0.31	0.96	0.13	0.0	3	3
1.28	0.35	1.03	0.19	0.0	3	3
1.39	0.38	1.11	0.22	0.0	3	3
1.44	0.39	1.20	0.19	0.0	3	3
1.55	0.46	1.24	0.23	0.0	3	3
1.59	0.43	1.29	0.23	0.0	3	3
1.67	0.34	1.35	0.22	0.0	3	3
1.67	0.42	1.41	0.15	0.0	3	3
1.87	0.54	1.46	0.25	0.0	3	3
1.90	0.46	1.51	0.25	0.0	3	3
1.99	0.60	1.56	0.27	0.0	3	3
2.14	0.60	1.63	0.29	0.0	3	3
2.22	0.60	1.66	0.33	0.0	3	3
2.23	0.61	1.71	0.30	0.0	3	3

($d_{Limit} = 10\text{ m}$)

30	18.6	-9.9
50	6.0	-9.6
100	9.7	-9.2
150	7.9	-8.8
200	7.6	-8.6
250	9.5	-8.3
300	11.0	-8.1
350	12.4	-7.9
400	13.6	-7.6
450	14.7	-7.4
500	15.6	-7.2
550	16.3	-7.0
600	17.2	-6.9
650	18.1	-6.9
700	18.5	-6.8
750	19.1	-6.3
800	19.6	-6.3
850	20.1	-6.0
900	20.8	-5.8
950	21.1	-5.6
1000	21.6	-5.6

0.29	0.04	0.23	0.02	-10.5	10	3
0.39	0.09	0.32	0.08	-10.5	10	3
0.56	0.14	0.47	0.08	-10.5	10	3
0.73	0.20	0.59	0.12	-10.5	10	3
0.84	0.21	0.70	0.11	-10.5	10	3
0.98	0.24	0.80	0.13	-10.5	10	3
1.04	0.26	0.89	0.15	-10.5	10	3
1.18	0.31	0.96	0.13	-10.5	10	3
1.28	0.35	1.03	0.19	-10.5	10	3
1.39	0.38	1.11	0.22	-10.5	10	3
1.44	0.39	1.20	0.19	-10.5	10	3
1.55	0.46	1.24	0.23	-10.5	10	3
1.59	0.43	1.29	0.23	-10.5	10	3
1.67	0.34	1.35	0.22	-10.5	10	3
1.67	0.42	1.41	0.15	-10.5	10	3
1.87	0.54	1.46	0.25	-10.5	10	3
1.90	0.46	1.51	0.25	-10.5	10	3
1.99	0.60	1.56	0.27	-10.5	10	3
2.14	0.60	1.63	0.29	-10.5	10	3
2.22	0.60	1.66	0.33	-10.5	10	3
2.23	0.61	1.71	0.30	-10.5	10	3

Sample calculation

$$E \text{ (dB } \mu\text{V/m)} = U \text{ (dB } \mu\text{V)} + \text{AF (dB 1/m)} + \text{Corr. (dB)}$$

U = Receiver reading

AF = Antenna factor

Corr. = sum of single correction factors of used cables, switch unit, distance correction, amplifier (if applicable)

distance correction = $-20 * \text{LOG} (d_{Limit} / d_{used})$

Linear interpolation will be used for frequencies in between the values in the table.

Tables show an extract of values.

7.4 ANTENNA R&S HF907 (1 GHZ – 18 GHZ)

Frequency	AF R&S HF907	Corr.
MHz	dB (1/m)	dB
1000	24.4	-19.4
2000	28.5	-17.4
3000	31.0	-16.1
4000	33.1	-14.7
5000	34.4	-13.7
6000	34.7	-12.7
7000	35.6	-11.0

cable loss 1 (relay + cable inside chamber)	cable loss 2 (outside chamber)	cable loss 3 (switch unit, attenuator & pre-amp)	cable loss 4 (to receiver)		
dB	dB	dB	dB		
0.99	0.31	-21.51	0.79		
1.44	0.44	-20.63	1.38		
1.87	0.53	-19.85	1.33		
2.41	0.67	-19.13	1.31		
2.78	0.86	-18.71	1.40		
2.74	0.90	-17.83	1.47		
2.82	0.86	-16.19	1.46		

Frequency	AF R&S HF907	Corr.
MHz	dB (1/m)	dB
3000	31.0	-23.4
4000	33.1	-23.3
5000	34.4	-21.7
6000	34.7	-21.2
7000	35.6	-19.8

cable loss 1 (relay inside chamber)	cable loss 2 (inside chamber)	cable loss 3 (outside chamber)	cable loss 4 (switch unit, attenuator & pre-amp)	cable loss 5 (to receiver)	used for FCC 15.247
dB	dB	dB	dB	dB	
0.47	1.87	0.53	-27.58	1.33	
0.56	2.41	0.67	-28.23	1.31	
0.61	2.78	0.86	-27.35	1.40	
0.58	2.74	0.90	-26.89	1.47	
0.66	2.82	0.86	-25.58	1.46	

Frequency	AF R&S HF907	Corr.
MHz	dB (1/m)	dB
7000	35.6	-57.3
8000	36.3	-56.3
9000	37.1	-55.3
10000	37.5	-56.2
11000	37.5	-55.3
12000	37.6	-53.7
13000	38.2	-53.5
14000	39.9	-56.3
15000	40.9	-54.1
16000	41.3	-54.1
17000	42.8	-54.4
18000	44.2	-54.7

cable loss 1 (relay inside chamber)	cable loss 2 (High Pass)	cable loss 3 (pre-amp)	cable loss 4 (inside chamber)	cable loss 5 (outside chamber)	cable loss 6 (to receiver)
dB	dB	dB	dB	dB	dB
0.56	1.28	-62.72	2.66	0.94	1.46
0.69	0.71	-61.49	2.84	1.00	1.53
0.68	0.65	-60.80	3.06	1.09	1.60
0.70	0.54	-61.91	3.28	1.20	1.67
0.80	0.61	-61.40	3.43	1.27	1.70
0.84	0.42	-59.70	3.53	1.26	1.73
0.83	0.44	-59.81	3.75	1.32	1.83
0.91	0.53	-63.03	3.91	1.40	1.77
0.98	0.54	-61.05	4.02	1.44	1.83
1.23	0.49	-61.51	4.17	1.51	1.85
1.36	0.76	-62.36	4.34	1.53	2.00
1.70	0.53	-62.88	4.41	1.55	1.91

Sample calculation

$$E \text{ (dB } \mu\text{V/m)} = U \text{ (dB } \mu\text{V)} + \text{AF (dB 1/m)} + \text{Corr. (dB)}$$

U = Receiver reading

AF = Antenna factor

Corr. = sum of single correction factors of used cables, switch unit, distance correction, amplifier (if applicable)

Linear interpolation will be used for frequencies in between the values in the table.

Tables show an extract of values.

7.5 ANTENNA EMCO 3160-09 (18 GHZ – 26.5 GHZ)

Frequency MHz	AF EMCO 3160-09 dB (1/m)	Corr. dB	cable loss 1 (inside chamber) dB	cable loss 2 (pre- amp) dB	cable loss 3 (inside chamber) dB	cable loss 4 (switch unit) dB	cable loss 5 (to receiver) dB
18000	40.2	-23.5	0.72	-35.85	6.20	2.81	2.65
18500	40.2	-23.2	0.69	-35.71	6.46	2.76	2.59
19000	40.2	-22.0	0.76	-35.44	6.69	3.15	2.79
19500	40.3	-21.3	0.74	-35.07	7.04	3.11	2.91
20000	40.3	-20.3	0.72	-34.49	7.30	3.07	3.05
20500	40.3	-19.9	0.78	-34.46	7.48	3.12	3.15
21000	40.3	-19.1	0.87	-34.07	7.61	3.20	3.33
21500	40.3	-19.1	0.90	-33.96	7.47	3.28	3.19
22000	40.3	-18.7	0.89	-33.57	7.34	3.35	3.28
22500	40.4	-19.0	0.87	-33.66	7.06	3.75	2.94
23000	40.4	-19.5	0.88	-33.75	6.92	3.77	2.70
23500	40.4	-19.3	0.90	-33.35	6.99	3.52	2.66
24000	40.4	-19.8	0.88	-33.99	6.88	3.88	2.58
24500	40.4	-19.5	0.91	-33.89	7.01	3.93	2.51
25000	40.4	-19.3	0.88	-33.00	6.72	3.96	2.14
25500	40.5	-20.4	0.89	-34.07	6.90	3.66	2.22
26000	40.5	-21.3	0.86	-35.11	7.02	3.69	2.28
26500	40.5	-21.1	0.90	-35.20	7.15	3.91	2.36

Sample calculation

$$E \text{ (dB } \mu\text{V/m)} = U \text{ (dB } \mu\text{V)} + AF \text{ (dB 1/m)} + Corr. \text{ (dB)}$$

U = Receiver reading

AF = Antenna factor

Corr. = sum of single correction factors of used cables, switch unit, distance correction, amplifier (if applicable)

Linear interpolation will be used for frequencies in between the values in the table.

Table shows an extract of values.

7.6 ANTENNA EMCO 3160-10 (26.5 GHZ – 40 GHZ)

Frequency GHz	AF EMCO 3160-10 dB (1/m)	Corr. dB	cable loss 1 (inside chamber) dB	cable loss 2 (outside chamber) dB	cable loss 3 (switch unit) dB	cable loss 4 (to receiver) dB	distance corr. (-20 dB/ decade) dB	d _{Limit} (meas. distance (limit) m	d _{used} (meas. distance (used) m
26.5	43.4	-11.2	4.4				-9.5	3	1.0
27.0	43.4	-11.2	4.4				-9.5	3	1.0
28.0	43.4	-11.1	4.5				-9.5	3	1.0
29.0	43.5	-11.0	4.6				-9.5	3	1.0
30.0	43.5	-10.9	4.7				-9.5	3	1.0
31.0	43.5	-10.8	4.7				-9.5	3	1.0
32.0	43.5	-10.7	4.8				-9.5	3	1.0
33.0	43.6	-10.7	4.9				-9.5	3	1.0
34.0	43.6	-10.6	5.0				-9.5	3	1.0
35.0	43.6	-10.5	5.1				-9.5	3	1.0
36.0	43.6	-10.4	5.1				-9.5	3	1.0
37.0	43.7	-10.3	5.2				-9.5	3	1.0
38.0	43.7	-10.2	5.3				-9.5	3	1.0
39.0	43.7	-10.2	5.4				-9.5	3	1.0
40.0	43.8	-10.1	5.5				-9.5	3	1.0

Sample calculation

$$E \text{ (dB } \mu\text{V/m)} = U \text{ (dB } \mu\text{V)} + \text{AF (dB 1/m)} + \text{Corr. (dB)}$$

U = Receiver reading

AF = Antenna factor

Corr. = sum of single correction factors of used cables, switch unit, distance correction, amplifier (if applicable)

Linear interpolation will be used for frequencies in between the values in the table.

distance correction = $-20 * \text{LOG} (d_{\text{Limit}} / d_{\text{used}})$

Linear interpolation will be used for frequencies in between the values in the table.

Table shows an extract of values.

8 MEASUREMENT UNCERTAINTIES

Test Case	Parameter	Uncertainty
AC Power Line	Power	± 3.4 dB
Field Strength of spurious radiation	Power	± 5.5 dB
6 dB / 26 dB / 99% Bandwidth	Power Frequency	± 2.9 dB ± 11.2 kHz
Conducted Output Power	Power	± 2.2 dB
Band Edge Compliance	Power Frequency	± 2.2 dB ± 11.2 kHz
Frequency Stability	Frequency	± 25 Hz
Power Spectral Density	Power	± 2.2 dB

The measurement uncertainties for all parameters are calculated with an expansion factor (coverage factor) $k = 1.96$. This means, that the true value is in the corresponding interval with a probability of 95 %.

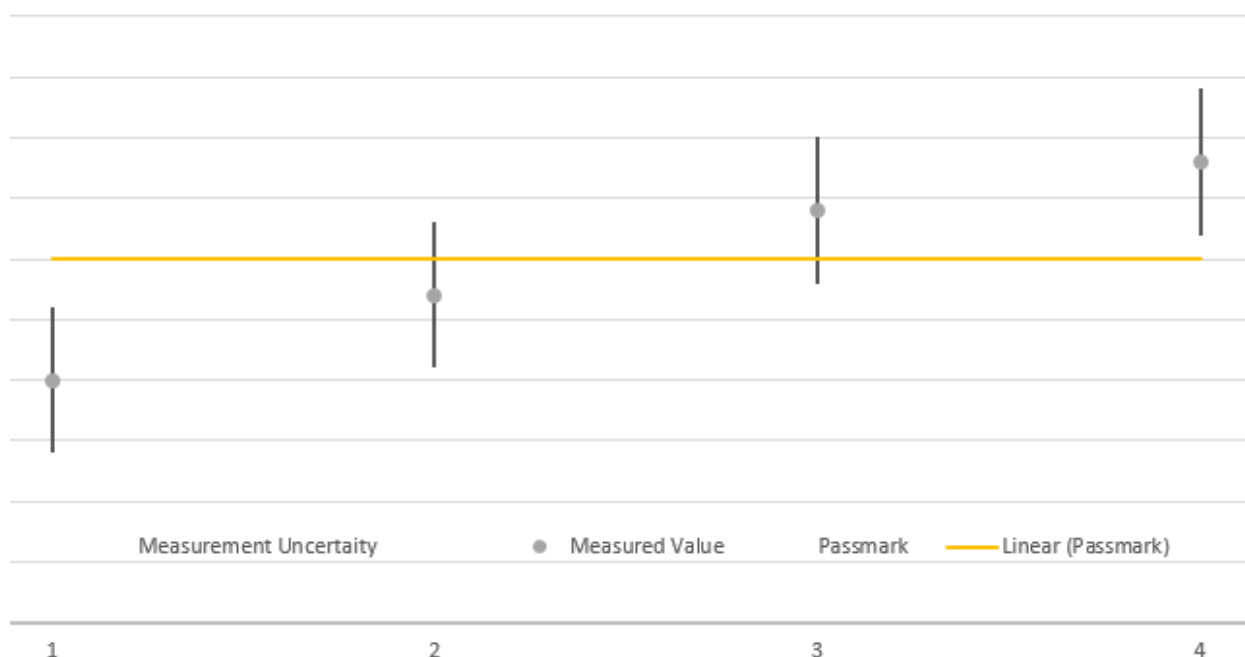

The verdicts in this test report are given according the above diagram:

Case	Measured Value	Uncertainty Range	Verdict
1	below pass mark	below pass mark	Passed
2	below pass mark	within pass mark	Passed
3	above pass mark	within pass mark	Failed
4	above pass mark	above pass mark	Failed

That means, the laboratory applies, as decision rule (see ISO/IEC 17025:2017), the so called shared risk principle.

9 PHOTO REPORT

Please see separate photo report.