

- Features
- Functions
- Installation
- Adjustment and Application
- Operation
- Precautions
- Troubleshooting Guide
- Warranty

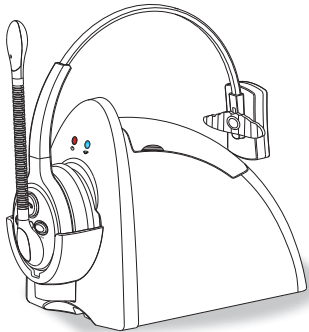

# 1.Features

- 2.4Ghz wireless headset
- ambient temperature:-10℃~+40℃
- relative humidity:10%~95%
- atmospheric pressure:86~106Kpa
- applicable all telephone
- wireless connection distance:100M(max)
- calling time: 5h
- standby time:20h

## Constitution

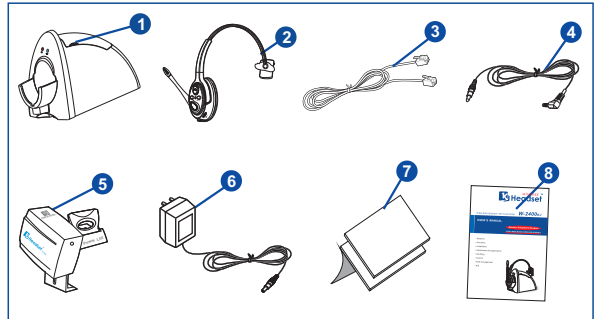

- |   |                             |
|---|-----------------------------|
| <b>1</b> wireless telephone (main part) | <b>5</b> LIFT               |
| <b>2</b> wireless headset               | <b>6</b> Adaptor            |
| <b>3</b> connecting line                | <b>7</b> LIFT Sponge cradle |
| <b>4</b> Lift connecting line           | <b>8</b> manual             |

## 2.Functions

### A. Receiver

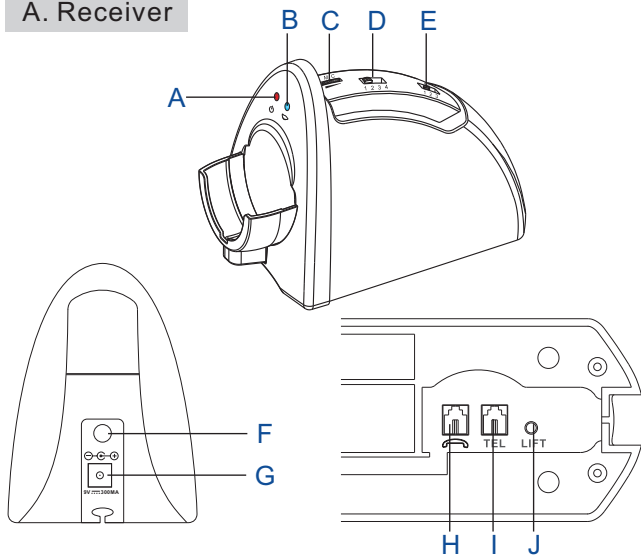

#### A. Power Indicator

Power Indicator (red) of Base Station will be ON when the Main Station is plugged into the electrical outlet.

#### B. Call&Receive/Charge Indicator

The indicator is ON when either the main station is being charged or the phone is being used.

#### C. Volume adjustment of the microphone

Adjust the volume of the microphone while the phone is

being used.

#### D. Select the telephone power line

Select the telephone power line 1~ 4 range to match the different power.

#### E. Polarity switch of MIC

F. **Paging Button**  
paging button (headset signal)

#### G. Adaptor

H. **Headset connecting line** (mic connecting line) jack

I. **TEL connecting line jack**

J. **LIFT jack**

## B. Wireless Headset

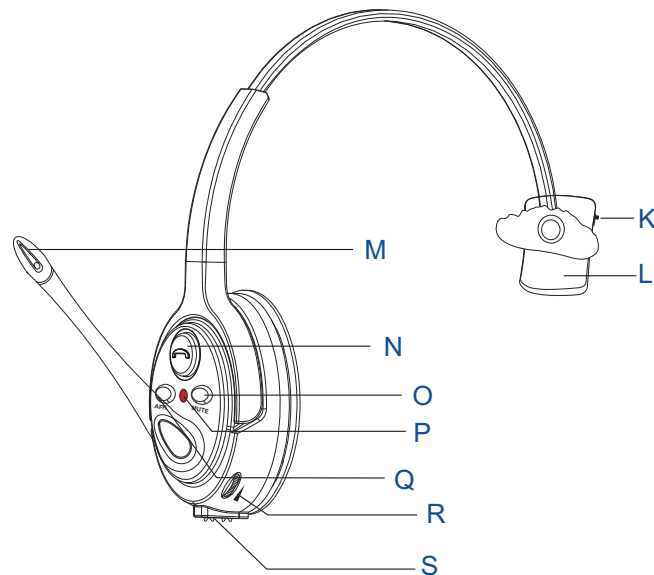

K. ON/OFF Battery Switch :  
make sure the power is ON  
when it is being used.

L. Battery

M. MIC : (Microphone)

N. Call / Receive : Press the

Call/receive button when you  
either call or receive the phone.

O. MUTE: The MUTE button on

the Headset during a call to make  
other person not to hear your  
voice. To mute or un-mute during  
a call, press the MUTE button.

P. indicator light

Q. AFH: Select the optimal channel  
by changing the frequency.

R. VOL: Volume adjustment for  
receiving

S. POWR OFF

## C. LIFT

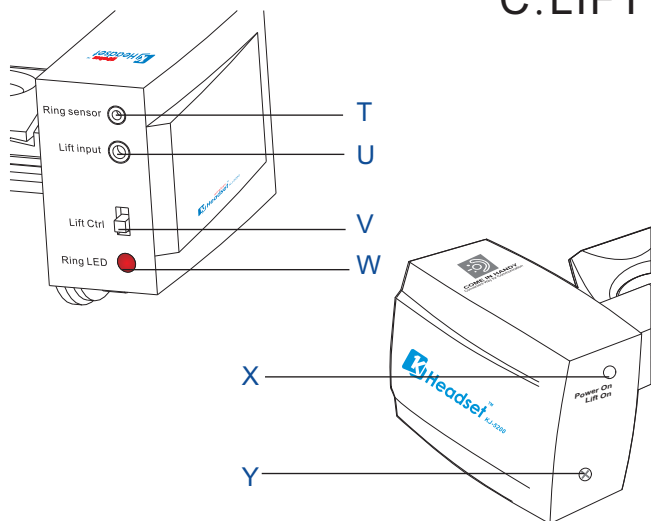

**T. RING SENSOR:** It can be varied due to using different type of phones (however the most of the phones will be same)

**U. LIFT INPUT:** Connect to the LIFT with connecting line.

**V. LIFT CTRL:** The switch has 3 different positions to adjust the lifting level of the LIFT.

**W. RING LED:** The light will be on when the LIFT is being used.

**X. RING LED:** The light will be on when the

**Y. RING LED:** The light will be on when the

## 3. Installation

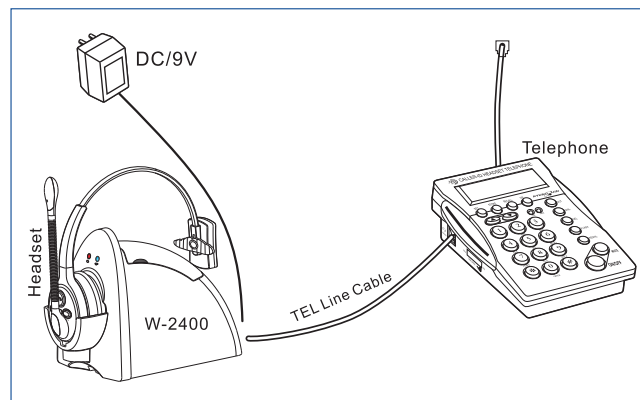
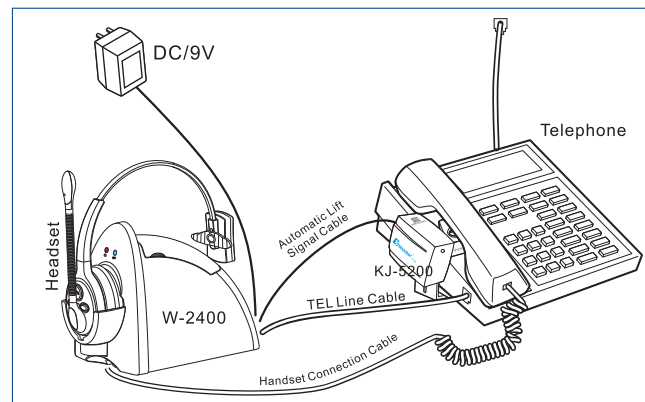

1. Plug Connect the DC9V adaptor on the backside of the main station.



2. Unplug the handset (receiver) connection cable from the telephone and plug it in to the handset connecting jack at the bottom of W-2400 Main Station.(no need to connect with the phone without receiver)



3. Connect with the provided connecting line to the unplugged jack of the handset(receiver) and the other end to jack at the bottom of the main station.



4. Connect the LIFT with connecting line to the jack at the bottom of the main station and the jack of the LIFT.



5. Use the Headset after it is fully charged. (The Battery ON/OFF switch must be ON when the headset is used).

## 4.Adjustment and Application

### Headset Charging

1. Place the headset on top of the main station to charge. Then the green light will be ON. Turn on the ON/OFF switch on the battery section to charge the headset. (It takes more than 6 hours to be fully charged when it is being charged the first time.)
2. Make sure that the headset is properly placed on the main station. When it is properly done, the green light will be ON.

### Headset Application

1. Power switch should be ON after the headset has been separated from the main station when it is being used. (To save the battery, turn OFF the battery switch when it is not being used for a long time)
2. Call/Receiving can be made by pressing the Call/Receiving switch. The LED light will be ON. Check the connection lines if either the LED light is not ON or no signal tone.
3. MUTE button on the Headset may be used during a call to make other person not to hear your voice. To mute or un-mute during a call, press the MUTE button.
4. Press the AFH button of the Adaptive Frequency Hopping System when several headsets are being used at the same location.

## Main Station

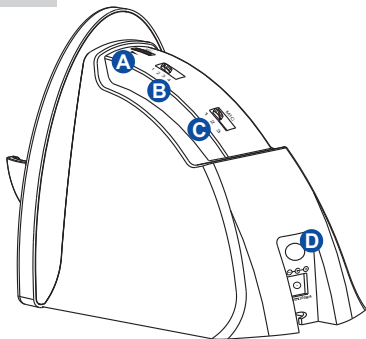

1. Adjust A button to get the best sound.
2. Change the B (1-4) switch on the headset when there is either no or abnormal signal tone.
3. Use C button when the signal tone cannot be adjusted with A button.
4. Use D button when you want to page the person using the headset.

## 5. Operation

### Receiving a Call

1. Press the  switch when the phone ringing.
2. If the LIFT is connected, it will be operating automatically. If not, it can be answered by picking up the handset (receiver) of the phone or pressing the headset button.

### Make a call

1. Press the  switch then dial the number.
2. Signal tone can be heard when the LIFT is operating.  
If the LIFT is not connected, the handset (receiver) should be picked up to hear the signal tone.

## 6. Precaution

1. Keep the wireless headset dry. Precipitation, humidity and all types of liquids or moisture can contain minerals that it will corrode electronic circuits. If your device does get wet, allow it to dry completely.
2. Do not use or store the wireless headset in dusty, dirty areas. Its moving parts and electronic components can be damaged.
3. Do not drop, knock, over powering when pressing buttons or shake the wireless headset. Rough handling can break internal circuit boards and fine mechanics.
4. Do not attempt to open the wireless headset. If any part such as battery, adapter, headset and main station is not working properly, take it to the nearest authorized service facility for service.
5. Battery life time is around 400 charging times. Make sure to make the replacement with properly certified battery with the same specifications.
6. If the wireless headset will not be used for a long time, the switch for the battery should be OFF.
7. If the Headset will not be used for a long time, it is recommended to charge fully then store in the original package and store it properly.

## 7. Troubleshooting Guide

Problem	Cause	Solution
Lift is not functioning properly and indicator light is keeping flashing	Power supply is malfunctioning due to the connection is not properly made	The jack of Automatic Lift Signal Cable to W-2400 Main Station should be removed and reconnected
All set up of the wireless headset is done properly but still not functioning	Frequencies of Headset and Telephone is not matched	Place the Headset on the Main Station then operate while it is on the charge terminator
	Battery is dead or its switch is off	Put the switch ON or recharge the battery
Cannot hear the other person's voice	Sound control of the Headset is not properly set up	Adjust the sound control on the Headset
Other person cannot hear any sound	MIC volume control of the headset has not set up properly	Adjust the MIC volume control on the main station

## 8. Warranty Service

1. When the product is not working properly, do not attempt to repair it yourself and take it to the nearby certified service center or retail store where the product has purchased.



### Warranty Service ●

- 1 Products cord and Number: \_\_\_\_\_
- 2 Company name: \_\_\_\_\_
- 3 Contact name: \_\_\_\_\_
- 4 Email address: \_\_\_\_\_
- 5 Address: \_\_\_\_\_
- 6 Purchase date: \_\_\_\_\_

Customer should fill out 1-5 and Retail store should fill out 6.

This wireless headset does not guarantee the security during a call and may have some interference while in use.



2.4Ghz WIDE BAND CORDLESS HEADSET

MAIN OFFICE / KYUNG JIN ELECTRON CO., LTD.  
 H.K.OFFICE / KJ COMMUNICATION(H.K)CO., LTD.  
 FACTORY / N-SIA COMMUNICATION(S.Z)CO., LTD.

[www.kj-headset.co.kr](http://www.kj-headset.co.kr)