

Electromagnetic Emission
FCC MEASUREMENT REPORT
CERTIFICATION OF COMPLIANCE
FCC Part 15 Certification Measurement

PRODUCT : High Definition Set top Box
MODEL/Serial No. : Azbox Premium HD+ / Proto type
Multiple Model : NONE
FCC ID : XNXAZBOXPREMIUMHD
APPLICANT : OpenSat Lda.
Edificio Opensat, Lagoa, 4950-283 Mazedo MNC, PORTUGAL
Attn. : Hugo Condessa / C.E.O
MANUFACTURER : TG Korea
1125-1 Singil-Dong, Danwon-Gu, Ansan-City,
Gyeonggi-Do, 425-839, Korea
FCC CLASSIFICATION : DTS: Part 15 Digital Transmission System
TYPE OF MODULATION : DSSS(CCK), OFDM(QAM)
FREQUENCY CHANNEL : 2 412 MHz to 2 462 MHz and Channel Spacing 5 MHz (11 Channels)
AIR DATE RATE : 11 Mbps(802.11b mode), 54 Mbps(802.11g mode)
ANTENNA TYPE : PIFA antenna
ANTENNA GAIN : 2.97 dBi max
RULE PART(S) : FCC Part 15 Subpart B and Subpart C
FCC PROCEDURE : ANSI C63.4-2003
TEST REPORT No. : ETLE090810.05
DATES OF TEST : September 04, 2009 to September 09, 2009
REPORT ISSUE DATE : October 26, 2009
TEST LABORATORY : ETL Inc. (FCC Designation Number : KR0022)

The High Definition Set top Box, Model Azbox Premium HD+ has been tested in accordance with the measurement procedures specified in ANSI C63.4-2003 at the ETL Test Laboratory and has been shown to be complied with the electromagnetic radiated emission limits specified in FCC Rule Part15 Subpart C section 15.247

I attest to the accuracy of data. All measurement herein was performed by me or was made under my supervision and is correct to the best of my knowledge and belief. I assume full responsibility for the completeness of these measurements and vouch for the qualifications of all persons taking them.

The results of testing in this report apply to the product/system which was tested only. Other similar equipment will not necessarily produce the same results due to production tolerance and measurement uncertainties.



Hyung Seok, Lee / Chief Engineer

ETL Inc.
#371-51, Gasan-dong, Geumcheon-gu, Seoul, 153-803, Korea
Tel: 82-2-858-0786 Fax: 82-2-858-0788

Table of Contents

FCC Measurement Report

1. Introduction
2. Product Information
3. Description of Tests
4. Test Condition
5. Test Results
 - 5.1 Summary of Test Results
 - 5.2 6 dB Bandwidth
 - 5.3 Maximum Peak Output Power
 - 5.4 Band Edges Measurement
 - 5.5 Peak Power Spectral density
 - 5.6 Spurious Emissions
 - 5.7 Conducted Emissions Test
6. Sample Calculation
7. List of test Equipment used for Measurement

Appendix A. FCC ID Label and Location

Appendix B. Test Setup Photographs

Appendix C. External Photographs

Appendix D. Internal Photographs

Appendix E. Block Diagram

Appendix F. Circuit Diagram

Appendix G. User Manual

Appendix H. Operational Description

Appendix I. Antenna Requirement

Appendix j. Radio Frequency Exposure

FCC MEASUREMENT REPORT

Scope – Measurement and determination of electromagnetic emission(EME) of radio frequency devices including intentional radiators and/or unintentional radiators for compliance with the technical rules and regulations of the U.S Federal Communications Commission(FCC)

General Information

Applicant Name	: OpenSat Lda.
Address	: Edificio Opensat, Lagoa, 4950-283 Mazedo MNC, PORTUGAL
Attention	: Hugo Condessa / C.E.O

- **EUT Type** : High Definition Set top Box
- **Model Number** : Azbox Premium HD+
- **S/N** : Proto type
- **Freq. Range** : 2 412 MHz – 2 462 MHz
- **Number of Channels** : 11
- **Modulation Technique** : DSSS(CCK), OFDM(QAM)
- **Frequency Channel** : 2 412 MHz to 2 462 MHz and Channel Spacing 5 MHz (11 Channels)
- **Air Data Rate** : 11 Mbps(802.11b mode), 54 Mbps(802.11g mode)
- **Antenna Type** : PIFA antenna
- **ANTENNA GAIN** : 2.97 dBi max
- **FCC Rule Part(s)** : FCC Part 15 Subpart B and C
- **Test Procedure** : ANSI C63.4-2003
- **FCC Classification** : DTS: Part 15 Digital Transmission System
- **Place of Tests** : ETL Inc. Testing Lab.
Radiated Emission test;
#499-1, Sagot-ri, Seosin-myeon, Hwaseong-si, Gyeonggi-do,
445-882, Korea

Conducted Emission test;
ETL Inc. Testing Lab.
371-51, Gasan-dong, Geumcheon-gu, Seoul, 153-803, Korea

1. INTRODUCTION

The measurement test for radiated and conducted emission test was conducted at the ETL Inc. The site is constructed in conformance with the requirements of the ANSI C63.4-2003 and CISPR Publication 16. The ETL has site descriptions on file with the FCC for 3 m and 10 m site configurations. Detailed description of test facility was found to be in compliance with FCC Rules according to the ANSI C63.4-2003 and registered to the Federal Communications Commission (FCC Designation Number : KR0022).

The measurement procedure described in American National Standard for Method of Measurement of Radio-Noise Emission from Low-Voltage Electrical and Electronic Equipment in the Range of 9 kHz to 40 GHz (ANSI C63.4-2003) was used in determining radiated and conducted emissions from the OpenSat Lda., Model: Azbox Premium HD+

2. PRODUCT INFORMATION

2.1 Equipment Description

The Equipment Under Test (EUT) is High Definition Set top Box (model: Azbox Premium HD+).

2.2 General Specification

Item	Specification
Power (Adapter)	Input: AC 100 V – 240 V; 50 Hz/60 Hz; 1.5 A Max
	Output: DC 12.0 V; 5 000 mA; DC 24.0 V; 1 000 mA
Dimension	340 mm (W) x 243 mm (H) x 66 mm (D)
Gross Weight	2.65 kg
Net Weight	2.11 kg
Operating Temperature	0 °C ~ 60 °C
Storage Temperature	-10 °C ~ +70 °C
HDMI	High definition video output
	Left & right audio output
	Dolby digital audio output
VIDEO	Composite video (CVBS) output
AUDIO	Left & right audio output
YCbCr	Component video (YUV) output
S/PDIF	Dolby digital audio output
USB	2.0 Host (5 V, 500 mA)

Channel ID	1	2	3	4	5	6	7	8	9	10	11
GHz	2.412	2.417	2.422	2.427	2.432	2.437	2.442	2.447	2.452	2.457	2.462

*Antenna Gain

- Main

2.4 GHz: 2.87

2.45 GHz: 2.93

- Aux

2.4 GHz: 2.71

2.45 GHz: 2.97

*RF Modulation Type

- IEEE 802.11g: BPSK, QPSK, 16QAM, QFDM

- IEEE 802.11b: DQPSK, DBPSK, DSSS, CCK

3. DESCRIPTION OF TESTS

3.1 Radiated Emission Measurement

Radiated emission measurements were made in accordance with § 13 in ANSI C63.4-2003 "Measurement of Intentional radiators" The measurements were performed over the frequency range of 30 MHz to 40 GHz using antenna as the input transducer to a Spectrum analyzer or a Field Intensity Meter. The measurements were made with the detector set for "Peak, Quasi-peak, Average" within a bandwidth of 120 kHz and above 1GHz is 1 MHz.

Preliminary measurements were made at 3 m using broadband antennas, and spectrum analyzer to determine the frequency producing the maximum emission in shielded room. Appropriate precaution was taken to ensure that all emission from the EUT were maximized and investigated. The system configuration, mode of operation, turntable azimuth and height with respect to the antenna were noted for each frequency found. The spectrum was scanned from 30 MHz to 1000 MHz using Log-Bicon antenna. Above 1 GHz, linearly polarized double ridge horn antennas were used. Final measurements were made open site at 3 m. The test equipment was laced on a wooden turn-table. Sufficient time for the EUT, support equipment, and test equipment was allowed in order for them to warm up to their normal operating condition. Each frequency found during pre-scan measurements was re-examined by manual. The detector function was set to CISPR Quasi-peak mode and the bandwidth of the receiver was set to 120 kHz or 1 MHz depending on the frequency of type of signal. The EUT, support equipment and interconnecting cables were re-configured to the set-up producing the maximum emission for the frequency and were placed on top of a 0,8 m high nonmetallic 1m x 1.5 m table. The EUT, support equipment, and interconnecting cables were re-arranged and manipulated to maximize each emission. The turntable containing the system was rotated; the antenna height was varied 1 m to 4 m and stopped at the azimuth or height producing the maximum emission.

Varying the mode of operating frequencies of the EUT maximized each emission. The system was tested in all the three orthogonal planes and changing the polarity of the antenna. The worst-case emissions are recorded in the data tables. If necessary, the radiated emission measurement could be performed at a closer distance to ensure higher accuracy and the results were extrapolated to the specified distance using an inverse linear distance extrapolation factor (20 dB/decade) as per section 15.31(f).

Photographs of the worst-case emission can be seen in Photographs of the worst-case emission test setup can be seen in Appendix B.

3.2 Conducted Emission Measurement

Conducted emissions measurements were made in accordance with section § 13 in ANSI C63.4-2003 "measurement of intentional radiators" The measurements were performed over the frequency range of 0.15 MHz to 30 MHz using a 50 Ω / 50 uH LISN as the input transducer to a Spectrum Analyzer or a Test Receiver. The measurements were made with the detector set for "Peak" amplitude within a bandwidth of 9 kHz or for "quasi-peak" within a bandwidth of 9 kHz.

The line-conducted emission test is conducted inside a shielded anechoic chamber room with 1 m x 1.5 m x 0.8 m wooden table which is placed 0.4 m away from the vertical wall and 1.5 m away from the side wall of the chamber room. Two LISN are bonded to the shielded room. The EUT is powered from the LISN and the support equipment is powered from the other LISN. Power to the LISNs are filtered by a noise cut power line filters. All electrical cables are shielded by braided tinned steel tubing with inner ϕ 1.2 cm. If the EUT is a DC-powered device, power will be derived from the source power supply it normally will be powered from and these supply lines will be connected to the LISN. Non-inductive bundling to a 1 m length shortened all interconnecting cables more than 1 m. Sufficient time for the EUT, support equipment, and test equipment was allowed in order for them to warm up to their normal operating condition. The RF output of the LISN was connected to the EMI Test Receiver to determine the frequency producing the maximum emission from the EUT. The frequency producing the maximum level was reexamined using to set Quasi-Peak mode by manual, after scanned by automatic Peak mode from 0.15 MHz to 30 MHz. The bandwidth of the spectrum analyzer was set to 9 kHz. The EUT, support equipment, and interconnecting cables were arranged and manipulated to maximize each emission.

Photographs of the worst-case emission can be seen in Photographs of the worst-case emission test setup can be seen in Appendix B.

3.4 FCC Part 15.205 Restricted Bands of Operations

(a) Except as shown in paragraph (d) of this section, only spurious emissions are permitted in any of the frequency bands listed below:

MHz	MHz	MHz	GHz
0.090 - 0.110	16.42 - 16.423	399.9 - 410	4.5 - 5.15
¹ 0.495 - 0.505	16.69475 - 16.69525	608 - 614	5.35 - 5.46
2.1735 - 2.1905	16.80425 - 16.80475	960 - 1240	7.25 - 7.75
4.125 - 4.128	25.5 - 25.67	1300 - 1427	8.025 - 8.5
4.17725 - 4.17775	37.5 - 38.25	1435 - 1626.5	9.0 - 9.2
4.20725 - 4.20775	73 - 74.6	1645.5 - 1646.5	9.3 - 9.5
6.215 - 6.218	74.8 - 75.2	1660 - 1710	10.6 - 12.7
6.26775 - 6.26825	108 - 121.94	1718.8 - 1722.2	13.25 - 13.4
6.31175 - 6.31225	123 - 138	2200 - 2300	14.47 - 14.5
8.291 - 8.294	149.9 - 150.05	2310 - 2390	15.35 - 16.2
8.362 - 8.366	156.52475 - 156.52525	2483.5 - 2500	17.7 - 21.4
8.37625 - 8.38675	156.7 - 156.9	2690 - 2900	22.01 - 23.12
8.41425 - 8.41475	162.0125 - 167.17	3260 - 3267	23.6 - 24.0
12.29 - 12.293	167.72 - 173.2	3332 - 3339	31.2 - 31.8
12.51975 - 12.52025	240 - 285	3345.8 - 3358	36.43 - 36.5
12.57675 - 12.57725	322 - 335.4	3600 - 4400	(²)
13.36 - 13.41			

¹ Until February 1, 1999, this restricted band shall be 0.490-0.510 MHz.

² Above 38.6

(b) Except as provided in paragraphs (d) and (e), the field strength of emissions appearing within these frequency bands shall not exceed the limits shown in Section 15.209. At frequencies equal to or less than 1000 MHz, compliance with the limits in Section 15.209 shall be demonstrated using measurement instrumentation employing a CISPR quasi-peak detector. Above 1000 MHz, compliance with the emission limits in Section 15.209 shall be demonstrated based on the average value of the measured emissions. The provisions in Section 15.35 apply to these measurements.

4. TEST CONDITION

4.1 Test Configuration

The device was configured for testing in a typical fashion (as a customer would normally use it). During the tests, the following conditions and configurations were used.

4.2 Description of Test modes

High Definition Set top Box that has the control software.

The EUT operated under Tx, Rx and standby mode during all the tests.

With individual verifying, the maximum output power were found at 11 Mbps data rate for 802.11b mode and 54 Mbps data rate for 802.11g mode. The final tests were executed under these conditions recorded in this report individually.

This test used aux ANT which has high gain from in the main ANT and aux ANT .

4.3 The setup drawing(s)

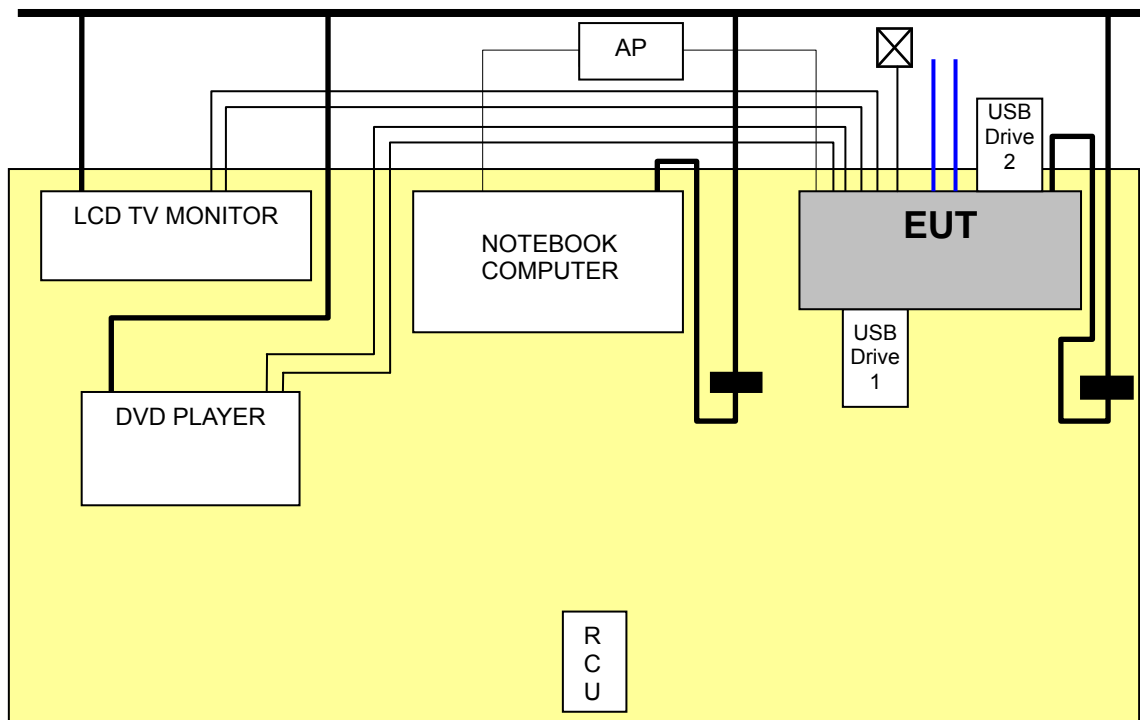

- : Data Line
- : Power Line
- : Adapter
- ⊗ : Termination
- : Satellite Antenna

5. TEST RESULTS

5.1 Summary of Test Results

The measurement results were obtained with the EUT tested in the conditions described in this report. Detailed measurement data and plots showing the maximum emission of the EUT are reported.

Applied Standard : 47 CFR Part 15, Subpart B and C			
FCC Rule	Measurement Required	Limit	Result
15.247(a)(2)	6 dB Bandwidth	> 500 kHz	Pass
15.247(b)(3)	Maximum Peak Output Power	< 1 W	Pass
15.247(d)	Bandwidth of Frequency Band Edges	More than 20 dBc	Pass
15.247(e)	Power Spectral Density	8 dBm	Pass
15.109, 209(a)	Spurious Emissions	Various	Pass
15.107, 207	Conducted Emissions	Various	Pass
15.111	Antenna Power Conduction Measurement	50 dB μ V	Pass
15.247(i) 1.1307(b)(1)	RF Exposure	< 20 cm	Pass

The data collected shows that the **OpenSat Lda. / High Definition Set top Box / Azbox Premium HD+** complied with technical requirements of above rules part 15.107, 109, 111, 209 and 15.247 Limits.

The equipment is not modified anything, mechanical or circuits to improve EMI status during a measurement. No EMI suppression device(s) was added and/or modified during testing.

5.2 6 dB Bandwidth

EUT	High Definition Set top Box / Azbox Premium HD+
Limit apply to	FCC Part 15.247(a)(2)
Test Date	September 04, 2009
Operating Condition	RF transmitting continuously during the tested.
Result	Passed

Limit

The maximum 6 dB bandwidth shall be at least 500 kHz

Test Data

Mode	Frequency(MHz)	6 dB Bandwidth (MHz)	Limit
802.11b	2 412	12.10	> 500 kHz
	2 437	12.10	
	2 462	12.10	
802.11g	2 412	16.55	
	2 437	16.55	
	2 462	16.55	

NOTES:

1. Measure frequency separation of relevant channel using spectrum analyzer.
2. RBW 100 kHz, VBW 100 kHz, span 50 MHz, Sweep time Auto.
3. Please see the measured plot in next page.



Test Engineer : Hoon Pyo, Lee

Plots of 6 dB Bandwidth

- 802.11b Mode

[2 412MHz]

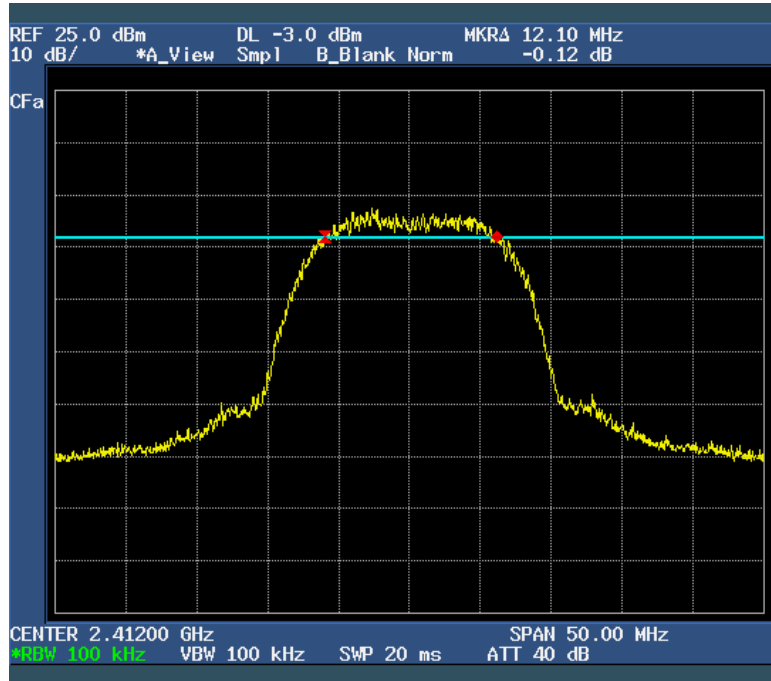

[2 437 MHz]

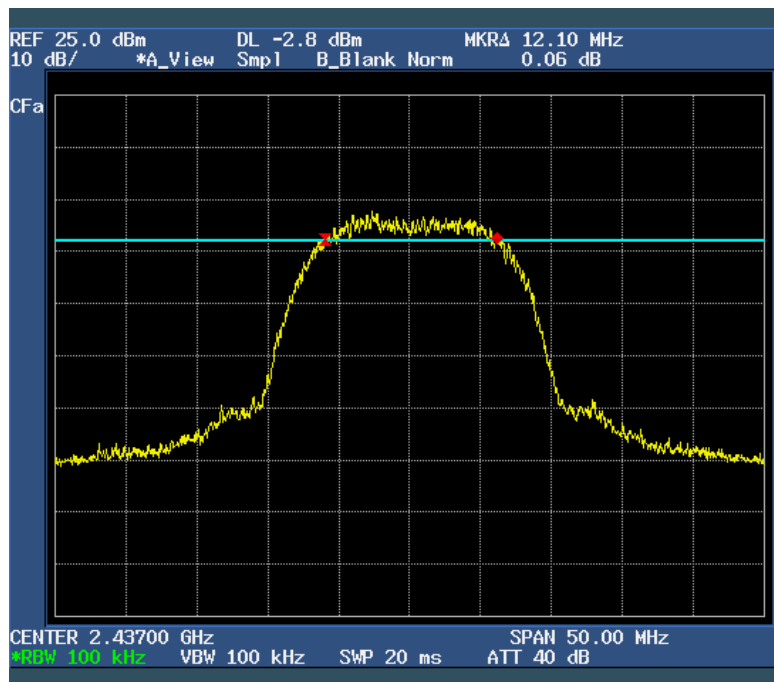

[2 462 MHz]

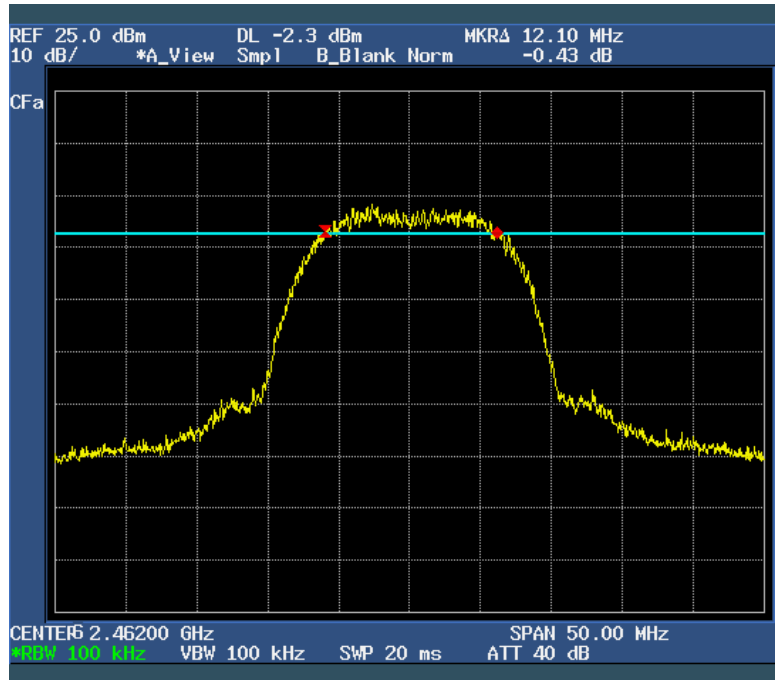

- 802.11g Mode

[2 412 MHz]

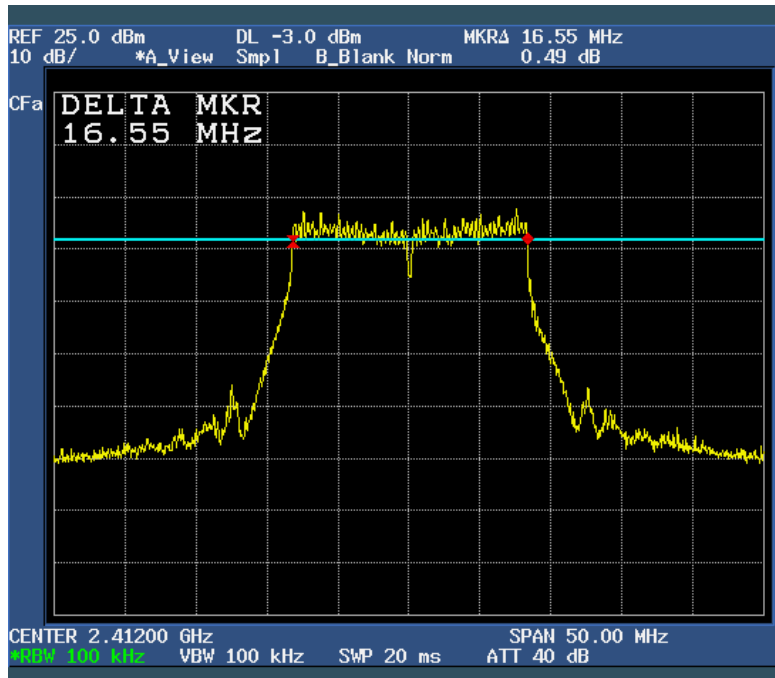

[2 437 MHz]

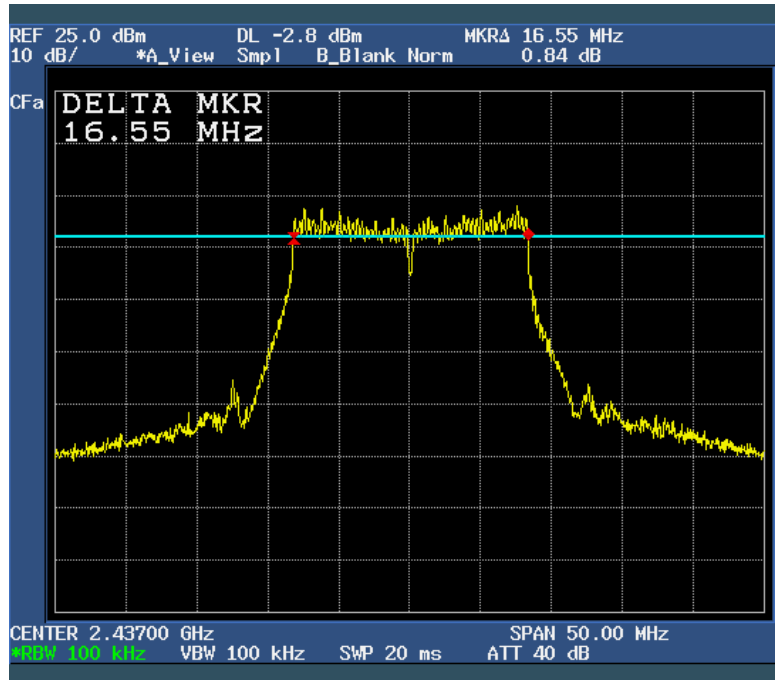

[2 462 MHz]

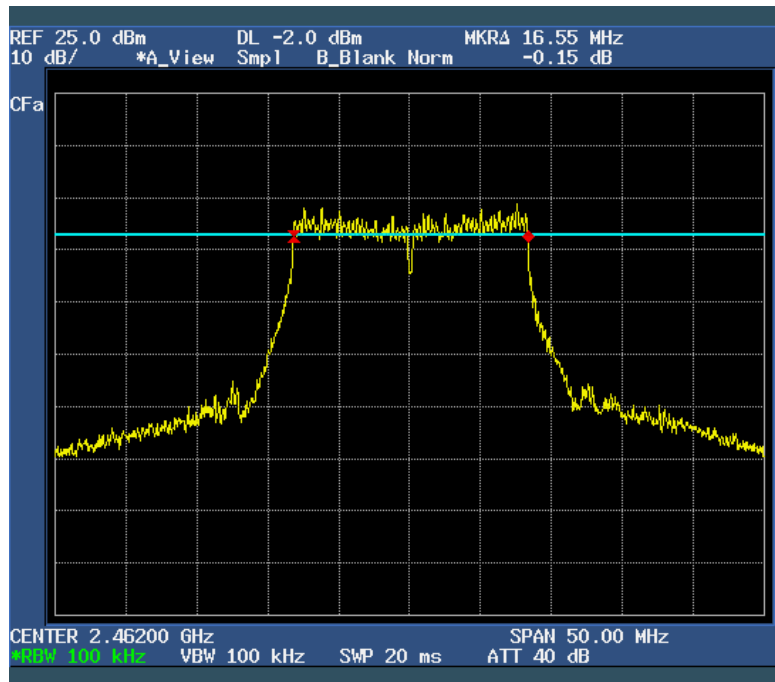

5.3 Maximum peak conducted output power

EUT	High Definition Set top Box / Azbox Premium HD+
Limit apply to	FCC Part 15.247(b)(3)
Test Date	September 04, 2009
Operating Condition	RF transmitting continuously during the tested.
Result	Passed

Limit

The maximum peak conducted output power of the intentional radiator shall not exceed the following:

- For systems using digital modulation operating in the 2 400-2 483.5 MHz band: 1 watt

Test Data

Mode	Frequency(MHz)	Output Power (dBm)	Limit
802.11b	2 412	17.78	< 30 dBm(1W)
	2 437	18.96	
	2 462	19.47	
802.11g	2 412	17.30	
	2 437	17.48	
	2 462	17.82	

NOTES:

1. Measure conducted Channel power of relevant channel using Spectrum analyzer
2. RBW 1MHz, VBW 1MHz



Test Engineer : Hoon Pyo, Lee

Plots of Maximum Peak Output Power

- 802.11b mode

[2 412 MHz]

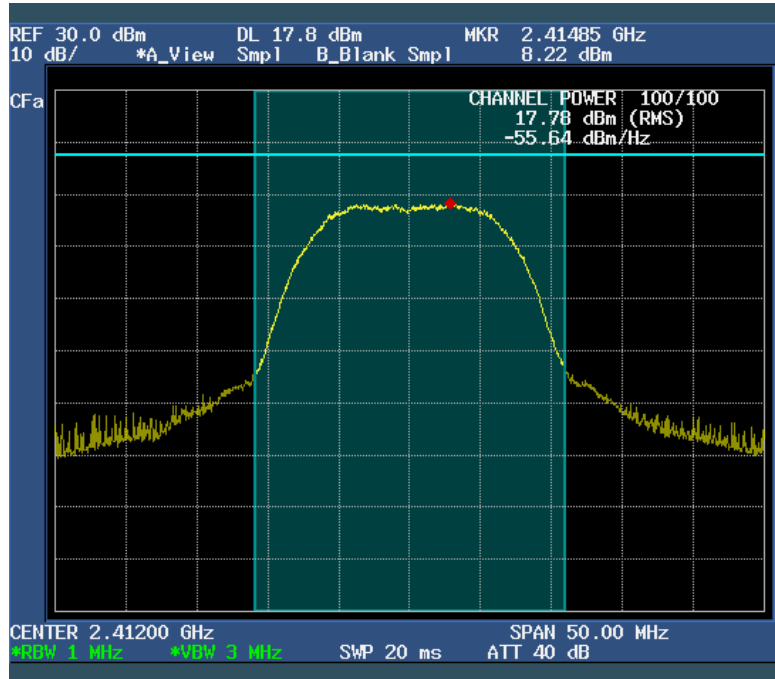

[2 437 MHz]

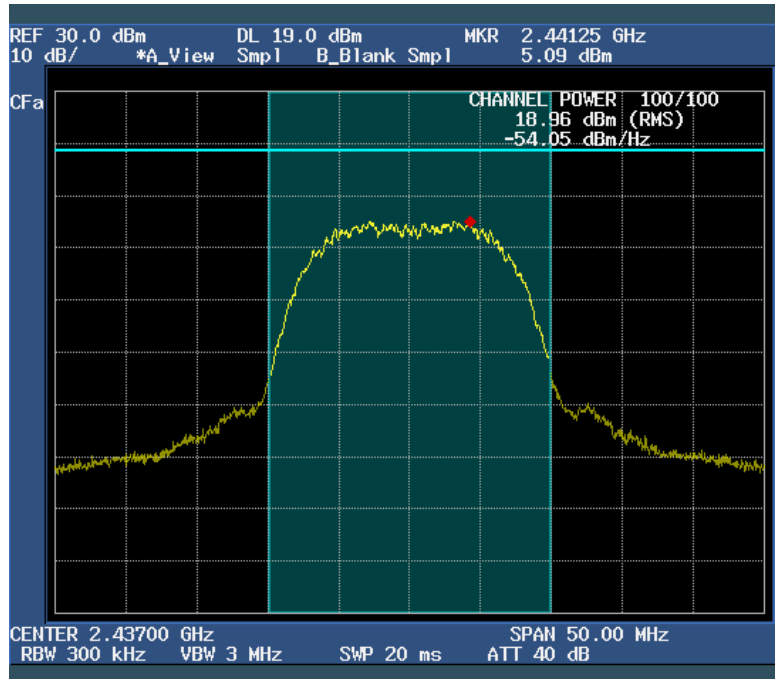

[2 462 MHz]

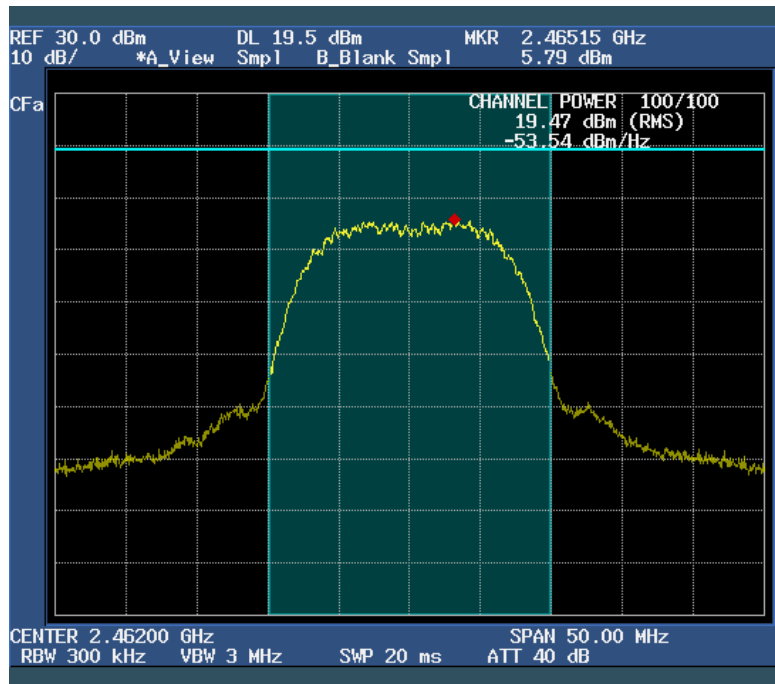

- 802.11g mode

[2 412 MHz]

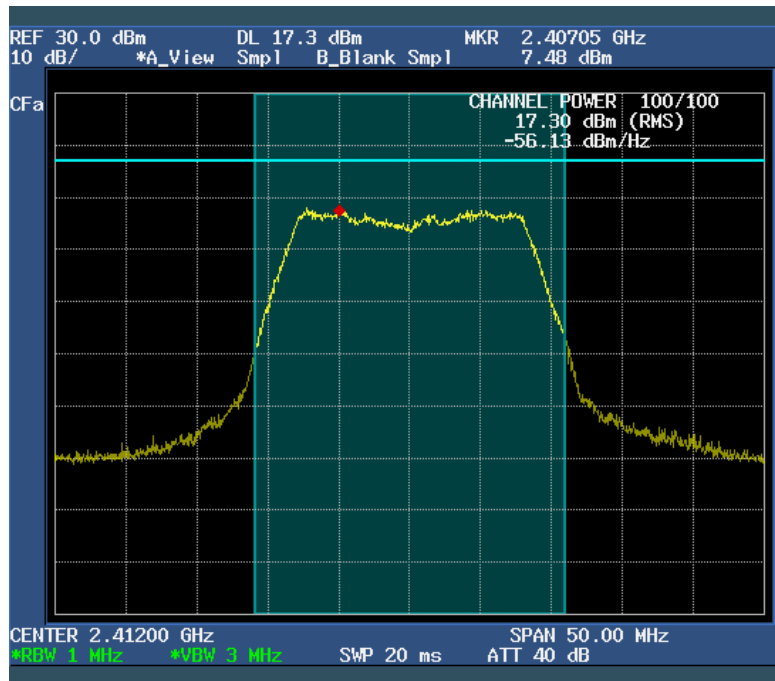

[2 437 MHz]

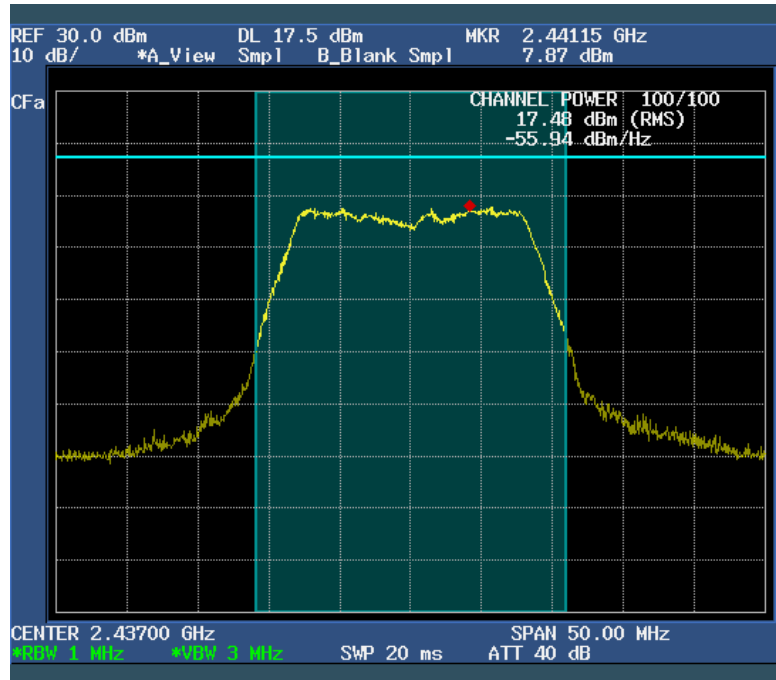

[2 462 MHz]

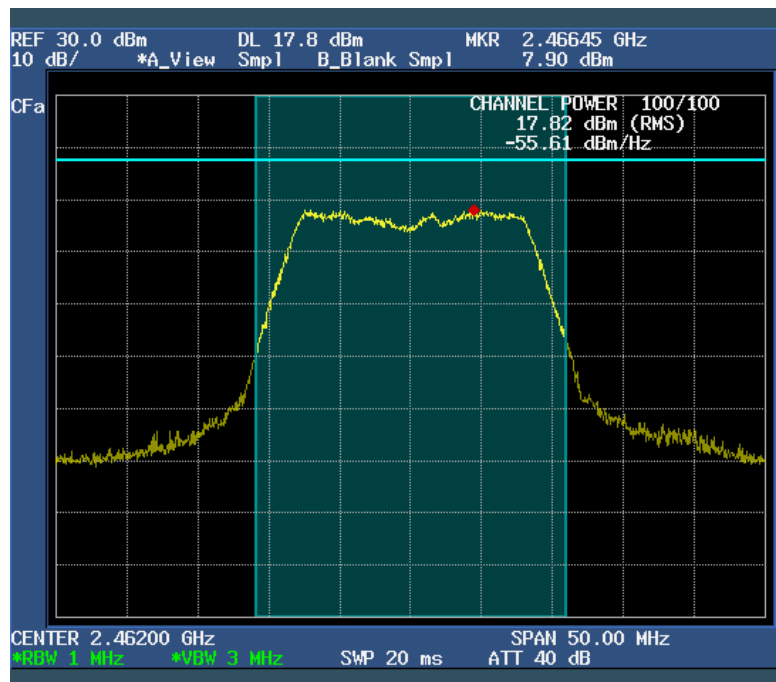

5.4 Bandwidth of Frequency Band Edges

EUT	High Definition Set top Box / Azbox Premium HD+
Limit apply to	FCC Part 15.247(d)
Test Date	September 07, 2009
Operating Condition	RF transmitting continuously during the tested.
Result	Passed

Limit

In any 100 kHz bandwidth outside the frequency band in which the spread spectrum or digitally modulated intentional radiator is operating, the radio frequency power that is produced by the intentional radiator shall be at least 20 dB below that in the 100 kHz bandwidth within the band that contains the highest level of the desired power, based on either an RF conducted or a radiated measurement, provided the transmitter demonstrates compliance with the peak conducted power limits. If the transmitter complies with the conducted power limits based on the use of RMS averaging over a time interval, as permitted under paragraph (b)(3) of this section, the attenuation required under this paragraph shall be 30 dB instead of 20 dB. Attenuation below the general limits specified in Section 15.209(a) is not required. In addition, radiated emissions which fall in the restricted bands, as defined in Section 15.205(a), must also comply with the radiated emission limits specified in Section 15.209(a) (see Section 15.205(c)).

Test Results

- Refer to see the measured plot in next page.

NOTES:

1. The test was performed to make a direct field strength measurement at the band edge frequencies.



Test Engineer : Hoon Pyo, Lee

Bandwidth of Frequency Band Edges

- 802.11b mode

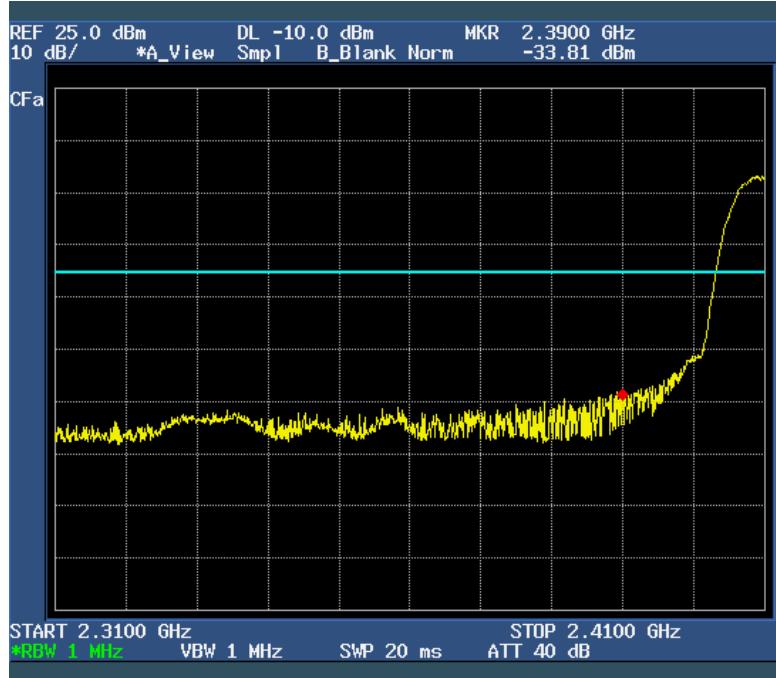

- 802.11g mode

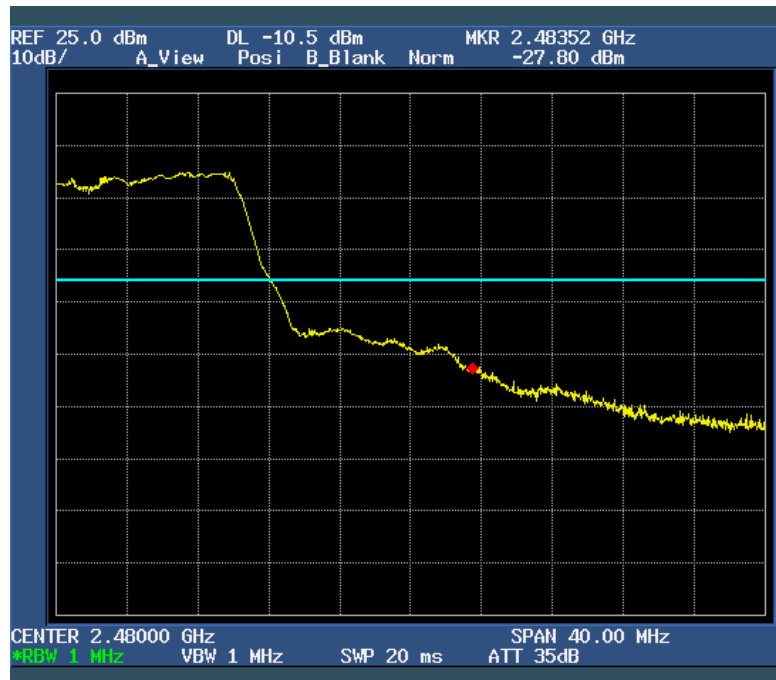
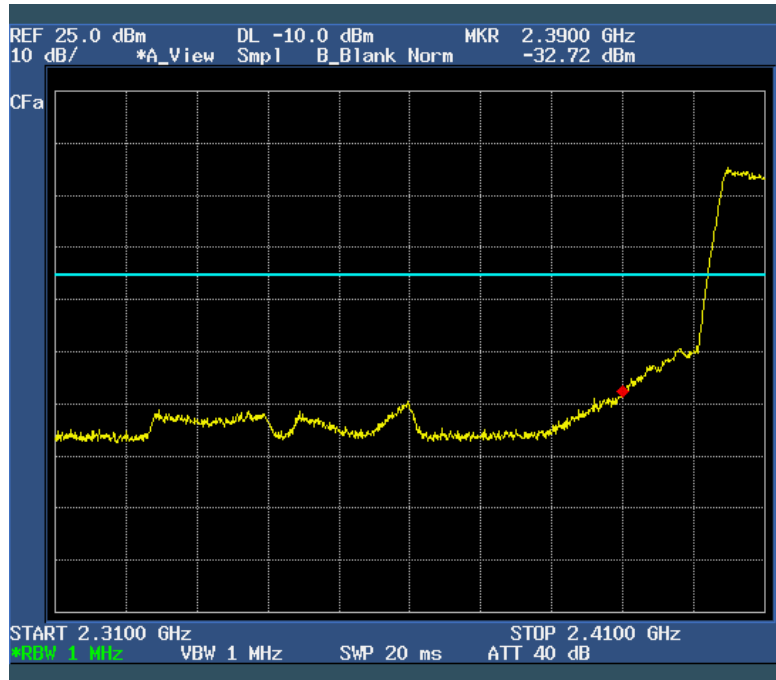

5.5 Power Spectral Density

EUT	High Definition Set top Box / Azbox Premium HD+
Limit apply to	FCC Part 15.247(e)
Test Date	September 07, 2009
Operating Condition	RF transmitting continuously during the tested.
Result	Passed

Limit

For digitally modulated systems, the power spectral density conducted from the intentional radiator to the antenna shall not be greater than 8 dBm in any 3 kHz band during any time interval of continuous transmission. This power spectral density shall be determined in accordance with the provisions of paragraph (b) of this section. The same method of determining the conducted output power shall be used to determine the power spectral density.

Test Data

802.11b mode

Channel	Frequency (MHz)	PSD (dBm)	Limit
Low	2 412	-13.36	8 dBm
Mid	2 437	-13.26	
High	2 462	-12.87	

802.11g mode

Channel	Frequency (MHz)	PSD (dBm)	Limit
Low	2 412	-19.09	8 dBm
Mid	2 437	-18.69	
High	2 462	-17.94	

NOTES:

1. Measure power spectral density of relevant channel using spectrum analyzer.
2. RBW 3 kHz, VBW 3 kHz, span 1 MHz, Sweep time (= span / 3khz).
3. Please see the measured plot in next page.



Test Engineer : Hoon Pyo, Lee

Power Spectral Density

- 802.11b mode

[CH Low]

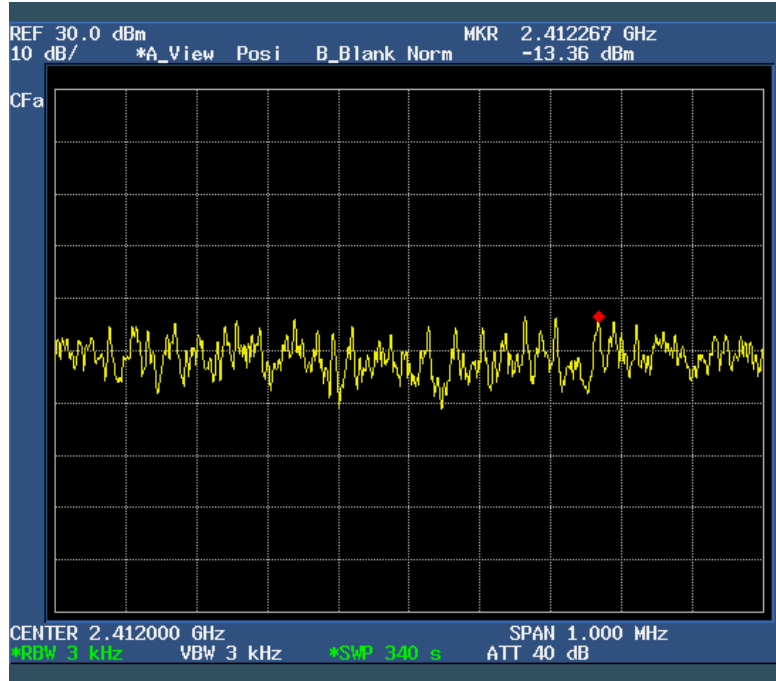

[CH Mid]

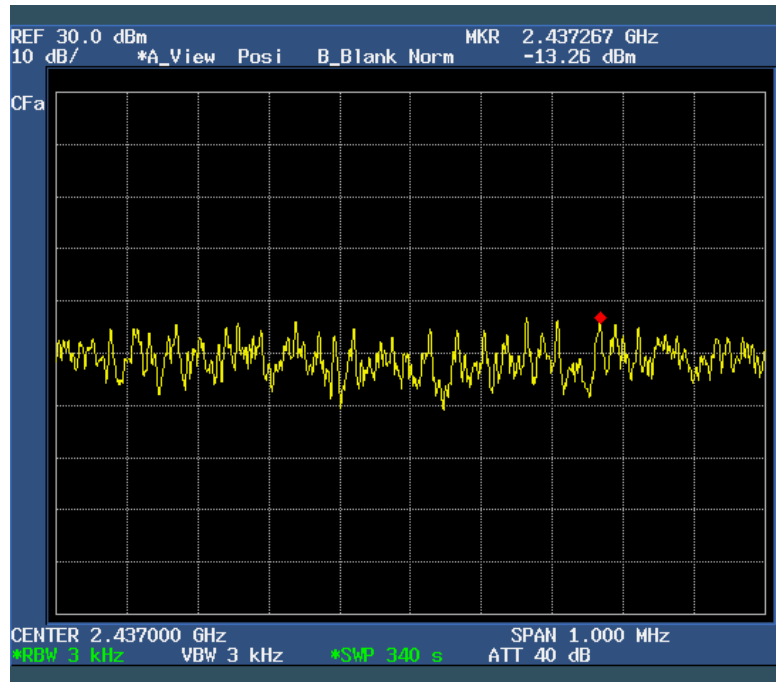

[CH High]

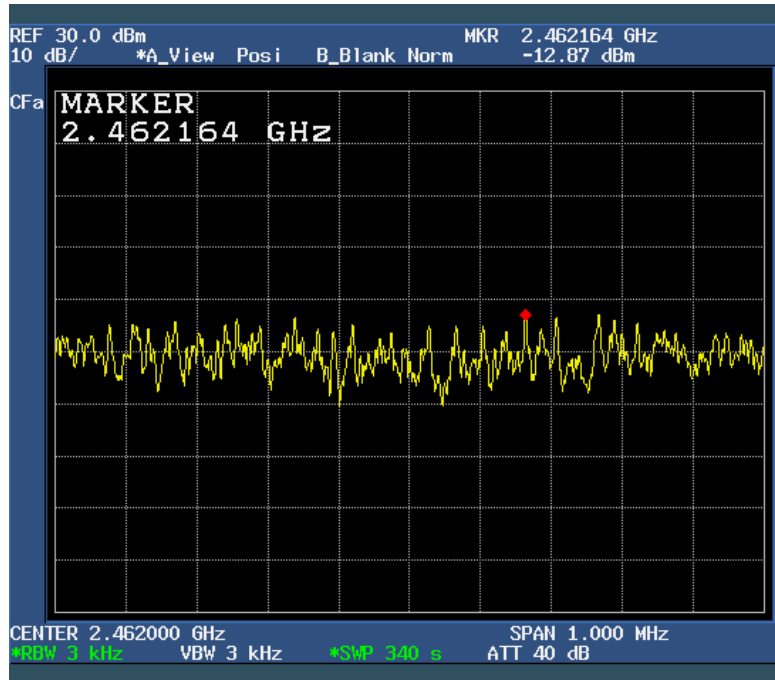

- 802.11g mode

[CH Low]

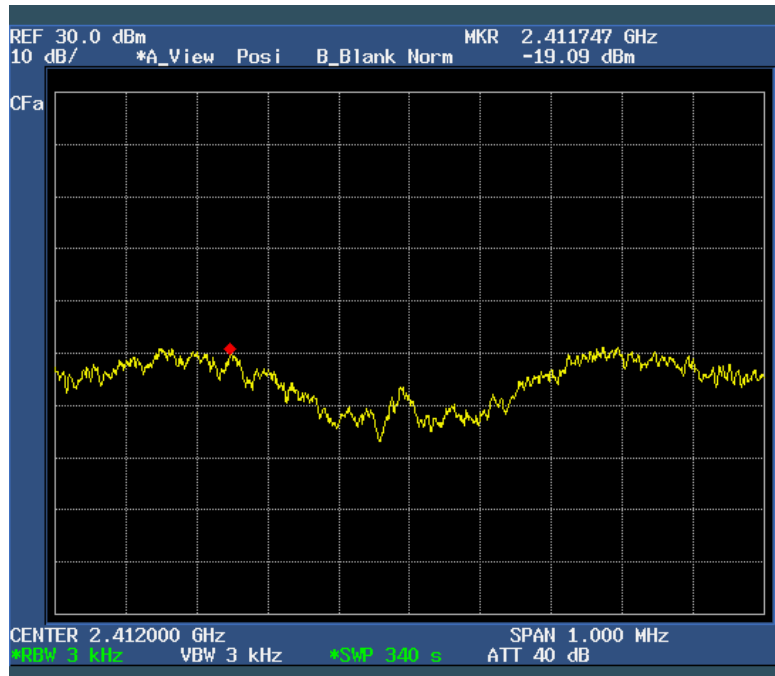

[CH Mid]



[CH High]

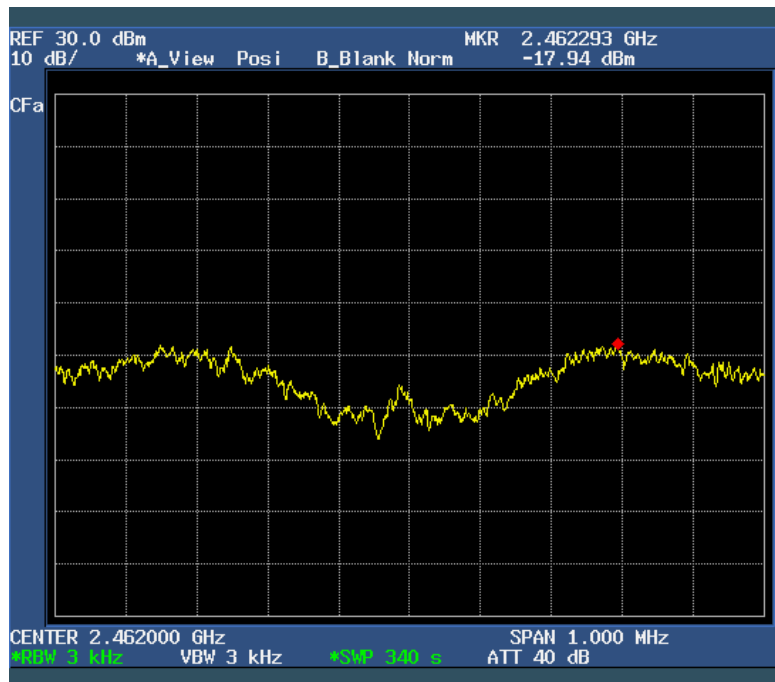

5.6 Spurious Emissions

5.6.1 Radiated Emissions

EUT	High Definition Set top Box / Azbox Premium HD+
Limit apply to	FCC Part 15.109, 209
Test Date	September 08, 2009
Operating Condition	Low CH, Middle CH, High CH Transmission
Result	Passed

Limit

Except as provided elsewhere in this Subpart, the emissions from an intentional radiator shall not exceed the field strength levels specified in the following table:

Frequencies (MHz)	Field Strength (uV/m)	Field Strength (dBuV/m)	Measurement Distance (m)
30 – 88	100*	40	3
88 – 216	150*	43.5	3
216 – 960	200*	46	3
Above 960	500	54	3

* Except as provided in paragraph (g), fundamental emissions from intentional radiators operating under this Section shall not be located in the frequency bands 54-72 MHz, 76-88 MHz, 174-216 MHz or 470-806 MHz. However, operation within these frequency bands is permitted under other sections of this Part, e.g., Sections 15.231 and 15.241.

Test Results

- Refer to see the measured plot in next page.



Test Engineer : Hoon Pyo, Lee

Radiated Emissions Test data

Below 1 GHz

The following table shows the highest levels of radiated emissions on both polarizations of horizontal and vertical.
Detector mode: CISPR Quasi – Peak mode (6 dB Bandwidth: 120 kHz)

802.11b test mode

Frequency [MHz]	Reading [dB μ V]	Polarization (*H/**V)	Ant. Factor [dB/m]	Cable Loss [dB]	Result [dB μ V/m]	Limit [dB μ V/m]	Margin [dB]
47.63	20.42	V	12.17	1.61	34.20	40.00	5.80
79.68	24.25	V	8.41	2.04	34.70	40.00	5.30
167.87	17.58	V	11.99	3.23	32.80	43.50	10.70
216.02	18.89	V	9.63	3.88	32.40	46.00	13.60
250.02	26.26	H	10.94	4.10	41.30	46.00	4.70
400.21	20.26	H	14.55	5.29	40.10	46.00	5.90
466.68	20.12	H	16.30	5.88	42.30	46.00	3.70

802.11g test mode

Frequency [MHz]	Reading [dB μ V]	Polarization (*H/**V)	Ant. Factor [dB/m]	Cable Loss [dB]	Result [dB μ V/m]	Limit [dB μ V/m]	Margin [dB]
47.63	21.32	V	12.17	1.61	35.10	40.00	4.90
120.01	22.42	V	11.22	2.56	36.20	43.50	7.30
167.87	17.38	V	11.99	3.23	32.60	43.50	10.90
250.01	26.06	H	10.94	4.10	41.10	46.00	4.90
466.68	20.12	H	16.30	5.88	42.30	46.00	3.70
501.31	19.11	H	16.67	6.02	41.80	46.00	4.20

NOTES:

1. * H : Horizontal polarization , ** V : Vertical polarization
2. Result = Reading + Antenna factor + Cable loss
3. Margin value = Limit - Result
4. The measurement was performed for the frequency range above 30 MHz according to FCC Part 15.209.

802.11b test mode

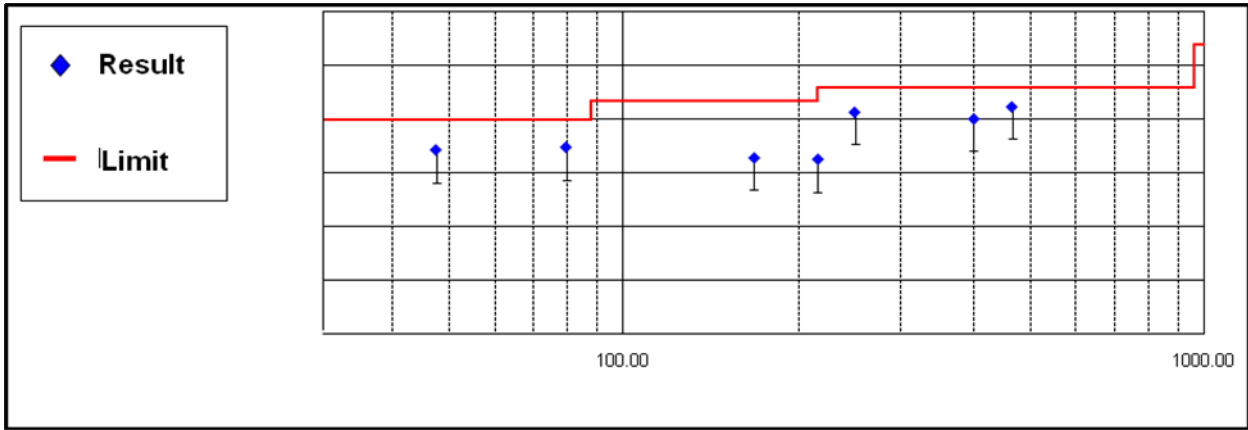

802.11g test mode

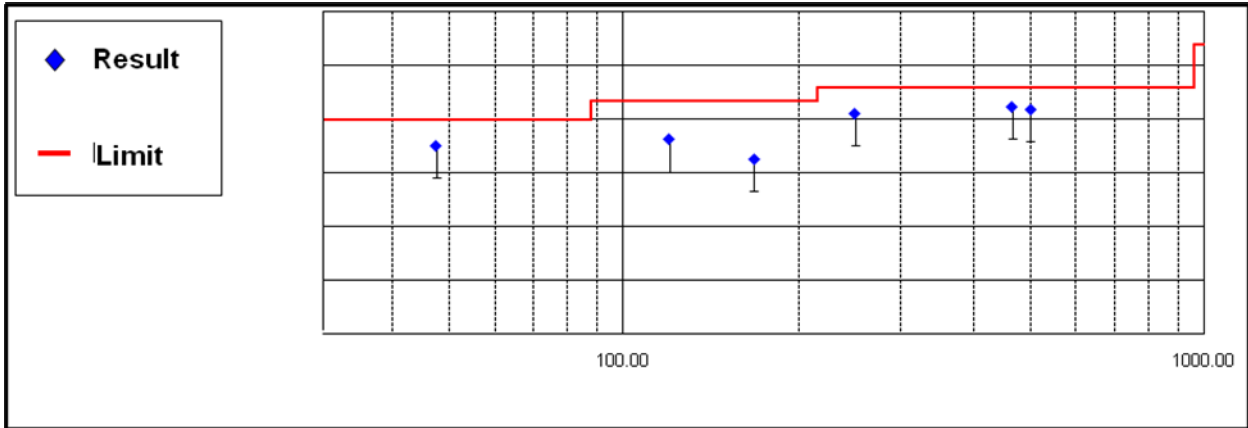

Above 1 GHz

- Operating mode: TX / CH: Low, Mid, High

The following table shows the highest levels of radiated emissions on both polarizations of horizontal and vertical.

— Peak Limit Line
— AV Limit Line

802.11b

Final data Peak

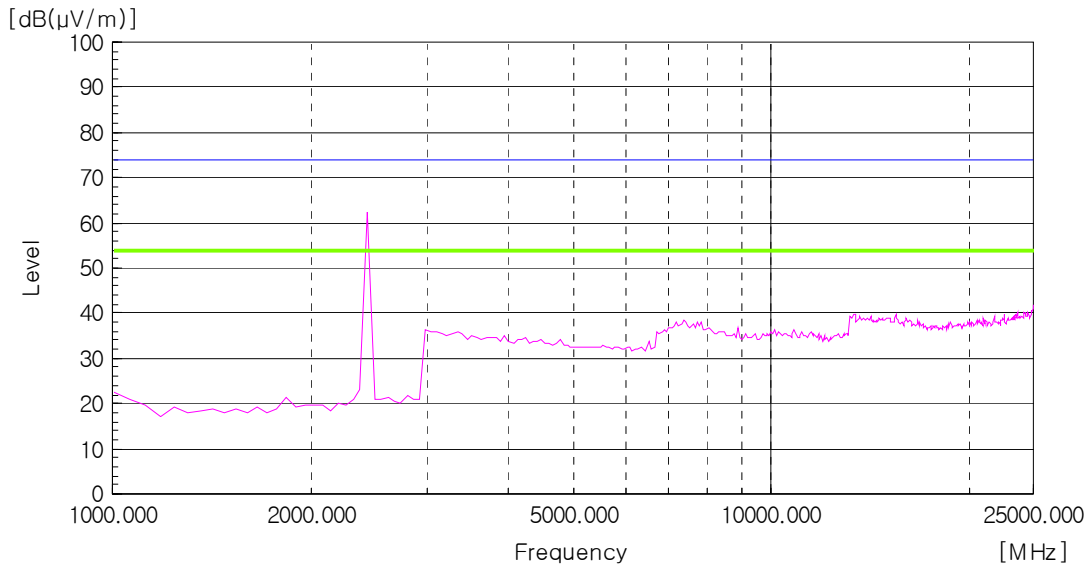

Final data AV

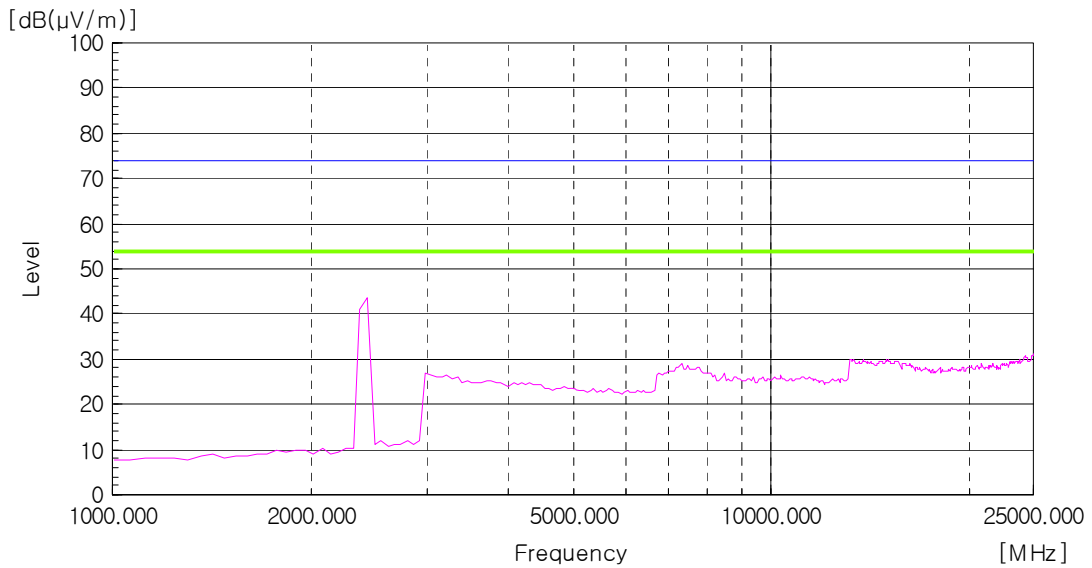

802.11g

Final data Peak

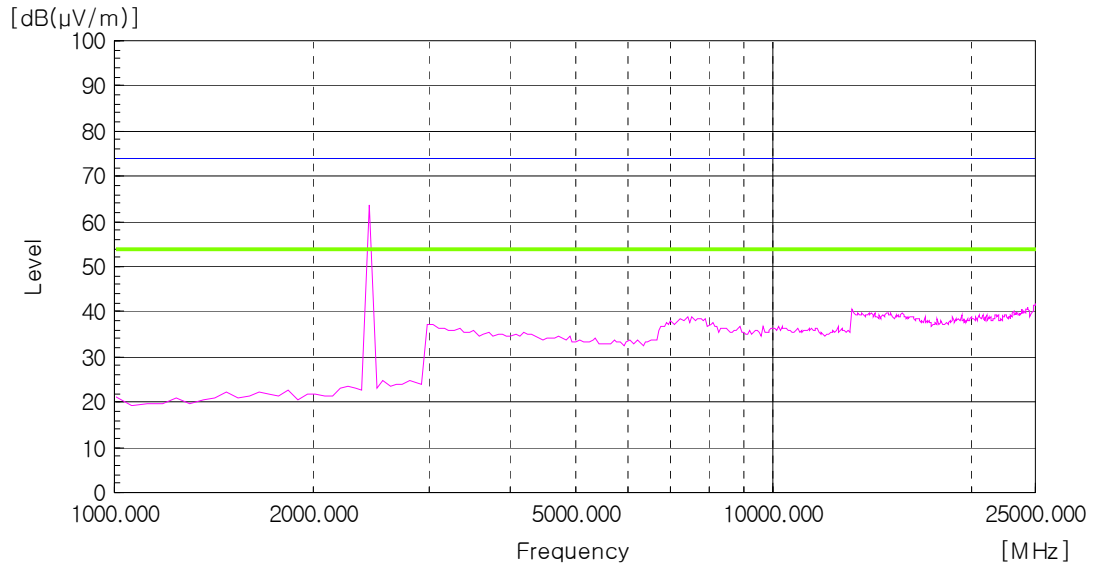

Final data AV

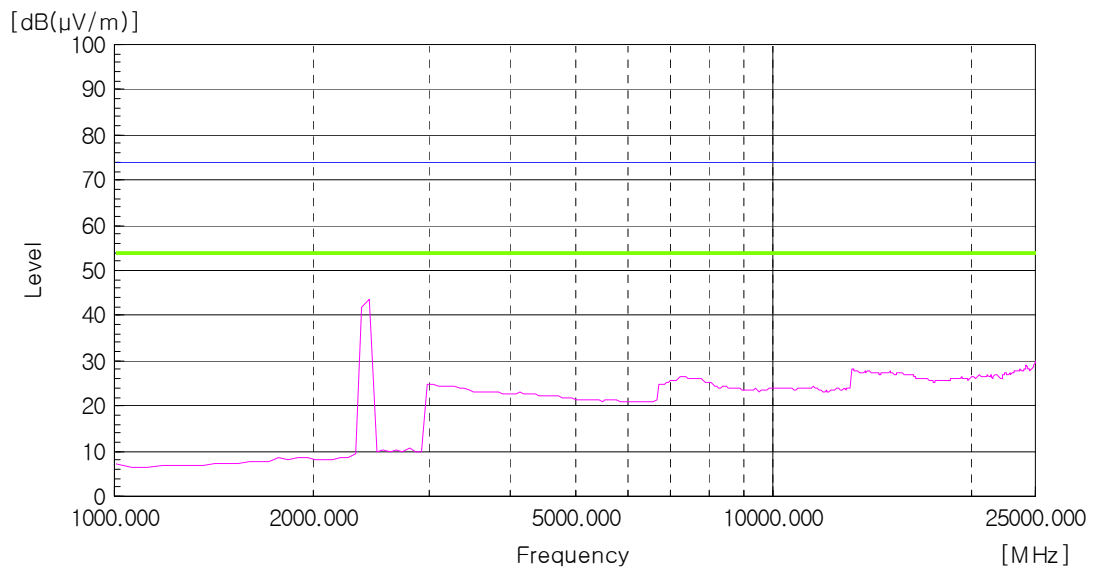

802.11b

1. Low CH

Detector mode: Peak mode

Frequency [MHz]	Reading [dB μ V]	Polarization (*H/**V)	Ant. Factor [dB/m]	Cable Loss [dB μ V]	Result [dB μ V/m]	Limit [dB μ V/m]	Margin [dB]
-	-	-	-	-	-	-	-
-	-	-	-	-	-	-	-

Detector mode: Average mode

Frequency [MHz]	Reading [dB μ V]	Polarization (*H/**V)	Ant. Factor [dB/m]	Cable Loss [dB μ V]	Result [dB μ V/m]	Limit [dB μ V/m]	Margin [dB]
-	-	-	-	-	-	-	-
-	-	-	-	-	-	-	-

2. Middle CH

Detector mode: Peak mode

Frequency [MHz]	Reading [dB μ V]	Polarization (*H/**V)	Ant. Factor [dB/m]	Cable Loss [dB μ V]	Result [dB μ V/m]	Limit [dB μ V/m]	Margin [dB]
-	-	-	-	-	-	-	-
-	-	-	-	-	-	-	-

Detector mode: Average mode

Frequency [MHz]	Reading [dB μ V]	Polarization (*H/**V)	Ant. Factor [dB/m]	Cable Loss [dB μ V]	Result [dB μ V/m]	Limit [dB μ V/m]	Margin [dB]
-	-	-	-	-	-	-	-
-	-	-	-	-	-	-	-

3. High CH

Detector mode: Peak mode

Frequency [MHz]	Reading [dB μ V]	Polarization (*H/**V)	Ant. Factor [dB/m]	Cable Loss [dB μ V]	Result [dB μ V/m]	Limit [dB μ V/m]	Margin [dB]
-	-	-	-	-	-	-	-
-	-	-	-	-	-	-	-

Detector mode: Average mode

Frequency [MHz]	Reading [dB μ V]	Polarization (*H/**V)	Ant. Factor [dB/m]	Cable Loss [dB μ V]	Result [dB μ V/m]	Limit [dB μ V/m]	Margin [dB]
-	-	-	-	-	-	-	-
-	-	-	-	-	-	-	-

802.11g

1. Low CH

Detector mode: Peak mode

Frequency [MHz]	Reading [dB μ V]	Polarization (*H/**V)	Ant. Factor [dB/m]	Cable Loss [dB μ V]	Result [dB μ V/m]	Limit [dB μ V/m]	Margin [dB]
-	-	-	-	-	-	-	-
-	-	-	-	-	-	-	-

Detector mode: Average mode

Frequency [MHz]	Reading [dB μ V]	Polarization (*H/**V)	Ant. Factor [dB/m]	Cable Loss [dB μ V]	Result [dB μ V/m]	Limit [dB μ V/m]	Margin [dB]
-	-	-	-	-	-	-	-
-	-	-	-	-	-	-	-

2. Middle CH

Detector mode: Peak mode

Frequency [MHz]	Reading [dB μ V]	Polarization (*H/**V)	Ant. Factor [dB/m]	Cable Loss [dB μ V]	Result [dB μ V/m]	Limit [dB μ V/m]	Margin [dB]
-	-	-	-	-	-	-	-
-	-	-	-	-	-	-	-

Detector mode: Average mode

Frequency [MHz]	Reading [dB μ V]	Polarization (*H/**V)	Ant. Factor [dB/m]	Cable Loss [dB μ V]	Result [dB μ V/m]	Limit [dB μ V/m]	Margin [dB]
-	-	-	-	-	-	-	-
-	-	-	-	-	-	-	-

3. High CH

Detector mode: Peak mode

Frequency [MHz]	Reading [dB μ V]	Polarization (*H/**V)	Ant. Factor [dB/m]	Cable Loss [dB μ V]	Result [dB μ V/m]	Limit [dB μ V/m]	Margin [dB]
-	-	-	-	-	-	-	-
-	-	-	-	-	-	-	-

Detector mode: Average mode

Frequency [MHz]	Reading [dB μ V]	Polarization (*H/**V)	Ant. Factor [dB/m]	Cable Loss [dB μ V]	Result [dB μ V/m]	Limit [dB μ V/m]	Margin [dB]
-	-	-	-	-	-	-	-
-	-	-	-	-	-	-	-

Result: All emissions below noise floor of 20 dB μ V/m

NOTES :

1. * H : Horizontal polarization , ** V : Vertical polarization
2. Result = Reading + Antenna factor + Cable loss
3. Margin value = Limit - Result
4. Measuring frequencies from 1GHz to the 10th harmonic of highest fundamental frequency.
5. Measurements above show only up to 6 maximum emissions noted, or would be lesser if no specific emissions from the EUT are recorded(ie: margin > 20 dB from the applicable limit) and considered that's already beyond the background noise floor.
6. Spectrum setting:
 - a. Peak Setting 1 GHz to 10th harmonics of fundamental, RBW = 1 MHz, VBW = 1 MHz, Sweep = Auto
 - b. AV Setting 1 GHz to 10th harmonics of fundamental, RBW = 1 MHz, VBW = 10 Hz, Sweep = Auto

Spurious Emissions (Conducted Measurement)

- 802.11b

[CH Low]

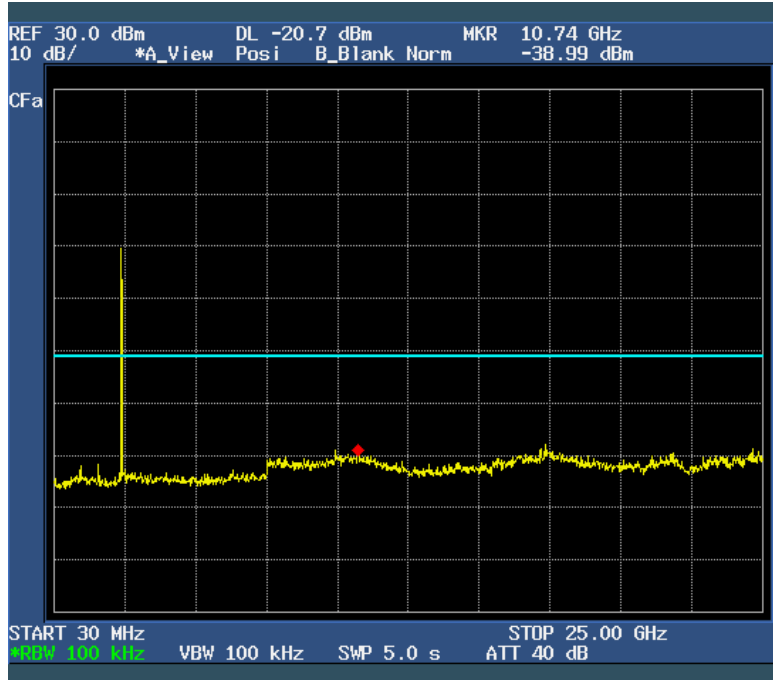

[CH Mid]

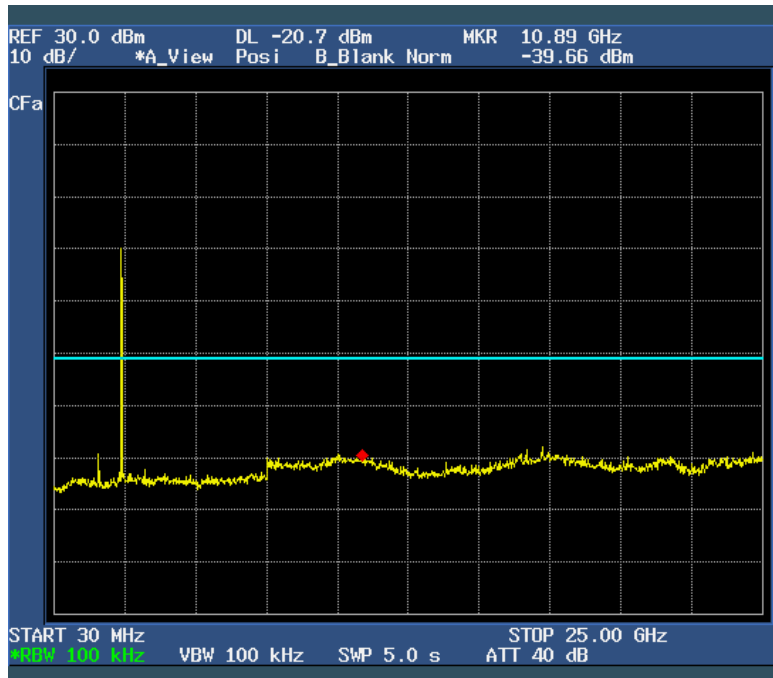

[CH High]

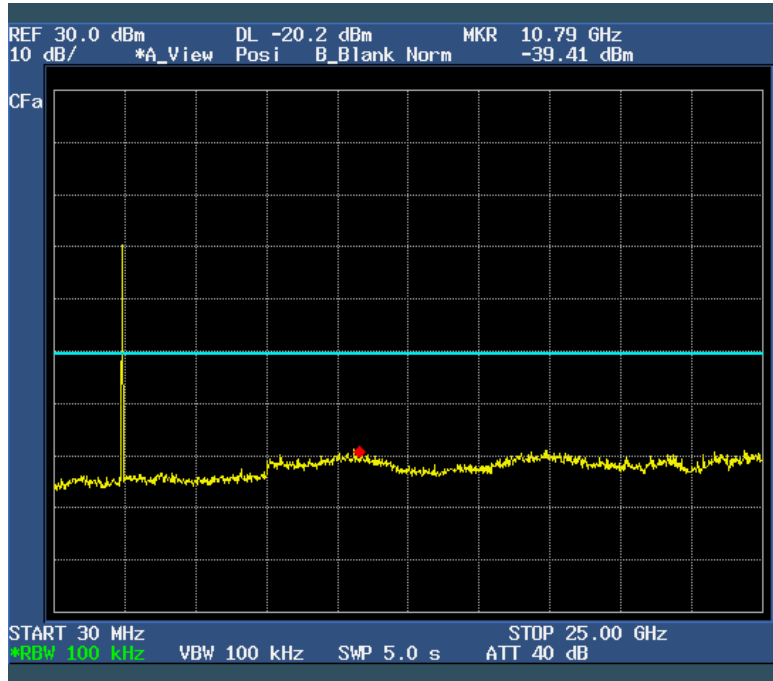

- 802.11g

[CH Low]

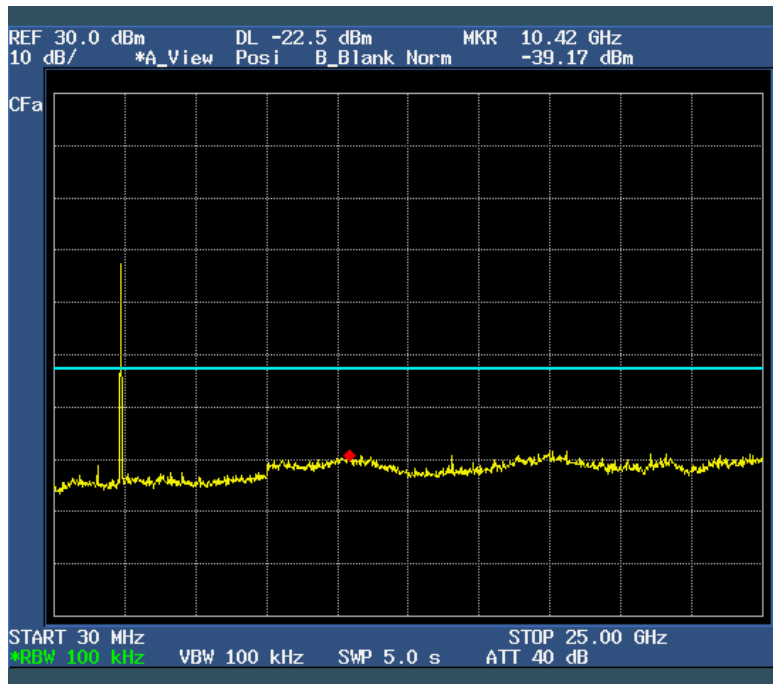

[CH Mid]

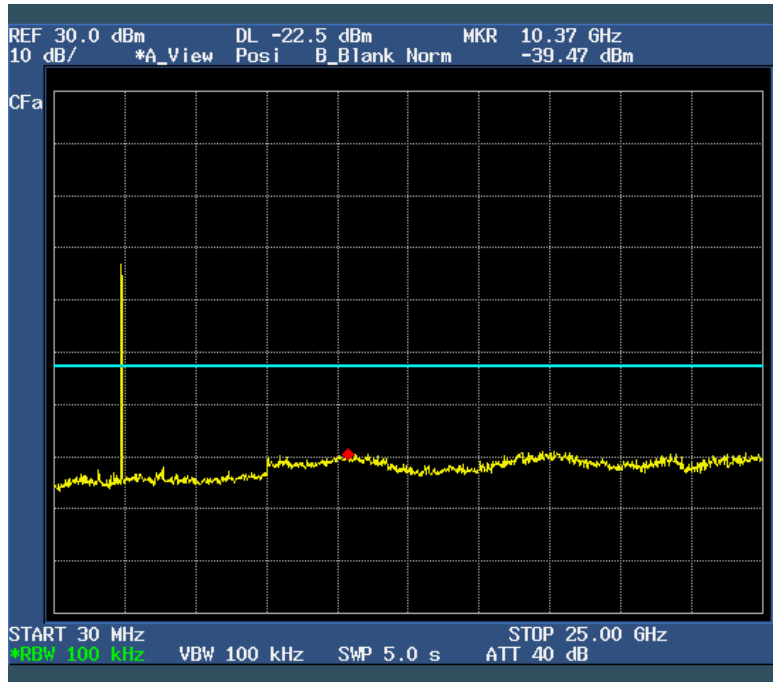

[CH High]

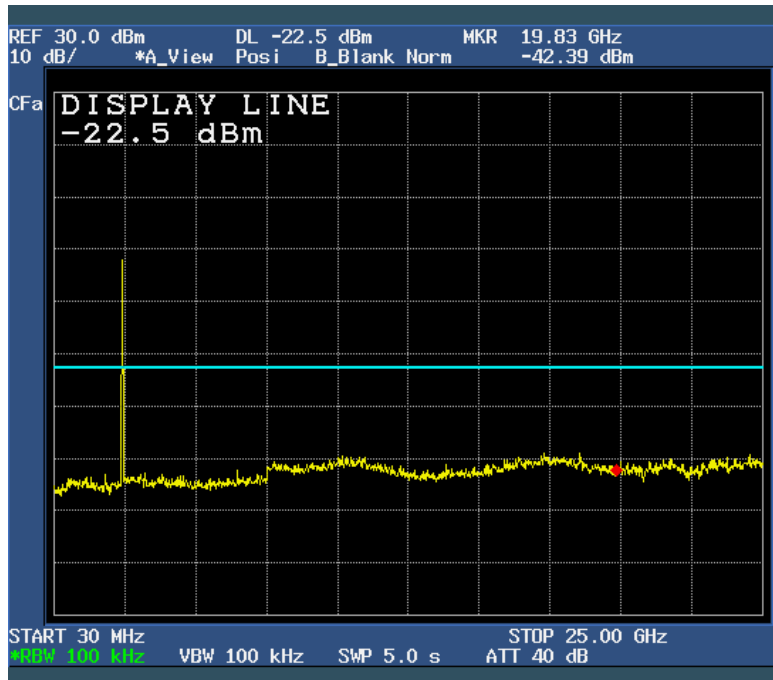

5.7 Conducted Emissions Measurement

EUT	High Definition Set top Box / Azbox Premium HD+
Limit apply to	FCC Part 15.107, 207
Test Date	September 09, 2009
Operating Condition	RF transmitting continuously during the tested.
Result	Passed

5.7.1 Conducted Emission Test Data

The following table shows the highest levels of conducted emissions on both polarizations of hot and neutral line.

Detector mode: CISPR Quasi-Peak mode (6 dB Bandwidth: 9 kHz)

802.11b

Frequency [MHz]	Result [dB μ V]		Phase (*L/**N)	Limit [dB μ V]		Margin [dB]	
	Quasi-peak	Average		Quasi-peak	Average	Quasi-peak	Average
0.482	52.90	42.80	H	56.30	46.30	3.40	3.50
0.571	52.60	42.80	N	56.00	46.00	3.40	3.20
1.251	51.10	39.60	H	56.00	46.00	4.90	6.40
1.993	50.30	36.60	H	56.00	46.00	5.70	9.40
3.033	50.60	37.40	H	56.00	46.00	5.40	8.60
3.891	49.20	36.60	H	56.00	46.00	6.80	9.40
4.454	46.30	35.30	N	56.00	46.00	9.70	10.70

NOTES:

1. * H : HOT Line , **N : Neutral Line
2. Margin value = Limit – Result
3. Measurement were performed at the AC Power Inlet in the frequency band of 150 kHz ~ 30 MHz according to the FCC Part 15 Class B.

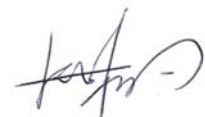

Test Engineer: Hoon Pyo, Lee

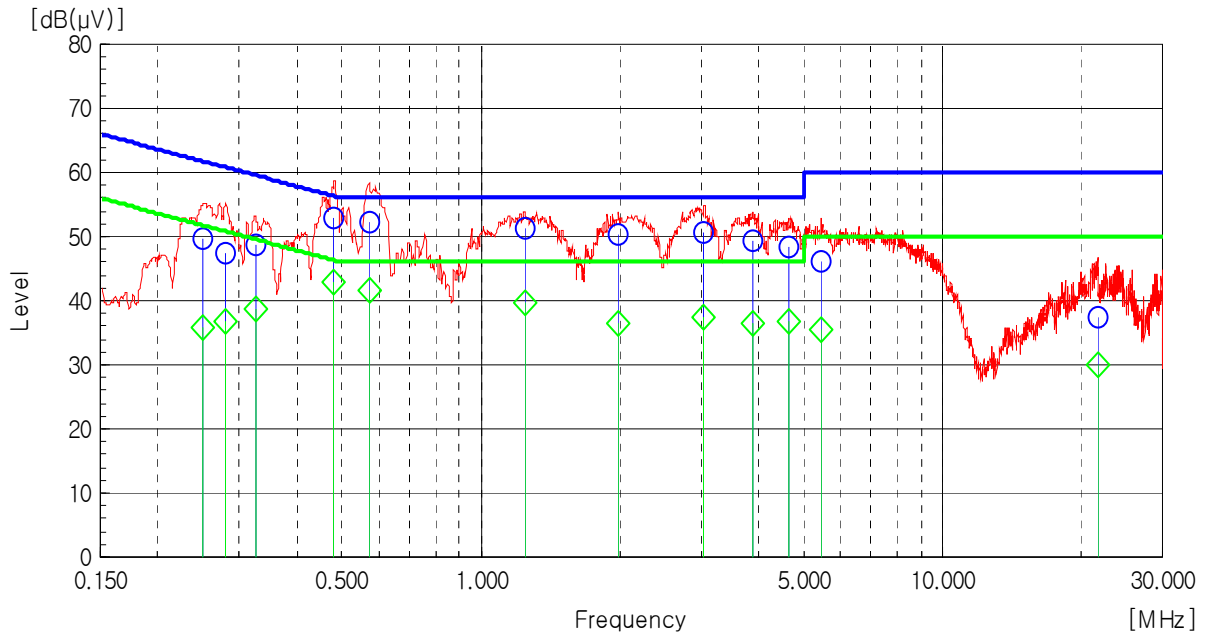
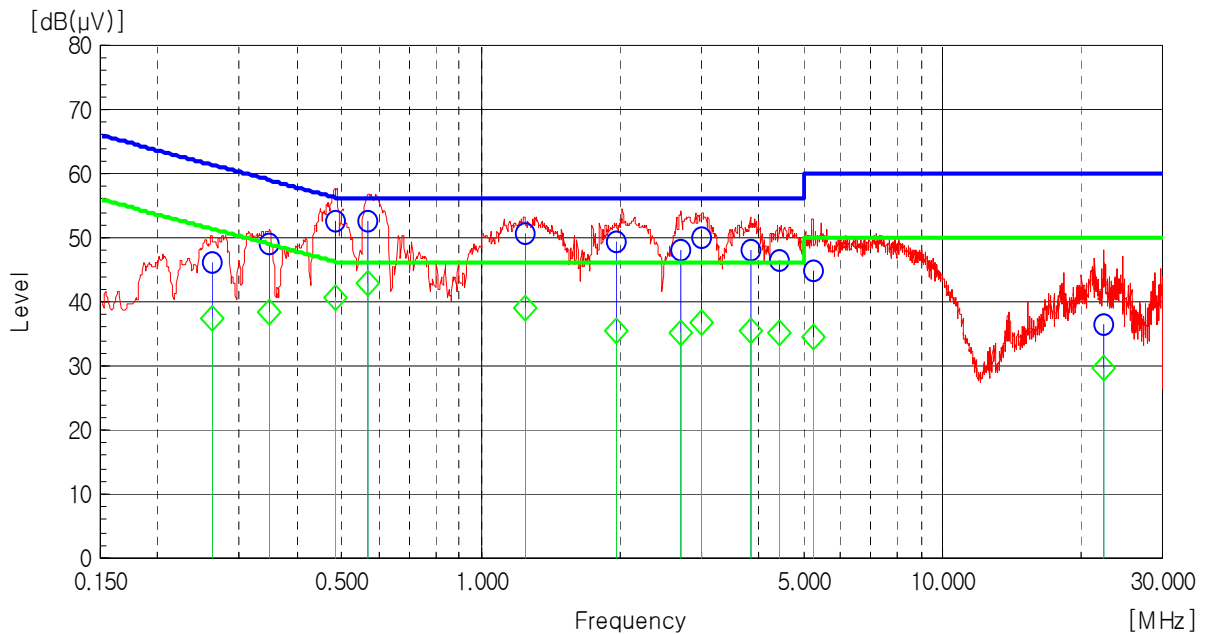
Line: HOT LineLimit : — Quasi-Peak
— Average**Line: Neutral Line**

Quasi-peak Average

802.11g

Frequency [MHz]	Result [dB μ V]		Phase (*L/**N)	Limit [dB μ V]		Margin [dB]	
	Quasi-peak	Average		Quasi-peak	Average	Quasi-peak	Average
0.485	52.50	42.80	H	56.20	46.20	3.70	3.40
0.569	52.80	42.70	H	56.00	46.00	3.20	3.30
1.353	50.80	36.20	H	56.00	46.00	5.20	9.80
1.982	50.50	36.50	H	56.00	46.00	5.50	9.50
2.863	50.80	38.30	H	56.00	46.00	5.20	7.70
3.852	49.10	36.00	H	56.00	46.00	6.90	10.00
4.544	47.70	36.40	H	56.00	46.00	8.30	9.60

NOTES:

1. * H : HOT Line , **N : Neutral Line
2. Margin value = Limit – Result
3. Measurement were performed at the AC Power Inlet in the frequency band of 150 kHz ~ 30 MHz according to the FCC Part 15 Class B.

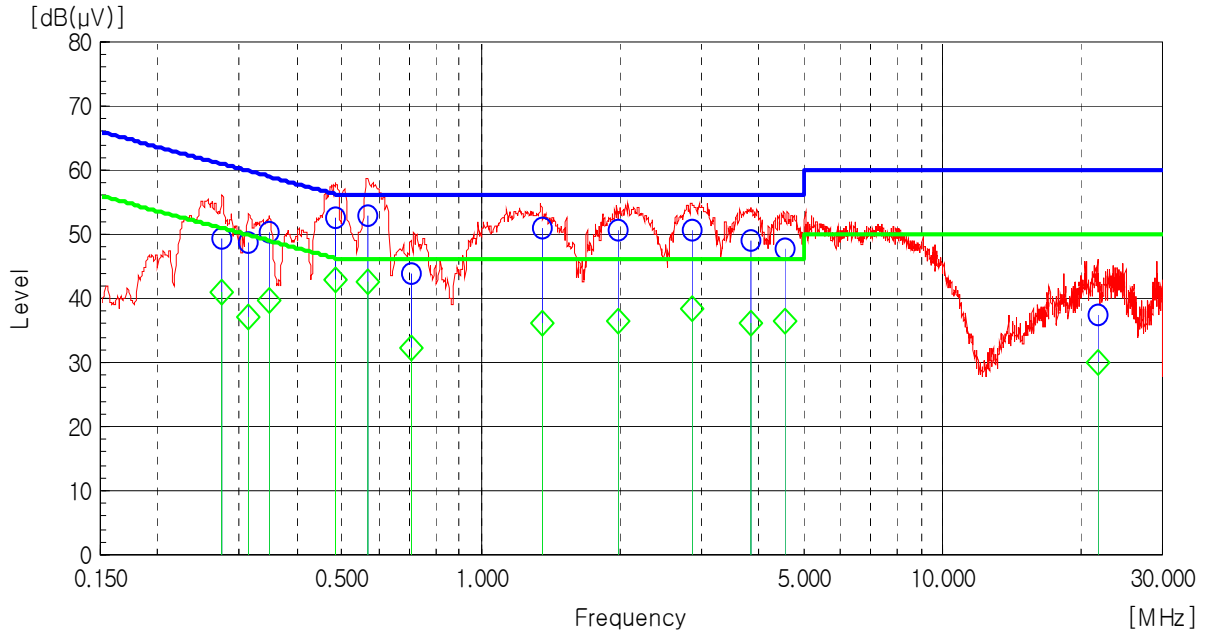
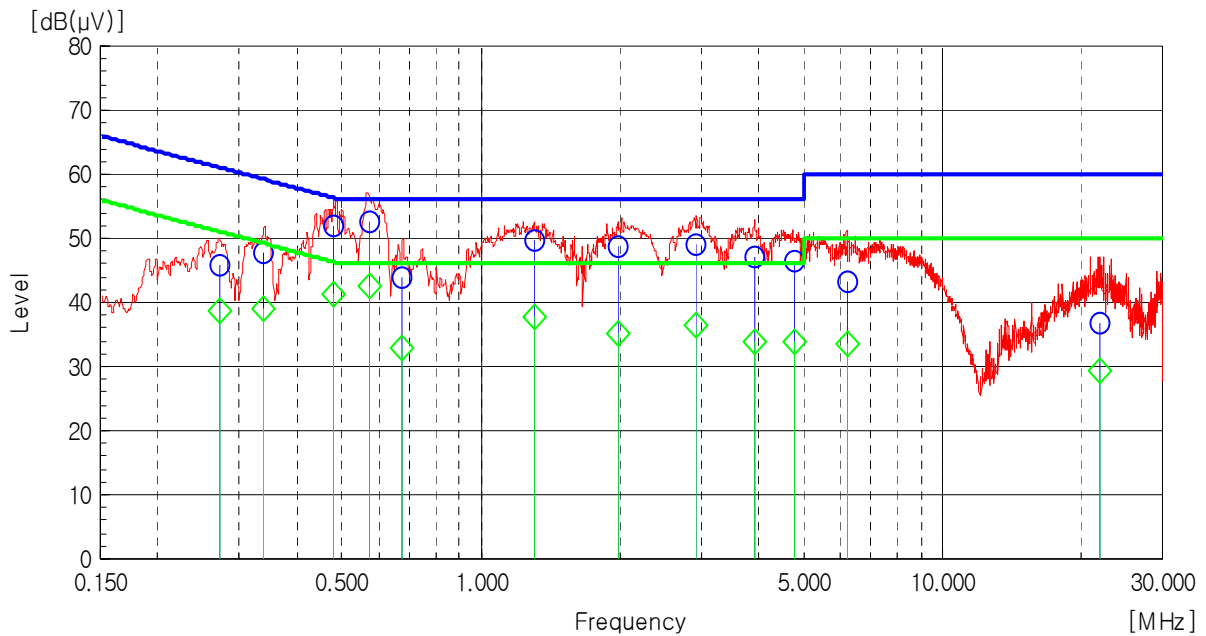

Test Engineer: Hoon Pyo, Lee

Line: HOT LineLimit : — Quasi-Peak
— Average**Line: Neutral Line**

Quasi-peak Average

6. SAMPLE CALCULATION

Sample Field Strength Calculation

The field strength is calculated by adding the Antenna Factor and Cable Factor.
The basic equation with a sample calculation is as follows:

$$FS = RA + AF + CF$$

Where FS = Field Strength

RA = Receiver Amplitude

AF = Antenna Factor

CF = Cable Attenuation Factor

$$dB(\mu V) = 20 \log_{10} (uV) : \text{Equation}$$

Example : @ 132.26 MHz

Class B Limit	=	43.50 dBuV/m
Reading	=	25.30 dBuV
Antenna Factor + Cable Loss	=	11.02 + 3.28 = 14.30 dBuV/m
Total	=	39.60 dBuV/m
Margin	=	43.50 – 39.60 = 3.90 dB
	=	3.90 dB below Limit

7. List of test equipments used for measurements

	Test Equipment	Model	Mfg.	Serial No.	Cal. Due Date
■	EMI Test Receiver	ESVS10	R & S	835165/001	10-04-02
■	Spectrum Analyzer	E7405A	H.P	US41160290	10-09-18
■	LogBicon Antenna	VULB9160	Schwarzbeck	3082	10-01-25
■	Broad band Horn antenna	BBHA 9120D	Schwarz Beck	227	11-03-16
■	Broad band Horn antenna	BBHA 9120D	Schwarz Beck	285	11-03-16
■	Preamplifier	8447D	H.P	3307A02865	10-09-18
■	System Power Supply	6030A	Agilent	1036546	10-04-03
■	Power Meter	NRVS	R & S	834053/060	10-09-18
■	Controller	HD2000	HD GmbH	C/125	N/A
■	Antenna Master	MA2400	HD GmbH	N/A	N/A
■	Turn-Table	MFT-120S	Max-Full Antenna Corp	N/A	N/A
■	Antenna Master	MFA-440E	Max-Full Antenna Corp	N/A	N/A