FCC Test Report

Report No: WD-RF-R-250011-A0

Product Name : Wireless Module
Model Name : ZY-IA9QH5
FCC ID : XN6-IA9QH5V1
Applicant : Zylux Acoustic Corporation
Received Date : Nov. 22, 2024
Tested Date : Dec. 17, 2024 ~ Jan. 09, 2025
Applicable Standard : 47 CFR FCC Part 15, Subpart E (Section 15.407)
789033 D02 General U-NII Test Procedures New Rules v02r01
291074 D01 General Requirements v01
ANSI C63.10 : 2013



Wendell Industrial Co., Ltd
Wendell EMC & RF Laboratory

Caution:

This report sets forth our findings solely with respect to the test samples identified herein. The results set forth in this report are not indicative or representative of the quality or characteristics of the lot from which a test sample was taken or any similar or identical product unless specifically and expressly noted.

The test results shown in the test report are traceable to the national/international standard through the calibration report of the equipment.

Please note that the measurement uncertainty are provided for informational purpose only and are not used in determining the Pass/Fail results.

This report must not be used to claim product endorsement by TAF or any agency of the government.

The test report shall not be reproduced without the written approval of Wendell Industrial Co., Ltd..

Test Report

Issued Date: January 09, 2025

Project No.: 24Q111503

Product Name	Wireless Module
Trade Name	N/A
Model Name	ZY-IA9QH5
FCC ID	XN6-IA9QH5V1
Applicant	Zylux Acoustic Corporation
Manufacturer	Zylux Acoustic Corporation
EUT Rated Voltage	DC 3.3V
EUT Test Voltage	AC 120V / 60Hz
EUT Supports Radios Application	Other 5G
Applicable Standard	47 CFR FCC Part 15, Subpart E (Section 15.407) 789033 D02 General U-NII Test Procedures New Rules v02r01 ANSI C63.10 : 2013
Output Power	5.16 ~ 5.245 GHz: 8.97 dBm 5.735 ~ 5.850 GHz: 9.42 dBm 5.850 ~ 5.875 GHz: 14.67 dBm
Test Result	Complied

Documented :



(Specialist / Emma Lu)

Technical Engineer

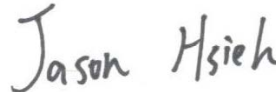

(Assistant Section Manager / Jason Hsieh)

Approved :

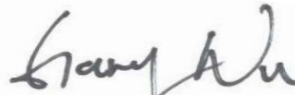

(Project Manager / Gary Wu)

Table of Contents

Document Revision History	5
Summary of Test Result.....	6
1 Generation Information	7
1.1 Applicant.....	7
1.2 Manufacturer.....	7
1.3 Description of Equipment under Test.....	7
1.4 Test Mode Applicability And Tested Channel Detail	11
1.5 Configuration of Tested System	13
1.6 EUT Exercise Software	13
1.7 Tested System Details.....	14
1.8 Test Facility	15
1.9 Measurement Uncertainty	16
1.10 List of Test Equipment.....	17
2 Test Result	21
2.1 Antenna Requirement.....	21
2.1.1 Applicable Standard.....	21
2.1.2 Antenna Connected Construction	22
2.1.3 Test Result	22
2.2 Output Power Measurement and Transmit Power Control	23
2.2.1 Limit	23
2.2.2 Test Setup.....	24
2.2.3 Test Procedure.....	24
2.2.4 Test Result	25
2.2.5 Transmit Power Control.....	26
2.3 26dB Bandwidth, 6dB Bandwidth and 99% Occupied Bandwidth Measurement.....	27
2.3.1 Limit	27
2.3.2 Test Setup.....	27
2.3.3 Test Procedure.....	27
2.3.4 Test Result	29
2.2.4.1 6dB Bandwidth	29
2.2.4.1 26dB & 99% Bandwidth.....	31
2.4 Power Spectral Density Measurement.....	33
2.4.1 Limit	33
2.4.2 Test Setup.....	33
2.4.3 Test Procedure.....	34
2.4.4 Test Result	35
2.5 Unwanted Emission Measurement	38
2.5.1 Limit	38
2.5.2 Test Setup.....	40
2.5.3 Test Procedure.....	41
2.5.4 Duty Cycle	42
2.5.5 Test Result of Radiated Band Edge Measurement.....	42
2.5.6 Test Result of Radiated Spurious Emission Measurement	55
2.6 Frequency Stability	78
2.6.1 Limit	78

2.6.2	Test Setup.....	78
2.6.3	Test Procedure.....	78
2.6.4	Test Result	79
2.7	Antenna Requirement.....	81
2.7.1	Applicable Standard.....	81
2.7.2	Antenna Connected Construction	81
2.7.3	Antenna Gain	81
2.8	AC Conducted Emissions Measurement.....	82
2.8.1	Limit	82
2.8.2	Test Setup.....	82
2.8.3	Test Procedure.....	83
2.8.4	Test Result	84
Attachment 1: EUT Test Photographs		
Attachment 2: EUT Detailed Photographs		

Document Revision History

Report No.	Issue date	Description
WD-RF-R-250011-A0	January 09, 2025	Initial report

Summary of Test Result

Ref. Std. Clause	Test Items	Result
15.407(a)	26dB Bandwidth	Pass
15.407(e)	6dB Bandwidth	Pass
--	99% Occupied Bandwidth	Pass
15.407(a)	Maximum Conducted Output Power	Pass
15.407(a)	Power Spectral Density	Pass
15.407(b) 15.209	Unwanted Emissions	Pass
15.407(g)	Frequency Stability	Pass
15.207	AC Conducted Emission	Pass
15.203 15.407(a)	Antenna Requirement	Pass

1 Generation Information

1.1 Applicant

Zylux Acoustic Corporation
7F, 70, Rui Guang Road, Neihu District, Taipei 114, Taiwan

1.2 Manufacturer

Zylux Acoustic Corporation
7F, 70, Rui Guang Road, Neihu District, Taipei 114, Taiwan

1.3 Description of Equipment under Test

Product Name	Wireless Module
Model No.	ZY-IA9QH5
FCC ID	XN6-IA9QH5V1
Frequency Range	5160-5245MHz, 5735-5850MHz, 5850-5875MHz
Number of Channels	5160-5245MHz:18 ; 5735-5850MHz:24 ; 5850-5875MHz:6
Data Rate	Other 5G:2Mbps
Type of Modulation	GFSK
Antenna Information	Refer to the table “Antenna List”
EUT Supports Radios Application	Other 5G
EUT Rated Voltage	DC 3.3V
EUT Test Voltage	AC 120V / 60Hz

Antenna List

No.	Manufacturer	Model No.	Antenna Type	Peak Gain
1	ZYLUX	ZZ_ANT_0000004	PCB Printed Antenna	4.35 dBi for 5.16 ~ 5.875 GHz
2	ZYLUX	ZZ_ANT_0000004	PCB Printed Antenna	5.38 dBi for 5.16 ~ 5.875 GHz

Remark: The antenna of EUT is conforming to FCC 15.203

Channel List

5160 ~ 5245MHz		5735 ~ 5850MHz		5850 ~ 5875MHz	
Channel	Frequency(MHz)	Channel	Frequency(MHz)	Channel	Frequency(MHz)
0	5160	0	5735	0	5850
1	5165	1	5740	1	5855
2	5170	2	5745	2	5860
3	5175	3	5750	3	5865
4	5180	4	5755	4	5870
5	5185	5	5760	5	5875
6	5190	6	5765	--	--
7	5195	7	5770	--	--
8	5200	8	5775	--	--
9	5205	9	5780	--	--
10	5210	10	5785	--	--
11	5215	11	5790	--	--
12	5220	12	5795	--	--
13	5225	13	5800	--	--
14	5230	14	5805	--	--
15	5235	15	5810	--	--
16	5240	16	5815	--	--
17	5245	17	5820	--	--
--	--	18	5825	--	--
--	--	19	5830	--	--
--	--	20	5835	--	--
--	--	21	5840	--	--
--	--	22	5845	--	--
--	--	23	5850	--	--

Test Frequencies in each operating band

Frequency range over which the device operates in each operating band (Note 1)	Number of test frequencies required	Location of test frequencies inside the operating frequency range (Note 1,2)
≤ 1 MHz	1	near center
> 1 MHz and ≤ 10 MHz	2	1 near high end, 1 near low end
> 10 MHz	3	1 near high end, 1 near center, and 1 near low end

Note 1: The frequency range over which the device operates in a given operating band is the difference between the highest and lowest frequencies on which the device can be tuned within that given operating band. The frequency range can be smaller than or equal to the operating band, but cannot be greater than the operating band.

Note 2: In the third column of table 1, “near” means as close as possible to or at the center / low end / high end of the frequency range over which the device operates.

Firmware / Software Version

1	Product Name	Wireless Module
2	Model No.	ZY-IA9QH5
3	Test SW Version	Syncomm Debug Tool v24.03.08
4	RF power setting in TEST SW	<input type="checkbox"/> RF power setting was not able to alter during testing. <input checked="" type="checkbox"/> RF power setting was able to alter during testing. (See the following table)

Parameters of test software setting

Type of Modulation	Channel	Frequency (MHz)	Set Value	
			Chain A	Chain B
other 5G	0	5160	04	04
	9	5205	04	04
	17	5245	04	04
	0	5735	03	03
	11	5790	03	03
	23	5850	03	03
	0	5850	03	03
	2	5860	04	04
	5	5875	04	04

1.4 Test Mode Applicability And Tested Channel Detail

1. Pre-Scan has been conducted to determine the worst-case mode from all possible combinations between available modulations, data rates, XYZ axis and antenna ports.
2. The worst case was found when positioned on X axis for radiated emission. Following test modes were selected for the final test, and the final worst case is recorded in the report:

EUT Configure Mode	RE < 1G	RE ≥ 1G	ACM	ACP	Description
--	☒	☒	☒	☒	Transmit

Note : RE<1G: Radiated Emission below 1GHz RE≥1G: Radiated Emission above 1GHz
 ACM: Antenna Port Conducted Measurement ACP: AC Power Line Conducted Emission

Following channel(s) was (were) selected for the final test as listed below:

Radiated Spurious Emission Measurement(Below 1GHz):

Mode	Frequency (MHz)	Available Channel	Tested Channel	Modulation Type	Data Rate (Mbps)
--	5160 ~ 5245	0 ~ 17	0	GFSK	2
--	5735 ~ 5850	0 ~ 23	0	GFSK	2
--	5850 ~ 5875	0 ~ 5	2	GFSK	2

Radiated Spurious Emission Measurement(Above 1GHz):

Mode	Frequency (MHz)	Available Channel	Tested Channel	Modulation Type	Data Rate (Mbps)
--	5160 ~ 5245	0 ~ 17	0, 9, 17	GFSK	2
--	5735 ~ 5850	0 ~ 23	0, 11, 23	GFSK	2
--	5850 ~ 5875	0 ~ 5	0, 2, 5	GFSK	2

Radiated Band Edge Emission Measurement(Above 1GHz):

Mode	Frequency (MHz)	Available Channel	Tested Channel	Modulation Type	Data Rate (Mbps)
--	5160 ~ 5245	0 ~ 17	0	GFSK	2
--	5735 ~ 5850	0 ~ 23	0, 23	GFSK	2
--	5850 ~ 5875	0 ~ 5	0, 2, 5	GFSK	2

Output Power, Power Spectral Density:

Mode	Frequency (MHz)	Available Channel	Tested Channel	Modulation Type	Data Rate (Mbps)
--	5160 ~ 5245	0 ~ 17	0, 9, 17	GFSK	2
--	5735 ~ 5850	0 ~ 23	0, 11, 23	GFSK	2
--	5850 ~ 5875	0 ~ 5	0, 2, 5	GFSK	2

6dB Bandwidth:

Mode	Frequency (MHz)	Available Channel	Tested Channel	Modulation Type	Data Rate (Mbps)
--	5735 ~ 5850	0 ~ 23	0, 11, 23	GFSK	2
--	5850 ~ 5875	0 ~ 5	0, 2, 5	GFSK	2

26dB Bandwidth, 99% Occupied Bandwidth:

Mode	Frequency (MHz)	Available Channel	Tested Channel	Modulation Type	Data Rate (Mbps)
--	5160 ~ 5245	0 ~ 17	0, 9, 17	GFSK	2
--	5735 ~ 5850	0 ~ 23	0, 11, 23	GFSK	2
--	5850 ~ 5875	0 ~ 5	0, 2, 5	GFSK	2

Frequency Stability:

Mode	Frequency (MHz)	Available Channel	Tested Channel	Modulation Type	Data Rate (Mbps)
--	5160 ~ 5245	0 ~ 17	0, 9, 17	GFSK	2
--	5735 ~ 5850	0 ~ 23	0, 11, 23	GFSK	2
--	5850 ~ 5875	0 ~ 5	0, 2, 5	GFSK	2

AC Conducted Emission:

EUT Configure Mode	Mode	Available Channel	Tested Channel	Modulation Type	Data Rate (Mbps)
--	5850 ~ 5875	0 ~ 5	2	GFSK	2

1.5 Configuration of Tested System

Radiation

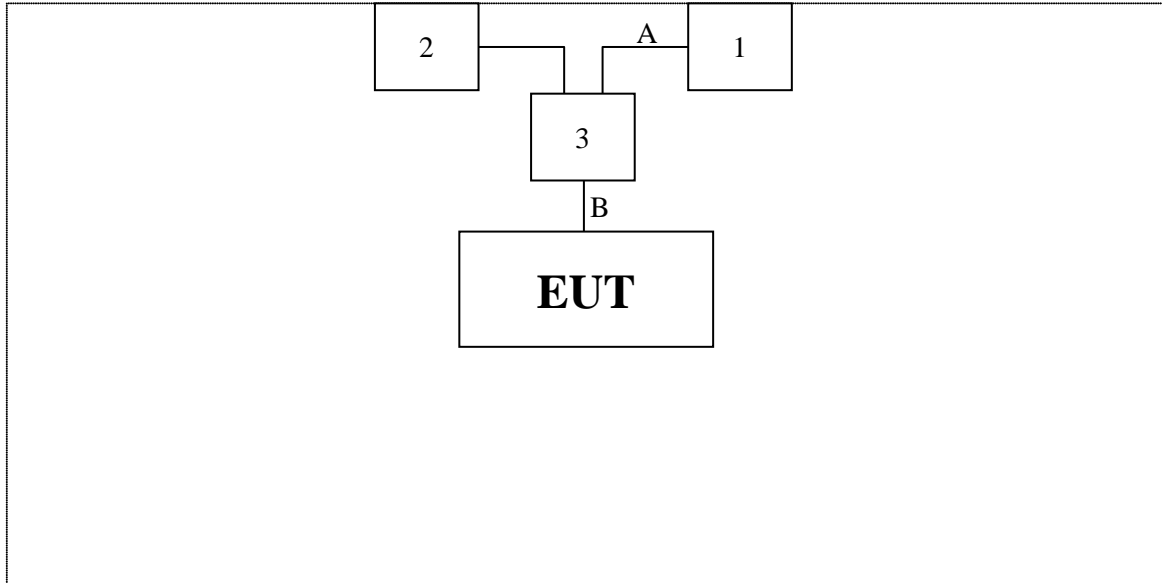

Test Table

AC Conduction

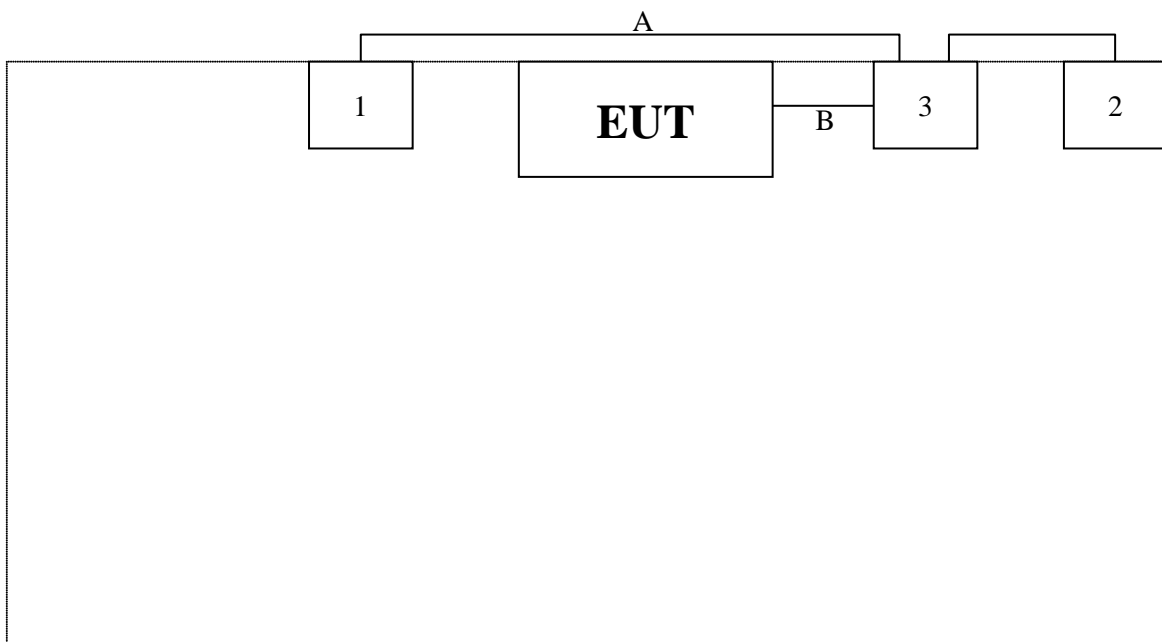

Test Table

1.6 EUT Exercise Software

1. Setup the EUT as shown in Section 1.5
2. Execute software "Syncomm Debug Tool v24.03.08".
3. Configure the test mode, the test channel, and the data rate.
4. Press "OK" to start the continuous transmit.
5. Verify that the EUT works properly.

1.7 Tested System Details

The types for all equipment, plus descriptions of all cables used in the tested system (including inserted cards) are:

No.	Product	Manufacturer	Model No.	Serial No.	Power Cord
1	Notebook PC	acer	N16Q1	NXVD4TA023742254707600	N/A
2	Adapter	SYNIC	JZB012-050150UX	N/A	Non-shielded, Non-Core, 1.5m
3	Fixture	SYNIC	B5	N/A	N/A

No.	Signal Cable Type	Signal cable Description
A	USB Cable	Shielded, Non-Core, 0.6m
B	Flexible flat Cable	Non-shielded, Non-Core, 0.26m

1.8 Test Facility

Items	Required (IEC 60068-1)	Actual
Temperature (°C)	15-35	20~25
Humidity (% RH)	25-75	45~55
Barometric pressure (mbar)	860-1060	990~1020

Description: Accredited by TAF
Accredited Number: 2965

Issued by: Wendell Industrial Co., Ltd

Lab Address: 6F/6F-1, No.188, Baoqiao Rd., Xindian Dist.,
New Taipei City 23145, Taiwan R.O.C

Test Lab: Wendell EMC & RF Laboratory

Test Location: No. 119, Wugong 3rd Rd., Wugu Dist.,
New Taipei City 248, Taiwan (R.O.C.)

Designation Number: TW0025

Test Firm Registration Number: 665221

1.9 Measurement Uncertainty

ISO/IEC 17025 requires that an estimate of the measurement uncertainties associated with the emissions test results be included in the report. The measurement uncertainties given below are based on a 95% confidence (level based on a coverage factor K=2)

Measurement Project	Condition	Expanded Uncertainty
AC Conducted Emission	0.150 ~ 30 MHz	2.64 dB
Radiated Emission	0.009 ~ 30 MHz	± 4.2 dB
	30 ~ 1000 MHz	± 3.9 dB
	1000 ~ 18000 MHz	± 4.1 dB
	18000 ~ 40000 MHz	± 3.9 dB
RF Power, Conducted	Conducted Measuring	± 0.51 dB
Occupied Bandwidth	Conducted Measuring	± 2.4 %
Power Density	Conducted Measuring	± 1.7 dB
Duty Cycle	Conducted Measuring	± 1.3 %
Frequency Stability	Conducted Measuring	± 0.063 ppm
DC Power Supply	--	± 3.2 %
Temperature	--	± 1.1 °C
Humidity	--	± 3.4 %

Note: Please note that the measurement uncertainty are provided for informational purpose only and are not used in determining the Pass/Fail results.

1.10 List of Test Equipment

For Conducted measurements / W08-Conducted Measurement

Equipment	Manufacturer	Model No.	Serial No.	Cal. Date	Due Date
✓ Spectrum analyzer	Keysight	N9010A	SG50420005	2024/08/09	2025/08/08
✓ Wideband Peak Power Meter	Anritsu	ML2495A	1733007	2024/09/05	2025/09/04
✓ Pulse Power Sensor + Precision Adaptor	Anritsu	MA2411B	1726022	2024/09/05	2025/09/04
Temperature Chamber	TERCHY	MHK-225LK	1061121	2024/04/19	2025/04/18
Wireless Connectivity Tester	R&S	CMW270	101307	2024/06/04	2025/06/03
✓ Attenuator	MVE	MVE2211-10	CT-9-056	2024/08/08	2026/08/07
Attenuator	MVE	MVE2211-20	CT-9-057	2024/08/08	2026/08/07
Attenuator	MVE	MVE2211-30	CT-9-058	2024/08/08	2026/08/07
Power Divider	MVE	MVE8546	170826003	2024/08/08	2026/08/07
Power Splitter	MVE	MVE8547	170302047	2024/08/10	2026/08/09
DC Power Supply	GW INSTEK	GPC-3060D	GER817636	2024/08/05	2025/08/04

Remark:

1. The equipments are calibrated every one year.
2. The Attenuator/ Divider/ Splitter are calibrated every two year.
3. The test instruments marked with “✓” are used to measure the final test results.

For AC Conduction measurements / W08-CE

	Equipment	Manufacturer	Model No.	Serial No.	Cal. Date	Due Date
✓	EMI Test Receiver	R&S	ESR3	102309	2024/06/21	2025/06/20
✓	2-Line V-Network LISN	R&S	ENV216	101185	2024/06/20	2025/06/19
✓	LISN	SCHWARZBECK	NSLK 8127RC	05028	2024/06/20	2025/06/19
✓	Transient Limiter	EM Electronics Corporation	EM-7600	857	2024/06/24	2025/06/23
✓	50ohm Cable	EMCI	EMCCFD300-BM-BM- 5000	170612	2024/06/24	2025/06/23
✓	50 ohm terminal impedance	HUBER+SUHNER	50 ohm terminal impedance	CT-1-109-1	2024/06/20	2025/06/19

Remark:

1. All equipments are calibrated every one year.
2. The test instruments marked with “✓” are used to measure the final test results.
3. Test Software version: FARAD EZ-EMC Ver.EMC-CON 3A1

For Radiated measurements / W08-996-2

Equipment	Manufacturer	Model No.	Serial No.	Cal. Date	Due Date
✓ EMI Receiver	Keysight	N9038A	MY51210173	2024/08/21	2025/08/20
✓ Spectrum Analyzer	Keysight	N9010A	MY52220228	2024/08/19	2025/08/18
✓ Loop Antenna	EMCI	FMZB 1513-60B	00033	2024/05/02	2025/05/01
✓ TRILOG super broad Antenna	Schwarzbeck	VULB 9168	VULB 9168-700 & 20E03	2024/07/23	2025/07/22
✓ Horn Antenna	Schwarzbeck	BBHA 9120D	01767	2024/08/15	2025/08/14
✓ Horn Antenna	Schwarzbeck	BBHA 9170	703	2024/08/15	2025/08/14
✓ Pre-Amplifier	EM	EMC330	060774	2024/08/16	2025/08/15
✓ Pre-Amplifier	EMEC	EM01G18G	060648	2024/08/16	2025/08/15
✓ Pre-Amplifier	JPT	JPA0118-55-303K	1910001800055003	2024/08/20	2025/08/19
✓ Pre-Amplifier	EMCI	EMC184045SE	980515	2024/08/16	2025/08/15
✓ Cable	EMEC	EM-CB400	105060103	2024/08/21	2025/08/20
✓ Cable	EMEC	EM-CB400	105060102	2024/08/21	2025/08/20
✓ Cable	EMEC	EM-CB400	105060101	2024/08/21	2025/08/20
✓ RF Cable	HUBER+SUHNER	SF102	MY2752/2	2024/08/21	2025/08/20
✓ Cable	MVE	280280.LL266.1200	C90177C	2024/08/21	2025/08/20
✓ RF Cable	HUBER+SUHNER	EMC102-KM-KM-600	190646	2024/08/21	2025/08/20
✓ Cable	EMCI	140140.LL404.700	B90014C	2024/08/21	2025/08/20
RF Filter	EMEC	140140.LL404.300	B90006C	2024/08/21	2025/08/20
✓ RF Filter	EMEC	BRF-2400-2500	002	2024/08/26	2026/08/25
✓ RF Filter	EMEC	BRF-5150-5350	104	2024/08/26	2026/08/25
✓ RF Filter	EMEC	BRF-5470-5725	092	2024/08/26	2026/08/25
RF Filter	EMEC	BRF-5725-5875	091	2024/08/26	2026/08/25
✓ RF Filter	EMEC	HPF-2800	002	2024/08/26	2026/08/25
SMA Notch Filter	MVE	HPF-5850	059	2024/08/26	2026/08/25

Remark:

1. The equipments are calibrated every one year.
2. The Filter calibrated every two year.
3. The test instruments marked with "✓" are used to measure the final test results.

4. Test Software version: FARAD EZ-EMC Ver.WD-03A1-1

2 Test Result

2.1 Antenna Requirement

2.1.1 Applicable Standard

For the band 5.15-5.25 GHz

- (1) For an outdoor access point operating:

If transmitting antennas of directional gain greater than 6 dBi are used, both the maximum conducted output power and the maximum power spectral density shall be reduced by the amount in dB that the directional gain of the antenna exceeds 6 dBi.

- (2) For an indoor access point operating:

If transmitting antennas of directional gain greater than 6 dBi are used, both the maximum conducted output power and the maximum power spectral density shall be reduced by the amount in dB that the directional gain of the antenna exceeds 6 dBi.

- (3) For fixed point-to-point access points operating:

For fixed point-to-point transmitters that employ a directional antenna gain greater than 23 dBi, a 1 dB reduction in maximum conducted output power and maximum power spectral density is required for each 1 dB of antenna gain in excess of 23 dBi.

- (4) For client devices:

If transmitting antennas of directional gain greater than 6 dBi are used, both the maximum conducted output power and the maximum power spectral density shall be reduced by the amount in dB that the directional gain of the antenna exceeds 6 dBi.

For the 5.25-5.35 GHz and 5.47-5.725 GHz bands

If transmitting antennas of directional gain greater than 6 dBi are used, both the maximum conducted output power and the maximum power spectral density shall be reduced by the amount in dB that the directional gain of the antenna exceeds 6 dBi.

For the band 5.725-5.85 GHz

If transmitting antennas of directional gain greater than 6 dBi are used, both the maximum conducted output power and the maximum power spectral density shall be reduced by the amount in dB that the directional gain of the antenna exceeds 6 dBi. However, fixed point-to-point U-NII devices operating in this band may employ transmitting antennas with directional gain greater than 6 dBi without any corresponding reduction in transmitter conducted power. Fixed, point-to-point operations exclude the use of point-to-multipoint systems, omnidirectional applications, and multiple collocated transmitters transmitting the same information.

2.1.2 Antenna Connected Construction

Non-standard antenna connector is used.

2.1.3 Test Result

No.	Manufacturer	Model No.	Antenna Type	Peak Gain
1	ZYLUX	ZZ_ANT_0000004	PCB Printed Antenna	4.35 dBi for 5.16 ~ 5.875 GHz
2	ZYLUX	ZZ_ANT_0000004	PCB Printed Antenna	5.38 dBi for 5.16 ~ 5.875 GHz

Description of the operating transmit modes :

* other 5G : diversity Antenna but only one active mode, this port is Ant-1

Directional gain calculation :

* B1_other 5G : Gain = 4.35 dBi < 6dBi

* B4_other 5G : Gain = 4.35 dBi < 6dBi

2.2 Output Power Measurement and Transmit Power Control

2.2.1 Limit

1. For frequency Band 5150~5250MHz:
 - (1) Outdoor access point : 1W (30 dBm)
 - (2) Indoor access point : 1W (30 dBm)
 - (3) Fixed point-to-point access point : 1W (30 dBm)
 - (4) Client device : 250mW (24 dBm)
 - (5) If transmitting antennas of directional gain greater than 6 dBi are used, both the maximum conducted output power and the maximum power spectral density shall be reduced by the amount in dB that the directional gain of the antenna exceeds 6 dBi.

2. For frequency Band 5250~5350MHz and 5470~5725MHz:
 - (1) 250mW or 11 dBm + 10 log B, where B is the 26 dB emission bandwidth (MHz), whichever is lesser.
 - (2) If transmitting antennas of directional gain greater than 6 dBi are used, both the maximum conducted output power and the maximum power spectral density shall be reduced by the amount in dB that the directional gain of the antenna exceeds 6 dBi.

3. For frequency Band 5725~5850MHz:
 - (1) The maximum conducted output power over the frequency band of operation shall not exceed 1 W(30 dBm).
 - (2) If transmitting antennas of directional gain greater than 6 dBi are used, both the maximum conducted output power and the maximum power spectral density shall be reduced by the amount in dB that the directional gain of the antenna exceeds 6 dBi.

4. For frequency Band 5850~5895MHz:
 - (1) Indoor access point & subordinate device: The maximum e.i.r.p. over the frequency band of operation must not exceed 36 dBm.
 - (2) Client device: The maximum e.i.r.p. over the frequency band of operation must not exceed 30 dBm.

Transmit power control (TPC). U-NII devices operating in the 5.25-5.35 GHz band and the 5.47-5.725 GHz band shall employ a TPC mechanism. The U-NII device is required to have the capability to operate at least 6 dB below the mean EIRP value of 30 dBm. A TPC mechanism is not required for systems with an e.i.r.p. of less than 500 mW.

2.2.2 Test Setup

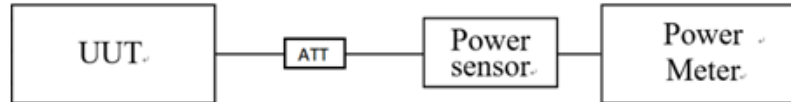

2.2.3 Test Procedure

1. Enable the EUT transmit continuously.
2. Let EUT be connected to the power meter, and record the max. reading.
3. Measurement using a gated RF average power meter, since this measurement is made only during the ON time of the transmitter, no duty cycle correction is required.

2.2.4 Test Result

Frequency (MHz)	Average power (dBm)			Limit (dBm)	Result
	Chain A	Chain B	Total		
5160	8.97	7.43	--	≤ 24	Pass
5205	8.82	7.32	--	≤ 24	Pass
5245	8.76	7.25	--	≤ 24	Pass
5735	9.42	8.23	--	≤ 30	Pass
5790	8.94	7.75	--	≤ 30	Pass
5850	8.27	7.16	--	≤ 30	Pass

Frequency (MHz)	EIRP Average power (dBm)			EIRP Limit (dBm)	Result
	Chain A	Chain B	Total		
5850	12.62	12.54	--	≤ 30	Pass
5860	14.67	14.51	--	≤ 30	Pass
5875	14.20	13.80	--	≤ 30	Pass

Remark:

1. Average Power = Reading value on power meter + cable loss
2. EIRP Average Power = Reading value on power meter + cable loss + antenna gain
3. $10 \text{ Log}(X/\text{mW}) = \text{dBm}$, $X=1 \text{ watt}$ (Limit)
1 watt = 30 dBm
4. Directional Gain > 6dB, Actual Limit = Original Limit - (Directional Gain - 6dB)

2.2.5 Transmit Power Control

EUT doesn't support TPC function.

2.3 26dB Bandwidth, 6dB Bandwidth and 99% Occupied Bandwidth Measurement

2.3.1 Limit

Within 5725~5895 MHz, the minimum 6 dB bandwidth shall be at least 500 kHz.

2.3.2 Test Setup



2.3.3 Test Procedure

1. The following procedure shall be used for measuring 6dB bandwidth:
 - (1) Enable the EUT transmit continuously.
 - (2) Set RBW = 100 kHz, VBW \geq 3 RBW, Sweep = auto couple.
 - (3) Detector = Peak, Trace mode = max hold.
 - (4) Measure the maximum width of the emission that is constrained by the frequencies associated with the two outermost amplitude points (upper and lower frequencies) that are attenuated by 6 dB relative to the maximum level measured in the fundamental emission.
2. The following procedure shall be used for measuring 26 dB bandwidth:
 - (1) Set RBW = approximately 1% of the emission bandwidth.
 - (2) Set the VBW > RBW, Detector = Peak, Trace mode = max hold
 - (3) Measure the maximum width of the emission that is 26 dB down from the peak of the emission. Compare this with the RBW setting of the analyzer. Readjust RBW and repeat measurement as needed until the RBW/EBW ratio is approximately 1%.
3. The following procedure shall be used for measuring 99% power bandwidth:
 - (1) Set center frequency to the nominal EUT channel center frequency.
 - (2) Set span = 1.5 times to 5.0 times the OBW.
 - (3) Set RBW = 1% to 5% of the OBW.
 - (4) Set the VBW \geq 3 RBW.
 - (5) Video averaging is not permitted. Where practical, a sample detection and single sweep mode shall be used. Otherwise, peak detection and max hold mode (until the trace stabilizes) shall be used.
 - (6) Use the 99% power bandwidth function of the instrument.

- (7) If the instrument does not have a 99% power bandwidth function, the trace data points are recovered and directly summed in power units. The recovered amplitude data points, beginning at the lowest frequency, are placed in a running sum until 0.5% of the total is reached; that frequency is recorded as the lower frequency. The process is repeated until 99.5% of the total is reached; that frequency is recorded as the upper frequency. The 99% occupied bandwidth is the difference between these two frequencies.

2.3.4 Test Result

2.2.4.1 6dB Bandwidth

UNII Band 3

Frequency (MHz)	6dB BW (MHz)		Limit (kHz)	Result
	Chain A	Chain B		
5735	1.89	--	> 500	Pass
5790	1.90	--	> 500	Pass
5850	1.90	--	> 500	Pass

6dB spectrum plot of Chain A value:

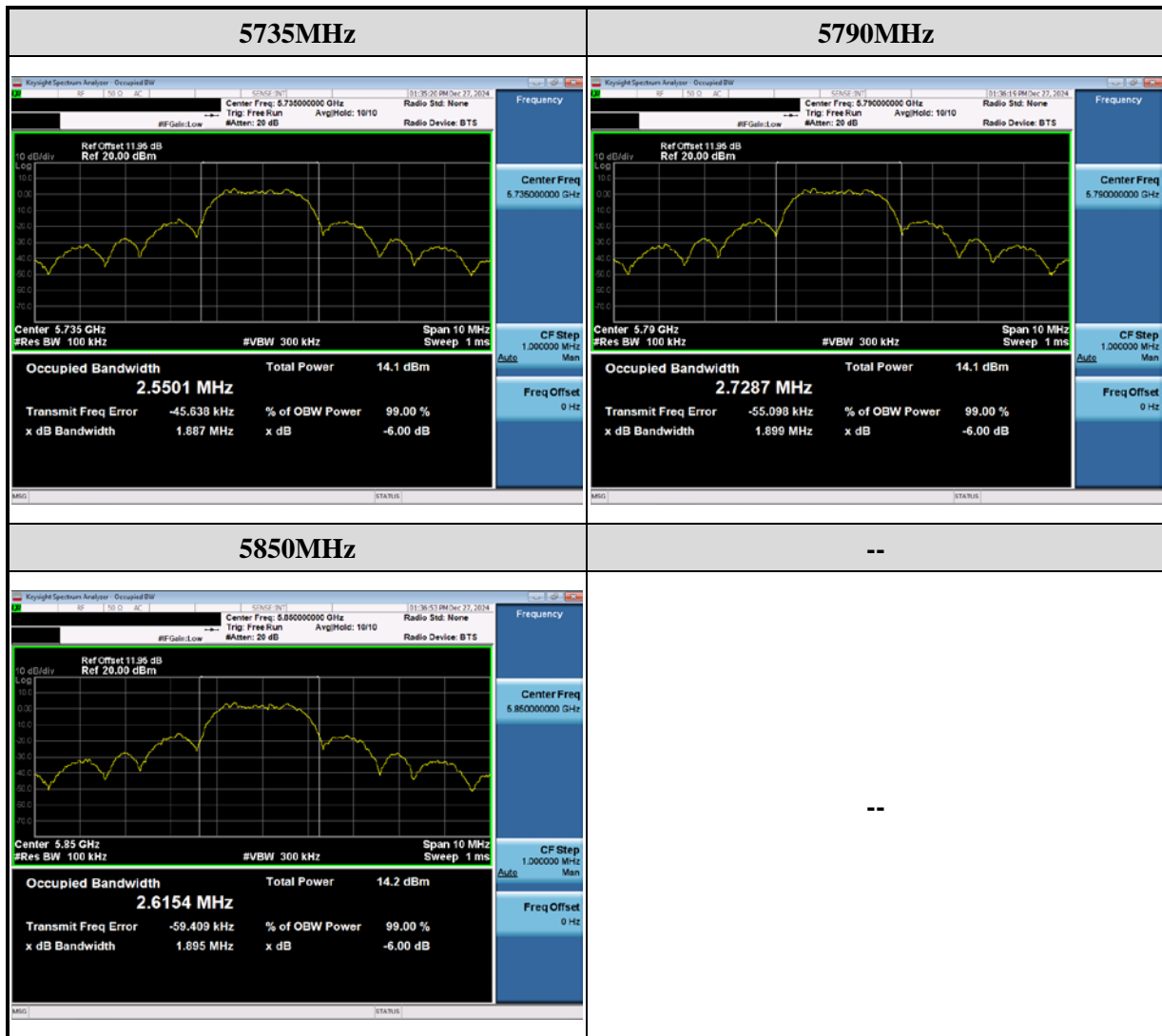

UNII Band 4:

Frequency (MHz)	6dB BW (MHz)		Limit (kHz)	Result
	Chain A	Chain B		
5850	1.89	--	> 500	Pass
5860	1.90	--	> 500	Pass
5875	1.92	--	> 500	Pass

6dB spectrum plot of Chain A value:

2.2.4.1 26dB & 99% Bandwidth

Frequency (MHz)	26dB BW (MHz)		99% OBW (MHz)		Limit (kHz)	Result
	Chain A	Chain B	Chain A	Chain B		
5160	4.536	--	2.927	--	--	--
5205	4.543	--	2.645	--	--	--
5245	4.543	--	2.622	--	--	--

26dB Occupied Bandwidth spectrum plot of Chain A value:

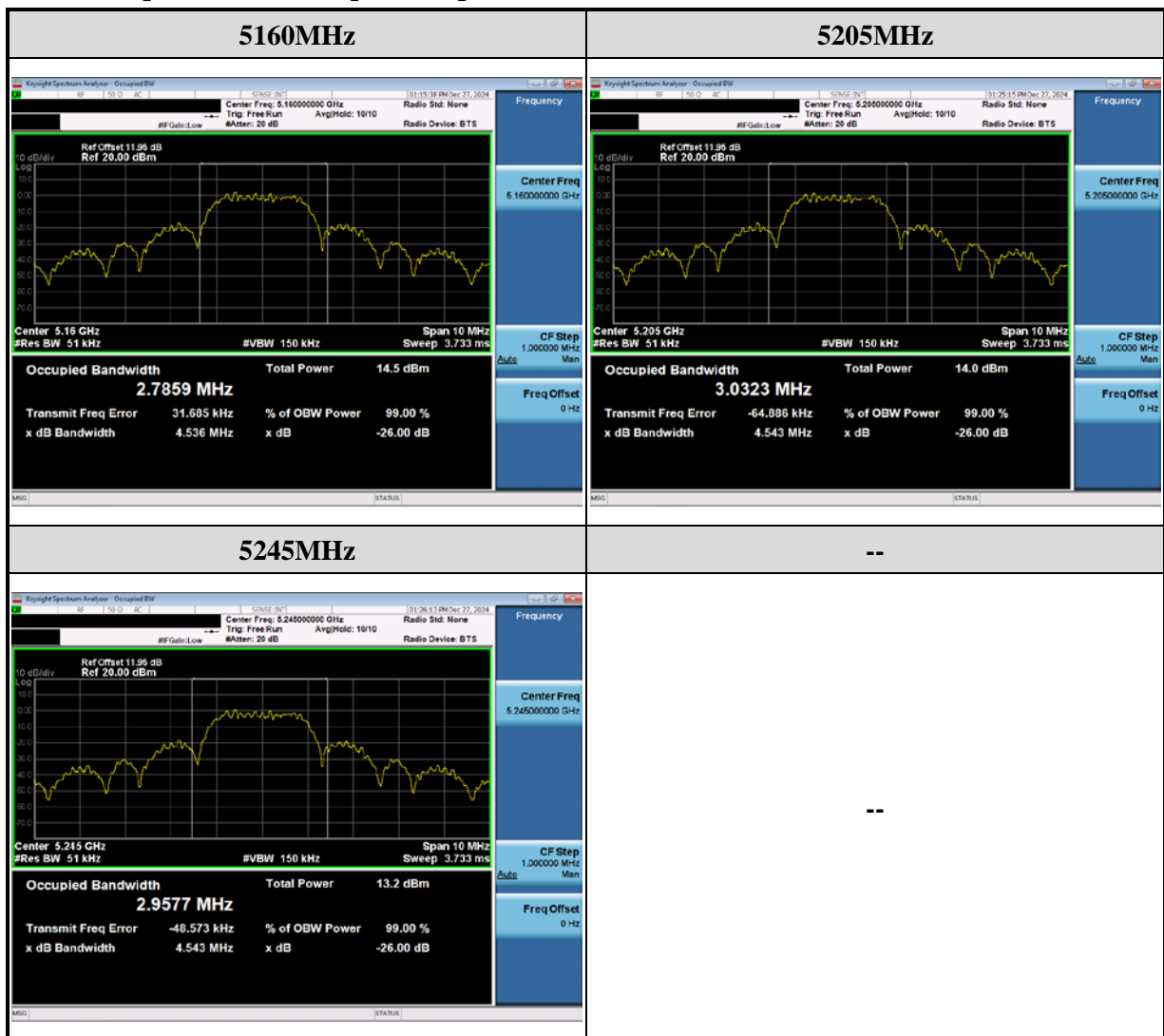

99% Occupied Bandwidth spectrum plot of Chain A value :



2.4 Power Spectral Density Measurement

2.4.1 Limit

1. For frequency Band 5150~5250MHz:
 - (1) Outdoor access point : 17 dBm / MHz
 - (2) Indoor access point : 17 dBm / MHz
 - (3) Fixed point-to-point access point : 17 dBm / MHz
 - (4) Client device : 11 dBm / MHz
2. For frequency Band 5250~5350MHz:
11 dBm / MHz
3. For frequency Band 5470~5725MHz:
11 dBm / MHz
4. For frequency Band 5725~5850MHz:
30 dBm / 500kHz
5. For frequency Band 5850~5895MHz:
Indoor access point & Subordinate device : e.i.r.p 20 dBm / MHz
Client device : e.i.r.p 14 dBm / MHz
6. If transmitting antennas of directional gain greater than 6 dBi are used, both the maximum conducted output power and the maximum power spectral density shall be reduced by the amount in dB that the directional gain of the antenna exceeds 6 dBi.

2.4.2 Test Setup



2.4.3 Test Procedure

1. For frequency band 5150~5250, 5250~5350, 5470~5725, 5850~5895MHz
Method SA-2
 - (1) Measure the duty cycle D of the transmitter output signal.
 - (2) Set span to encompass the entire 26 dB EBW or 99% OBW of the signal
 - (3) Spectrum analyzer set:
 - a) RBW = 1 MHz
 - b) VBW = 3 MHz
 - c) Sweep time = auto
 - d) Detector = RMS
 - e) Number of points in sweep $\geq [2 \text{ span} / \text{RBW}]$.
(This gives bin-to-bin spacing $\leq \text{RBW} / 2$, so that narrowband signals are not lost between frequency bins.)
 - f) Trace average at least 100 traces in power averaging (rms) mode; however, the number of traces to be averaged shall be increased above 100 as needed such that the average accurately represents the true average over the ON and OFF periods of the transmitter.
2. For frequency band 5725~5850 MHz
Method SA-2
 - (1) Measure the duty cycle D of the transmitter output signal.
 - (2) Set span to encompass the entire 26 dB EBW or 99% OBW of the signal
 - (3) Spectrum analyzer set:
 - a) RBW = 100 kHz
 - b) VBW = 300 kHz
 - c) Sweep time = auto
 - d) Detector = RMS
 - e) Number of points in sweep $\geq [2 \text{ span} / \text{RBW}]$.
(This gives bin-to-bin spacing $\leq \text{RBW} / 2$, so that narrowband signals are not lost between frequency bins.)
 - f) Trace average at least 100 traces in power averaging (rms) mode; however, the number of traces to be averaged shall be increased above 100 as needed such that the average accurately represents the true average over the ON and OFF periods of the transmitter.

2.4.4 Test Result

For 5160 MHz ~ 5245 MHz

Frequency (MHz)	PSD (dBm/MHz)		Total PSD (dBm/MHz)	Limit (dBm/MHz)	Result
	Chain A	Chain B			
5160	5.16	--	--	< 11	Pass
5205	5.34	--	--	< 11	Pass
5245	4.62	--	--	< 11	Pass

Remark: PSD = Reading value on a spectrum analyzer + cable loss + duty factor

Power Spectral Density spectrum plot of Chain A value:

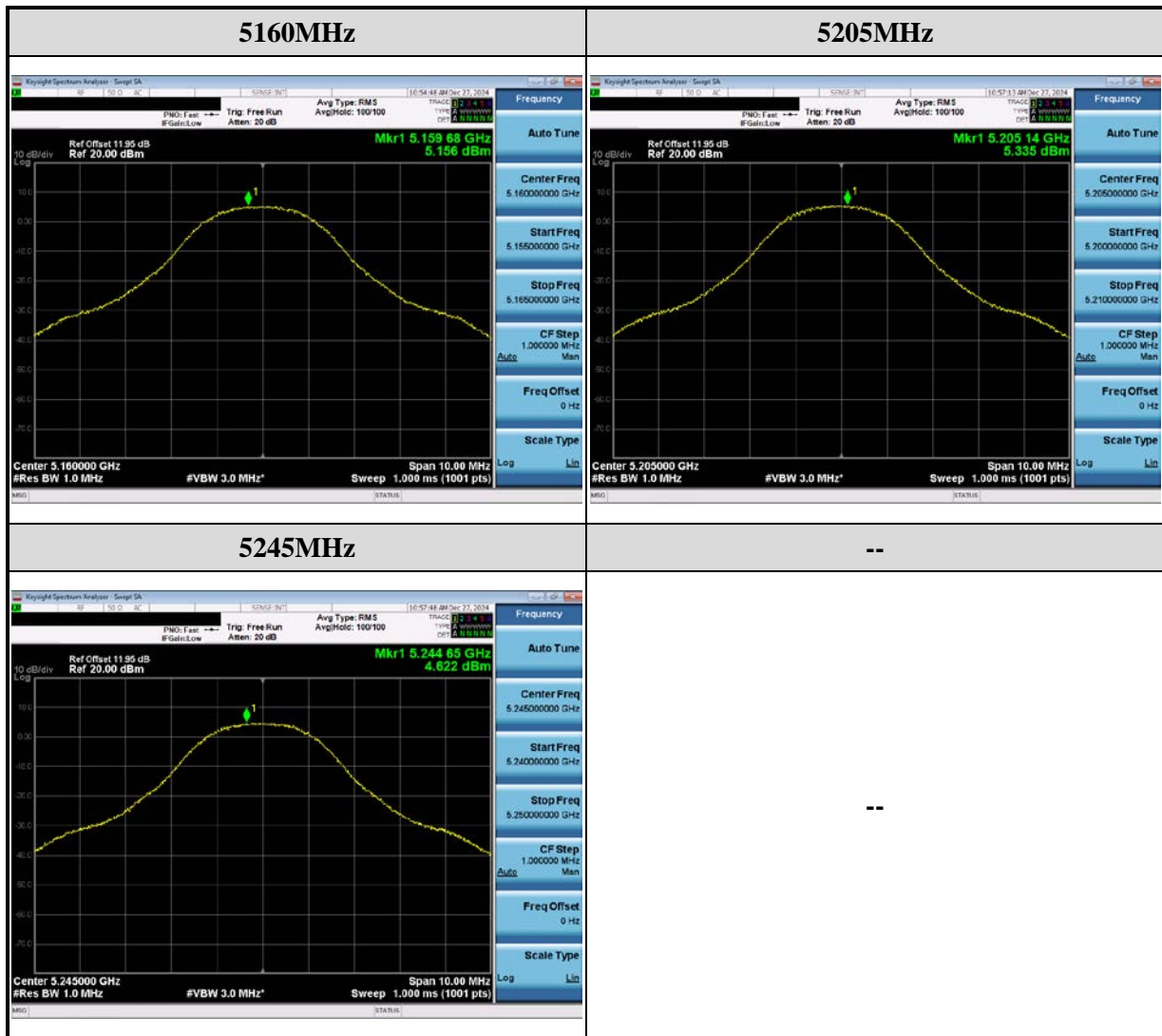

For 5735 MHz ~ 5850 MHz

Frequency (MHz)	PSD (dBm/500kHz)		Total PSD (dBm/500kHz)	Limit (dBm/500kHz)	Result
	Chain A	Chain B			
5735	1.18	--	--	< 30	Pass
5790	1.21	--	--	< 30	Pass
5850	1.35	--	--	< 30	Pass

Remark:

1. Measured value = Reading value on a spectrum analyzer + cable loss + duty factor
2. PSD(dBm/500kHz) = Measured value + 10log(500kHz/100kHz)

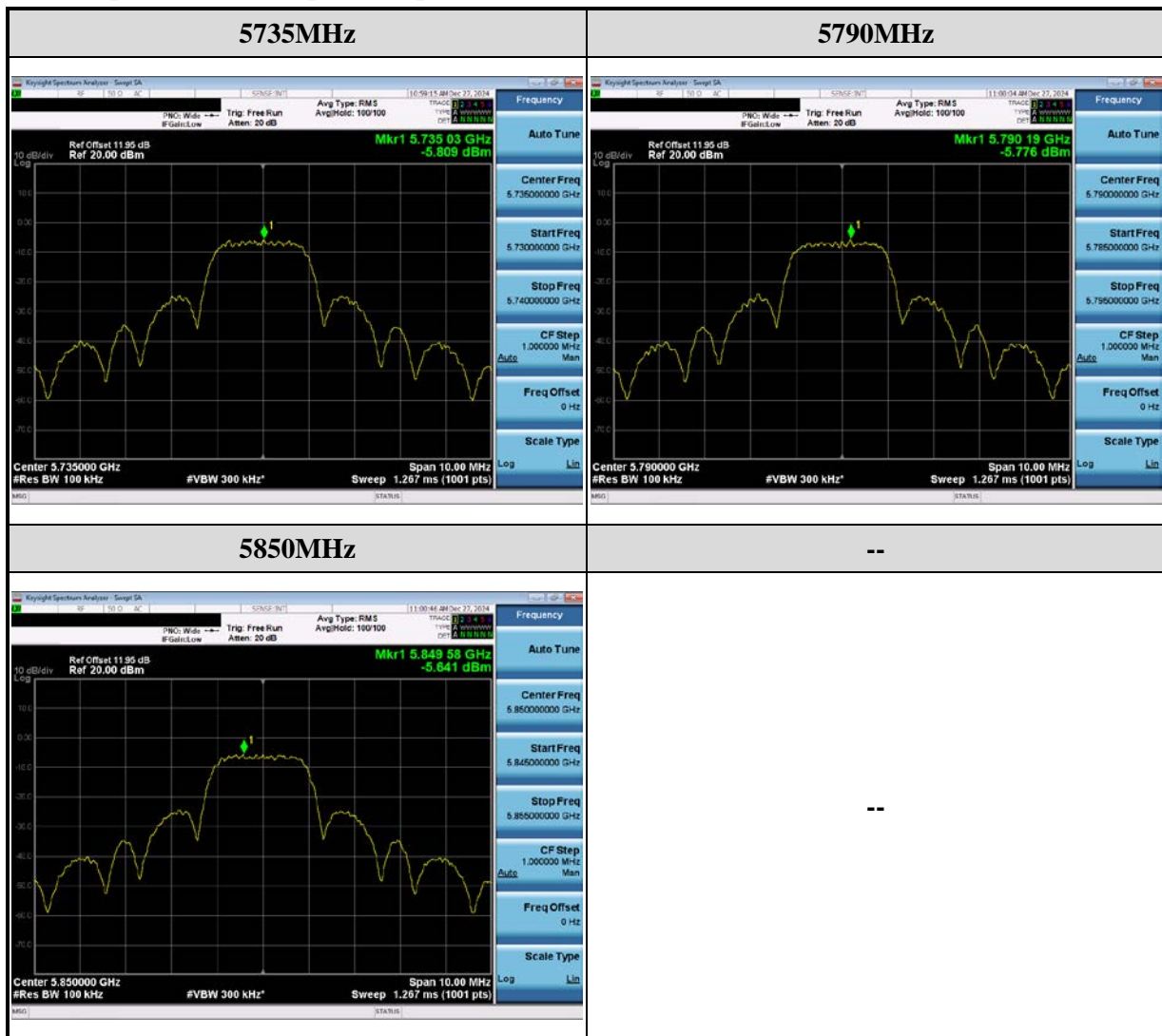
Power Spectral Density spectrum plot of Chain A value:

For 5850 MHz ~ 5895 MHz

Frequency (MHz)	EIRP PSD (dBm/MHz)		Total PSD (dBm/MHz)	EIRP Limit (dBm/MHz)	Result
	Chain A	Chain B			
5850	8.88	--	--	< 14	Pass
5860	10.73	--	--	< 14	Pass
5875	10.01	--	--	< 14	Pass

Remark: PSD = Reading value on a spectrum analyzer + cable loss + duty factor + antenna gain

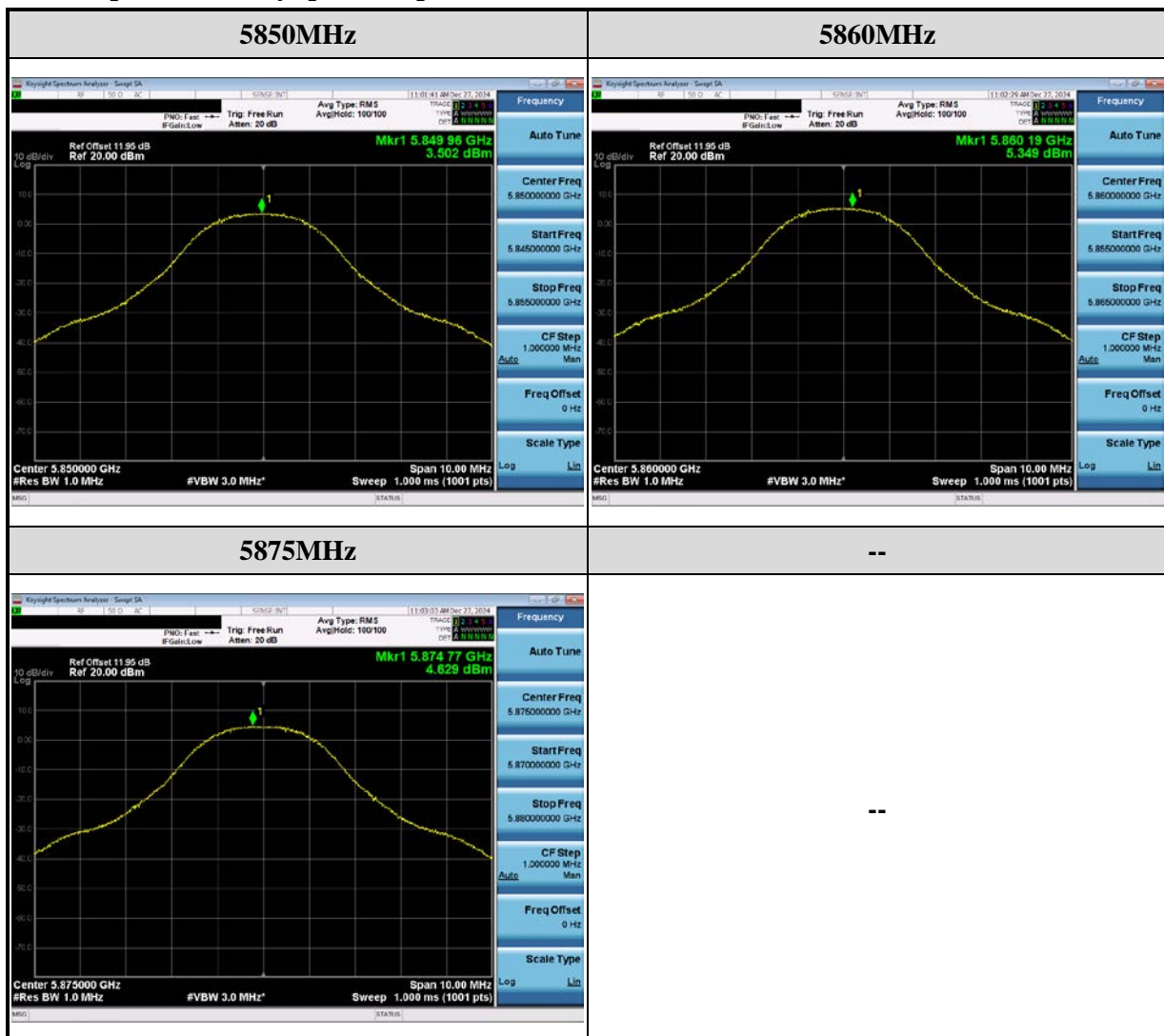
Power Spectral Density spectrum plot of Chain A value:

2.5 Unwanted Emission Measurement

2.5.1 Limit

1. Un- restricted bands unwanted emission limit :

Operating Band (MHz)	Limit of all emissions outside of the operating band
5150 ~ 5250	-27dBm/MHz, EIRP
5250 ~ 5350	-27dBm/MHz, EIRP
5470 ~ 5725	-27dBm/MHz, EIRP
5725 ~ 5850	All emissions shall be limited to a level of -27 dBm/MHz at 75 MHz or more above or below the band edge increasing linearly to 10 dBm/MHz at 25 MHz above or below the band edge, and from 25 MHz above or below the band edge increasing linearly to a level of 15.6 dBm/MHz at 5 MHz above or below the band edge, and from 5 MHz above or below the band edge increasing linearly to a level of 27 dBm/MHz at the band edge.
5850 ~ 5895	<p>(1) For an indoor access point or subordinate device, all emissions at or above 5.895 GHz shall not exceed an e.i.r.p. of 15 dBm/MHz and shall decrease linearly to an e.i.r.p. of -7 dBm/MHz at or above 5.925 GHz.</p> <p>(2) For a client device, all emissions at or above 5.895 GHz shall not exceed an e.i.r.p. of -5 dBm/MHz and shall decrease linearly to an e.i.r.p. of -27 dBm/MHz at or above 5.925 GHz.</p> <p>(3) For a client device or indoor access point or subordinate device, all emissions below 5.725 GHz shall not exceed an e.i.r.p. of -27 dBm/MHz at 5.65 GHz increasing linearly to 10 dBm/ MHz at 5.7 GHz, and from 5.7 GHz increasing linearly to a level of 15.6 dBm/MHz at 5.72 GHz, and from 5.72 GHz increasing linearly to a level of 27 dBm/MHz at 5.725 GHz</p>

EIRP (dBm)	Field Strength at 3m (dBμV/m)
- 27	68.2

2. Restricted bands unwanted emission limit :

Frequency (MHz)	Field Strength ($\mu\text{V/m}$)	Measurement Distance (m)
0.009 – 0.490	2400/F(kHz)	300
0.490 – 1.705	24000/F(kHz)	30
1.705 – 30.0	30	30
30 – 88	100	3
88 – 216	150	3
216 - 960	200	3
Above 960	500	3

Remarks:

1. RF Voltage (dBuV) = 20 log RF Voltage(uV)
2. In the Above Table, the tighter limit applies at the band edges.
3. Distance refers to the distance in meters between the measuring instrument antenna and the closed point of any part of the device or system

2.5.2 Test Setup

Below 30MHz

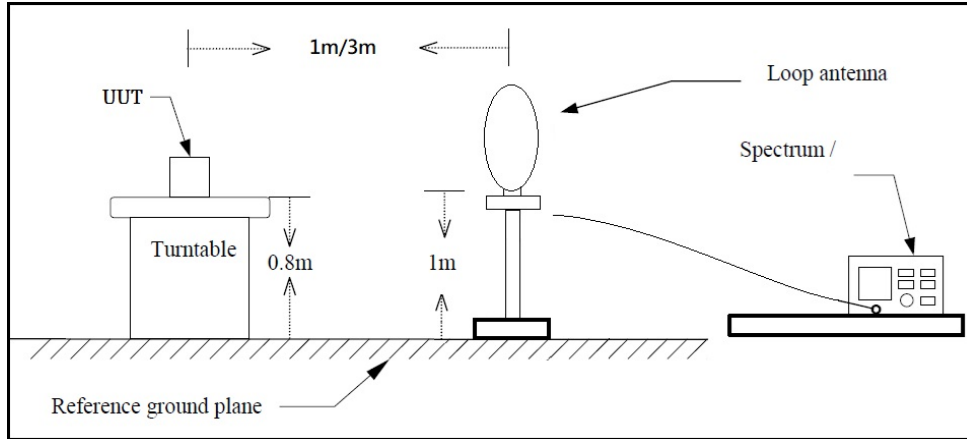

30MHz~1GHz

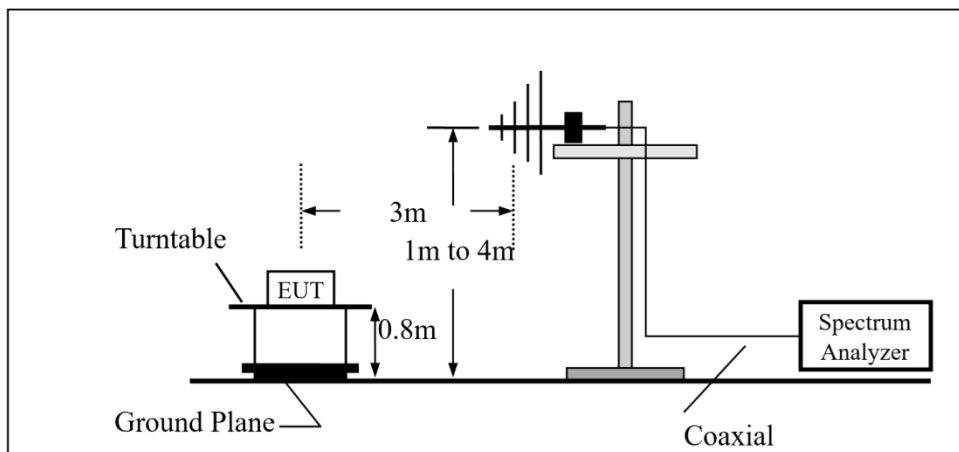

Above 1GHz

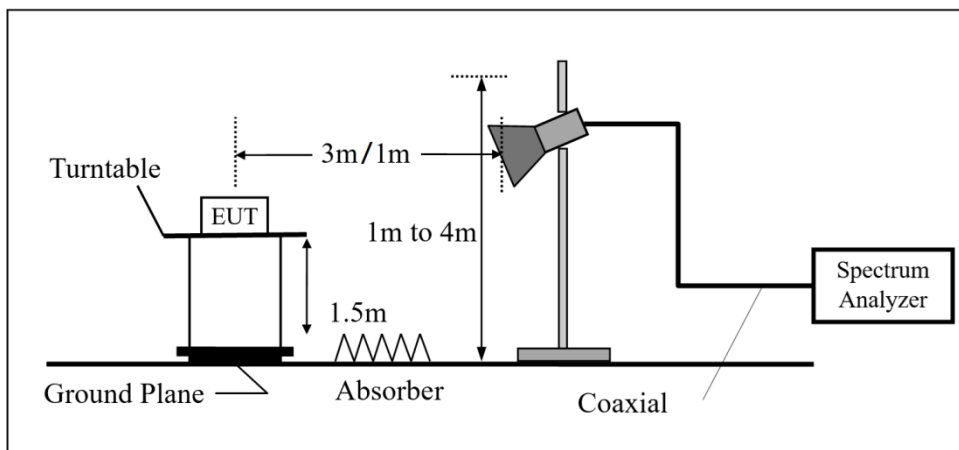

2.5.3 Test Procedure

The EUT was setup according to ANSI C63.10, 2013 and tested according test procedure of KDB 789033 for compliance to FCC 47CFR 15.407 requirements.

For Radiated emission below 30MHz

- (1) The EUT was placed on the top of a rotating table 0.8 meters above the ground in a 3 meter chamber room. The table was rotated 360 degrees to determine the position of the highest radiation.
- (2) The EUT was set 3 meters away from the interference-receiving antenna, which was mounted on the top of a variable-height antenna tower.
- (3) Parallel, perpendicular, and ground-parallel orientations of the antenna are set to make the measurement.
- (4) For each suspected emission, the EUT was arranged to its worst case and the rotatable table was turned from 0 degrees to 360 degrees to find the maximum reading.
- (5) The test-receiver system was set to Quasi-Peak Detect Function and Specified Bandwidth with Maximum Hold Mode.

For Radiated emission Above 30MHz

- (1) The EUT was placed on the top of a rotating table 0.8 meters (for below 1GHz) / 1.5 meters (for above 1GHz) above the ground at 3 meter chamber room for the test. The table was rotated 360 degrees to determine the position of the highest radiation.
- (2) The EUT was set 3 meters away from the interference-receiving antenna, the height of the antenna is varied from 1 meter to 4 meters above the ground to determine the maximum value of the field strength.
- (3) Parallel, perpendicular, and ground-parallel orientations of the antenna are set to make the measurement.
- (4) For each suspected emission, the EUT was arranged to its worst case and the rotatable table was turned from 0 degrees to 360 degrees to find the maximum reading.
- (5) The test-receiver system was set to quasi-peak detect function and specified bandwidth with maximum hold mode when the test frequency is below 1 GHz.
- (6) The test-receiver system was set to peak and average detect function and specified bandwidth with maximum hold mode when the test frequency is above 1 GHz. If the peak reading value also meets the average limit, measurement with the average detector is unnecessary.

2.5.4 Duty Cycle

Type of Modulation	Frequency (MHz)	on time (ms)	on+off time (ms)	Duty cycle	Duty Factor (dB)	1/T Minimum VBW (kHz)
Other 5G	5160	8.740	8.740	1.000	0.000	0.010

2.5.5 Test Result of Radiated Band Edge Measurement

The following tables for radiated measurement, pre-scanned in three orthogonal panels, X, Y, Z. The worst cases (**X** axis) were recorded in this report.

Test Frequency			
RF	5160 ~ 5245MHz	5735 ~ 5850MHz	5850 ~ 5875MHz
Tx	CH00 (5160MHz)	CH00 (5735MHz) CH23 (5850MHz)	CH00 (5850MHz) CH02 (5860MHz) CH05 (5875MHz)

Test Mode :	Transmit (Other 5G 2Mbps)	Test Date :	2025/01/06
Test Channel :	CH00(5160MHz)	Temperature :	20.5 °C
Polarization :	Horizontal	Relative Humidity :	47.5 %

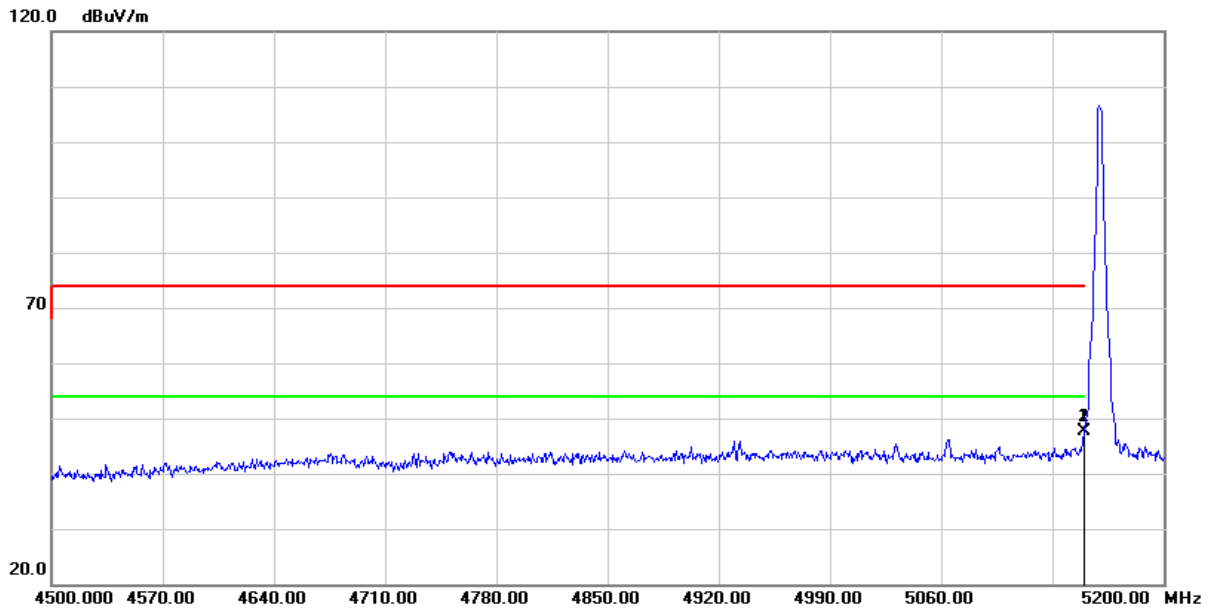

No.	Frequency (MHz)	Reading (dBuV/m)	Correct Factor (dB/m)	Result (dBuV/m)	Limit (dBuV/m)	Margin (dB)	Remark
1	5149.600	45.20	2.46	47.66	74.00	-26.34	peak
2	5150.000	45.27	2.46	47.73	74.00	-26.27	peak

Remark :

1. Correction Factor = Antenna factor + Cable loss – Amplifier gain
2. Result Value = Reading Level + Correct Factor
3. Margin Level = Result Value – Limit Value
4. The other emission levels were very low against the limit

Test Mode :	Transmit (Other 5G 2Mbps)	Test Date :	2025/01/06
Test Channel :	CH00(5160MHz)	Temperature :	20.5 °C
Polarization :	Vertical	Relative Humidity :	47.5 %

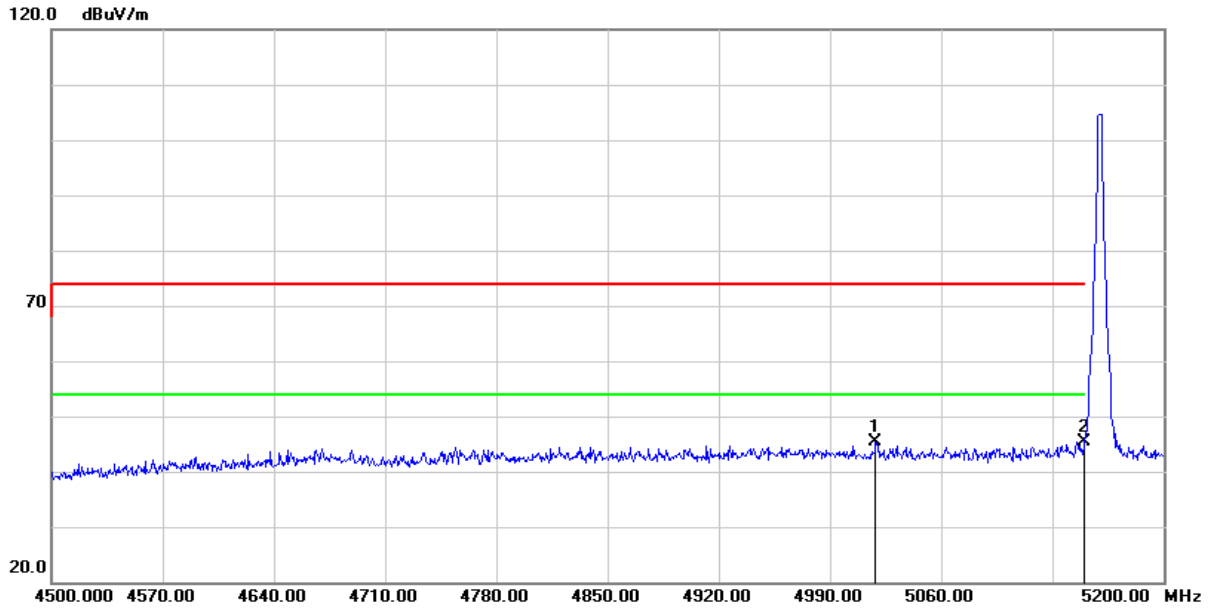

No.	Frequency (MHz)	Reading (dBuV/m)	Correct Factor (dB/m)	Result (dBuV/m)	Limit (dBuV/m)	Margin (dB)	Remark
1	5018.700	43.37	2.06	45.43	74.00	-28.57	peak
2	5150.000	42.91	2.46	45.37	74.00	-28.63	peak

Remark :

1. Correction Factor = Antenna factor + Cable loss – Amplifier gain
2. Result Value = Reading Level + Correct Factor
3. Margin Level = Result Value – Limit Value
4. The other emission levels were very low against the limit

Test Mode :	Transmit (Other 5G 2Mbps)	Test Date :	2025/01/06
Test Channel :	CH00(5735MHz)	Temperature :	20.5 °C
Polarization :	Horizontal	Relative Humidity :	47.5 %

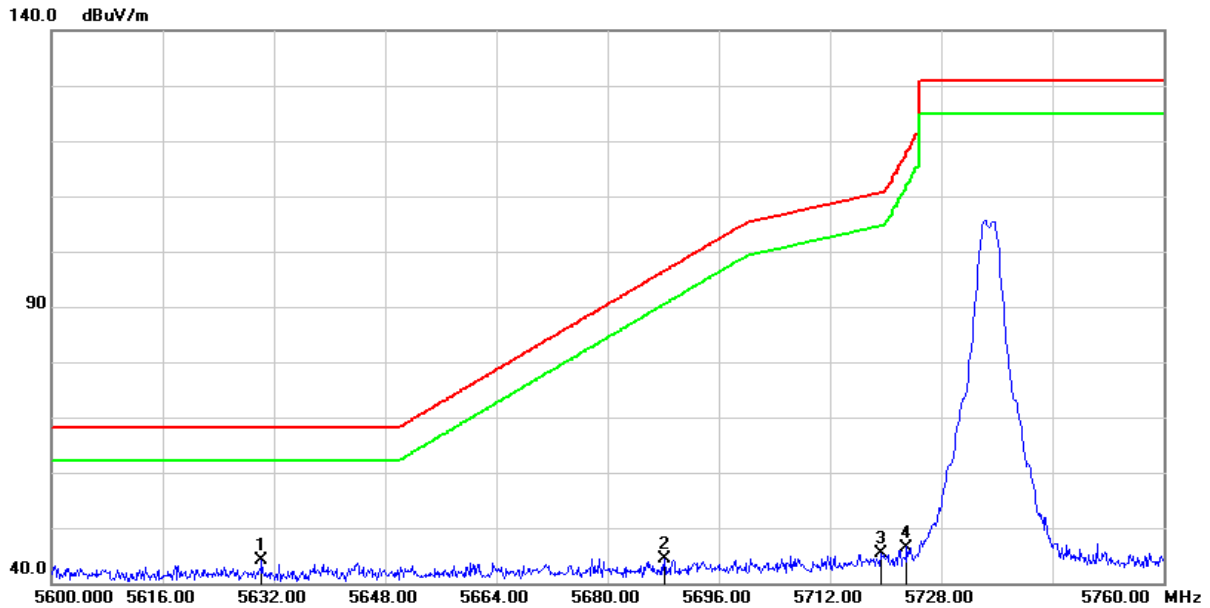

No.	Frequency (MHz)	Reading (dBuV/m)	Correct Factor (dB/m)	Result (dBuV/m)	Limit (dBuV/m)	Margin (dB)	Remark
1	5630.240	41.80	2.24	44.04	68.20	-24.16	peak
2	5688.160	41.87	2.56	44.43	96.44	-52.01	peak
3	5719.360	42.60	2.66	45.26	110.62	-65.36	peak
4	5723.040	43.83	2.67	46.50	117.73	-71.23	peak

Remark :

1. Correction Factor = Antenna factor + Cable loss – Amplifier gain
2. Result Value = Reading Level + Correct Factor
3. Margin Level = Result Value – Limit Value
4. The other emission levels were very low against the limit

Test Mode :	Transmit (Other 5G 2Mbps)	Test Date :	2025/01/06
Test Channel :	CH00(5735MHz)	Temperature :	20.5 °C
Polarization :	Vertical	Relative Humidity :	47.5 %

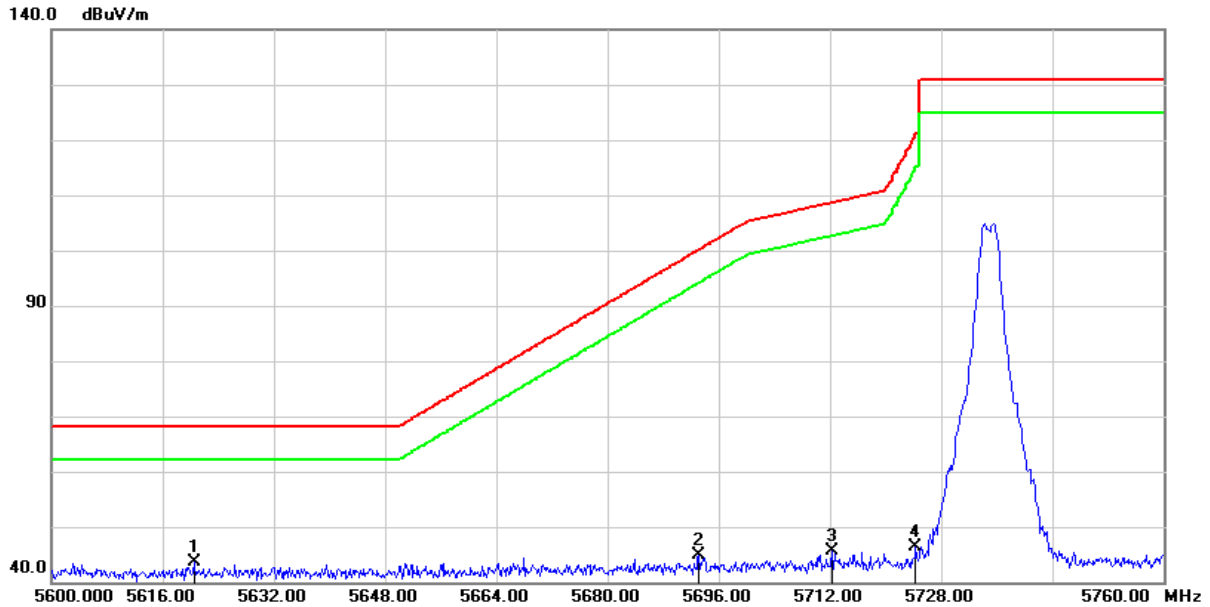

No.	Frequency (MHz)	Reading (dBuV/m)	Correct Factor (dB/m)	Result (dBuV/m)	Limit (dBuV/m)	Margin (dB)	Remark
1	5620.480	41.39	2.21	43.60	68.20	-24.60	peak
2	5693.120	42.33	2.60	44.93	100.11	-55.18	peak
3	5712.320	42.86	2.65	45.51	108.65	-63.14	peak
4	5724.320	43.65	2.67	46.32	120.65	-74.33	peak

Remark :

1. Correction Factor = Antenna factor + Cable loss – Amplifier gain
2. Result Value = Reading Level + Correct Factor
3. Margin Level = Result Value – Limit Value
4. The other emission levels were very low against the limit

Test Mode :	Transmit (Other 5G 2Mbps)	Test Date :	2025/01/06
Test Channel :	CH23(5850MHz)	Temperature :	20.5 °C
Polarization :	Horizontal	Relative Humidity :	47.5 %

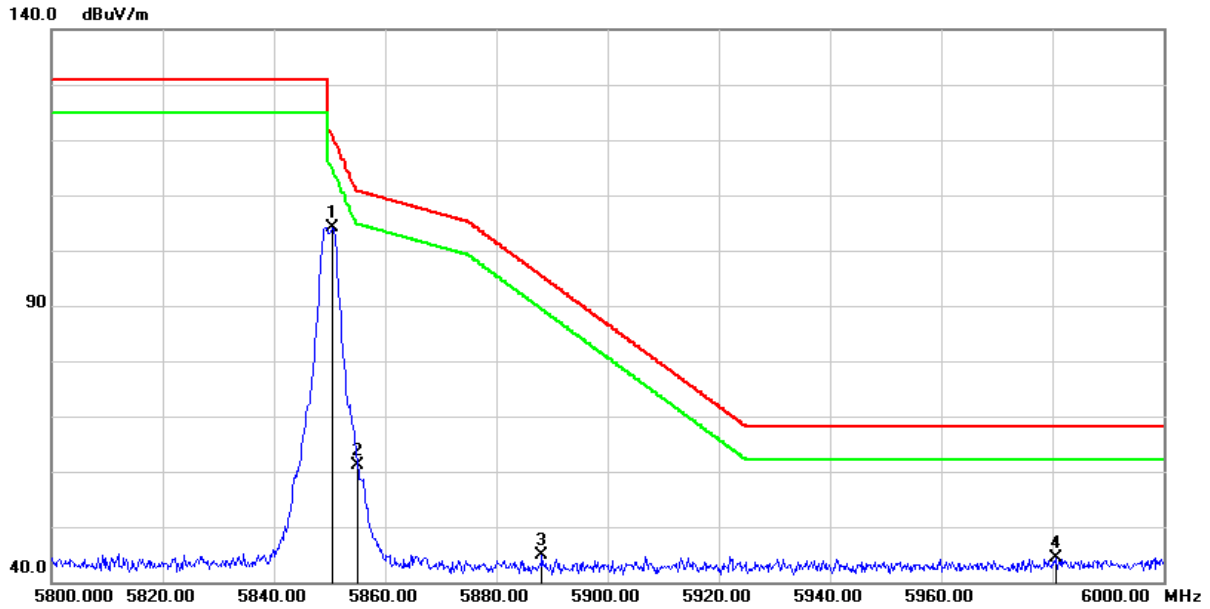

No.	Frequency (MHz)	Reading (dBuV/m)	Correct Factor (dB/m)	Result (dBuV/m)	Limit (dBuV/m)	Margin (dB)	Remark
1	5850.600	101.15	2.88	104.03	120.83	-16.80	peak
2	5855.000	58.26	2.90	61.16	110.80	-49.64	peak
3	5888.200	41.90	3.05	44.95	95.43	-50.48	peak
4	5980.600	41.21	3.25	44.46	68.20	-23.74	peak

Remark :

1. Correction Factor = Antenna factor + Cable loss – Amplifier gain
2. Result Value = Reading Level + Correct Factor
3. Margin Level = Result Value – Limit Value
4. The other emission levels were very low against the limit

Test Mode :	Transmit (Other 5G 2Mbps)	Test Date :	2025/01/06
Test Channel :	CH23(5850MHz)	Temperature :	20.5 °C
Polarization :	Vertical	Relative Humidity :	47.5 %

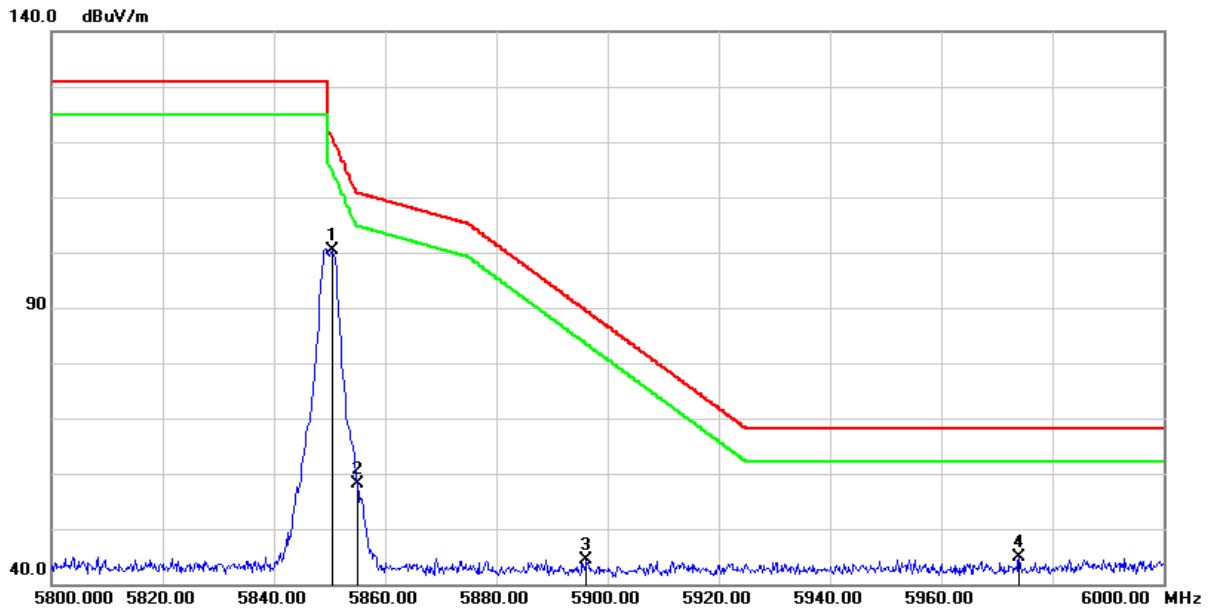

No.	Frequency (MHz)	Reading (dBuV/m)	Correct Factor (dB/m)	Result (dBuV/m)	Limit (dBuV/m)	Margin (dB)	Remark
1	5850.400	97.54	2.88	100.42	121.29	-20.87	peak
2	5855.000	55.12	2.90	58.02	110.80	-52.78	peak
3	5896.200	41.22	3.09	44.31	89.51	-45.20	peak
4	5974.000	41.70	3.23	44.93	68.20	-23.27	peak

Remark :

1. Correction Factor = Antenna factor + Cable loss – Amplifier gain
2. Result Value = Reading Level + Correct Factor
3. Margin Level = Result Value – Limit Value
4. The other emission levels were very low against the limit

Test Mode :	Transmit (Other 5G 2Mbps)	Test Date :	2025/01/06
Test Channel :	CH00(5850MHz)	Temperature :	20.5 °C
Polarization :	Horizontal	Relative Humidity :	47.5 %

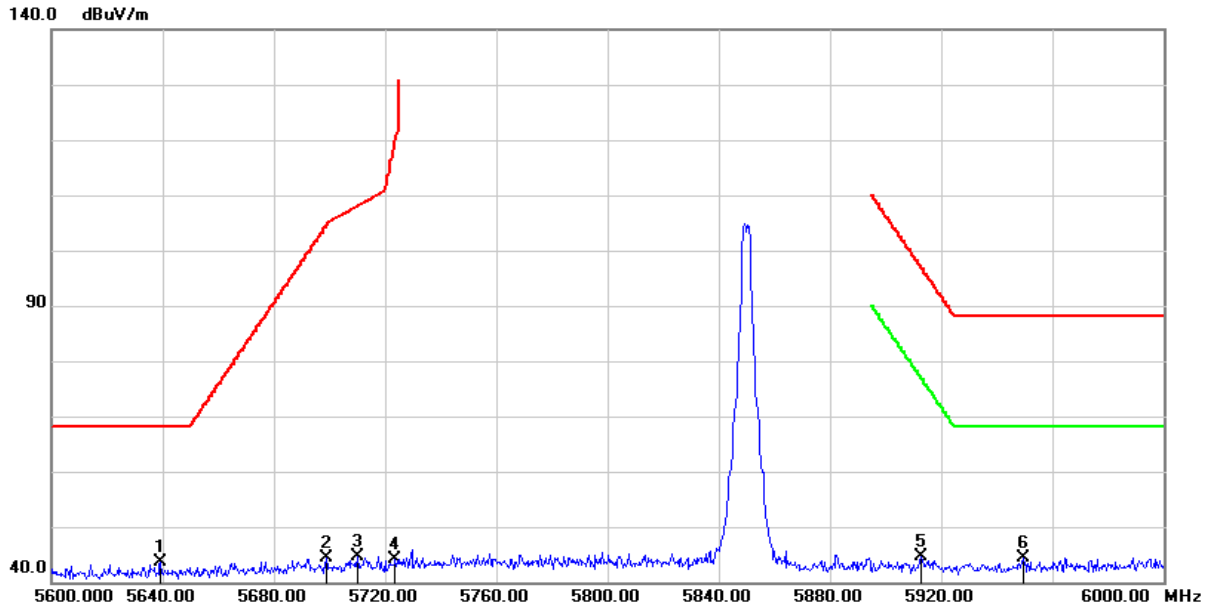

No.	Frequency (MHz)	Reading (dBuV/m)	Correct Factor (dB/m)	Result (dBuV/m)	Limit (dBuV/m)	Margin (dB)	Remark
1	5639.200	41.43	2.27	43.70	68.20	-24.50	peak
2	5698.800	41.71	2.63	44.34	104.31	-59.97	peak
3	5710.000	42.00	2.65	44.65	108.00	-63.35	peak
4	5723.600	41.41	2.67	44.08	119.01	-74.93	peak
5	5912.800	41.58	3.13	44.71	97.15	-52.44	peak
6	5949.600	41.32	3.15	44.47	88.20	-43.73	peak

Remark :

1. Correction Factor = Antenna factor + Cable loss – Amplifier gain
2. Result Value = Reading Level + Correct Factor
3. Margin Level = Result Value – Limit Value
4. The other emission levels were very low against the limit

Test Mode :	Transmit (Other 5G 2Mbps)	Test Date :	2025/01/06
Test Channel :	CH00(5850MHz)	Temperature :	20.5 °C
Polarization :	Vertical	Relative Humidity :	47.5 %

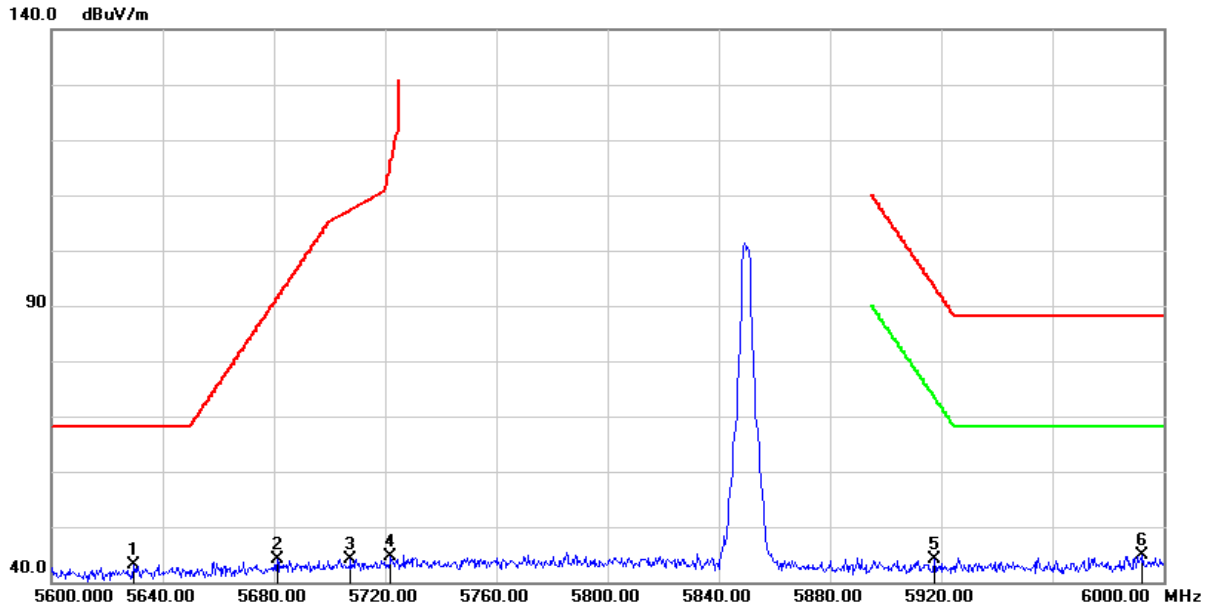

No.	Frequency (MHz)	Reading (dBuV/m)	Correct Factor (dB/m)	Result (dBuV/m)	Limit (dBuV/m)	Margin (dB)	Remark
1	5629.600	41.00	2.24	43.24	68.20	-24.96	peak
2	5681.200	41.49	2.52	44.01	91.29	-47.28	peak
3	5707.600	41.50	2.65	44.15	107.33	-63.18	peak
4	5722.000	42.02	2.67	44.69	115.36	-70.67	peak
5	5917.600	40.92	3.13	44.05	93.63	-49.58	peak
6	5992.400	41.49	3.27	44.76	88.20	-43.44	peak

Remark :

1. Correction Factor = Antenna factor + Cable loss – Amplifier gain
2. Result Value = Reading Level + Correct Factor
3. Margin Level = Result Value – Limit Value
4. The other emission levels were very low against the limit

Test Mode :	Transmit (Other 5G 2Mbps)	Test Date :	2025/01/06
Test Channel :	CH02(5860MHz)	Temperature :	20.5 °C
Polarization :	Horizontal	Relative Humidity :	47.5 %

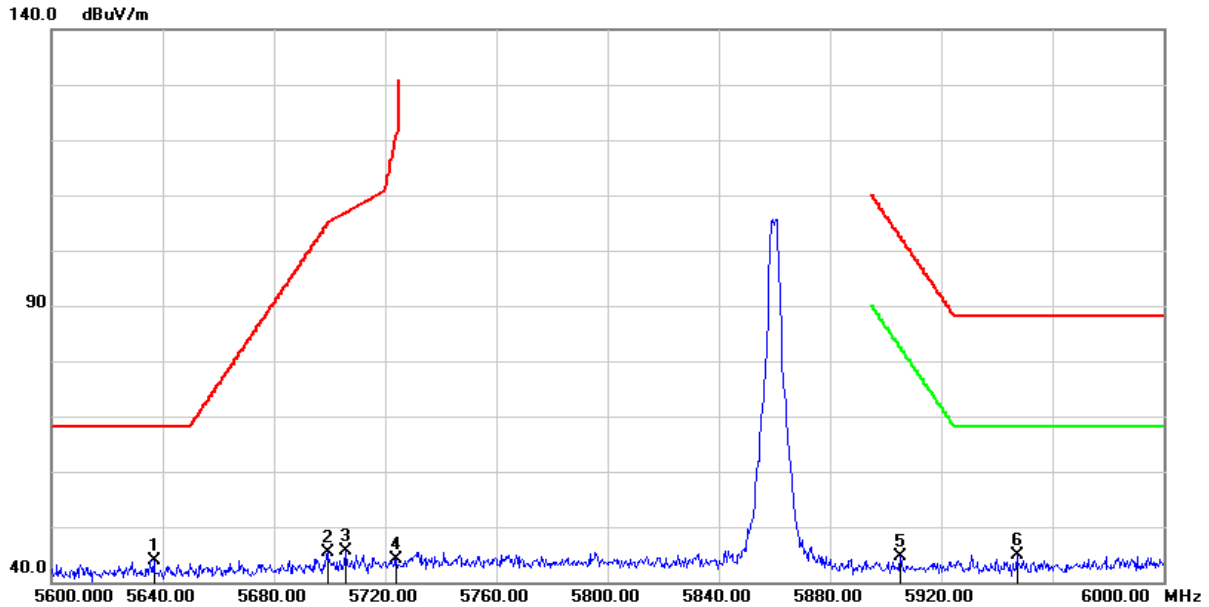

No.	Frequency (MHz)	Reading (dBuV/m)	Correct Factor (dB/m)	Result (dBuV/m)	Limit (dBuV/m)	Margin (dB)	Remark
1	5636.800	41.53	2.26	43.79	68.20	-24.41	peak
2	5699.200	42.85	2.64	45.49	104.61	-59.12	peak
3	5706.000	43.00	2.64	45.64	106.88	-61.24	peak
4	5724.000	41.49	2.67	44.16	119.92	-75.76	peak
5	5905.200	41.44	3.11	44.55	102.72	-58.17	peak
6	5947.200	41.80	3.15	44.95	88.20	-43.25	peak

Remark :

1. Correction Factor = Antenna factor + Cable loss – Amplifier gain
2. Result Value = Reading Level + Correct Factor
3. Margin Level = Result Value – Limit Value
4. The other emission levels were very low against the limit

Test Mode :	Transmit (Other 5G 2Mbps)	Test Date :	2025/01/06
Test Channel :	CH02(5860MHz)	Temperature :	20.5 °C
Polarization :	Vertical	Relative Humidity :	47.5 %

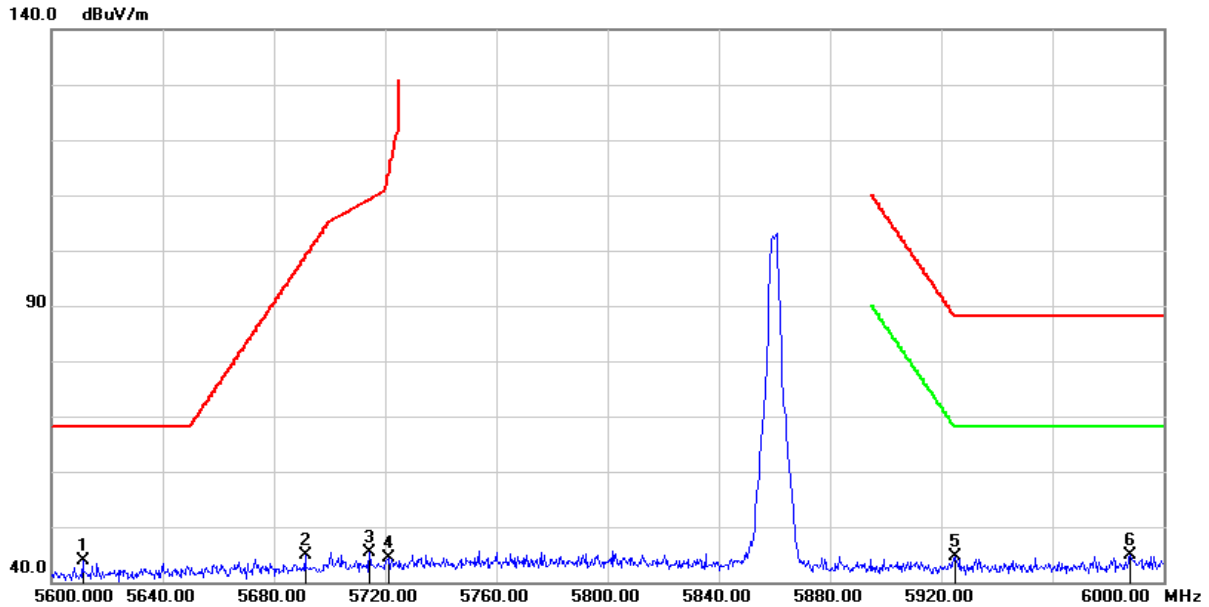

No.	Frequency (MHz)	Reading (dBuV/m)	Correct Factor (dB/m)	Result (dBuV/m)	Limit (dBuV/m)	Margin (dB)	Remark
1	5611.200	41.61	2.19	43.80	68.20	-24.40	peak
2	5691.200	42.41	2.58	44.99	98.69	-53.70	peak
3	5714.400	42.65	2.65	45.30	109.23	-63.93	peak
4	5721.200	41.62	2.66	44.28	113.54	-69.26	peak
5	5924.800	41.50	3.14	44.64	88.35	-43.71	peak
6	5988.000	41.66	3.27	44.93	88.20	-43.27	peak

Remark :

1. Correction Factor = Antenna factor + Cable loss – Amplifier gain
2. Result Value = Reading Level + Correct Factor
3. Margin Level = Result Value – Limit Value
4. The other emission levels were very low against the limit

Test Mode :	Transmit (Other 5G 2Mbps)	Test Date :	2025/01/06
Test Channel :	CH05(5875MHz)	Temperature :	20.5 °C
Polarization :	Horizontal	Relative Humidity :	47.5 %

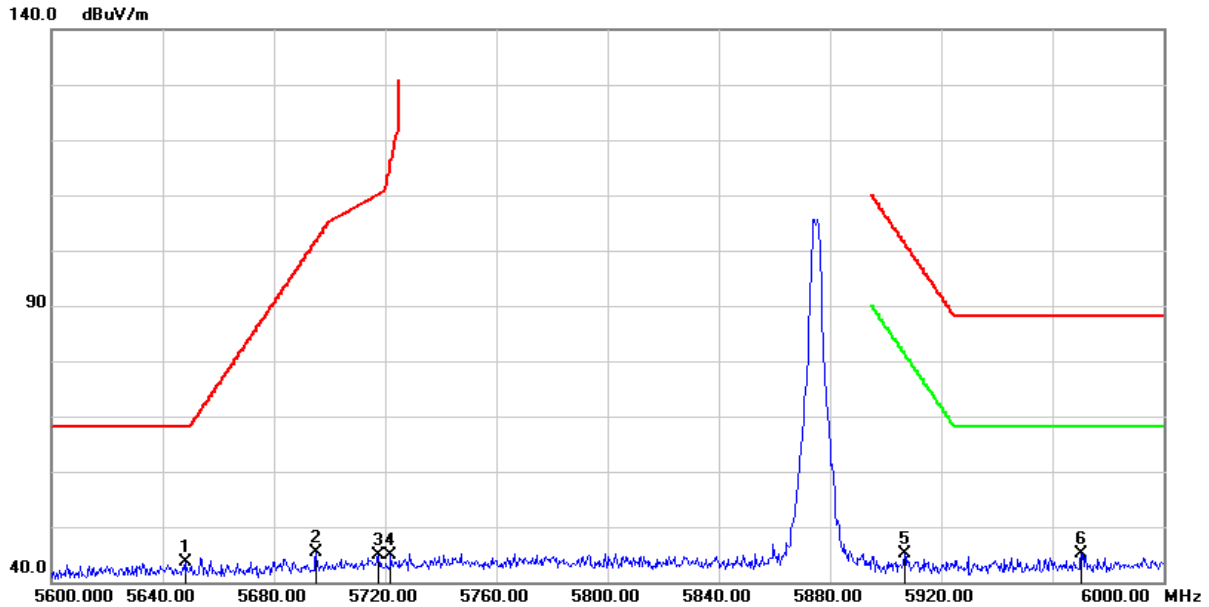

No.	Frequency (MHz)	Reading (dBuV/m)	Correct Factor (dB/m)	Result (dBuV/m)	Limit (dBuV/m)	Margin (dB)	Remark
1	5648.400	41.23	2.29	43.52	68.20	-24.68	peak
2	5695.200	42.83	2.61	45.44	101.65	-56.21	peak
3	5717.600	42.20	2.65	44.85	110.13	-65.28	peak
4	5722.000	42.28	2.67	44.95	115.36	-70.41	peak
5	5906.800	41.92	3.12	45.04	101.55	-56.51	peak
6	5970.400	42.02	3.22	45.24	88.20	-42.96	peak

Remark :

1. Correction Factor = Antenna factor + Cable loss – Amplifier gain
2. Result Value = Reading Level + Correct Factor
3. Margin Level = Result Value – Limit Value
4. The other emission levels were very low against the limit

Test Mode :	Transmit (Other 5G 2Mbps)	Test Date :	2025/01/06
Test Channel :	CH05(5875MHz)	Temperature :	20.5 °C
Polarization :	Vertical	Relative Humidity :	47.5 %

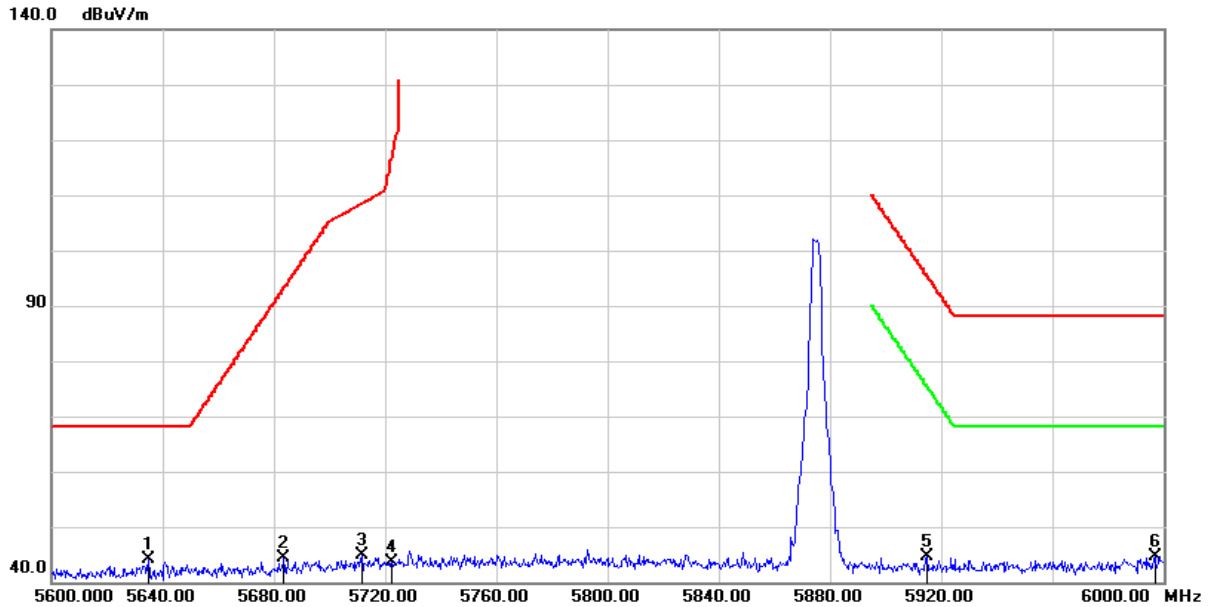

No.	Frequency (MHz)	Reading (dBuV/m)	Correct Factor (dB/m)	Result (dBuV/m)	Limit (dBuV/m)	Margin (dB)	Remark
1	5634.800	41.98	2.25	44.23	68.20	-23.97	peak
2	5683.600	41.91	2.53	44.44	93.06	-48.62	peak
3	5711.600	42.19	2.65	44.84	108.45	-63.61	peak
4	5722.400	40.97	2.67	43.64	116.27	-72.63	peak
5	5914.800	41.41	3.13	44.54	95.68	-51.14	peak
6	5996.800	41.38	3.29	44.67	88.20	-43.53	peak

Remark :

1. Correction Factor = Antenna factor + Cable loss – Amplifier gain
2. Result Value = Reading Level + Correct Factor
3. Margin Level = Result Value – Limit Value
4. The other emission levels were very low against the limit

2.5.6 Test Result of Radiated Spurious Emission Measurement

- (1) The radiation measurement frequency is 9kHz ~ 30MHz. The interference value of this frequency range is less than the limit value of 20 dB. It is considered that the background noise value is not recorded.
- (2) The following table shows the radiation measurement frequency from 30MHz to 40GHz, pre-scanning in the X, Y and Z axes. The worst case (X-axis) is documented in this report.

Test Frequency			
RF	5160 ~ 5245MHz	5735 ~ 5850MHz	5850 ~ 5875MHz
Tx	CH00 (5160MHz) CH09 (5205MHz) CH17 (5245MHz)	CH00 (5735MHz) CH11 (5790MHz) CH23 (5850MHz)	CH00 (5850MHz) CH02 (5860MHz) CH05 (5875MHz)

Above 1GHz Data

Test Mode :	Transmit (Other 5G 2Mbps)	Test Date :	2025/01/06
Test Channel :	CH00(5160MHz)	Temperature :	20.5 °C
Polarization :	Horizontal	Relative Humidity :	47.5 %

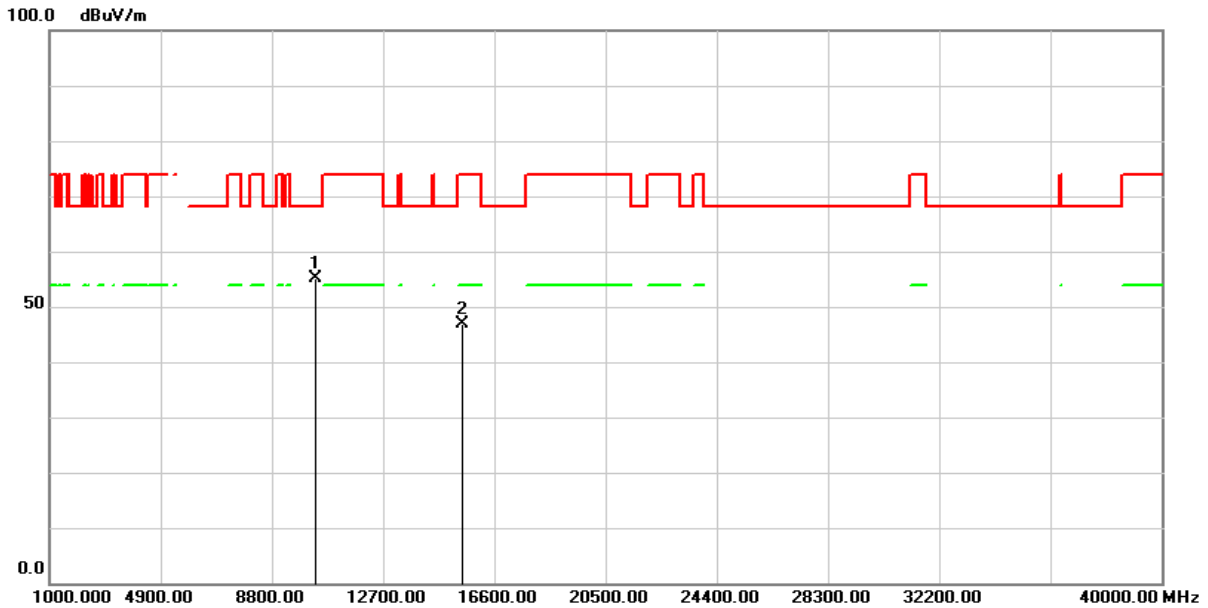

No.	Frequency (MHz)	Reading (dBuV/m)	Correct Factor (dB/m)	Result (dBuV/m)	Limit (dBuV/m)	Margin (dB)	Remark
1	10320.000	66.73	-11.51	55.22	68.20	-12.98	peak
2	15480.000	56.23	-9.23	47.00	74.00	-27.00	peak

Remark :

1. Correction Factor = Antenna factor + Cable loss – Amplifier gain
2. Result Value = Reading Level + Correct Factor
3. Margin Level = Result Value – Limit Value
4. The other emission levels were very low against the limit

Test Mode :	Transmit (Other 5G 2Mbps)	Test Date :	2025/01/06
Test Channel :	CH00(5160MHz)	Temperature :	20.5 °C
Polarization :	Vertical	Relative Humidity :	47.5 %

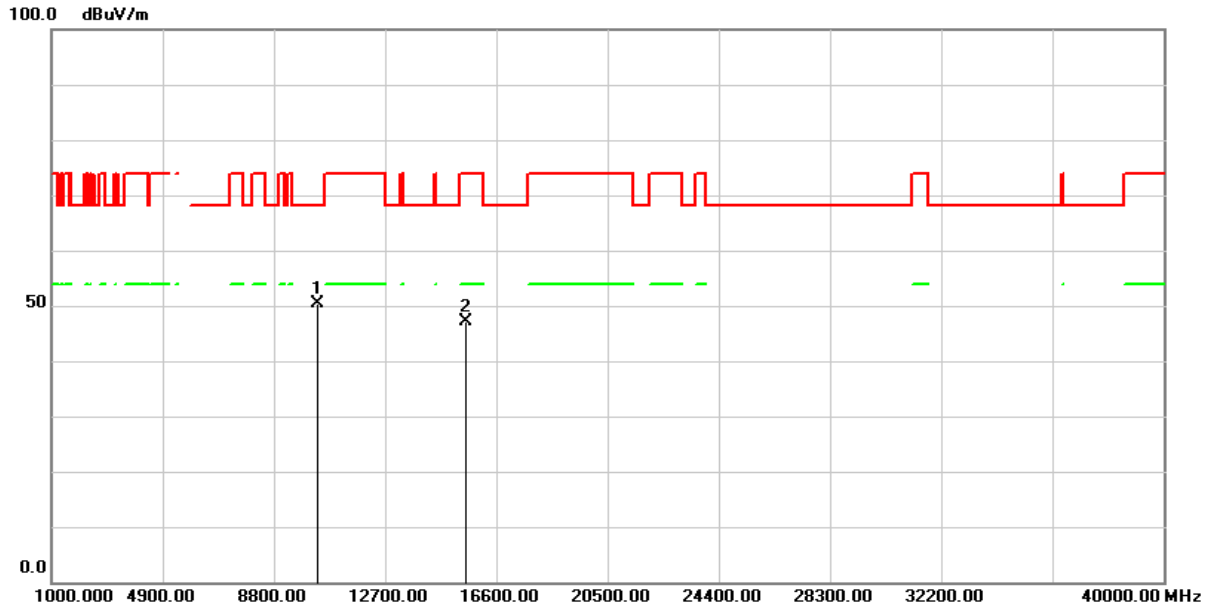

No.	Frequency (MHz)	Reading (dBuV/m)	Correct Factor (dB/m)	Result (dBuV/m)	Limit (dBuV/m)	Margin (dB)	Remark
1	10320.000	61.81	-11.51	50.30	68.20	-17.90	peak
2	15480.000	56.35	-9.23	47.12	74.00	-26.88	peak

Remark :

1. Correction Factor = Antenna factor + Cable loss – Amplifier gain
2. Result Value = Reading Level + Correct Factor
3. Margin Level = Result Value – Limit Value
4. The other emission levels were very low against the limit

Test Mode :	Transmit (Other 5G 2Mbps)	Test Date :	2025/01/06
Test Channel :	CH09(5205MHz)	Temperature :	20.5 °C
Polarization :	Horizontal	Relative Humidity :	47.5 %

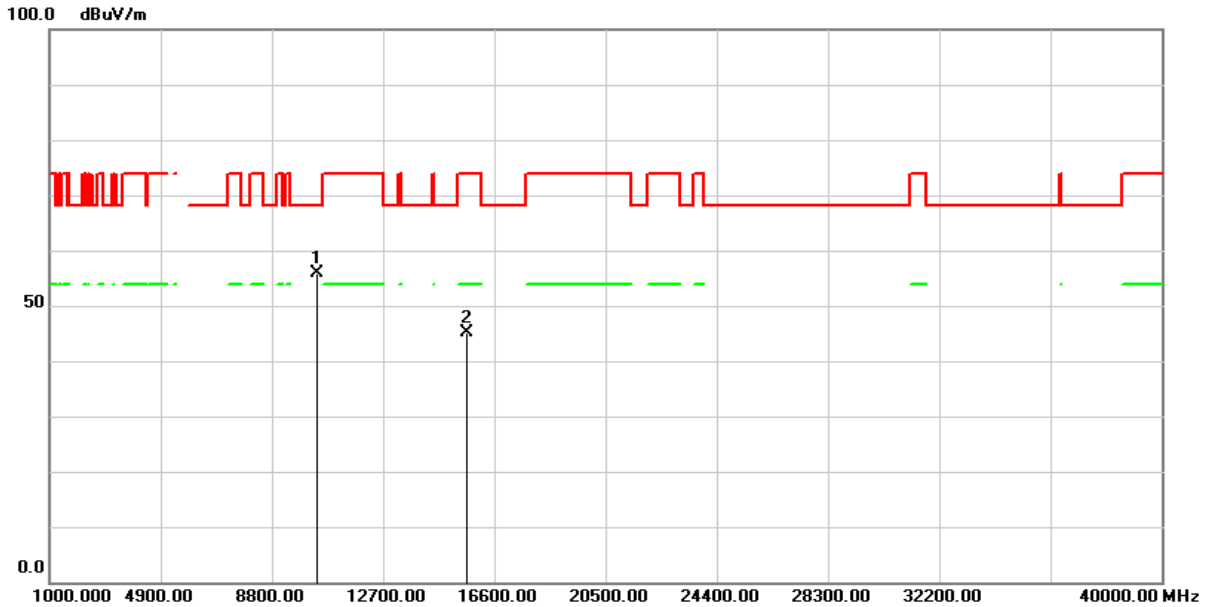

No.	Frequency (MHz)	Reading (dBuV/m)	Correct Factor (dB/m)	Result (dBuV/m)	Limit (dBuV/m)	Margin (dB)	Remark
1	10410.000	67.32	-11.37	55.95	68.20	-12.25	peak
2	15615.000	54.63	-9.49	45.14	74.00	-28.86	peak

Remark :

1. Correction Factor = Antenna factor + Cable loss – Amplifier gain
2. Result Value = Reading Level + Correct Factor
3. Margin Level = Result Value – Limit Value
4. The other emission levels were very low against the limit

Test Mode :	Transmit (Other 5G 2Mbps)	Test Date :	2025/01/06
Test Channel :	CH09(5205MHz)	Temperature :	20.5 °C
Polarization :	Vertical	Relative Humidity :	47.5 %

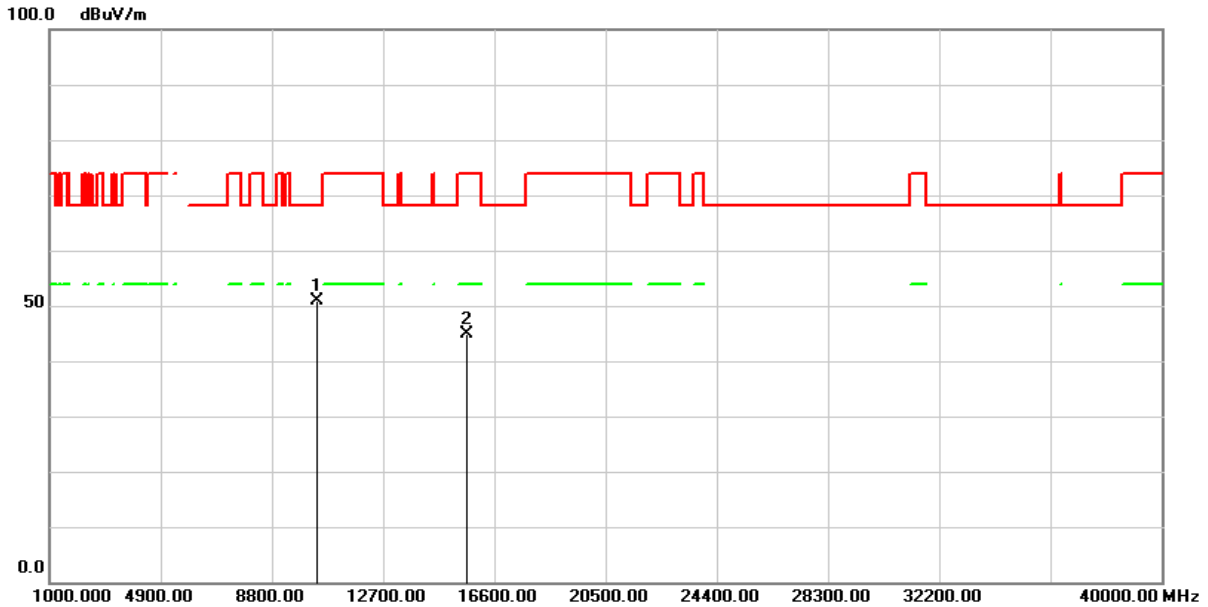

No.	Frequency (MHz)	Reading (dBuV/m)	Correct Factor (dB/m)	Result (dBuV/m)	Limit (dBuV/m)	Margin (dB)	Remark
1	10410.000	62.32	-11.37	50.95	68.20	-17.25	peak
2	15615.000	54.48	-9.49	44.99	74.00	-29.01	peak

Remark :

1. Correction Factor = Antenna factor + Cable loss – Amplifier gain
2. Result Value = Reading Level + Correct Factor
3. Margin Level = Result Value – Limit Value
4. The other emission levels were very low against the limit

Test Mode :	Transmit (Other 5G 2Mbps)	Test Date :	2025/01/06
Test Channel :	CH17(5245MHz)	Temperature :	20.5 °C
Polarization :	Horizontal	Relative Humidity :	47.5 %

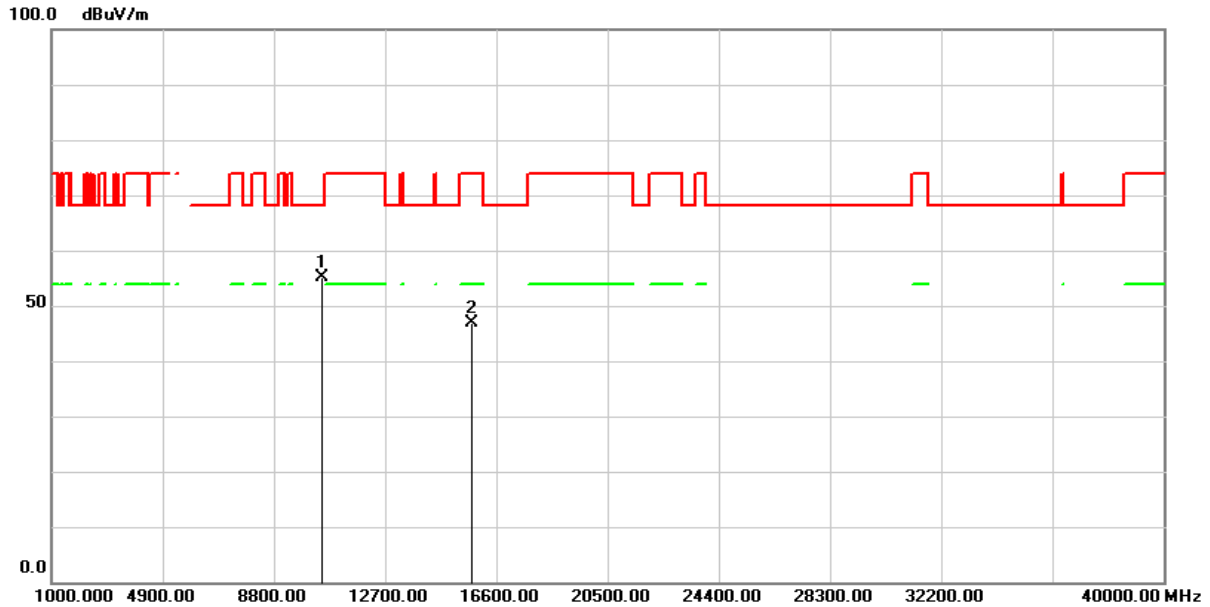

No.	Frequency (MHz)	Reading (dBuV/m)	Correct Factor (dB/m)	Result (dBuV/m)	Limit (dBuV/m)	Margin (dB)	Remark
1	10490.000	66.52	-11.35	55.17	68.20	-13.03	peak
2	15735.000	55.96	-9.09	46.87	74.00	-27.13	peak

Remark :

1. Correction Factor = Antenna factor + Cable loss – Amplifier gain
2. Result Value = Reading Level + Correct Factor
3. Margin Level = Result Value – Limit Value
4. The other emission levels were very low against the limit

Test Mode :	Transmit (Other 5G 2Mbps)	Test Date :	2025/01/06
Test Channel :	CH17(5245MHz)	Temperature :	20.5 °C
Polarization :	Vertical	Relative Humidity :	47.5 %

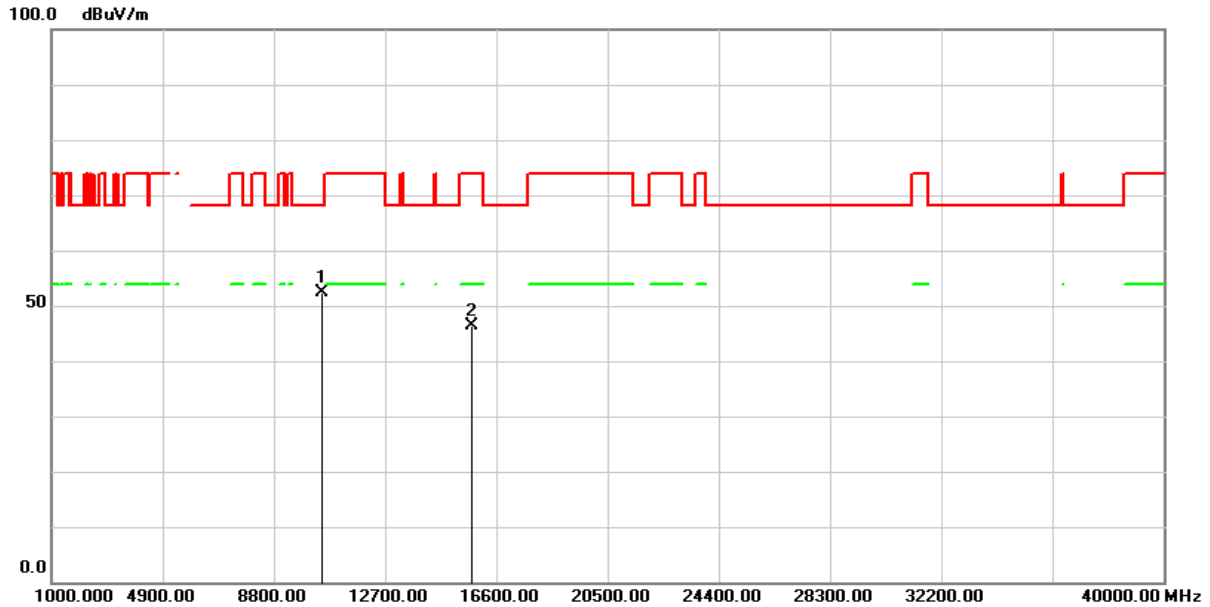

No.	Frequency (MHz)	Reading (dBuV/m)	Correct Factor (dB/m)	Result (dBuV/m)	Limit (dBuV/m)	Margin (dB)	Remark
1	10490.000	63.66	-11.35	52.31	68.20	-15.89	peak
2	15735.000	55.49	-9.09	46.40	74.00	-27.60	peak

Remark :

1. Correction Factor = Antenna factor + Cable loss – Amplifier gain
2. Result Value = Reading Level + Correct Factor
3. Margin Level = Result Value – Limit Value
4. The other emission levels were very low against the limit

Test Mode :	Transmit (Other 5G 2Mbps)	Test Date :	2025/01/06
Test Channel :	CH00(5735MHz)	Temperature :	20.5 °C
Polarization :	Horizontal	Relative Humidity :	47.5 %

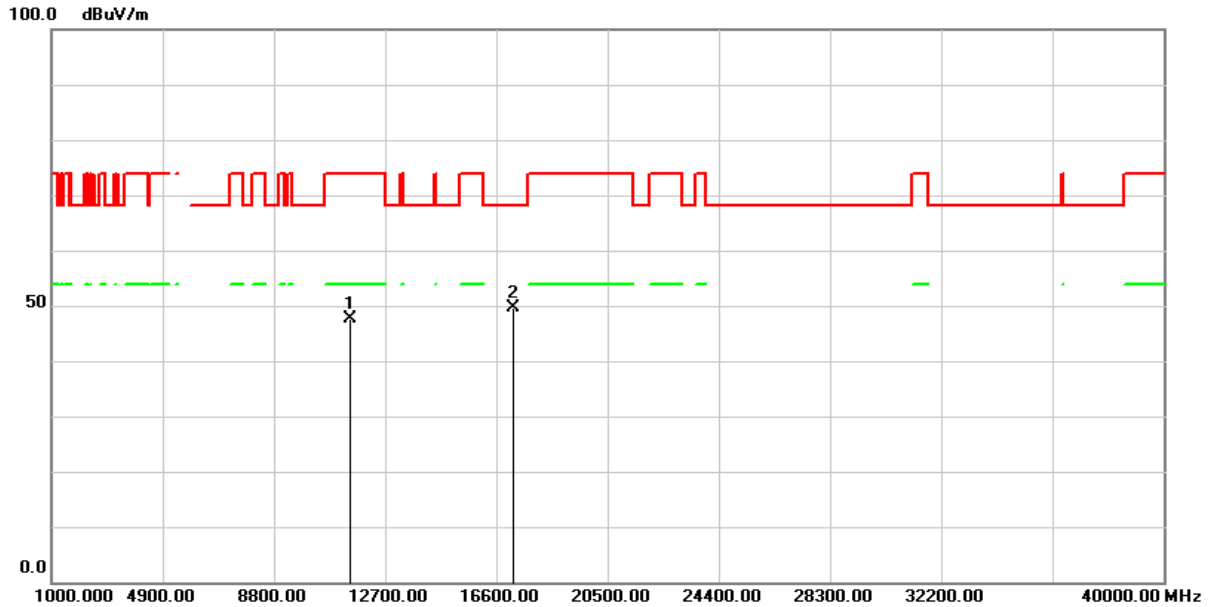

No.	Frequency (MHz)	Reading (dBuV/m)	Correct Factor (dB/m)	Result (dBuV/m)	Limit (dBuV/m)	Margin (dB)	Remark
1	11470.000	58.64	-10.91	47.73	74.00	-26.27	peak
2	17205.000	53.56	-3.97	49.59	68.20	-18.61	peak

Remark :

1. Correction Factor = Antenna factor + Cable loss – Amplifier gain
2. Result Value = Reading Level + Correct Factor
3. Margin Level = Result Value – Limit Value
4. The other emission levels were very low against the limit

Test Mode :	Transmit (Other 5G 2Mbps)	Test Date :	2025/01/06
Test Channel :	CH00(5735MHz)	Temperature :	20.5 °C
Polarization :	Vertical	Relative Humidity :	47.5 %

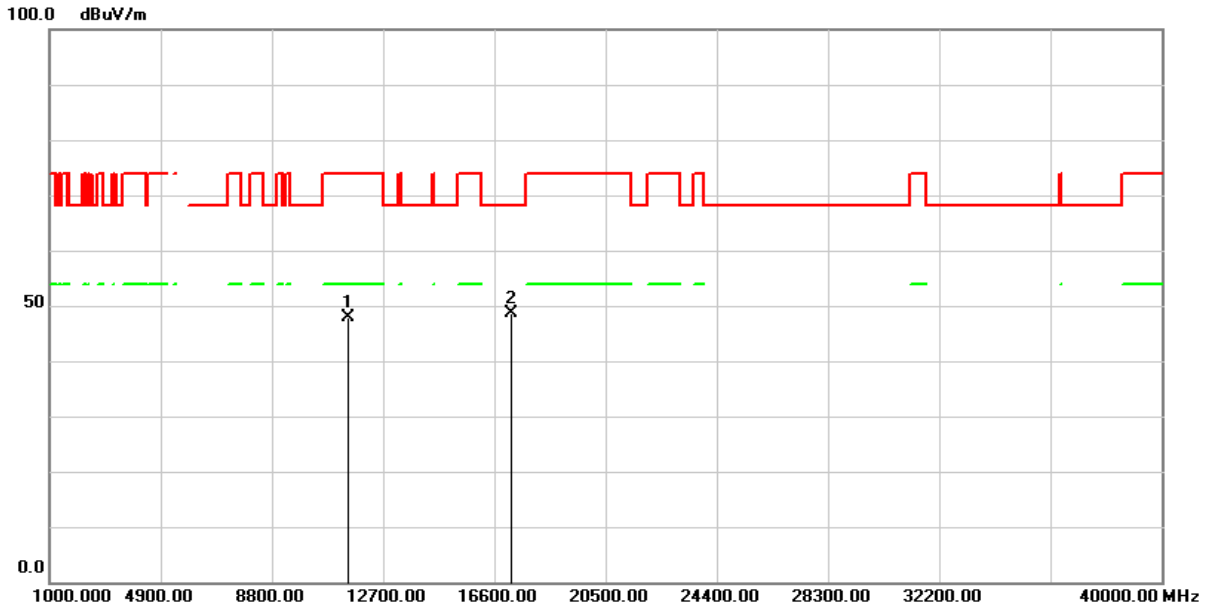

No.	Frequency (MHz)	Reading (dBuV/m)	Correct Factor (dB/m)	Result (dBuV/m)	Limit (dBuV/m)	Margin (dB)	Remark
1	11470.000	58.77	-10.91	47.86	74.00	-26.14	peak
2	17205.000	52.56	-3.97	48.59	68.20	-19.61	peak

Remark :

1. Correction Factor = Antenna factor + Cable loss – Amplifier gain
2. Result Value = Reading Level + Correct Factor
3. Margin Level = Result Value – Limit Value
4. The other emission levels were very low against the limit

Test Mode :	Transmit (Other 5G 2Mbps)	Test Date :	2025/01/06
Test Channel :	CH11(5790MHz)	Temperature :	20.5 °C
Polarization :	Horizontal	Relative Humidity :	47.5 %

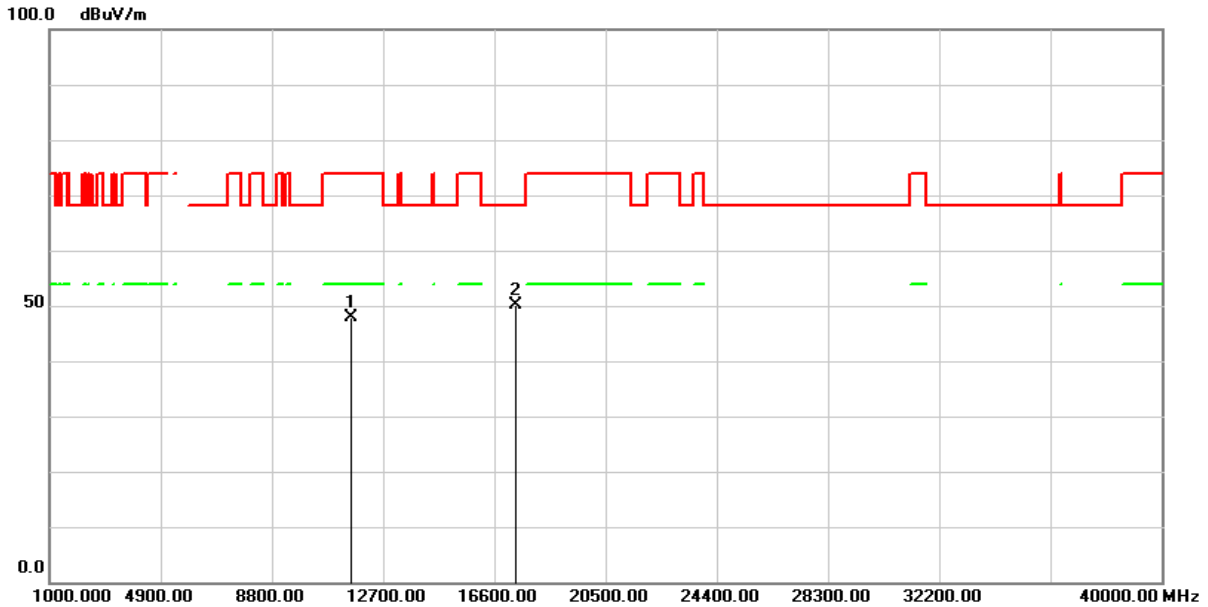

No.	Frequency (MHz)	Reading (dBuV/m)	Correct Factor (dB/m)	Result (dBuV/m)	Limit (dBuV/m)	Margin (dB)	Remark
1	11580.000	58.86	-10.96	47.90	74.00	-26.10	peak
2	17370.000	53.30	-3.21	50.09	68.20	-18.11	peak

Remark :

1. Correction Factor = Antenna factor + Cable loss – Amplifier gain
2. Result Value = Reading Level + Correct Factor
3. Margin Level = Result Value – Limit Value
4. The other emission levels were very low against the limit

Test Mode :	Transmit (Other 5G 2Mbps)	Test Date :	2025/01/06
Test Channel :	CH11(5790MHz)	Temperature :	20.5 °C
Polarization :	Vertical	Relative Humidity :	47.5 %

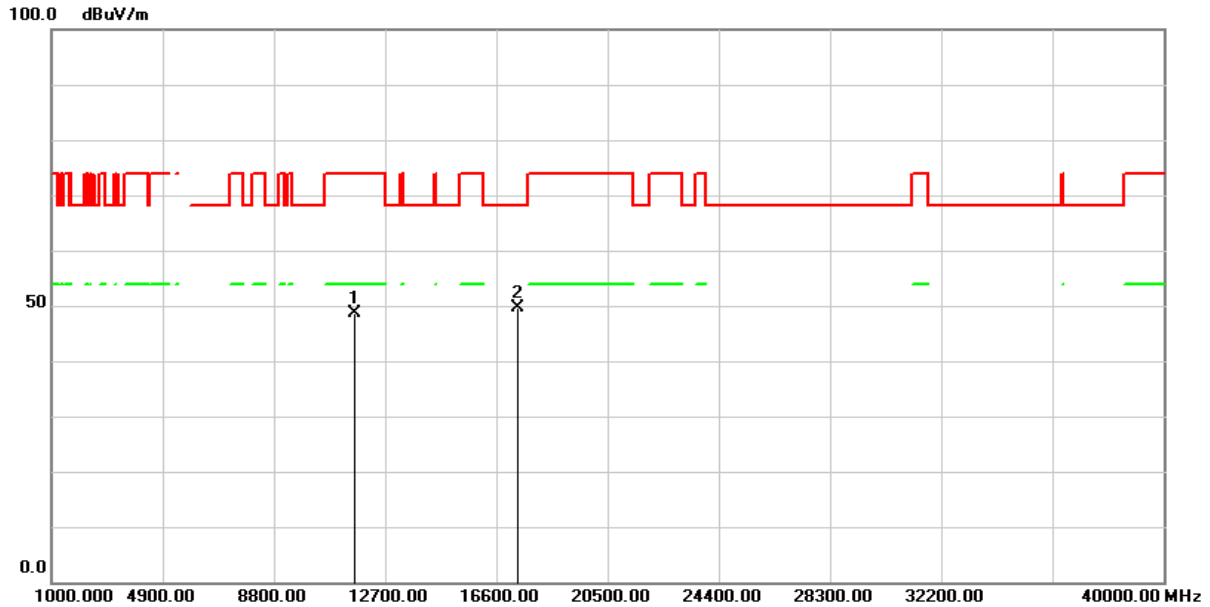

No.	Frequency (MHz)	Reading (dBuV/m)	Correct Factor (dB/m)	Result (dBuV/m)	Limit (dBuV/m)	Margin (dB)	Remark
1	11580.000	59.66	-10.96	48.70	74.00	-25.30	peak
2	17370.000	52.79	-3.21	49.58	68.20	-18.62	peak

Remark :

1. Correction Factor = Antenna factor + Cable loss – Amplifier gain
2. Result Value = Reading Level + Correct Factor
3. Margin Level = Result Value – Limit Value
4. The other emission levels were very low against the limit

Test Mode :	Transmit (Other 5G 2Mbps)	Test Date :	2025/01/07
Test Channel :	CH23/CH00(5850MHz)	Temperature :	20.5 °C
Polarization :	Horizontal	Relative Humidity :	47.5 %

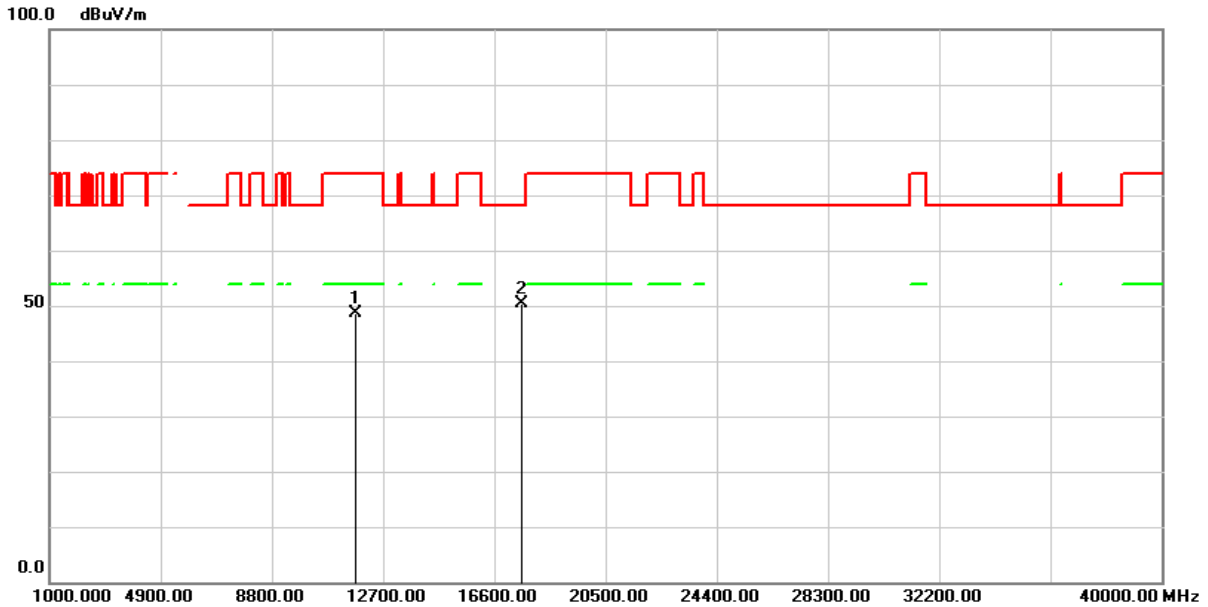

No.	Frequency (MHz)	Reading (dBuV/m)	Correct Factor (dB/m)	Result (dBuV/m)	Limit (dBuV/m)	Margin (dB)	Remark
1	11700.000	59.78	-11.24	48.54	74.00	-25.46	peak
2	17550.000	52.06	-1.67	50.39	68.20	-17.81	peak

Remark :

1. Correction Factor = Antenna factor + Cable loss – Amplifier gain
2. Result Value = Reading Level + Correct Factor
3. Margin Level = Result Value – Limit Value
4. The other emission levels were very low against the limit

Test Mode :	Transmit (Other 5G 2Mbps)	Test Date :	2025/01/07
Test Channel :	CH23/CH00(5850MHz)	Temperature :	20.5 °C
Polarization :	Vertical	Relative Humidity :	47.5 %

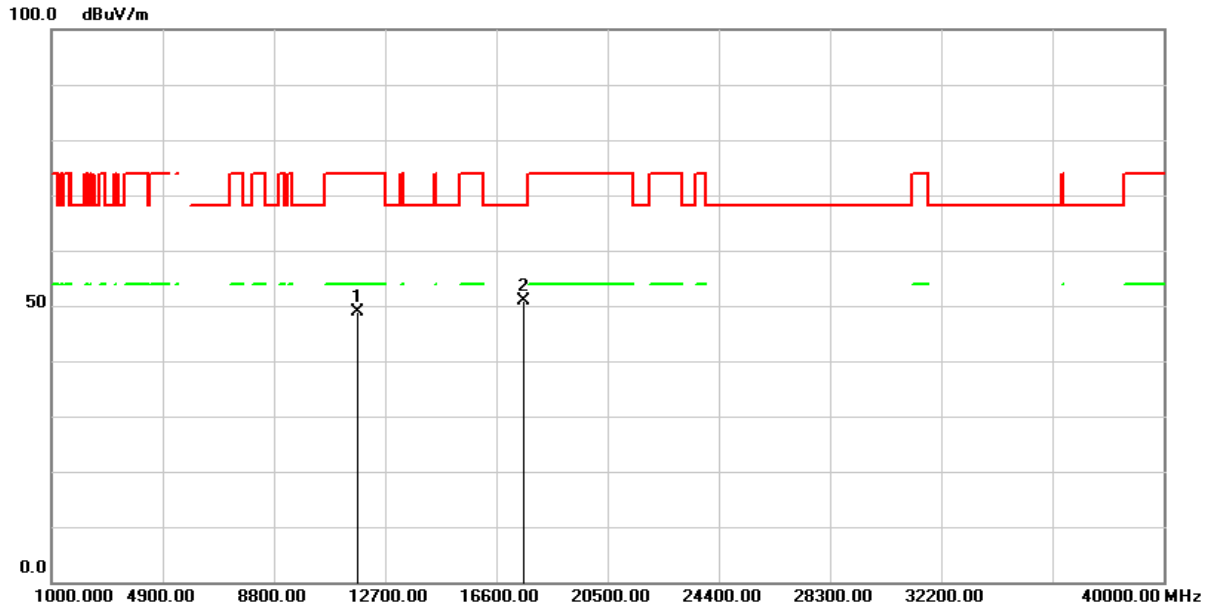

No.	Frequency (MHz)	Reading (dBuV/m)	Correct Factor (dB/m)	Result (dBuV/m)	Limit (dBuV/m)	Margin (dB)	Remark
1	11700.000	60.03	-11.24	48.79	74.00	-25.21	peak
2	17550.000	52.49	-1.67	50.82	68.20	-17.38	peak

Remark :

1. Correction Factor = Antenna factor + Cable loss – Amplifier gain
2. Result Value = Reading Level + Correct Factor
3. Margin Level = Result Value – Limit Value
4. The other emission levels were very low against the limit

Test Mode :	Transmit (Other 5G 2Mbps)	Test Date :	2025/01/07
Test Channel :	CH02(5860MHz)	Temperature :	20.5 °C
Polarization :	Horizontal	Relative Humidity :	47.5 %

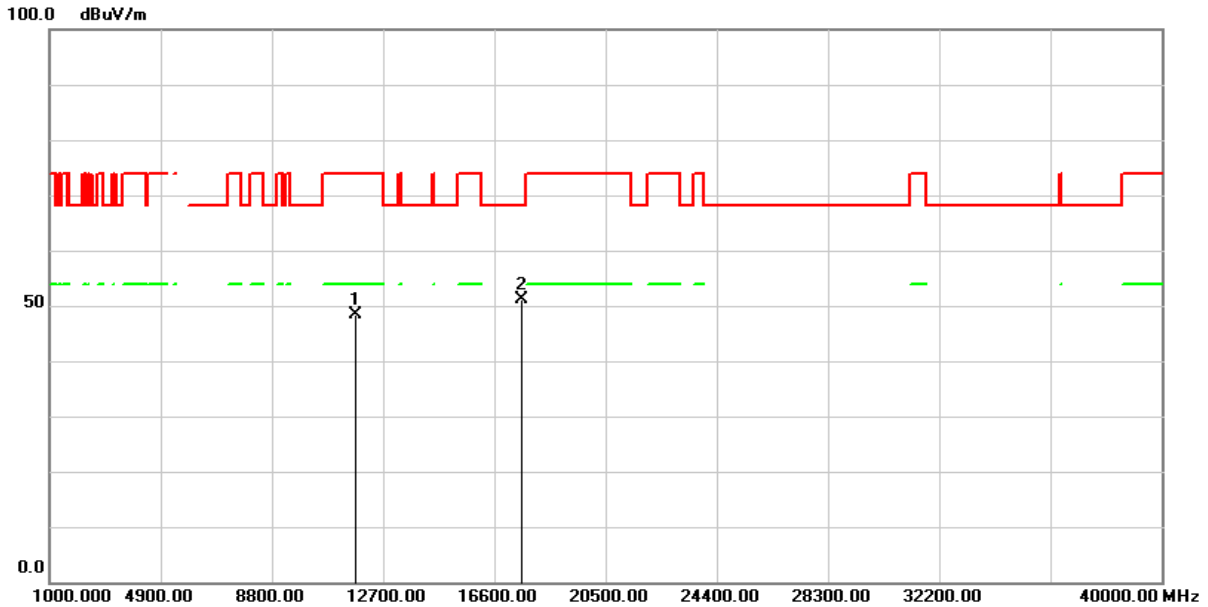

No.	Frequency (MHz)	Reading (dBuV/m)	Correct Factor (dB/m)	Result (dBuV/m)	Limit (dBuV/m)	Margin (dB)	Remark
1	11720.000	59.83	-11.35	48.48	74.00	-25.52	peak
2	17580.000	52.34	-1.33	51.01	68.20	-17.19	peak

Remark :

1. Correction Factor = Antenna factor + Cable loss – Amplifier gain
2. Result Value = Reading Level + Correct Factor
3. Margin Level = Result Value – Limit Value
4. The other emission levels were very low against the limit

Test Mode :	Transmit (Other 5G 2Mbps)	Test Date :	2025/01/07
Test Channel :	CH02(5860MHz)	Temperature :	20.5 °C
Polarization :	Vertical	Relative Humidity :	47.5 %

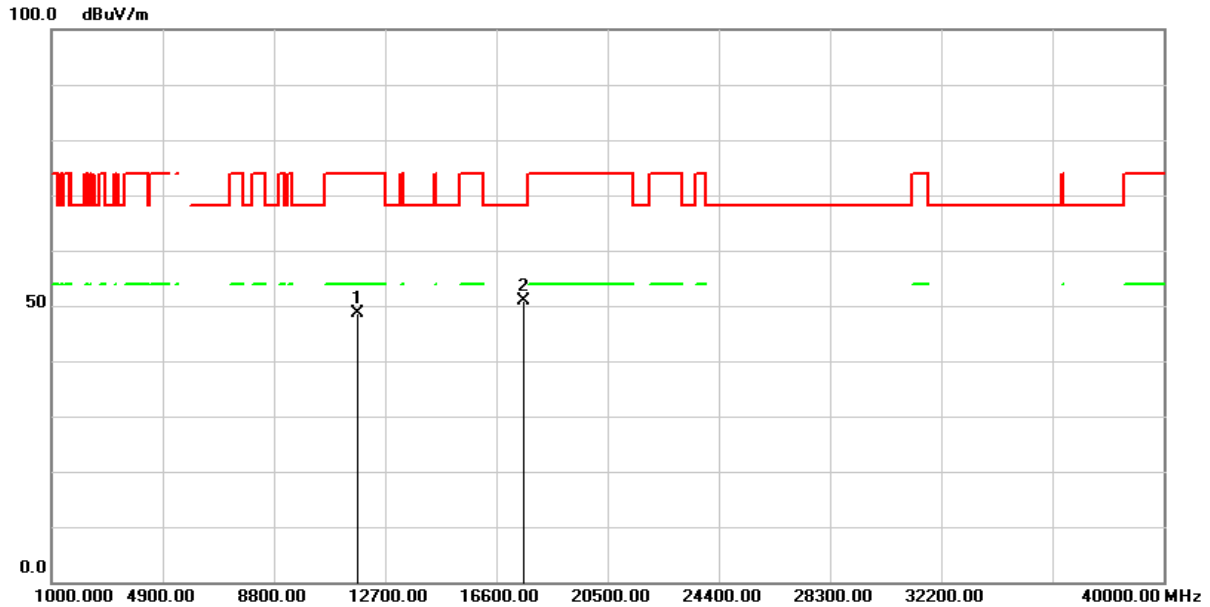

No.	Frequency (MHz)	Reading (dBuV/m)	Correct Factor (dB/m)	Result (dBuV/m)	Limit (dBuV/m)	Margin (dB)	Remark
1	11720.000	60.03	-11.35	48.68	74.00	-25.32	peak
2	17580.000	52.31	-1.33	50.98	68.20	-17.22	peak

Remark :

1. Correction Factor = Antenna factor + Cable loss – Amplifier gain
2. Result Value = Reading Level + Correct Factor
3. Margin Level = Result Value – Limit Value
4. The other emission levels were very low against the limit

Test Mode :	Transmit (Other 5G 2Mbps)	Test Date :	2025/01/07
Test Channel :	CH05(5875MHz)	Temperature :	20.5 °C
Polarization :	Horizontal	Relative Humidity :	47.5 %

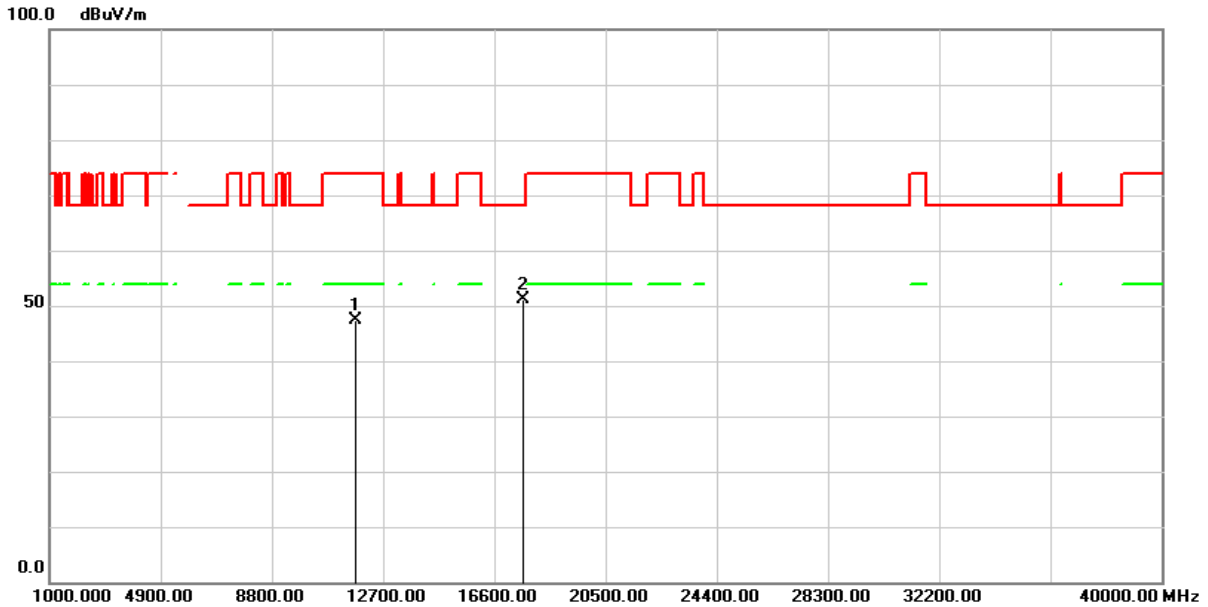

No.	Frequency (MHz)	Reading (dBuV/m)	Correct Factor (dB/m)	Result (dBuV/m)	Limit (dBuV/m)	Margin (dB)	Remark
1	11750.000	58.89	-11.52	47.37	74.00	-26.63	peak
2	17625.000	51.95	-0.82	51.13	68.20	-17.07	peak

Remark :

1. Correction Factor = Antenna factor + Cable loss – Amplifier gain
2. Result Value = Reading Level + Correct Factor
3. Margin Level = Result Value – Limit Value
4. The other emission levels were very low against the limit

Test Mode :	Transmit (Other 5G 2Mbps)	Test Date :	2025/01/07
Test Channel :	CH05(5875MHz)	Temperature :	20.5 °C
Polarization :	Vertical	Relative Humidity :	47.5 %

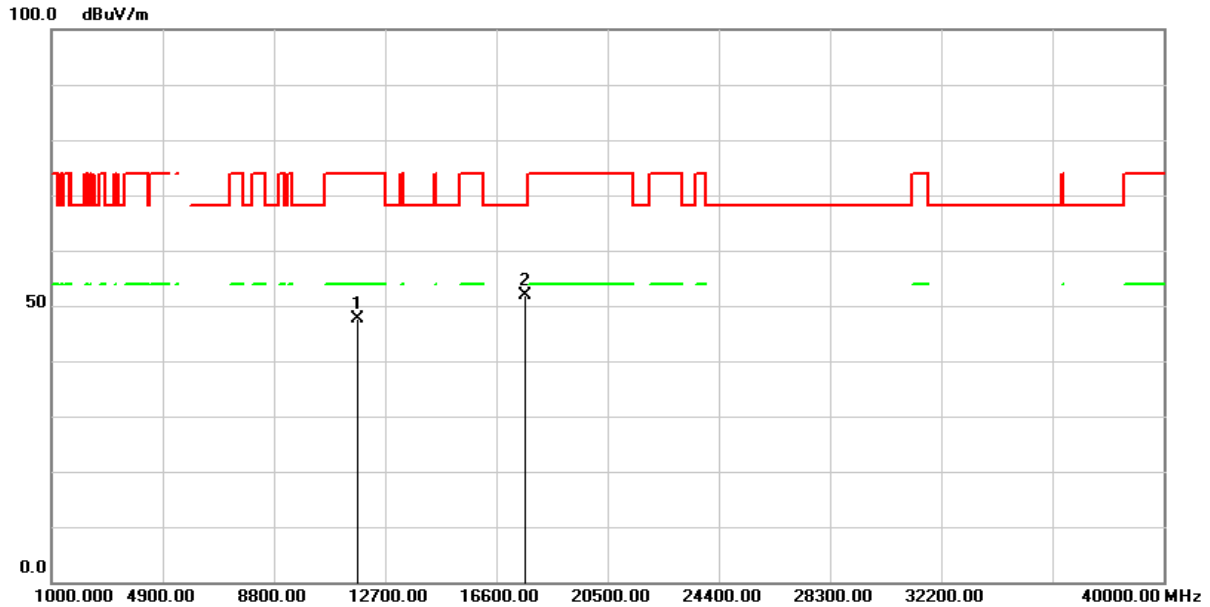

No.	Frequency (MHz)	Reading (dBuV/m)	Correct Factor (dB/m)	Result (dBuV/m)	Limit (dBuV/m)	Margin (dB)	Remark
1	11750.000	59.20	-11.52	47.68	74.00	-26.32	peak
2	17625.000	52.61	-0.82	51.79	68.20	-16.41	peak

Remark :

1. Correction Factor = Antenna factor + Cable loss – Amplifier gain
2. Result Value = Reading Level + Correct Factor
3. Margin Level = Result Value – Limit Value
4. The other emission levels were very low against the limit

Below 1GHz Data

Test Mode :	Transmit (Other 5G 2Mbps)	Test Date :	2025/01/06
Test Channel :	CH00(5160MHz)	Temperature :	20.7 °C
Polarization :	Horizontal	Relative Humidity :	50.3 %

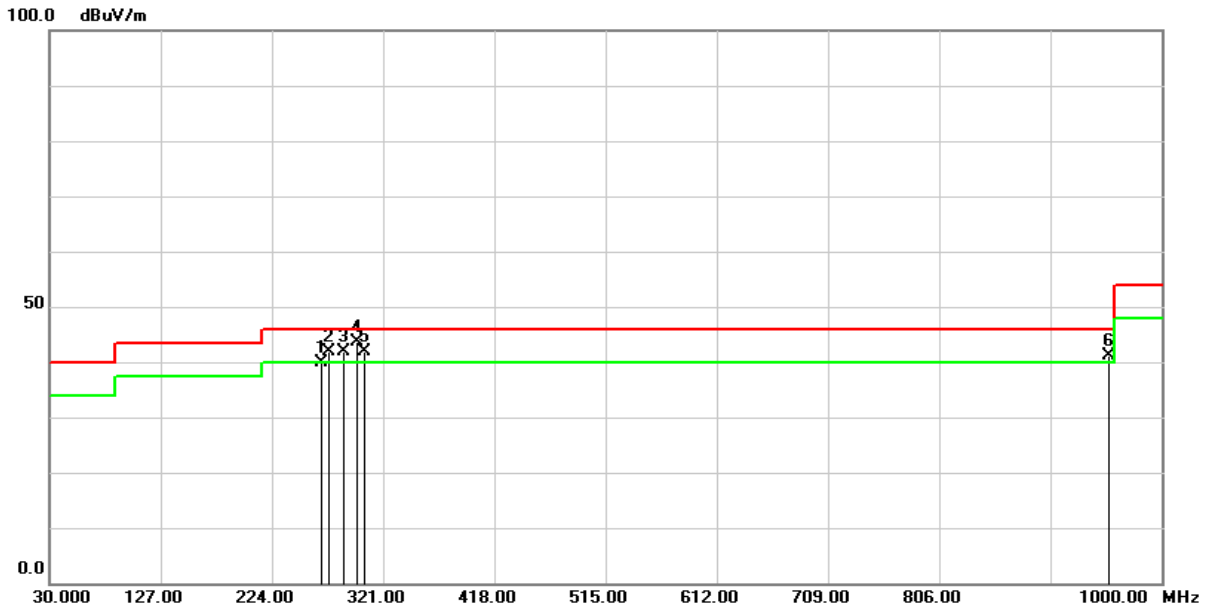

No.	Frequency (MHz)	Reading (dBuV/m)	Correct Factor (dB/m)	Result (dBuV/m)	Limit (dBuV/m)	Margin (dB)	Remark
1	267.6500	50.11	-10.35	39.76	46.00	-6.24	QP
2	273.4030	51.79	-9.92	41.87	46.00	-4.13	QP
3	286.0800	51.44	-9.54	41.90	46.00	-4.10	QP
4	297.9820	52.96	-9.25	43.71	46.00	-2.29	QP
5	304.5100	50.92	-9.05	41.87	46.00	-4.13	QP
6	954.4100	35.09	5.98	41.07	46.00	-4.93	QP

Remark :

1. Correction Factor = Antenna factor + Cable loss – Amplifier gain
2. Result Value = Reading Level + Correct Factor
3. Margin Level = Result Value – Limit Value
4. The other emission levels were very low against the limit

Test Mode :	Transmit (Other 5G 2Mbps)	Test Date :	2025/01/06
Test Channel :	CH00(5160MHz)	Temperature :	20.7 °C
Polarization :	Vertical	Relative Humidity :	50.3 %

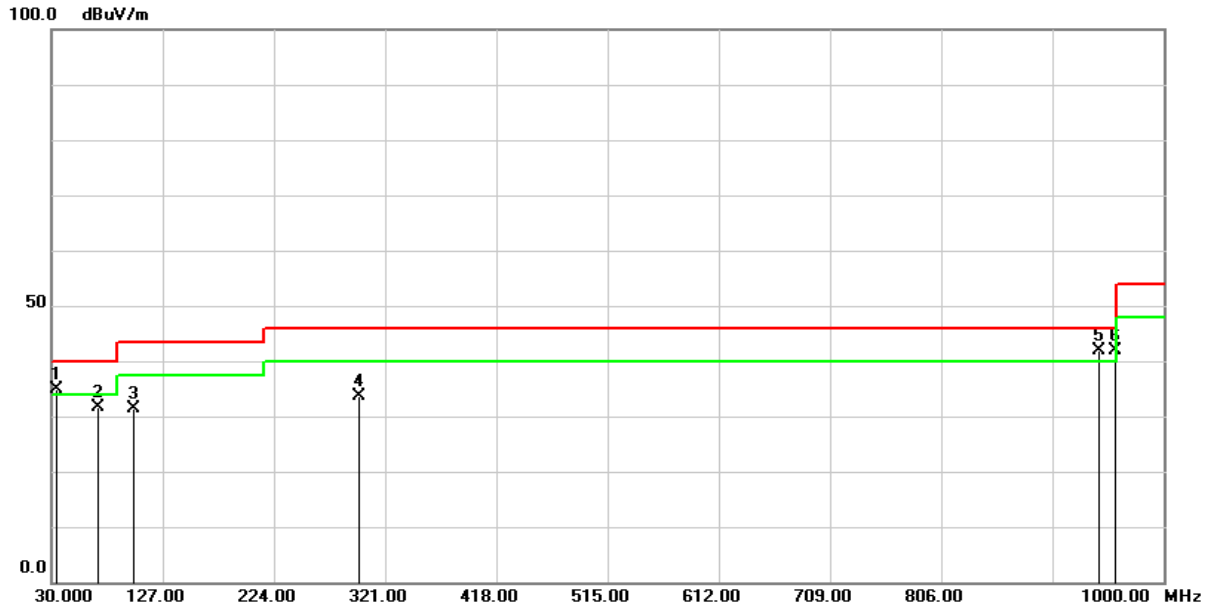

No.	Frequency (MHz)	Reading (dBuV/m)	Correct Factor (dB/m)	Result (dBuV/m)	Limit (dBuV/m)	Margin (dB)	Remark
1	34.8500	47.09	-12.33	34.76	40.00	-5.24	QP
2	70.7400	45.25	-13.52	31.73	40.00	-8.27	QP
3	101.7800	46.48	-15.13	31.35	43.50	-12.15	QP
4	297.7200	42.93	-9.26	33.67	46.00	-12.33	QP
5	943.7400	36.06	5.77	41.83	46.00	-4.17	QP
6	958.2900	35.96	6.02	41.98	46.00	-4.02	QP

Remark :

1. Correction Factor = Antenna factor + Cable loss – Amplifier gain
2. Result Value = Reading Level + Correct Factor
3. Margin Level = Result Value – Limit Value
4. The other emission levels were very low against the limit

Test Mode :	Transmit (Other 5G 2Mbps)	Test Date :	2025/01/06
Test Channel :	CH00(5735MHz)	Temperature :	20.7 °C
Polarization :	Horizontal	Relative Humidity :	50.3 %

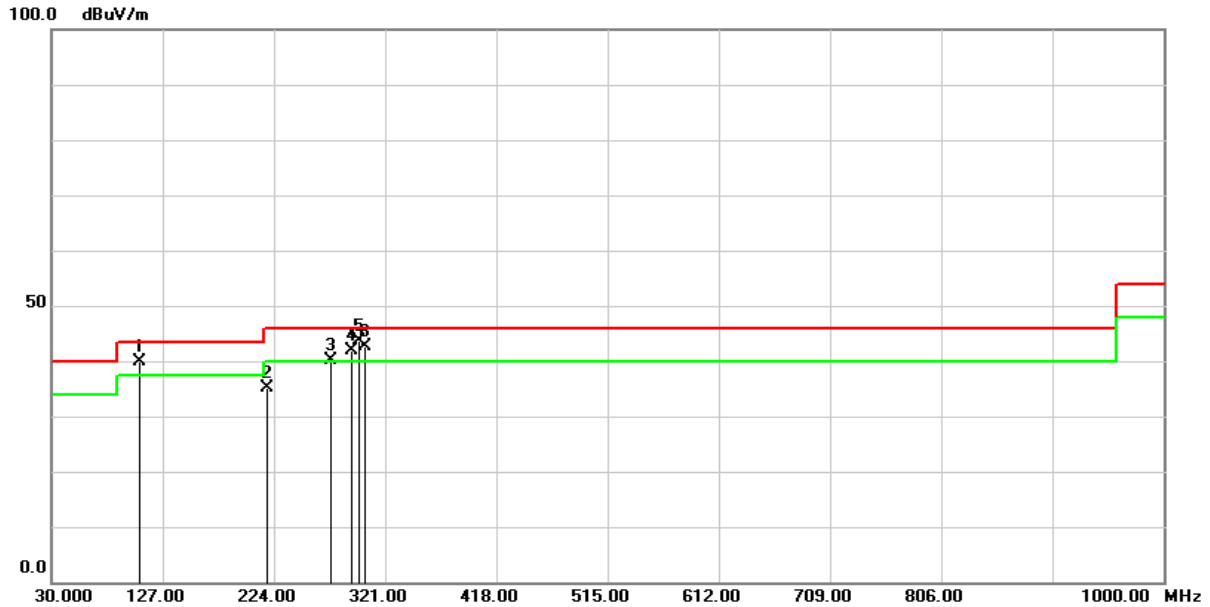

No.	Frequency (MHz)	Reading (dBuV/m)	Correct Factor (dB/m)	Result (dBuV/m)	Limit (dBuV/m)	Margin (dB)	Remark
1	107.5230	54.22	-14.28	39.94	43.50	-3.56	QP
2	218.1800	48.48	-13.43	35.05	46.00	-10.95	QP
3	273.4700	50.02	-9.91	40.11	46.00	-5.89	QP
4	291.9000	51.21	-9.45	41.76	46.00	-4.24	QP
5	297.9830	52.88	-9.25	43.63	46.00	-2.37	QP
6	304.1230	51.78	-9.06	42.72	46.00	-3.28	QP

Remark :

1. Correction Factor = Antenna factor + Cable loss – Amplifier gain
2. Result Value = Reading Level + Correct Factor
3. Margin Level = Result Value – Limit Value
4. The other emission levels were very low against the limit

Test Mode :	Transmit (Other 5G 2Mbps)	Test Date :	2025/01/06
Test Channel :	CH00(5735MHz)	Temperature :	20.7 °C
Polarization :	Vertical	Relative Humidity :	50.3 %

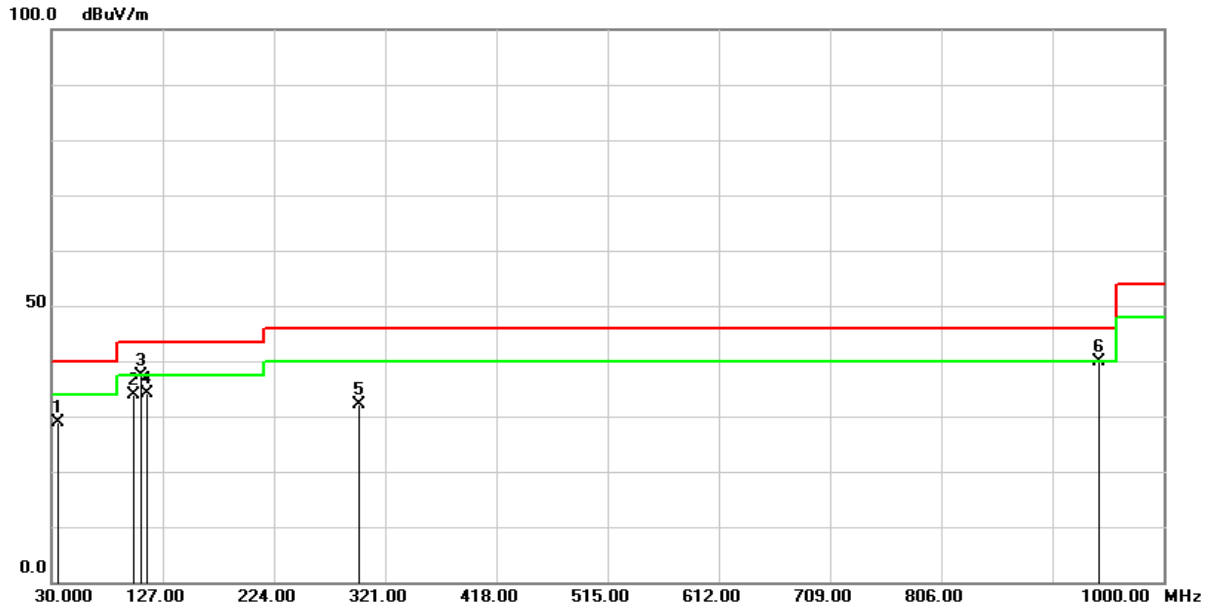

No.	Frequency (MHz)	Reading (dBuV/m)	Correct Factor (dB/m)	Result (dBuV/m)	Limit (dBuV/m)	Margin (dB)	Remark
1	35.8200	41.15	-12.38	28.77	40.00	-11.23	QP
2	101.7800	49.13	-15.13	34.00	43.50	-9.50	QP
3	107.6000	51.56	-14.28	37.28	43.50	-6.22	QP
4	113.4200	48.05	-13.93	34.12	43.50	-9.38	QP
5	297.7200	41.31	-9.26	32.05	46.00	-13.95	QP
6	943.7400	34.06	5.77	39.83	46.00	-6.17	QP

Remark :

1. Correction Factor = Antenna factor + Cable loss – Amplifier gain
2. Result Value = Reading Level + Correct Factor
3. Margin Level = Result Value – Limit Value
4. The other emission levels were very low against the limit

Test Mode :	Transmit (Other 5G 2Mbps)	Test Date :	2025/01/06
Test Channel :	CH02(5860MHz)	Temperature :	20.7 °C
Polarization :	Horizontal	Relative Humidity :	50.3 %

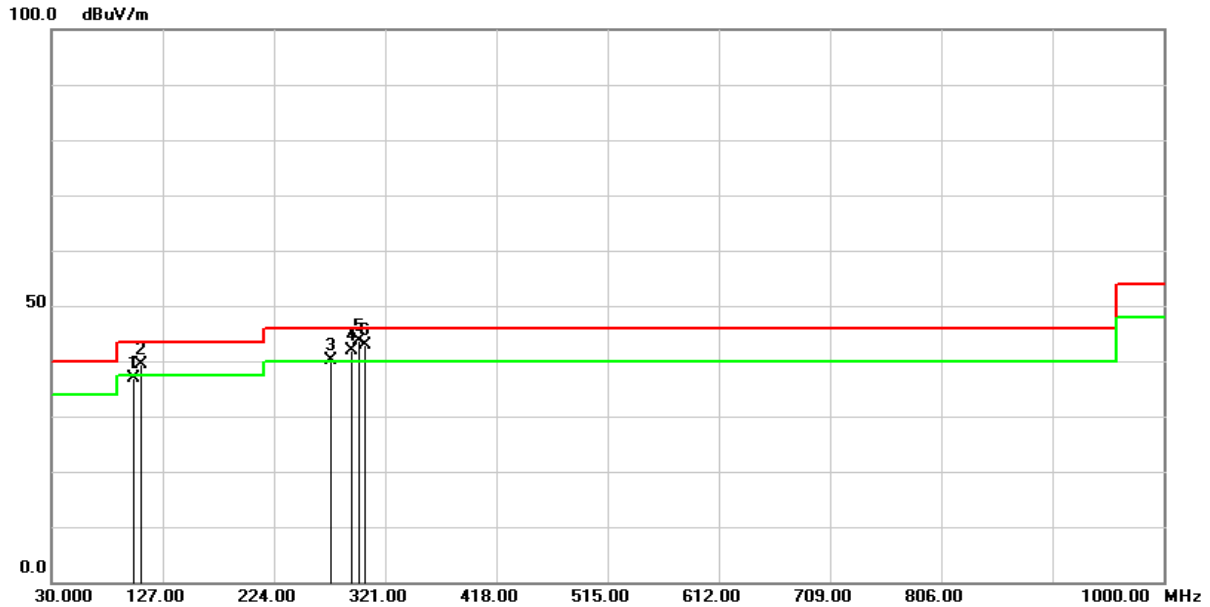

No.	Frequency (MHz)	Reading (dBuV/m)	Correct Factor (dB/m)	Result (dBuV/m)	Limit (dBuV/m)	Margin (dB)	Remark
1	101.7800	51.94	-15.13	36.81	43.50	-6.69	QP
2	107.6000	53.56	-14.28	39.28	43.50	-4.22	QP
3	273.4700	50.03	-9.91	40.12	46.00	-5.88	QP
4	291.9000	51.40	-9.45	41.95	46.00	-4.05	QP
5	297.9810	52.84	-9.25	43.59	46.00	-2.41	QP
6	304.1240	51.98	-9.06	42.92	46.00	-3.08	QP

Remark :

1. Correction Factor = Antenna factor + Cable loss – Amplifier gain
2. Result Value = Reading Level + Correct Factor
3. Margin Level = Result Value – Limit Value
4. The other emission levels were very low against the limit

Test Mode :	Transmit (Other 5G 2Mbps)	Test Date :	2025/01/06
Test Channel :	CH02(5860MHz)	Temperature :	20.7 °C
Polarization :	Vertical	Relative Humidity :	50.3 %

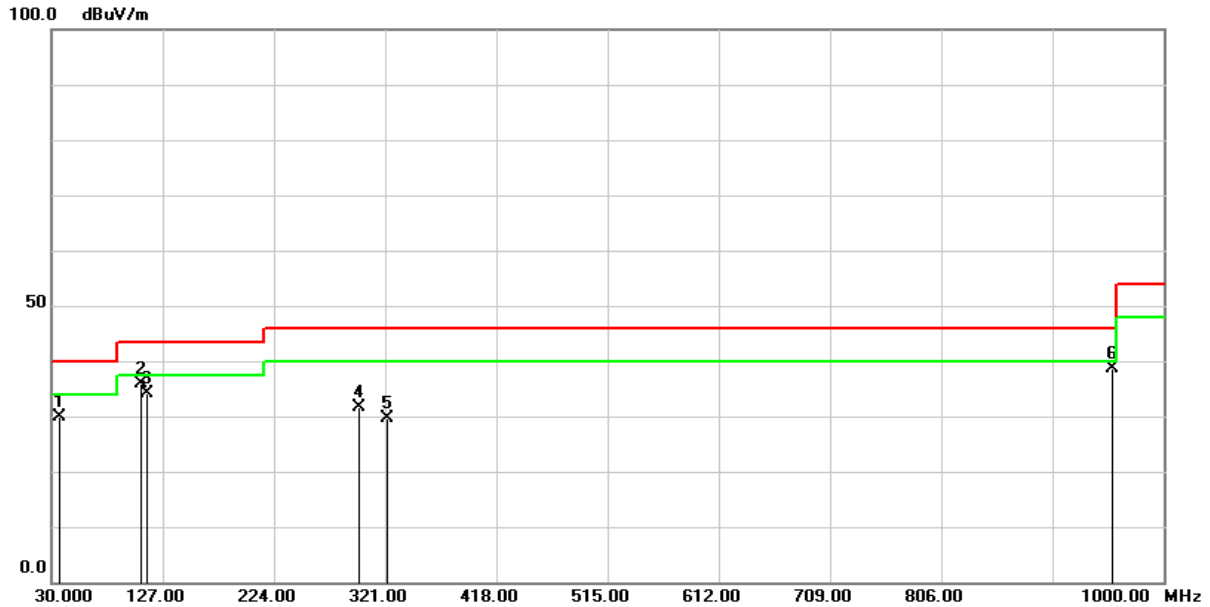

No.	Frequency (MHz)	Reading (dBuV/m)	Correct Factor (dB/m)	Result (dBuV/m)	Limit (dBuV/m)	Margin (dB)	Remark
1	36.7900	41.94	-12.07	29.87	40.00	-10.13	QP
2	107.6000	50.19	-14.28	35.91	43.50	-7.59	QP
3	113.4200	48.07	-13.93	34.14	43.50	-9.36	QP
4	297.7200	40.98	-9.26	31.72	46.00	-14.28	QP
5	322.9400	38.04	-8.44	29.60	46.00	-16.40	QP
6	955.3800	32.56	6.00	38.56	46.00	-7.44	QP

Remark :

1. Correction Factor = Antenna factor + Cable loss – Amplifier gain
2. Result Value = Reading Level + Correct Factor
3. Margin Level = Result Value – Limit Value
4. The other emission levels were very low against the limit

2.6 Frequency Stability

2.6.1 Limit

Manufacturers of U-NII devices are responsible for ensuring frequency stability such that an emission is maintained within the band of operation under all conditions of normal operation as specified in the user's manual.

2.6.2 Test Setup

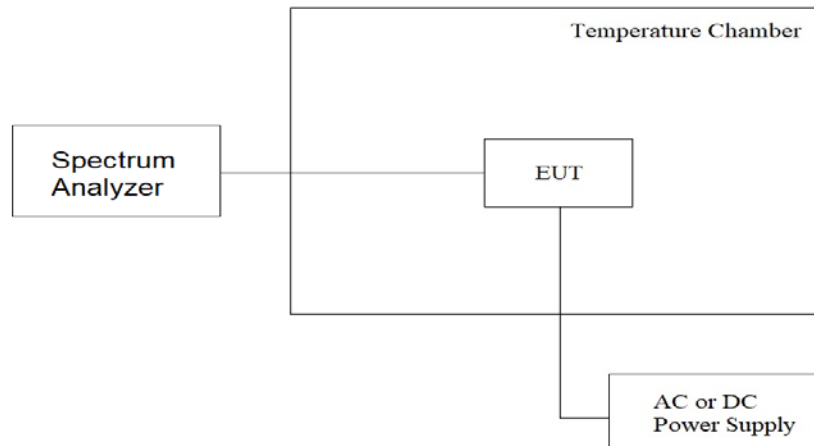

2.6.3 Test Procedure

1. The test shall be performed under 85% ~115% of the nominal voltage.
2. Set the temperature control on the chamber to the highest specified in the regulatory requirements for the type of device and allow the oscillator heater and the chamber temperature to stabilize.
3. The frequency deviation was calculated by adding the upper frequency point and the lower frequency point divided by two. Those detailed values of frequency deviation are provided in table below.

2.6.4 Test Result

UN-II Band I selected frequency: 5160MHz

Temperature (°C)	Voltage (V)	Tolerance (ppm)				Limit (ppm)	Result
		Start	2 min	5 min	10 min		
20	108	-0.039	-0.116	0.136	0.019	20	Pass
	120	0.116	0.078	0.136	-0.174	20	Pass
	132	0.039	0.116	0.097	0.078	20	Pass

Temperature (°C)	Voltage (V)	Tolerance (ppm)				Limit (ppm)	Result
		Start	2 min	5 min	10 min		
0	120	-0.019	0.019	0.000	-0.136	20	Pass
10		-0.136	0.078	0.078	-0.116	20	Pass
20		0.097	0.174	0.039	0.097	20	Pass
30		-0.097	0.174	0.000	-0.019	20	Pass
40		0.097	0.155	-0.155	-0.155	20	Pass
45		-0.136	0.019	-0.136	0.000	20	Pass

UNII Band III selected frequency: 5735MHz

Temperature (°C)	Voltage (V)	Tolerance (ppm)				Limit (ppm)	Result
		Start	2 min	5 min	10 min		
20	108	1.280	-0.922	-1.473	0.900	20	Pass
	120	-0.605	1.381	-0.298	0.677	20	Pass
	132	0.070	1.452	-0.345	1.147	20	Pass

Temperature (°C)	Voltage (V)	Tolerance (ppm)				Limit (ppm)	Result
		Start	2 min	5 min	10 min		
0	120	-0.101	1.358	-1.233	-1.407	20	Pass
10		-1.269	-1.583	-0.696	-1.051	20	Pass
20		1.200	-0.249	0.985	1.112	20	Pass
30		-0.005	0.155	-1.173	0.626	20	Pass
40		1.376	-0.546	1.062	0.183	20	Pass
45		1.240	-1.020	-1.229	0.828	20	Pass

UNII Band IV selected frequency: 5850MHz

Temperature (°C)	Voltage (V)	Tolerance (ppm)				Limit (ppm)	Result
		Start	2 min	5 min	10 min		
20	108	1.679	0.236	-0.267	-1.696	20	Pass
	120	1.345	-1.581	1.282	0.221	20	Pass
	132	-1.648	-0.092	-0.897	-0.699	20	Pass

Temperature (°C)	Voltage (V)	Tolerance (ppm)				Limit (ppm)	Result
		Start	2 min	5 min	10 min		
0	120	-1.634	-0.875	1.301	-0.342	20	Pass
10		1.222	-1.113	0.959	1.593	20	Pass
20		-0.718	-0.456	-1.639	-1.053	20	Pass
30		0.715	0.133	1.038	0.691	20	Pass
40		-0.005	-1.692	0.176	1.332	20	Pass
45		1.161	-0.427	-1.209	-1.039	20	Pass

UNII Band IV selected frequency: 5875MHz

Temperature (°C)	Voltage (V)	Tolerance (ppm)				Limit (ppm)	Result
		Start	2 min	5 min	10 min		
20	108	-1.077	-1.391	-0.330	-0.371	20	Pass
	120	1.350	-1.438	-1.236	-0.015	20	Pass
	132	1.035	0.214	-0.805	-1.539	20	Pass

Temperature (°C)	Voltage (V)	Tolerance (ppm)				Limit (ppm)	Result
		Start	2 min	5 min	10 min		
0	120	-0.296	1.173	0.688	-1.290	20	Pass
10		0.727	1.573	-0.180	-0.238	20	Pass
20		1.239	-1.622	1.375	0.354	20	Pass
30		1.563	-1.231	-1.009	0.376	20	Pass
40		-0.095	-1.137	-1.054	-1.195	20	Pass
45		0.701	-1.421	1.387	-1.675	20	Pass

2.7 Antenna Requirement

2.7.1 Applicable Standard

An intentional radiator shall be designed to ensure that no antenna other than that furnished by the responsible party shall be used with the device. The use of a permanently attached antenna or of an antenna that uses a unique coupling to the intentional radiator shall be considered sufficient to comply with the provisions of this section. The manufacturer may design the unit so that a broken antenna can be replaced by the user, but the use of a standard antenna jack or electrical connector is prohibited.

An intentional radiator shall be designed to ensure that no antenna other than as furnished by the responsible party shall be used with the device. If transmitting antennas of directional gain greater than 6dBi are using the power shall be reduced by the amount in dB that the directional gain of the antenna exceeds 6 dBi, for compliance to FCC 47CFR 15.407 (a) requirements.

2.7.2 Antenna Connected Construction

Non-standard antenna connector is used.

2.7.3 Antenna Gain

No.	Manufacturer	Model No.	Antenna Type	Peak Gain
1	ZYLUX	ZZ_ANT_0000004	PCB Printed Antenna	4.35 dBi for 5.16 ~ 5.875 GHz
2	ZYLUX	ZZ_ANT_0000004	PCB Printed Antenna	5.38 dBi for 5.16 ~ 5.875 GHz

2.8 AC Conducted Emissions Measurement

2.8.1 Limit

Frequency (MHz)	FCC Part 15 Subpart C Paragraph 15.207 (dBμV) Limit	
	Quasi-peak	Average
0.15 to 0.5	66 to 56*	56 to 46*
0.50 to 5.0	56	46
5.0 to 30.0	60	50

*Decreases with the logarithm of the frequency

2.8.2 Test Setup

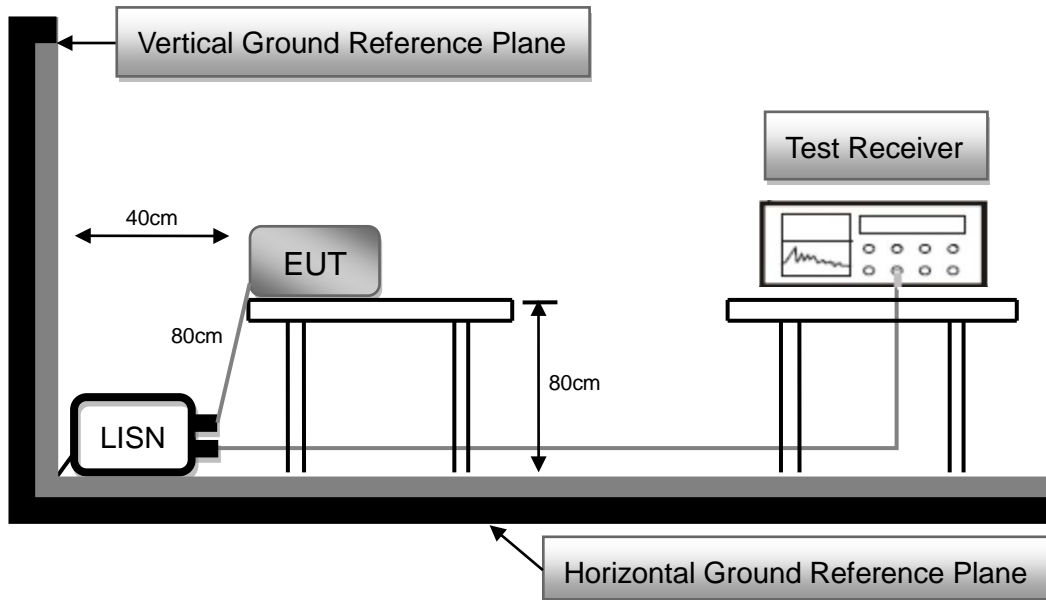

2.8.3 Test Procedure

1. The EUT was placed 0.8 meter height wooden table from the horizontal ground plane with EUT being connected to power source through a line impedance stabilization network (LISN). The LISN at least be 80 cm from nearest chassis of EUT.
2. The line impedance stabilization network (LISN) provides 50 ohm/50uH of coupling impedance for the measuring instrument. All other support equipments powered from additional LISN(s).
3. Interrelating cables that hang closer than 40 cm to the ground plane shall be folded back and forth in the center forming a bundle. All I/O cables were positioned to simulate typical usage.
4. All I/O cables that are not connected to a peripheral shall be bundle in the center. The end of the cable may be terminated, if required, using the correct terminating impedance. The overall length shall not exceed 1 m.
5. The EMI test receiver connected to LISN powering the EUT. The actual test configuration, please refer to EUT test photos.
6. The receiver scanned from 150kHz to 30MHz for emissions in each of test modes. A scan was taken on both power lines, Line and Neutral, recording at least six highest emissions.
7. The EUT and cable configuration of the above highest emission levels were recorded. The Test Data of the worst case was recorded.

2.8.4 Test Result

Test Voltage :	120Vac, 60Hz	Frequency Range:	0.15-30 MHz
Test Mode :	Transmit (Other 5G 2Mbps)	6dB Bandwidth :	9 kHz
Test Date :	2024/11/28	Phase :	L
Temperature :	24.2°C	Humidity :	45 %

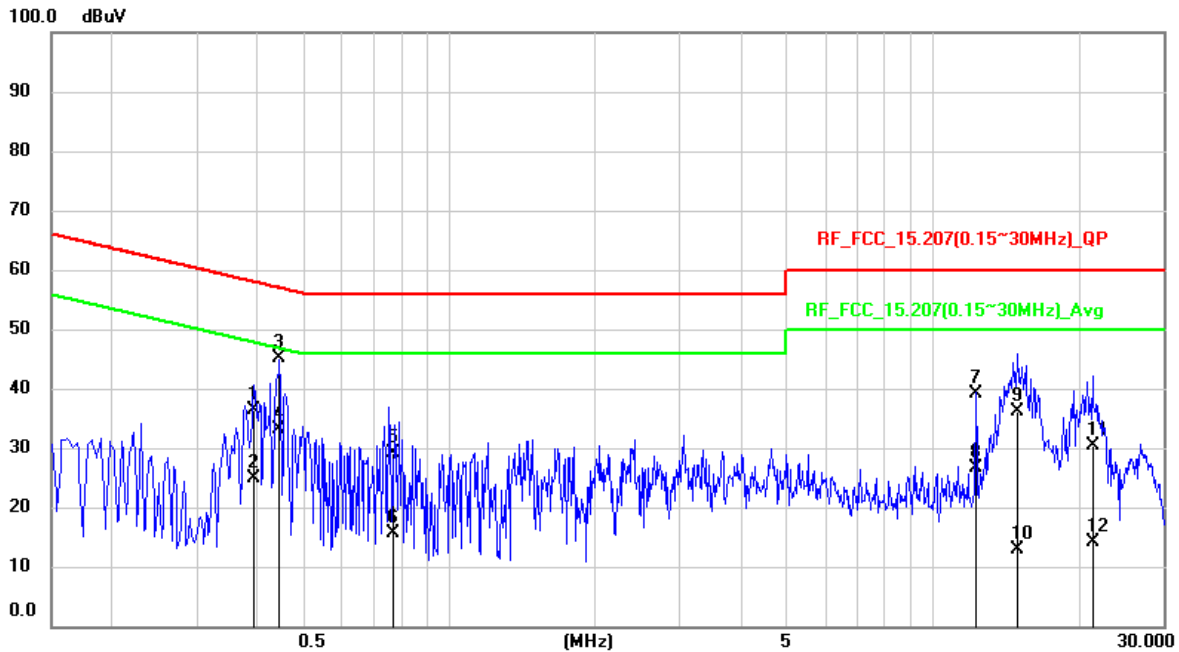

No.	Frequency (MHz)	Reading Level (dBuV)	Correct Factor (dB)	Measurement (dBuV)	Limit (dBuV)	Margin (dB)	Detector
1	0.3929	26.55	9.83	36.38	58	-21.62	QP
2	0.3929	15.08	9.83	24.91	48	-23.09	AVG
3	0.4438	35.25	9.83	45.08	56.99	-11.91	QP
4	0.4438	23.22	9.83	33.05	46.99	-13.94	AVG
5	0.7628	19.32	9.83	29.15	56	-26.85	QP
6	0.7628	5.88	9.83	15.71	46	-30.29	AVG
7	12.2868	29.05	10.17	39.22	60	-20.78	QP
8	12.2868	16.5	10.17	26.67	50	-23.33	AVG
9	14.9999	25.89	10.22	36.11	60	-23.89	QP
10	14.9999	2.65	10.22	12.87	50	-37.13	AVG
11	21.4108	20.09	10.35	30.44	60	-29.56	QP
12	21.4108	3.76	10.35	14.11	50	-35.89	AVG

Remark:

1. QP = Quasi Peak, AVG = Average
2. Correction Factor = Insertion loss of LISN + Cable loss
3. Measurement Value = Reading Level + Correct Factor
4. Margin Level = Measurement Value – Limit Value

Test Voltage :	120Vac, 60Hz	Frequency Range:	0.15-30 MHz
Test Mode :	Transmit (Other 5G 2Mbps)	6dB Bandwidth :	9 kHz
Test Date :	2024/11/28	Phase :	N
Temperature :	24.2°C	Humidity :	45 %

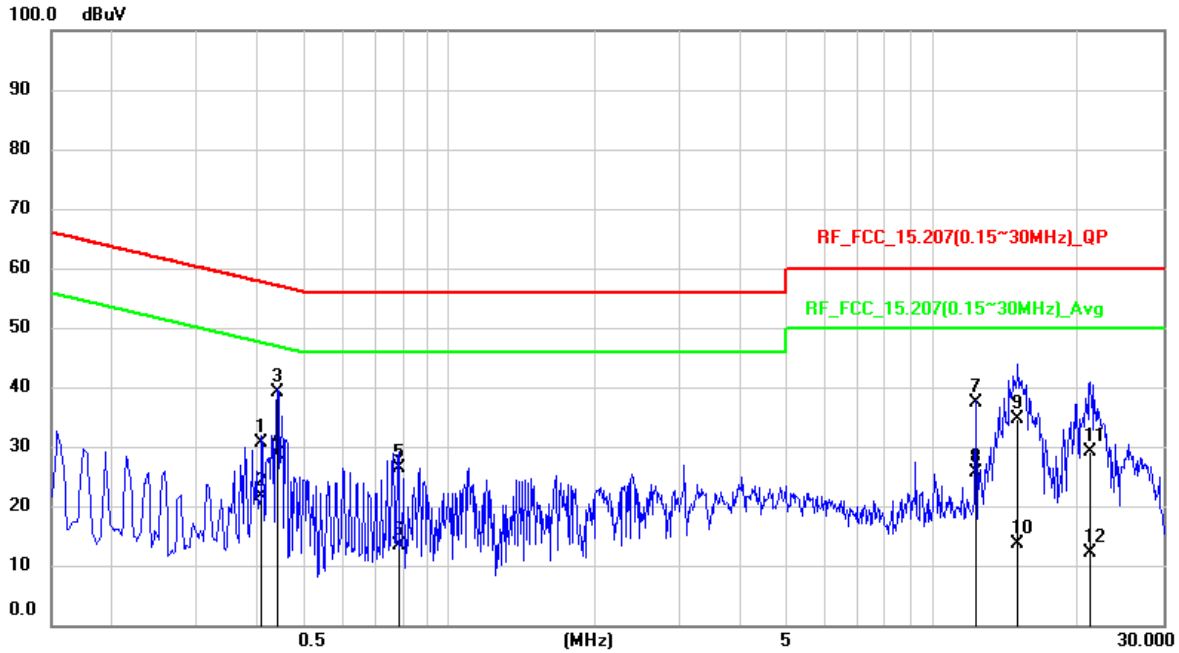

No.	Frequency (MHz)	Reading Level (dBuV)	Correct Factor (dB)	Measurement (dBuV)	Limit (dBuV)	Margin (dB)	Detector
1	0.4083	20.8	9.82	30.62	57.68	-27.06	QP
2	0.4083	11.81	9.82	21.63	47.68	-26.05	AVG
3	0.4418	29.26	9.82	39.08	57.03	-17.95	QP
4	0.4418	18.76	9.82	28.58	47.03	-18.45	AVG
5	0.7824	16.47	9.83	26.3	56	-29.7	QP
6	0.7824	3.53	9.83	13.36	46	-32.64	AVG
7	12.2878	27.2	10.15	37.35	60	-22.65	QP
8	12.2878	15.58	10.15	25.73	50	-24.27	AVG
9	14.9782	24.53	10.21	34.74	60	-25.26	QP
10	14.9782	3.52	10.21	13.73	50	-36.27	AVG
11	21.1162	18.76	10.33	29.09	60	-30.91	QP
12	21.1162	1.85	10.33	12.18	50	-37.82	AVG

Remark:

1. QP = Quasi Peak, AVG = Average
2. Correction Factor = Insertion loss of LISN + Cable loss
3. Measurement Value = Reading Level + Correct Factor
4. Margin Level = Measurement Value – Limit Value

--- END ---