



承 认 书

APPROVAL SHEET

客户名称 Customer				
客户料号 Customer P/N				
项目名称 Project Name	WiFi Dual-band SMA Male(Black)			
供应商名称 Supplier	上海圣丹纳无线科技有限公司 Shanghai Saintenna Wireless Technology Co.,LTD.			
圣丹纳物料型号 Saintenna P/N	SAA31578A			
是否符合 RoHS IF ROHS	yes			
送样日期 Providing Date	2020.07.10			
供应商 Supplier	制定 Prepared by	设计 Designer	品质 QA	批准 Approver
	马玉学	钱锐	李光辉	余剑平
地址: 上海市宝山区宝祁路611号8号楼 Address: Building 8, No.611 Bao Qi Road, Bao Shan District, Shanghai, China				
电话/Tel: 086-021-36307272; 传真/Fax: 086-021-36307757				
客户 Customer	编制 Prepared by	审核 Checked by	批准 Approver	

注: 必须手工签字确认 (Note: Signature must be confirmed by hand)

CONFIDENTIAL

The information contained in this product is of a proprietary nature. It may not be reproduced without expressed written permission of Shanghai Saintenna Wireless Technology Co.,LTD.

目录/Content

一 封面/Cover.....	☑
二 目录/Content.....	☑
三 规格/Specification.....	☑
四 图纸/Drawing.....	☑
五 电性能报告/Electric Report.....	☑

规格/Specification

1. 机械规格/Mechanical Specification

- 连接方式/Connect Type..... SMA-J
- 工作温度/Work Temperature..... -40~85℃
- 存储温度/Storage Temperature..... -40~85℃

2. 电性能参数/Electrical Specification

- 频段/Frequency Range..... 2.4~2.5&5.15~5.85GHz
- 驻波比/VSWR..... <3
- 增益/Peak Gain..... 0dBi
- 极化/Polarization..... Vertical
- 特性阻抗/Input Impedance..... 50 Ω
- 最大承载功率/Max Input Power..... 5W

标记	签名	修改内容	日期

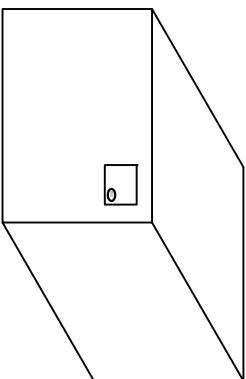
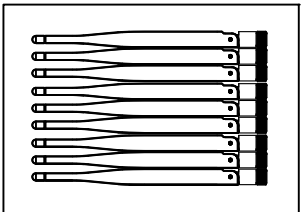

- 1. 外箱需贴1PCS/ROHS 标签于外箱标签上
- 2. 外箱需贴1PCS/外箱标签于外箱侧麦右上角

ROHS

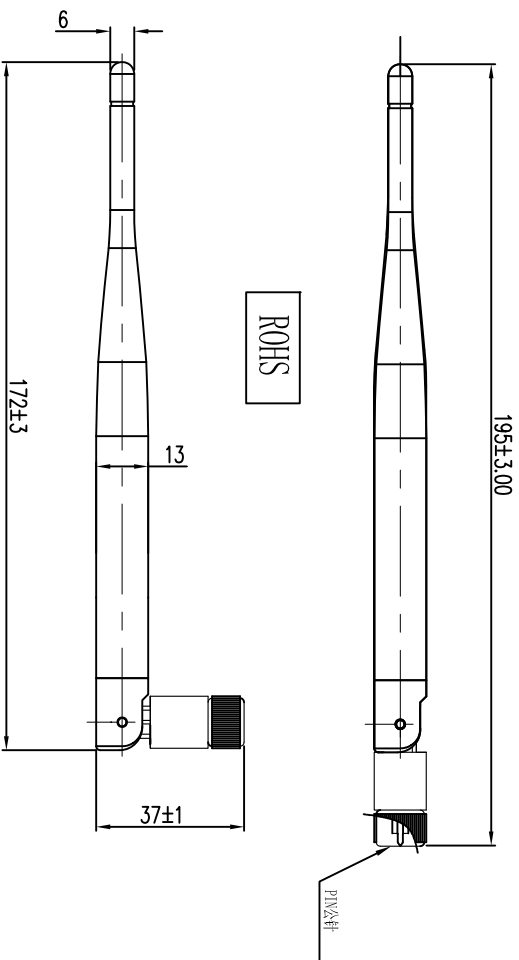

上海圣丹纳无线科技有限公司

第三视角		项目名称	WIFI Dual-band -Antenna	日期	2020.07.10	
0~3	±0.05	Φ	0.05	设计	MD	mayuxue
3~30	±0.10	○	0.03	产品名称	RF	qiannui
30~50	±0.15	◎	0.02	产品料号	SAA31578A	
50~80	±0.20	⊥	0.02	单位	mm	比例
角度	±1°	∠	0.05	批准	单位	mm
第 1 页, 共 1 页		SAA31578A		单位	mm	比例
第 1 页, 共 1 页		SAA31578A		单位	mm	比例

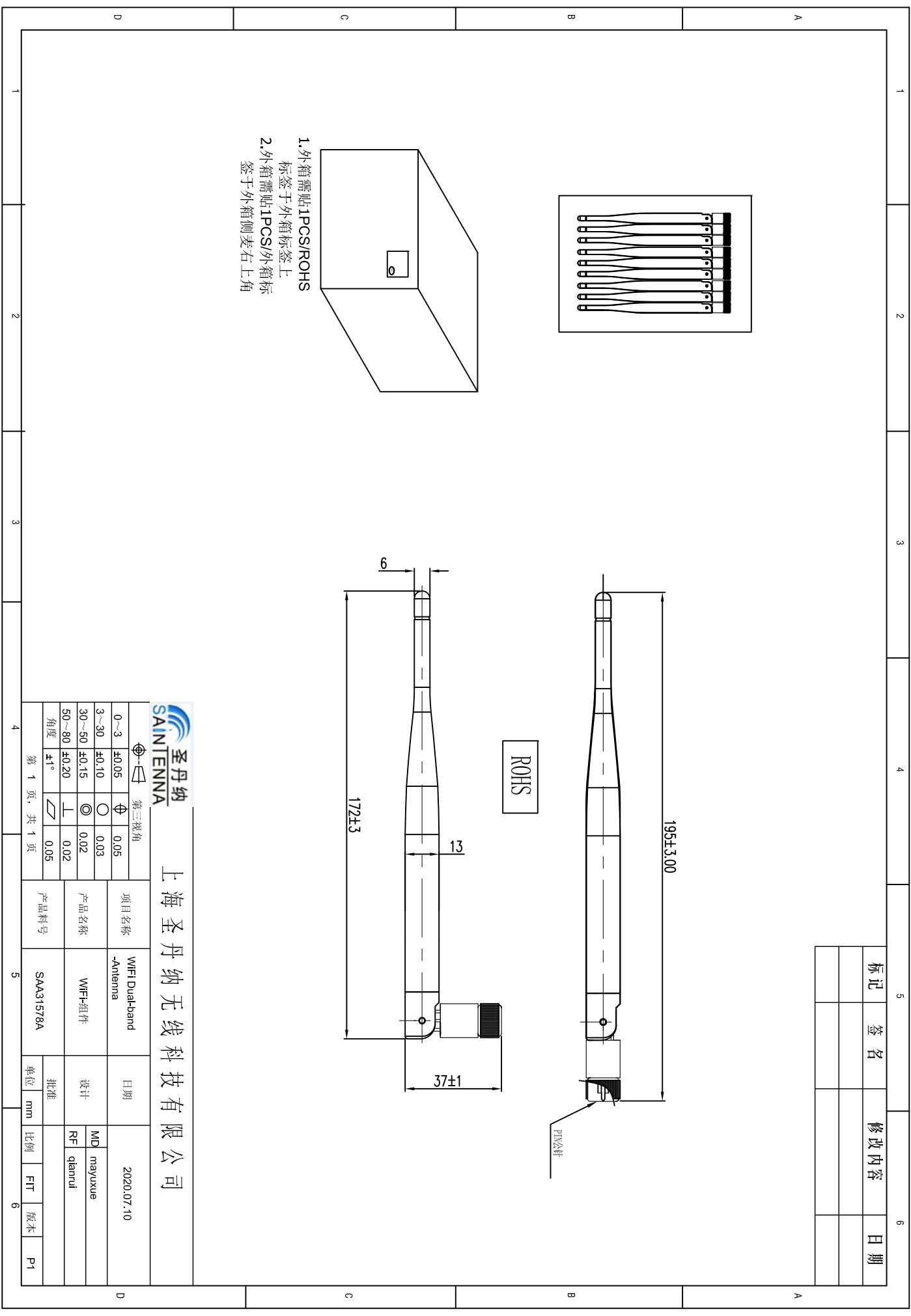



移远0dBi双频WiFi天线调试报告

上海圣丹纳无线科技有限公司

Shanghai Saintenna Wireless Technology Co.,LTD.

Project Information

客户名称 Customer Name	移远
项目名称 Project Name	0dBi双频WiFi天线
工作频段 Working Band	2.4G/5.8GHZ
规格 Description	SMA-Male
版本 Version	V1.0
日期 Date	2020-7-10

Debug Instrument

Network Analyzer	Agilent E5071C
Frequency Range	100KHz ~ 8.5GHz
Test Item	Return Loss/VSWR/Smith Chart /Isolation

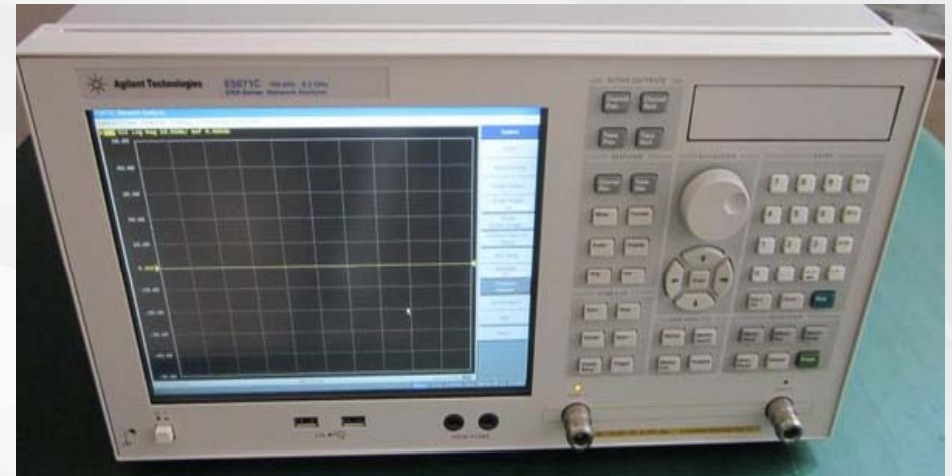

Typical Setup for Test System

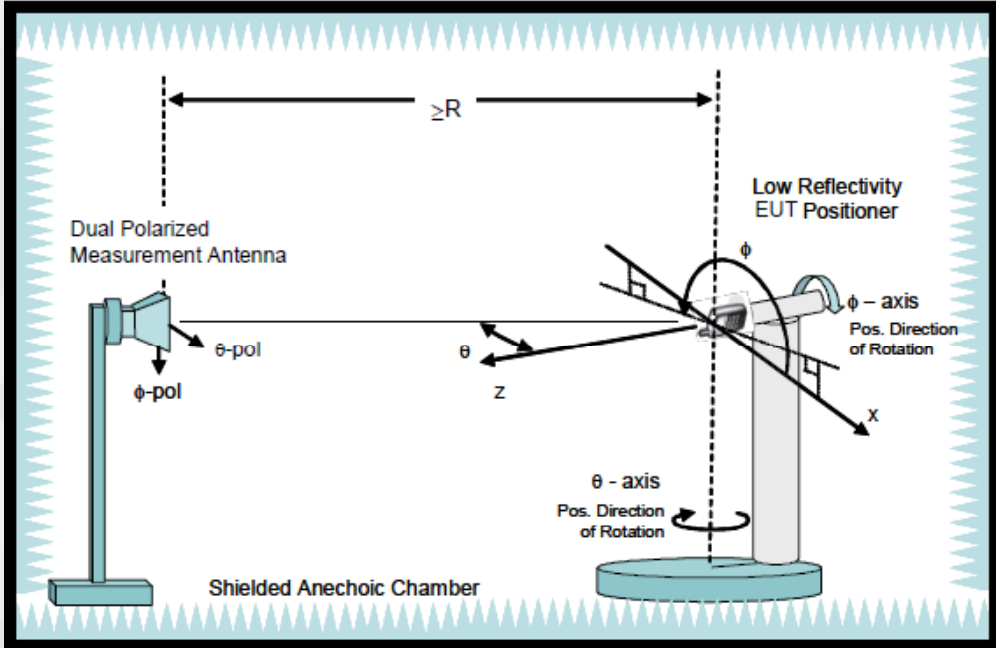

Combined-Axes System

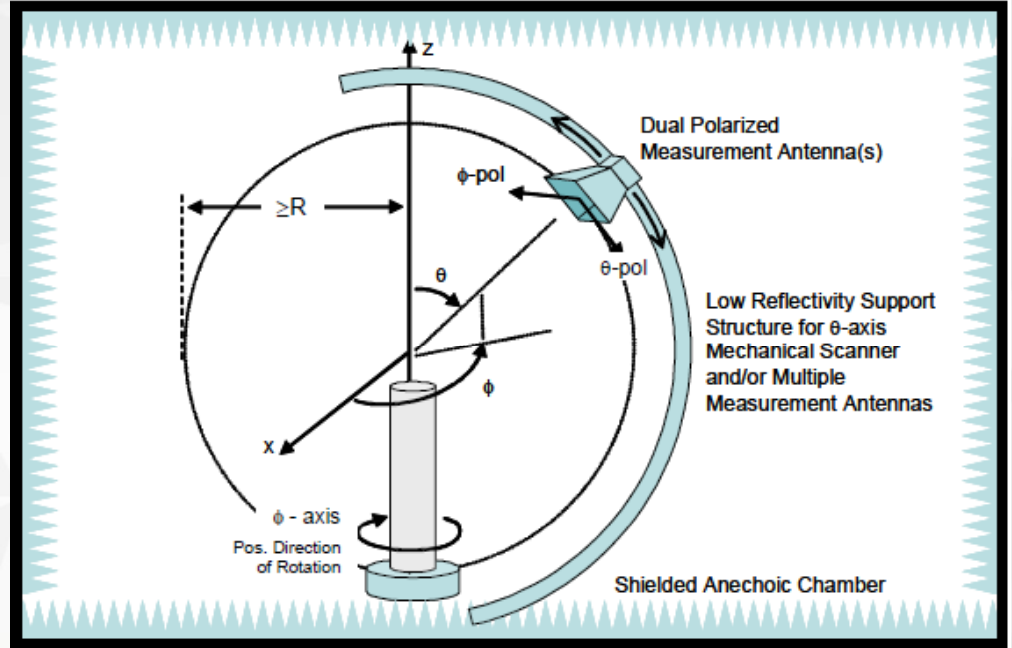

Distributed-Axes System

Anechoic Chamber

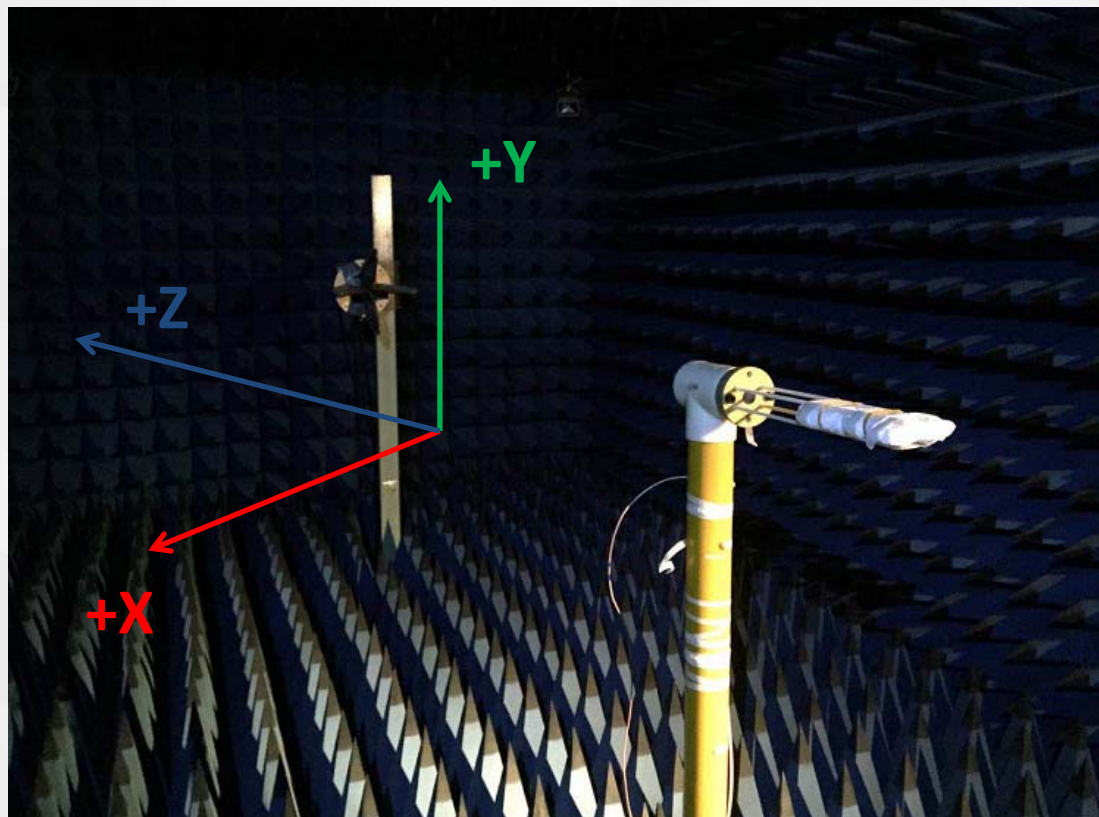

Combined-Axes System

Test Instrument

Generator	Agilent E4438C
Test Item	GPS

Radio Communication Tester	R&S CMW500
Test Item	Active Test

Network Analyzer	Agilent E5071C
Test Item	Passive Test

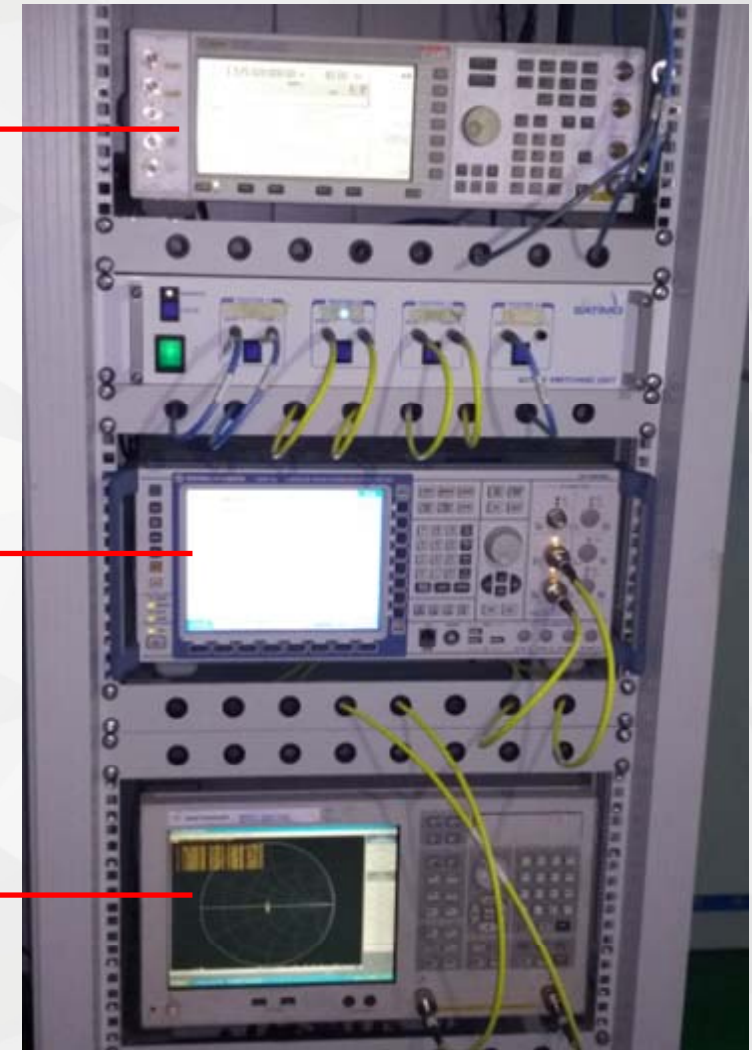

Test Fixture



S11 Return Loss



S11 VSWR



Gain/Efficiency

Freq.(MHz)	Gain(dBi)	Efficiency	Freq.(MHz)	Gain(dBi)	Efficiency
2400	0.25	51.60%	5150	-0.91	30.80%
2410	0.47	51.80%	5200	-0.69	40.60%
2420	-0.02	49.00%	5250	-0.67	41.30%
2430	-0.12	46.60%	5300	-0.19	44.20%
2440	-0.04	46.50%	5350	-0.92	36.70%
2450	-0.55	45.60%	5400	-0.02	43.40%
2460	-0.34	45.00%	5450	0.49	43.50%
2470	-0.11	44.70%	5500	0.65	41.00%
2480	-0.02	43.80%	5550	0.39	35.80%
2490	-0.11	43.40%	5600	1.09	42.70%
2500	-0.24	43.50%	5650	1.28	45.70%
			5700	0.48	37.10%
			5750	0.16	32.10%
			5800	1	36.40%
			5850	1.1	38.80%

Test Result

Frequency(GHz)	2.4	2.45	2.5
VSWR	1.29	1.4	1.54
Gain(dBi)	0.25	-0.55	-0.24

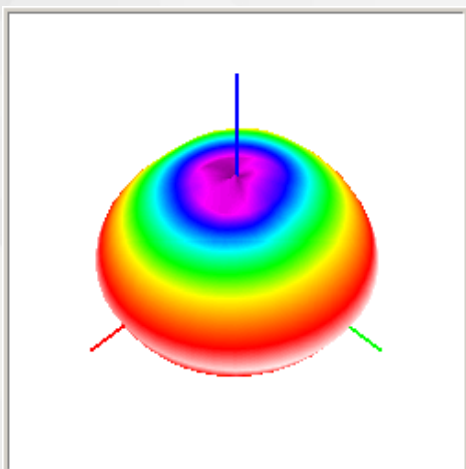

2.4GHz

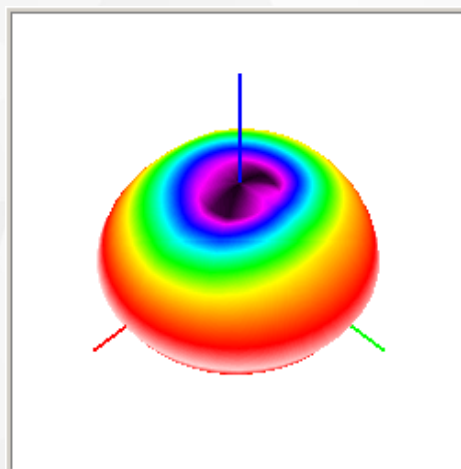

2.45GHz

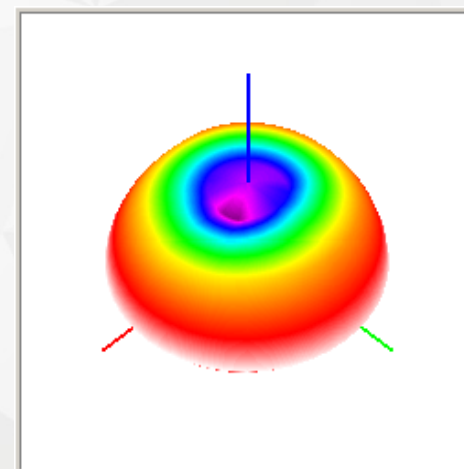

2.5GHz

Test Result

Frequency(GHz)	5.15	5.5	5.85
VSWR	2.64	1.8	1.18
Gain(dBi)	-0.91	0.65	1.1

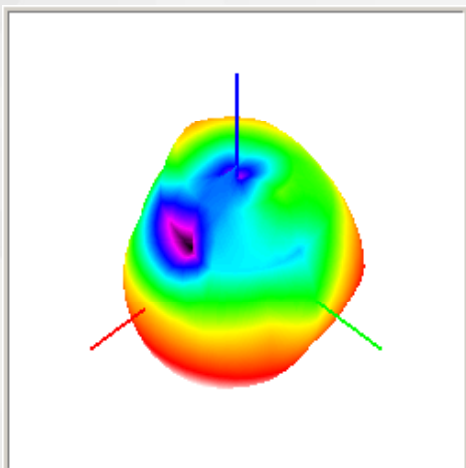

5.15GHz

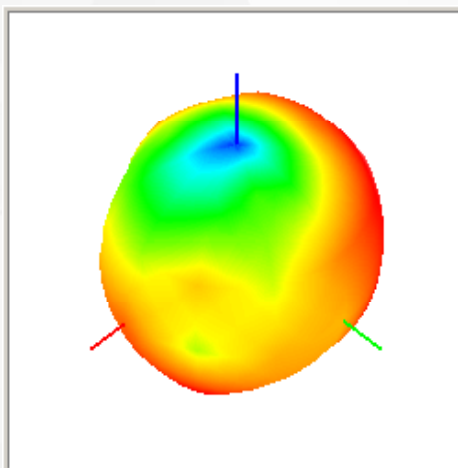

5.5GHz

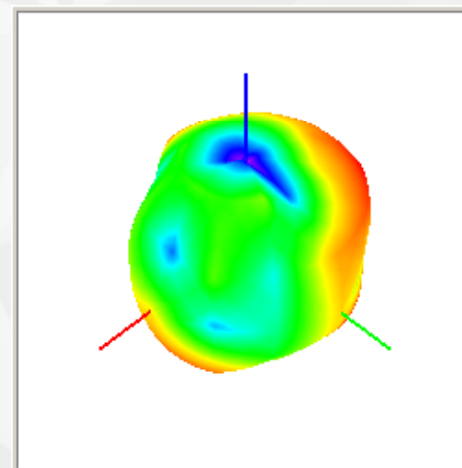

5.85GHz