

A70 5G Mobile Hotspot

User Manual

Model Number: RG3102



NOTE: All images and drawings in this document are examples only. The actual product may vary due to product options and upgrades.

Contents

Getting Started	1
<i>Overview</i>	2
System Requirements	2
<i>Components</i>	3
<i>Device Display</i>	4
<i>Battery Management</i>	5
Using Your A70 Mobile Hotspot	6
<i>Accessing the Network</i>	7
<i>Using Your A70 for the First Time</i>	7
System Requirements	7
Installing the SIM Card	7
Charging the Battery	8
<i>Connecting to Your A70</i>	8
Connecting via Wi-Fi	8
Connecting via USB cable	9
Connecting via Ethernet	9
A70 Settings	10
<i>Managing Your Mobile Hotspot</i>	11
Access Web Admin home page	11
Web Admin Page Security	11
<i>Web Admin Home</i>	12
<i>Home</i>	12
<i>Messages</i>	13
<i>Settings</i>	13
Wi-Fi	14
Mobile Network	17
Device	20
Advanced Router	23
<i>About</i>	28
<i>Support</i>	29
Troubleshooting	30
<i>Overview</i>	31
<i>First Steps</i>	31
<i>Common Problems and Solutions</i>	31
Regulatory Information	33
<i>Regulatory Statements</i>	34
FCC Equipment Authorization ID: XHG-RG3102	34

Body-Worn Operation	34
<i>Safety Hazards</i>	35
Glossary	37
<i>Glossary</i>	38

1

Getting Started

Overview
Components
Device Display
Battery Management

Overview

Thank you for choosing the A70 (model number: RG3102), your new 5G Mobile Hotspot!

With the A70, you'll enjoy the latest 5G and LTE networks for faster speeds. Connect up to 32 Wi-Fi devices at once, including laptops, tablets, eReaders, and smartphones and many more.

System Requirements

- Compatible with all IEEE802.11b/g/n/ac/ax/be Wi-Fi enabled devices.
- Works with the latest versions of most browsers*.

** We recommend using the latest version of your internet browser for optimal compatibility with the A70 Web Admin Home Page (<http://mobile.hotspot>). Older versions may not work as expected.*

Components



1. **Power Button** – Turn on / off the device.

	Operations	Actions
	Turn On	Press and hold the button until the display turns on.
	Turn Off	Press and hold the button until the display says Goodbye.
	Display Wake-Up	Press the button once to wake up the display when it is off for power saving.

2. **Touch Display** – Provides general information of the device status and device menu.
3. **Power Indicator Light** – Flashes when the device is powered on.
4. **Back Button** – Press to go back to previous screen.
5. **Home Button** – Press to go to the home screen
6. **Menu Button** - Press to see device setting menu
7. **Ethernet Port** – Connect your LAN cable here to connect via Ethernet
8. **USB Port** – Type C USB port. Connect the USB cable here to charge the battery.
9. **Battery Cover Notch** – Lift the notch to open the battery cover.
10. **Battery Cover** – The battery pack can be removed by opening the battery cover.

Device Display



- Status Icon Bar
- Wi-Fi Information
- Quick connect QR code

Status Icon Bar

Icons	Status
	Shows network signal strength.
	Shows network type the device is currently using
	Appears when the device is roaming on another network.
	Shows the number of connected devices on the Wi-Fi network.
	Shows SIM status (no SIM found, SIM PIN locked, SIM error)
	Appears when the USB port is tethering data
	Appears when the Ethernet port is connected
	Shows the battery status.

Wi-Fi Information: Displays Main and Guest Wi-Fi Network SSIDs and Password

Quick connect QR code: Press the icon to display QR code for quick scan and connection

Device Menu: Press menu button () to see device menu for information and settings

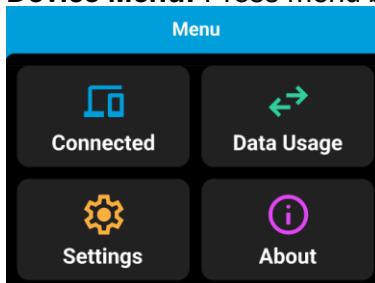

Touch menu icons to see information or to change settings.

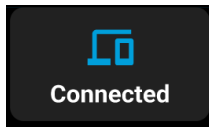

Connected

Displays the list of devices connected to your mobile hotspot.

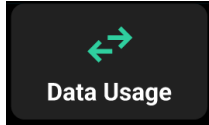

Data Usage

Displays data usage information.

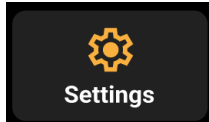

Settings

Change device settings.

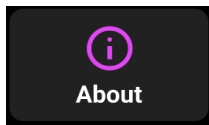

About

Displays device information.

Battery Management

Your A70 is equipped with a replaceable and rechargeable battery. It works from its charged battery alone or plugged into a power source.

Note: Please do not attempt to open or disassemble your mobile hotspot and the battery pack. Doing so may cause damage that voids your warranty. Charge the battery with the charger provided together with your mobile hotspot. While the battery is charging, the battery charging icon  displays.

IMPORTANT! Please use only the approved charger to charge your mobile hotspot. Improper handling of the charging port, as well as the use of an incompatible charger may cause damage to your device and void the warranty.

IMPORTANT! Please DO NOT use your mobile hotspot for a long period of time while it is connected to the charger. This can damage the battery and shorten its lifespan. When the battery is charged, it is recommended to disconnect the charger before continuing to use.

IMPORTANT! Avoid Exposure to High Temperatures: If it is exposed to high temperatures for long periods of time, the battery life can be severely shortened, and, in severe cases, it could swell or explode. It is recommended that mobile hotspots be stored in cool, well-ventilated area when not in use. Specifically, the temperature inside a vehicle can be extremely high. Please DO NOT leave the mobile hotspot inside vehicles or in high temperature location unattended.

2

Using Your A70 Mobile Hotspot

Accessing the Network
Using Your A70 for the First Time
Connecting to Your A70

Accessing the Network

Work effectively outside the home or office with the reliable broadband speed that 5G and LTE service provide. You can connect to the internet wirelessly at speed fast enough to keep up to date on all your email correspondence, to download attachments, and to access your corporate intranet and many more.

If your mobile hotspot has a SIM card inserted and service activated by your service provider, it will automatically connect to optimal wireless network upon powering on.

Using Your A70 for the First Time

System Requirements

Your computer, tablet, or other wireless devices need Wi-Fi capability and necessary software such as Internet browsers, email client. Your A70 is compatible with most major operating systems and the latest versions of browsers.

Installing the SIM Card

Your SIM (Subscriber Identity Module) card is a small rectangular plastic card that stores important information about your wireless service. If not already inserted, follow the instructions below to install your SIM card.

1. Remove the battery cover by lifting the notch on the cover, then take the battery out.
2. Slide your SIM card into the SIM card slot all the way with Wireless Carrier logo facing up.
3. Properly install the battery and put the battery cover back on.

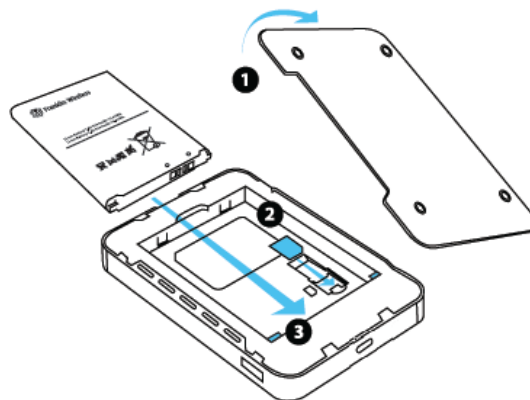

IMPORTANT! Do not bend or scratch your SIM card. Avoid exposing your SIM card to static electricity, water, or dirt. Whenever you insert or remove the SIM card, ensure your mobile hotspot is powered off and is not connected to any power source. Never use tools, knives, keys, or any type of object to force the door open or to remove the SIM card.

Charging the Battery

Before using your mobile hotspot, ensure that the battery is fully charged. Be sure to use the charger that came with your mobile hotspot.

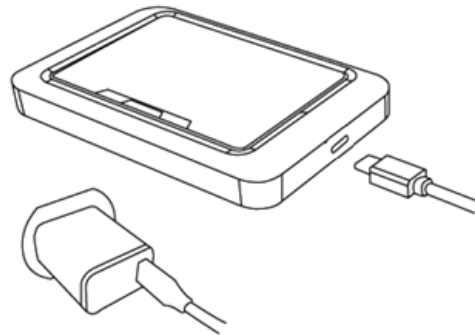

NOTE: Your mobile hotspot is equipped with a replaceable rechargeable battery. When handling the battery or SIM card, please make sure the device is not connected to any power sources. Do not use any tools, sharp objects or any utensils when dealing with the battery. Doing so may cause damage that voids your warranty.

- It normally takes 3~5 hours, depending on your power sources and device status to fully charge the battery.
- The battery discharges faster as more devices connect to your mobile hotspot.
- Battery life depends on the network, signal strength, temperature, features, and active connection time.
- When charging, keep your device near room temperature.
- Never leave the mobile hotspot unattended in high temperature such as inside a vehicle due to uncontrolled temperatures that may be outside the desired temperatures and damage your mobile hotspot.
- It is normal for batteries to gradually wear down and require longer charging time.

Connecting to Your A70

Connecting via Wi-Fi

Main and Guest Wi-Fi Names and Passwords can be found on the device display.

- 1 Open the Wi-Fi application or controls on your laptop or Wi-Fi capable device that you want to connect to your mobile hotspot.
- 2 Select the Wi-Fi name and enter the password when prompted

Your A70 is a wireless mobile hotspot creating Wi-Fi local networks that allow up to 32 Wi-Fi connections to Wi-Fi capable devices around it.

Connecting via USB cable

Connect your mobile hotspot to your computers with the USB cable provided. It will make data connection automatically.

NOTE: If not connecting, make sure you have USB connection enabled from device menu.
Menu > Settings > Connection Type > USB On

Connecting via Ethernet

Connect your mobile hotspot to your computers with an Ethernet cable (not included). It will make data connection automatically.

3

A70 Settings

Managing Your Mobile Hotspot
Web Admin Home
Messages
Settings
About
Support

Managing Your Mobile Hotspot

Access **Web Admin** home page

Once connection is set up between your devices and your A70 mobile hotspot, you can access the A70 Mobile Hotspot Web Admin home page from internet browsers on your device.

Access A70 Mobile Hotspot Web Admin home page.

- 1 Connect your device to A70 mobile hotspot.
- 2 Run a web browser on your device and open the Web Admin home page, <http://mobile.hotspot>
- 3 Click **Log in** and enter the password.

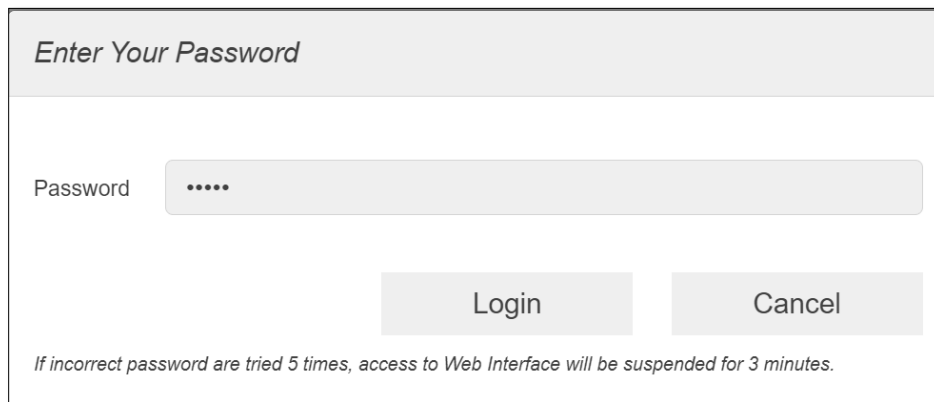

Enter Your Password

Password

Login Cancel

If incorrect password are tried 5 times, access to Web Interface will be suspended for 3 minutes.

NOTE: The default password is **admin**. On your first login using the default password, you will be guided to change the password. You must change the password on your first login to access the **Web Admin** page.

Web Admin Page Security

Your mobile hotspot comes from the factory with security turned on. On your first login using the default password, you will be guided to change the password.

You can change the **Web Admin** password from the **Web Admin** home page.

To change your **Web Admin** home page password:

- 1 Connect your device to your mobile hotspot.
- 2 Run an internet browser and open page <http://mobile.hotspot>
- 3 Go to **Settings > Device > Change password**

Web Admin Home

The **Web Admin** home page allows you to access to the following menu

- **Home**
- **Messages**
- **Settings**
- **About**
- **Support**

Home

Home menu shows network connection status, data usage information and usage alert settings.

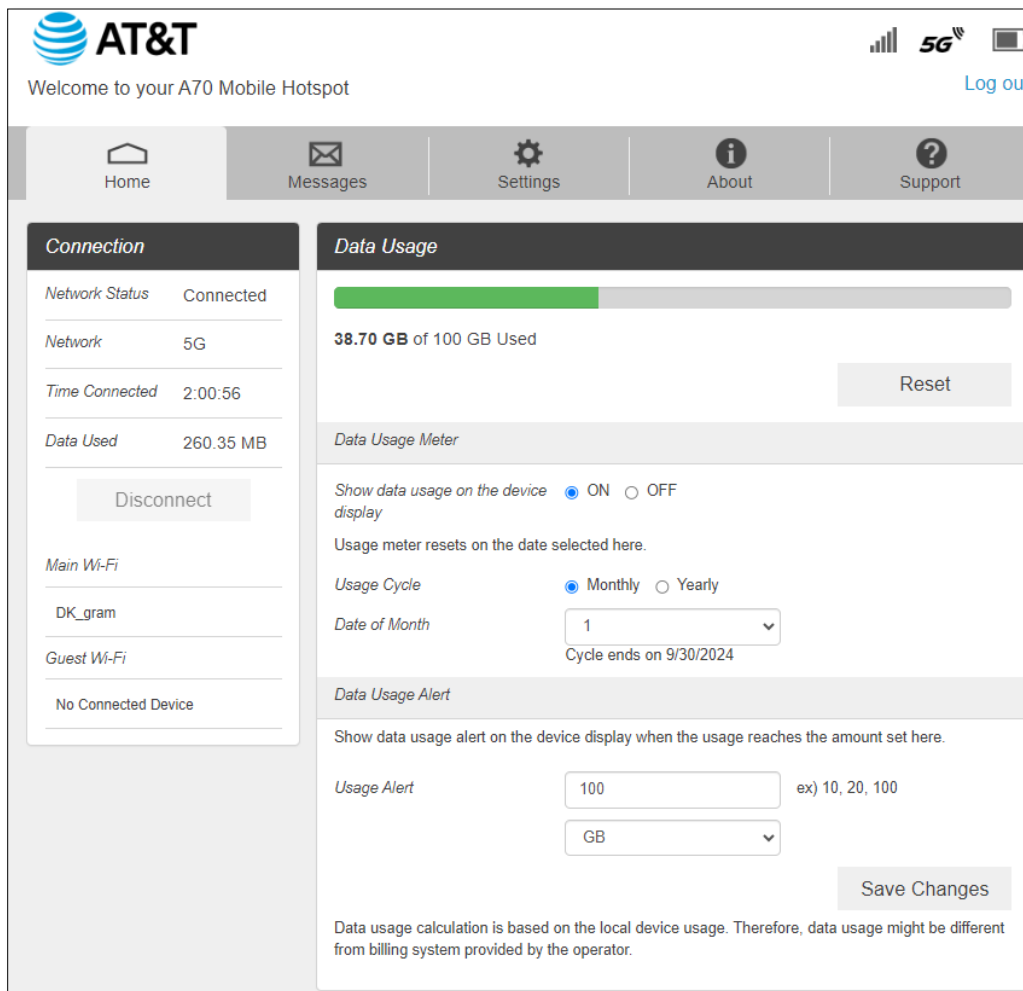

- Disconnect: Click Disconnect to disconnect the Internet. If Auto Connection is set ON, this button is inactive.
- Reset: Reset data usage meter.
- Data Usage Meter

- Show data usage on the device display: Select ON to show data usage meter on your device display.
- Usage Cycle: Select if the data usage meter resets monthly or yearly.
- Data of Month (Year): Select the date when the data usage meter resets.
- Usage Alert: Enter data usage amount and unit. You will see the alert message on your device display when data usage reaches the amount you set here.

Messages

Messages page displays SMS messages sent to your device.

Click on the message to see the full message content.

The green dots on the trash bin icon tell you the message is new and not been read.

To delete a selected message, click the trash bin icon.

To delete all messages, click **Delete All** button.

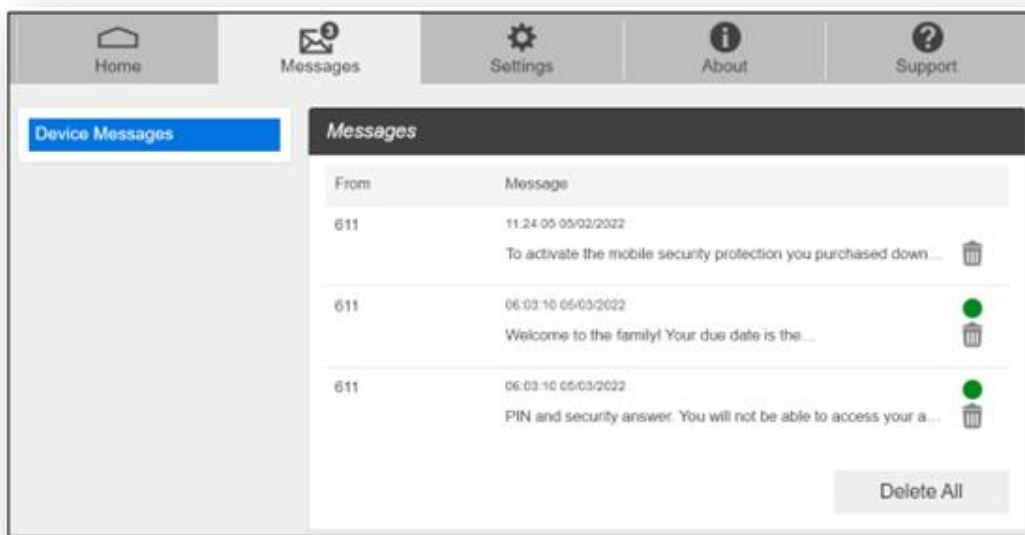

NOTE: Message service is not always available and depends on your service provider's policy for mobile hotspot.

Settings

The **Settings** page has the following menu options.

- **Wi-Fi**
- **Mobile Network**
- **Device**
- **Advanced Router**

Wi-Fi

Wi-Fi pages show you current Wi-Fi network settings. You can change Wi-Fi network settings.

- **Settings:** You can change Wi-Fi network settings.

The screenshot shows the 'Wi-Fi Basic Settings' page. At the top, there are navigation tabs for Home, Messages, Settings, About, and Support. A left sidebar menu is open, showing 'Wi-Fi' selected, with sub-options for Settings, Connected Devices, Mobile Network, Device, and Advanced Router. The main content area is titled 'Wi-Fi Basic Settings' and contains the following sections:

- Multi SSID:** Radio buttons for ON (selected) and OFF.
- Multi SSID Isolation:** Radio buttons for ON and OFF (selected).
- Main Wi-Fi:**
 - Wi-Fi Name (SSID): Text input field containing 'ATT-WIFI-F3A2'.
 - Wi-Fi Password: Text input field containing '8818c71d'.
 - Privacy Separator: Radio buttons for ON (selected) and OFF.
 - Hide Wi-Fi Name: Radio buttons for ON and OFF (selected).
 - Display Wi-Fi Name and Password on device: Radio buttons for ON (selected) and OFF.
- Advanced Settings:** A collapsed section.
- Guest Wi-Fi:**
 - Wi-Fi Name (SSID): Text input field containing 'ATT-WIFI-F3A2-Guest'.
 - Wi-Fi Password: Text input field containing 'daa919da'.
 - Enable Guest Mode (Web interface access will be restricted): Checked checkbox.
 - Privacy Separator: Radio buttons for ON (selected) and OFF.
 - Hide Wi-Fi Name: Radio buttons for ON and OFF (selected).
 - Display Wi-Fi Name and Password on device: Radio buttons for ON (selected) and OFF.
- Advanced Settings:** A collapsed section.
- Maximum Connections:**
 - Maximum Connections: Dropdown menu set to '32'.
 - Main Wi-Fi: Text input '1' with a '+' button.
 - Guest Wi-Fi: Text input '1' with a '+' button.
- Inactive Time:**
 - Inactive Time: Dropdown menu set to '10 Minutes'.
 - Text: 'Your mobile hotspot will go to sleep if no devices are connected for 10 minutes (you can change this setting). To wake it up, simply press any button.'
- Save Changes:** A button at the bottom right of the settings area.
- Wi-Fi Settings Reset:**
 - Text: 'This operation will return all Wi-Fi settings to the default.'
 - Reset:** A button at the bottom right of the reset section.

- **Multi SSID:** Select **ON** to set up a separate Guest Wi-Fi network.
- **Multi SSID Isolation:** Select **ON** to prevent your devices from communicating across the Main and Guest Wi-Fi networks.
- **Wi-Fi Name:** Wi-Fi Service Set Identifier (SSID).
- **Wi-Fi Password:** The password needs to be at least 8 characters long.

- **Privacy Separator:** Select **ON** to prevent your devices on the same Wi-Fi Name making Local Area Network communication.

NOTE: if you connect WLAN printer to your A70, Privacy Separator should be OFF for your connected devices to send files to the printer.

- **Hide Wi-Fi Name:** Select **ON** to stop the Wi-Fi name broadcasting. If this is set **ON**, you need to manually enter the Wi-Fi name to connect.
- **Display Wi-Fi Name and Password:** Select **OFF** to remove the Wi-Fi Name and Password display on your mobile hotspot main screen.
- **Guest Wi-Fi:** If Multi SSID is **ON**, Guest Wi-Fi menu appears. You can change Guest Wi-Fi settings.
- **Enable Guest Mode:** If the box is checked, devices on the Guest Wi-Fi network are not allowed to access **Web Admin** home page.
- **Advanced Settings:** Click to change advanced Wi-Fi settings

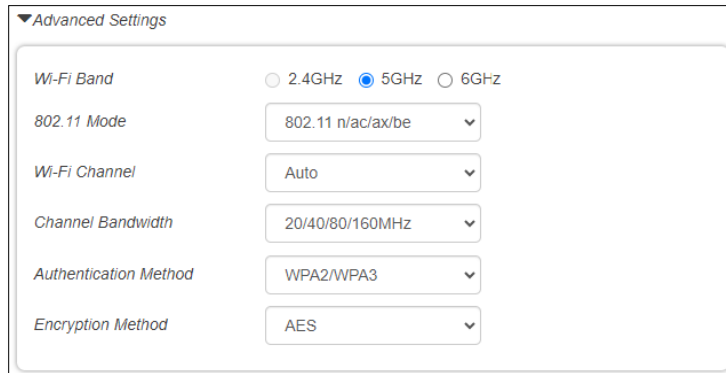

▼ Advanced Settings

Wi-Fi Band: 2.4GHz 5GHz 6GHz

802.11 Mode: 802.11 n/ac/ax/be

Wi-Fi Channel: Auto

Channel Bandwidth: 20/40/80/160MHz

Authentication Method: WPA2/WPA3

Encryption Method: AES

- Wi-Fi Band: Select 2.4GHz, 5GHz or 6GHz band of Wi-Fi spectrum.
- 802.11 Mode: Select 802.11 mode from the drop-down list.
- Wi-Fi Channel: Select a Wi-Fi channel from the drop-down list.
- Channel Bandwidth: Select channel bandwidth from the drop-down list.
- Authentication Method: Wi-Fi authentication method can be selected.

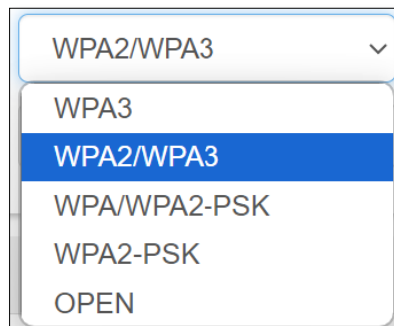

WPA2/WPA3

WPA3

WPA2/WPA3

WPA/WPA2-PSK

WPA2-PSK

OPEN

Mode	Description
WPA3	WPA3 is the latest, updated implementation of WPA2
WPA2/WPA3	Apply both the WPA2 and WPA3 scheme.
WPA/WPA2-PSK	Apply both the WPA-PSK and WPA2-PSK scheme.

WPA2-PSK	WPA-PSK is the securer version of WPA with implementation of the 802.11i standard.
OPEN	Authentication and encryption will not be performed. There are risks that private info will be intercepted or network will be used by unauthorized individuals.

- Encryption Method: Select an encryption method from the drop-down list.

- Maximum Connections: Choose the maximum number of devices allowed to connect to your mobile hotspot simultaneously.
- Inactive time: Your mobile hotspot will go to sleep if no devices are connected for set time here to save battery power.

NOTE: Default Inactive Time is 10 minutes. If there is no connection to your mobile hotspot for 10 minutes, it goes to sleep mode. Press any button gently once to wake up your mobile hotspot to continue using.

- Wi-Fi Settings Reset: Click the **Reset** button to reset all Wi-Fi settings to the factory default.

- **Connected Devices**

The Connected Devices menu contains the following options:

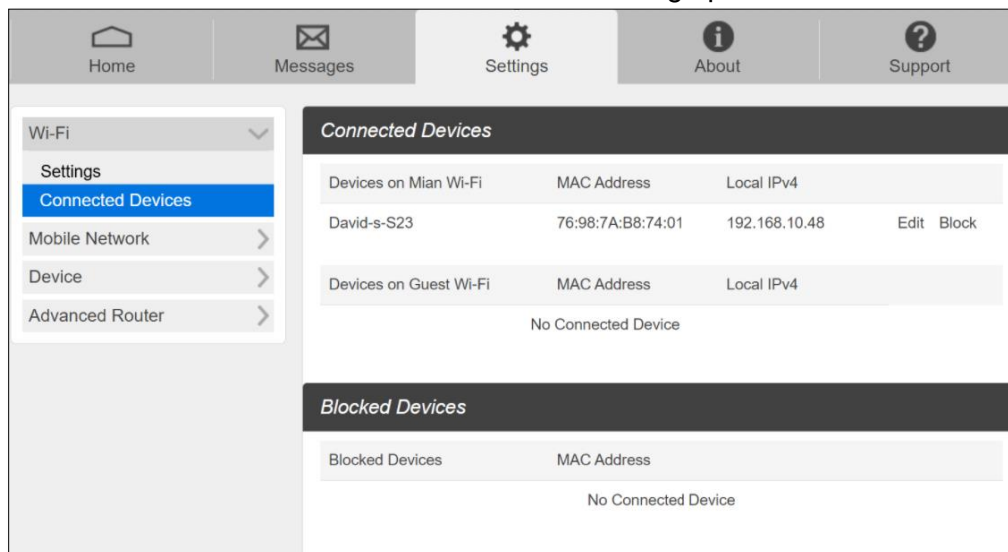

- Devices on Main/Guest Wi-Fi – The names of connected devices
- MAC Address – The MAC address is a unique identifier for each connected device.
- Local IPv4 – Assigned local IPv4 address

To edit device name:

1. Click **Edit**.
2. Update the name of the device and click **OK**.

To block connection:

1. Press **Block** on the list.

- The devices blocked will be listed on the **Blocked Devices**. The blocked devices will not be allowed to connect to your mobile hotspot Wi-Fi network
- To unblock the device, press **Unblock**.

Mobile Network

Mobile Network menu help you to manage your mobile network settings.

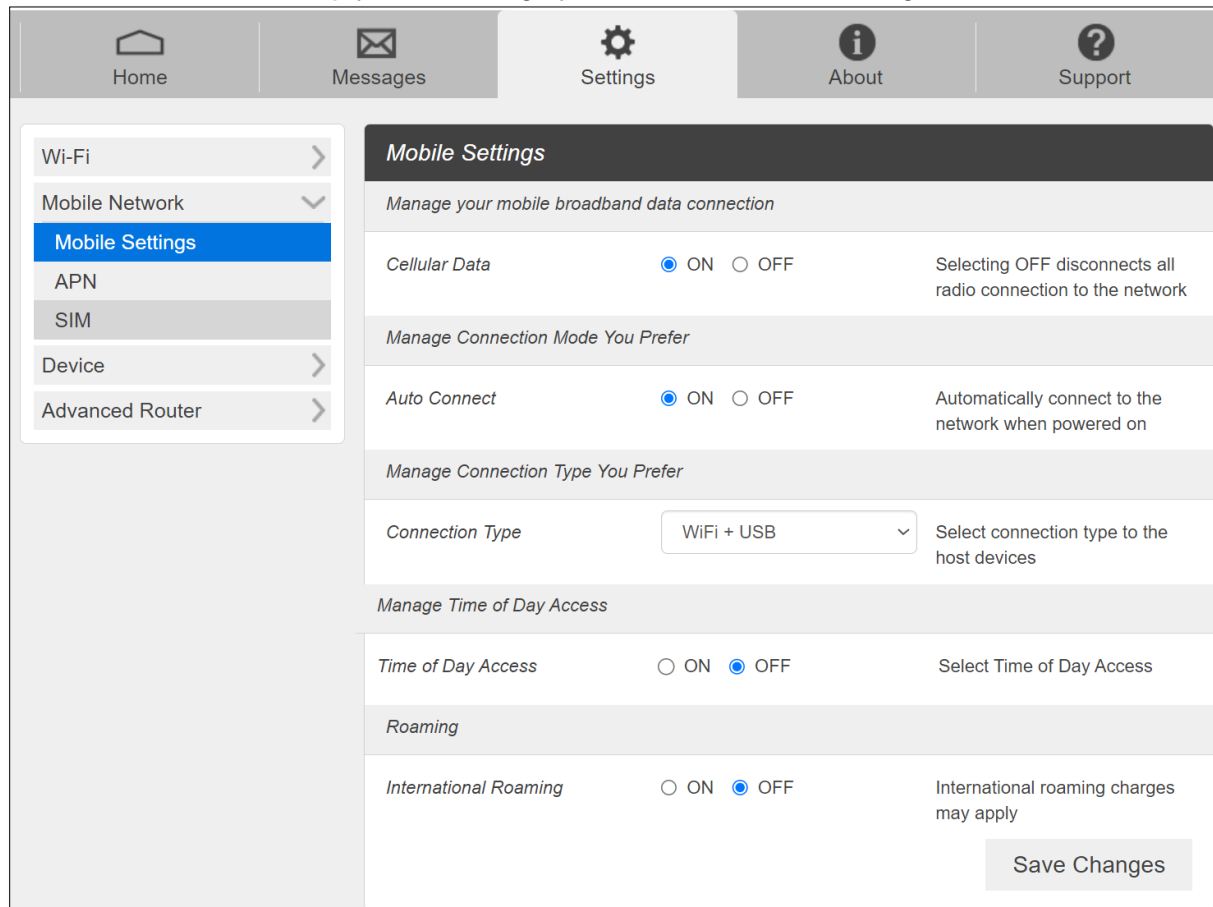

- **Mobile Settings**
 - Cellular Data: Selecting **OFF** disconnects all radio connections to the network.
 - Auto Connect: Select **ON** to make your device automatically connects to the network when it is powered on. If **OFF** is selected, you need to login the **Web Admin** home page to connect to the network manually every time you power on your mobile hotspot.
 - Connection Type: Select connection type between your devices and your mobile hotspot.
 - Time of Day Access: You can set the time windows per day allowing data connection. Once set, your mobile hotspot will not allow data connection beside the time windows.
 - International Roaming: Turn International Roaming **ON** or **OFF**.

CAUTION! Allowing international roaming could result in additional service charges. Please contact your service provider for more details.

- **APN**

APN menu shows current APN settings. You can add new APNs.

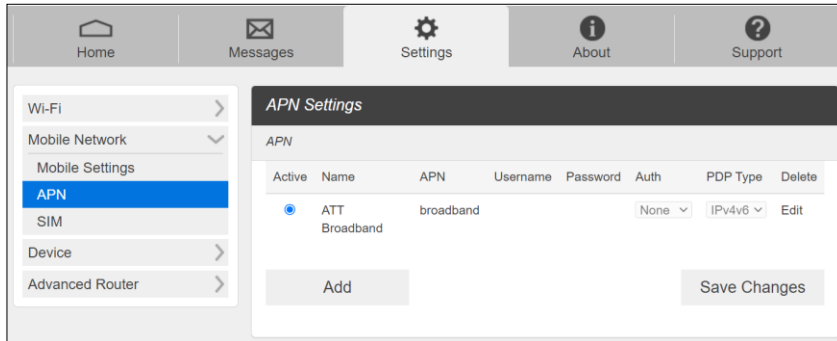

To add a new APN,

1. Click **Add** to add a line for a new APN information.

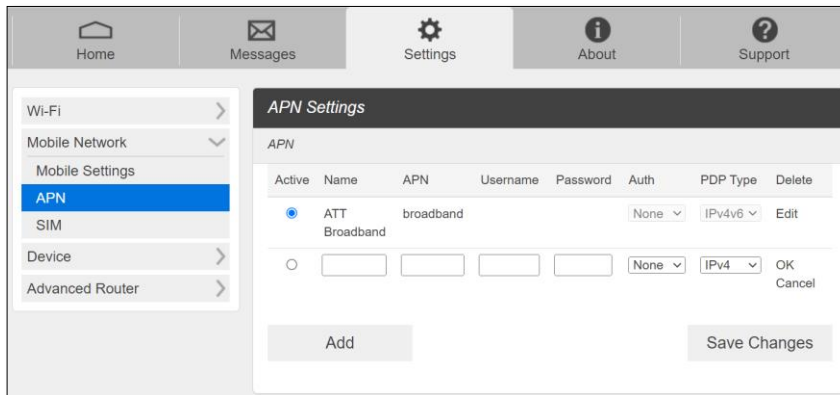

2. Enter the related parameters as described in the following table.

Parameters	Description
Name	Enter the APN profile name.
APN	Enter Access Point Name (APN) here. The Access Point Name (APN) is the name to set up a connection to the gateway between your service provider's cellular network and the public Internet.
Username	Username is used to obtain authentication from the ISP when the connection is established.
Password	Password is used to obtain authentication from the ISP when the connection is established.
Auth (Authentication)	Password Authentication Protocol (PAP) provides a simple method without encryption for the peer to establish its identity using a 2-way handshake. Challenge-Handshake Authentication Protocol (CHAP) is used to periodically verify the identity of the peer using a 3-way handshake.
PDP type	Select IP address type supported. IPv4, IPv6, IPv4v6

3. Click **OK** button once completing entering a new APN information

4. Click **Save Changes** to add the new APN.

Additional APN Options

- To select APN to use, click Active circle, then click **Save Changes**.
- To edit APN info, click **Edit**, change the settings, and then click **Save Changes**.
- To delete APN, click **Delete**.

CAUTION! Changing APN information could result in connection failure. Please contact your service provider before changing APN.

SIM

The **SIM** menu provides additional security by locking your SIM (Subscriber Identity Module) card with SIM PIN, or by locking / unlocking by your service provider.

The screenshot shows the SIM settings interface. At the top, there's a navigation bar with icons for Home, Messages, Settings, About, and Support. Below that is a sidebar menu with options: Wi-Fi, Mobile Network, Mobile Settings, APN, SIM (highlighted in blue), Device, and Advanced Router. The main content area is titled 'SIM' and is divided into two sections: 'SIM Pin Lock' and 'Carrier Unlock'. The 'SIM Pin Lock' section shows the status as 'Disabled', a dropdown for 'Desired Action' set to 'Enable PIN', and an input field for 'Enter Current PIN'. Below this, it states '3 attempts remain until your sim is PIN unblock code locked.' and a warning: 'Entering an incorrect PIN too many times will PIN unblock code lock your SIM and you will unable to use this device. You will need to contact your service provider to unlock the SIM.' A 'Save Changes' button is at the bottom right of this section. The 'Carrier Unlock' section shows the status as 'Locked', a dropdown for 'Desired Action' set to 'Carrier Unlock', and an input field for 'Enter Unlock Code'. An 'Unlock' button is at the bottom right of this section.

SIM Pin Lock

The SIM card inside your device can be locked with a PIN code for additional security. If locked, the PIN code must be entered before the mobile hotspot can connect to the Internet whenever you power on your device. You can also change the SIM PIN.

Enter the SIM PIN and press **Save Changes** to save your settings. The SIM Status will be changed to Enabled. Once the SIM PIN Lock is enabled, you need to enter SIM PIN to connect to the mobile broadband network each time you power on your mobile hotspot by logging in the **Web Admin** page.

NOTE: Contact your service provider for default SIM PIN code. If you enter the wrong SIM PIN three times, your SIM will be disabled permanently until you enter the PUK code from your service provider.

Carrier Unlock

Your A70 mobile hotspot could be locked by default to be used with a SIM card from your wireless service provider only. To use other SIMs from other wireless service provider, you need to unlock the carrier lock. Contact your service provider for carrier unlock code.

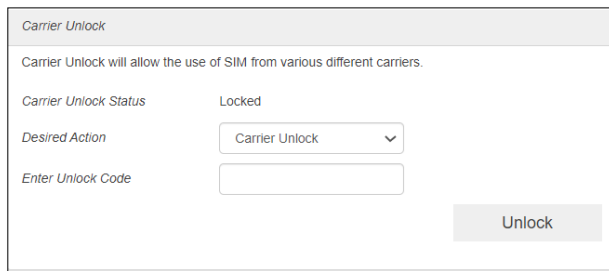

The Carrier Unlock settings page includes a title bar, a descriptive paragraph, a status field (Carrier Unlock Status: Locked), a dropdown menu for Desired Action (Carrier Unlock), an input field for Enter Unlock Code, and an Unlock button.

Device

- Preferences

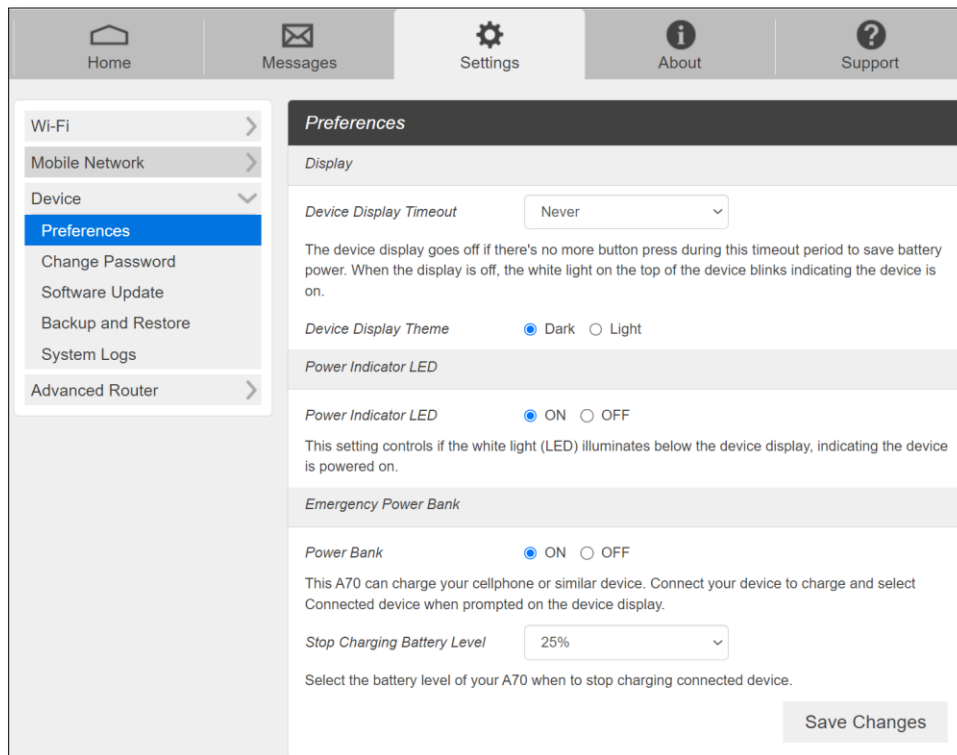

The Device Preferences settings page features a top navigation bar with Home, Messages, Settings, About, and Support. A left sidebar lists various settings categories, with Preferences selected. The main content area is titled 'Preferences' and includes sections for Display (Device Display Timeout: Never, Device Display Theme: Dark), Power Indicator LED (ON), Emergency Power Bank (Power Bank: ON), and Stop Charging Battery Level (25%). A Save Changes button is located at the bottom right.

- Device Display Timeout: Choose a timeout period from the dropdown menu. Your mobile hotspot's screen will turn off after this period of inactivity if no buttons are pressed.

- Device Display Theme: Select your preferred device display theme: dark or light.

- Power Indicator LED: This setting allows you to choose whether the white light (LED) flashes below the device display to indicate power. When the screen is off, the LED can be used to easily check if the device is still on.

- Power Bank: If **ON** is selected, your mobile hotspot can act as a power bank to charge your phone or other compatible devices. Connect your device and select **Connected device** when prompted on the screen.

- Stop Charging Battery Level: Choose the desired battery level for your mobile hotspot to stop charging the connected device.

- **Change Password**

You can change your **Web Admin** home page login password on this page.

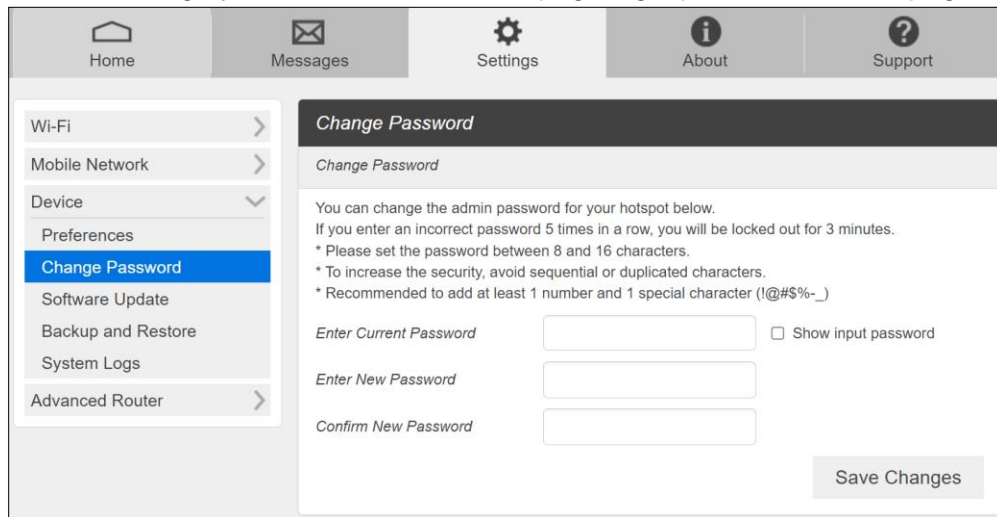

The screenshot shows the Web Admin interface with a navigation bar at the top containing Home, Messages, Settings, About, and Support. A left sidebar menu is open, showing options like Wi-Fi, Mobile Network, Device, Preferences, Change Password (highlighted), Software Update, Backup and Restore, System Logs, and Advanced Router. The main content area is titled 'Change Password' and contains the following text: 'You can change the admin password for your hotspot below. If you enter an incorrect password 5 times in a row, you will be locked out for 3 minutes. * Please set the password between 8 and 16 characters. * To increase the security, avoid sequential or duplicated characters. * Recommended to add at least 1 number and 1 special character (!@#%\$_-_)'. Below this text are three input fields labeled 'Enter Current Password', 'Enter New Password', and 'Confirm New Password'. There is also a checkbox labeled 'Show input password' and a 'Save Changes' button at the bottom right.

To change the password:

- Current Password: Enter the current password.
- New Password: Enter the new password.
- Confirm New Password: Enter the new password again.
- Click **Save Changes** to save your settings.

- **Software Update**

You can find the current software version and check for a new update available.

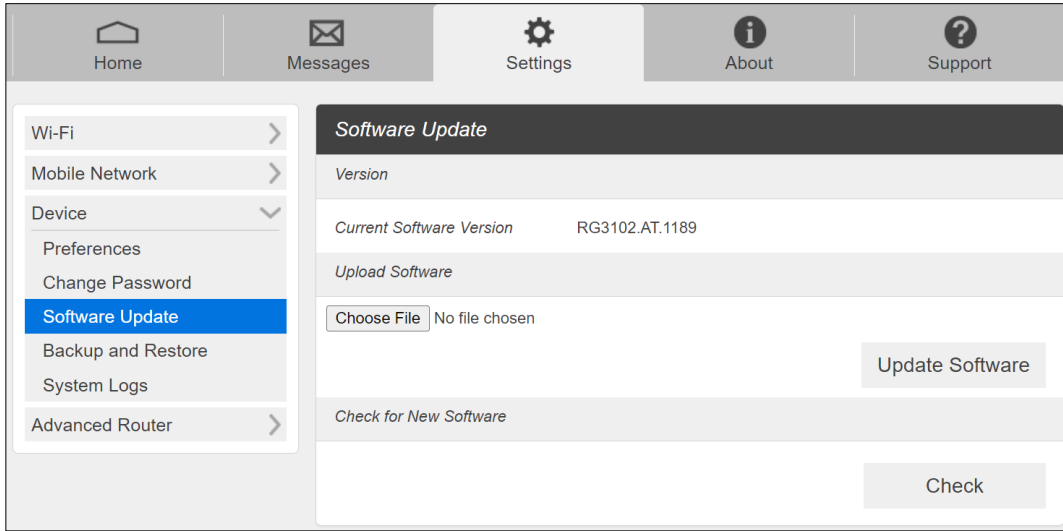

Manual Update: In case you have a new software file provided by your operator, select the file by pressing **Choose File**, then press **Upload Software** to update your device software.

Automatic Update: Click **Check** button. Message windows will pop up and guide you through the update process.

- **Backup and Restore**

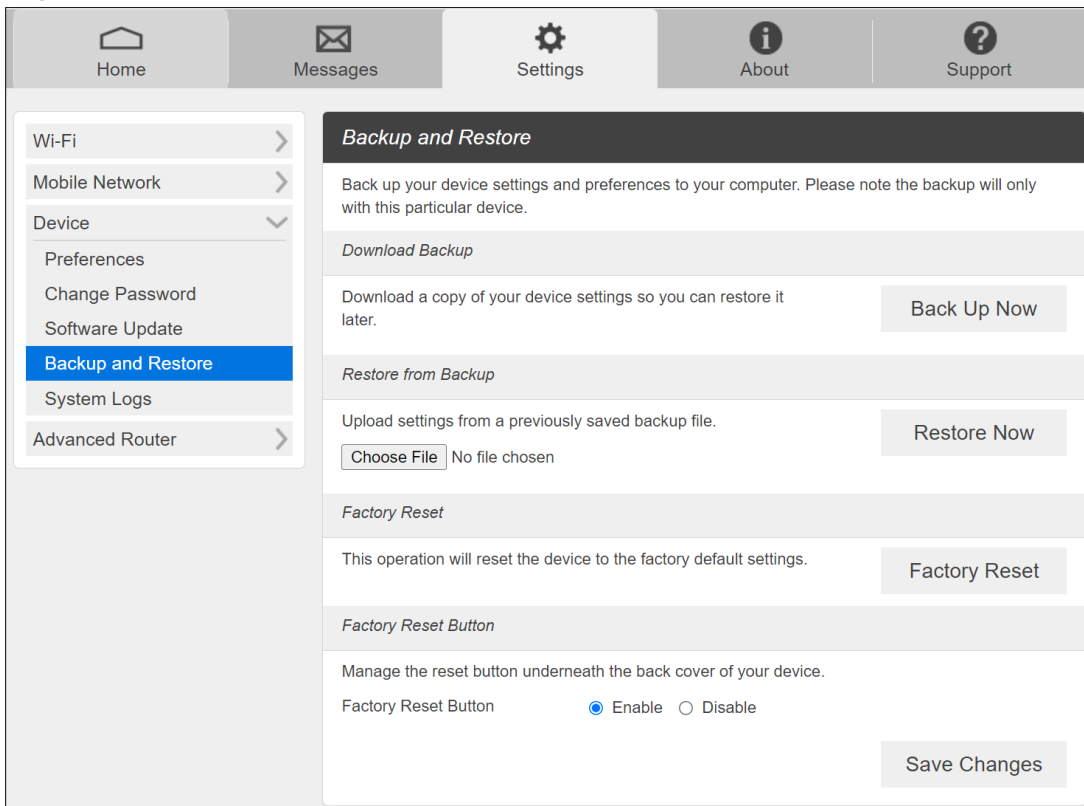

To back up your device settings into a file to your computer, click **Back Up Now** button. The backup setting file (hotspot_cfg.bin) will be created on the downloads folder of your device.

To restore the device setting from the backup file you made, follow the steps below:

- Click **Choose File** and select the backup file you saved.
- Click **Restore now**. Your mobile hotspot will restart.

To restore all your device settings to its factory default settings, follow the steps below:

- Click **Factory Reset**.
- Click **OK** to confirm the command.

Factory Reset Button: you can disable the physical factory reset button underneath the battery cover. If **Disable** is selected, pressing the button will not perform factory reset.

Advanced Router

Configure LAN, Firewall, and other Router settings.

- LAN Settings

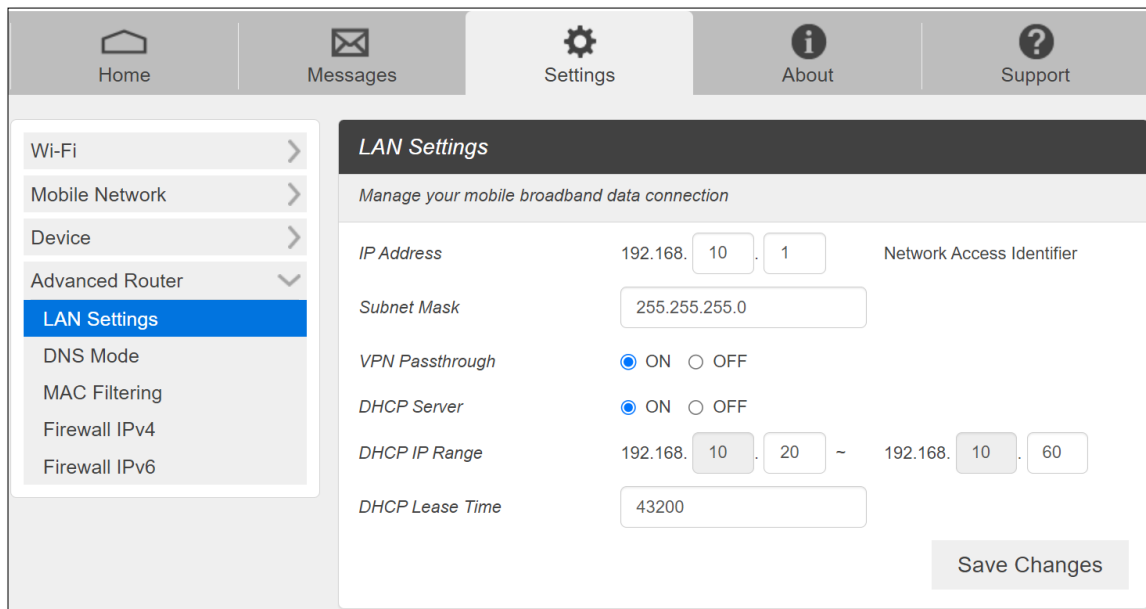

The screenshot displays the 'LAN Settings' page in the Mobile Hotspot Web Admin interface. The top navigation bar includes 'Home', 'Messages', 'Settings', 'About', and 'Support'. The left sidebar lists various settings, with 'LAN Settings' highlighted. The main content area is titled 'LAN Settings' and includes the subtitle 'Manage your mobile broadband data connection'. The settings are as follows:

Setting	Value	Additional Info
IP Address	192.168.10.1	Network Access Identifier
Subnet Mask	255.255.255.0	
VPN Passthrough	<input checked="" type="radio"/> ON <input type="radio"/> OFF	
DHCP Server	<input checked="" type="radio"/> ON <input type="radio"/> OFF	
DHCP IP Range	192.168.10.20 ~ 192.168.10.60	
DHCP Lease Time	43200	

A 'Save Changes' button is located at the bottom right of the settings area.

- **IP address** – The IP address for your Mobile Hotspot **Web Admin** page. This is also a default gateway IP of your device.
- **Subnet mask** – The Subnet mask network setting for your mobile hotspot. The default value 255.255.255.0 is standard for small (class “C”) networks.

- **VPN Passthrough** – When turned **ON**, this feature allows VPN clients on your connected device to connect through your mobile hotspot to remote VPN servers.
- **DHCP (Dynamic Host Configuration Protocol) server** – The **DHCP server** is **ON** by default. When turned **ON**, your mobile hotspot automatically assigns local IPs to the devices connected to your mobile hotspot. When turned **OFF**, you will need to set it up manually from the device you want to connect to your mobile hotspot.
- **DHCP IP Range** – Defines the local IP range that DHCP server assigns to connected devices.
- **DHCP Lease Time** - The period between when your connected device obtained its IP address from your mobile hotspot and the time when it expires. When the **DHCP lease time** expires, your connected device automatically releases IP address and asks your mobile hotspot to assign a new one.

- DNS Mode

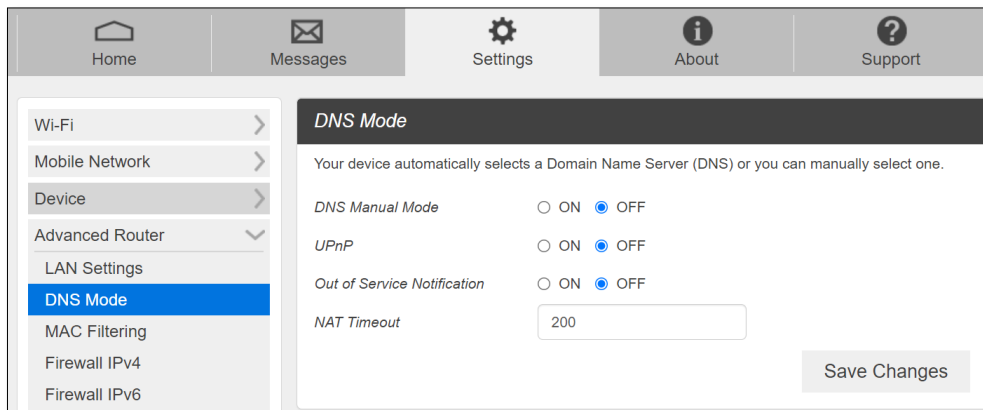

- **DNS Manual Mode-** Your mobile hotspot uses Domain Name Servers (DNS) assigned by your network by default. The **DNS Manual Mode** option allows you to use your own DNS service if you have.

To manually set a Domain Name Server:

1. Click the **ON** button to enable **DNS Manual Mode**.
 2. Enter the IP address of the first DNS in the **DNS 1 IP address** field.
 3. Enter the IP address of the second DNS in the **DNS 2 IP address** field.
 4. Click **Save Changes** button.
- **UPnP** - Universal Plug and Play (UPnP) is a network protocol that allows compliant devices to automatically set port forwarding rules for themselves. These devices can be personal computers, printers, security cameras, game consoles or mobile devices that communicate with each other and share data over your network
 - **Out of Service Notification:** Notify when DNS service is not working
 - **NAT Timeout** - NAT session timeout is the length of time that the router will keep that connection even if it is inactive. After that, the router will remove the entry, and stop accepting the incoming traffic.

- **MAC Filtering**

The MAC filtering allows only selected devices to access your mobile hotspot Wi-Fi network. By default, MAC filtering is turned **OFF**.

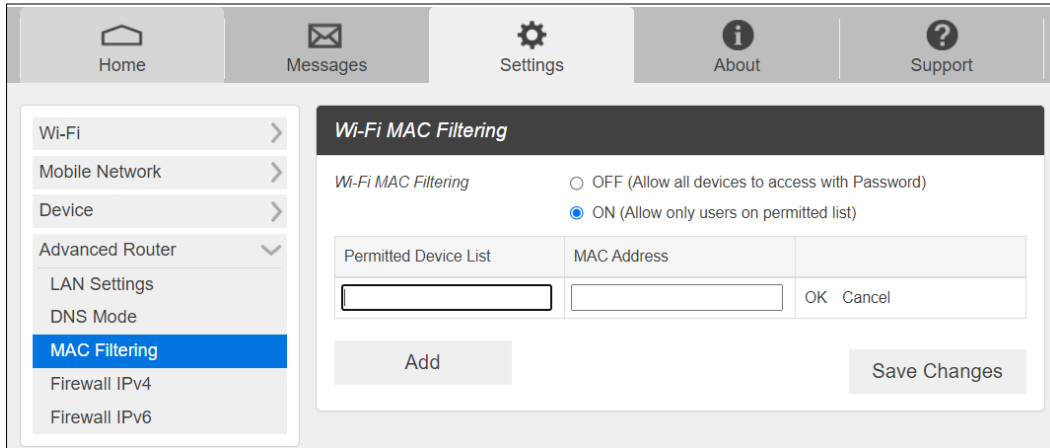

To enable MAC Filtering,

1. Select **ON**.
2. Press **Add** to add a line to enter device name and MAC address, then click OK. When entering MAC addresses, use “:” as the separators (for example, c2:b5:d7:27:fb:9b). To add more, press **Add** to add another line.
3. When completed adding devices, press **Save Changes**.

NOTE: If MAC filtering is on and at least one device is listed, only the listed devices can access your A70 Wi-Fi network. The MAC filtering has no effect on devices connected via USB connection nor Ethernet connection.

- **Firewall IPv4**

You can set up firewall rules to protect your network from virus and malicious activity on the Internet.

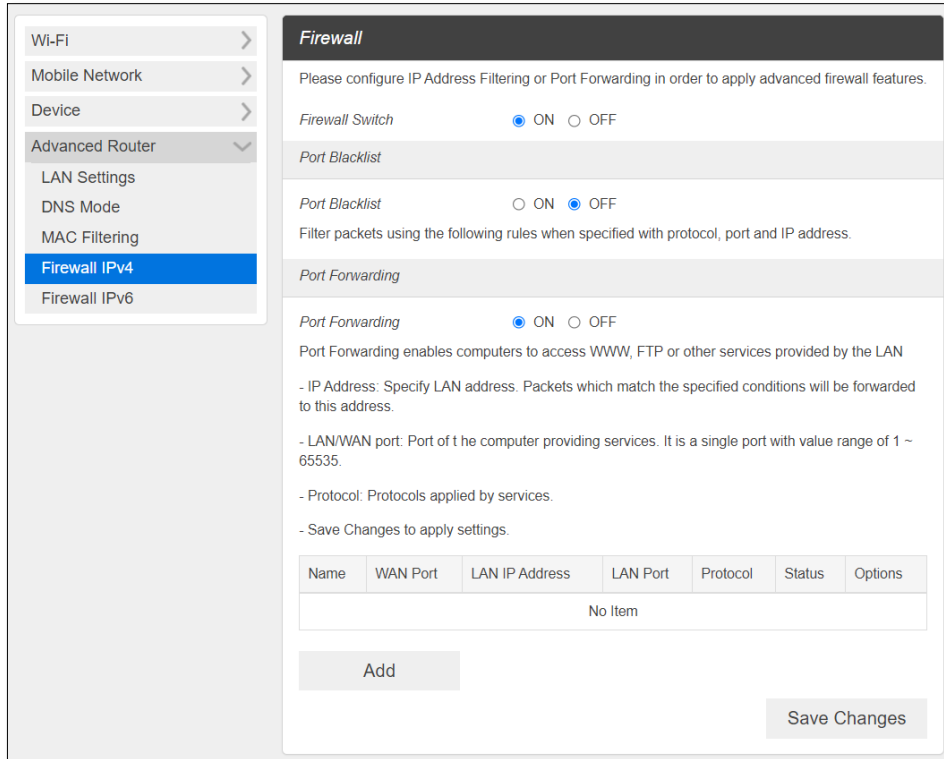

- **Firewall Switch** – To set up Port Blacklist or Port Forwarding, turn Firewall Switch **ON**. If Firewall Switch is **OFF**, both Port Blacklist and Port Forwarding settings are not active.
- **Port Blacklist** – You can block outbound forward packet by setting up a rule in the blacklist. To set up the rule,
 1. Turn **ON** Port Blacklist.
 2. Press **Add** to create a line to setup a rule.
 3. Enter the name of the rule you want to set up.
 4. Enter IP address of the site you want to restrict outbound forward packet.
 5. Enter Port number of the outbound forward packet.
 6. Select Protocol and Status **ON/OFF**: **ON** means the rule is in active. **OFF** means the rule is not active.
 7. Press **OK** to complete set up, then press **Save Changes**.
- **Port Forwarding** – You can allow inbound packet for specific port number by setting up port forwarding rule. To set up Port Forwarding,
 1. Turn **ON** Port Forwarding.
 2. Press **Add** to create a line to set up a rule.
 3. Enter the name of the rule you want to set up.
 4. Enter WAN port number of allowed inbound forward packet.
 5. Enter LAN IP address your connected device that is assigned by your mobile hotspot.
 6. Enter LAN port number of allowed inbound forward packet.

7. Select Protocol and Status **ON/OFF**: **ON** means the rule is in active. **OFF** means the rule is not active.
8. Press **OK** to complete set up, then press **Save Changes**.

- **Firewall IPv6**

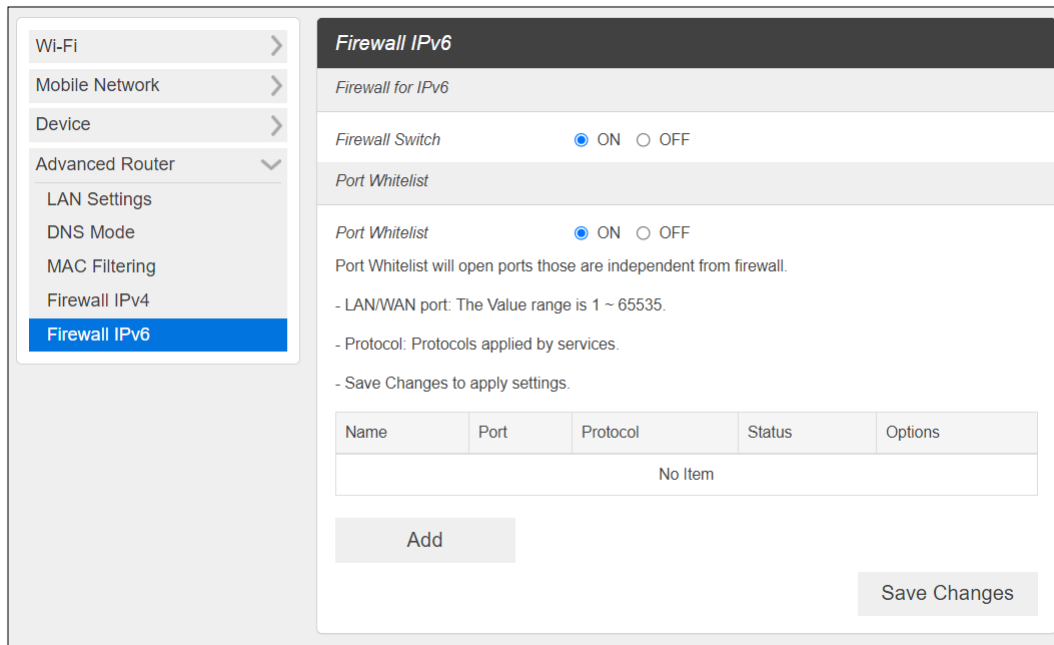

- **Firewall Switch** – To set up Port Whitelist, turn Firewall Switch **ON**. If Firewall Switch is **OFF**, Port Whitelist settings is not active.
- **Port Whitelist** – You can allow inbound forward packet of specific port number by setting up Port Whitelist. To set up Port Whitelist,
 1. Turn **ON** Port Whitelist.
 2. Press **Add** to create a line to set up a rule.
 3. Enter the name of the rule you want to create.
 4. Enter the port number you want to allow inbound forward packet.
 5. Select Protocol and Status **ON/OFF**: **ON** means the rule is in active. **OFF** means the rule is not active.
 6. Press **OK** to complete set up, then press **Save Changes**.

About

View your device's connection information, firmware information, WWAN information, Wi-Fi details and other information.

The screenshot displays the 'About' settings page with a navigation bar at the top containing icons for Home, Messages, Settings, About, and Support. The main content is organized into several sections:

- Account**:
 - My Number: 15122179037
 - ICCID: 89011003300087391167
 - IMSI: 313100008739116
 - IMEI: 354907400000632
- Device**:
 - Model: RG3102
 - Manager: mobile.hotspot
 - Hardware Revision: P1
 - Power State: Online
 - Current Voltage: 4.199V
 - Battery Charge Level: 100%
 - Battery Status: Charged
- Wi-Fi Details**:
 - Wi-Fi Name: ATT-WIFI-F3A2
 - Wi-Fi Password: 8818c71d
 - MAC Address: F4:63:49:E9:F3:A2
 - Encryption: WPA2WPA3 AES
 - Wi-Fi Devices: 1
 - Max Wi-Fi Devices: 32
 - Broadcast Network Name: Show
- Firmware**:
 - Software Version: RG3102.AT.1189
 - Modem Version: RG3102.AT.M1189
- WWAN Info**:
 - IP Address: 10.66.116.0, 2600:381:3382:5b57:815d:1306:3c05:3224
 - Lifetime Transferred: 40.87 GB

A 'Save to File' button is located below the WWAN Info section. At the bottom of the page, there is a 'Debug Info' section with the text 'View detailed diagnostic information about your device.' and a 'Debug' button.

Support

Obtain support information from the **Web Admin** page Support Tab.

The screenshot shows a web interface with a top navigation bar containing five items: Home (house icon), Messages (envelope icon), Settings (gear icon), About (info icon), and Support (question mark icon). The Support tab is active. Below the navigation bar, there are four main content areas arranged in a 2x2 grid:

- User Guide:** A dark header with the text "User Guide" and a "Download" button below it.
- Terms and Conditions:** A dark header with the text "Terms and Conditions" and an "Open" button below it.
- AT&T Web Address:** A dark header with the text "AT&T Web Address". Below it, there is a link "Device Support" and a paragraph: "Go to Support, find information on your device along with videos, tutorials, and community forums for your device."
- Customer Care:** A dark header with the text "Customer Care" and the phone number "800-331-0500" below it.

At the bottom right, there is a **Manufacturer** section with a dark header and the link "franklinwireless.com" below it.

4

Troubleshooting

Overview
First Steps
Common Problems and Solutions

Overview

The following tips can help solve many common problems encountered while using your Mobile Hotspot, A70.

First Steps

- 1 Make sure you are using your A70 in the correct geographic region (within coverage of your service provider).
- 2 Ensure that your wireless coverage extends to your current location by using the interactive Wireless Carrier's coverage map tool.
- 3 Ensure that you have an active service plan.
- 4 Restarting your computer and your A70 can resolve many issues.

IMPORTANT! Before contacting customer care, be sure to restart both your A70 and any host devices that are currently connected to your A70.

Common Problems and Solutions

A70 is just powered off without pressing the Power/Menu button. Why?

This may occur under battery depletion or overheating from excessive usage for a long time. To restore power, manually press and hold the power button to turn on your A70. If the battery is depleted, charge the battery with the AC charger provided.

IMPORTANT! If the power button will not start your A70, please open the battery cover, take out the battery and re-install the battery after 5 seconds. Put the battery cover back and turn on the A70 by pressing the power button.

How do I perform Factory Reset?

Using Web Admin Home page: Connect to your A70 and then open **Web Admin** home page (<http://mobile.hotspot>). Select **Settings > Device > Backup and Restore** and Click **Factory Reset**.

Using Mobile Hotspot Device Menu: Select **Settings** on the device display, then go to Factory Reset menu. Select **OK** to perform Factory Reset.

Using the Factory Reset Button on the device: Remove the battery cover. Make sure the battery is installed and your A70 is powered on. Press down the reset button for 3 seconds and release. Then, your A70 will perform the reset and restart automatically.

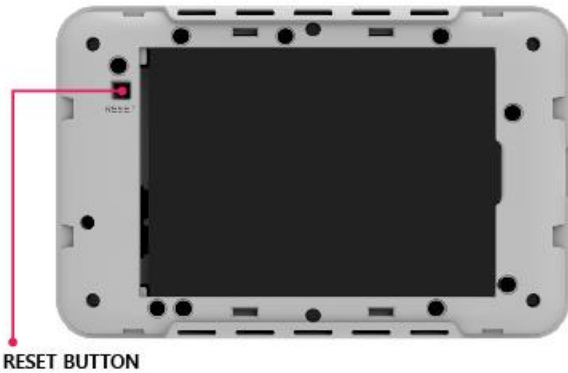

I cannot connect to Wi-Fi after changing Wi-Fi password.

Your Wi-Fi devices save the previously used Wi-Fi names associated with the passwords used to access the Wi-Fi name. When you change the Wi-Fi password only for your A70 and keep the same Wi-Fi Name, the devices try to connect to your A70 using the Wi-Fi name and previous Wi-Fi password saved, causing Wi-Fi authentication error. Perform “forget” first on the Wi-Fi name from your host devices.

I cannot access the Web Admin, <http://192.168.10.1>

Ensure that Wi-Fi connection is enabled on your device and that you have selected the correct Wi-Fi name (SSID) for your A70 connection. Also, make certain that you are entering the correct full URL address as <http://192.168.10.1> or <http://mobile.hotspot>.

If you changed the LAN IP settings from the **Web Admin, Settings > Advanced Router > LAN Settings** before, you need to use the IP address you changed to access the **Web Admin** page.

I cannot log into Web Admin, <http://mobile.hotspot>

Ensure that you are entering the correct **Web Admin** password to log in. The default **Web Admin** login password is “admin” unless you have previously changed. If you have forgotten your password, perform Factory Rest on your device (see How do I perform Factory Reset?).

5

Regulatory Information

Regulatory Statements
Safety Hazards

Regulatory Statements

FCC Equipment Authorization ID: XHG-RG3102

This device complies with Part 15 of the FCC Rules. Operation is subject to the following two conditions: (1) this device may not cause harmful interference, and (2) this device must accept any interference received, including interference that may cause undesired operation.

SAR Information

The exposure standard for your device uses a unit of measurement called the Specific Absorption Rate (“SAR”).

SAR is the unit of measurement for the amount of RF energy absorbed by the body when using a mobile device. Although the SAR is determined at the highest certified power level, the actual SAR value of the device while in operation can be well below the level reported to the FCC. This is due to a variety of factors including its proximity to a base station, the design of the device and other factors. What is important to remember is that each device meets strict Federal Government guidelines. Variations in SARs do not represent a variation in safety. All devices must meet the federal standard, which incorporates a substantial margin of safety. SAR values at or below the federal standard of 1.6 watts/kg (W/kg) are considered safe for use by the public. This product meets current FCC Radio Frequency Exposure Guidelines.

Additional details at FCC website:

www.fcc.gov/oet/ea

The max 1g SAR is 1.18 W/kg when tested for use worn on the body at 10mm)

Body-Worn Operation

Please note this important safety information regarding radio frequency (RF) radiation exposure and near-body operation. To ensure compliance with RF exposure guidelines, the device must be used at least 10 mm from your body. Failure to observe this warning could result in RF exposure exceeding the applicable guideline limits.

This equipment has been tested and found to comply with the limits for a Class B digital device, pursuant to part 15 of the FCC Rules. These limits are designed to provide reasonable protection against harmful interference in a residential installation.

This equipment generates, uses, and can radiate radio frequency energy and, if not installed and used in accordance with the instructions, may cause harmful interference to radio communications. However, there is no guarantee that interference will not occur in a particular installation. If this equipment does cause harmful interference to radio or television reception, which can be determined by turning the equipment off and on, the user is encouraged to try to correct the interference by one or more of the following measures:

- Reorient or relocate the receiving antenna.
- Increase the separation between the equipment and receiver.
- Connect the equipment into an outlet on a circuit different from that to which the receiver is connected.
- Consult the dealer or an experienced radio/TV technician for help.

FCC CAUTION: Any changes or modification not expressly approved by the party responsible for compliance could void the user's authority to operate this equipment.

NOTE: The Radio Frequency (RF) emitter installed in your modem must not be located or operated in conjunction with any other antenna or transmitter, unless specifically authorized by Franklin Wireless.

Safety Hazards

Follow Safety Guidelines

Always follow the applicable rules and regulations in the area in which you are using your device. Turn your device off in areas where its use is not allowed or when its use may cause interference or other problems.

Electronic Devices

Most modern electronic equipment is shielded from radio frequency (RF) signals. However, inadequately shielded electronic equipment may be affected by the RF signals generated by your device.

Medical and Life Support Equipment

Do not use your device in healthcare facilities or where medical life support equipment is located as such equipment could be affected by your device's external RF signals.

Pacemakers

- The Health Industry Manufacturers Association recommends that a minimum separation of six inches must be maintained between a device and a pacemaker in order to avoid potential interference with the pacemaker. These recommendations are consistent with the independent research by and recommendations of Wireless Technology Research. Persons with pacemakers should always follow these guidelines:
- Always keep the device at least six inches away from a pacemaker when the device is turned on.
- Place your device on the opposite side of your body where your pacemaker is implanted in order to add extra distance between the pacemaker and your device.
- Avoid placing a device that is on next to a pacemaker (e.g., do not carry your device in a shirt or jacket pocket that is located directly over the pacemaker).
- If you are concerned or suspect for any reason that interference is taking place with your pacemaker, turn your device OFF immediately.

Hearing Devices

When some wireless devices are used with certain hearing devices (including hearing aids and cochlear implants) users may detect a noise which may interfere with the effectiveness of the hearing device.

Use of Your Device while Operating a Vehicle

Please consult the manufacturer of any electronic equipment that has been installed in your vehicle as RF signals may affect electronic systems in motor vehicles.

Please do not operate your device while driving a vehicle. This may cause a severe distraction, and, in some areas, it is against the law.

Use of Your Device on an Aircraft

Using your device during flight may violate FAA regulations. Because your device may interfere with onboard electronic equipment, always follow the instructions of the airline personnel, and turn your device OFF when instructed to do so.

Blasting Areas

In order to avoid interfering with blasting operations, your device should be turned OFF when in a blasting area or in an area with posted signs indicating that people in the area must turn off two-way radios. Please obey all signs and instructions when you are in and around a blasting area.

Proper Battery & Adapter Use and Disposal

- Do not disassemble or open crush, bend or deform, puncture or shred.
- Do not modify or remanufacture, attempt to insert foreign objects into the battery, immerse or expose to water or other liquids, expose to fire, explosion, or another hazard.
- Only use the battery for the system for which it is specified.
- Only use the battery with a charging system that has been qualified with the system per CTIA Certification Requirements for Battery System Compliance to IEEE 1725. Use of an unqualified battery or charger may present a risk of fire, explosion, leakage, or another hazard.
- Do not short circuit a battery or allow metallic conductive objects to contact battery terminals.
- Replace the battery only with another battery that has been qualified with the system per this standard, IEEE-Std-1725. Use of an unqualified battery may present a risk of fire, explosion, leakage, or another hazard. Only authorized service providers shall replace the battery.
- Promptly dispose of used batteries in accordance with local regulations.
- Battery usage by children should be supervised.
- Avoid dropping the battery. If the battery is dropped, especially on a hard surface, and the user suspects damage, take it to a service center for inspection.
- Improper battery use may result in a fire, explosion, or another hazard.
- The host device shall only be connected to CTIA certified adapters, products that bear the USB-IF logo or products that have completed the USB-IF compliance program.

Document Revision History

Revision: Rev 0.1

Date: September 2024

6

Glossary

Glossary

Term	Definition
5G NR	5 th Generation New Radio
LTE	Long-Term Evolution
802.11(b/g/n/ac/ax/be)	A set of WLAN communication standards in the 2.4GHz frequency band, 5GHz frequency band and 6GHz frequency bands.
Bps	Bits per second
Broadband	High capacity, high-speed transmission channel with a wider bandwidth than conventional modem lines.
DHCP	Dynamic Host Configuration Protocol
DHCP Server	A server or service with a server that assigns IP addresses.
DNS	Domain Name System
Firmware	A computer program embedded in electronic devices. Firmware usually contains operating code for the device.
GB	Gigabyte
Hotspot	A Wi-Fi (802.11b/g/n/ac) access point or the area covered by an access point.
HTTP	Hyper Text Transfer Protocol
IMEI	International Mobile Equipment Identity
IMSI	International Mobile Subscriber Identity
IP	Internet Protocol
IP Type	The type of service provided over a network.
IP Address	The address of a device attached to an IP network.
ISP	Internet Service Provider
Kbps	Kilobits per second
LAN	Local Area Network
MAC Address	Media Access Control address
Mbps	Megabits per second
Network Operator	The vendor who provides your wireless access.
Port	A virtual data connection used by a program to exchange data.
Port Forwarding	A process that allows remote devices to connect to a specific computer within a private LAN.
Port Number	A 16-bit number used by the TCP and UDP protocols to direct traffic.
Protocol	A standard that allows connection, communication, and data transfer between computing endpoints.
Proxy	A firewall mechanism that replaces the IP address of a host on the internal (protected) network with its own IP address.
Router	A device that directs traffic from one network to another.
SIM	Subscriber Identification Module
SSID	Service Set Identifier
TCP/IP	Transmission Control Protocol/Internet Protocol
USB	Universal Serial Bus
VPN	Virtual Private Network
WLAN	Wireless Local Area Network
WWAN	Wireless Wide Area Network