



**FCC 47CFR part 15C
Test Report
For
JongoS340B**

Reference Standard: FCC 47CFR part 15C

Manufacturer: PURE

For type of equipment and serial number, refer to section 3

Report Number: 11-6525-5-12 Issue 01

Report Produced by: -

R.N. Electronics Ltd.

1 Arnolds Court
Arnolds Farm Lane
Mountnessing
Essex
CM13 1UT
U.K.

www.RNelectronics.com

Telephone +44 (0) 1277 352219

Facsimile +44 (0) 1277 352968

Copy No. pdf



Arnolds Court, Arnolds Farm Lane, Mountnessing, Brentwood Essex, CM13 1UT

Certificate of Test 6525/5

The unit noted below has been tested by **R.N. Electronics Limited** and, where appropriate, conforms to the relevant subpart of FCC 47CFR Part 15. This is a certificate of test only and should not be confused with an equipment authorisation. Other standards may also apply.

Equipment:	Jongo S340B
Model Number:	JongoS340B
Proposed FCC ID:	X280066
Unique Serial Number:	ES3-03
Manufacturer:	PURE Home Park Industrial Estate Kings Langley Hertfordshire WD4 8LZ UK
Full measurement results are detailed in Report Number:	11-6525-5-12 Issue 01
Test Standards:	FCC 47CFR Part 15.247 Effective date October 1st 2012 , Class DTS Intentional Radiator

NOTE:

Certain tests were not performed based upon manufacturer's declarations. Certain other requirements are subject to manufacturer declaration only and have not been tested/verified. For details refer to section 3 of this report.

DEVIATIONS: Deviations from the standards have been applied. For details refer to section 4.2 of this report.

This certificate relates only to the unit tested as identified by a unique serial number and in the condition at the time it was tested. It does not relate to any other similar equipment and performance of the product before or after the test cannot be guaranteed. Whilst every effort is made to assure quality of testing, type tests are not exhaustive and although no non-conformances may be found, this doesn't exclude the possibility of unit not meeting the intentions of the standard or the requirements of the Directive, particularly under different conditions to those during testing. Any compliance statements are made reliant on (a) the application of the product and use of the assigned band being acceptable to one or more national authorities within the EU and (b) the modes of operation as instructed to us by the Customer based on their specific knowledge of the application and functionality of the EUT. Statements of compliance, where measurements were made, do not include the measurement uncertainty. The measurement uncertainty, where stated, is the expanded uncertainty based on a standard uncertainty multiplied by a coverage factor of k=2, providing a level of confidence of approximately 95%.

Date of Test: 22nd October to 26th November
2012

Test Engineer:

Approved By:
Managing Director

Customer representative

File name PURE.6525-5.DOCM

The contents of this report, apart from the referenced ANSI C63.4-2003, are beyond the scope of UKAS Testing Laboratory No. 2360 accreditation.

1 Contents

1	Contents.....	3
2	Summary of test results	4
3	Equipment Under Test (EUT)	5
3.1	EQUIPMENT SPECIFICATION	5
3.2	EUT CONFIGURATIONS FOR TESTING	5
3.3	FUNCTIONAL DESCRIPTION.....	6
3.4	EUT MODES	6
3.5	EMISSIONS CONFIGURATION	7
4	Specifications.....	8
4.1	RELEVANT STANDARDS.....	8
4.2	DEVIATIONS.....	8
4.3	MEASUREMENT UNCERTAINTIES	8
5	Tests, Methods and Results	9
5.1	CONDUCTED EMISSIONS	9
5.2	PEAK CONDUCTED POWER.....	11
5.3	MAXIMUM POWER SPECTRAL DENSITY.....	13
5.4	DUTY CYCLE.....	15
5.5	RADIATED EMISSIONS	16
5.6	OCCUPIED BANDWIDTH.....	19
5.7	BAND EDGE COMPLIANCE	21
5.8	FHSS PARAMETERS	22
6	Plots and Results	23
6.1	CONDUCTED EMISSIONS	23
6.2	RADIATED EMISSIONS 9KHZ – 1GHZ.....	25
6.3	RADIATED EMISSIONS ABOVE 1GHZ.....	28
6.4	6DB BANDWIDTH.....	42
6.5	BAND EDGE COMPLIANCE	60
6.6	SPECTRAL POWER DENSITY	108
7	Explanatory Notes	126
7.1	EXPLANATION OF TABLE OF SIGNALS MEASURED	126
7.2	EXPLANATION OF LIMIT LINE CALCULATIONS FOR RADIATED MEASUREMENTS	126
8	Photographs.....	127
9	Signal Leads	138
10	Test Equipment Calibration list	138
11	Auxiliary equipment	138
11.1	AUXILIARY EQUIPMENT SUPPLIED BY	138
11.2	AUXILIARY EQUIPMENT SUPPLIED BY RN ELECTRONICS LIMITED.....	138
12	Modifications	139
12.1	MODIFICATIONS BEFORE TEST.....	139
12.2	MODIFICATIONS DURING TEST	139
13	Compliance information.....	139
14	Description of Test Sites.....	140
15	Abbreviations and Units.....	141

File name PURE.6525-5.DOCM

The contents of this report, apart from the referenced ANSI C63.4-2003, are beyond the scope of UKAS Testing Laboratory No. 2360 accreditation.

2 Summary of test results

The Jongo S340B was tested to the following standards: -

**FCC 47CFR Part 15.247 (effective date October 1st, 2012);
Class DTS Intentional Radiator**

Any compliance statements are made reliant on the modes of operation as instructed to us by the Manufacturer based on their specific knowledge of the application and functionality of the equipment tested. Whilst every effort is made to assure quality of testing, type tests are not exhaustive and although no non-conformances may be found, this doesn't exclude the possibility of equipment not meeting the intentions of the standard, particularly under different conditions to those during testing.

Title	Reference	Results
1. Conducted emissions	FCC Part 15C §15.207	PASSED
2. Radiated emissions	FCC Part 15C §15.205, §15.209 and §15.247(d)	PASSED
3. Occupied bandwidth	FCC Part 15C §15.215(c), §15.247(a)(2)	PASSED
4. Peak conducted power	FCC Part 15C §15.247(b)	PASSED
5. Frequency tolerance	FCC Part 15C §15.215(c)	NOT APPLICABLE ¹
6. Duty cycle	FCC Part 15C §15.35(c)	NOT APPLICABLE ²
7. Power Spectral Density	FCC Part 15C §15.247(e)	PASSED
8. Band edge compliance	FCC Part 15C §15.205, §15.209 and §15.247	PASSED
9. FHSS parameters	FCC Part 15C §15.247(a)(1)	NOT APPLICABLE ³

¹ No limits apply, however the requirement to contain the designated bandwidth of the emission within the specified frequency band includes the frequency stability of the transmitter over expected variations in temperature and supply voltage.

² No limits apply.

³ EUT does not employ FHSS technology.

3 Equipment Under Test (EUT)

3.1 Equipment Specification

Applicant	PURE Home Park Industrial Estate Kings Langley Hertfordshire WD4 8LZ UK	
Manufacturer of EUT	PURE	
Brand name of EUT	PURE	
Model Number of EUT	JongoS340B	
Proposed FCC ID	X280066	
Serial Number of EUT	ES3-03	
Date when equipment was received by RN Electronics	22 nd October 2012	
Date of test:	22 nd October to 26 th November 2012	
Customer order number:	PO122466	
Visual description of EUT:	Small plastic enclosure with a battery compartment on the bottom. On the rear are a DC input, USB port and an auxiliary audio input port, along with a small LCD display and 2 push buttons. On the front are 4 push buttons including an On/Off switch. The unit comes supplied with a dedicated AC/DC power adaptor. The Wi-Fi antenna is integral to the enclosure.	
Main function of the EUT:	Wireless audio speaker	
Height	130 mm	
Width	110 mm	
Depth	110 mm	
Weight	< 1 kg	
Voltage	9V DC from AC/DC adaptor, 3.7V DC from Lithium battery pack	
Current required from above voltage source	1500mA max @ 9V 2000mA max @ 3.7V	
EUT Supplied PSU	Manufacturer	E-Tek Electronics Manufactory Ltd
	Model Number	ZDD090150BS
	Serial Number	Not specified
	Specification	Input = 100-240V AC, 50/60 Hz @ 0.5A, Output = 9V DC @ 1500mA

3.2 EUT Configurations for testing

Frequency range	2412 – 2462 MHz
Normal use position	Desktop
Normal test signals	OFDM & DSSS up to 54MBPS
Declared power level	<+20dBm (+16dBm Nominal)
Declared channel bandwidth	20MHz
Highest frequency generated / used	2462MHz
Lowest frequency generated / used	12MHz USB clock

File name PURE.6525-5.DOCM

The contents of this report, apart from the referenced ANSI C63.4-2003, are beyond the scope of UKAS Testing Laboratory No. 2360 accreditation.

3.3 Functional Description

Wireless speaker to stream media via a home Wi-Fi network, by use of a network access point, or directly, via the soft AP mode on the Jongo unit. The unit also has the ability to stream via a supplied separate Bluetooth USB dongle.

3.4 EUT Modes

Mode	Description of mode	Used for Testing
Transmit Mod 2.412GHz	Unit in constant transmit with mod @ 2.412GHz	YES
Transmit Mod 2.437GHz	Unit in constant transmit with mod @ 2.437GHz	YES
Transmit Mod 2.462GHz	Unit in constant transmit with mod @ 2.462GHz	YES
Receive 2.412GHz	Unit in receive mode @2.412 GHz	YES
Receive 2.437GHz	Unit in receive mode @2.437 GHz	YES
Receive 2.462GHz	Unit in receive mode @2.462 GHz	YES
Transmit 1% duty cycle	Unit transmitting system modulation 1% duty cycle	YES

All Transmit modes were 100% duty cycle, modulated (except where stated otherwise), and left on the default max power setting.

The Transmit modes referred to above were checked in combination with the following table of modulation/ data rate schemes to fulfil the test requirements:-

Mode	Rate
802.11B	1 Mbps
802.11B	2 Mbps
802.11B	5.5 Mbps
802.11B	11 Mbps
802.11G	6 Mbps
802.11G	9 Mbps
802.11G	12 Mbps
802.11G	18 Mbps
802.11G	24 Mbps
802.11G	36 Mbps
802.11G	48 Mbps
802.11G	54 Mbps

Description of ancillary equipment connected to the equipment under test, for the purpose of tests, can be found in Section 10.

Any modifications made to the EUT, whilst under test, can be found in Section 11.

This report was printed on: 11 January 2013

3.5 Emissions Configuration

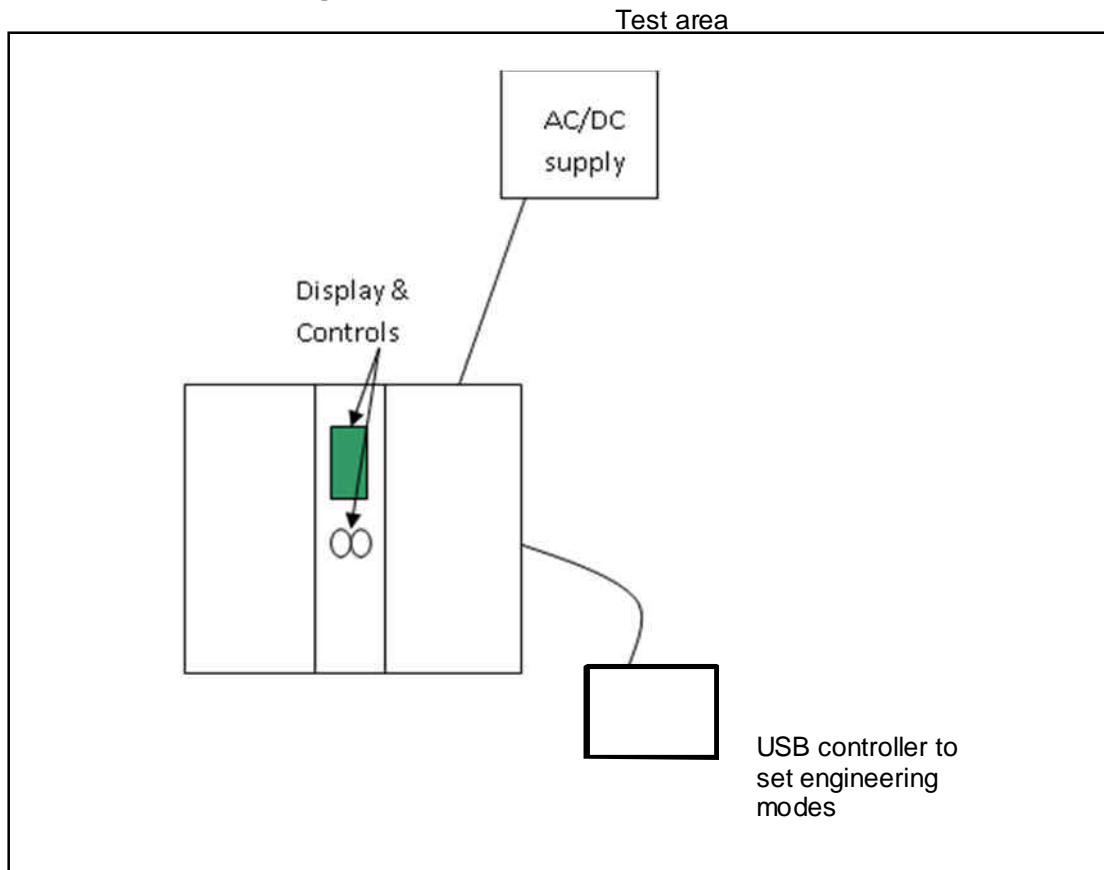

The unit was powered from the dedicated AC/DC adapter provided with the unit. For conducted tests the internal antenna was unsoldered and an SMA connector fitted in its place. The unit was configured with engineering menus in software to allow permanent transmit and receive modes of device on the top, middle and bottom channels as stated within section 3.4 of this report. The transmit mode was 100% continuous with modulation and the power settings for each channel were left at the default settings by the software.

For radiated and conducted emissions tests the unit was populated with typical leads, an audio input lead and a USB device, the USB device was a specially modified unit that allowed control and setting of the various engineering modes and configurations required for tests – not available to the end user. The AC/DC adapter was also placed on to the test table along with the main enclosure of the EUT. The same unit was used for both Radiated and Conducted tests.

4 Specifications

4.1 Relevant Standards

The tests were performed by RN Electronics Engineer Daniel Sims who set up the tests, the test equipment, and operated it in accordance with the **R.N. Electronics Ltd** procedures manual, ANSI C63.10-2009, FCC Part 15 and those specifications incorporated by reference into 47CFR15 (e.g. ANSI C63.4-2003).

R.N. Electronics Ltd sites M and OATS are listed with the FCC. Registration Number 293246

4.2 Deviations

ANSI C63-10-2009 deviations:

The reference standard ANSI C63.4-2003 was used, not the latest ANSI C63.4-2009

FCC Part 15 deviations:

None.

4.2.1 Tests at Extremes of Temperature & Voltage

Not required.

- A permanent internal RF Antenna was used for testing.
- A test fixture was used for testing.
- A temporary RF port was created for testing.
- The equipment internal RF port was used for testing.

4.3 Measurement Uncertainties

Parameter	Uncertainty
Transmitter Tests	
Conducted RF power	<± 1.0 dB
Occupied bandwidth	± 1.9 %
Radiated RF power	± 3.5 dB
Radiated spurious emissions	30MHz - 1000MHz ±5.1dB
	1000MHz - 2000MHz ±4.5dB
	1 – 18 GHz ±3.5dB
	18 – 26.5 GHz ±3.9dB
AC line conducted emissions	(For LISN) 150kHz to 30MHz ±3.6dB

File name PURE.6525-5.DOCM

The contents of this report, apart from the referenced ANSI C63.4-2003, are beyond the scope of UKAS Testing Laboratory No. 2360 accreditation.

5 Tests, Methods and Results

5.1 Conducted emissions

5.1.1 Test Methods

Test Requirements FCC Part 15C, Reference (15.207)

Test Method: ANSI C63.10, Reference (6.2.)

5.1.1.1 Configuration of EUT

The EUT and AC/DC adapter were placed on a wooden table 0.8m above the ground plane and connected to a LISN via a 1m mains cable.

Details of the Peripheral and Ancillary Equipment connected for this test is listed in section 11.

No discernible difference in emissions was noted between modes; therefore full tests were performed using mode **Transmit Mod 2.437GHz**.

5.1.1.2 Test Procedure

Tests were made in accordance with FCC Part 15 using the measuring equipment noted in the 'Test Equipment' Section. Measurements were made on the live and neutral conductors using both average and quasi-peak detection.

At least 6 signals within 20dB and/or all signals within 10dB of the limit were investigated.

Tests were performed in Test Site F.

5.1.2 Test results

Temperature of test Environment: 20°C

Analyser plots for the Quasi-Peak / Average values as applicable can be found in Section 6.1 of this report.

Quasi-Peak and Average Live

Signal No.	Freq (MHz)	Peak Amp (dBUV)	QP Amp (dBUV)	QP - Lim1 (dB)	AV Amp (dBUV)	AV - Lim1 (dB)
1	0.173	52.4	51.2	-13.6	42.0	-12.8
2	0.176	54.0	52.8	-11.9	42.6	-12.1
3	0.176	54.2	52.9	-11.8	42.7	-12.0
4	0.176	55.1	53.8	-10.9	43.3	-11.4
5	0.179	58.0	56.6	-7.9	45.1	-9.4
6	0.223	54.6	53.1	-9.6	41.8	-10.9
7	0.268	50.0	48.5	-12.7	35.5	-15.7
8	0.311	47.6	45.4	-14.5	33.9	-16.0
9	0.351	45.1	42.9	-16.0	31.4	-17.5
10	0.397	42.5	39.9	-18.0	25.4	-22.5
11	0.397	41.1	38.3	-19.6	24.2	-23.7
12	1.519	40.3	38.4	-17.6	32.9	-13.1
13	2.601	38.7	36.2	-19.8	28.4	-17.6
14	3.182	40.4	37.8	-18.2	30.1	-15.9
15	3.758	41.2	38.6	-17.4	31.1	-14.9

File name PURE.6525-5.DOCM

The contents of this report, apart from the referenced ANSI C63.4-2003, are beyond the scope of UKAS Testing Laboratory No. 2360 accreditation.

16	4.337	41.6	39.5	-16.5	32.4	-13.6
17	4.399	38.3	35.8	-20.2	30.4	-15.6
18	4.914	40.2	38.3	-17.7	31.6	-14.4

Quasi-Peak and Average Neutral

Signal No.	Freq (MHz)	Peak Amp (dBuV)	QP Amp (dBuV)	QP - Lim1 (dB)	AV Amp (dBuV)	AV - Lim1 (dB)
1	0.188	54.5	52.9	-11.2	42.0	-12.1
2	0.188	54.6	53.0	-11.1	42.0	-12.1
3	0.189	54.2	52.8	-11.3	42.0	-12.1
4	0.189	55.0	53.5	-10.6	42.5	-11.6
5	0.249	49.8	47.6	-14.2	35.3	-16.5
6	0.370	42.5	39.1	-19.4	24.3	-24.2
7	0.431	43.6	40.2	-17.0	27.9	-19.3
8	0.514	42.8	39.7	-16.3	30.2	-15.8
9	0.551	39.7	36.9	-19.1	25.4	-20.6
10	1.530	43.4	40.1	-15.9	32.8	-13.2
11	1.857	37.7	34.4	-21.6	24.5	-21.5
12	1.857	37.7	34.6	-21.4	24.5	-21.5
13	3.749	42.2	37.3	-18.7	28.8	-17.2
14	4.327	42.8	38.4	-17.6	30.2	-15.8
15	4.904	41.6	37.9	-18.1	29.8	-16.2

These results show that the **EUT** has **PASSED** this test.

5.1.2.1 Test Equipment used

E035, E150, E256, E410, E411, E412

See Section 10 for more details.

5.2 Peak Conducted power

5.2.1 Test Methods

Test Requirements	FCC Part 15C, Reference (15.247)
Test Method:	FCC Part 15C, Reference (15.247) ANSI C63.10, Reference (6.10.2.1 b)

5.2.1.1 Configuration of EUT

The EUT was measured on a bench using a spectrum analyser connected to the Internal RF port. The EUT was set to each mode and test signal in turn (see section 3.4) and highest power levels recorded.

5.2.1.2 Test Procedure

Tests were made in accordance with FCC Part 15 using the measuring equipment noted below.

Peak stated reading is maximum power observed using a spectrum analyser channel power function over the 6dB bandwidth + 1MHz using a 1MHz RBW, per ANSI C63.10.

Measurements were made on a test bench.

5.2.2 Test results

Test Environment: Temperature: 23°C Humidity: 43 %

Bottom channel results

Channel / scheme	Analyser reading (dBm)	Duty cycle adjustment (dB)	Total (dBm)	Peak ANSI C63.10 (mW)
1MB	18.7	0	18.7	74.1
2MB	18.8	0	18.8	75.9
5.5MB	19.9	0	19.9	97.7
11MB	20.5	0	20.5	112.2
6MB	19.3	0	19.3	85.1
9MB	19.5	0	19.5	89.1
12MB	18.7	0	18.7	74.1
18MB	18.7	0	18.7	74.1
24MB	18.8	0	18.8	75.9
36MB	18.9	0	18.9	77.6
48MB	17.0	0	17.0	50.1
54MB	16.9	0	16.9	49.0

Middle channel results

Channel / scheme	Analyser reading (dBm)	Duty cycle adjustment (dB)	Total (dBm)	Peak ANSI C63.10 (mW)
1MB	19.1	0	19.1	81.3
2MB	19.2	0	19.2	83.2
5.5MB	20.3	0	20.3	107.2
11MB	21.1	0	21.1	128.8
6MB	20.7	0	20.7	117.5
9MB	21.0	0	21.0	125.9
12MB	20.1	0	20.1	102.3
18MB	20.1	0	20.1	102.3
24MB	20.1	0	20.1	102.3
36MB	20.3	0	20.3	107.2
48MB	18.5	0	18.5	70.8
54MB	18.3	0	18.3	67.6

Top channel results

Channel / scheme	Analyser reading (dBm)	Duty cycle adjustment (dB)	Total (dBm)	Peak ANSI C63.10 (mW)
1MB	19.5	0	19.5	89.1
2MB	19.6	0	19.6	91.2
5.5MB	20.8	0	20.8	120.2
11MB	21.5	0	21.5	141.3
6MB	20.3	0	20.3	107.2
9MB	20.5	0	20.5	112.2
12MB	19.7	0	19.7	93.3
18MB	19.6	0	19.6	91.2
24MB	19.8	0	19.8	95.5
36MB	20.0	0	20.0	100.0
48MB	19.0	0	19.0	79.4
54MB	18.9	0	18.9	77.6

LIMITS:

15.247(b)(3)

For systems using digital modulation in the 902-928, 2400-2483.5 or 5725-5850 MHz bands 1 Watt.

These results show that the EUT has **PASSED** this test.

5.2.2.1 Test Equipment used

E252, E266, E290, E342, E397, E434, E492

See Section 10 for more details

5.3 Maximum Power Spectral Density

5.3.1 Test Methods

Test Requirements	FCC Part 15C, Reference (15.247)
Test Method:	FCC Part 15C, Reference (15.247) KDB558074, PSD Option 1

5.3.1.1 Configuration of EUT

The EUT was tested on a bench and results referenced to measured antenna Gain.

5.3.1.2 Test Procedure

Tests were made in accordance with FCC Part 15 using the measuring equipment noted below. PEP was recorded in the required bandwidths and the plots were taken.

5.3.2 Test results

Tests were performed using Test Site A.

Temperature of test Environment: 22°C

Bottom channel (1) test results

Channel/ scheme	PEP (dBm/3kHz)	Plot reference
1MB	-11.8	0040
2MB	-9.7	0041
5.5MB	-11.2	0042
11MB	-10.7	0043
6MB	-13.9	0044
9MB	-11.1	0045
12MB	-10.4	0046
18MB	-9.7	0047
24MB	-9.6	0048
36MB	-7.2	0049
48MB	-8.3	0050
54MB	-9.3	0051

Middle channel (6) test results

Channel/ scheme	PEP (dBm/3kHz)	Plot reference
1MB	-11.3	0052
2MB	-8.7	0053
5.5MB	-10.2	0054
11MB	-9.8	0055
6MB	-12.1	0056
9MB	-9.3	0057
12MB	-8.5	0058
18MB	-7.8	0059
24MB	-7.7	0060
36MB	-5.3	0061
48MB	-5.3	0062
54MB	-7.4	0063

File name PURE.6525-5.DOCM

The contents of this report, apart from the referenced ANSI C63.4-2003, are beyond the scope of UKAS Testing Laboratory No. 2360 accreditation.

Top channel (11) test results

Channel/ scheme	PEP (dBm/3kHz)	Plot reference
1MB	-11.1	0064
2MB	-8.6	0065
5.5MB	-9.9	0066
11MB	-9.7	0067
6MB	-13.0	0068
9MB	-10.1	0069
12MB	-9.5	0070
18MB	-8.6	0071
24MB	-8.5	0072
36MB	-6.1	0073
48MB	-6.2	0074
54MB	-7.4	0075

LIMITS:

15.247(e) +8dBm/3kHz.

Any Analyser plots can be found in Section 6.6 of this report.

These results show that the **EUT** has **PASSED** this test.

5.3.2.1 Test Equipment used

E252, E434, E492

See Section 10 for more details.

5.4 Duty cycle

Test not applicable. However, a basic duty cycle measurement was made in order to ascertain any duty cycle corrections required to be applied to the test results.

The Transmit mode was confirmed as being 100% TX On.

5.4.1.1 Test Equipment used

E492

See Section 10 for more details.

5.5 Radiated emissions

5.5.1 Test Methods

Test Requirements	FCC Part 15C, Reference (15.209)
Test Method:	ANSI C63.10, Reference (6.4 – 6.6.)

5.5.1.1 Configuration of EUT

The EUT was placed on a 0.8 metres high turntable. The front edge of the EUT was initially positioned facing the antenna. The EUT was measured at a distance of 3 metres. The EUT was rotated in all three orthogonal planes. Radiated Emissions testing was performed with an internal battery in place but with the EUT connected to its dedicated AC/DC adapter. The EUT was operated in **Transmit Mod 2.412GHz, Transmit Mod 2.437GHz and Transmit Mod 2.462GHz** modes.

5.5.1.2 Test Procedure

Tests were made in accordance with FCC Part 15 using the measuring equipment noted below.

Below 30MHz, measurements were made in a semi-anechoic chamber (pre-scan) with final measurements on an OATS without a ground plane. The antenna was placed 1m above the ground. The equipment and the antenna were rotated 360° to record the worst case emissions.

30MHz - 1GHz, measurements were made on a site listed with the FCC. The equipment was rotated 360° and the antenna scanned 1 – 4 metres in both horizontal and vertical polarisations to record the worst case emissions.

Above 1GHz, measurements were made in a semi-anechoic chamber with appropriate absorbing material for use in this range. The EUT was raised and antenna was placed 1.5m above the ground in line with the EUT, which was rotated through 360° to record the worst case emissions.

At least 6 signals within 20dB and all signals within 10dB of the limit were investigated.

5.5.2 Test results

Tests were performed using Test Site M.

Test Environment: M

Temperature: 18-22°C Humidity: 38-49 %

Analyser plots for the Quasi-Peak, Average and Peak values as applicable can be found in Section 6.2 and 6.3 of this report.

Note: EUT tested in a continuous transmit mode for ease of test.

Table of signals measured within 20dB of limits below 960MHz.

Horizontal Results Middle channel

Signal No.	Freq (MHz)	QP Amp (dBuV)	QP - Lim1 (dB)
1	192.004	25.5	-18.0
2	194.452	20.0	-23.5
3	270.350	29.0	-17.0
4	278.027	25.4	-20.6
5	280.000	28.9	-17.1
6	290.102	26.4	-19.6
7	293.223	26.6	-19.4
8	296.215	27.5	-18.5
9	311.446	26.4	-19.6
10	319.504	30.5	-15.5

Vertical Results Middle channel

Signal No.	Freq (MHz)	QP Amp (dBuV)	QP - Lim1 (dB)
1	39.585	22.6	-17.4
2	44.756	22.9	-17.1
3	49.067	22.0	-18.0
4	64.737	20.9	-19.1
5	64.948	18.2	-21.8
6	110.100	17.4	-26.1
7	417.813	29.9	-16.1
8	565.277	32.4	-13.6

Note: Emissions under 960MHz were present regardless of Wi-Fi transmit channel selected, therefore results tables have only been shown once as the emissions are "Generic" to the EUT regardless of the Wi-Fi part.

Table of signals measured within 20dB of limits above 960MHz.

Horizontal

Bottom channel TX.

Signal	Frequency (MHz)	PK measured	AV measured	PK-Lim	AV-Lim
1	4824	49.1	40.5	-24.9	-13.5
2	6432	54.3	49.3	-19.7	-4.7

Middle channel TX.

Signal	Frequency (MHz)	PK measured	AV measured	PK-Lim	AV-Lim
1	4874	48.9	40.9	-25.1	-13.1
2	6498	54.3	48.7	-19.7	-5.3

Top channel TX.

Signal	Frequency (MHz)	PK measured	AV measured	PK-Lim	AV-Lim
1	4924	49.9	41	-24.1	-13
2	6565	53.8	47.8	-20.2	-6.2
3	9848	51.5	40.3	-22.5	-13.7

File name PURE.6525-5.DOCM

The contents of this report, apart from the referenced ANSI C63.4-2003, are beyond the scope of UKAS Testing Laboratory No. 2360 accreditation.

Vertical

Bottom channel TX.

Signal	Frequency (MHz)	PK measured	AV measured	PK-Lim	AV-Lim
1	4824	47.9	37.9	-26.1	-16.1
2	6432	54.3	49.3	-19.4	-4.3
3	9648	50.6	41.9	-23.4	-12.1

Middle channel TX.

Signal	Frequency (MHz)	PK measured	AV measured	PK-Lim	AV-Lim
1	4874	49.9	42.9	-24.1	-11.1
2	6498	55.3	50.5	-18.7	-3.5
3	9748	50.9	42.0	-23.1	-12.0

Top channel TX.

Signal	Frequency (MHz)	PK measured	AV measured	PK-Lim	AV-Lim
1	4924	49.3	40.7	-24.7	-13.3
2	6565	54.0	48.3	-20.0	-5.7
3	9848	51.3	42	-22.7	-12

LIMITS:

15.209 limits are applicable in the restricted bands of 15.205 with the relevant detector.
15.247(d) other emissions, outside the intentional band, must be attenuated by at least 50dB from the level of the fundamental / meet the general limits of 15.209.

Plot references

Frequency range	Plot reference
1 – 2 GHz	6525-5 1-2GHz Horiz/Vert Mid chan
2 – 2.7 GHz	6525-5 2-2.7GHz Horiz/Vert Mid chan
2.7 – 5 GHz	6525-5 2.7-5GHz Horiz/Vert Mid chan
5 – 6.5 GHz	6525-5 5-6.5GHz Horiz/Vert Mid chan
6.5 – 7.8 GHz	6525-5 6.5-7.8GHz Horiz/Vert Mid chan
7.8 – 10 GHz	6525-5 7.8-10GHz Horiz/Vert Mid chan
10 – 12.5 GHz	6525-5 10-12.5GHz Horiz/Vert Mid chan
12.5 – 14 GHz	6525-5 12.5-14GHz Horiz/Vert Mid chan
14 – 16 GHz	6525-5 14-16GHz Horiz/Vert Mid chan
16 – 18 GHz	6525-5 16-18GHz Horiz/Vert Mid chan
18 – 20 GHz	6525-5 18-20GHz Horiz/Vert Mid chan
20 – 22 GHz	6525-5 20-22GHz Horiz/Vert Mid chan
22 – 24 GHz	6525-5 22-24GHz Horiz/Vert Mid chan
24 – 25 GHz	6525-5 24-25GHz Horiz/Vert Mid chan

N.b. the general limits of 15.209 are as drawn on the respective plots.

These show that the **EUT** has **PASSED** this test.

5.5.2.1 Test Equipment used

E410, E411, E412, TMS933, E268, E342, E429, TMS78, TMS79, TMS81, TMS82

See Section 10 for more details

File name PURE.6525-5.DOCM

The contents of this report, apart from the referenced ANSI C63.4-2003, are beyond the scope of UKAS Testing Laboratory No. 2360 accreditation.

5.6 Occupied bandwidth

5.6.1 Test Methods

Test Requirements FCC Part 15C, Reference (15.215)

Test Method: ANSI C63.10, Reference (6.9)

5.6.1.1 Configuration of EUT

The EUT was tested on a bench. The EUT was operated in **Transmit Mod 2.412GHz**, **Transmit Mod 2.437GHz** and **Transmit Mod 2.462GHz** modes in combination with the relevant modulation schemes.

5.6.1.2 Test Procedure

Tests were made in accordance with FCC Part 15 using the measuring equipment noted below. A 120kHz RBW, 3x VBW, auto sweep time and max hold settings were used for the 6dB bandwidth.

5.6.2 Test results

Tests were performed using Test Site **A**.

Temperature of test Environment: 23°C

Analyser plots for the 6dB bandwidth can be found in Section 6.4 of this report.

Bottom channel test results

Channel 1 / Scheme	BW result (MHz)	Plot reference
1Mbps	10.025	0001
2Mbps	10.125	0002
5.5Mbps	10.025	0003
11Mbps	10.075	0004
6Mbps	15.150	0005
9Mbps	15.150	0006
12Mbps	15.125	0007
18Mbps	15.425	0008
24Mbps	15.150	0009
36Mbps	15.650	0010
48Mbps	15.325	0011
54Mbps	15.150	0012

Middle channel test results

Channel 6 / Scheme	BW result (MHz)	Plot reference
1Mbps	10.025	0013
2Mbps	10.125	0014
5.5Mbps	10.025	0015
11Mbps	10.075	0016
6Mbps	15.150	0017
9Mbps	15.125	0018
12Mbps	15.125	0019
18Mbps	15.425	0020
24Mbps	15.150	0021
36Mbps	15.650	0022
48Mbps	15.325	0023
54Mbps	15.150	0024

Top channel test results

Chan nel 11 / Scheme	BW result (MHz)	Plot reference
1Mbps	10.050	0025
2Mbps	10.125	0026
5.5Mbps	10.025	0027
11Mbps	10.075	0028
6Mbps	15.150	0029
9Mbps	15.150	0030
12Mbps	15.125	0031
18Mbps	15.425	0032
24Mbps	15.150	0033
36Mbps	15.750	0034
48Mbps	15.325	0035
54Mbps	15.150	0036

LIMITS:

15.247(a)(2) The minimum 6dB bandwidth shall be at least 500kHz.

These results show that the **EUT** has **PASSED** this test.

5.6.2.1 Test Equipment used

E227, E434, E492, E252

See Section 10 for more details.

5.7 Band Edge Compliance

5.7.1 Test Methods

Test Requirements

FCC Part 15C, Reference (15.215 and 15.247)

Test Method:

FCC Part 15C, Reference (15.215)

ANSI C63.10-2009, Reference clause 6.9.3

5.7.1.1 Configuration of EUT

The EUT was tested on a bench and referenced to any antenna gain or loss.

5.7.1.2 Test Procedure

Tests were made in accordance with FCC Part 15 using the measuring equipment noted below

5.7.2 Test results

Tests were performed using Test Site A.

Temperature of test Environment: 23°C

Restricted Band Edges.

Analysers plots for the Restricted / Band Edge Compliance can be found in Section 6.5 of this report. The following tables list the field strengths observed in the adjacent restricted bands, which are required to meet the tighter 15.209 limits:

Plots are also shown demonstrating the 20dBc/30dBc requirement of 15.247(d) are met at the band edges of 2400 and 2483.5 MHz.

Bottom channel results

Channel 1 Scheme	Band edge PK reading (dBuV/m)	Band edge AV reading (dBuV/m)	Plot reference
1Mbps	51.6	59.8	J6525-5 Low chan AV Band edge 1MB scheme 1M RBW J6525-5 Low chan PK Band edge 1MB scheme 1M RBW
2Mbps	51.5	60.4	J6525-5 Low chan AV Band edge 1MB scheme 2M RBW J6525-5 Low chan PK Band edge 1MB scheme 2M RBW
5.5Mbps	48.6	59.2	J6525-5 Low chan AV Band edge 1MB scheme 5.5M RBW J6525-5 Low chan PK Band edge 1MB scheme 5.5M RBW
11Mbps	48.7	60.0	J6525-5 Low chan AV Band edge 1MB scheme 11M RBW J6525-5 Low chan PK Band edge 1MB scheme 11M RBW
6Mbps	47.5	62.7	J6525-5 Low chan AV Band edge 1MB scheme 6M RBW J6525-5 Low chan PK Band edge 1MB scheme 6M RBW
9Mbps	47.9	62.1	J6525-5 Low chan AV Band edge 1MB scheme 9M RBW J6525-5 Low chan PK Band edge 1MB scheme 9M RBW
12Mbps	48.0	65.7	J6525-5 Low chan AV Band edge 1MB scheme 12M RBW J6525-5 Low chan PK Band edge 1MB scheme 12M RBW
18Mbps	48.0	61.7	J6525-5 Low chan AV Band edge 1MB scheme 18M RBW J6525-5 Low chan PK Band edge 1MB scheme 18M RBW
24Mbps	47.5	60.3	J6525-5 Low chan AV Band edge 1MB scheme 24M RBW J6525-5 Low chan PK Band edge 1MB scheme 24M RBW
36Mbps	47.0	60.1	J6525-5 Low chan AV Band edge 1MB scheme 36M RBW J6525-5 Low chan PK Band edge 1MB scheme 36M RBW
48Mbps	45.3	58.8	J6525-5 Low chan AV Band edge 1MB scheme 48M RBW J6525-5 Low chan PK Band edge 1MB scheme 48M RBW
54Mbps	45.3	58.8	J6525-5 Low chan AV Band edge 1MB scheme 54M RBW J6525-5 Low chan PK Band edge 1MB scheme 54M RBW

File name PURE.6525-5.DOCM

The contents of this report, apart from the referenced ANSI C63.4-2003, are beyond the scope of UKAS Testing Laboratory No. 2360 accreditation.

Top channel results

Channel 11 Scheme	Band edge PK reading (dBuV/m)	Band edge AV reading (dBuV/m)	Plot reference
1Mbps	59.0	52.0	J6525-5 High chan AV Band edge 1MB scheme 1M RBW J6525-5 High chan PK Band edge 1MB scheme 1M RBW
2Mbps	60.2	51.4	J6525-5 High chan AV Band edge 1MB scheme 2M RBW J6525-5 High chan PK Band edge 1MB scheme 2M RBW
5.5Mbps	60.3	50.0	J6525-5 High chan AV Band edge 1MB scheme 5.5M RBW J6525-5 High chan PK Band edge 1MB scheme 5.5M RBW
11Mbps	60.6	50.0	J6525-5 High chan AV Band edge 1MB scheme 11M RBW J6525-5 High chan PK Band edge 1MB scheme 11M RBW
6Mbps	64.8	49.8	J6525-5 High chan AV Band edge 1MB scheme 6M RBW J6525-5 High chan PK Band edge 1MB scheme 6M RBW
9Mbps	67.8	50.1	J6525-5 High chan AV Band edge 1MB scheme 9M RBW J6525-5 High chan PK Band edge 1MB scheme 9M RBW
12Mbps	63.8	49.9	J6525-5 High chan AV Band edge 1MB scheme 12M RBW J6525-5 High chan PK Band edge 1MB scheme 12M RBW
18Mbps	65.8	50.4	J6525-5 High chan AV Band edge 1MB scheme 18M RBW J6525-5 High chan PK Band edge 1MB scheme 18M RBW
24Mbps	64.9	50.3	J6525-5 High chan AV Band edge 1MB scheme 24M RBW J6525-5 High chan PK Band edge 1MB scheme 24M RBW
36Mbps	64.8	49.3	J6525-5 High chan AV Band edge 1MB scheme 36M RBW J6525-5 High chan PK Band edge 1MB scheme 36M RBW
48Mbps	61.7	48.1	J6525-5 High chan AV Band edge 1MB scheme 48M RBW J6525-5 High chan PK Band edge 1MB scheme 48M RBW
54Mbps	61.8	47.7	J6525-5 High chan AV Band edge 1MB scheme 54M RBW J6525-5 High chan PK Band edge 1MB scheme 54M RBW

Limits: AV = 54dBuV/m at Restricted band edges
 PK = 74dBuV/m at Restricted band edges
 AV power complied with = 30dBc at Band edges
 PK power complied with = 20dBc at Band edges

The restricted band edges closest to the EUT frequency of 2400-2483.5MHz are 2390 & 2483.5MHz

Further wider span plots have been taken to show the fact that there are no spurious emissions above the restricted limits of 15.209.

These results show that the **EUT** has **PASSED** this test.

5.7.2.1 Test Equipment used

E492, E252

5.8 FHSS Parameters

The following tests were not applicable as the EUT does not employ FHSS Technology.

5.8.1 Frequency Separation

5.8.2 Number of hopping Channels

5.8.3 Dwell time

File name PURE.6525-5.DOCM

The contents of this report, apart from the referenced ANSI C63.4-2003, are beyond the scope of UKAS Testing Laboratory No. 2360 accreditation.

6 Plots and Results

6.1 Conducted Emissions

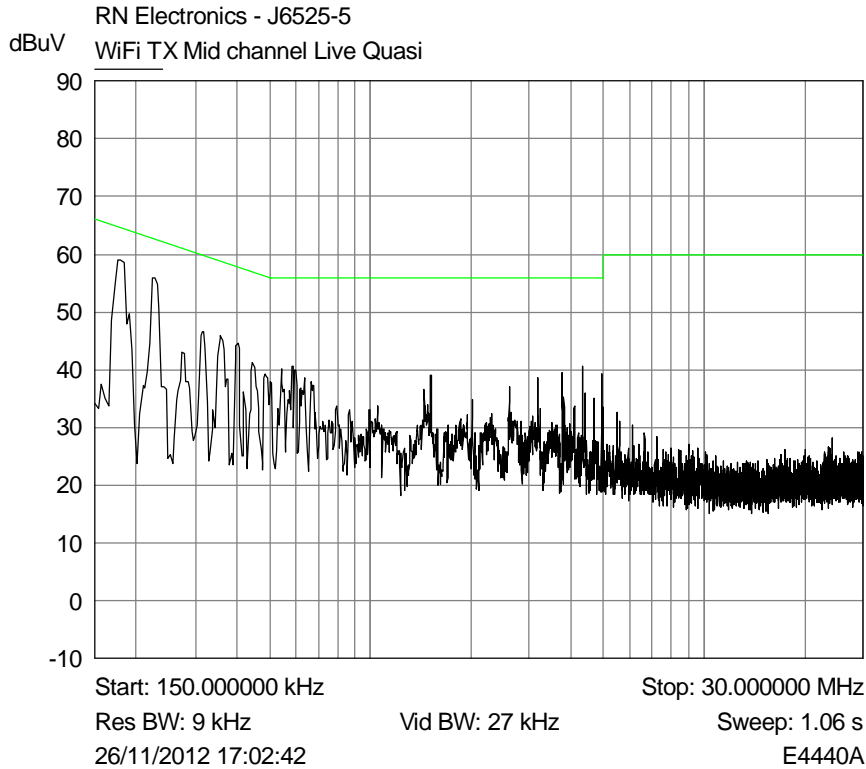

Plot of peak emissions 150kHz - 30MHz on the mains live terminal against the quasi-peak limit line.

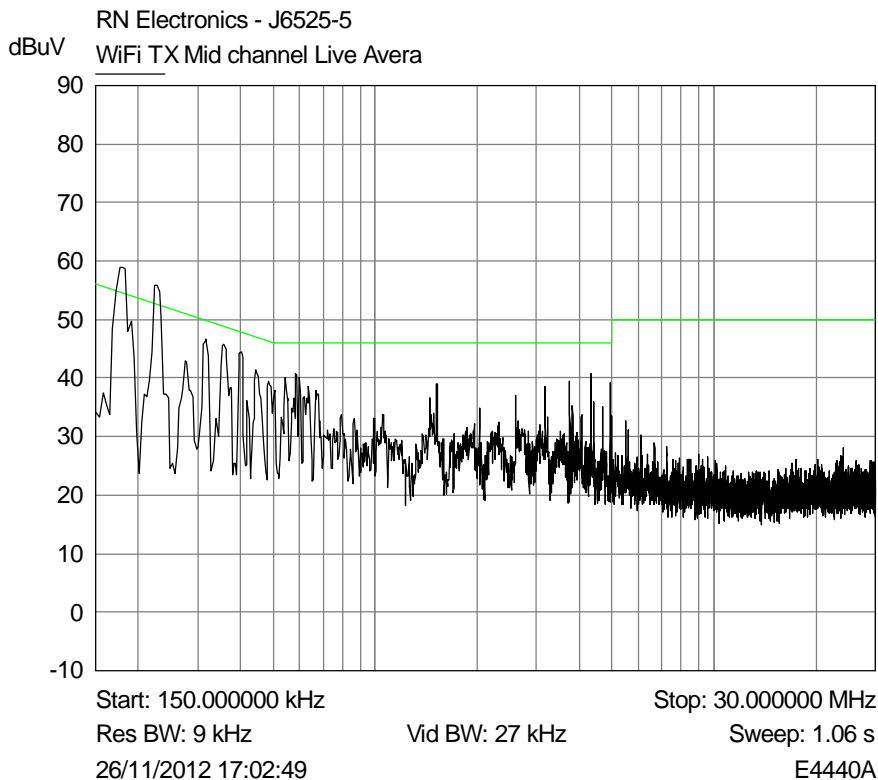

Plot of peak emissions 150kHz - 30MHz on the mains live terminal against the average limit line.

File name PURE.6525-5.DOCM

The contents of this report, apart from the referenced ANSI C63.4-2003, are beyond the scope of UKAS Testing Laboratory No. 2360 accreditation.

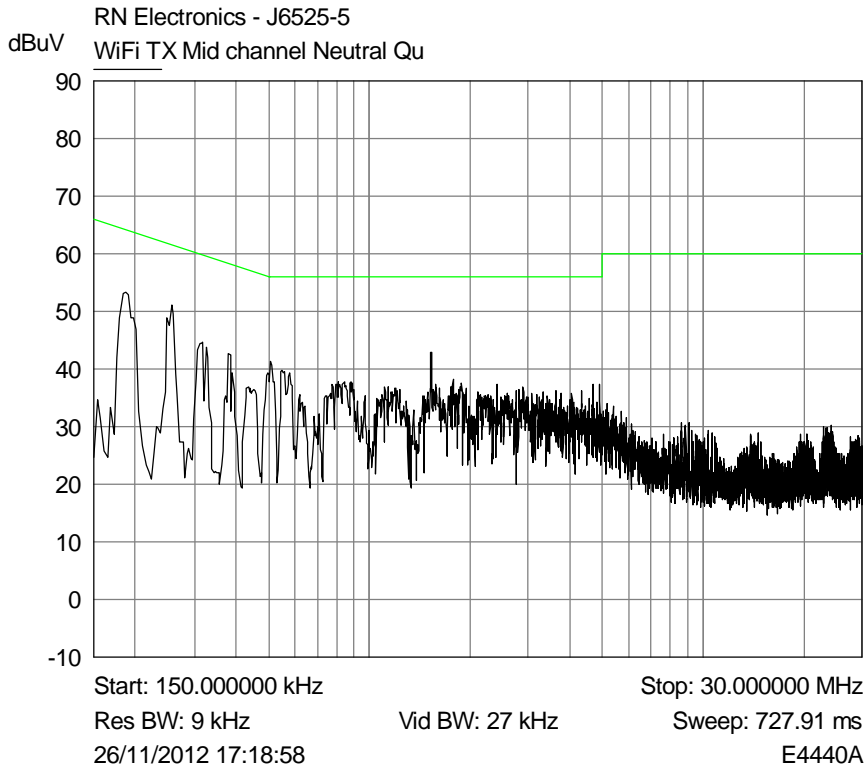

Plot of peak emissions 150kHz - 30MHz on the mains neutral terminal against the quasi-peak limit line.

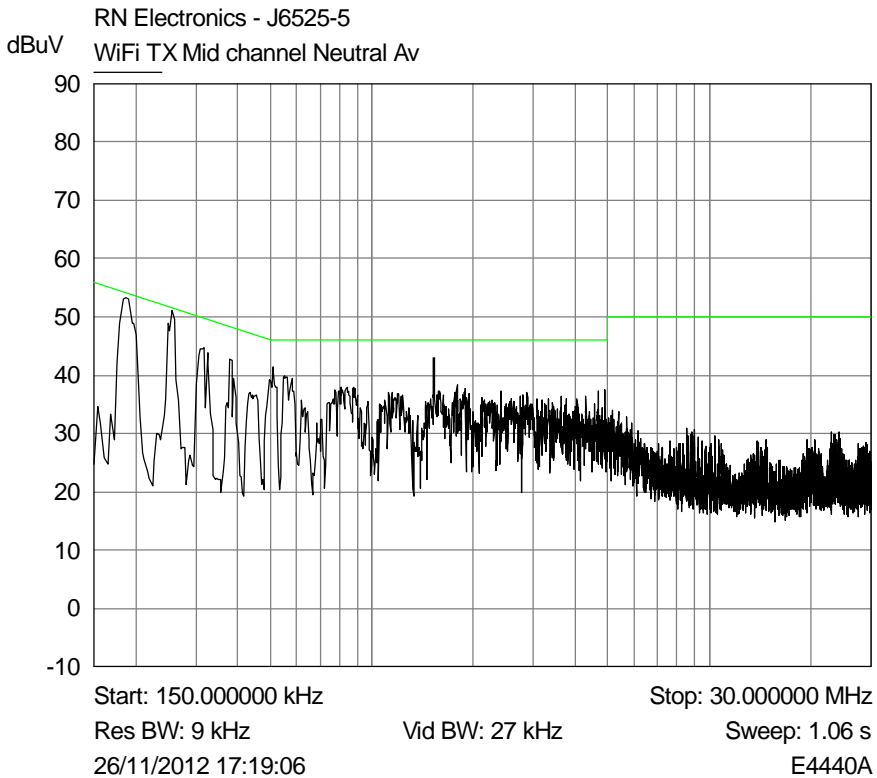

Plot of peak emissions 150kHz - 30MHz on the mains neutral terminal against the average limit line.

File name PURE.6525-5.DOCM

The contents of this report, apart from the referenced ANSI C63.4-2003, are beyond the scope of UKAS Testing Laboratory No. 2360 accreditation.

6.2 Radiated Emissions 9kHz – 1GHz

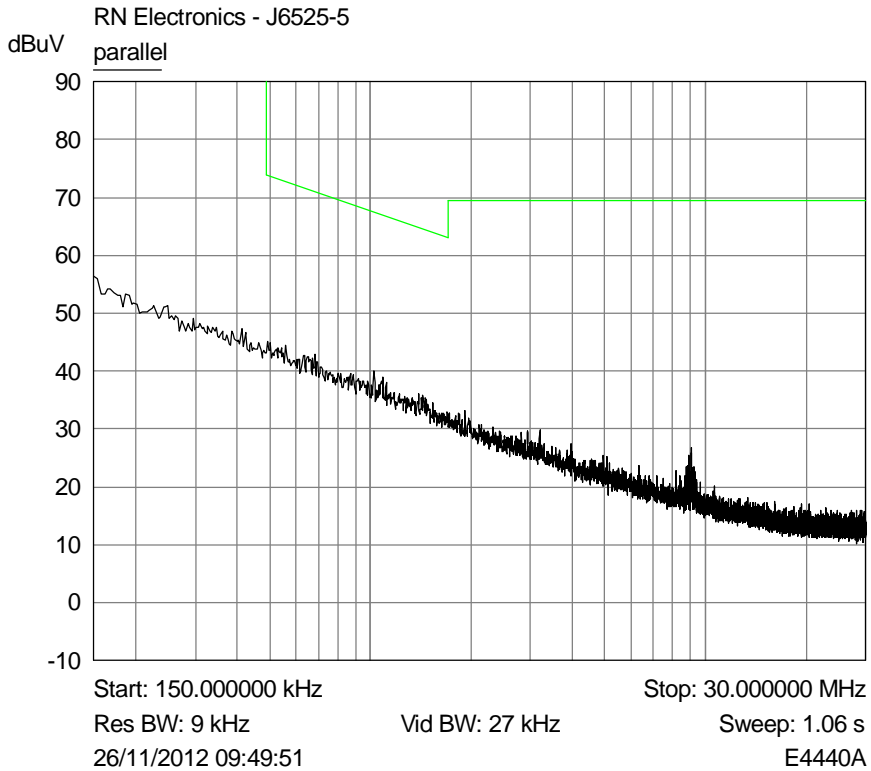

Plot of peak emissions 150kHz – 30MHz parallel against the quasi-peak limit line.

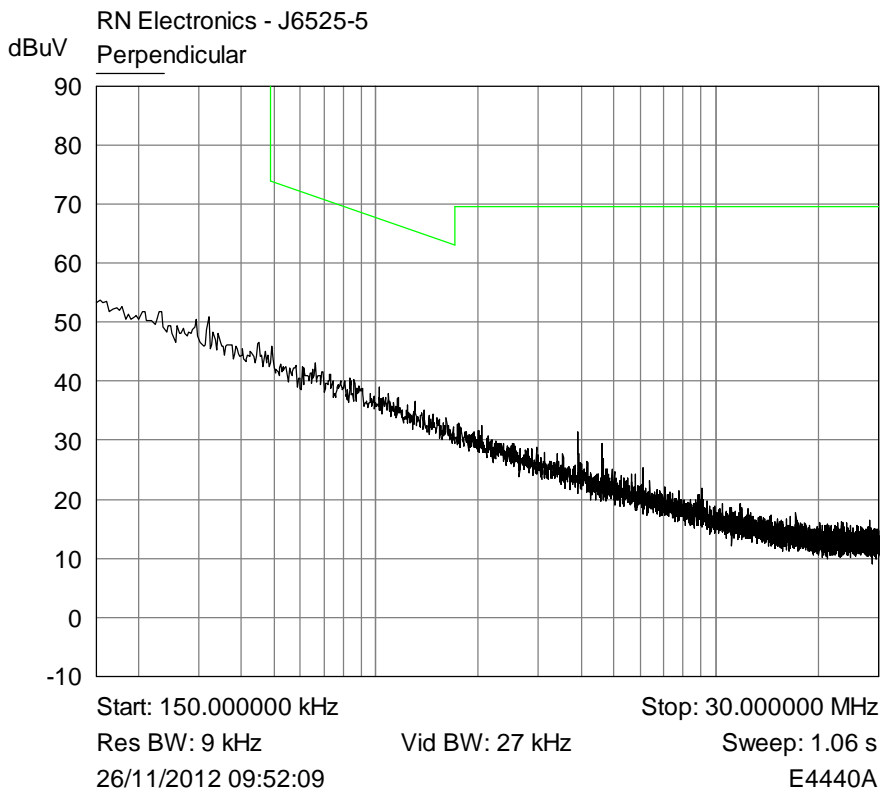

Plot of peak emissions 150kHz - 30MHz perpendicular against the quasi-peak limit line.

File name PURE.6525-5.DOCM

The contents of this report, apart from the referenced ANSI C63.4-2003, are beyond the scope of UKAS Testing Laboratory No. 2360 accreditation.

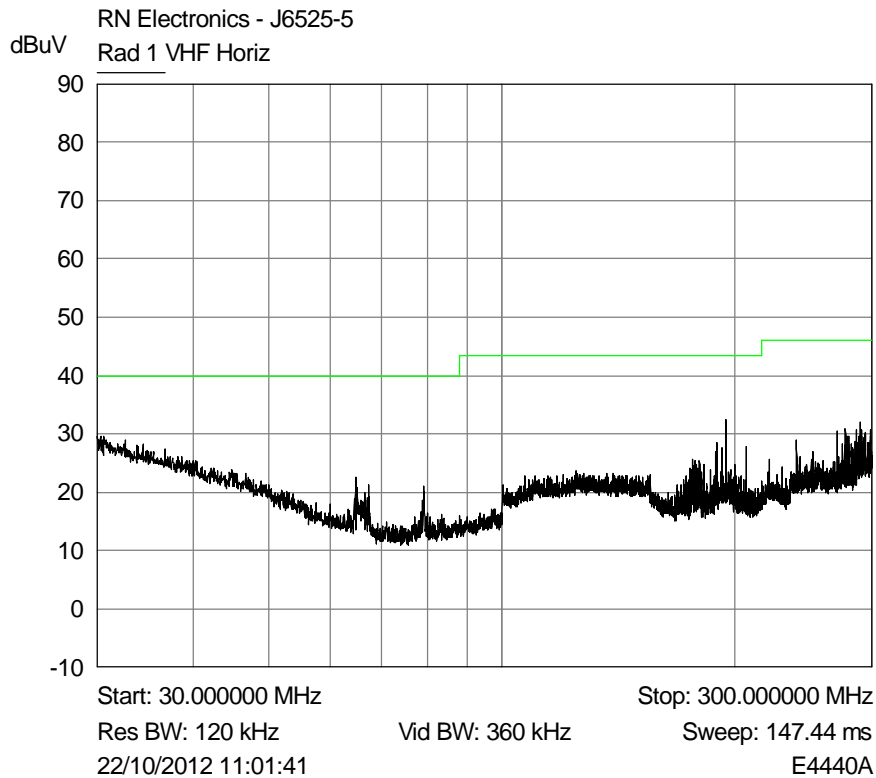

Plot of peak horizontal emissions 30MHz - 300MHz against the quasi-peak limit line.

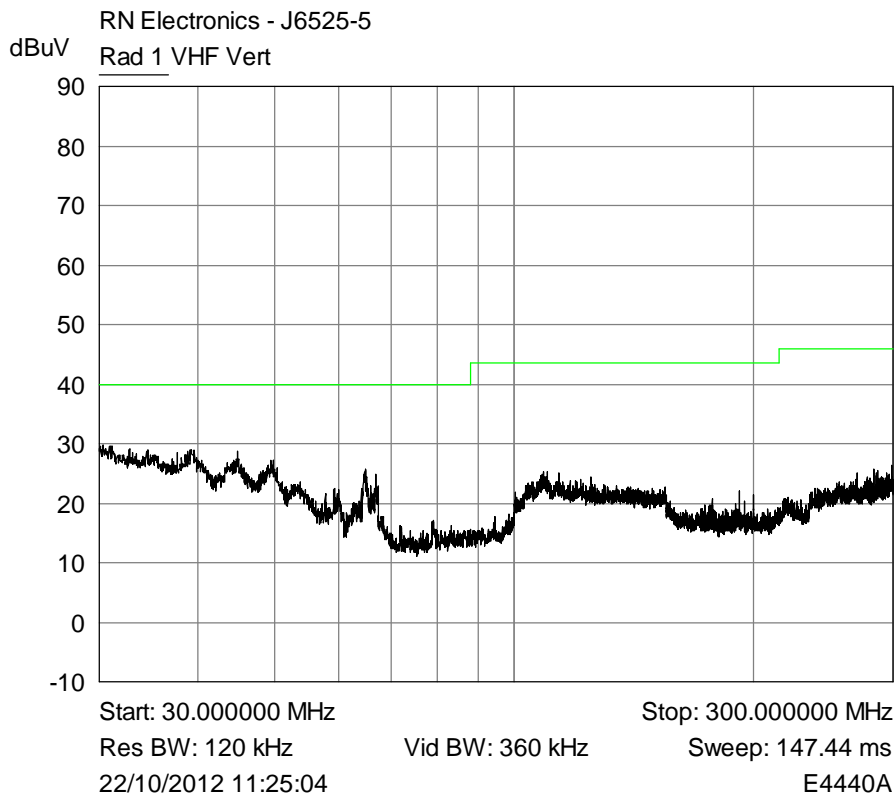

Plot of peak vertical emissions 30MHz - 300MHz against the quasi-peak limit line.

File name PURE.6525-5.DOCM

The contents of this report, apart from the referenced ANSI C63.4-2003, are beyond the scope of UKAS Testing Laboratory No. 2360 accreditation.

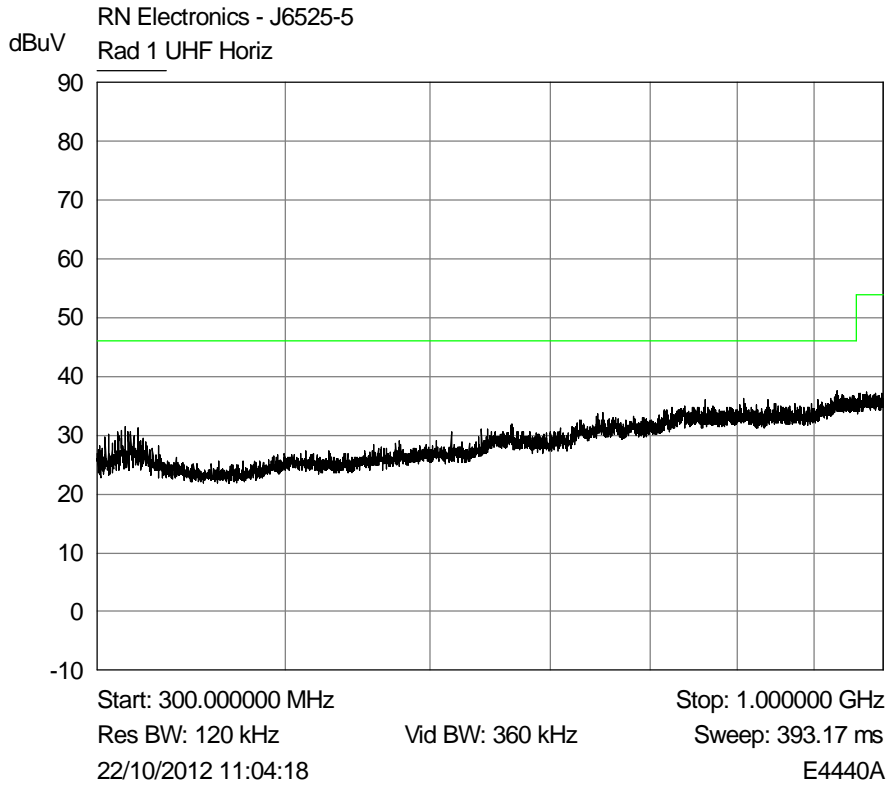

Plot of peak horizontal emissions 300MHz - 1GHz against the quasi-peak limit line.

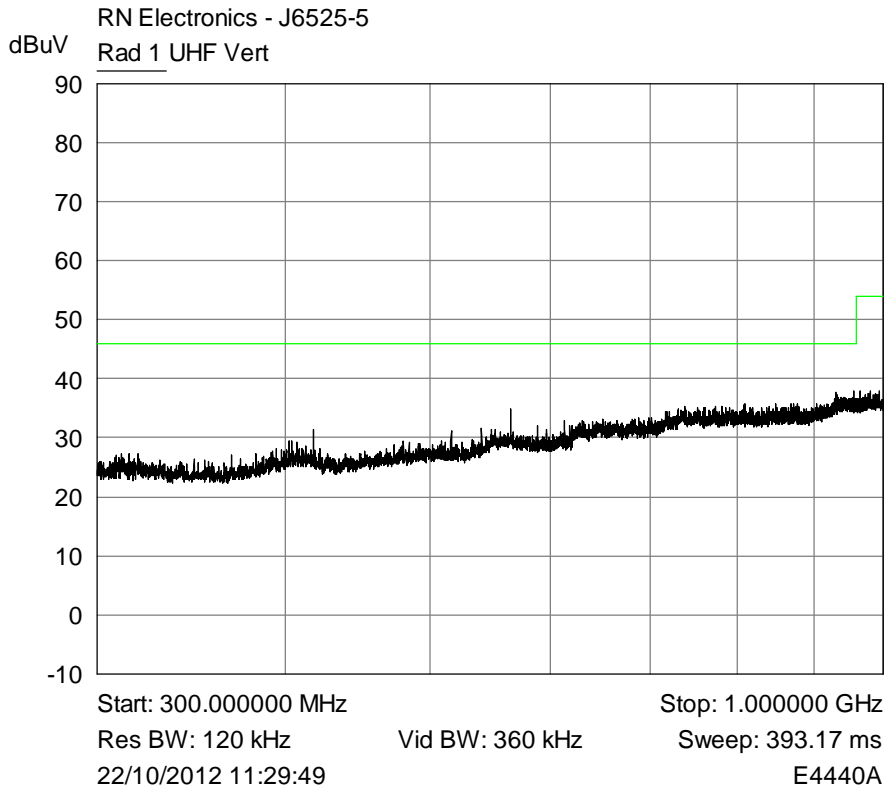

Plot of peak vertical emissions 300MHz - 1GHz against the quasi-peak limit line.

File name PURE.6525-5.DOCM

The contents of this report, apart from the referenced ANSI C63.4-2003, are beyond the scope of UKAS Testing Laboratory No. 2360 accreditation.

6.3 Radiated Emissions above 1GHz

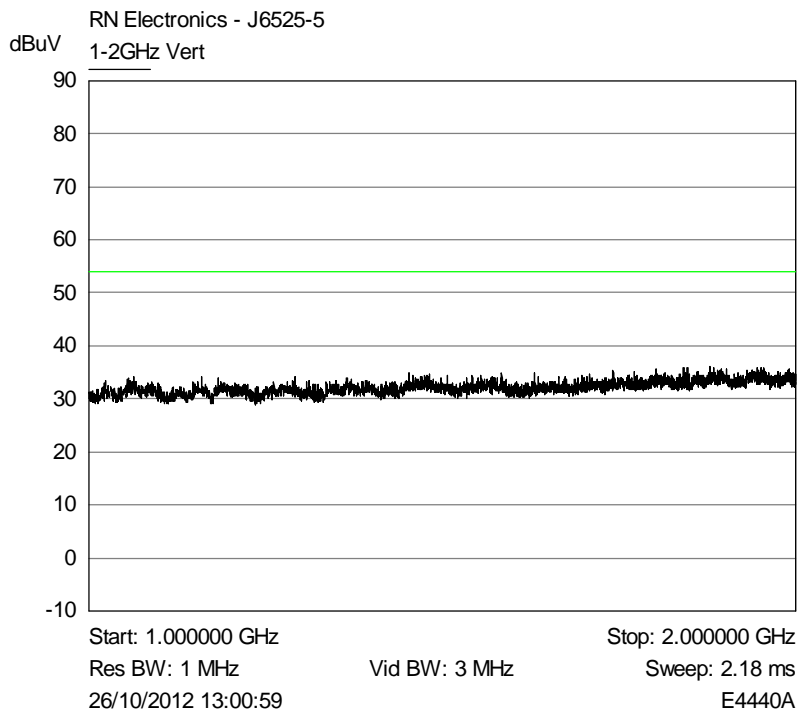
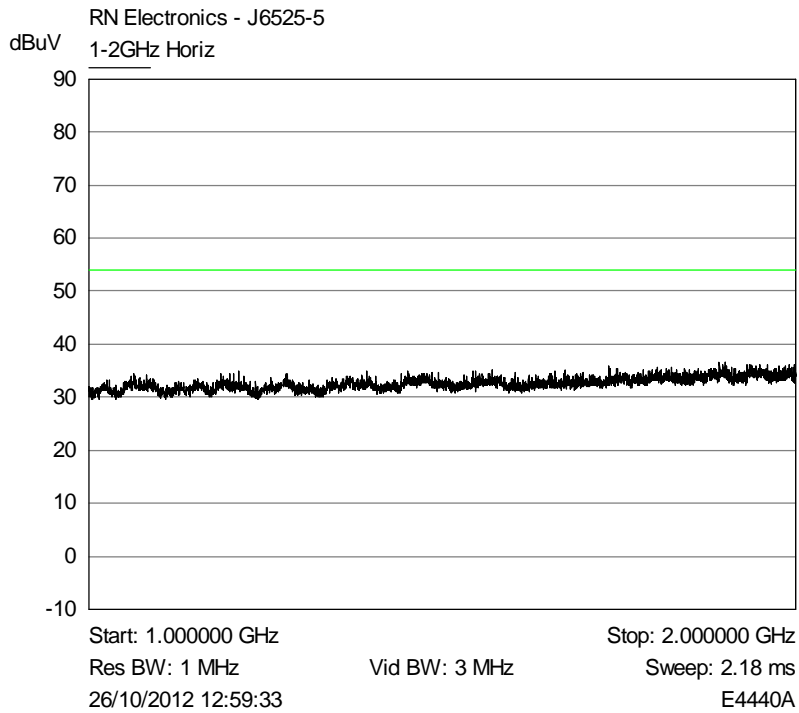

File name PURE.6525-5.DOCM

The contents of this report, apart from the referenced ANSI C63.4-2003, are beyond the scope of UKAS Testing Laboratory No. 2360 accreditation.

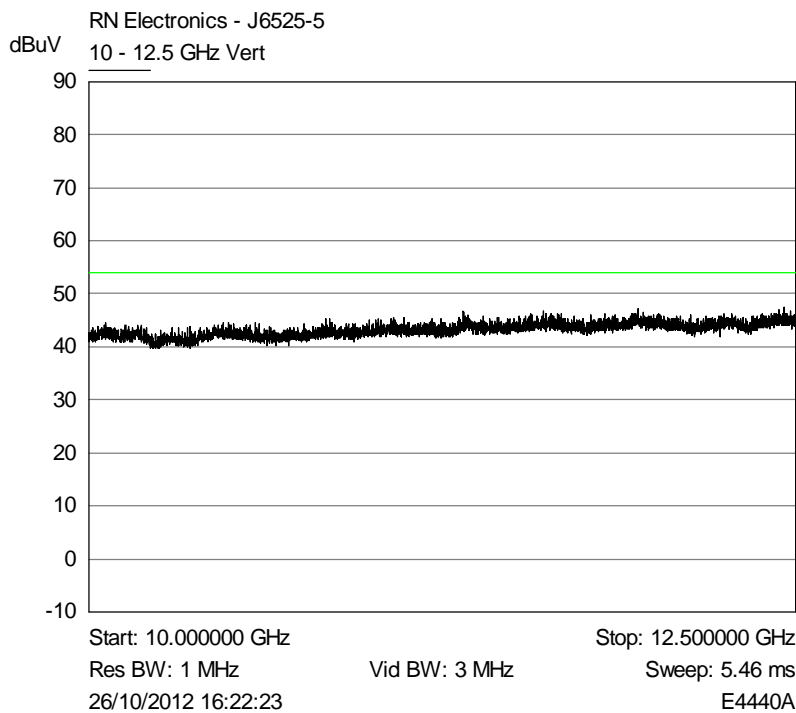
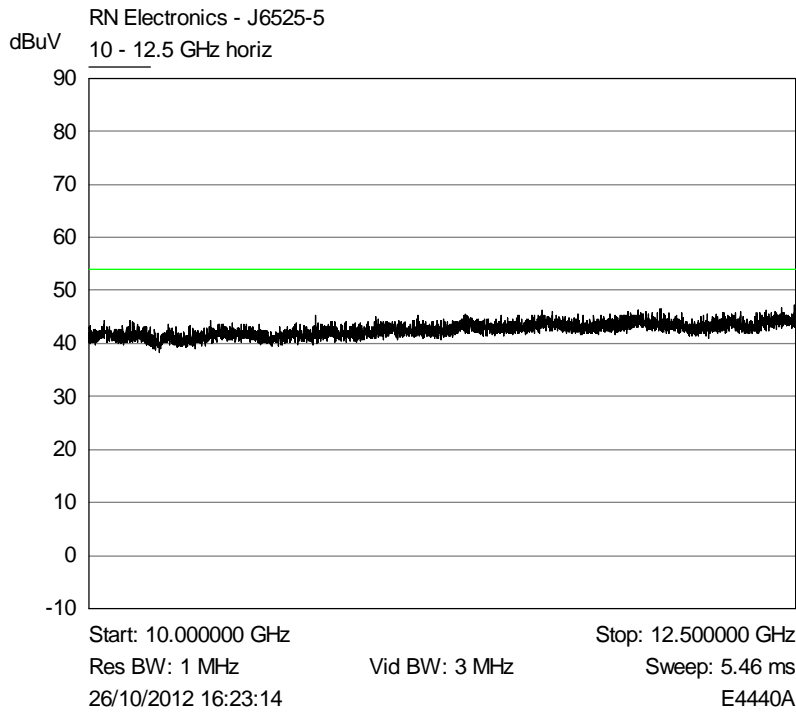

File name PURE.6525-5.DOCM

The contents of this report, apart from the referenced ANSI C63.4-2003, are beyond the scope of UKAS Testing Laboratory No. 2360 accreditation.

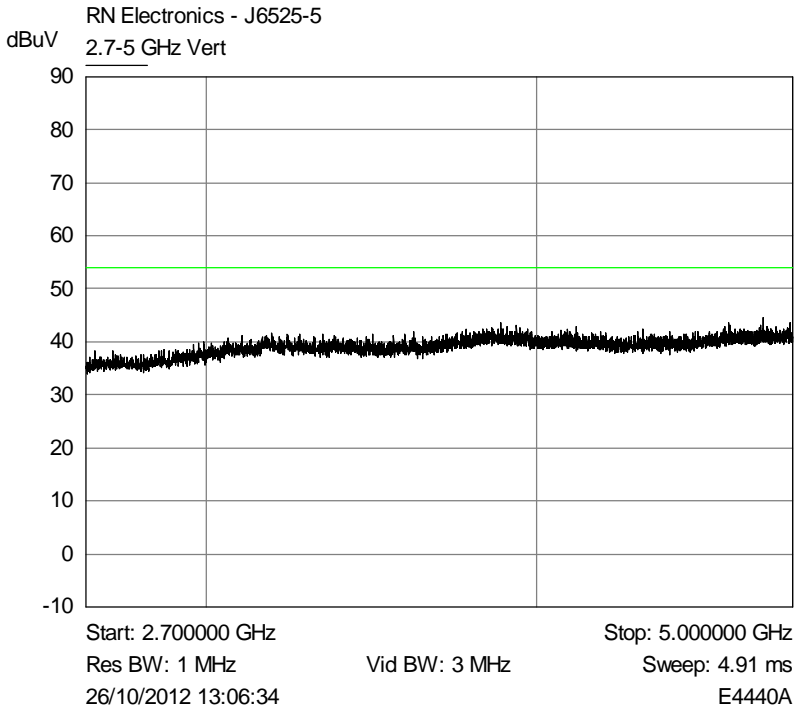
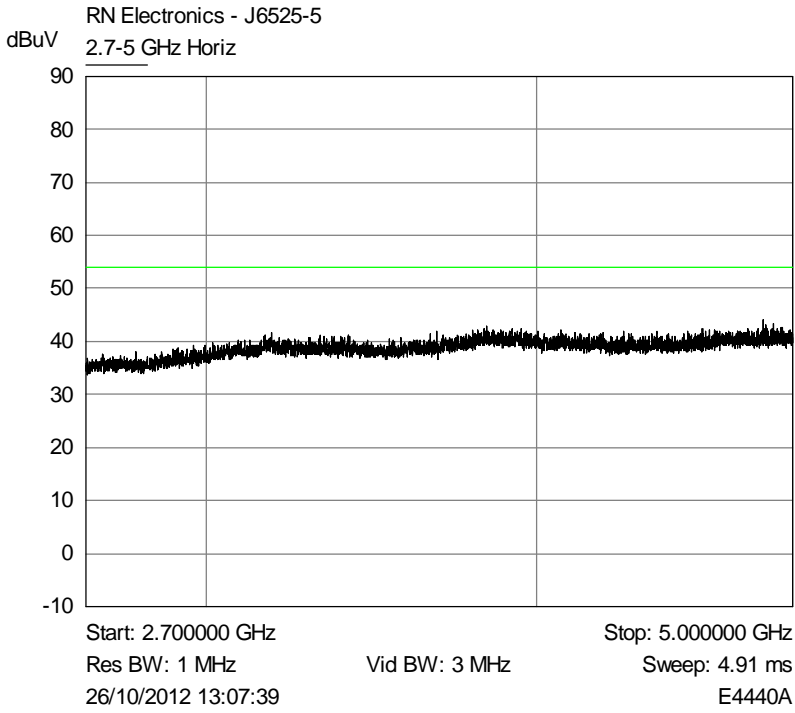

File name PURE.6525-5.DOCM

The contents of this report, apart from the referenced ANSI C63.4-2003, are beyond the scope of UKAS Testing Laboratory No. 2360 accreditation.

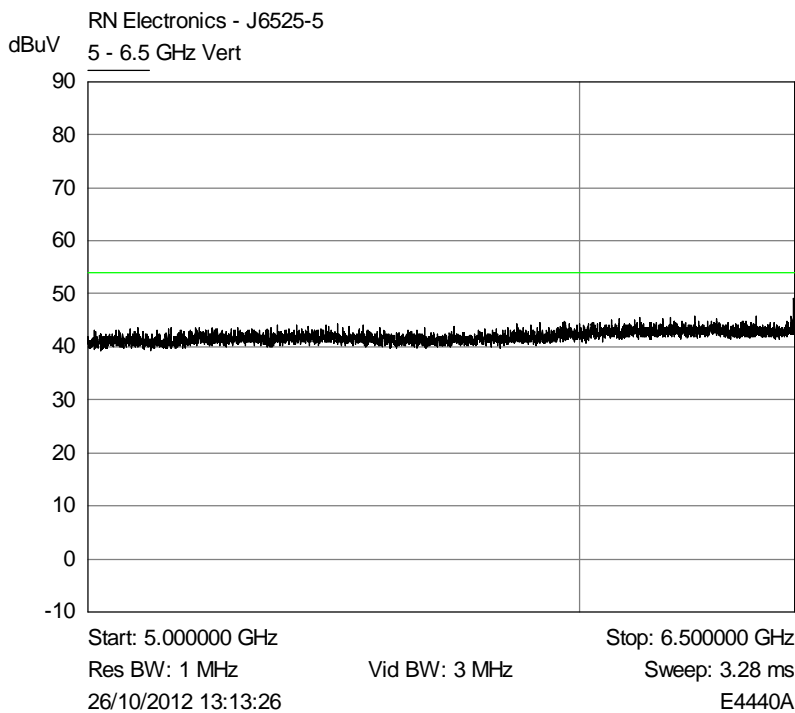
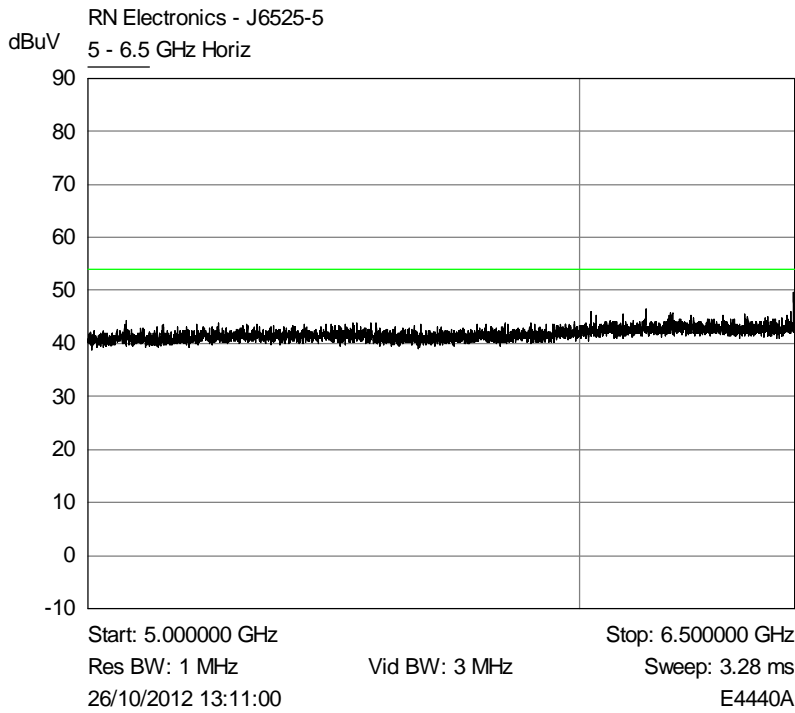

File name PURE.6525-5.DOCM

The contents of this report, apart from the referenced ANSI C63.4-2003, are beyond the scope of UKAS Testing Laboratory No. 2360 accreditation.

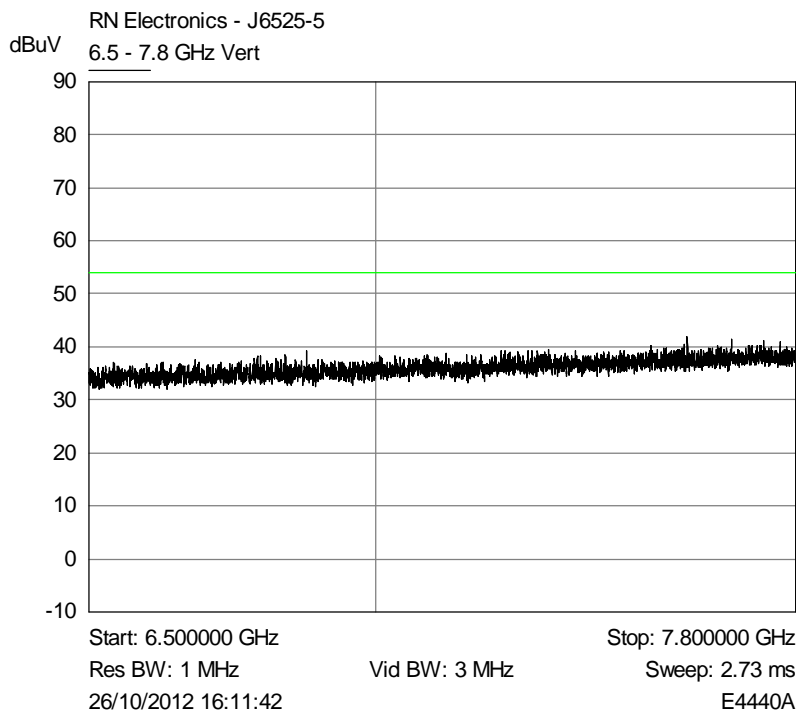
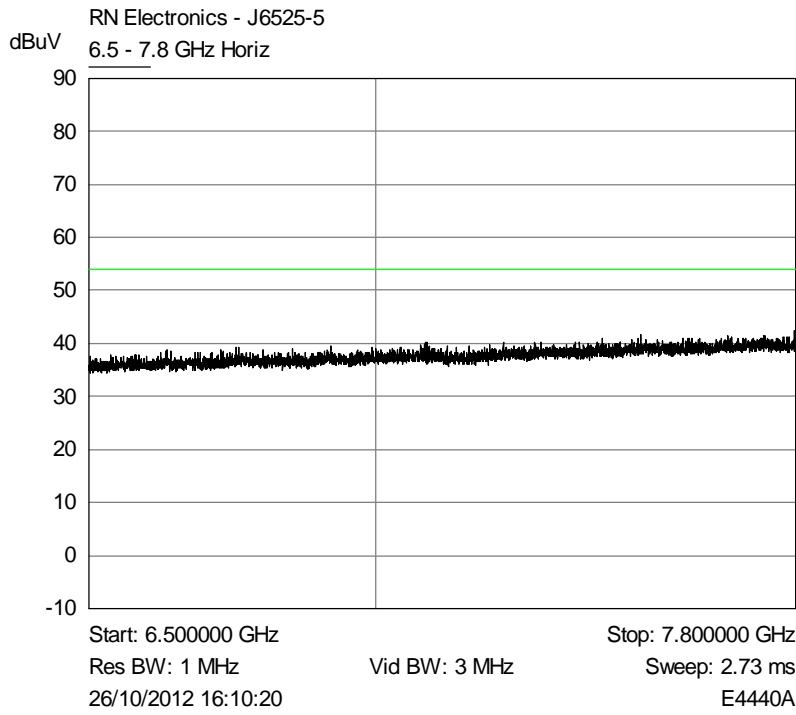

File name PURE.6525-5.DOCM

The contents of this report, apart from the referenced ANSI C63.4-2003, are beyond the scope of UKAS Testing Laboratory No. 2360 accreditation.

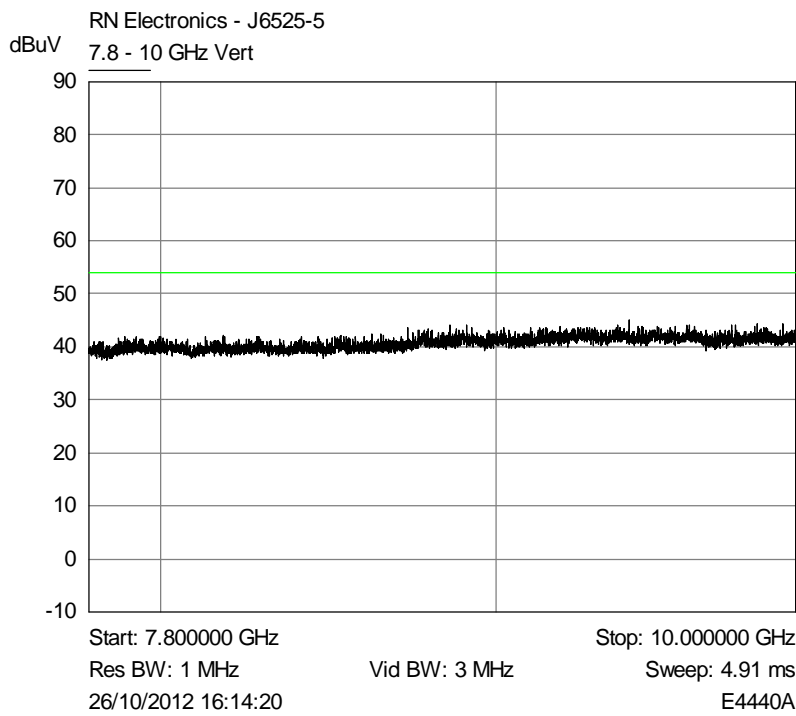
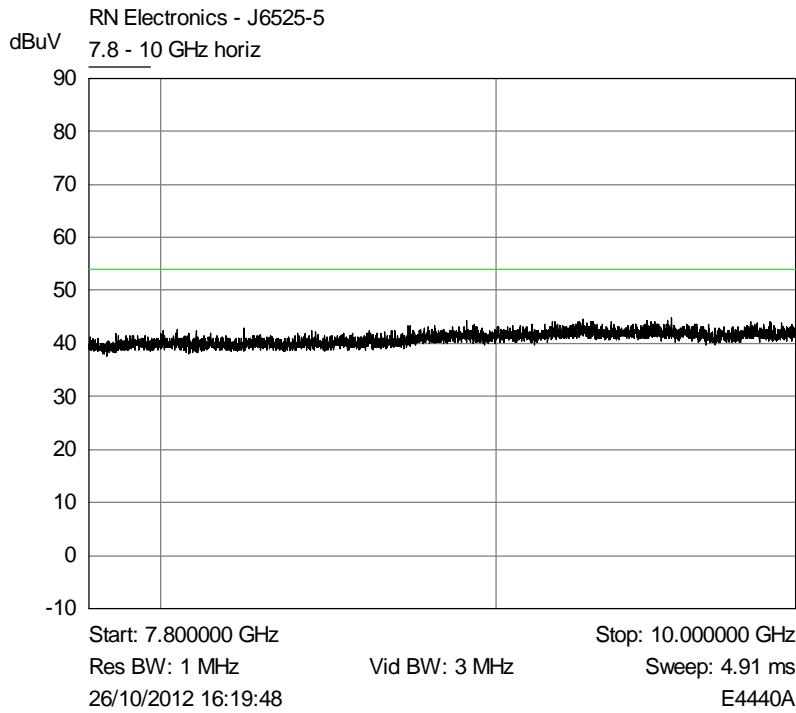

File name PURE.6525-5.DOCM

The contents of this report, apart from the referenced ANSI C63.4-2003, are beyond the scope of UKAS Testing Laboratory No. 2360 accreditation.

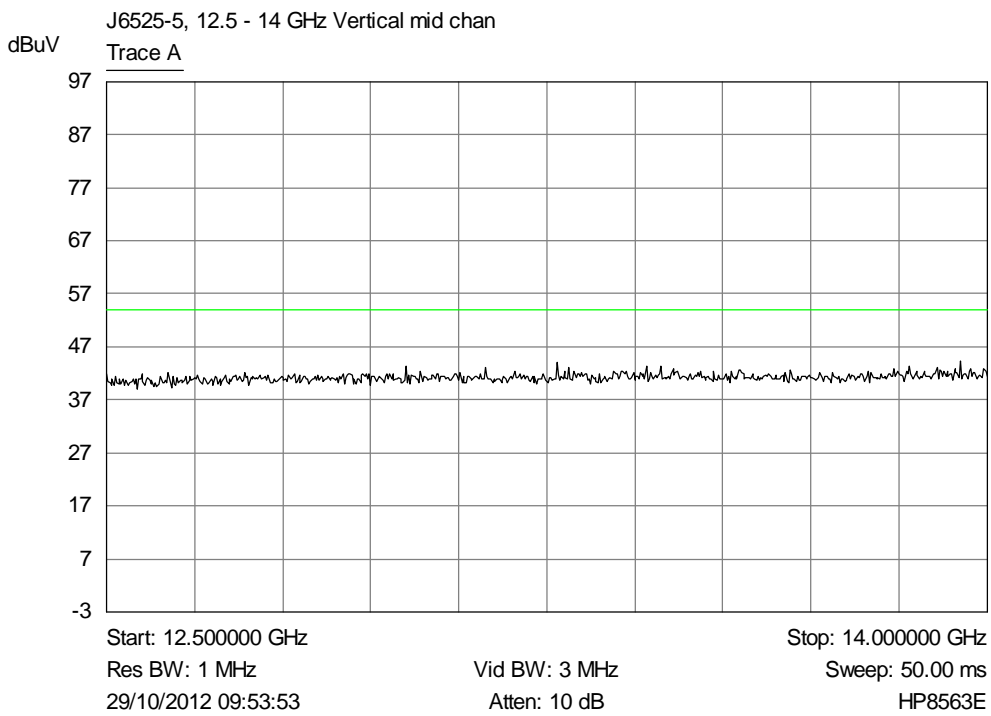
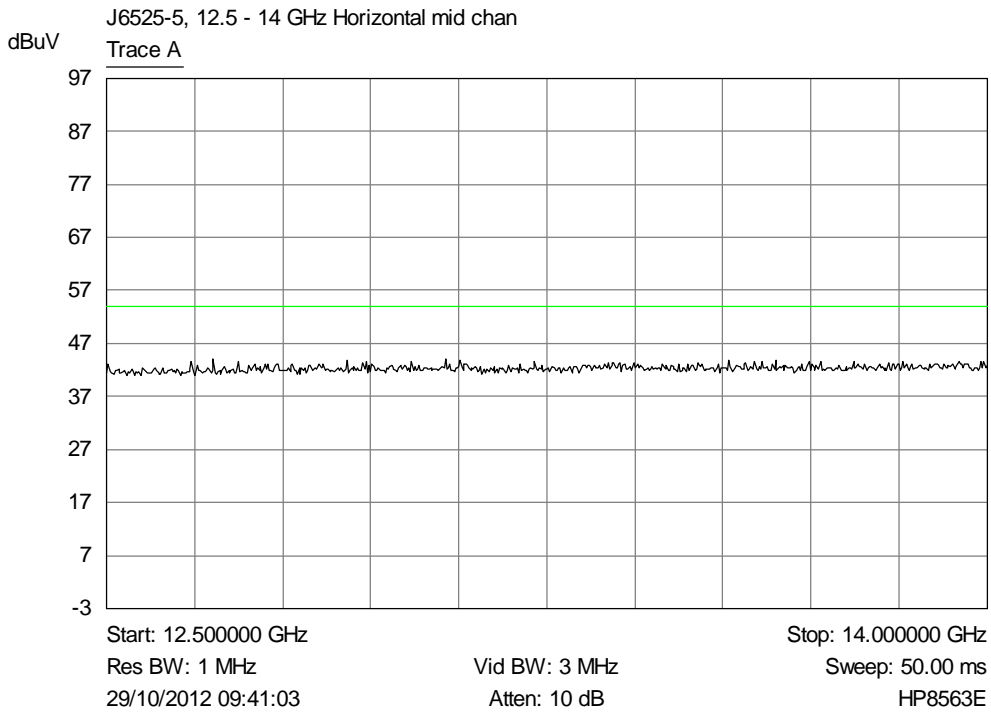

File name PURE.6525-5.DOCM

The contents of this report, apart from the referenced ANSI C63.4-2003, are beyond the scope of UKAS Testing Laboratory No. 2360 accreditation.

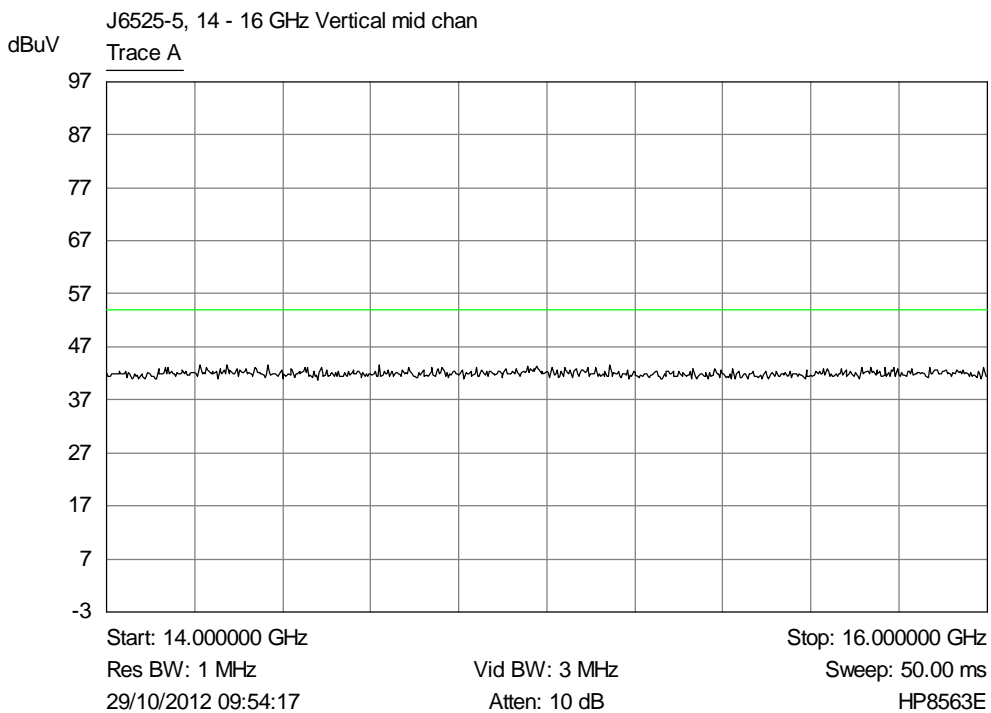
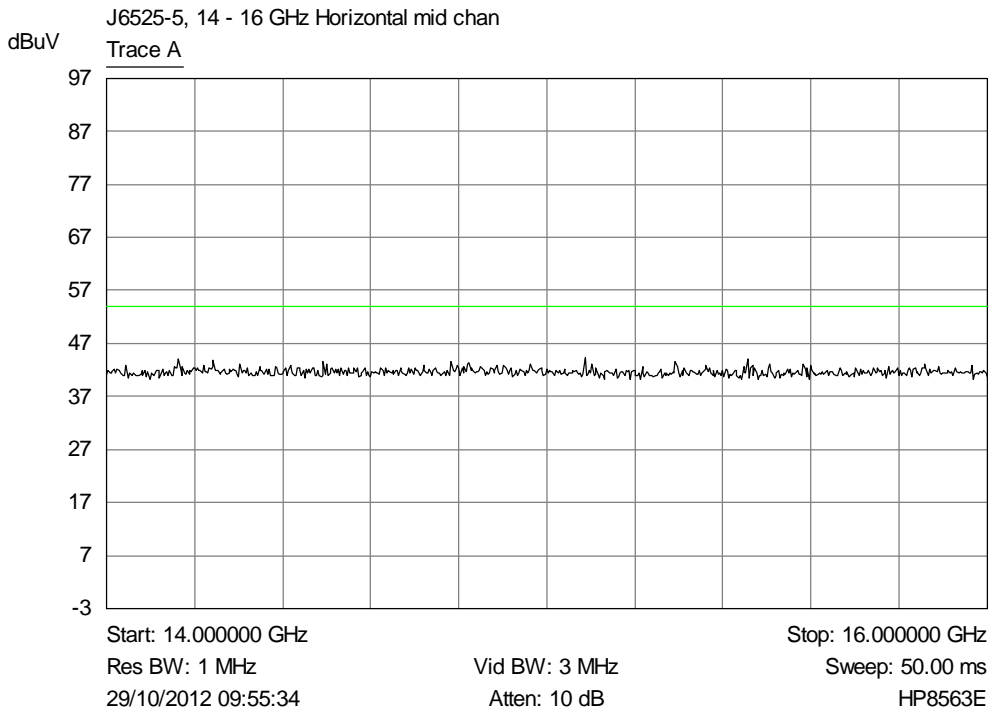

File name PURE.6525-5.DOCM

The contents of this report, apart from the referenced ANSI C63.4-2003, are beyond the scope of UKAS Testing Laboratory No. 2360 accreditation.

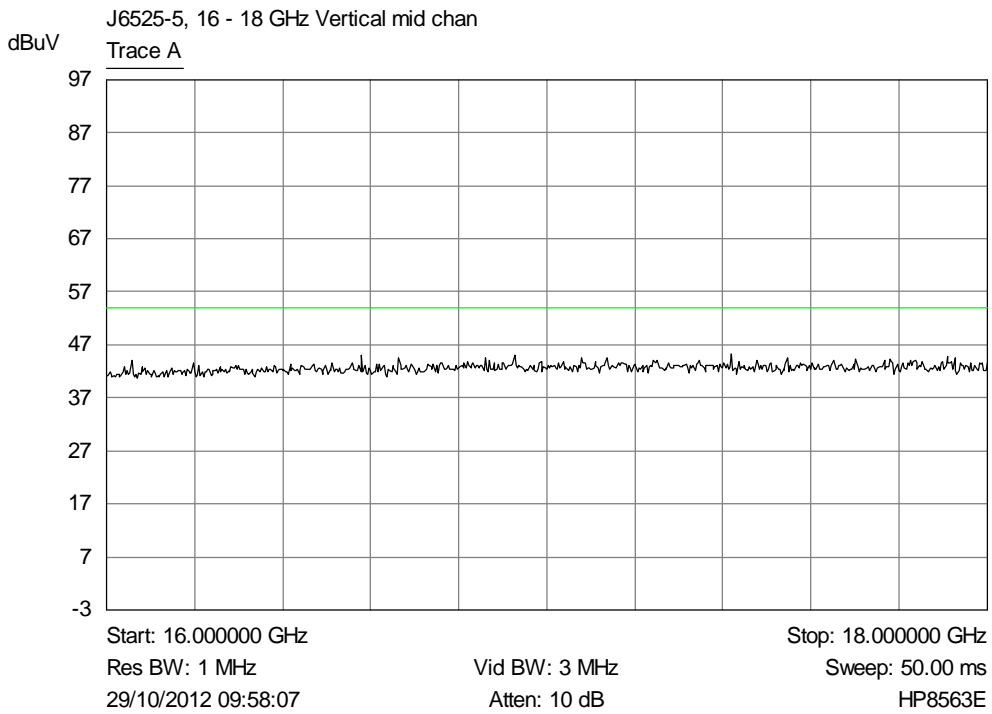
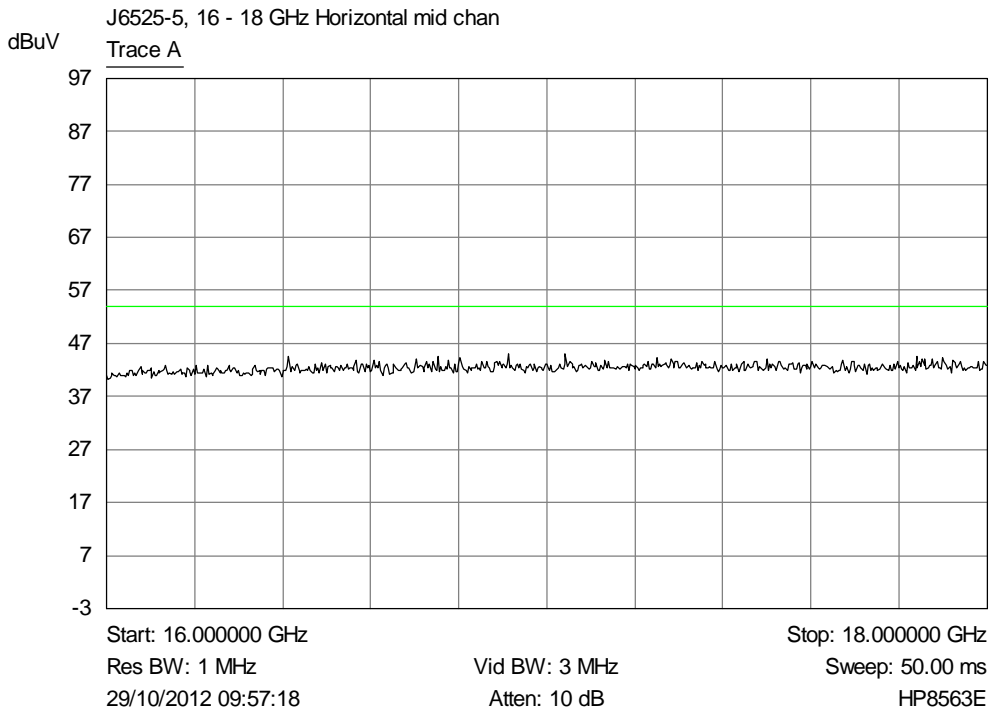

File name PURE.6525-5.DOCM

The contents of this report, apart from the referenced ANSI C63.4-2003, are beyond the scope of UKAS Testing Laboratory No. 2360 accreditation.

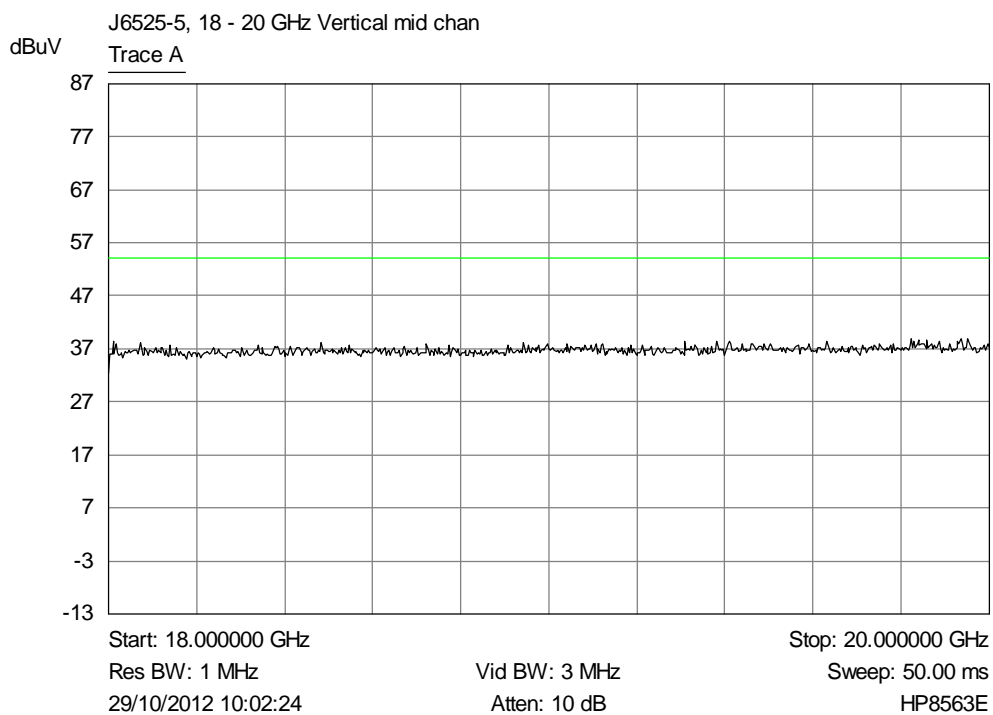
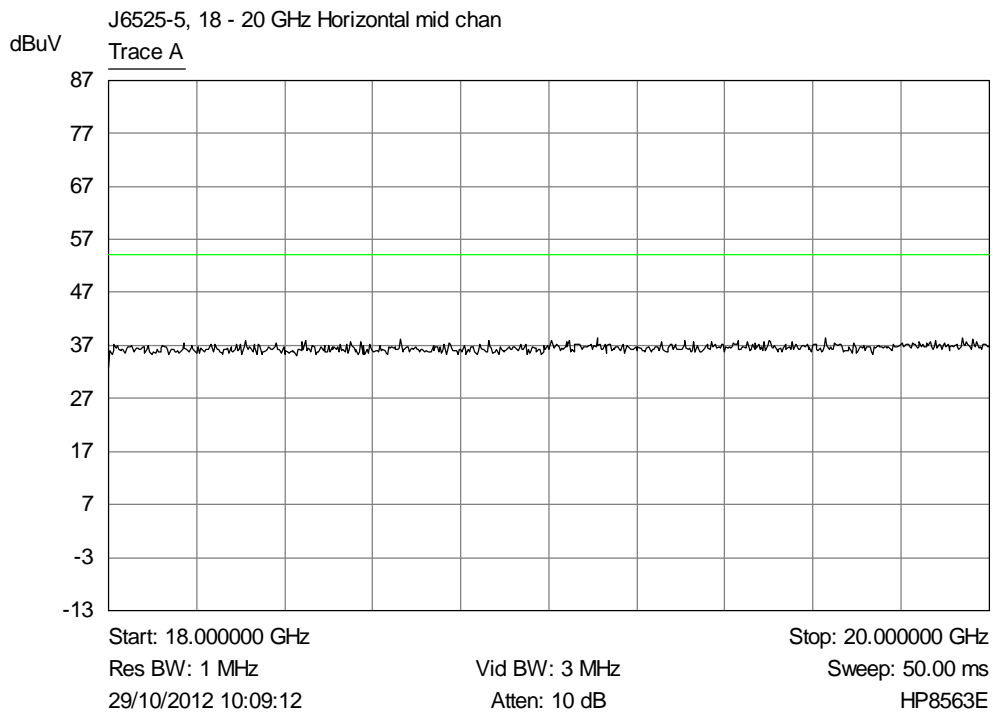

File name PURE.6525-5.DOCM

The contents of this report, apart from the referenced ANSI C63.4-2003, are beyond the scope of UKAS Testing Laboratory No. 2360 accreditation.

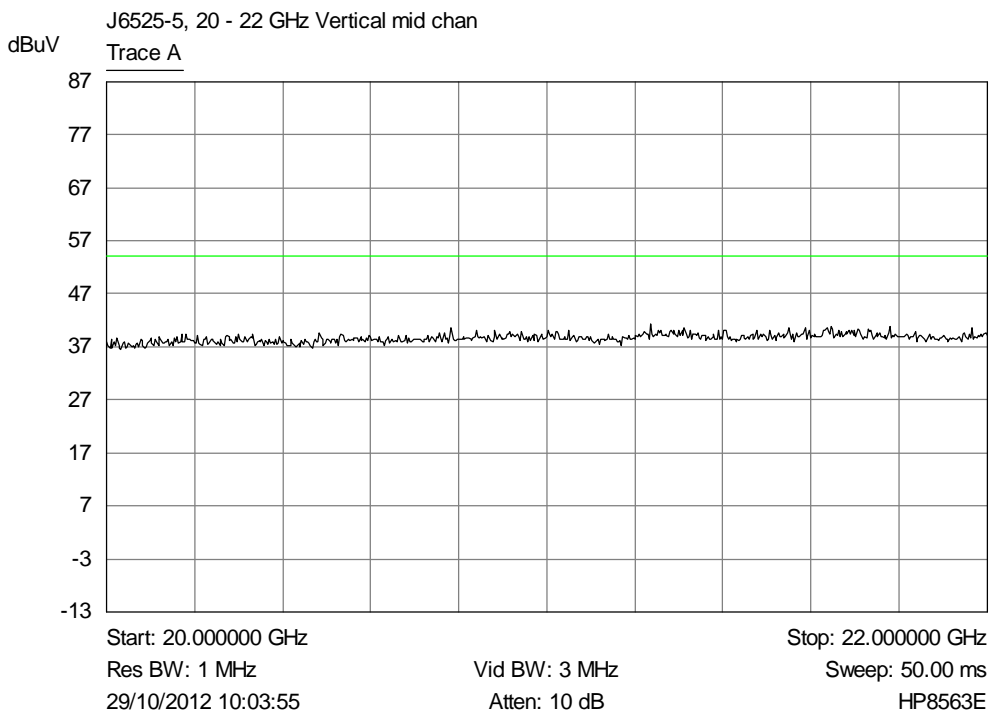
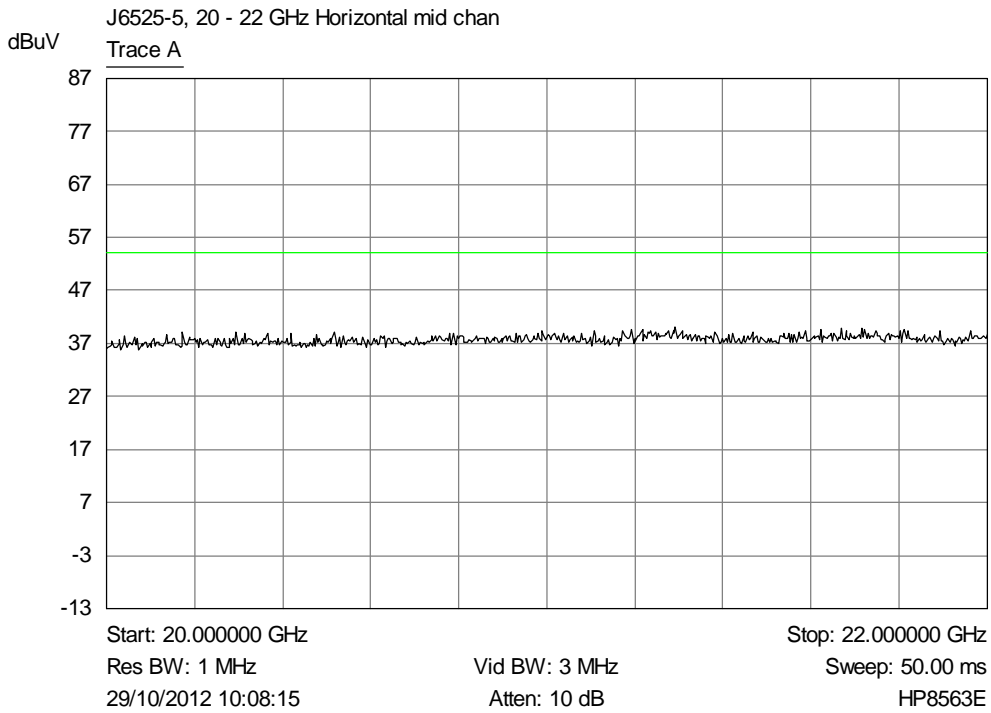

File name PURE.6525-5.DOCM

The contents of this report, apart from the referenced ANSI C63.4-2003, are beyond the scope of UKAS Testing Laboratory No. 2360 accreditation.

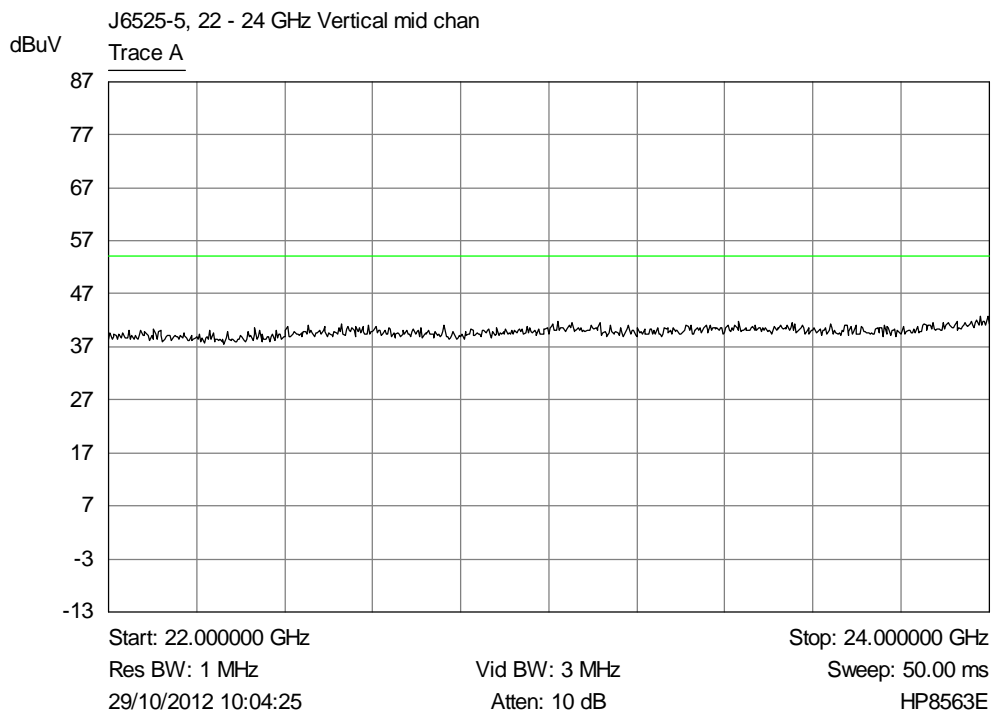
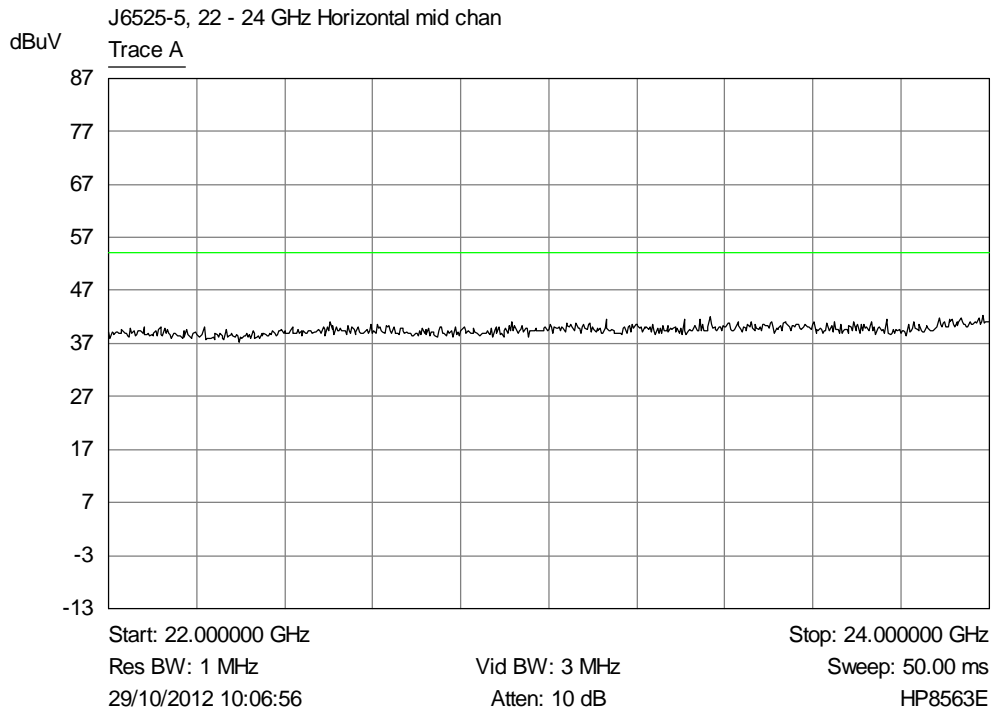

File name PURE.6525-5.DOCM

The contents of this report, apart from the referenced ANSI C63.4-2003, are beyond the scope of UKAS Testing Laboratory No. 2360 accreditation.

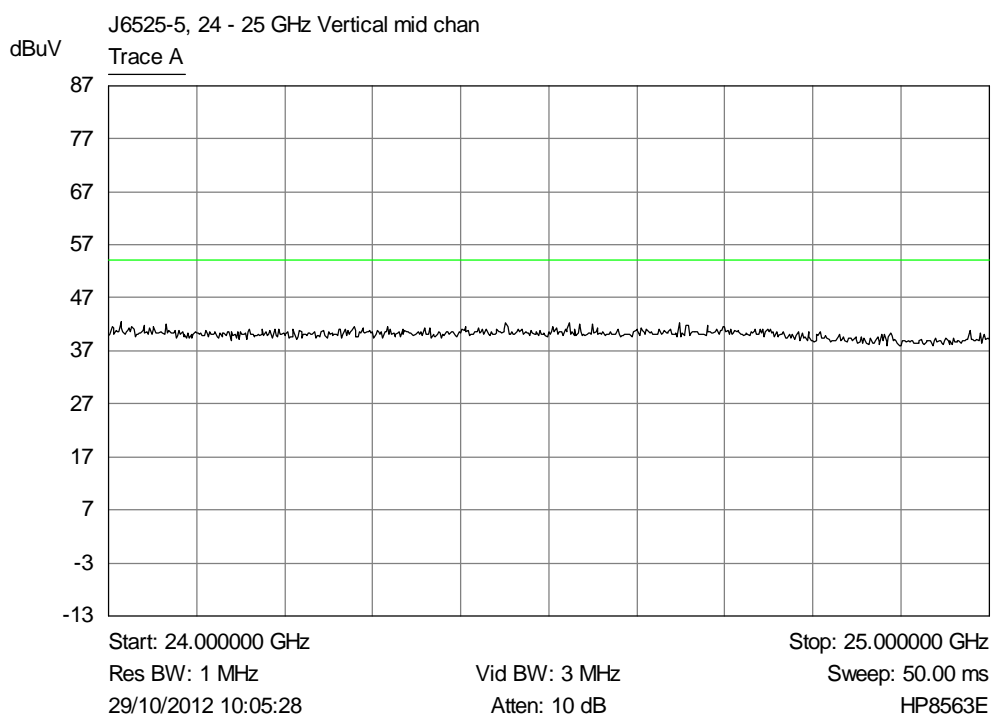
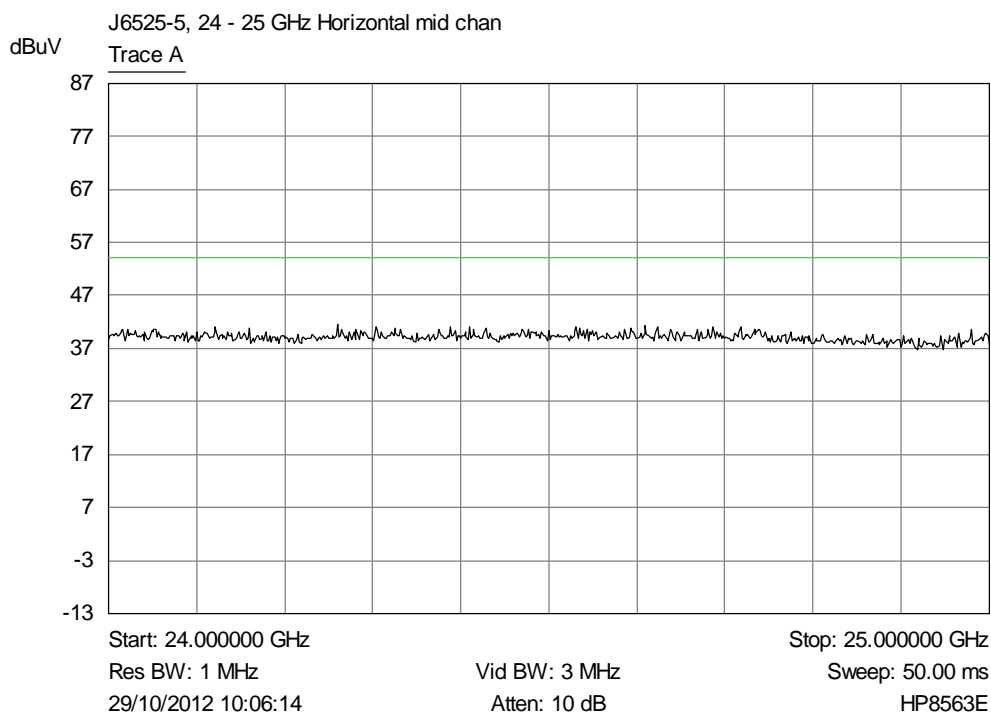

6.4 6dB Bandwidth

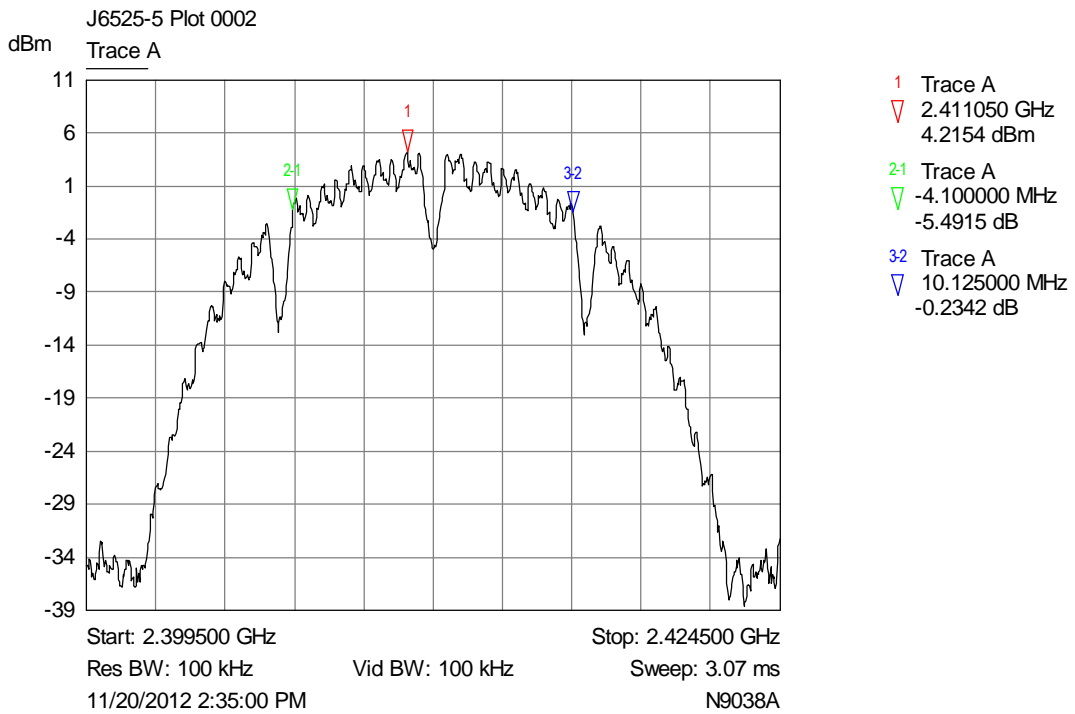
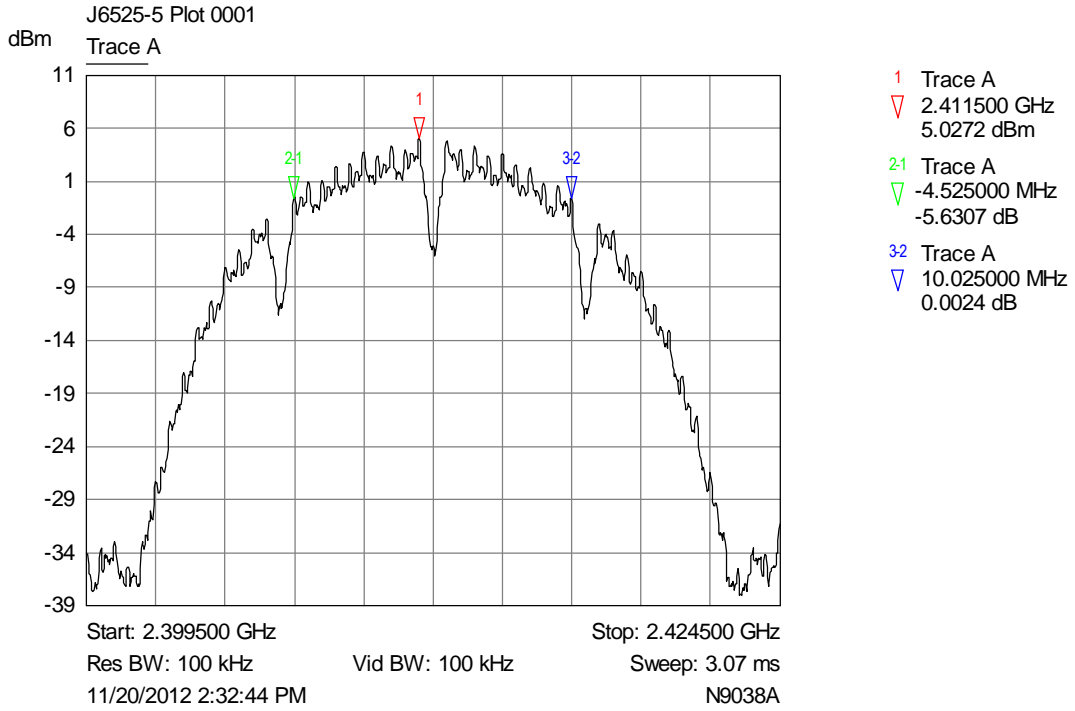

File name PURE.6525-5.DOCM

The contents of this report, apart from the referenced ANSI C63.4-2003, are beyond the scope of UKAS Testing Laboratory No. 2360 accreditation.

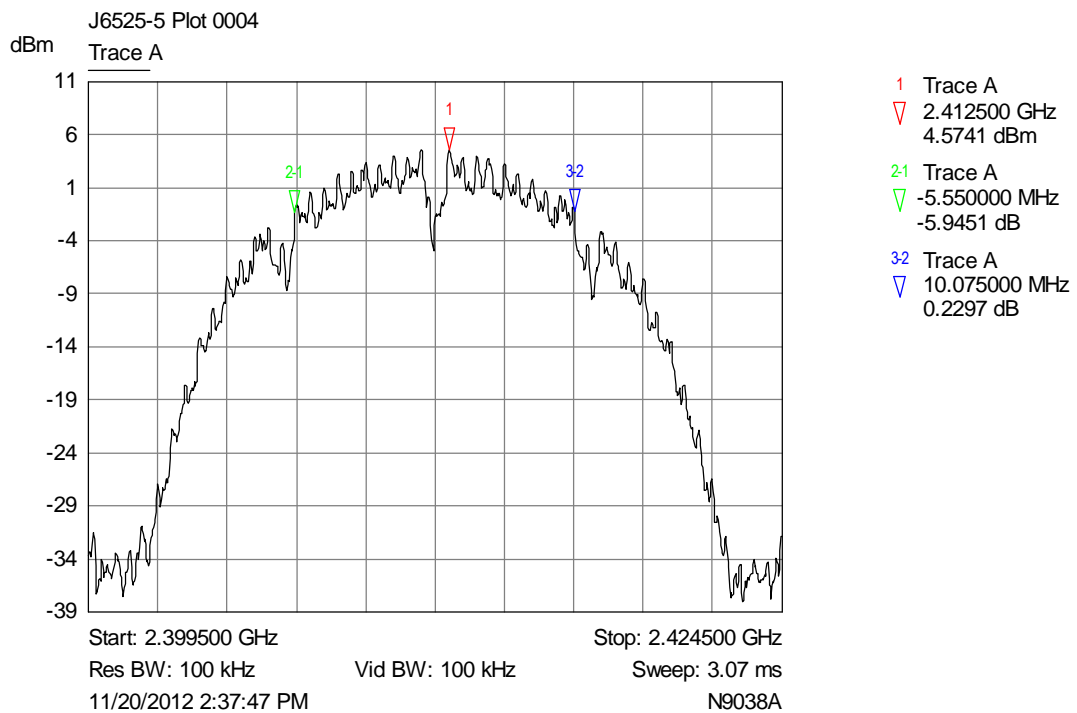
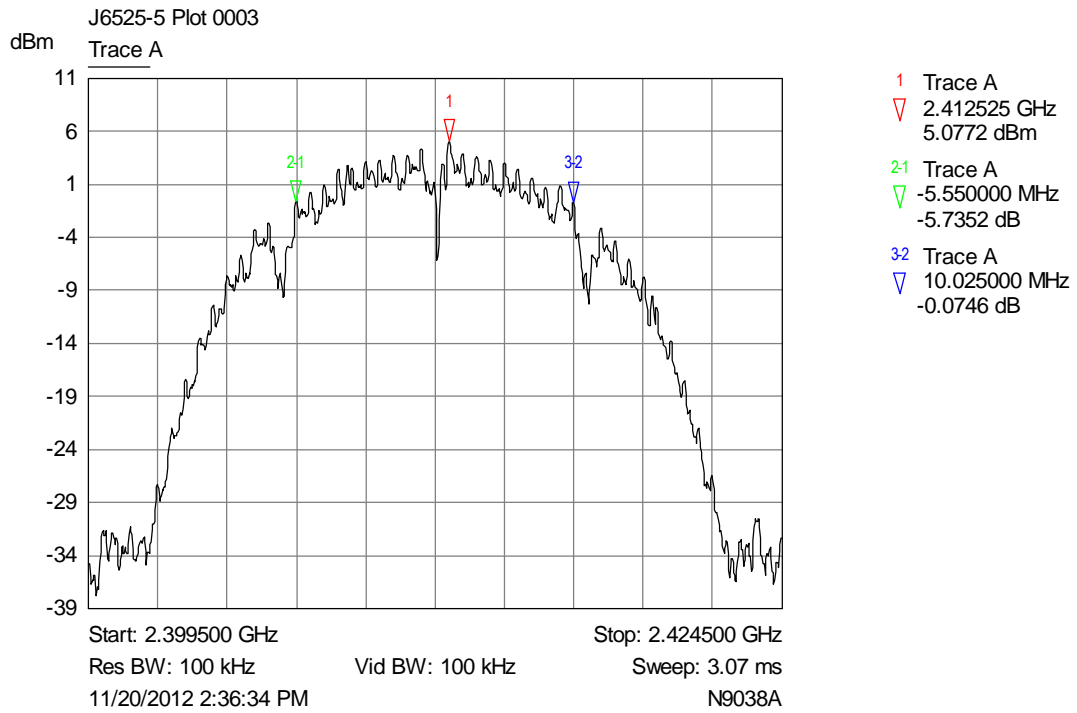

File name PURE.6525-5.DOCM

The contents of this report, apart from the referenced ANSI C63.4-2003, are beyond the scope of UKAS Testing Laboratory No. 2360 accreditation.

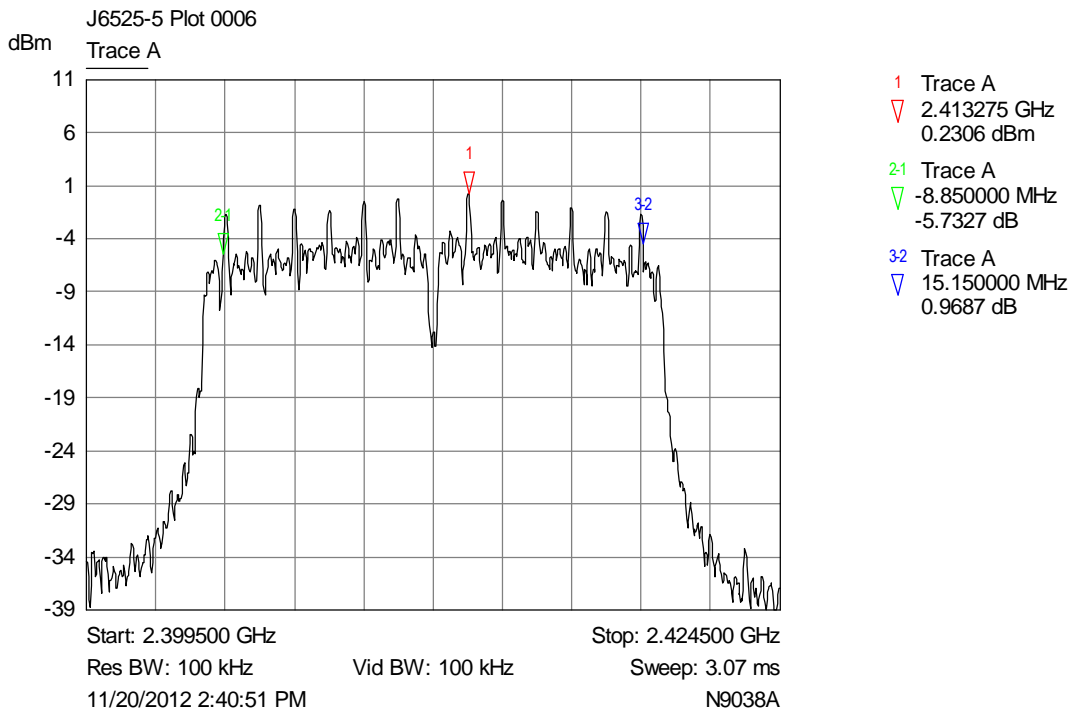
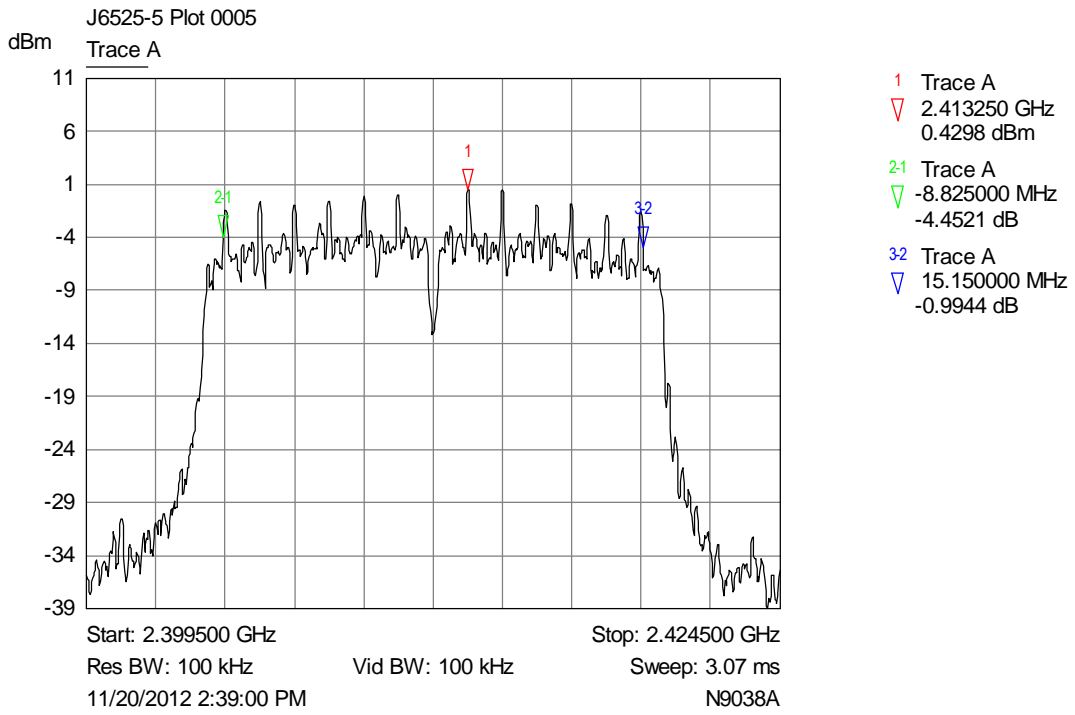

File name PURE.6525-5.DOCM

The contents of this report, apart from the referenced ANSI C63.4-2003, are beyond the scope of UKAS Testing Laboratory No. 2360 accreditation.

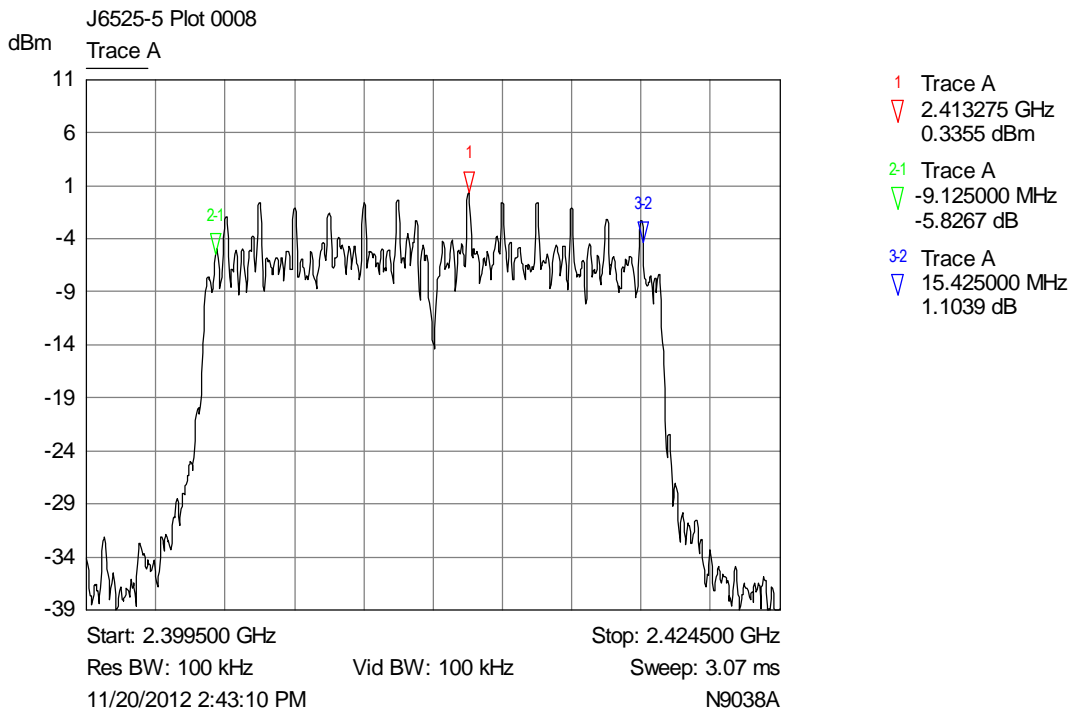
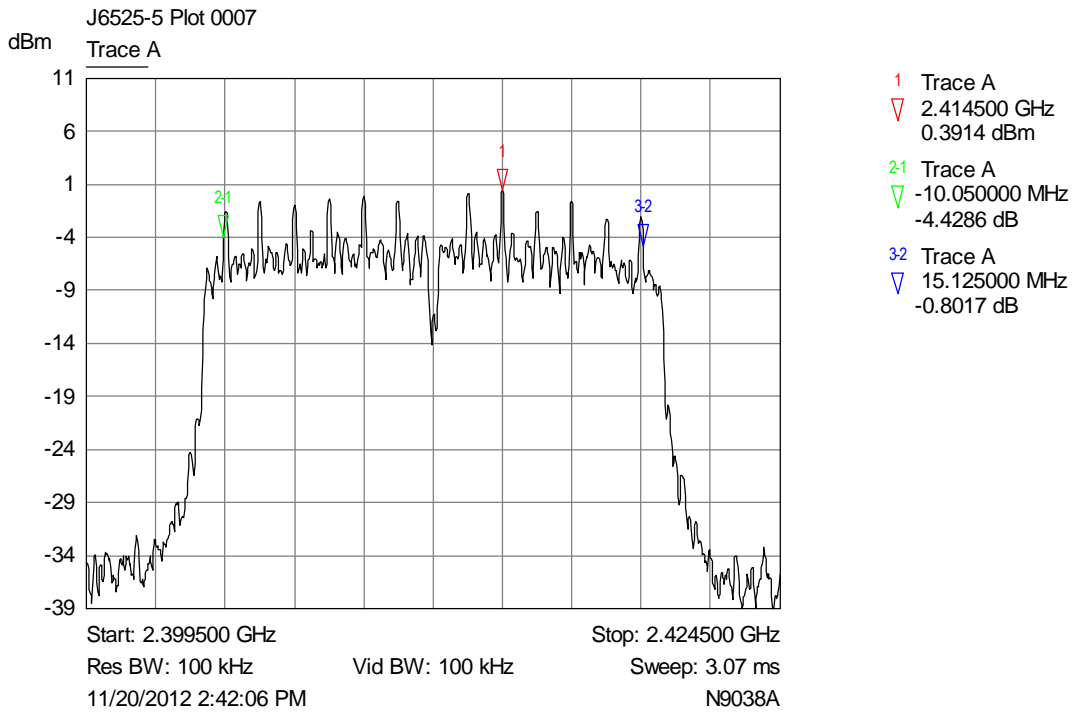

File name PURE.6525-5.DOCM

The contents of this report, apart from the referenced ANSI C63.4-2003, are beyond the scope of UKAS Testing Laboratory No. 2360 accreditation.

J6525-5 Plot 0009
dBm
Trace A

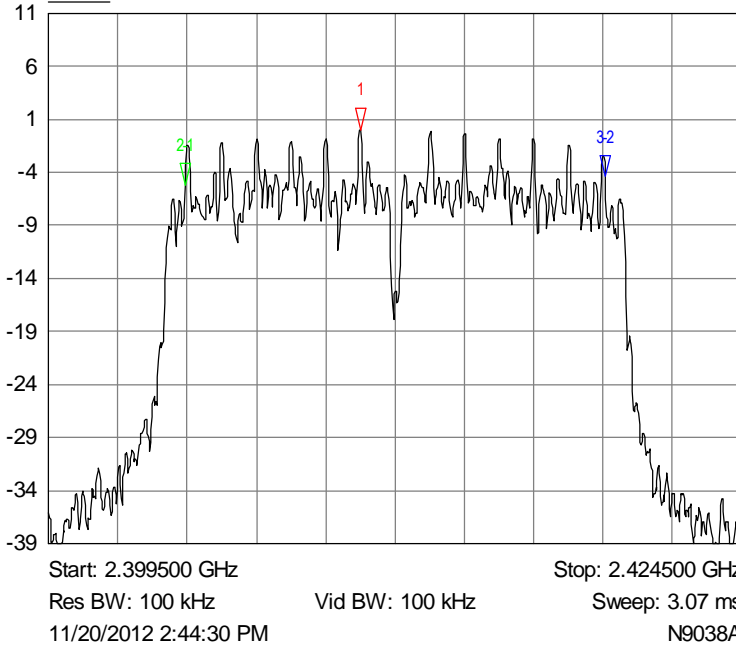

- 1 Trace A
▽ 2.410750 GHz
0.0330 dBm
- 21 Trace A
▽ -6.325000 MHz
-5.1899 dB
- 32 Trace A
▽ 15.150000 MHz
0.7743 dB

J6525-5 Plot 0010
dBm
Trace A

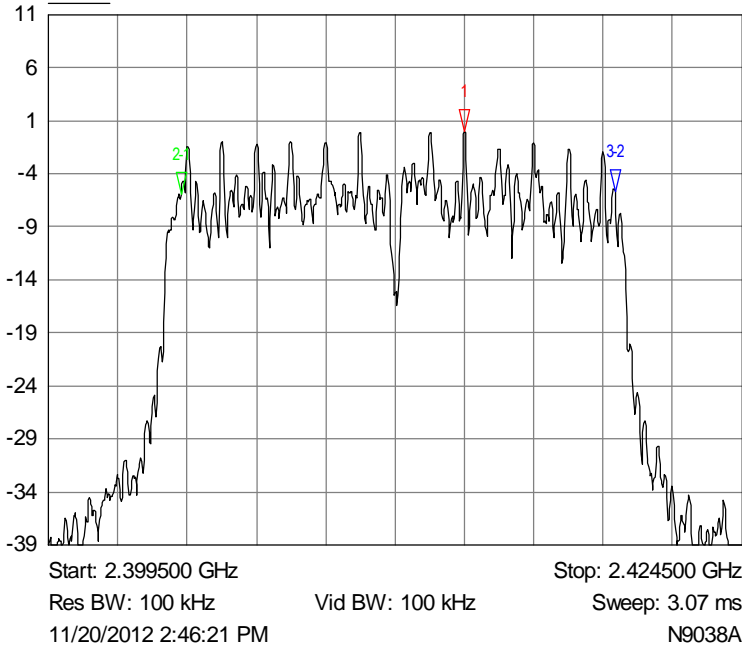

- 1 Trace A
▽ 2.414500 GHz
-0.0362 dBm
- 21 Trace A
▽ -10.225000 MHz
-5.8616 dB
- 32 Trace A
▽ 15.650000 MHz
0.2438 dB

File name PURE.6525-5.DOCM

The contents of this report, apart from the referenced ANSI C63.4-2003, are beyond the scope of UKAS Testing Laboratory No. 2360 accreditation.

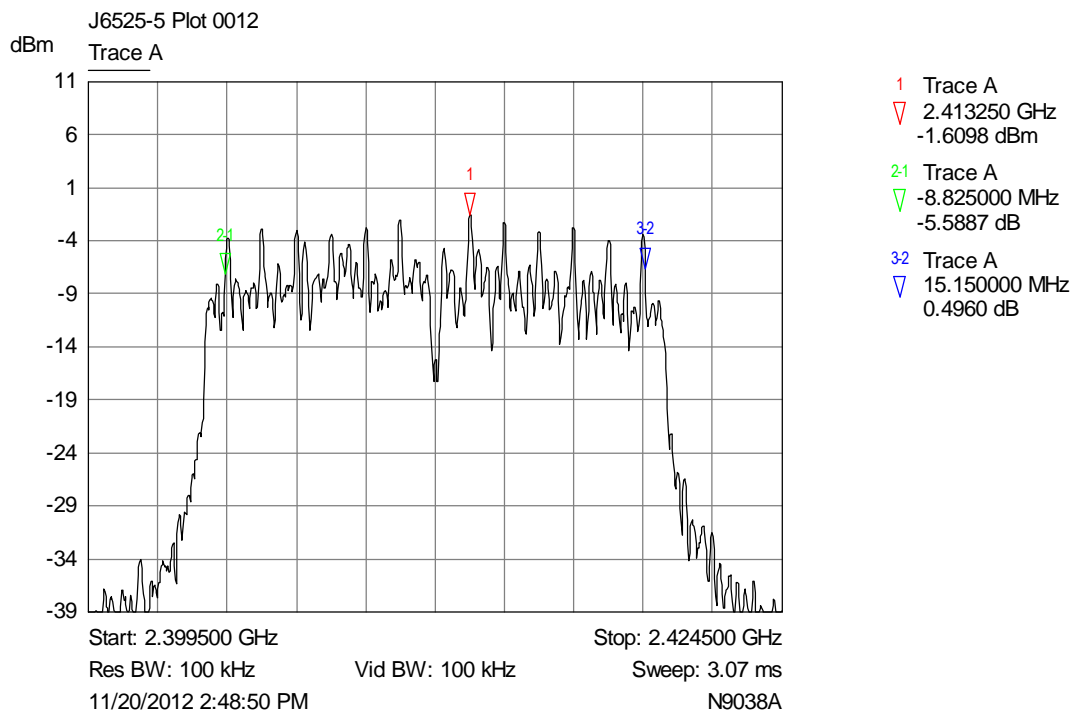
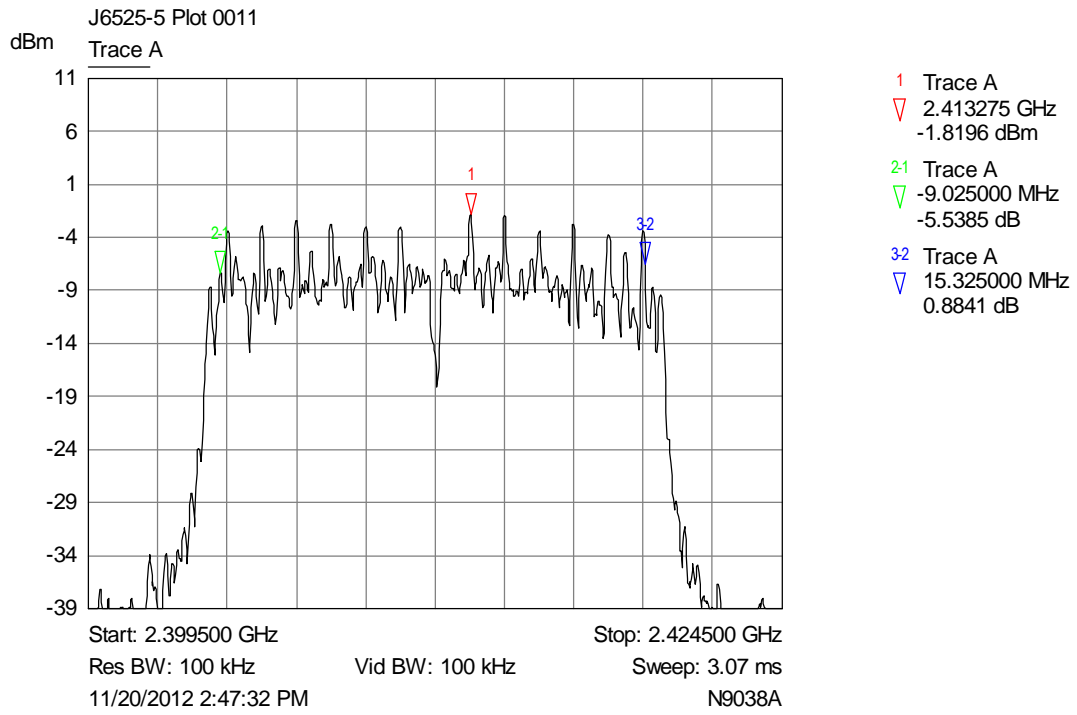

File name PURE.6525-5.DOCM

The contents of this report, apart from the referenced ANSI C63.4-2003, are beyond the scope of UKAS Testing Laboratory No. 2360 accreditation.

J6525-5 Plot 0013
dBm Trace A

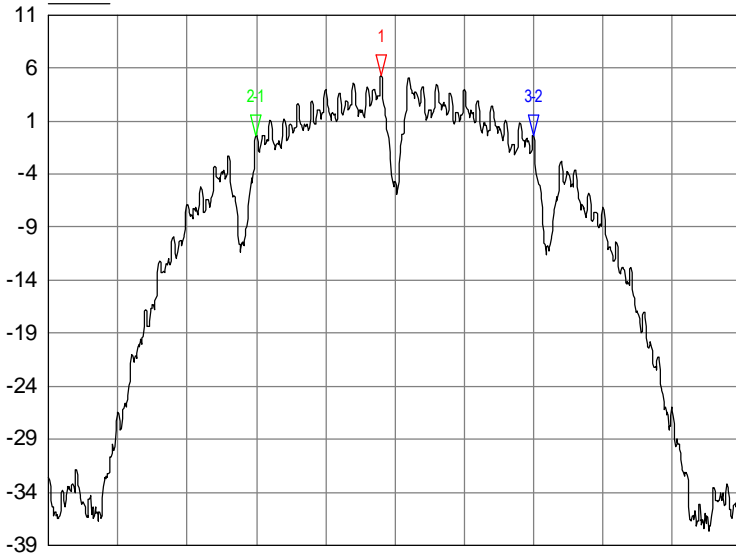

- 1 Trace A
2.436500 GHz
5.2136 dBm
- 2-1 Trace A
-4.525000 MHz
-5.6082 dB
- 3-2 Trace A
10.025000 MHz
-0.0598 dB

Start: 2.424500 GHz Stop: 2.449500 GHz
Res BW: 100 kHz Vid BW: 100 kHz Sweep: 3.07 ms
11/20/2012 2:51:20 PM N9038A

J6525-5 Plot 0014
dBm Trace A

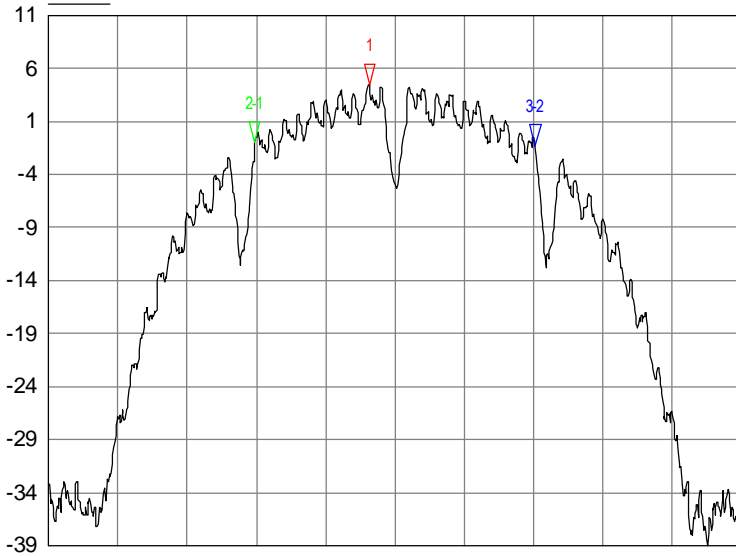

- 1 Trace A
2.436050 GHz
4.4364 dBm
- 2-1 Trace A
-4.100000 MHz
-5.4721 dB
- 3-2 Trace A
10.125000 MHz
-0.2758 dB

Start: 2.424500 GHz Stop: 2.449500 GHz
Res BW: 100 kHz Vid BW: 100 kHz Sweep: 3.07 ms
11/20/2012 2:53:01 PM N9038A

File name PURE.6525-5.DOCM

The contents of this report, apart from the referenced ANSI C63.4-2003, are beyond the scope of UKAS Testing Laboratory No. 2360 accreditation.

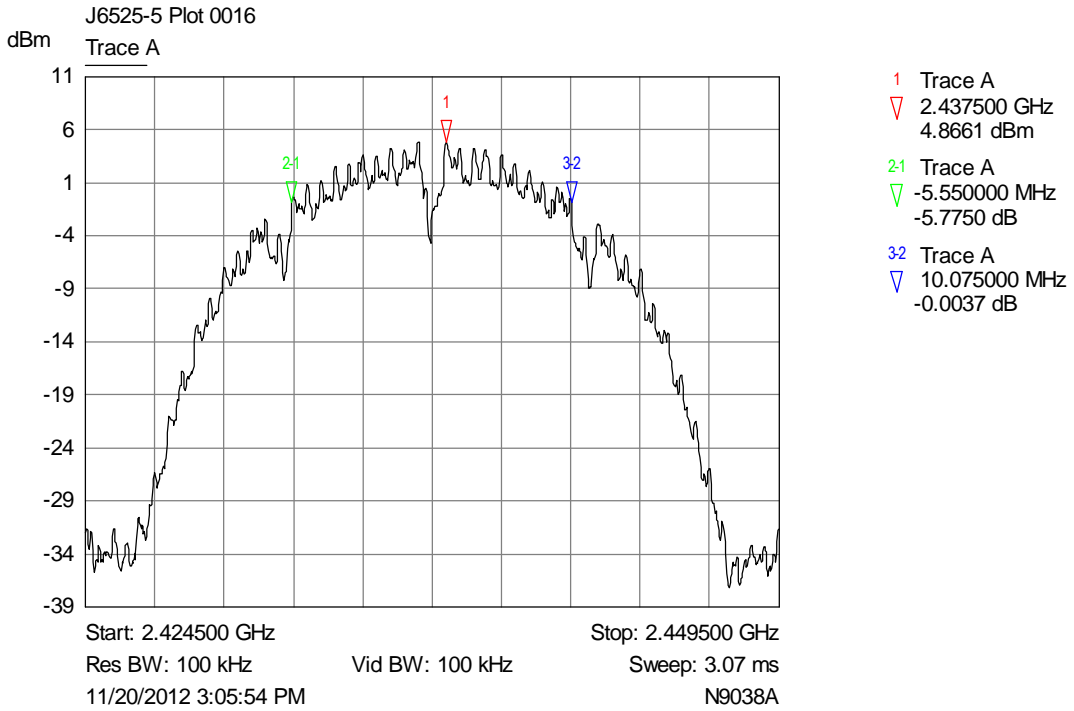
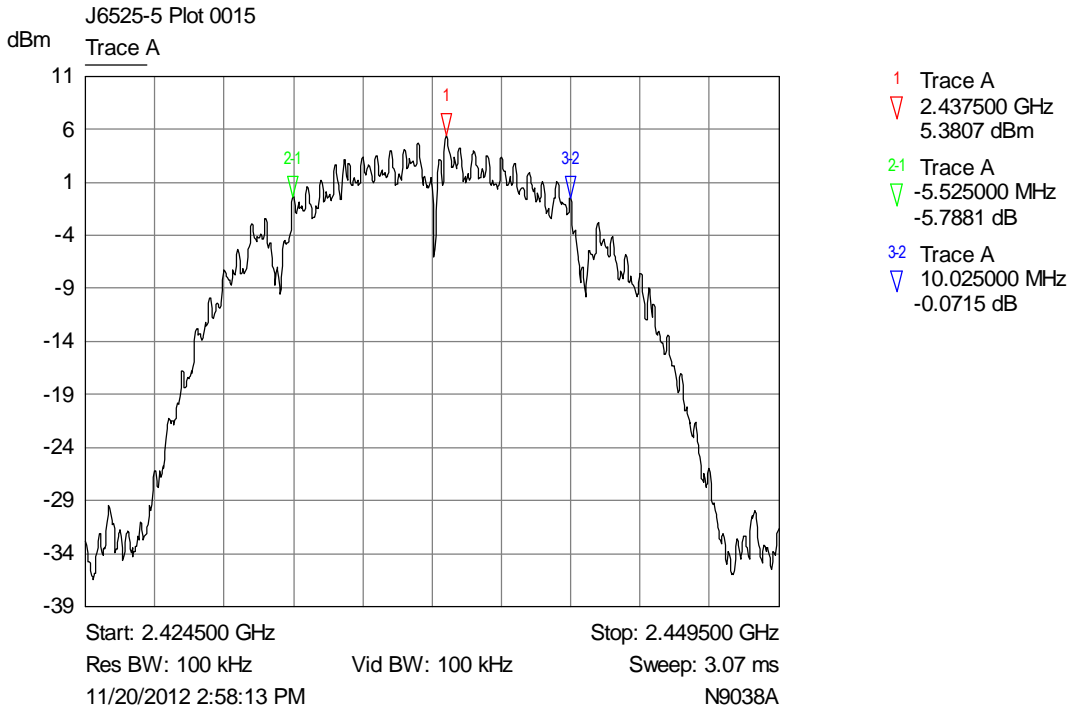

File name PURE.6525-5.DOCM

The contents of this report, apart from the referenced ANSI C63.4-2003, are beyond the scope of UKAS Testing Laboratory No. 2360 accreditation.

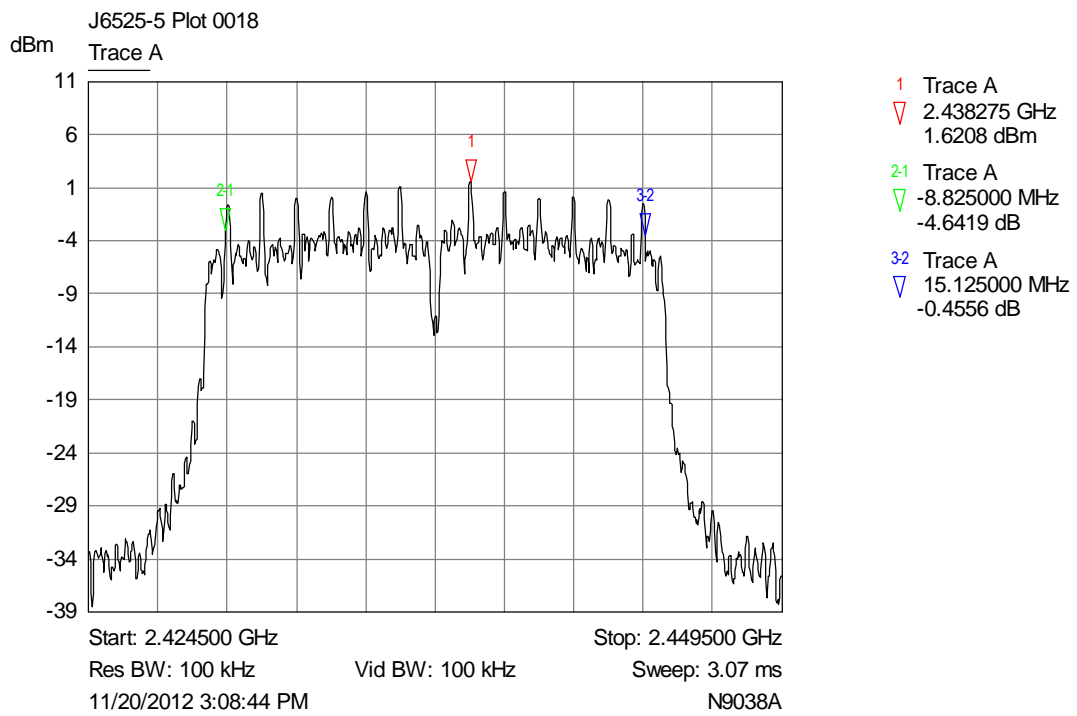
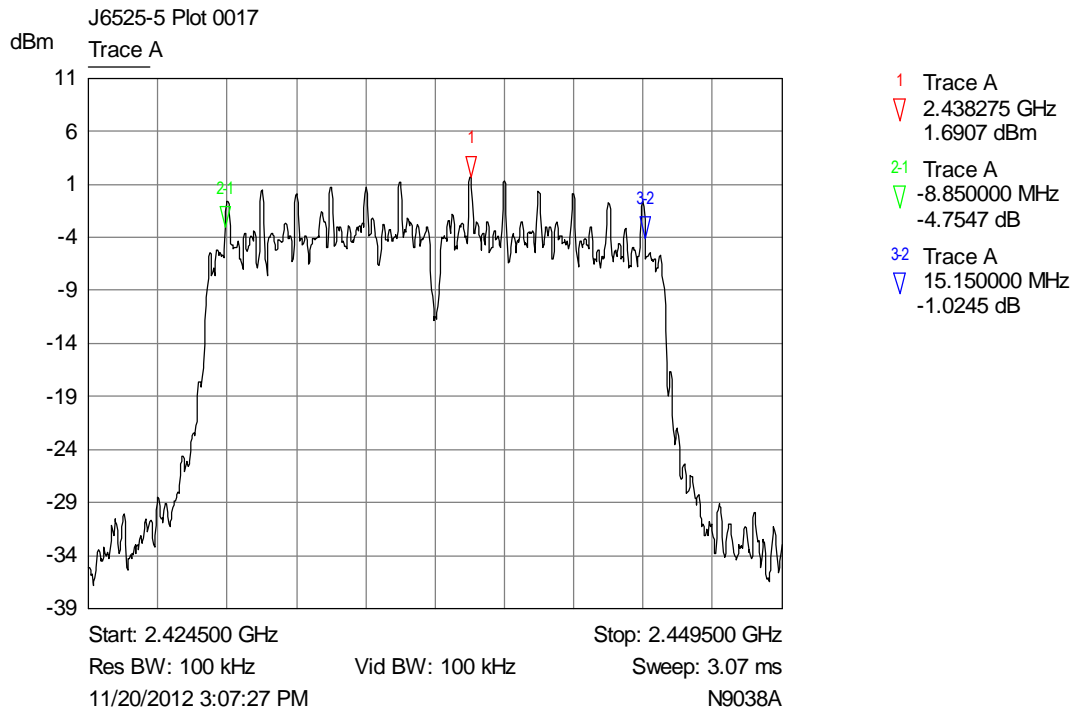

File name PURE.6525-5.DOCM

The contents of this report, apart from the referenced ANSI C63.4-2003, are beyond the scope of UKAS Testing Laboratory No. 2360 accreditation.

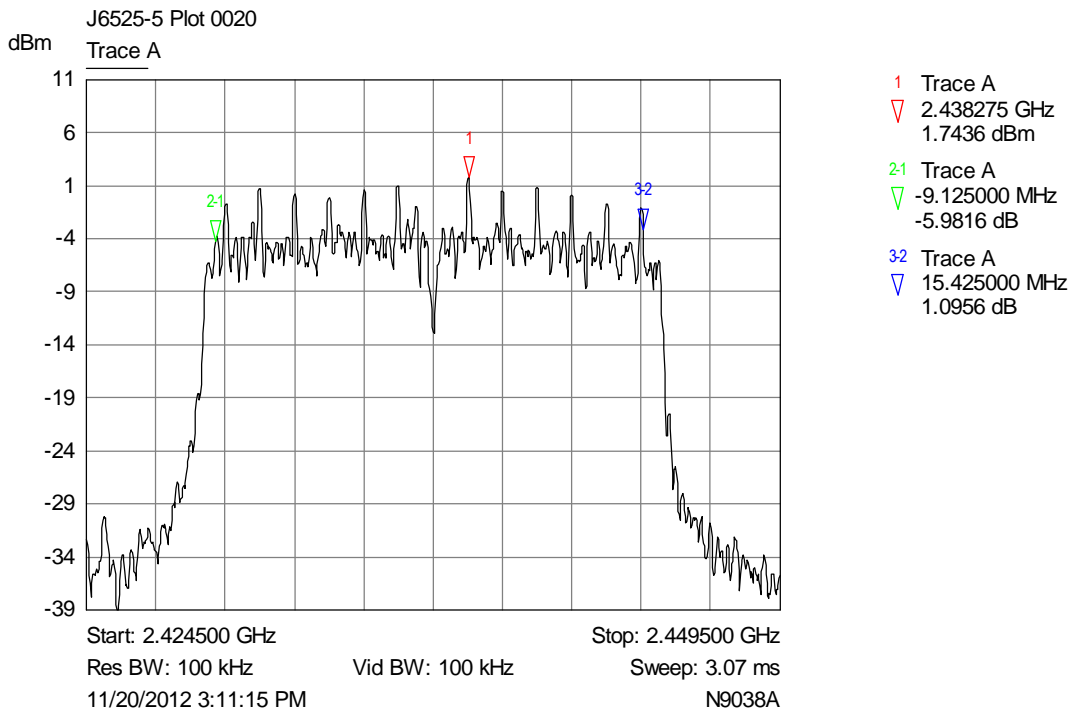
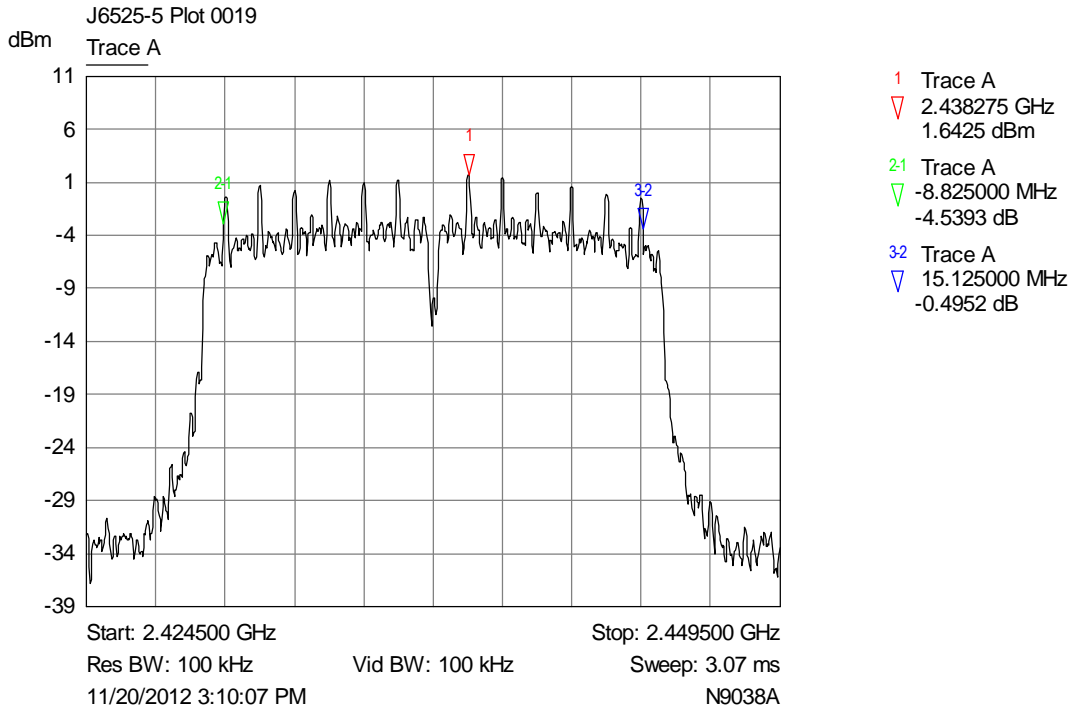

File name PURE.6525-5.DOCM

The contents of this report, apart from the referenced ANSI C63.4-2003, are beyond the scope of UKAS Testing Laboratory No. 2360 accreditation.

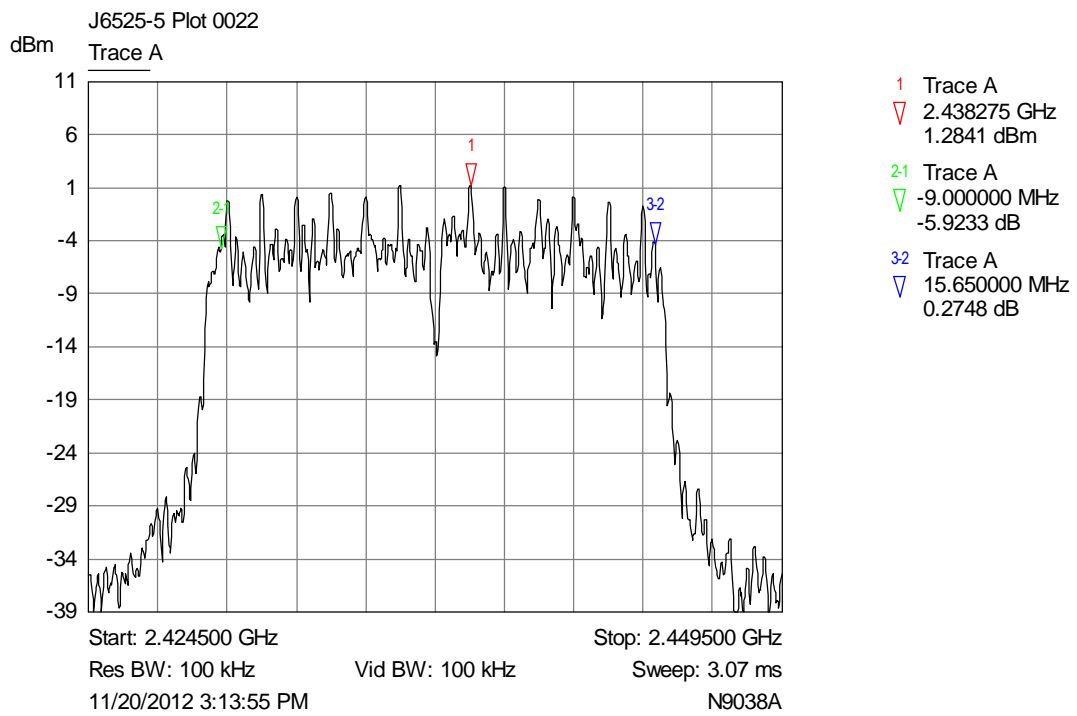
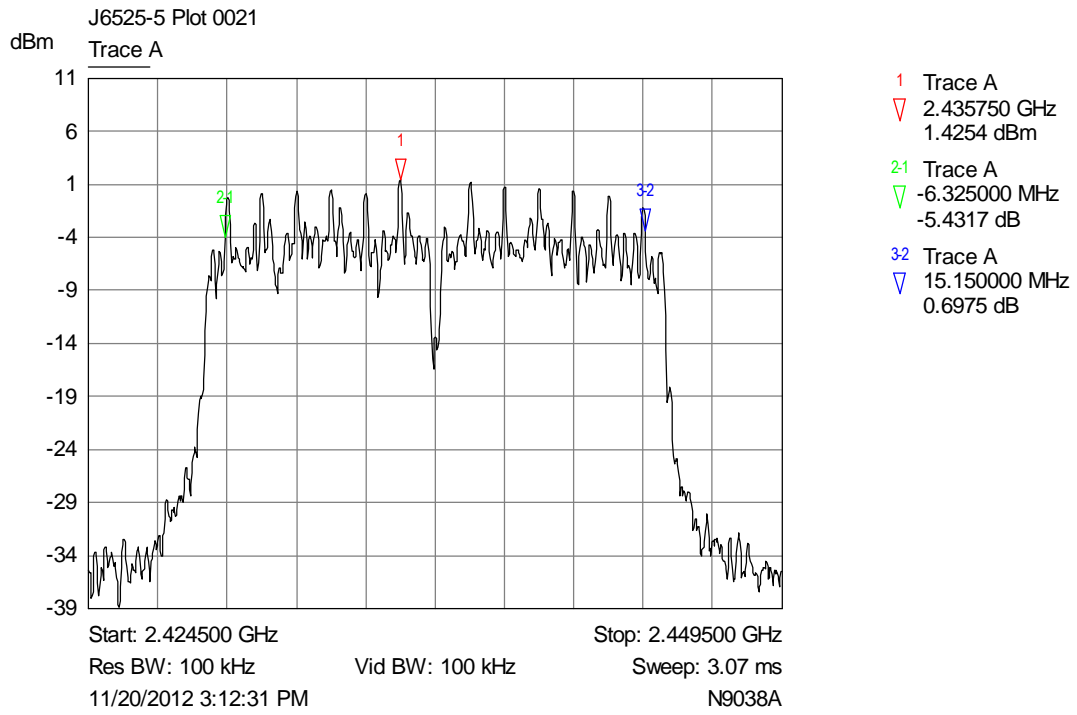

File name PURE.6525-5.DOCM

The contents of this report, apart from the referenced ANSI C63.4-2003, are beyond the scope of UKAS Testing Laboratory No. 2360 accreditation.

J6525-5 Plot 0023
 dBm Trace A

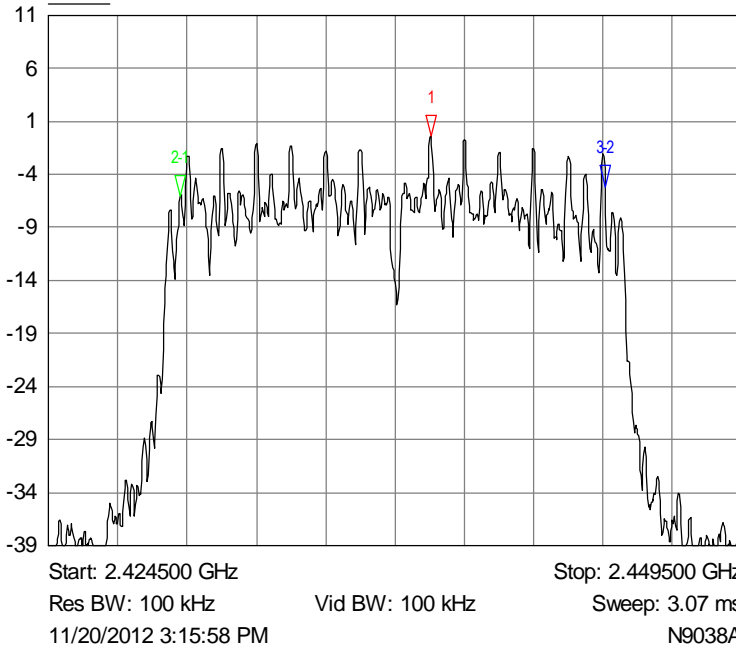

- 1 Trace A
 ▽ 2.438275 GHz
 -0.4091 dBm
- 2-1 Trace A
 ▽ -9.025000 MHz
 -5.6366 dB
- 3-2 Trace A
 ▽ 15.325000 MHz
 0.8501 dB

J6525-5 Plot 0024
 dBm Trace A

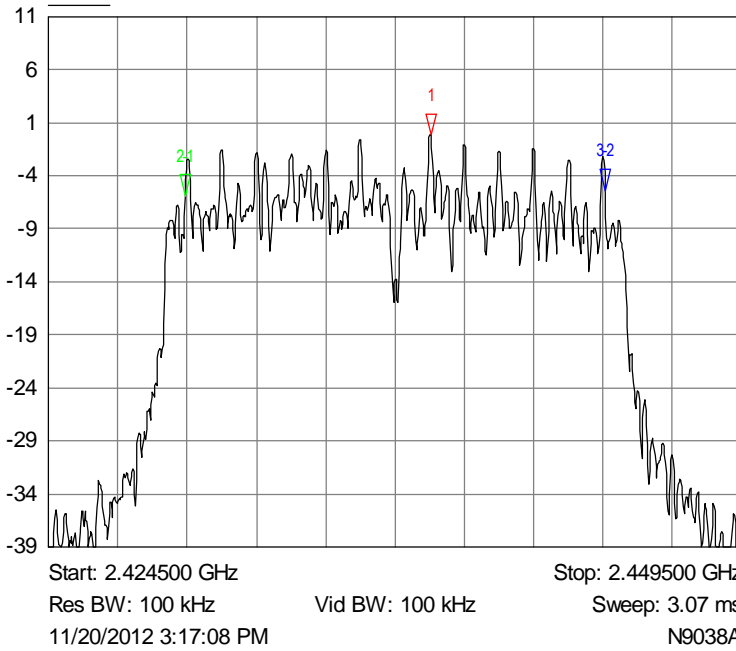

- 1 Trace A
 ▽ 2.438275 GHz
 -0.1899 dBm
- 2-1 Trace A
 ▽ -8.850000 MHz
 -5.7678 dB
- 3-2 Trace A
 ▽ 15.150000 MHz
 0.5498 dB

File name PURE.6525-5.DOCM

The contents of this report, apart from the referenced ANSI C63.4-2003, are beyond the scope of UKAS Testing Laboratory No. 2360 accreditation.

J6525-5 Plot 0025
Trace A

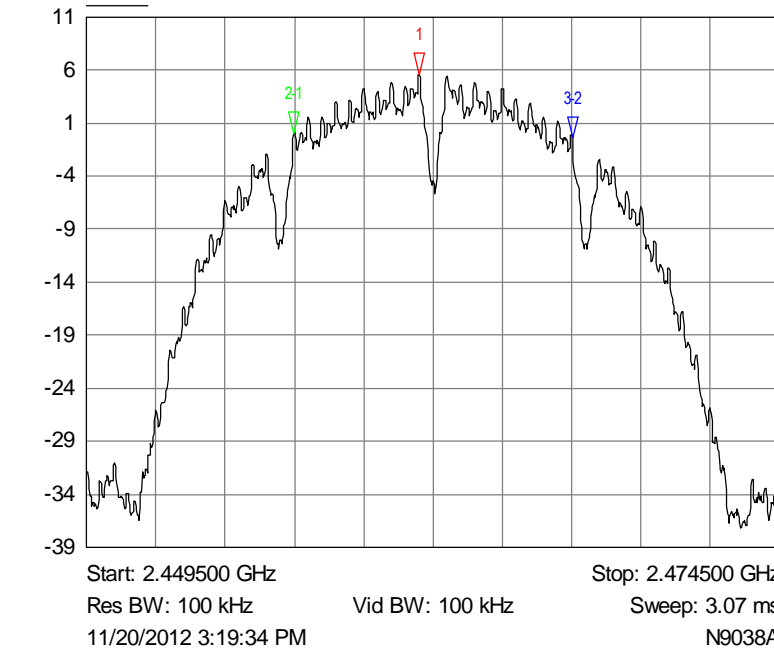

- 1 Trace A
2.461500 GHz
5.5846 dBm
- 2-1 Trace A
-4.525000 MHz
-5.5893 dB
- 3-2 Trace A
10.050000 MHz
-0.4142 dB

J6525-5 Plot 0026
Trace A

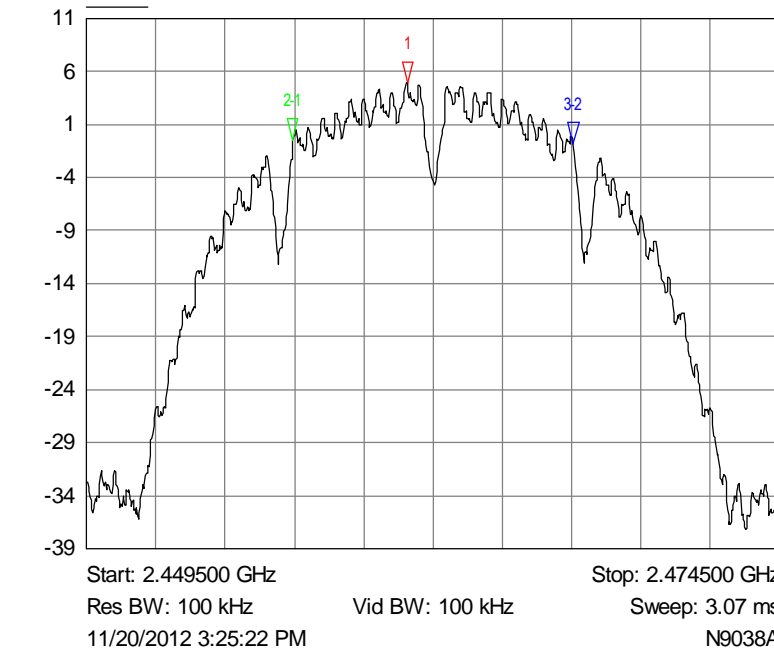

- 1 Trace A
2.461050 GHz
4.9541 dBm
- 2-1 Trace A
-4.100000 MHz
-5.4843 dB
- 3-2 Trace A
10.125000 MHz
-0.3158 dB

File name PURE.6525-5.DOCM

The contents of this report, apart from the referenced ANSI C63.4-2003, are beyond the scope of UKAS Testing Laboratory No. 2360 accreditation.

J6525-5 Plot 0027
dBm Trace A

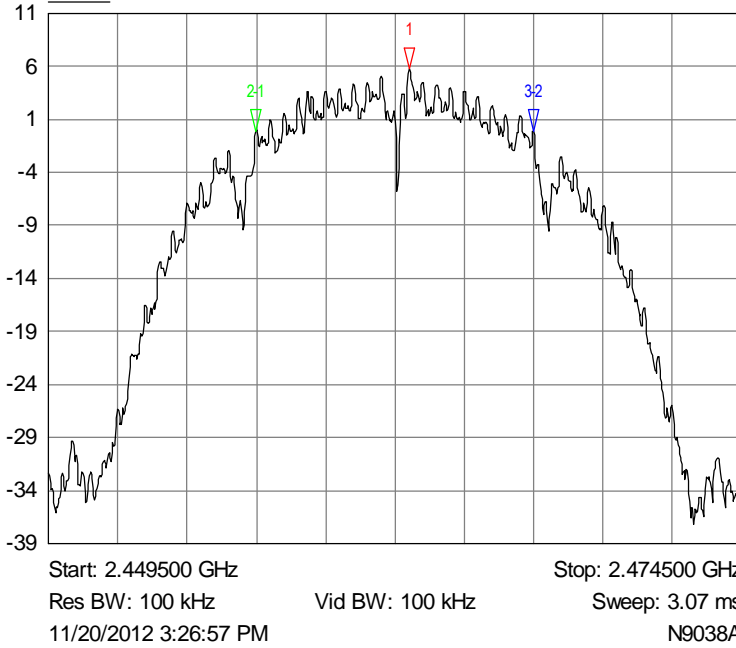

- 1 Trace A
2.462525 GHz
5.7403 dBm
- 21 Trace A
-5.550000 MHz
-5.8479 dB
- 32 Trace A
10.025000 MHz
-0.0138 dB

J6525-5 Plot 0028
dBm Trace A

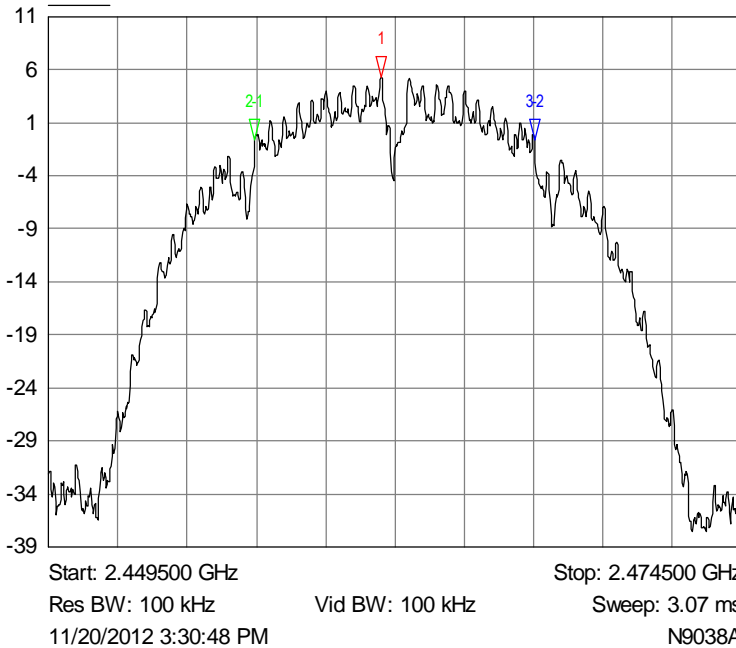

- 1 Trace A
2.461500 GHz
5.2407 dBm
- 21 Trace A
-4.550000 MHz
-5.9274 dB
- 32 Trace A
10.075000 MHz
0.0482 dB

File name PURE.6525-5.DOCM

The contents of this report, apart from the referenced ANSI C63.4-2003, are beyond the scope of UKAS Testing Laboratory No. 2360 accreditation.

J6525-5 Plot 0029
dBm Trace A

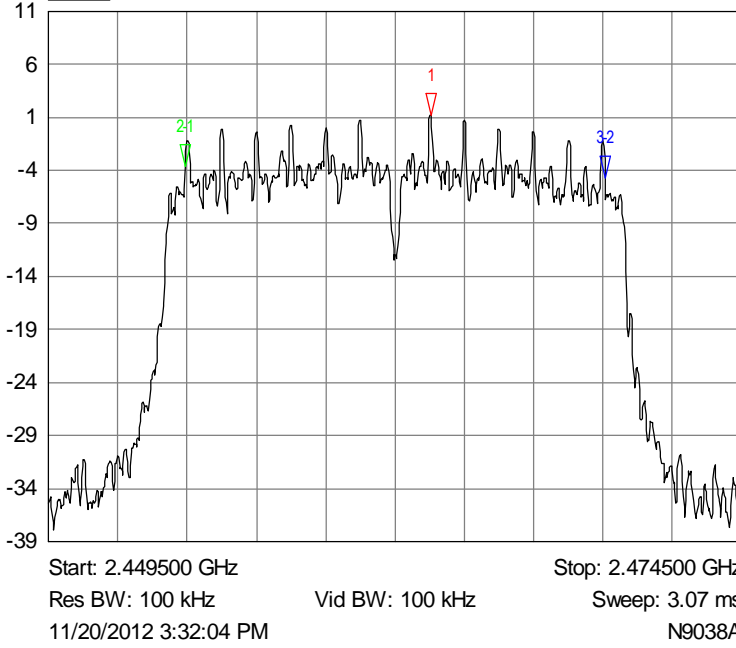

- 1 Trace A
2.463275 GHz
1.2258 dBm
- 2-1 Trace A
-8.850000 MHz
-4.8369 dB
- 3-2 Trace A
15.150000 MHz
-1.0874 dB

J6525-5 Plot 0030
dBm Trace A

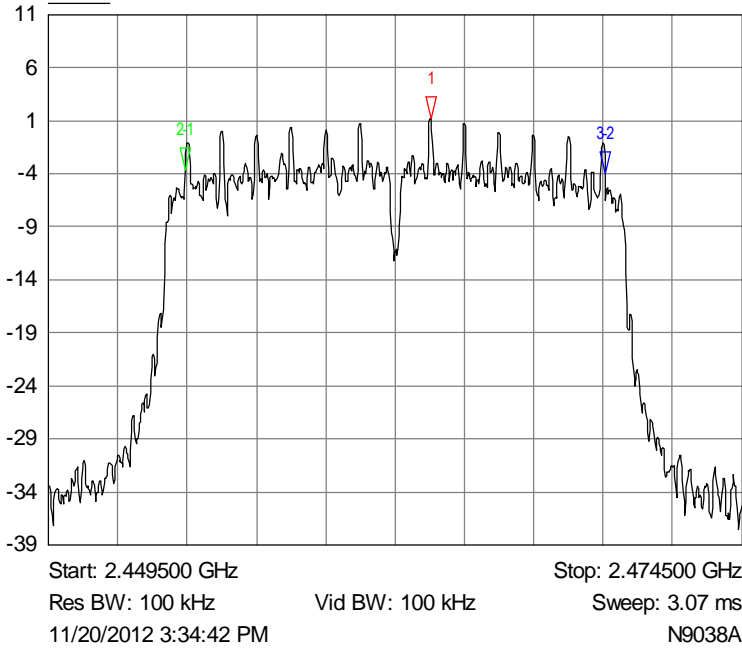

- 1 Trace A
2.463275 GHz
1.2771 dBm
- 2-1 Trace A
-8.850000 MHz
-4.8206 dB
- 3-2 Trace A
15.150000 MHz
-0.4615 dB

File name PURE.6525-5.DOCM

The contents of this report, apart from the referenced ANSI C63.4-2003, are beyond the scope of UKAS Testing Laboratory No. 2360 accreditation.

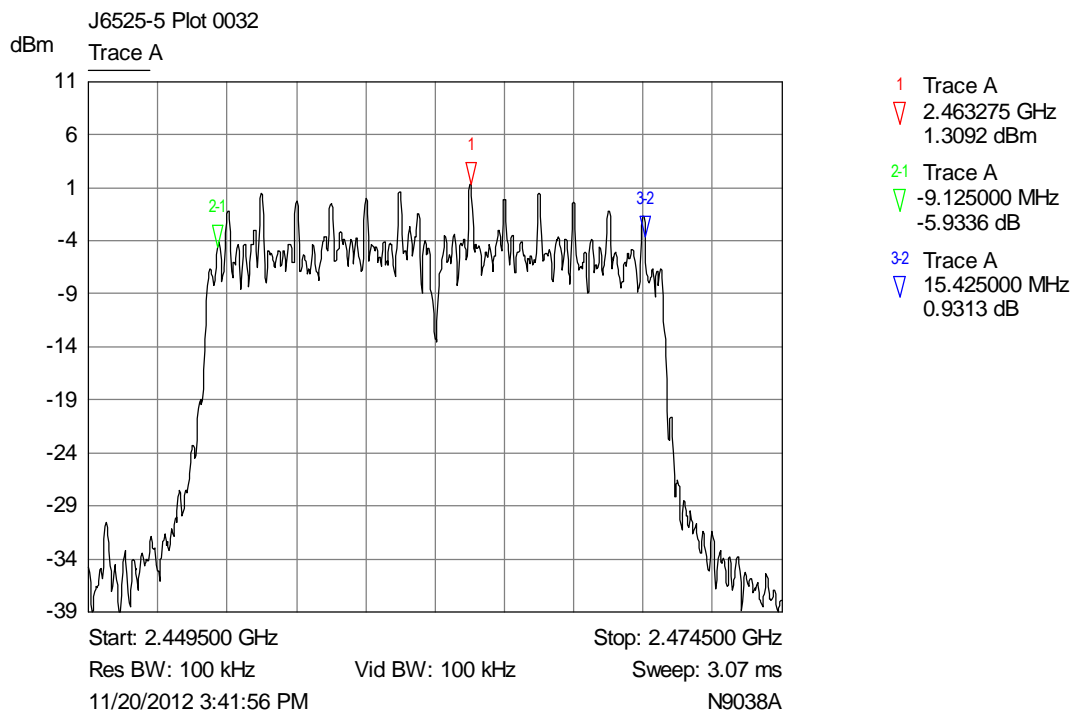
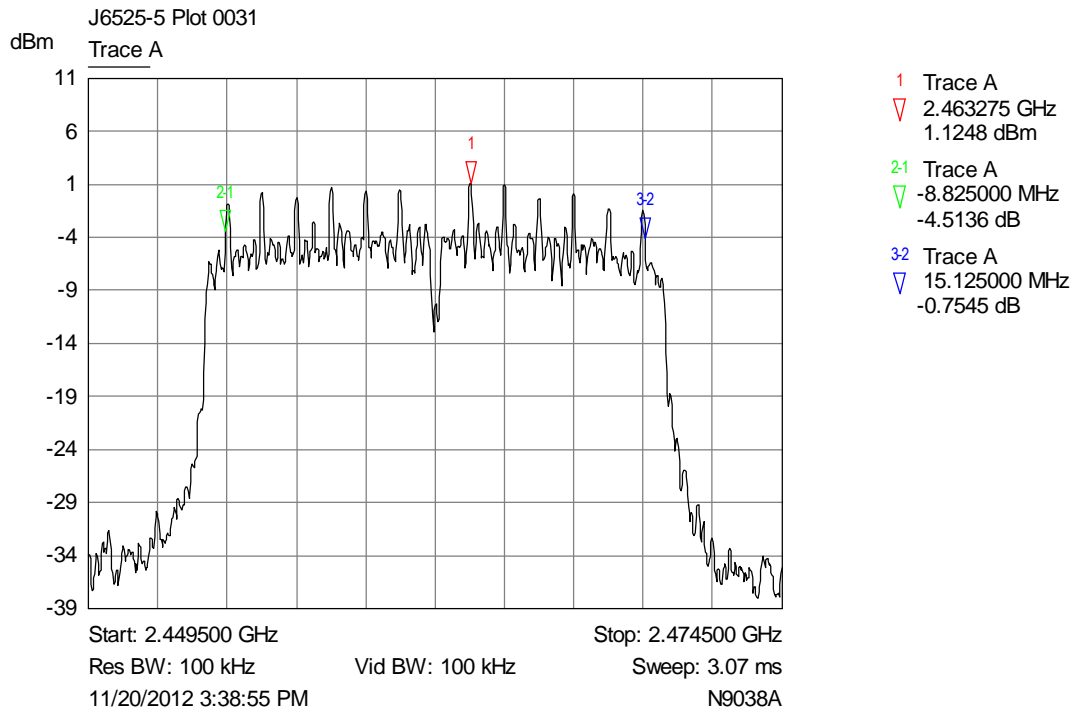

File name PURE.6525-5.DOCM

The contents of this report, apart from the referenced ANSI C63.4-2003, are beyond the scope of UKAS Testing Laboratory No. 2360 accreditation.

J6525-5 Plot 0033
Trace A

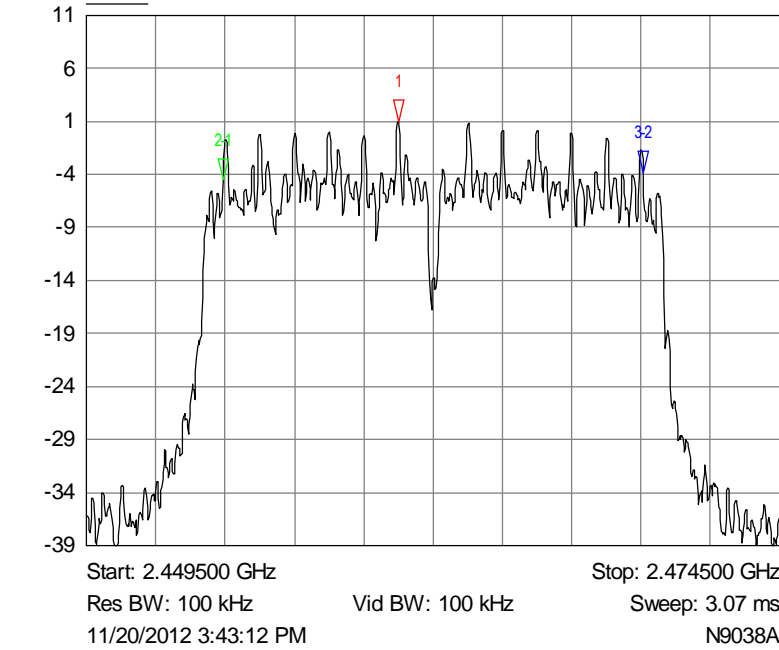

- 1 Trace A
2.460750 GHz
0.9829 dBm
- 2-1 Trace A
-6.325000 MHz
-5.5151 dB
- 3-2 Trace A
15.150000 MHz
0.6837 dB

J6525-5 Plot 0034
Trace A

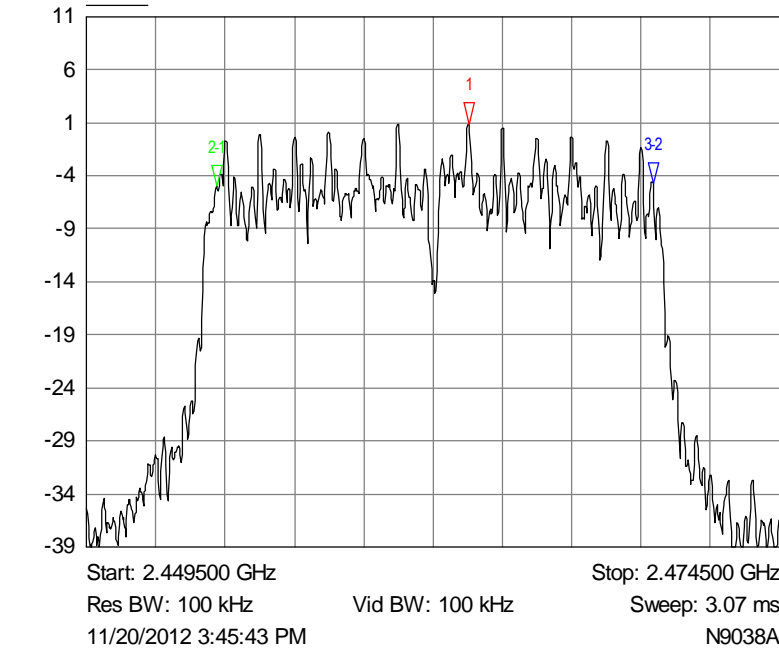

- 1 Trace A
2.463275 GHz
0.8723 dBm
- 2-1 Trace A
-9.100000 MHz
-5.8777 dB
- 3-2 Trace A
15.750000 MHz
0.2256 dB

File name PURE.6525-5.DOCM

The contents of this report, apart from the referenced ANSI C63.4-2003, are beyond the scope of UKAS Testing Laboratory No. 2360 accreditation.

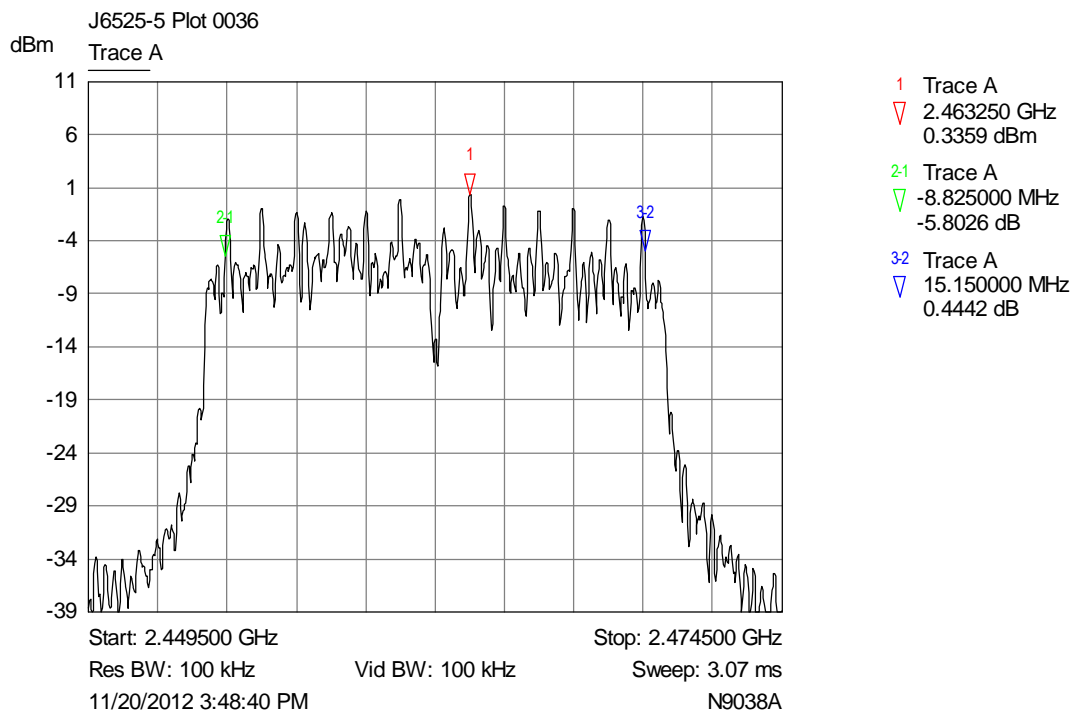
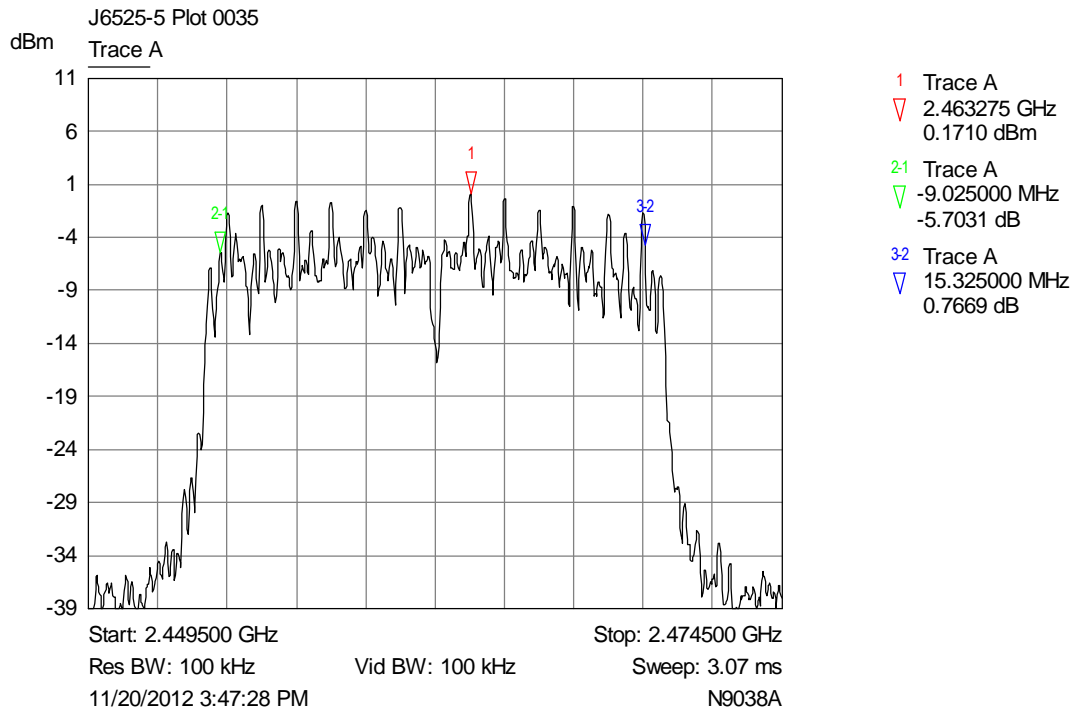

File name PURE.6525-5.DOCM

The contents of this report, apart from the referenced ANSI C63.4-2003, are beyond the scope of UKAS Testing Laboratory No. 2360 accreditation.

6.5 Band Edge Compliance

Band Edge & Restricted band edge.

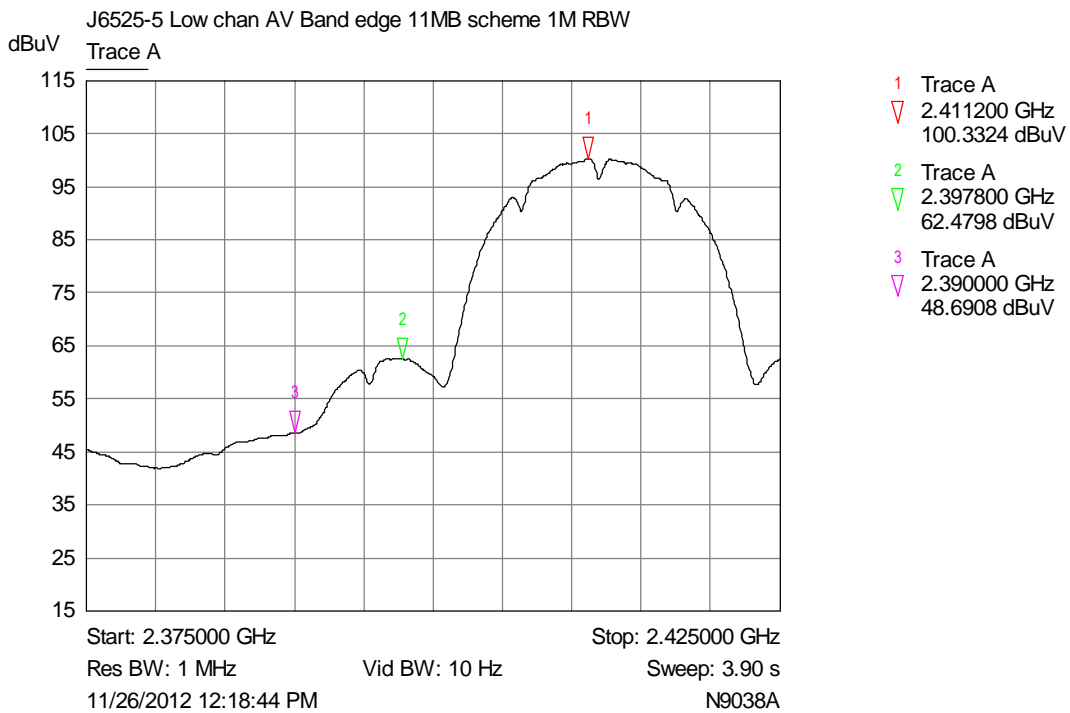
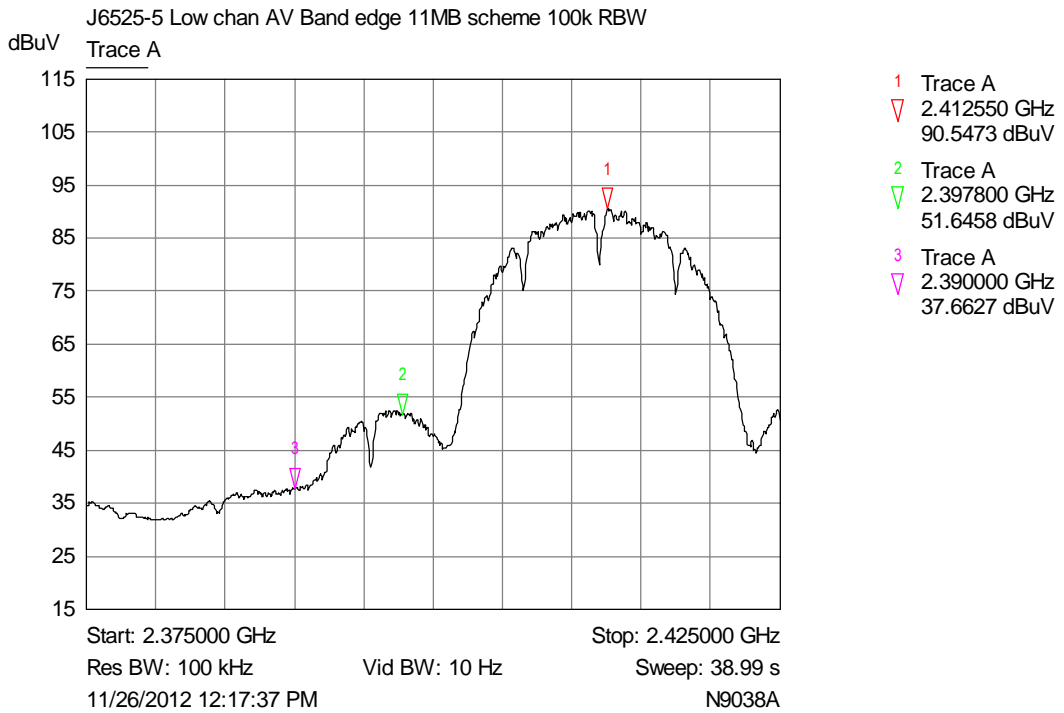

File name PURE.6525-5.DOCM

The contents of this report, apart from the referenced ANSI C63.4-2003, are beyond the scope of UKAS Testing Laboratory No. 2360 accreditation.

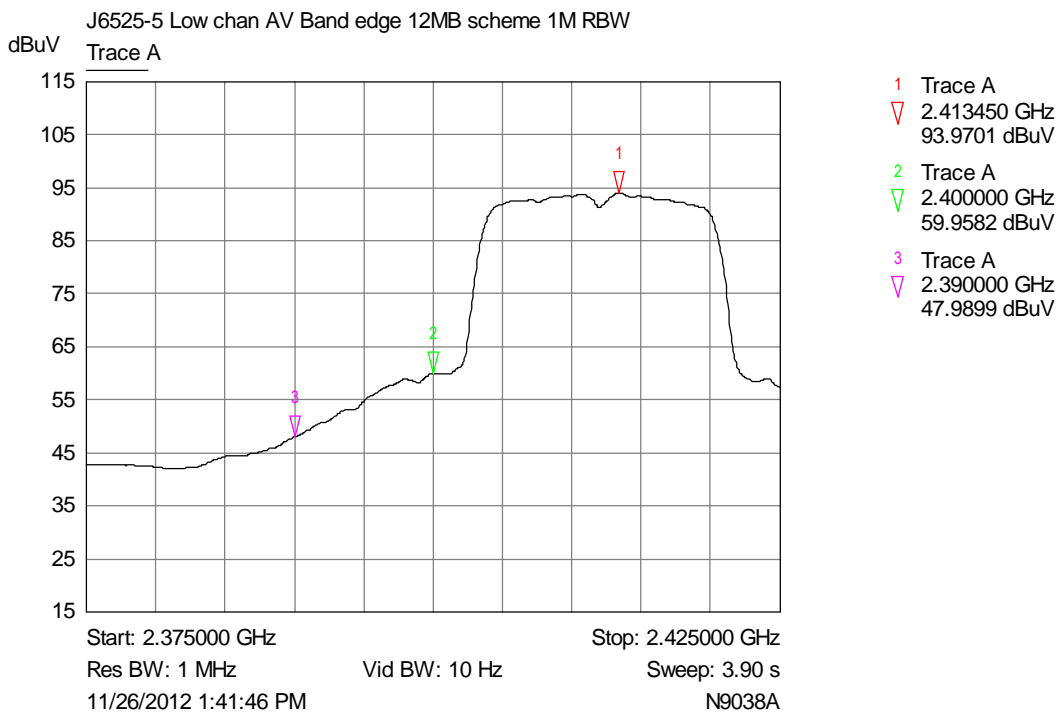
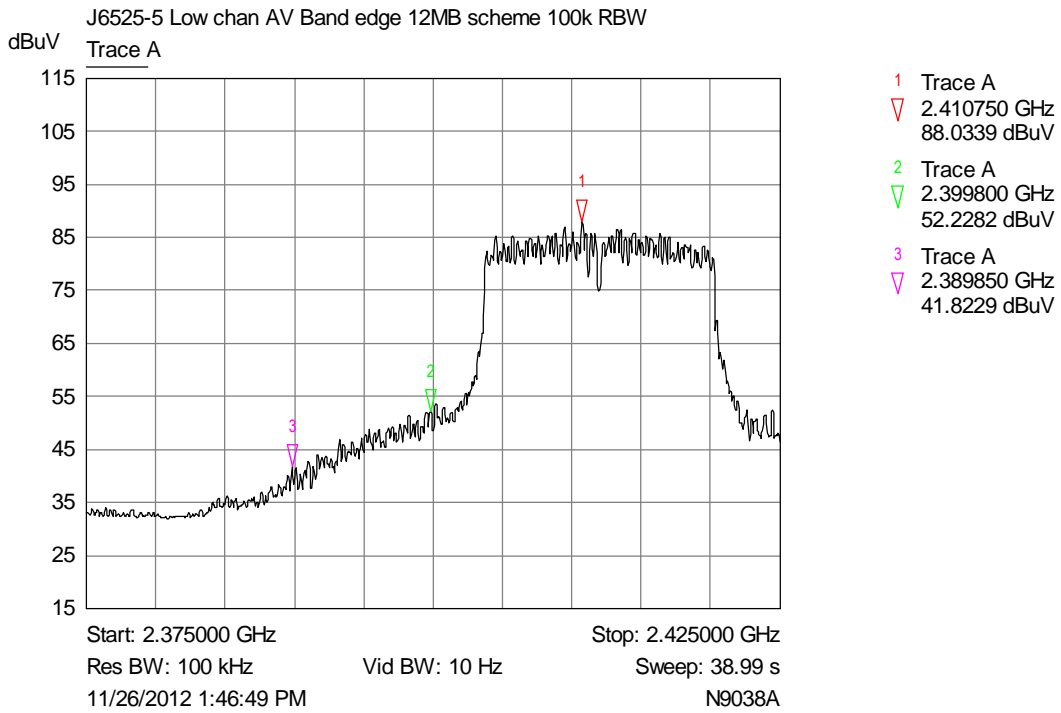

File name PURE.6525-5.DOCM

The contents of this report, apart from the referenced ANSI C63.4-2003, are beyond the scope of UKAS Testing Laboratory No. 2360 accreditation.

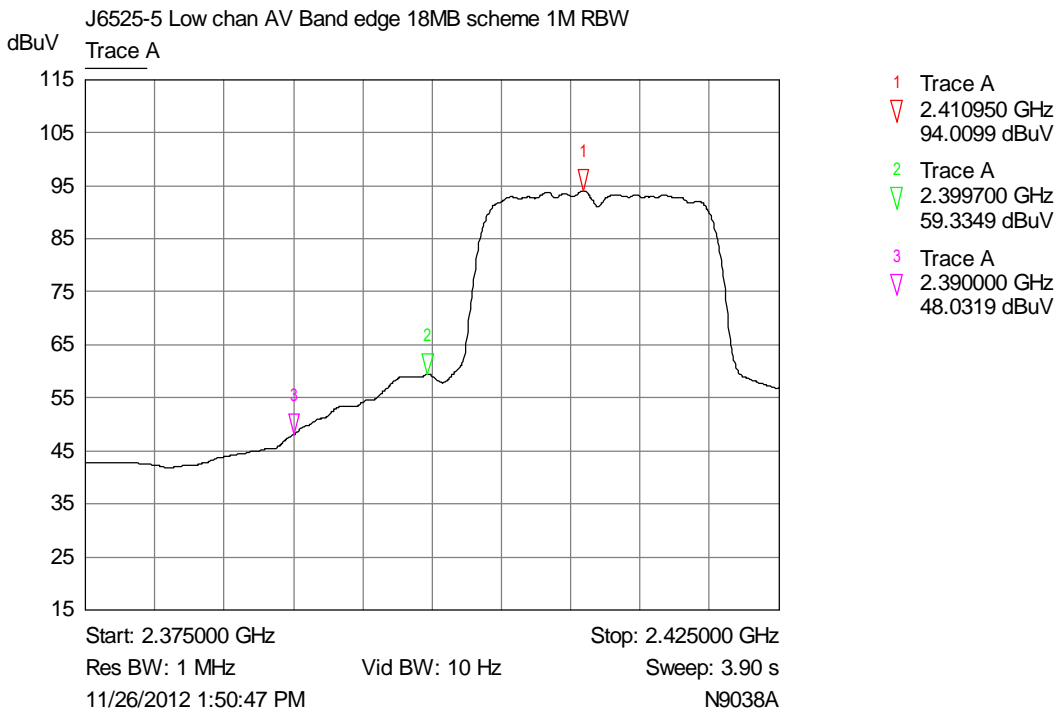
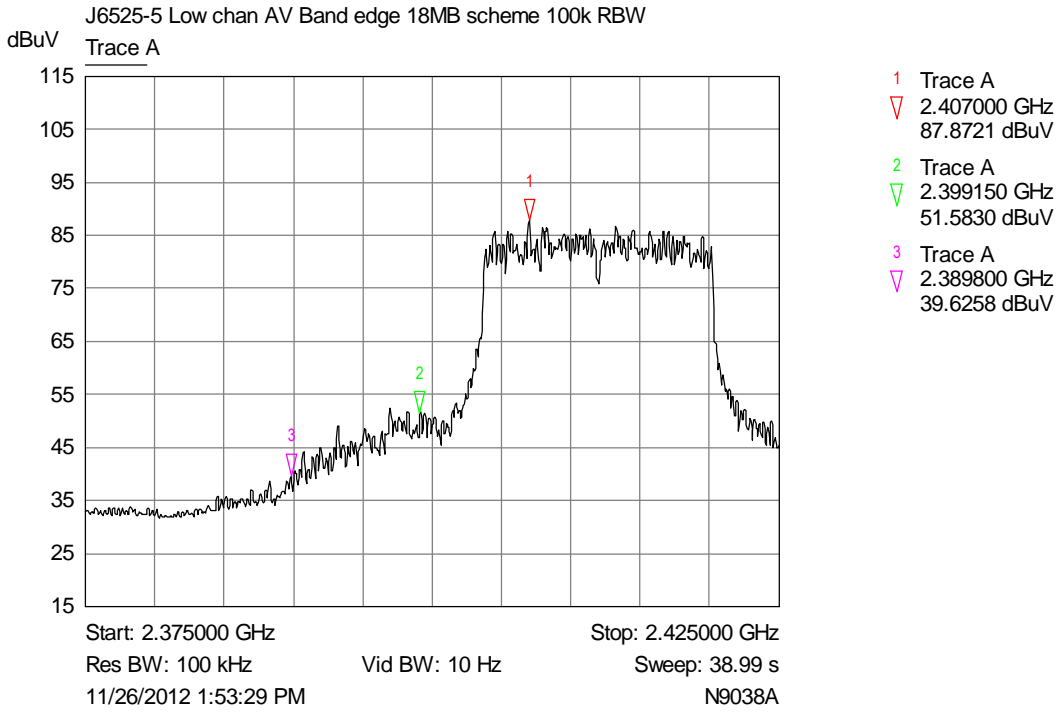

File name PURE.6525-5.DOCM

The contents of this report, apart from the referenced ANSI C63.4-2003, are beyond the scope of UKAS Testing Laboratory No. 2360 accreditation.

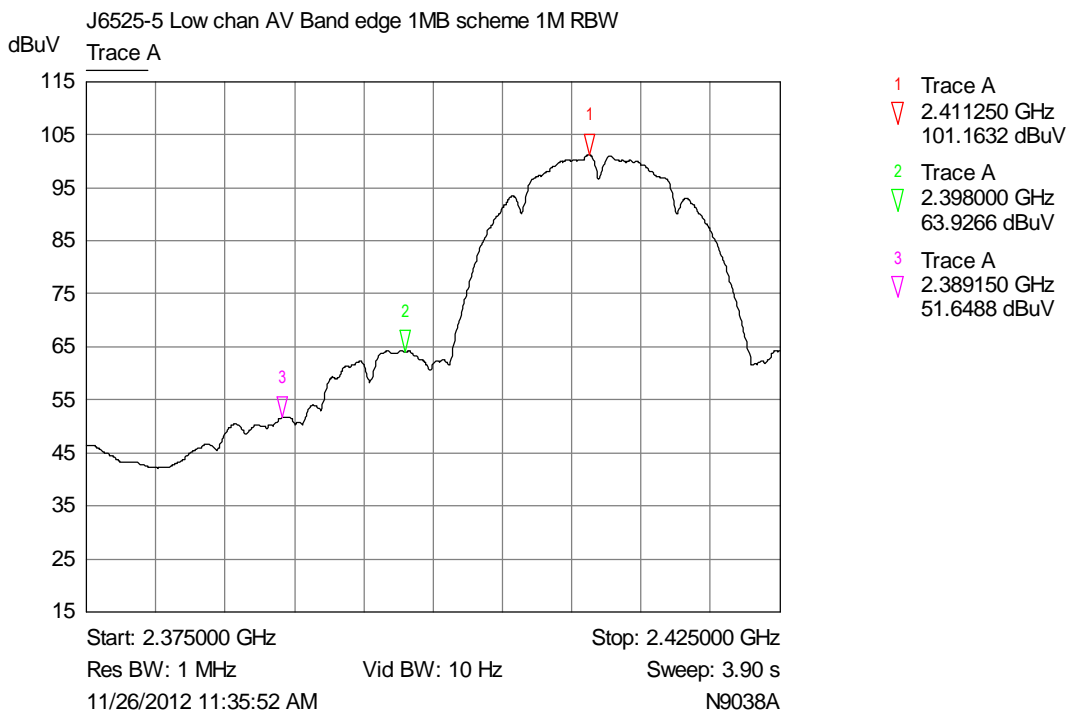
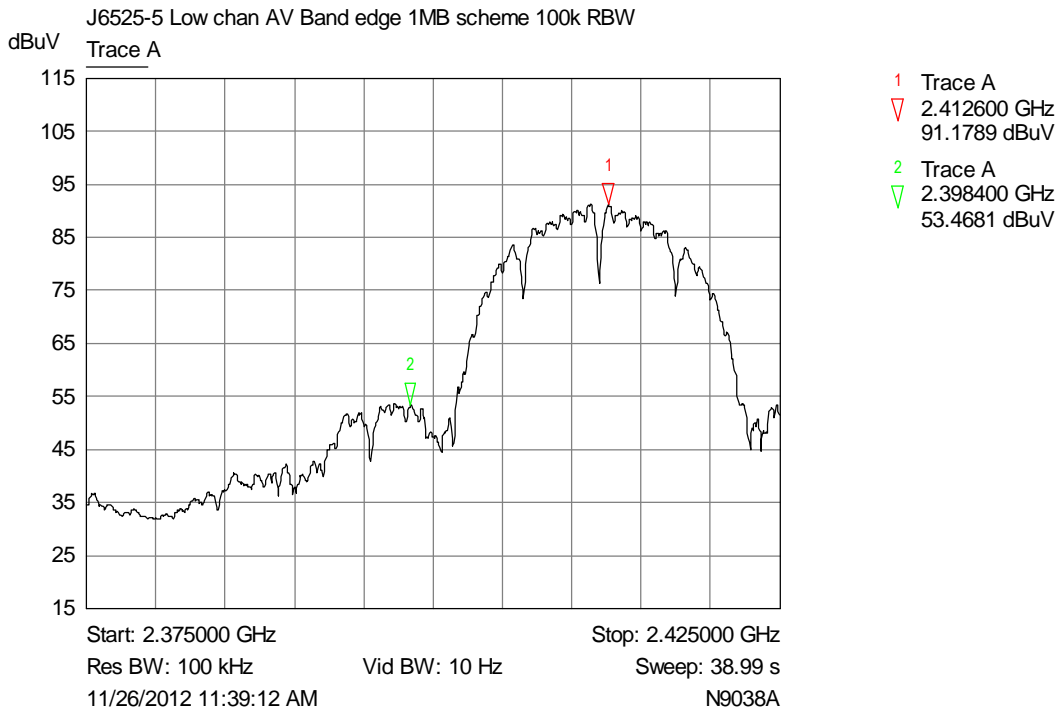

File name PURE.6525-5.DOCM

The contents of this report, apart from the referenced ANSI C63.4-2003, are beyond the scope of UKAS Testing Laboratory No. 2360 accreditation.

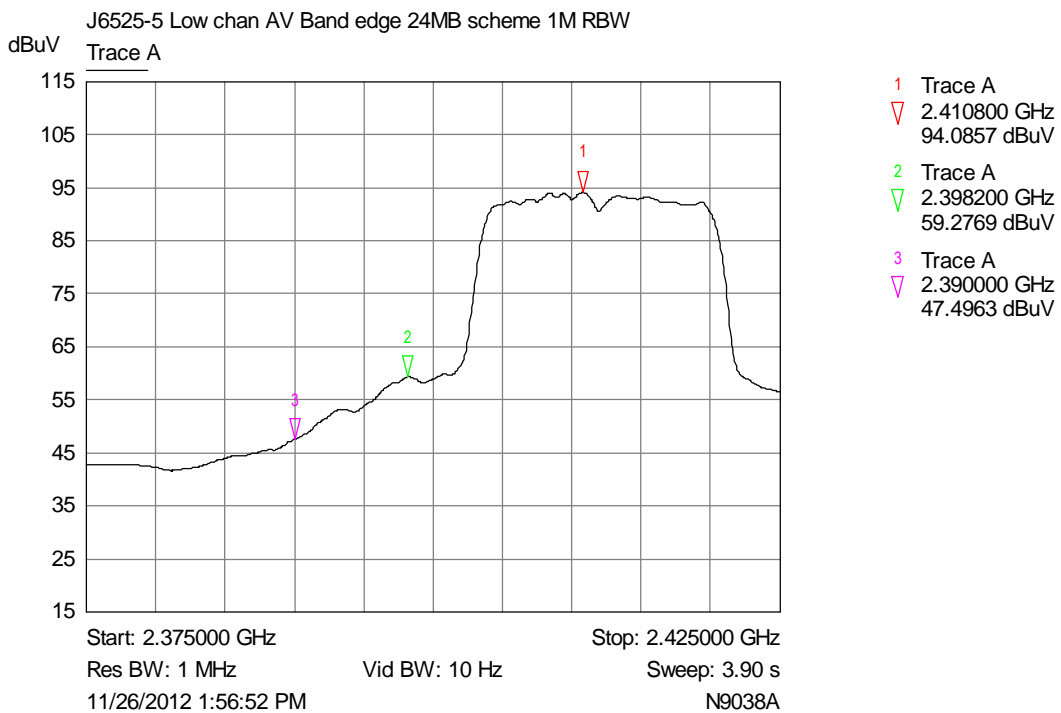
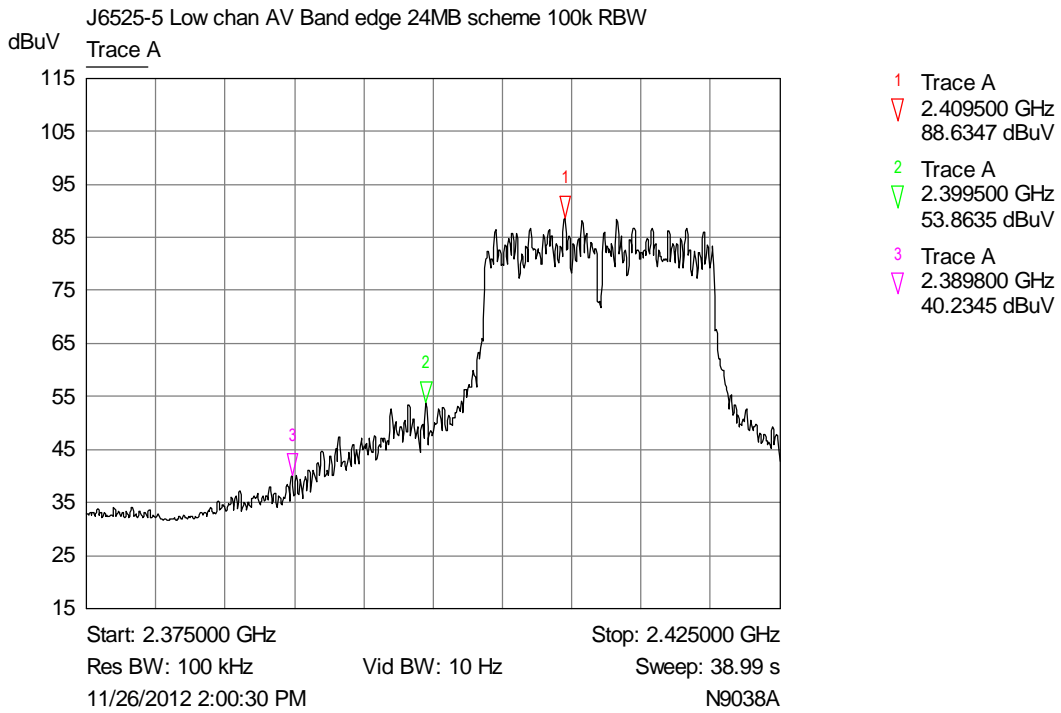

File name PURE.6525-5.DOCM

The contents of this report, apart from the referenced ANSI C63.4-2003, are beyond the scope of UKAS Testing Laboratory No. 2360 accreditation.

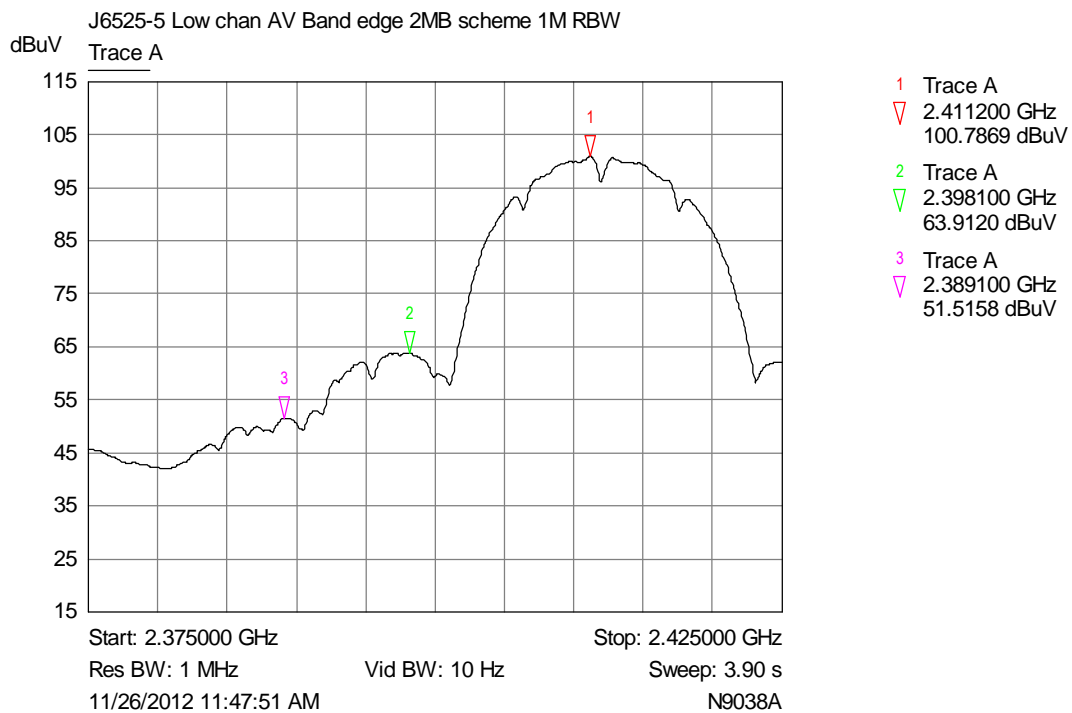
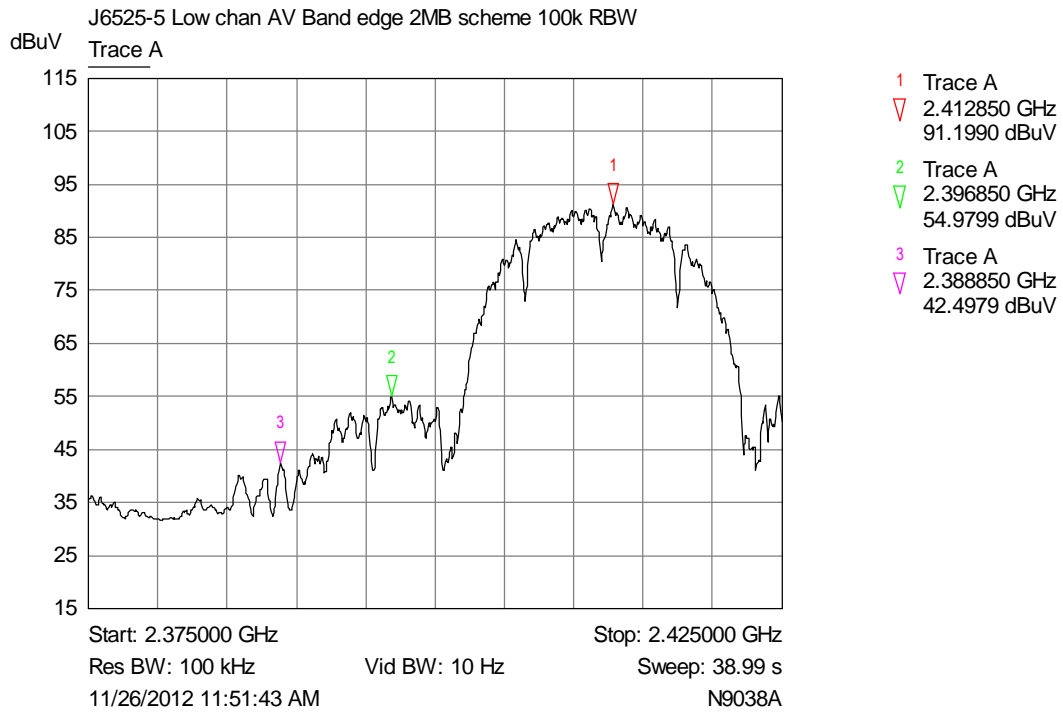

File name PURE.6525-5.DOCM

The contents of this report, apart from the referenced ANSI C63.4-2003, are beyond the scope of UKAS Testing Laboratory No. 2360 accreditation.

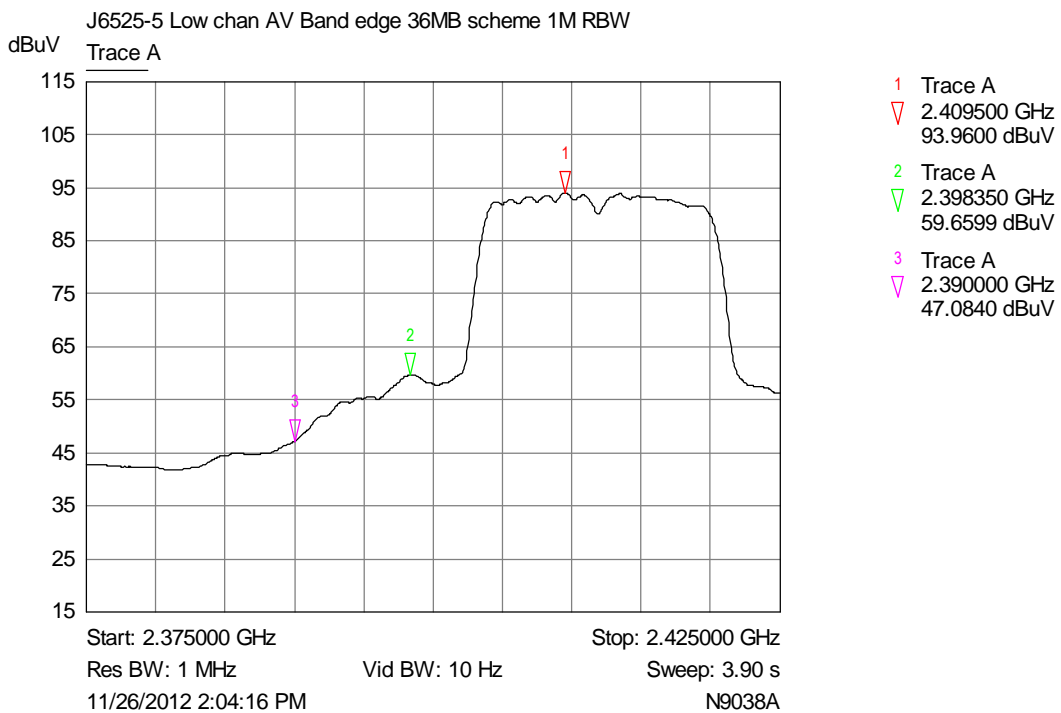
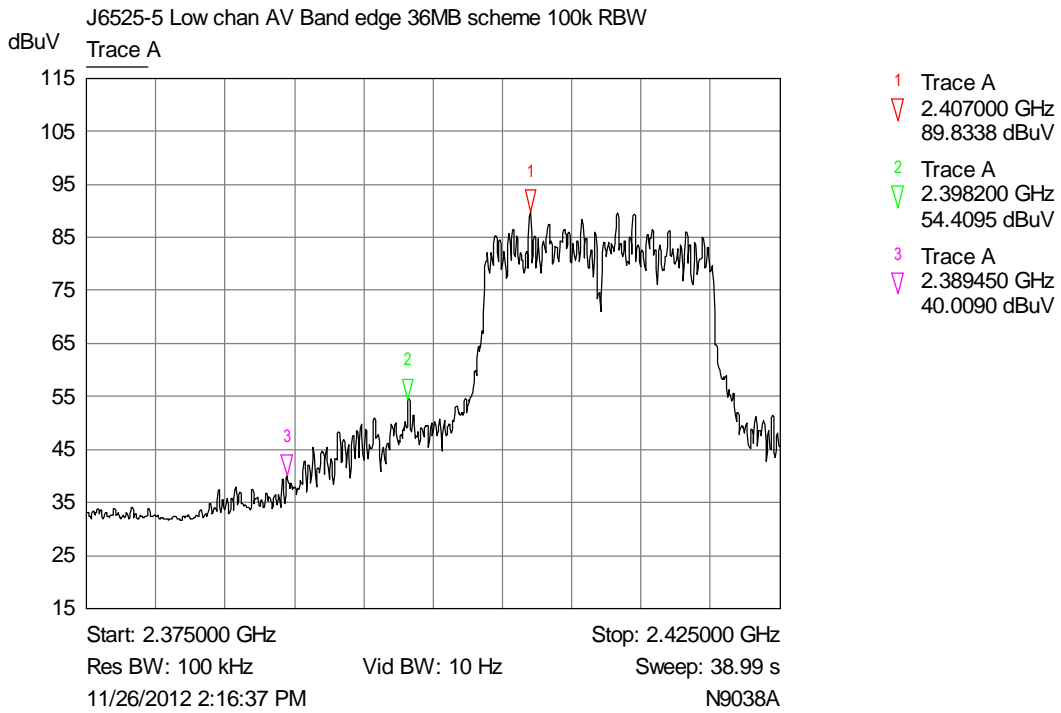

File name PURE.6525-5.DOCM

The contents of this report, apart from the referenced ANSI C63.4-2003, are beyond the scope of UKAS Testing Laboratory No. 2360 accreditation.

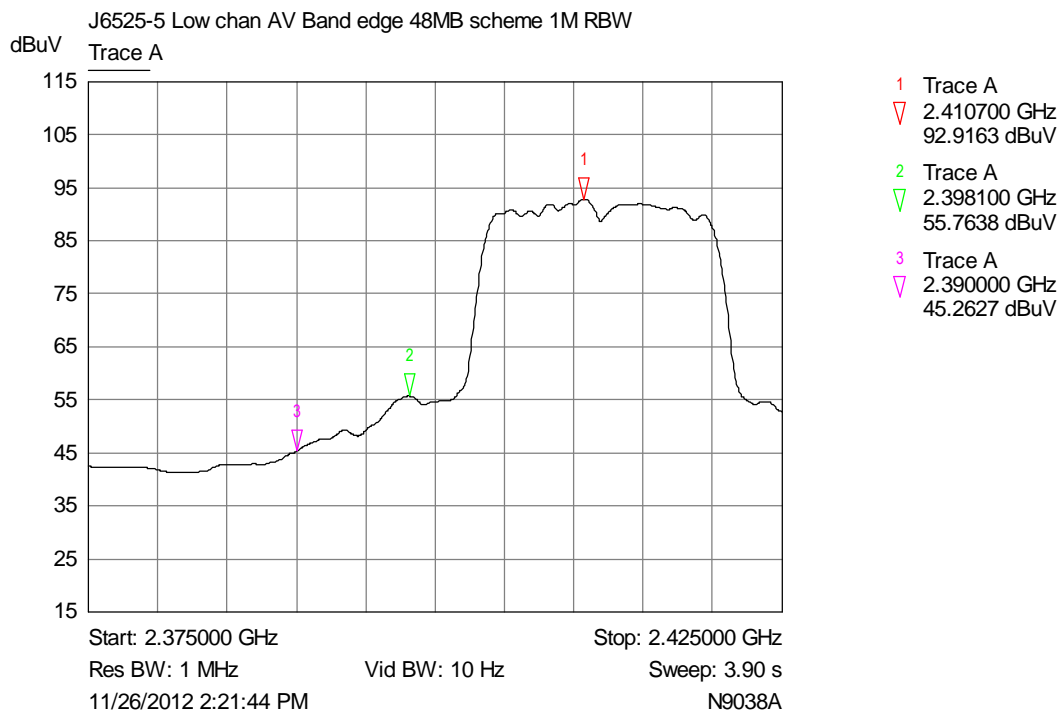
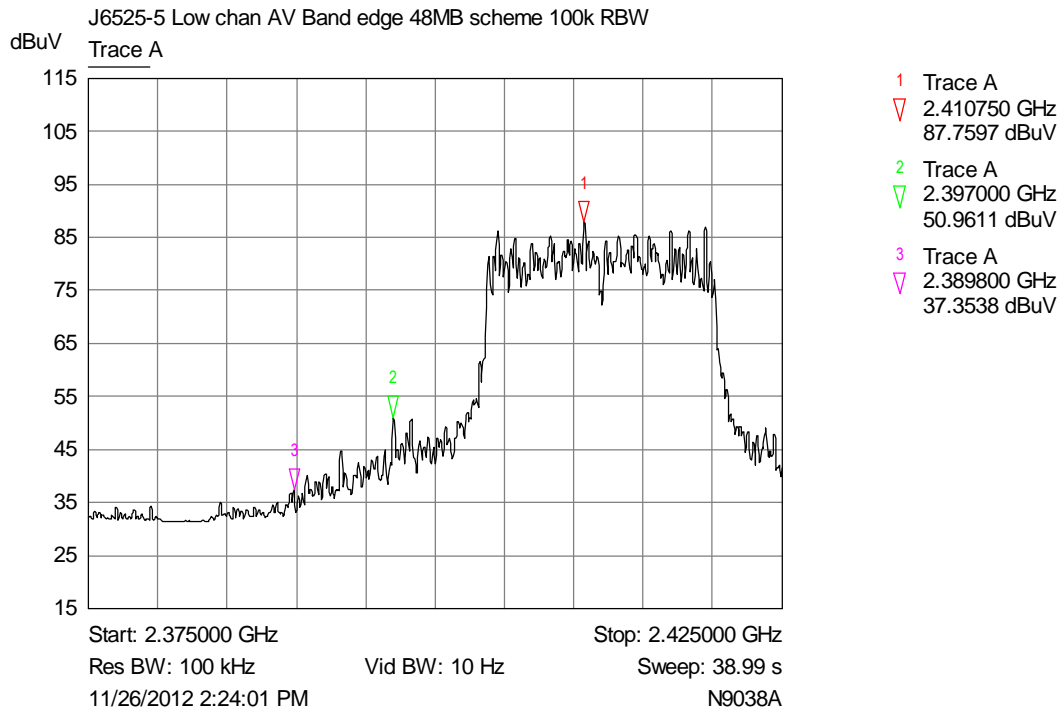

File name PURE.6525-5.DOCM

The contents of this report, apart from the referenced ANSI C63.4-2003, are beyond the scope of UKAS Testing Laboratory No. 2360 accreditation.

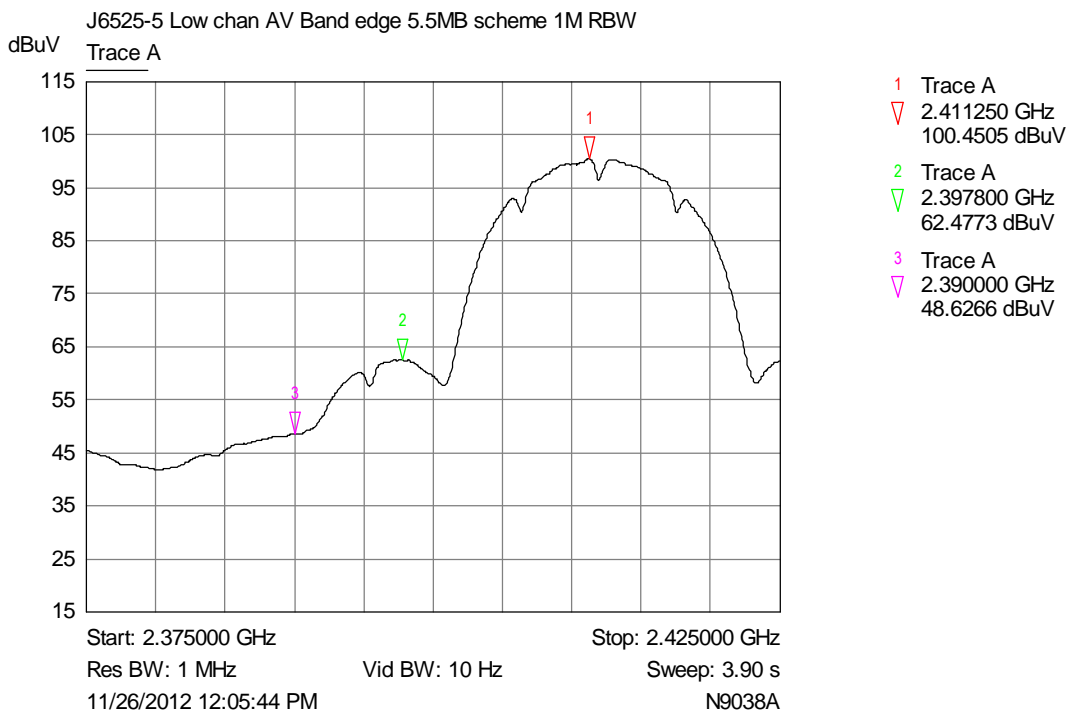
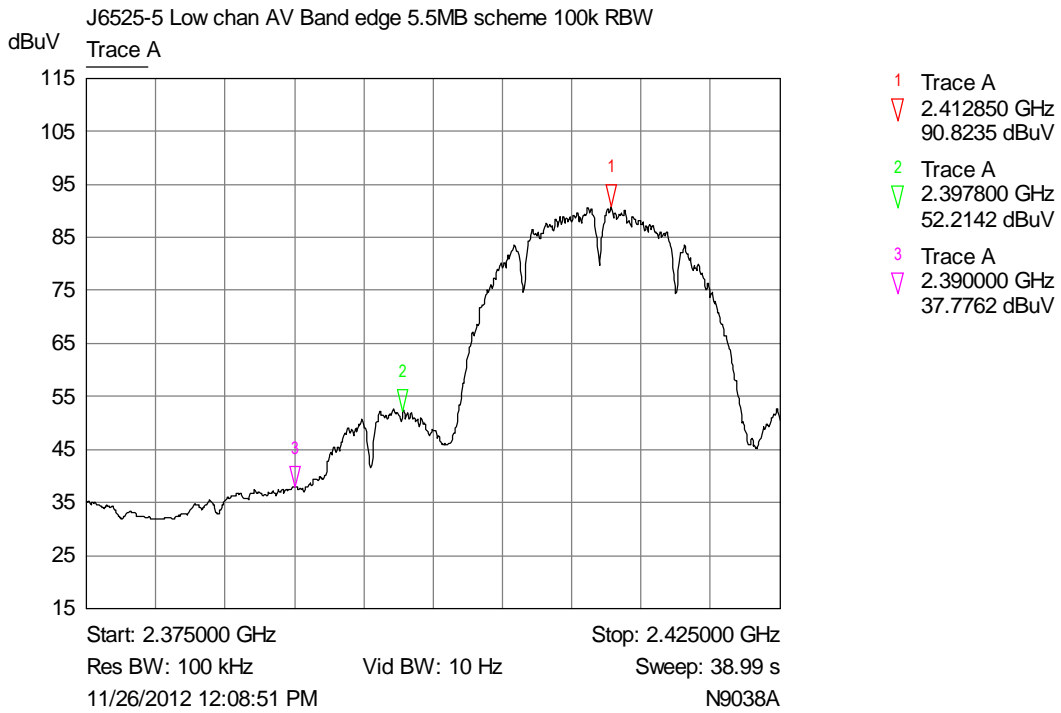

File name PURE.6525-5.DOCM

The contents of this report, apart from the referenced ANSI C63.4-2003, are beyond the scope of UKAS Testing Laboratory No. 2360 accreditation.

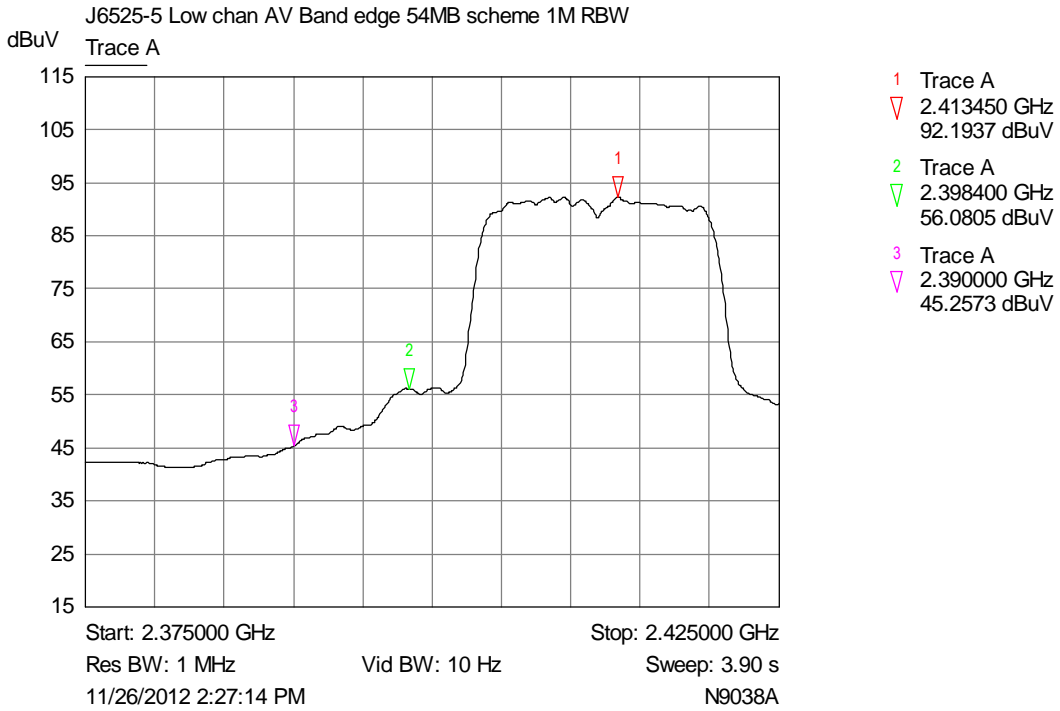
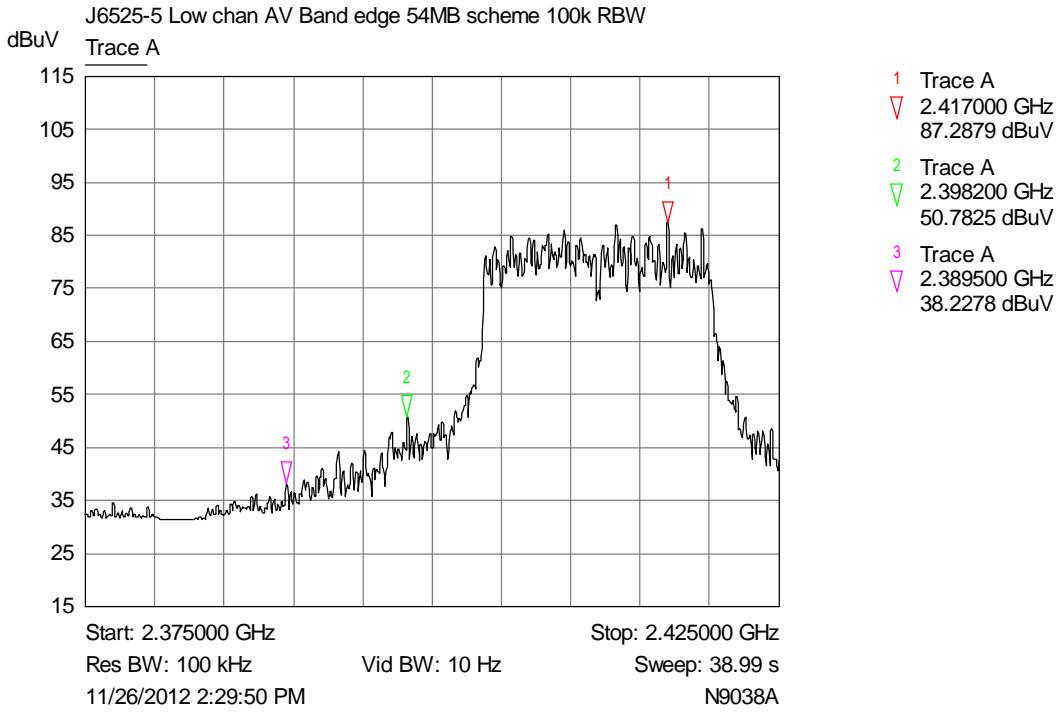

File name PURE.6525-5.DOCM

The contents of this report, apart from the referenced ANSI C63.4-2003, are beyond the scope of UKAS Testing Laboratory No. 2360 accreditation.

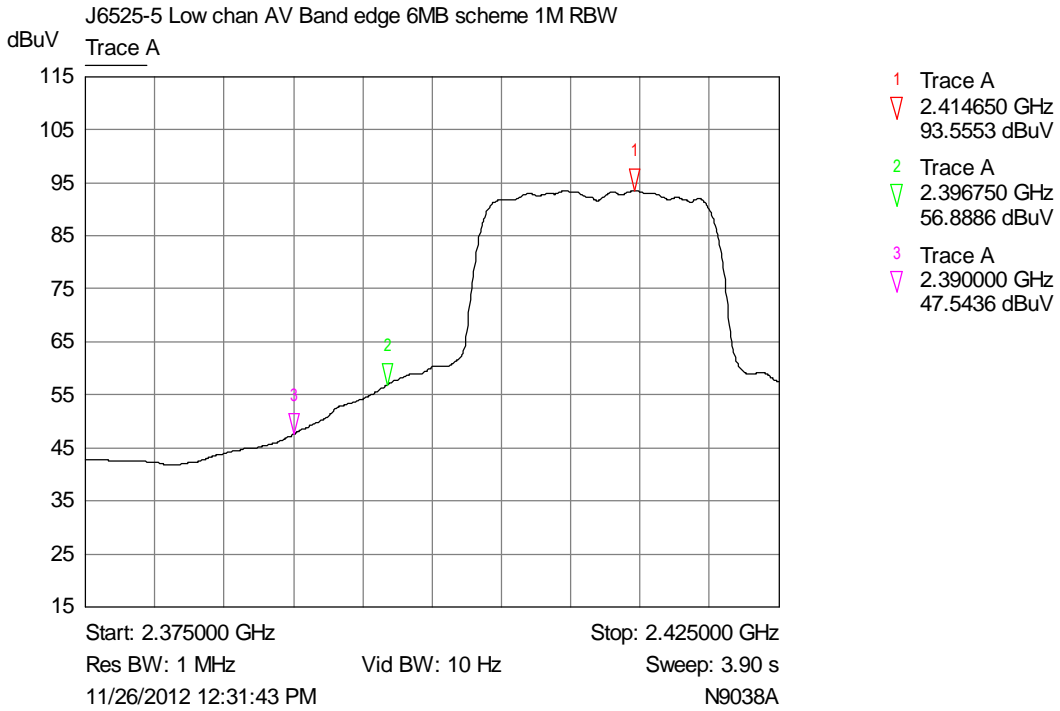
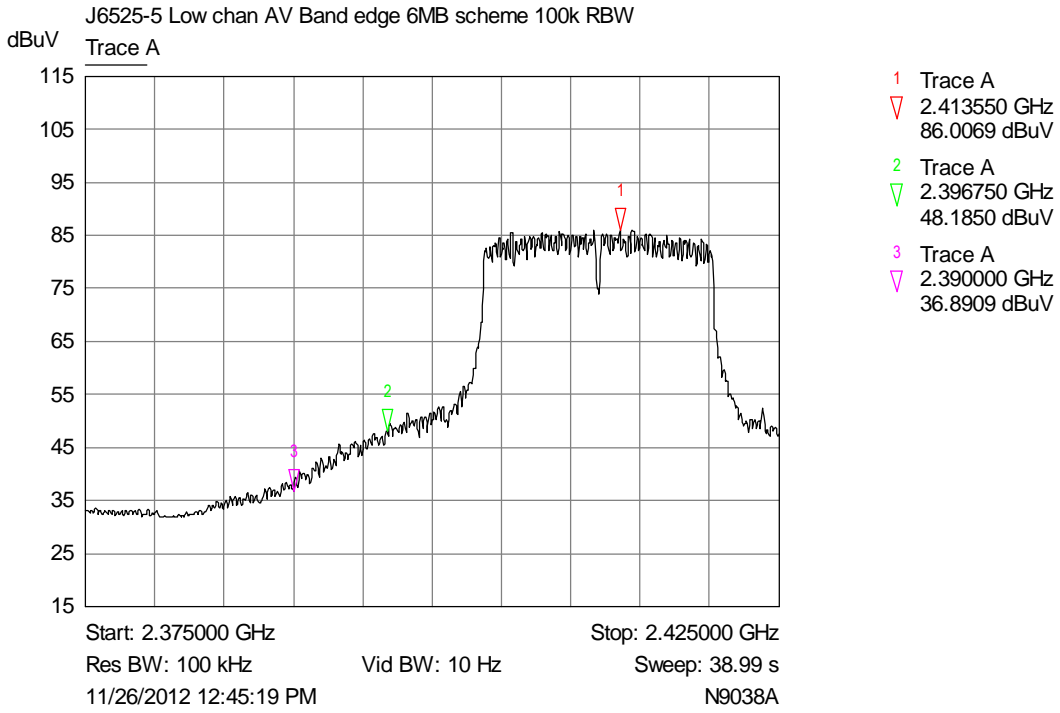

File name PURE.6525-5.DOCM

The contents of this report, apart from the referenced ANSI C63.4-2003, are beyond the scope of UKAS Testing Laboratory No. 2360 accreditation.

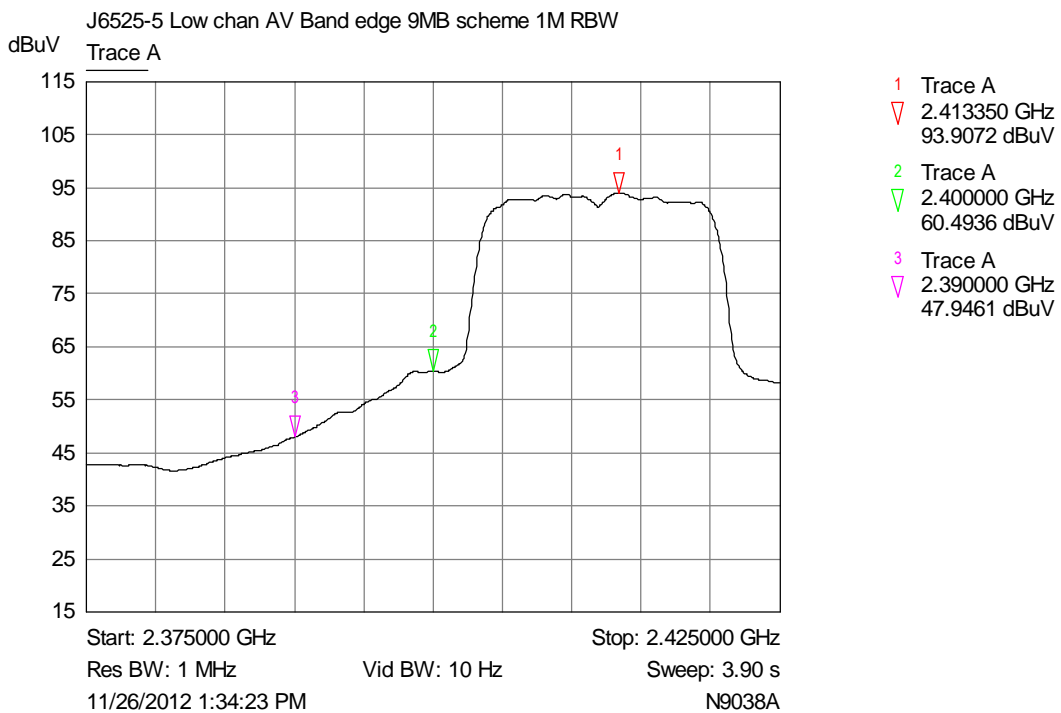
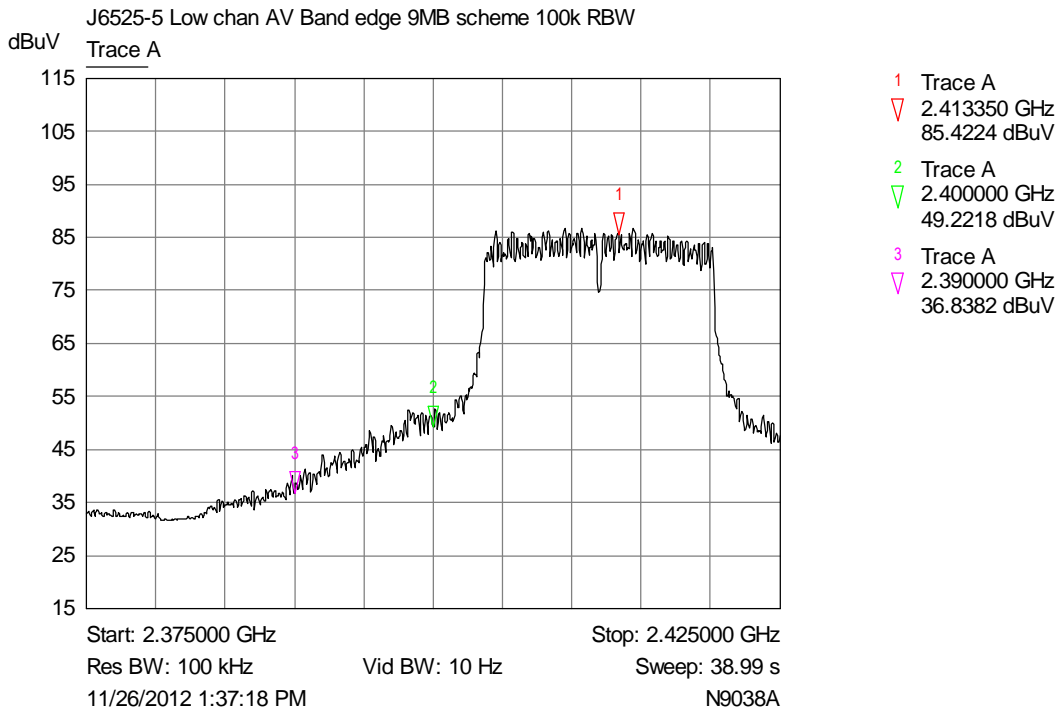

File name PURE.6525-5.DOCM

The contents of this report, apart from the referenced ANSI C63.4-2003, are beyond the scope of UKAS Testing Laboratory No. 2360 accreditation.

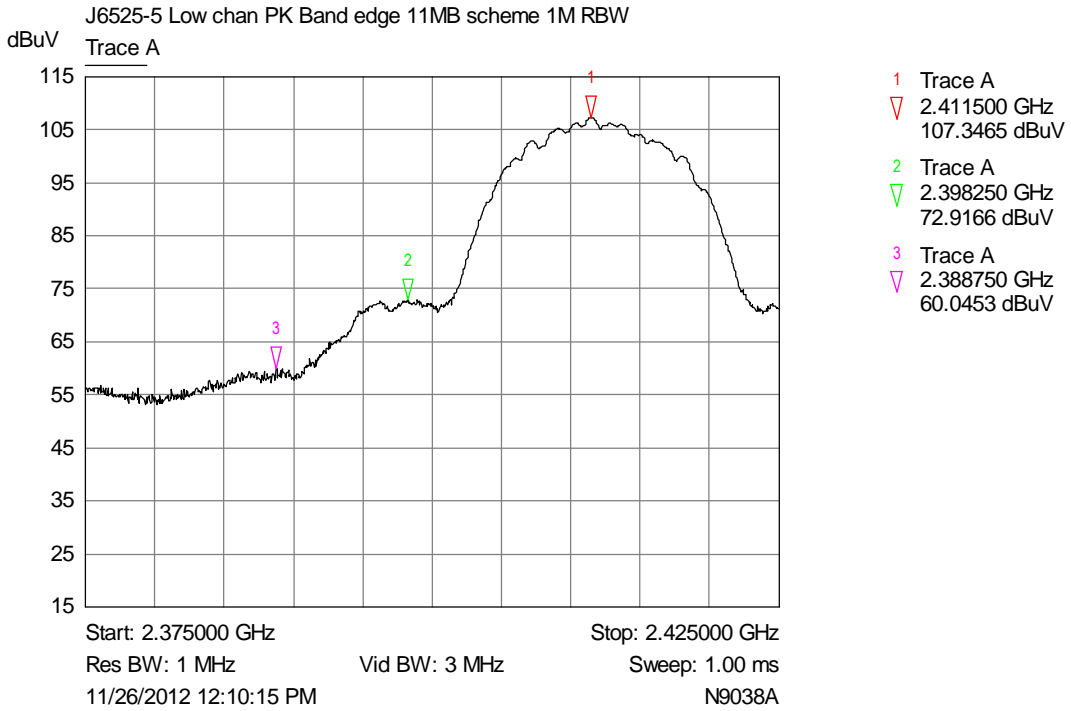
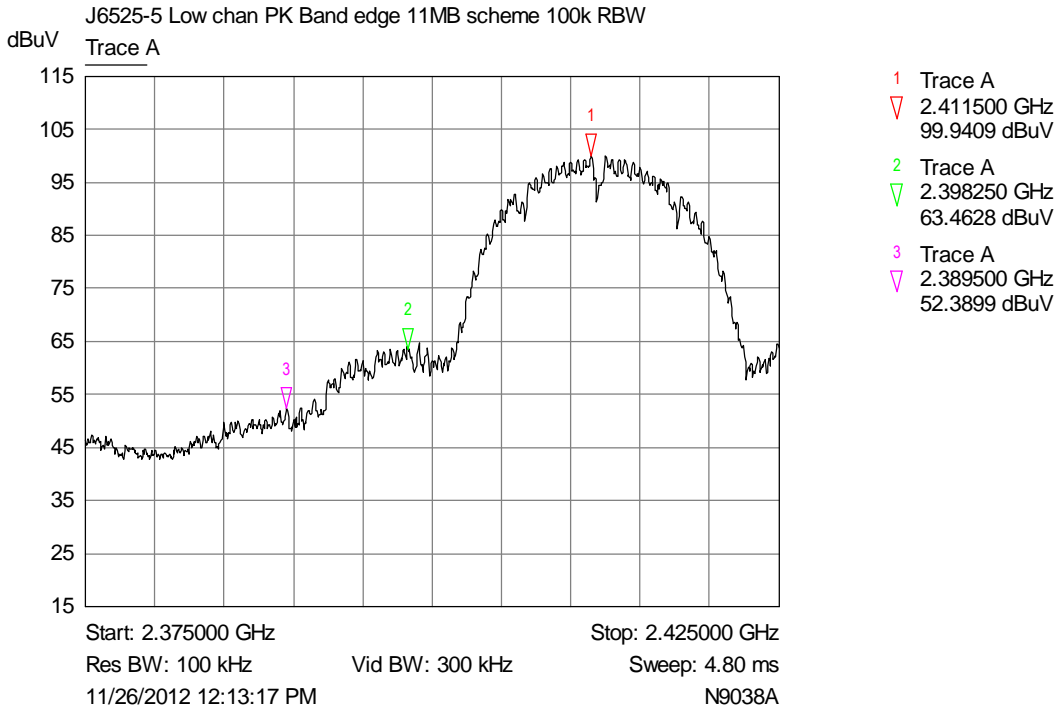

File name PURE.6525-5.DOCM

The contents of this report, apart from the referenced ANSI C63.4-2003, are beyond the scope of UKAS Testing Laboratory No. 2360 accreditation.

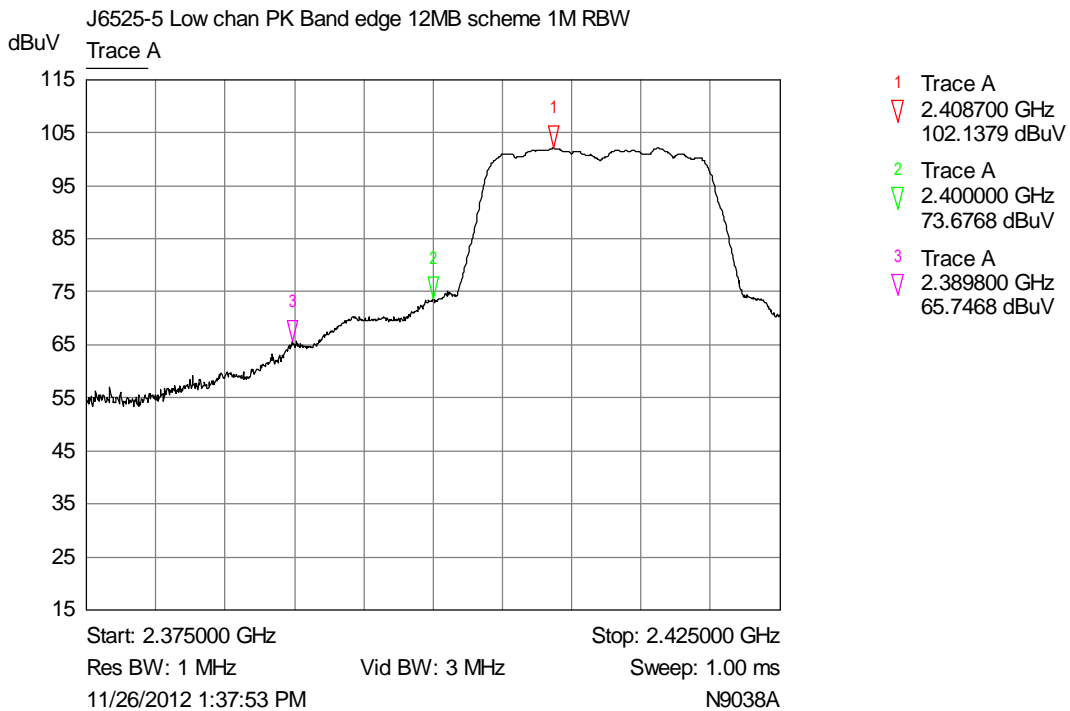
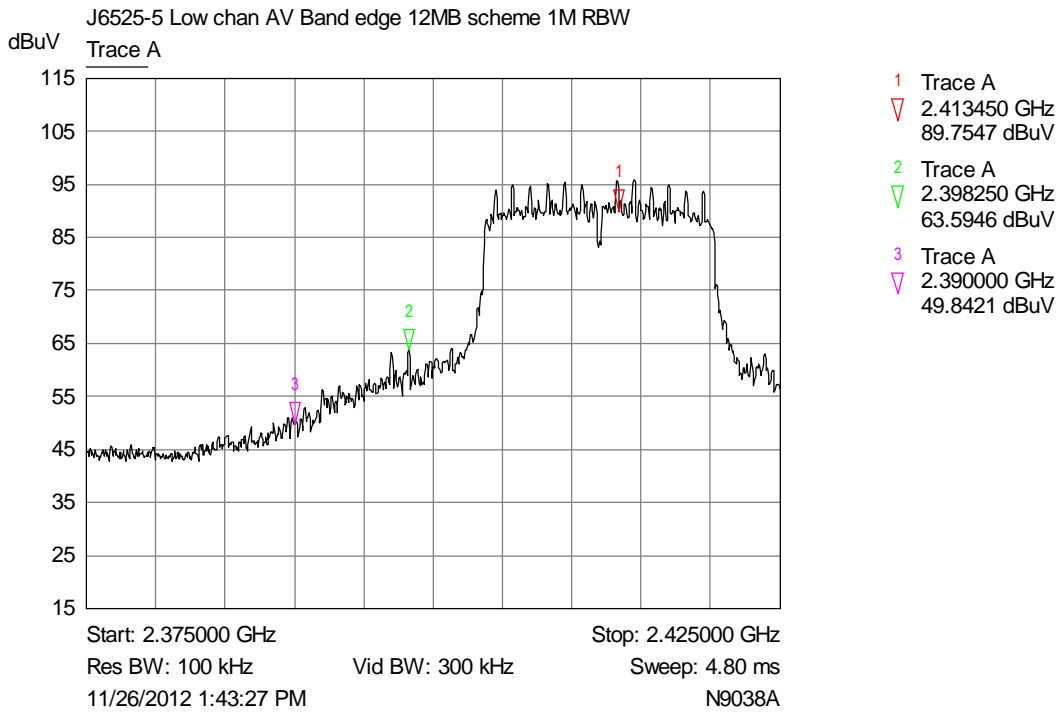

File name PURE.6525-5.DOCM

The contents of this report, apart from the referenced ANSI C63.4-2003, are beyond the scope of UKAS Testing Laboratory No. 2360 accreditation.

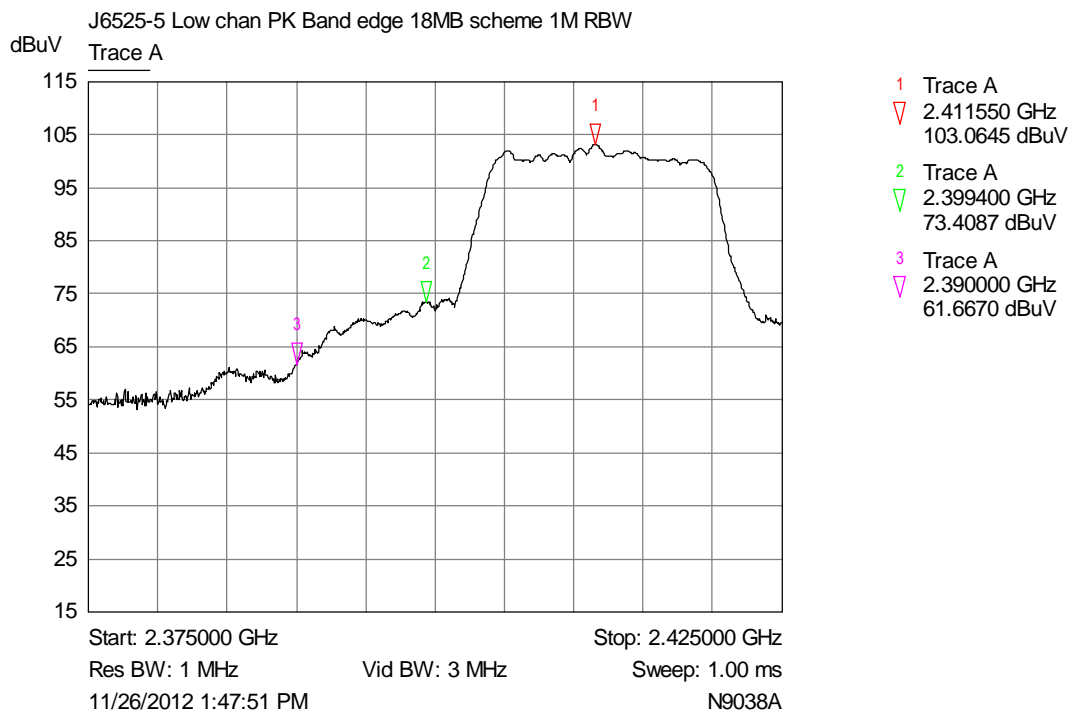
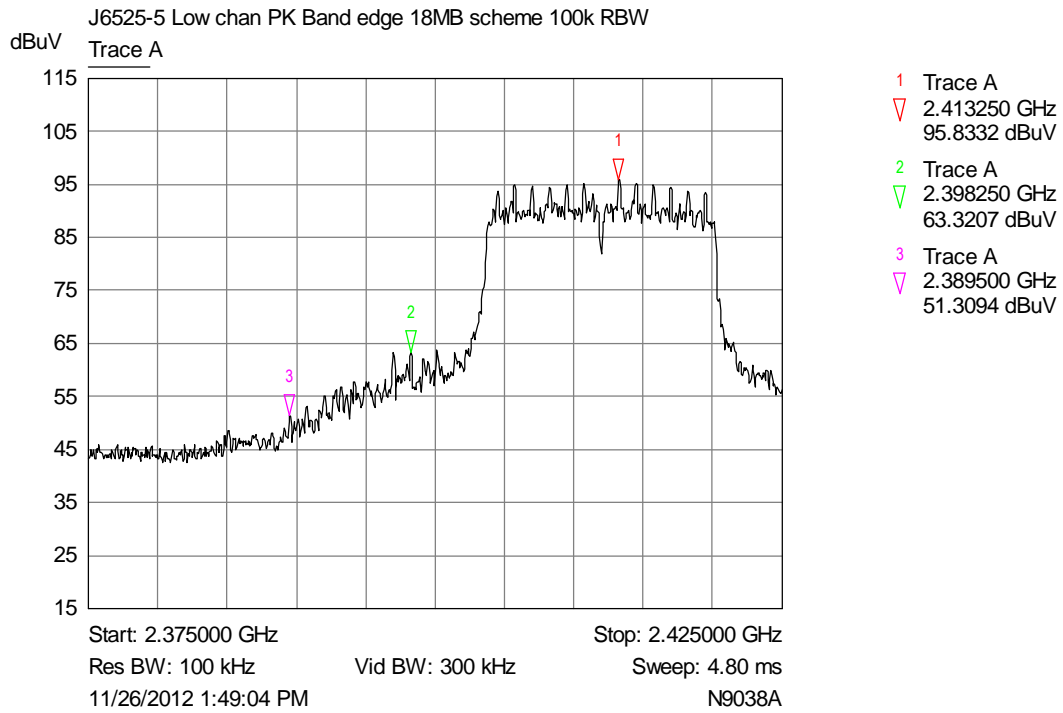

File name PURE.6525-5.DOCM

The contents of this report, apart from the referenced ANSI C63.4-2003, are beyond the scope of UKAS Testing Laboratory No. 2360 accreditation.

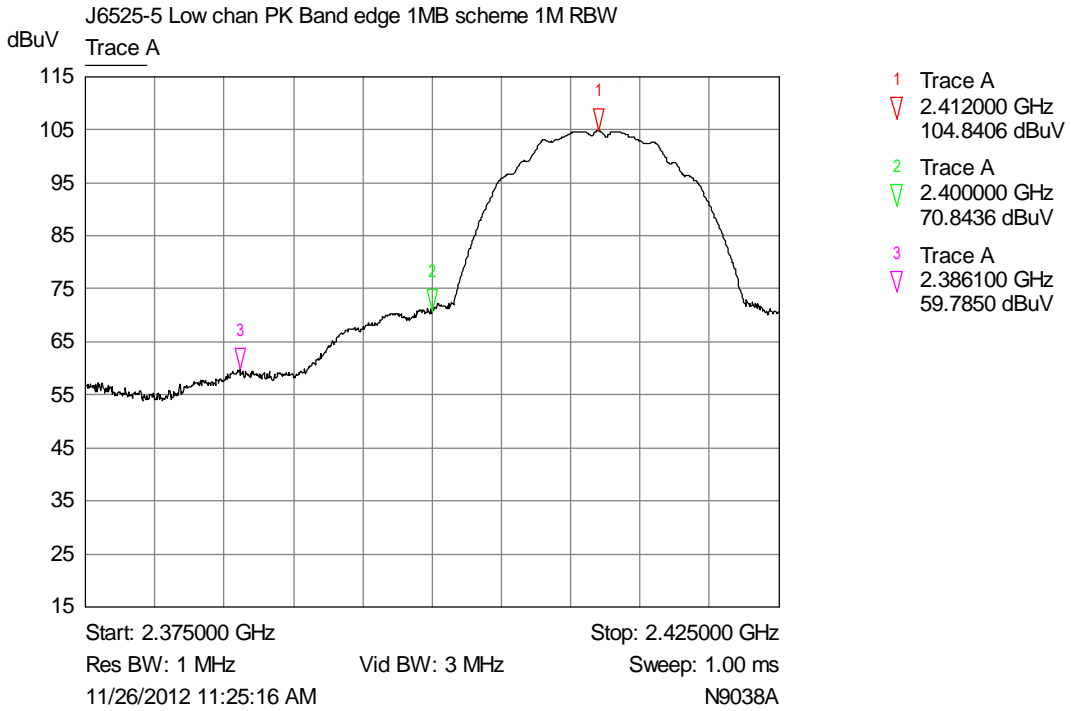
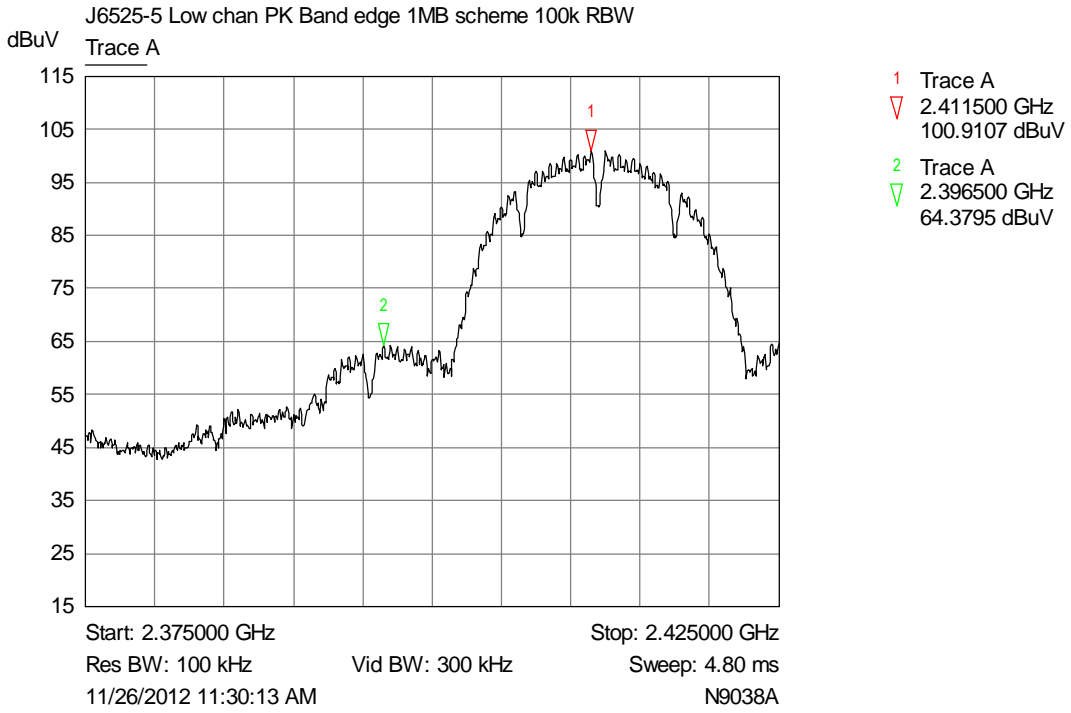

File name PURE.6525-5.DOCM

The contents of this report, apart from the referenced ANSI C63.4-2003, are beyond the scope of UKAS Testing Laboratory No. 2360 accreditation.

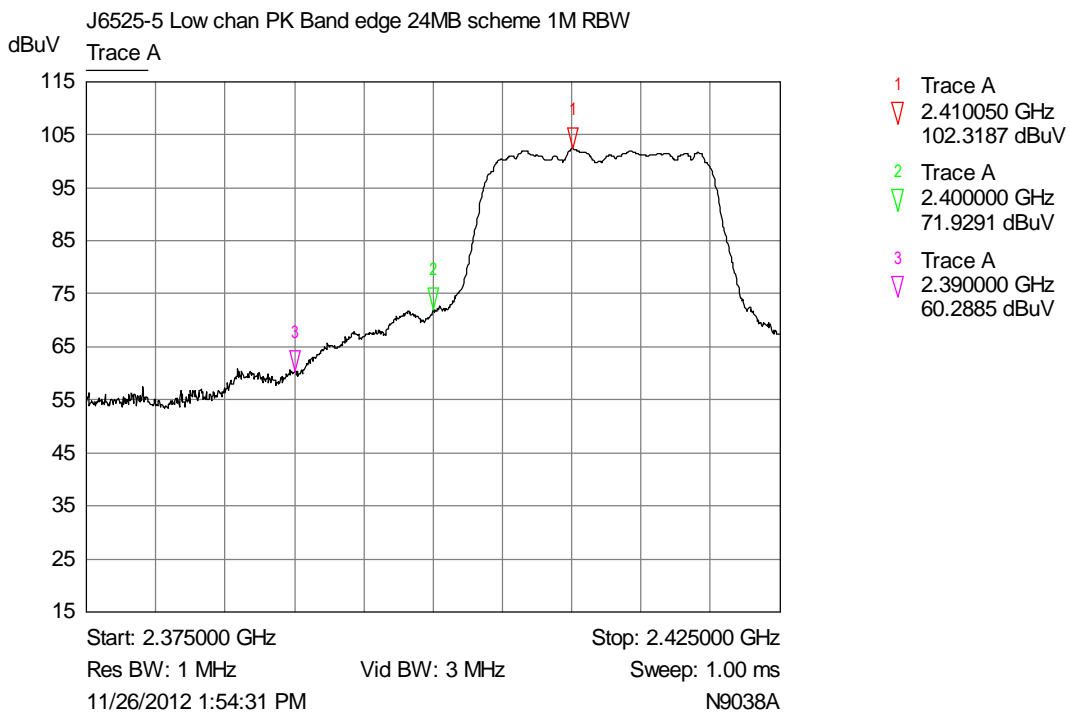
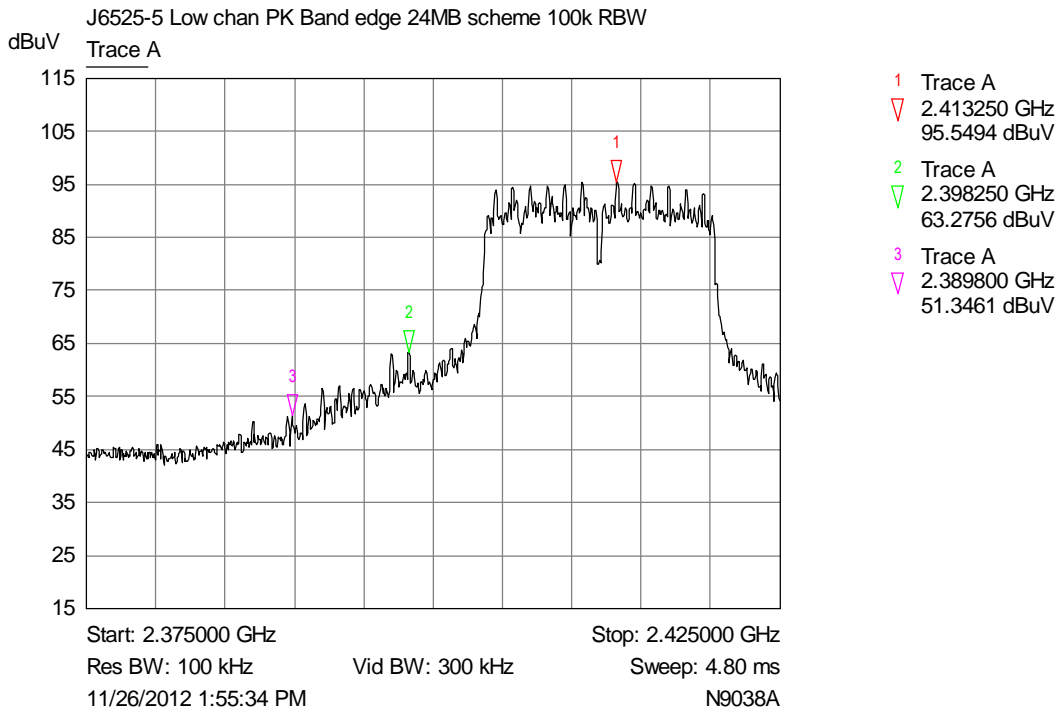

File name PURE.6525-5.DOCM

The contents of this report, apart from the referenced ANSI C63.4-2003, are beyond the scope of UKAS Testing Laboratory No. 2360 accreditation.

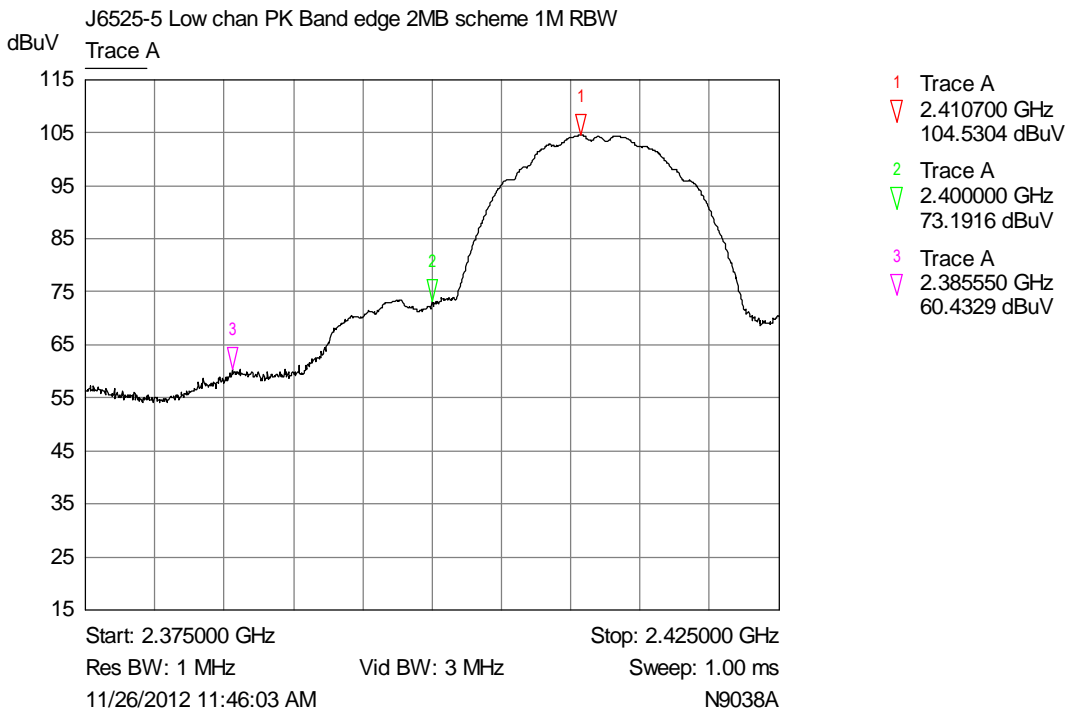
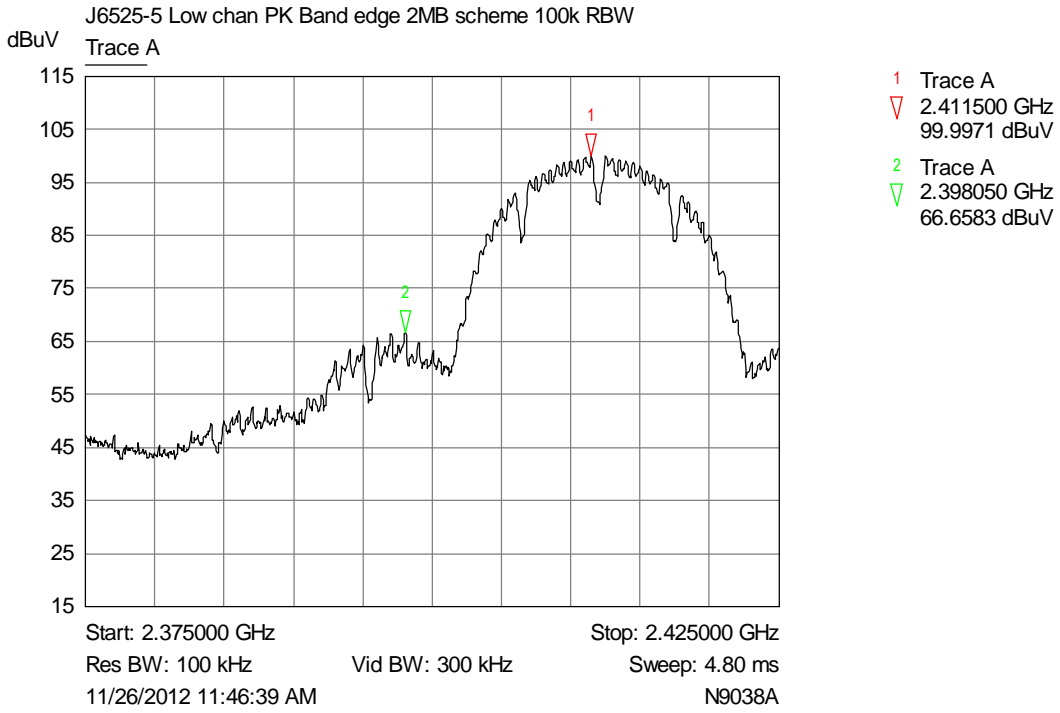

File name PURE.6525-5.DOCM

The contents of this report, apart from the referenced ANSI C63.4-2003, are beyond the scope of UKAS Testing Laboratory No. 2360 accreditation.

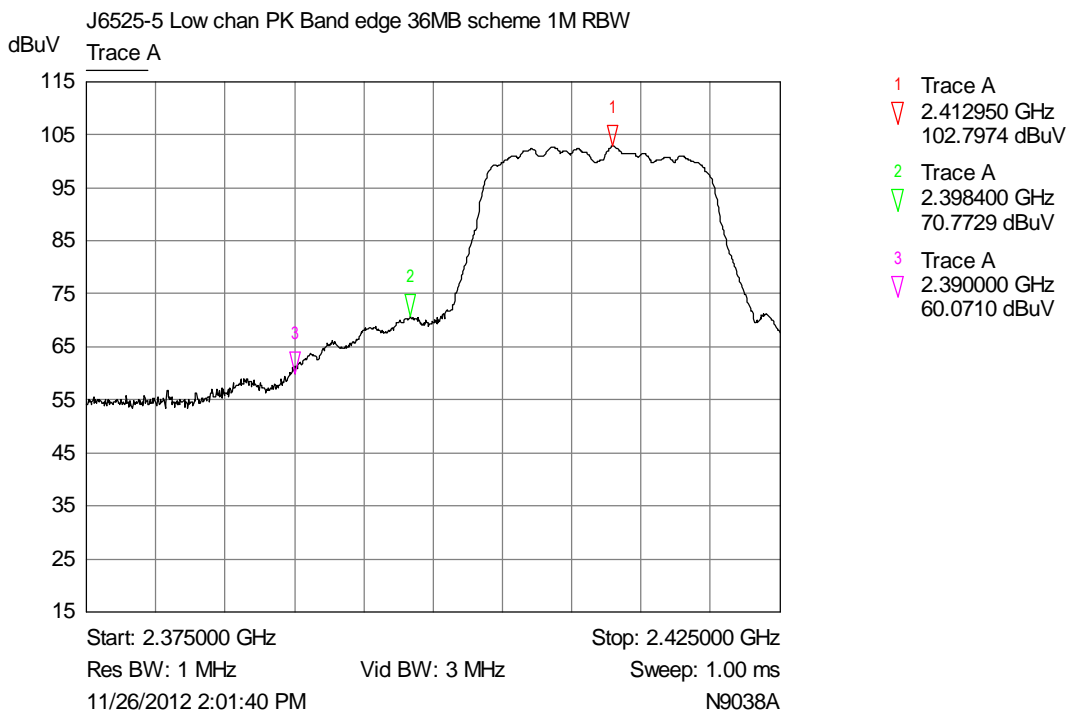
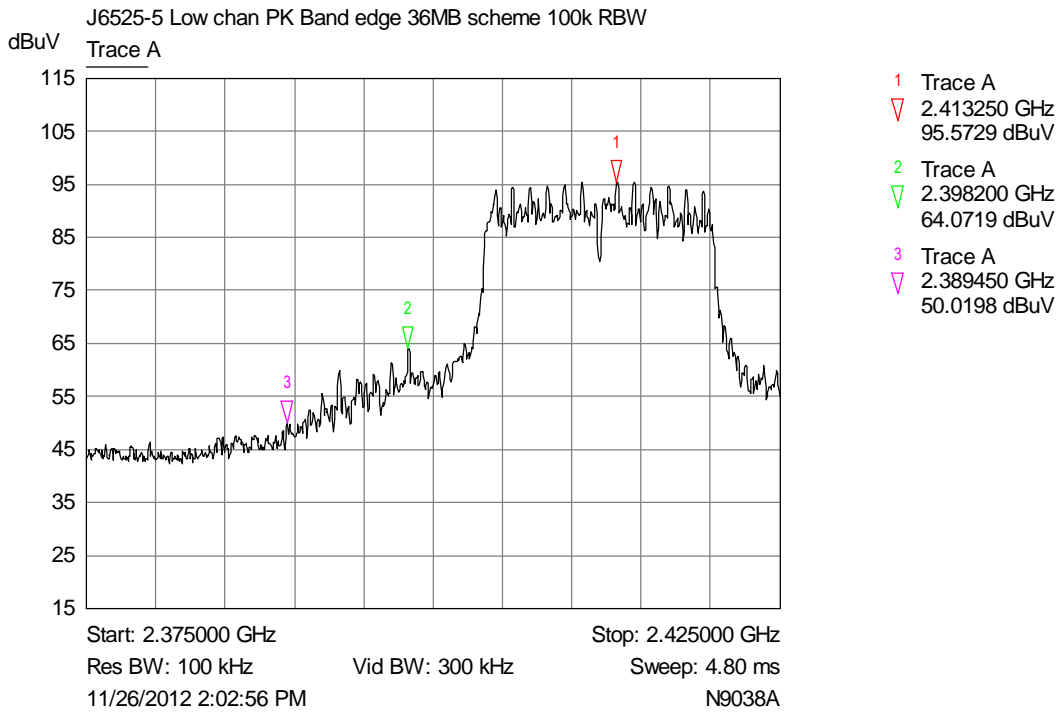

File name PURE.6525-5.DOCM

The contents of this report, apart from the referenced ANSI C63.4-2003, are beyond the scope of UKAS Testing Laboratory No. 2360 accreditation.

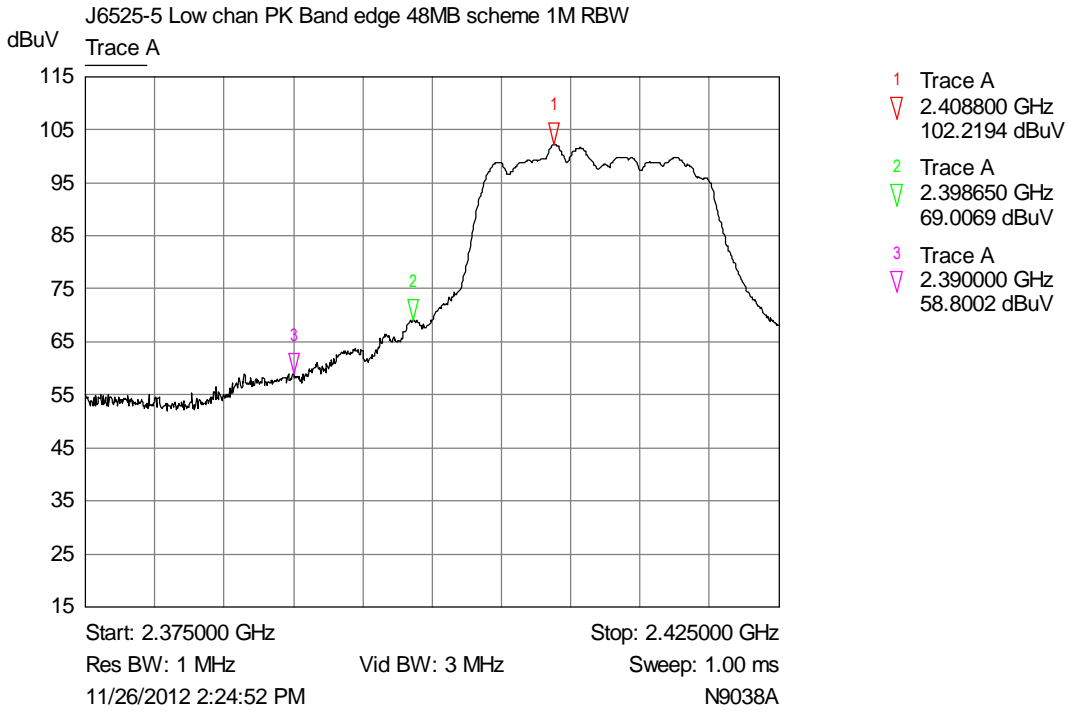
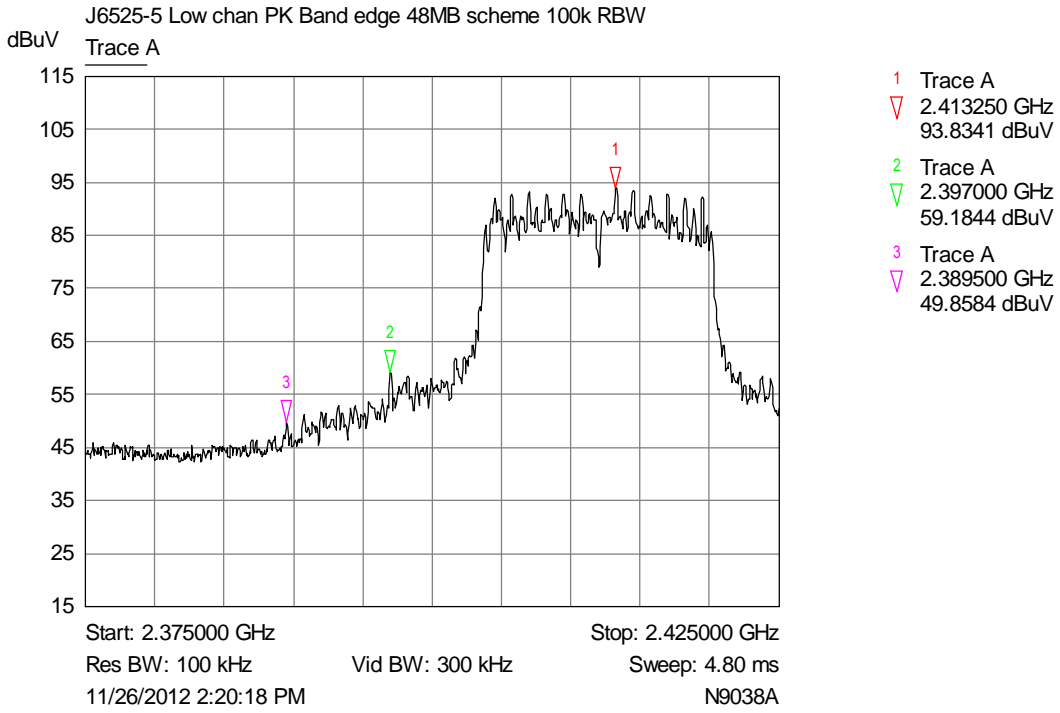

File name PURE.6525-5.DOCM

The contents of this report, apart from the referenced ANSI C63.4-2003, are beyond the scope of UKAS Testing Laboratory No. 2360 accreditation.

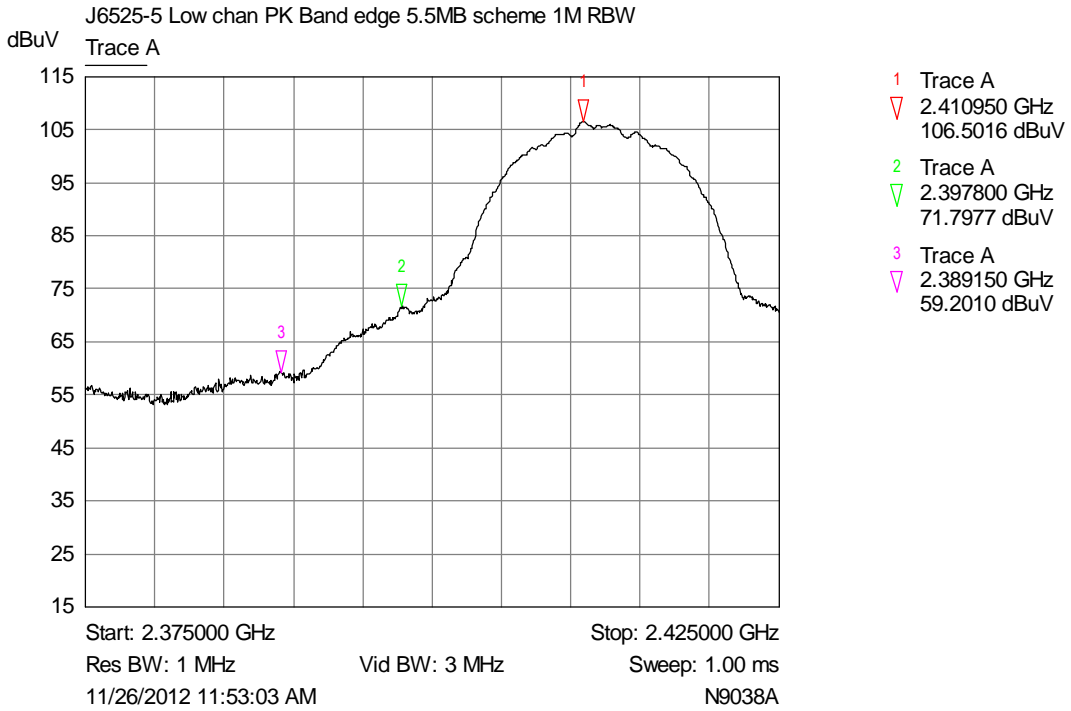
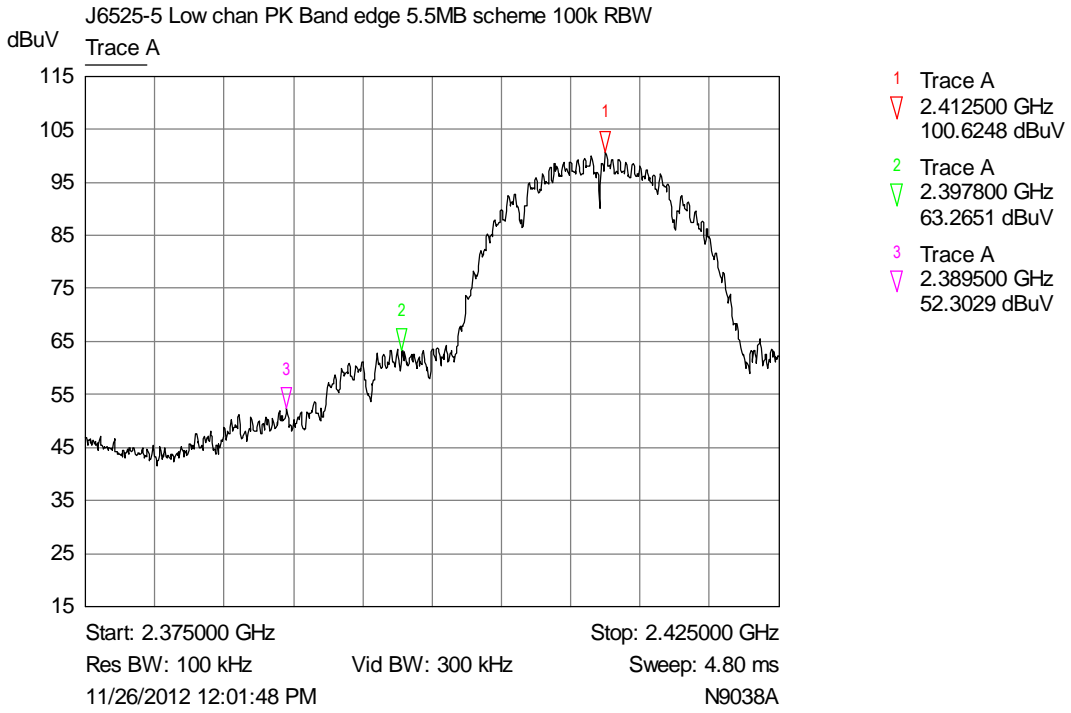

File name PURE.6525-5.DOCM

The contents of this report, apart from the referenced ANSI C63.4-2003, are beyond the scope of UKAS Testing Laboratory No. 2360 accreditation.

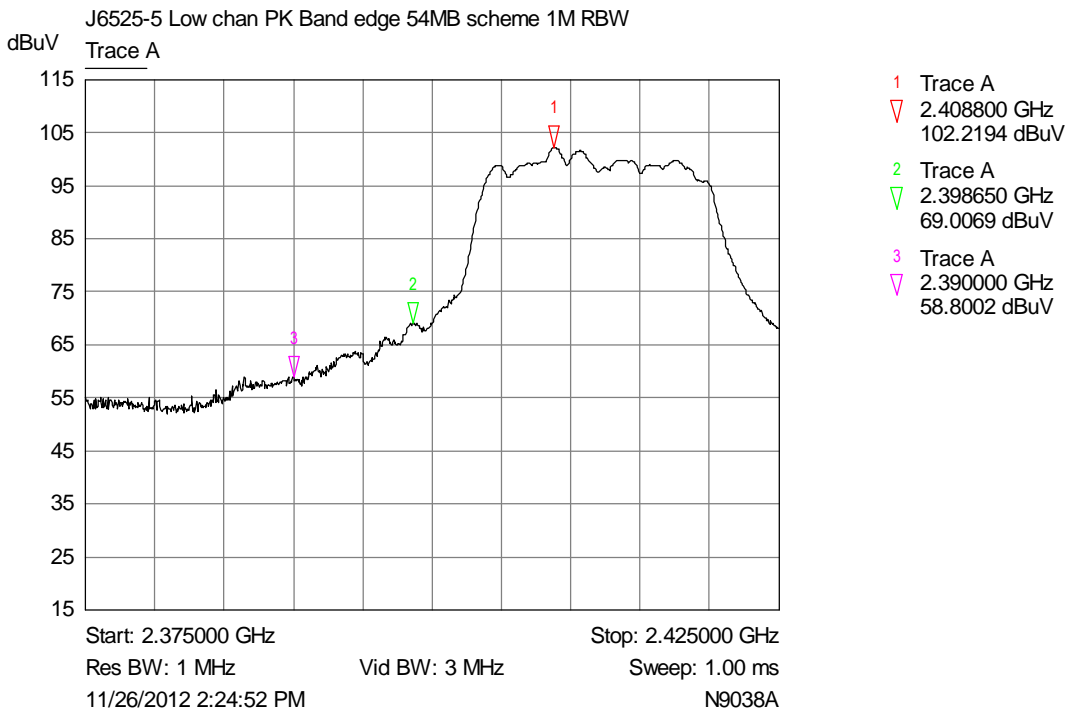
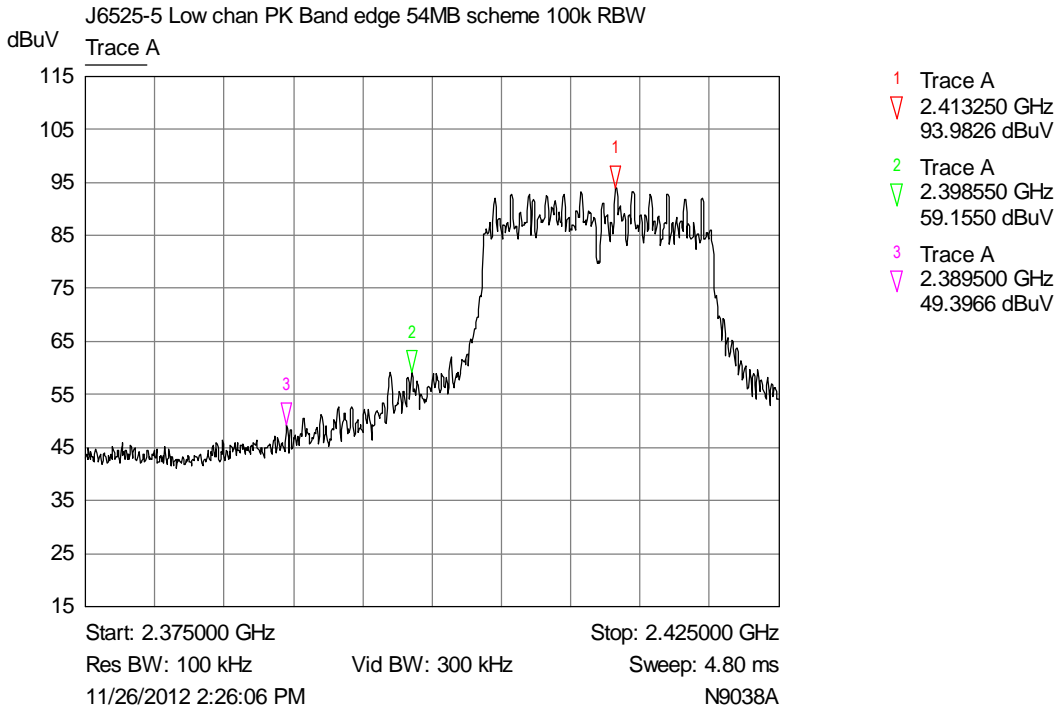

File name PURE.6525-5.DOCM

The contents of this report, apart from the referenced ANSI C63.4-2003, are beyond the scope of UKAS Testing Laboratory No. 2360 accreditation.

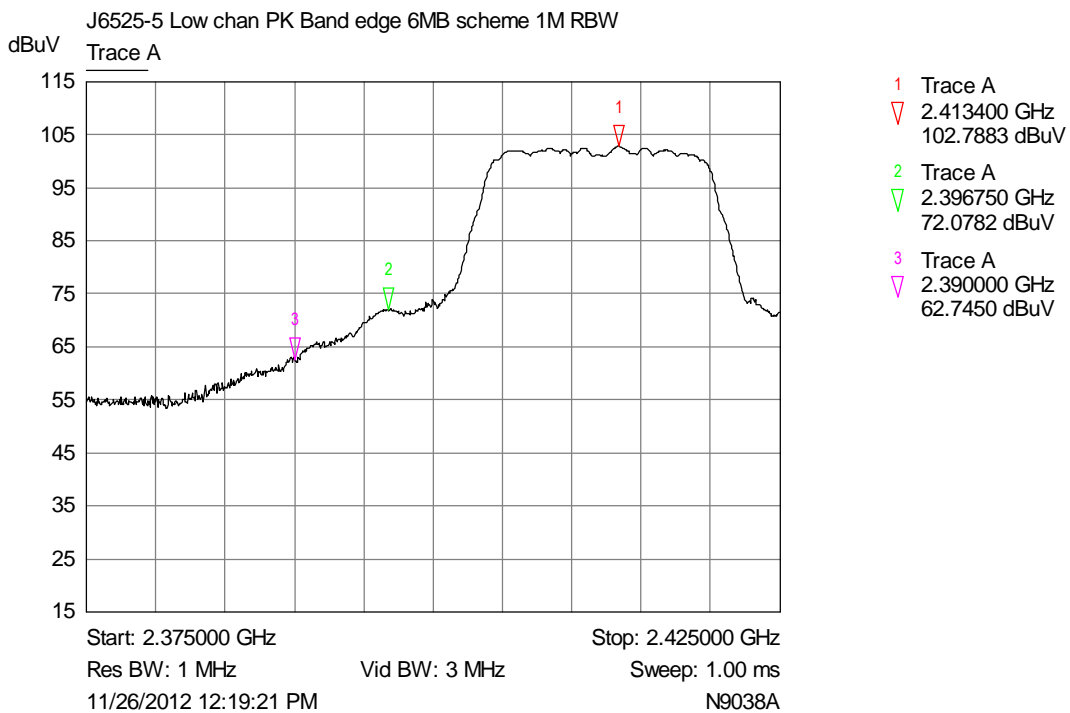
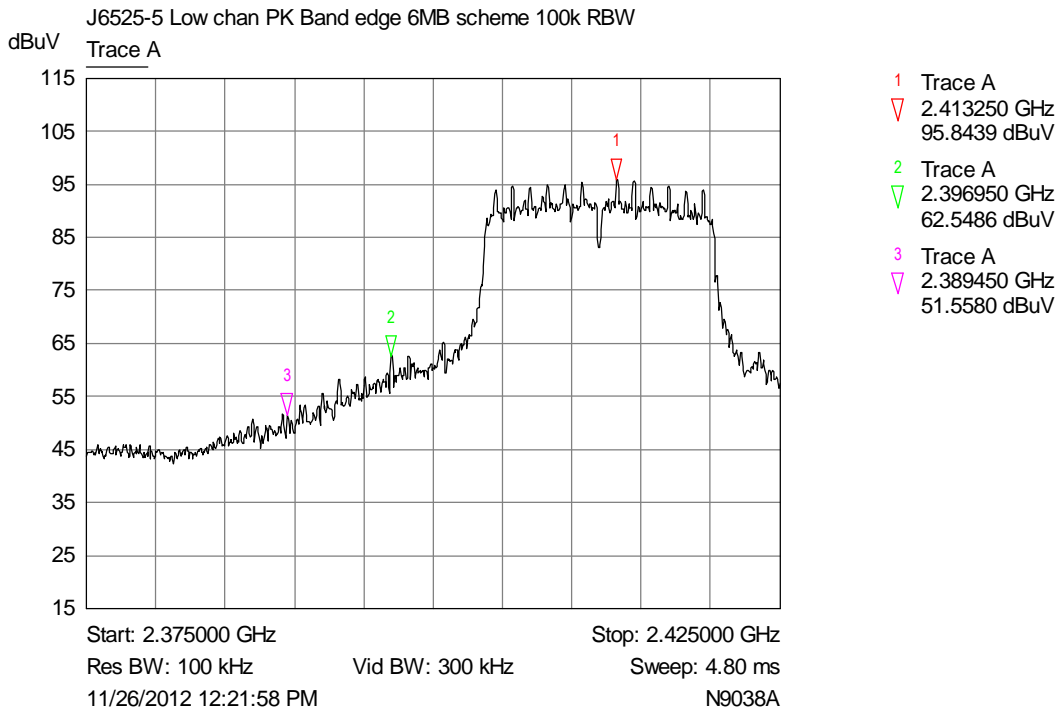

File name PURE.6525-5.DOCM

The contents of this report, apart from the referenced ANSI C63.4-2003, are beyond the scope of UKAS Testing Laboratory No. 2360 accreditation.

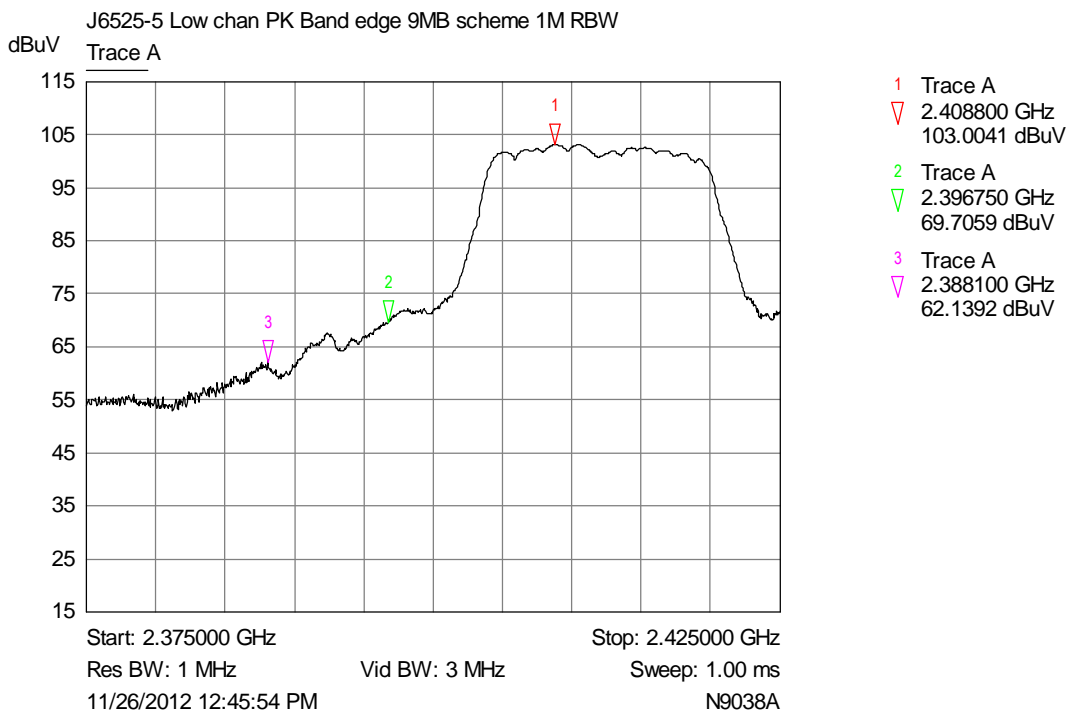
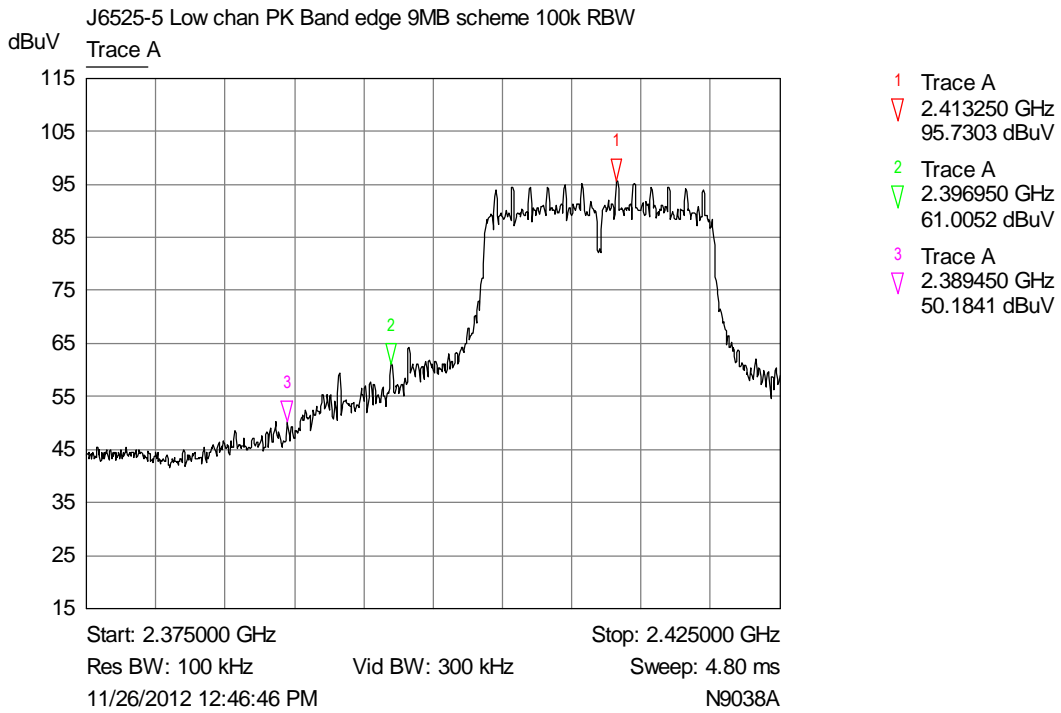

File name PURE.6525-5.DOCM

The contents of this report, apart from the referenced ANSI C63.4-2003, are beyond the scope of UKAS Testing Laboratory No. 2360 accreditation.

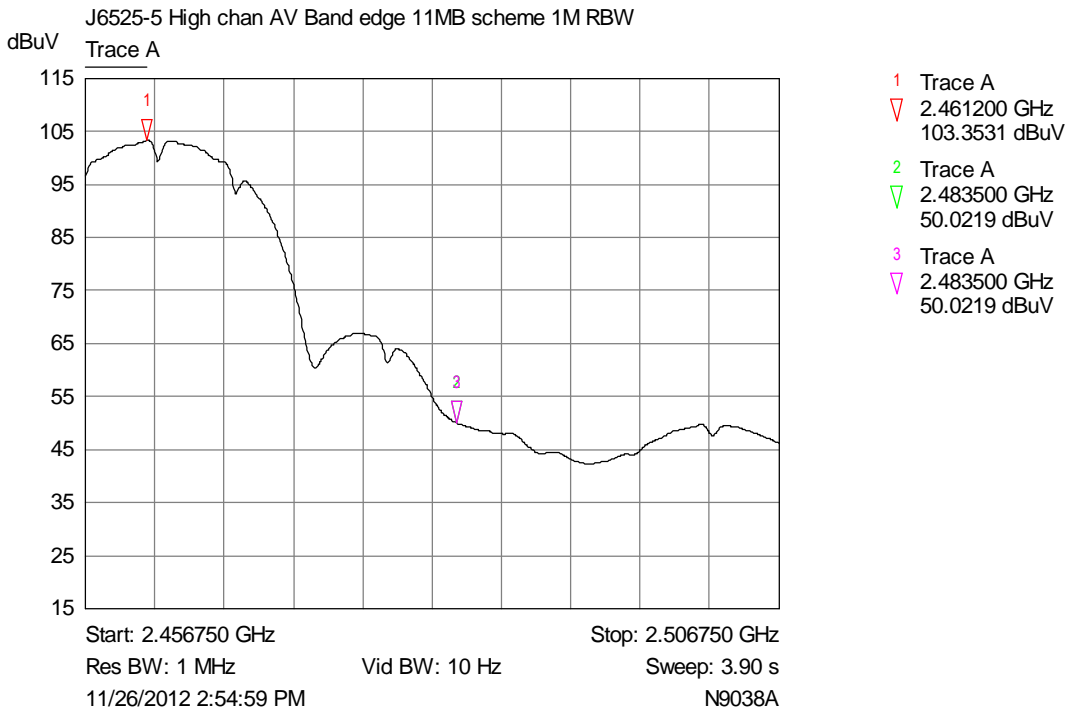
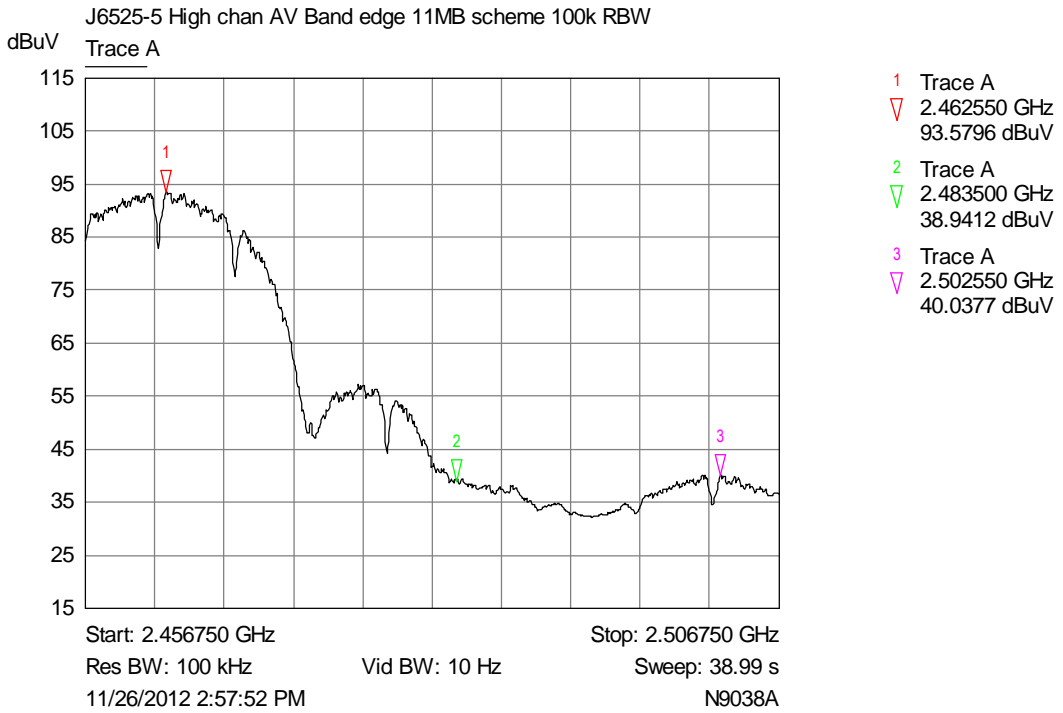

File name PURE.6525-5.DOCM

The contents of this report, apart from the referenced ANSI C63.4-2003, are beyond the scope of UKAS Testing Laboratory No. 2360 accreditation.

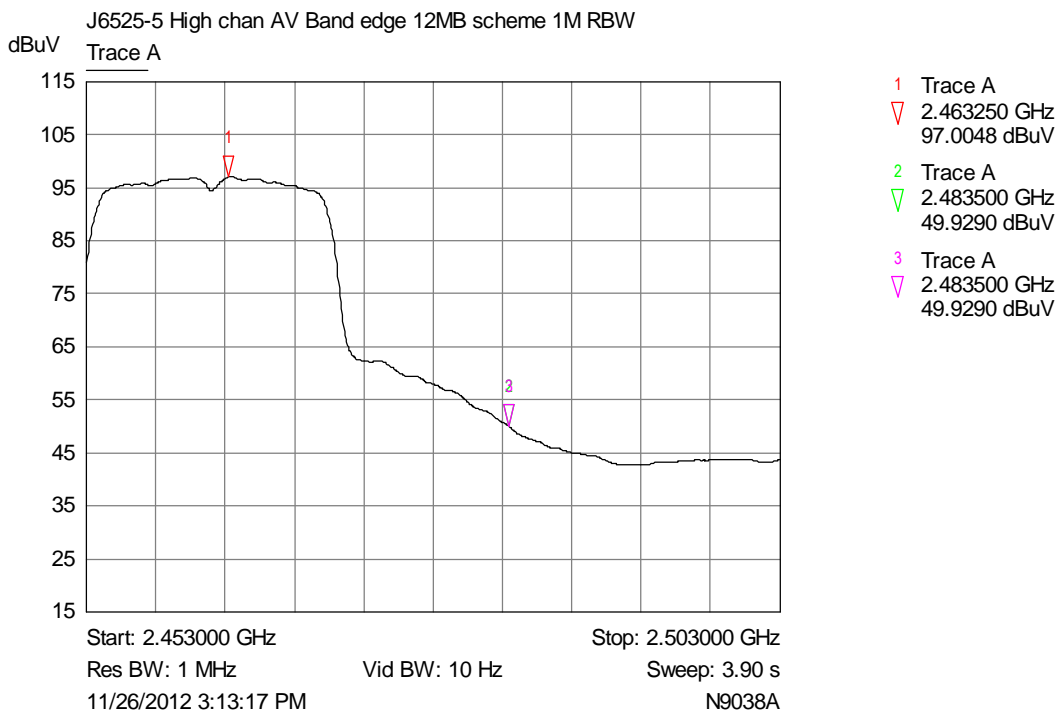
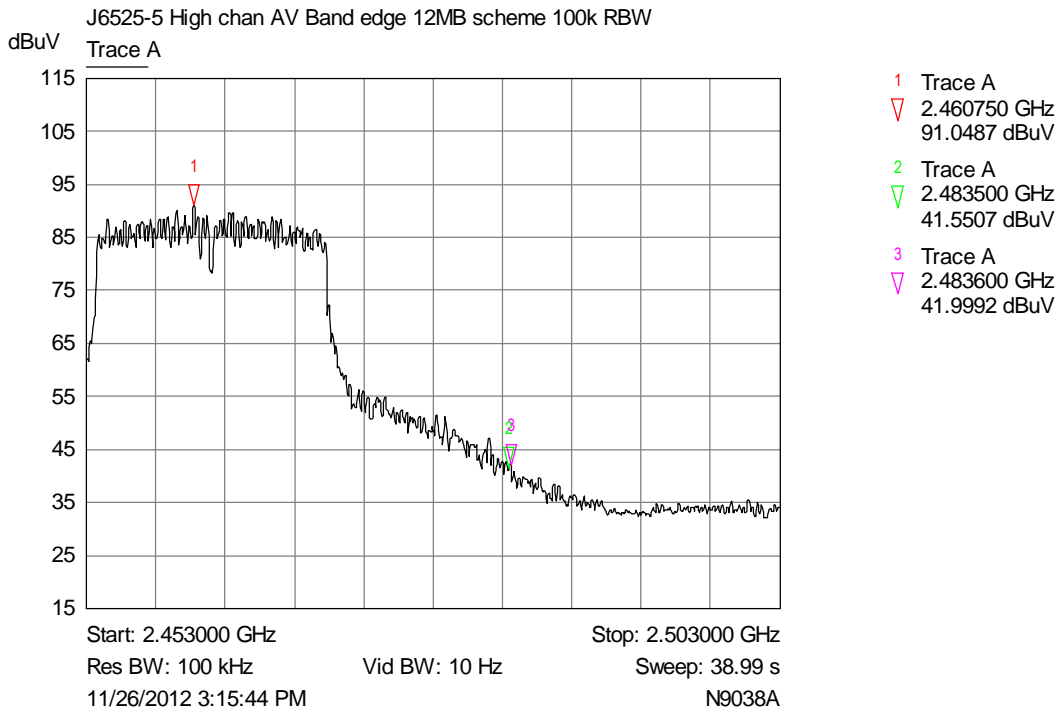

File name PURE.6525-5.DOCM

The contents of this report, apart from the referenced ANSI C63.4-2003, are beyond the scope of UKAS Testing Laboratory No. 2360 accreditation.

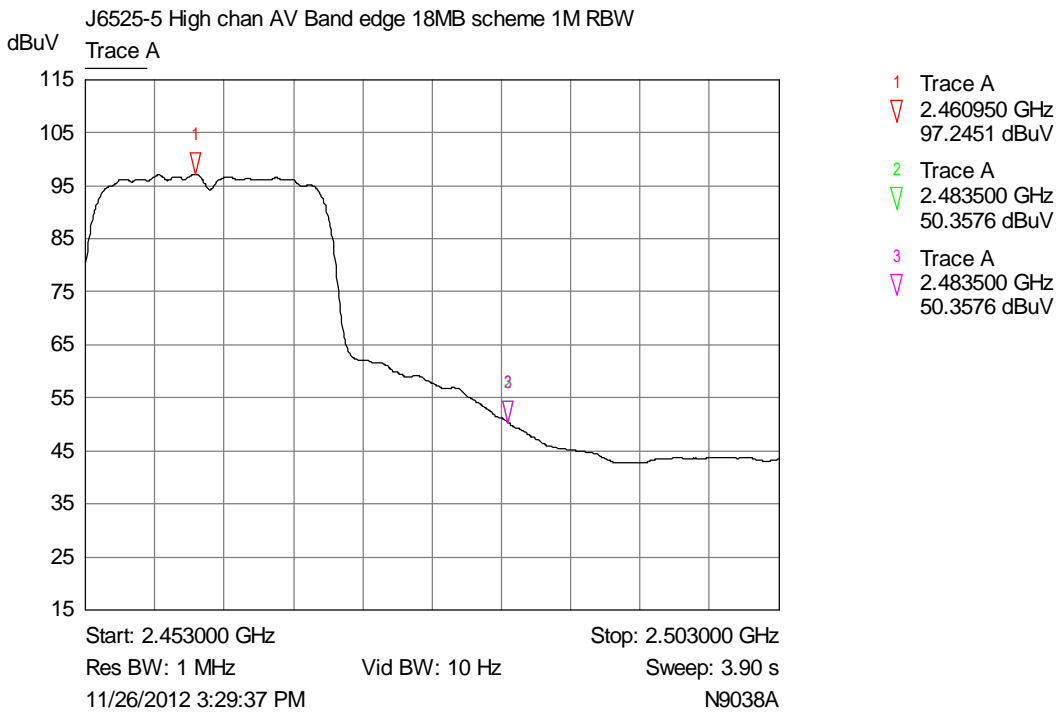
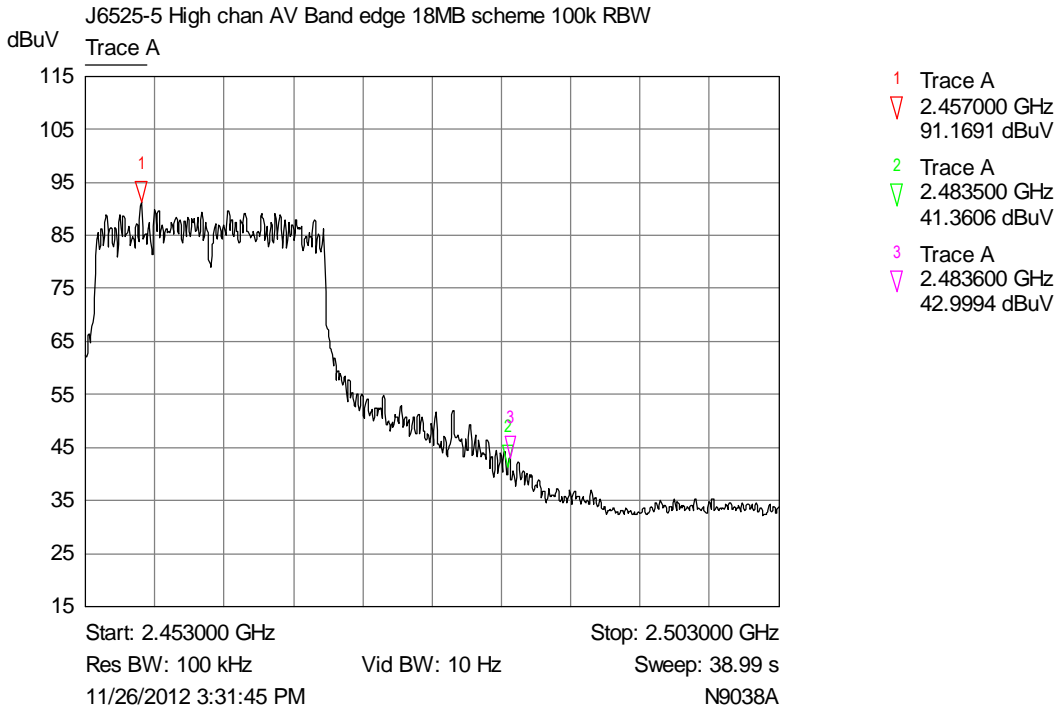

File name PURE.6525-5.DOCM

The contents of this report, apart from the referenced ANSI C63.4-2003, are beyond the scope of UKAS Testing Laboratory No. 2360 accreditation.

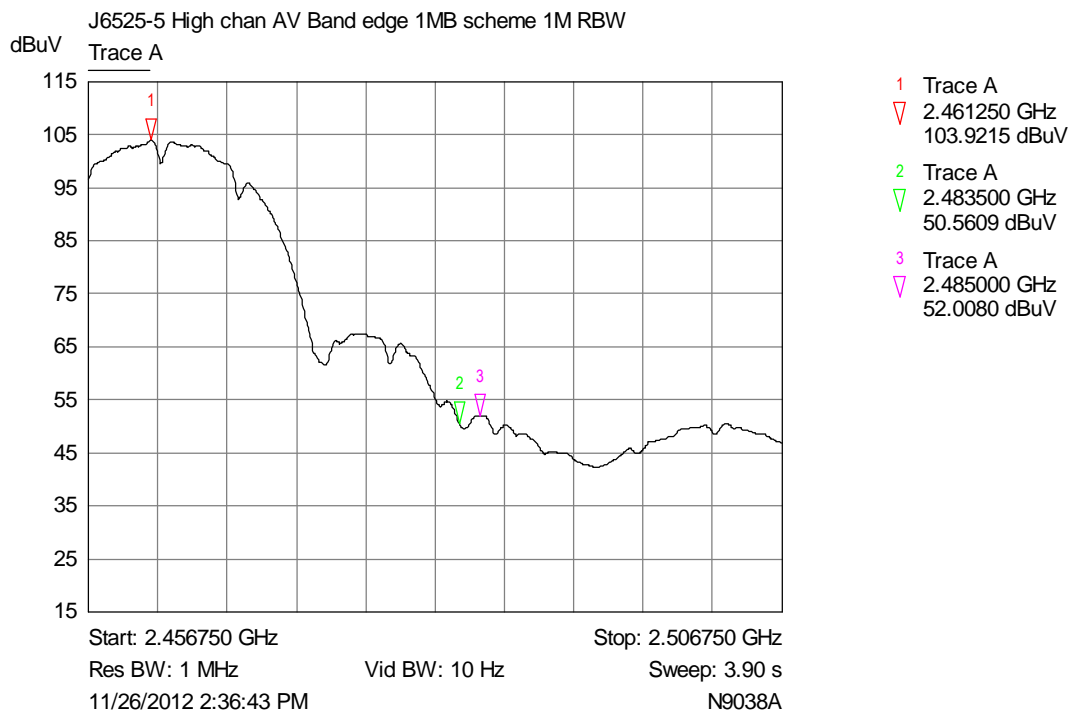
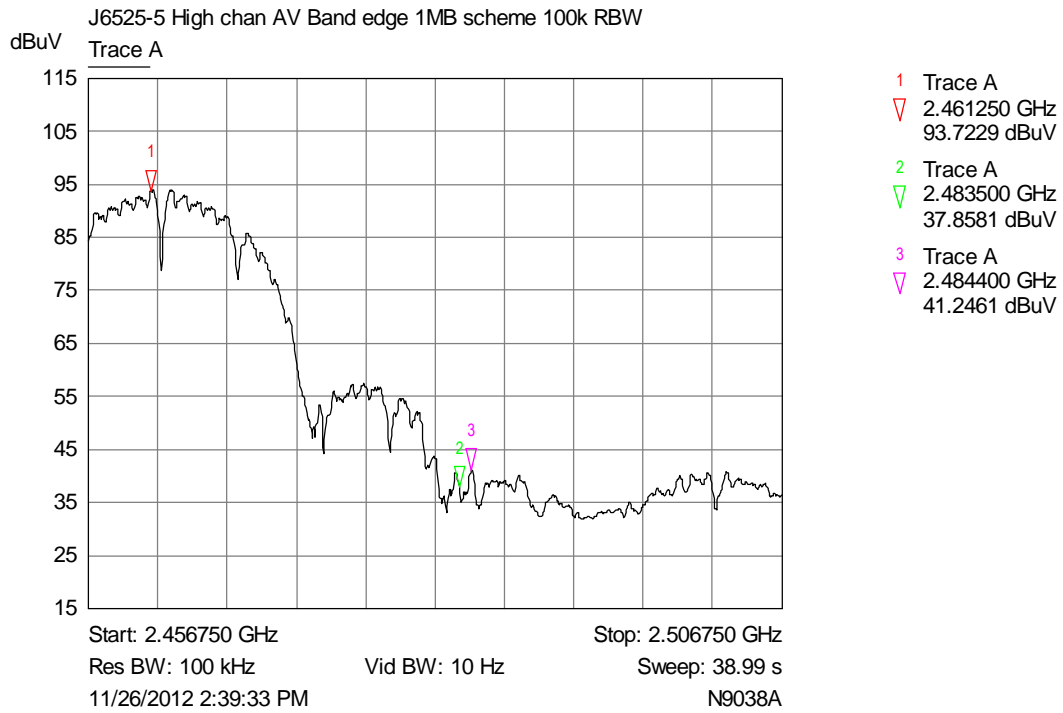

File name PURE.6525-5.DOCM

The contents of this report, apart from the referenced ANSI C63.4-2003, are beyond the scope of UKAS Testing Laboratory No. 2360 accreditation.

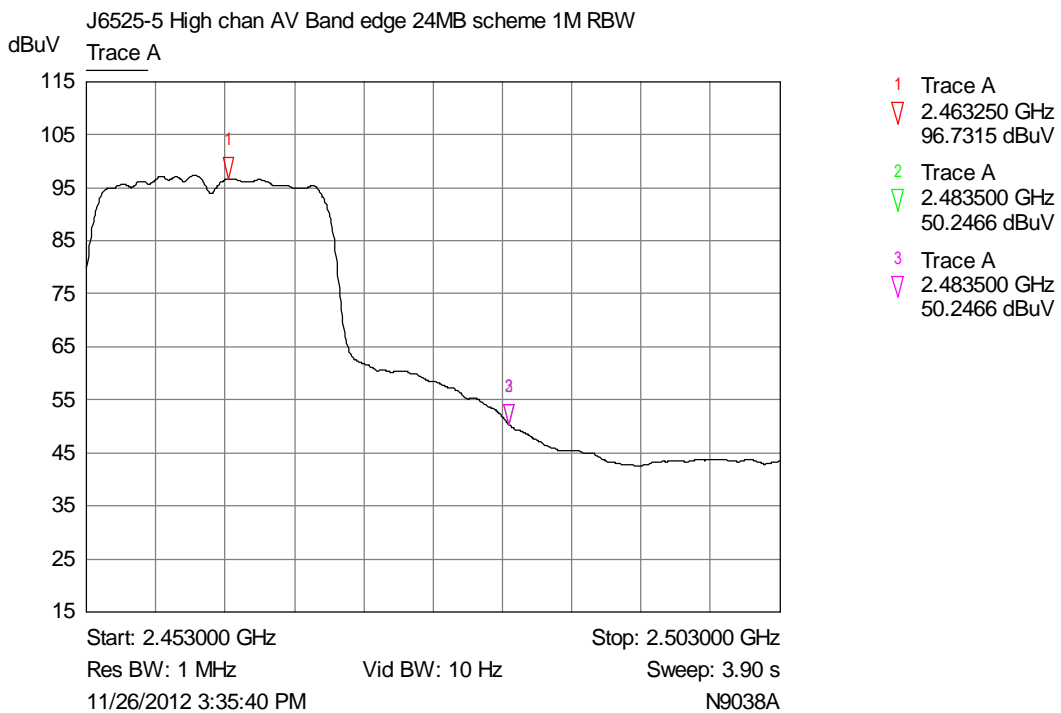
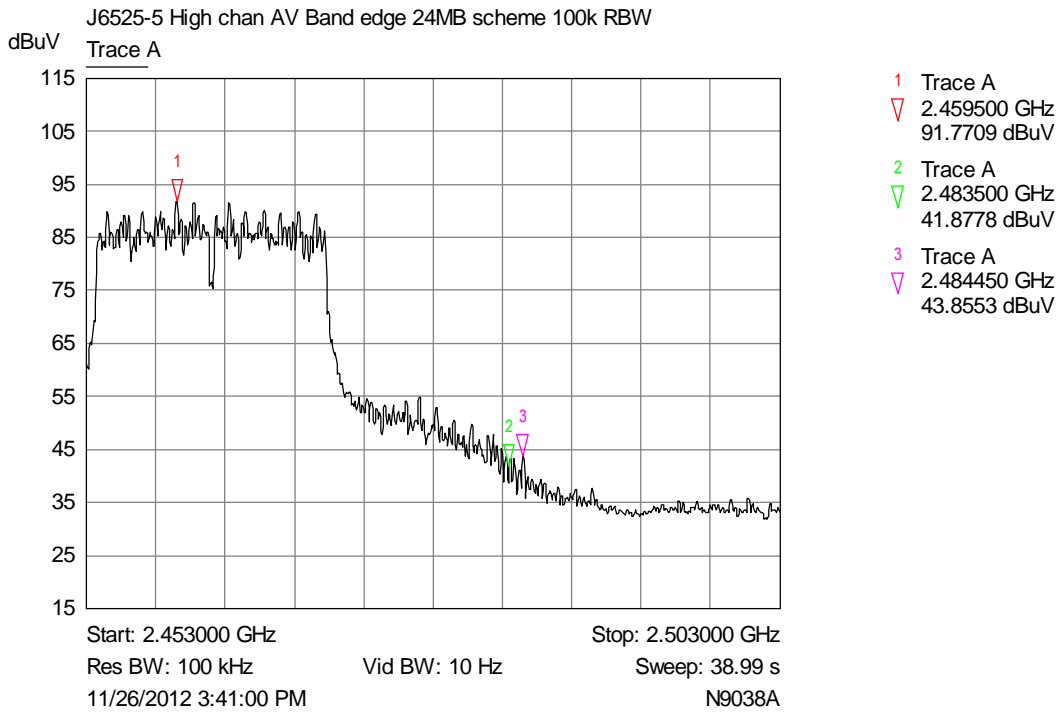

File name PURE.6525-5.DOCM

The contents of this report, apart from the referenced ANSI C63.4-2003, are beyond the scope of UKAS Testing Laboratory No. 2360 accreditation.

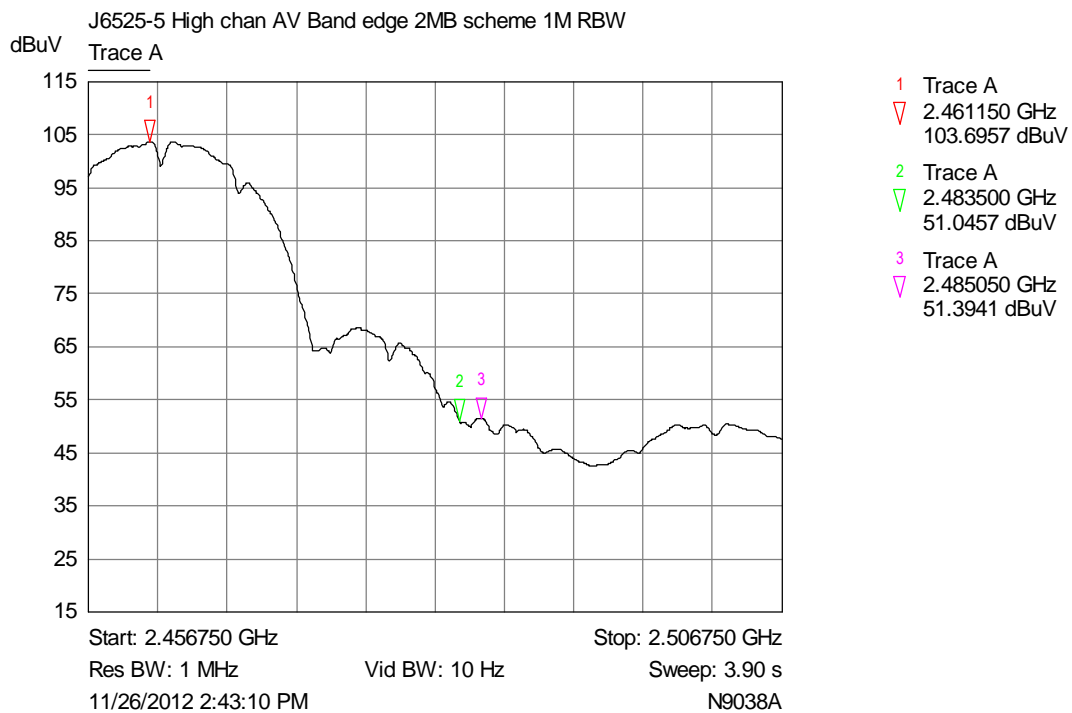
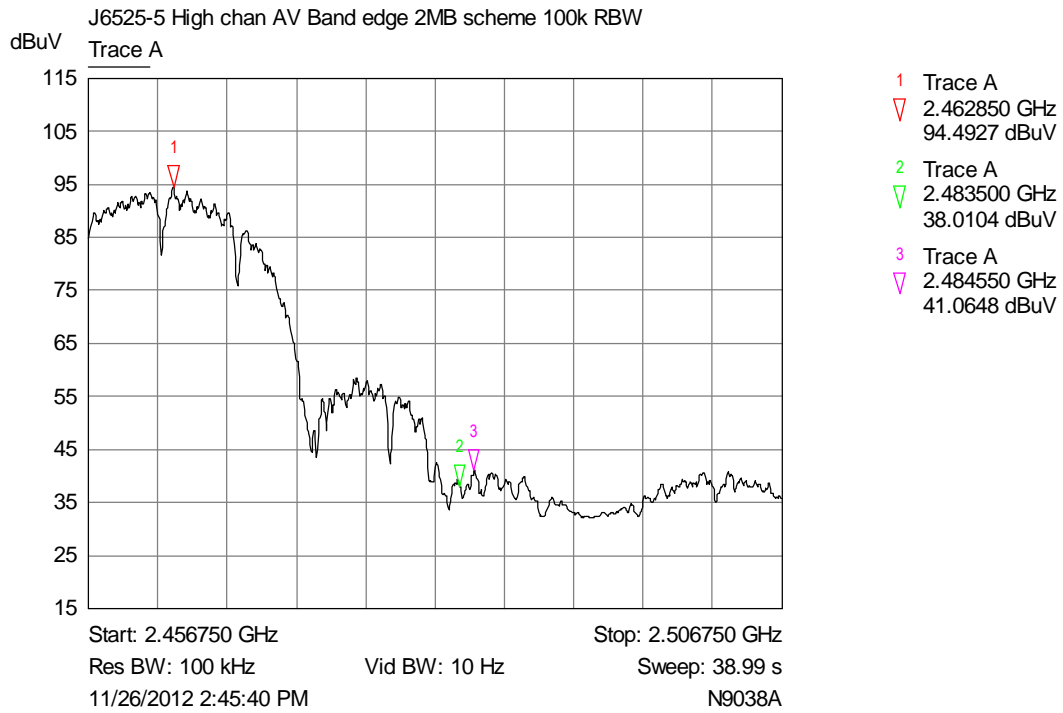

File name PURE.6525-5.DOCM

The contents of this report, apart from the referenced ANSI C63.4-2003, are beyond the scope of UKAS Testing Laboratory No. 2360 accreditation.

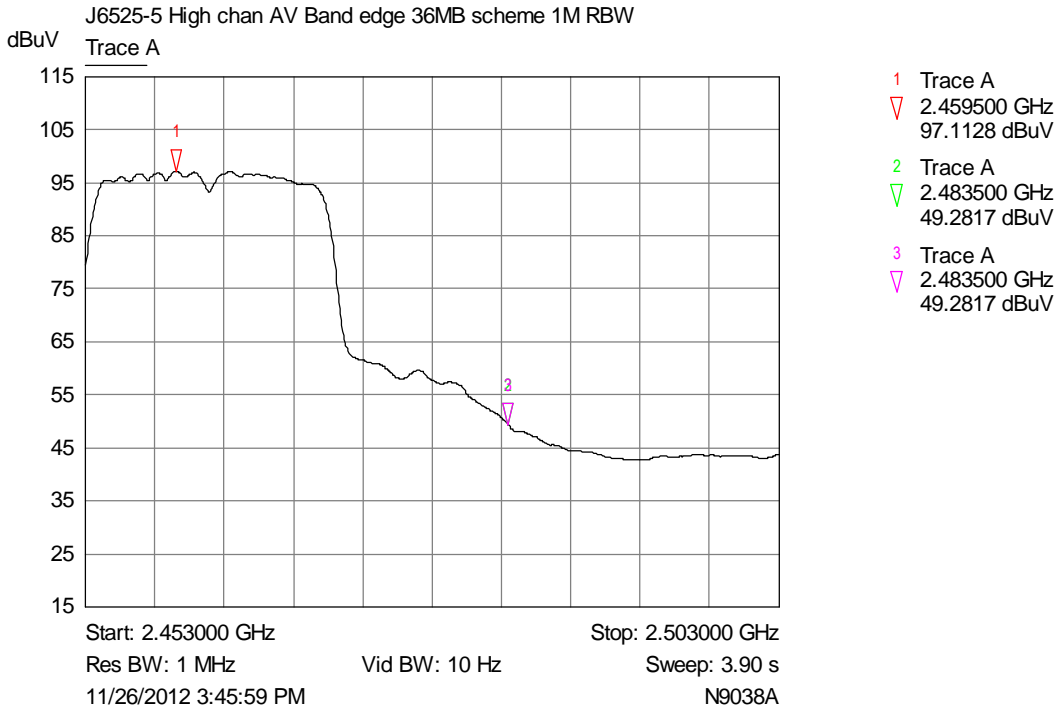
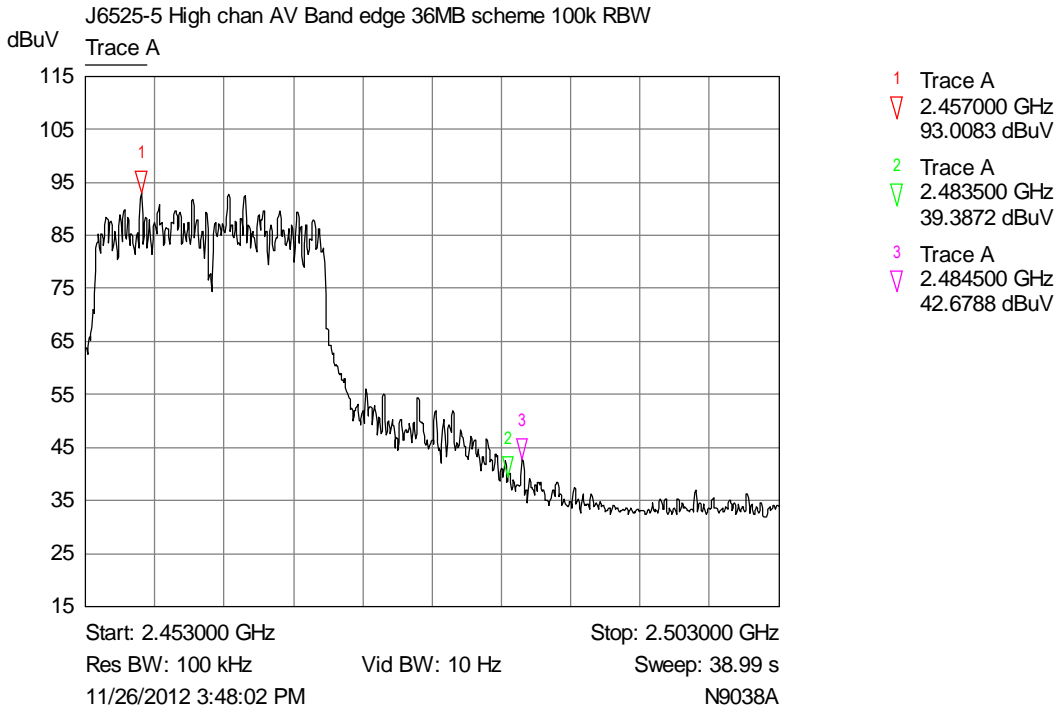

File name PURE.6525-5.DOCM

The contents of this report, apart from the referenced ANSI C63.4-2003, are beyond the scope of UKAS Testing Laboratory No. 2360 accreditation.

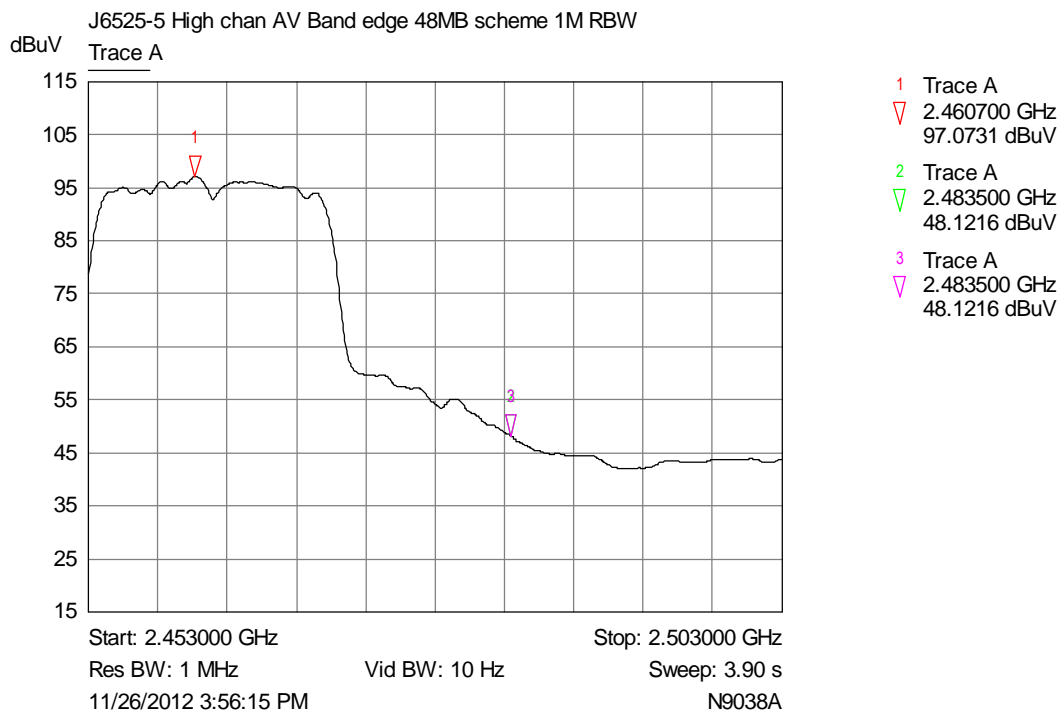
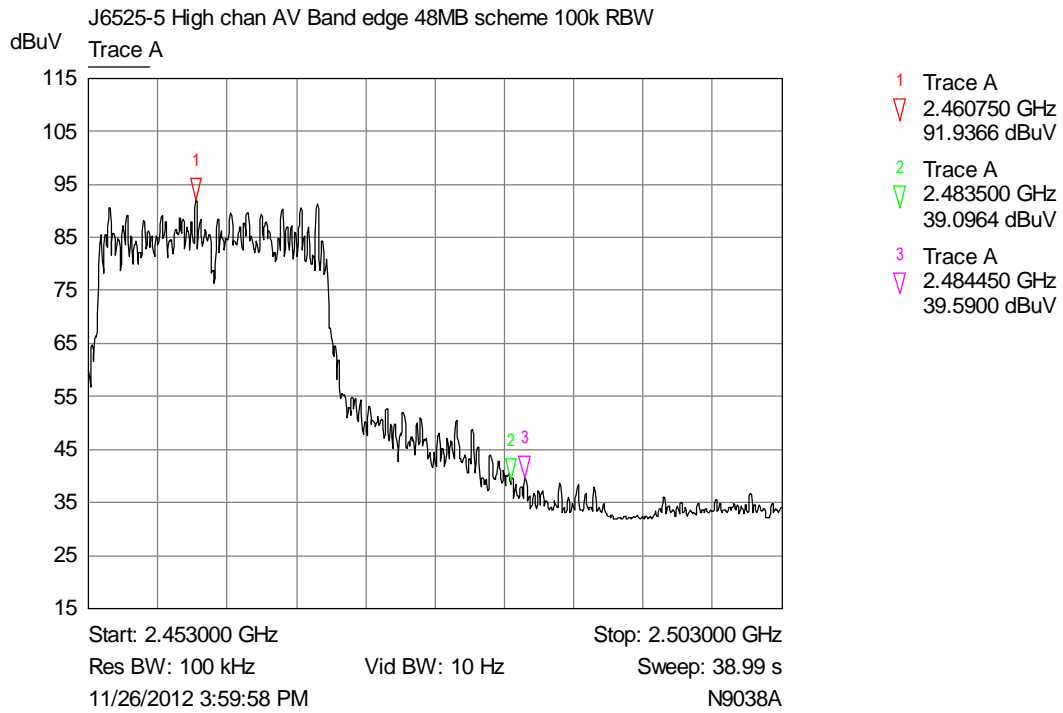

File name PURE.6525-5.DOCM

The contents of this report, apart from the referenced ANSI C63.4-2003, are beyond the scope of UKAS Testing Laboratory No. 2360 accreditation.

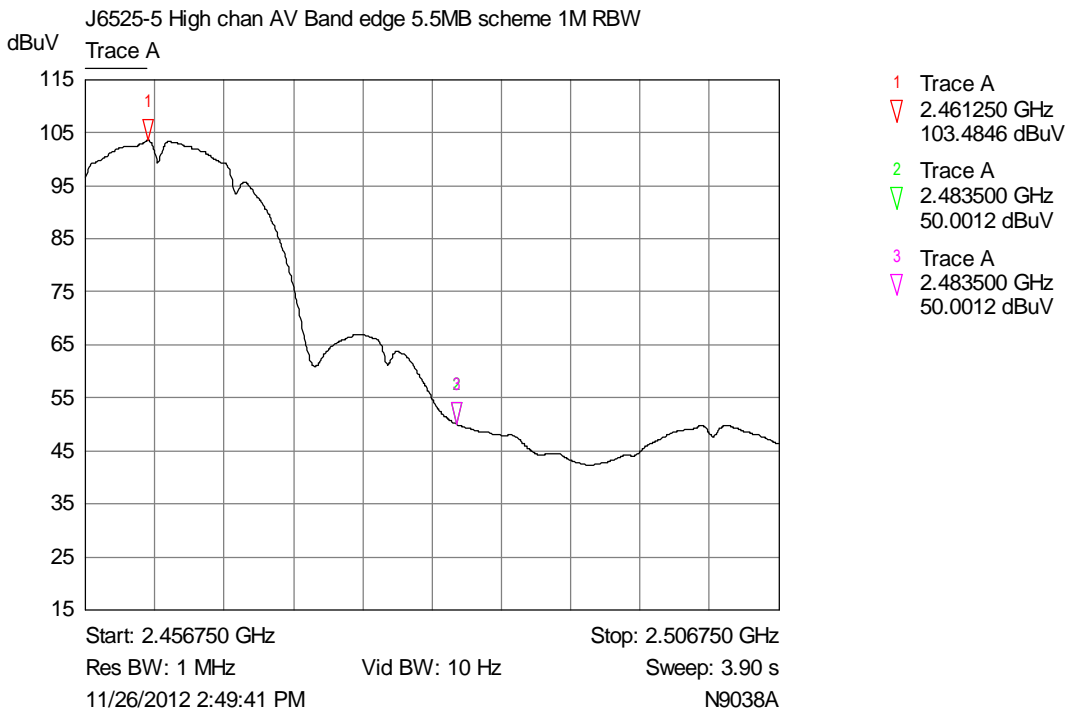
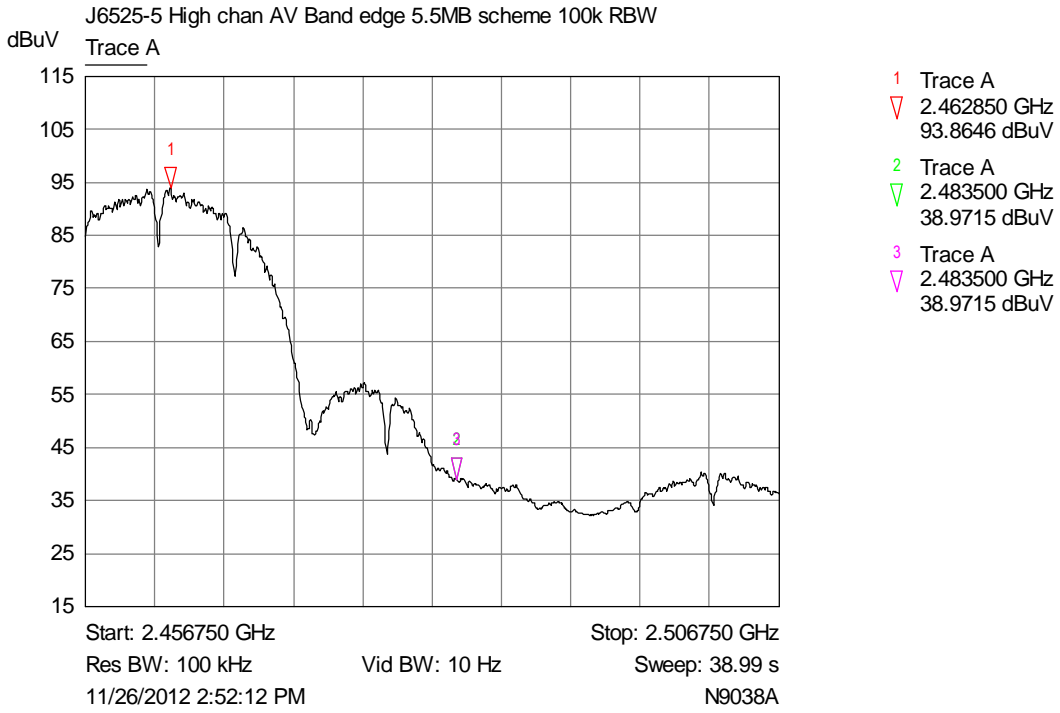

File name PURE.6525-5.DOCM

The contents of this report, apart from the referenced ANSI C63.4-2003, are beyond the scope of UKAS Testing Laboratory No. 2360 accreditation.

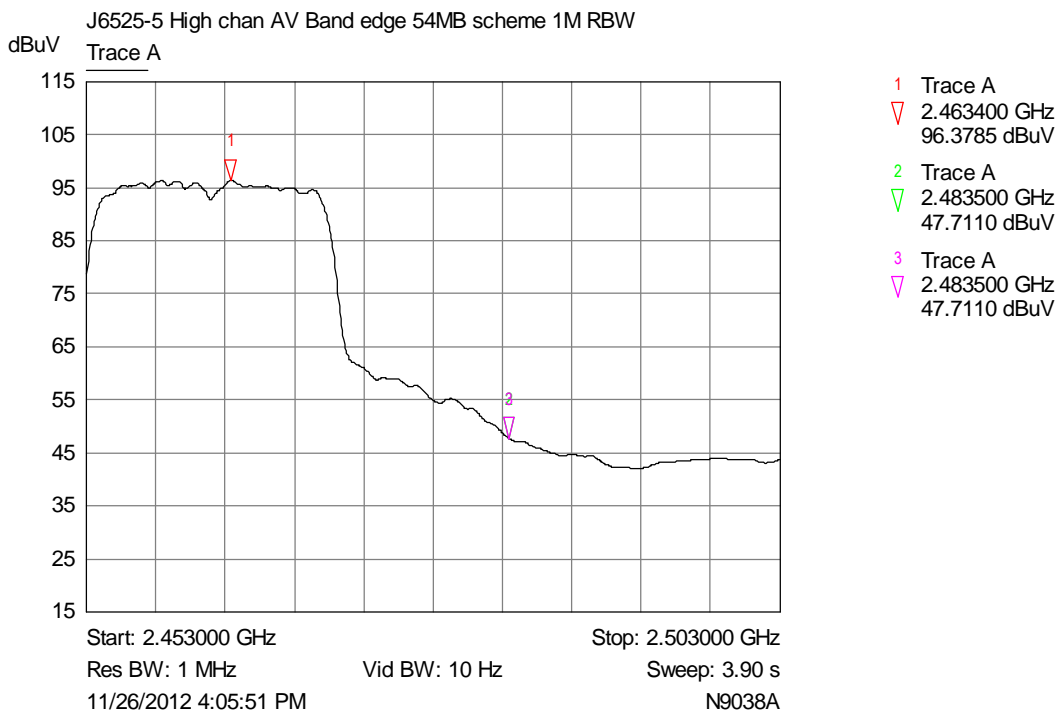
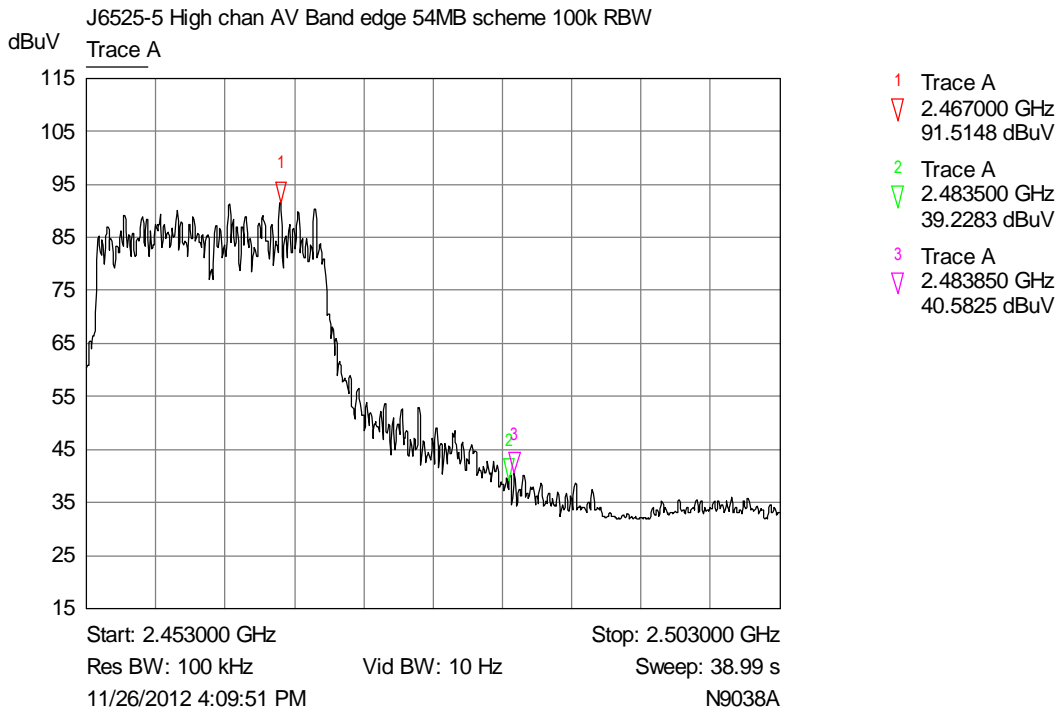

File name PURE.6525-5.DOCM

The contents of this report, apart from the referenced ANSI C63.4-2003, are beyond the scope of UKAS Testing Laboratory No. 2360 accreditation.

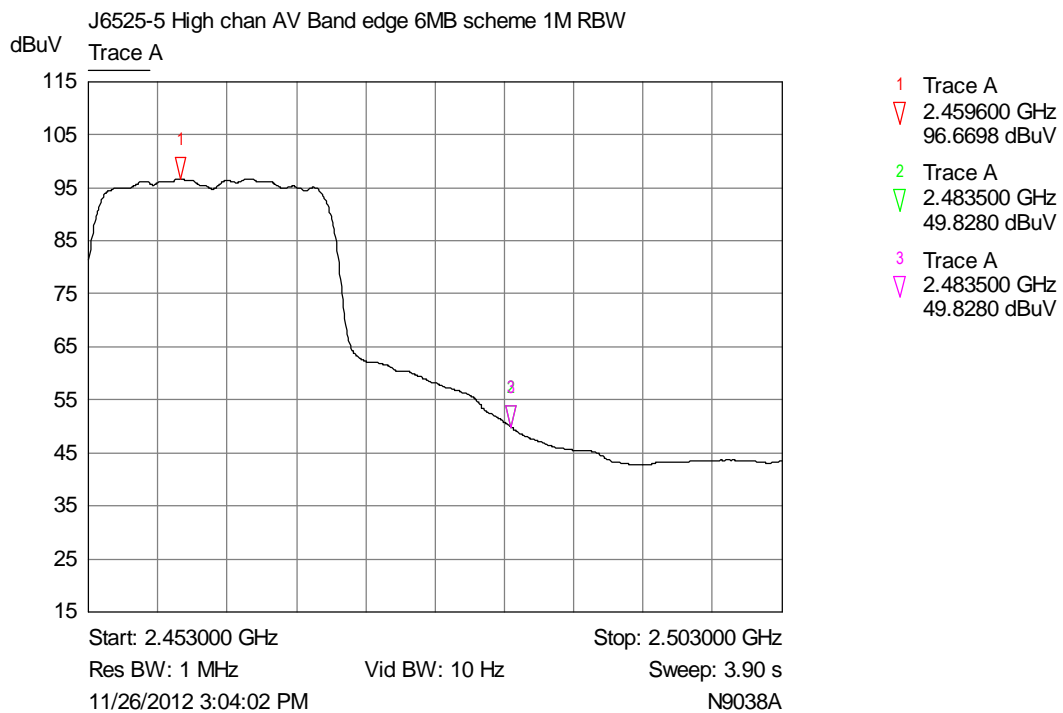
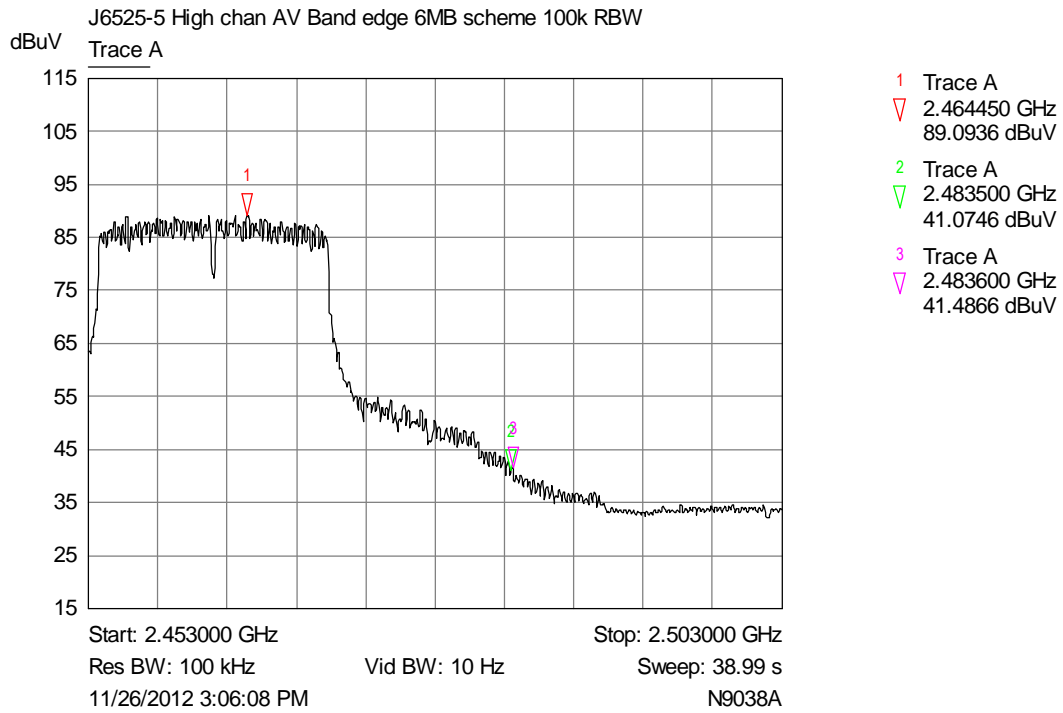

File name PURE.6525-5.DOCM

The contents of this report, apart from the referenced ANSI C63.4-2003, are beyond the scope of UKAS Testing Laboratory No. 2360 accreditation.

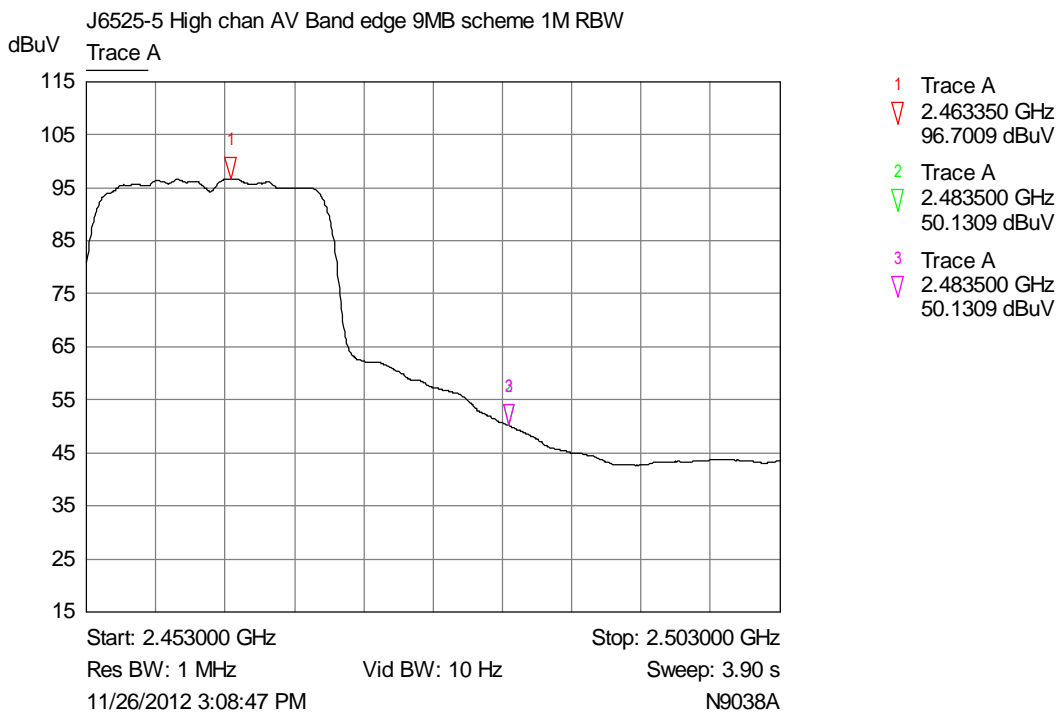
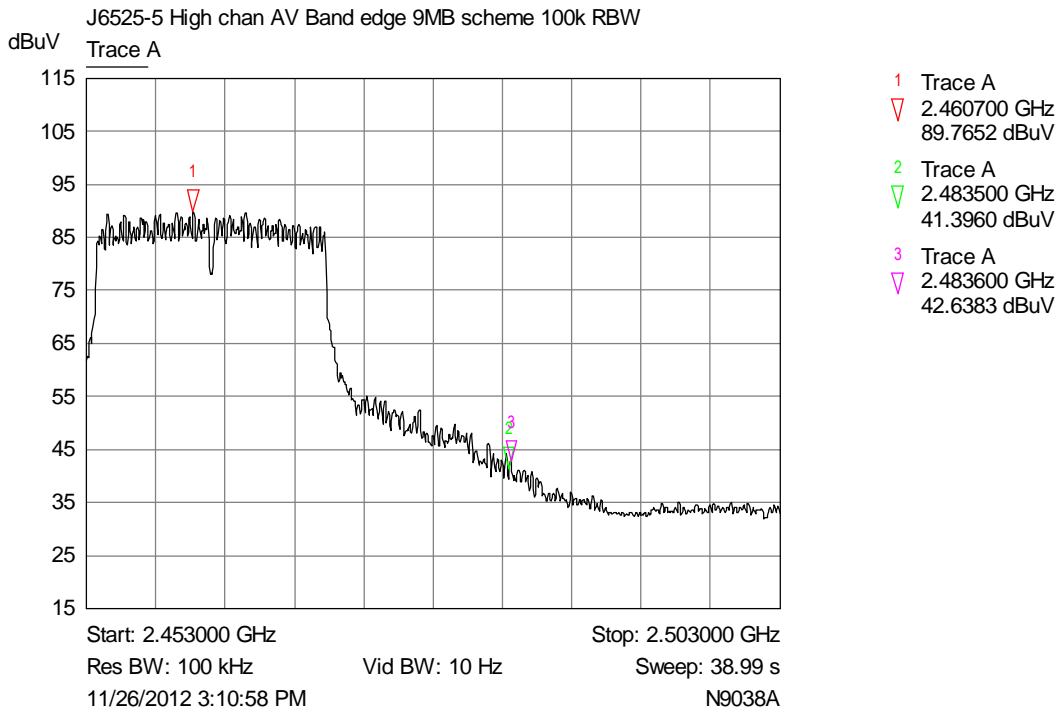

File name PURE.6525-5.DOCM

The contents of this report, apart from the referenced ANSI C63.4-2003, are beyond the scope of UKAS Testing Laboratory No. 2360 accreditation.

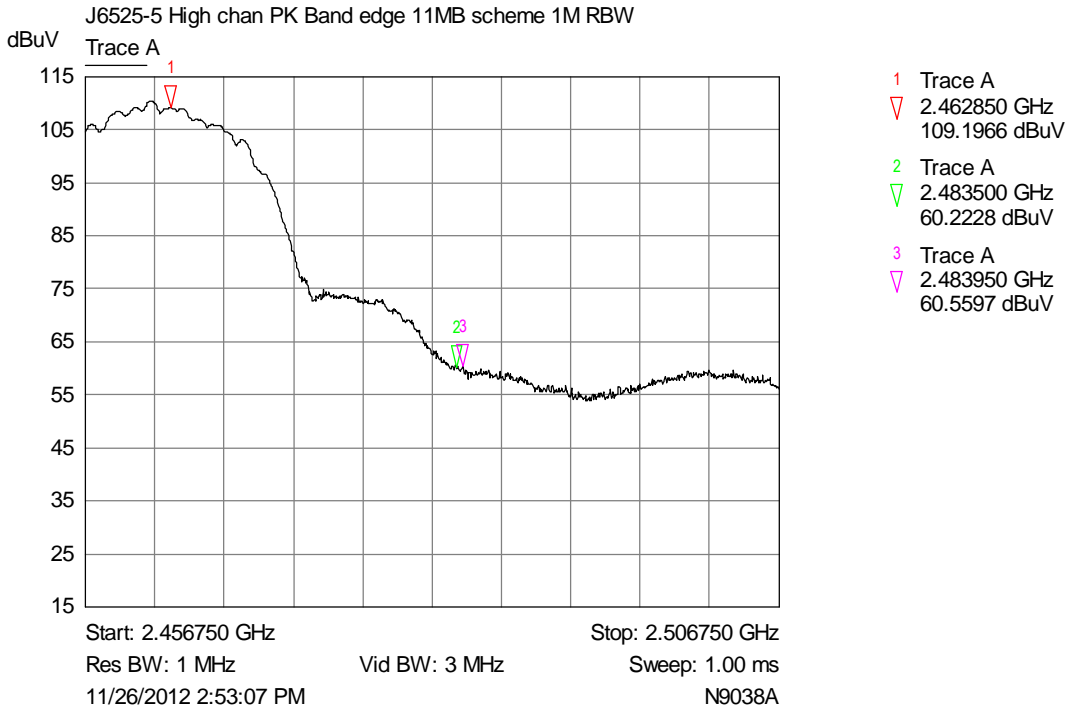
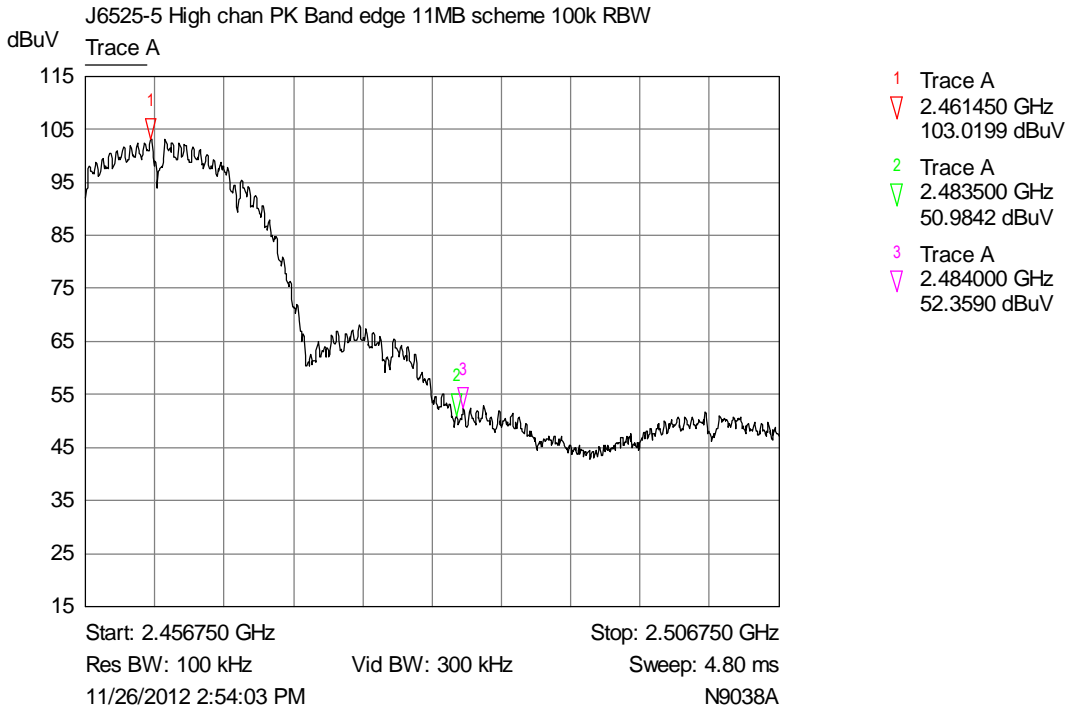

File name PURE.6525-5.DOCM

The contents of this report, apart from the referenced ANSI C63.4-2003, are beyond the scope of UKAS Testing Laboratory No. 2360 accreditation.

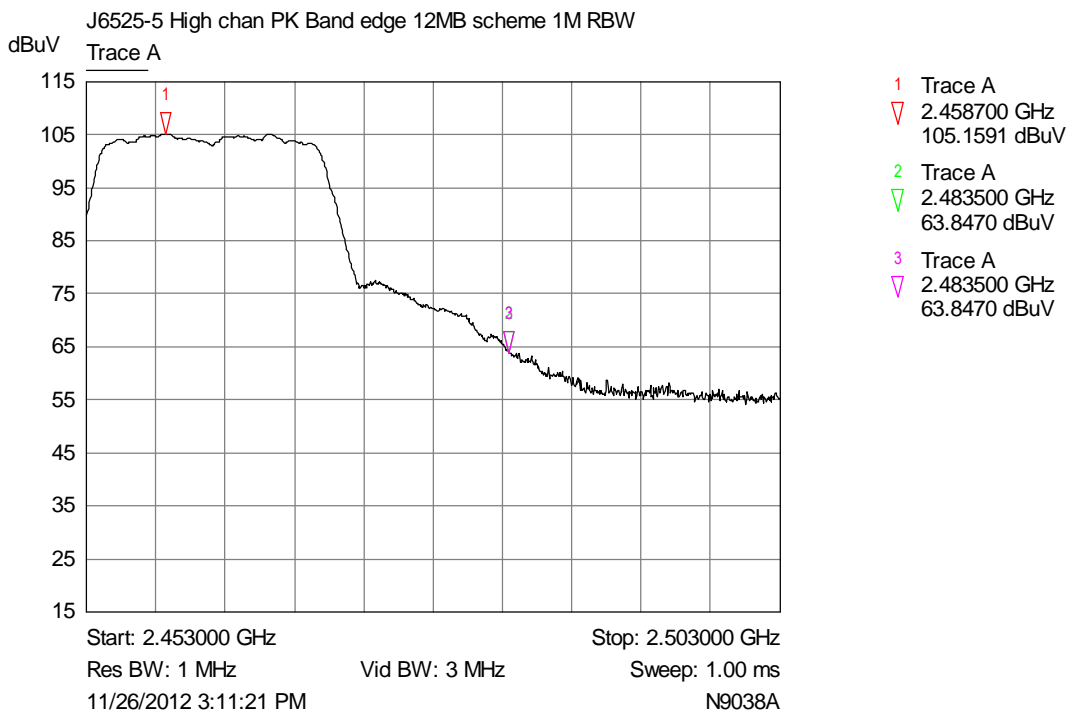
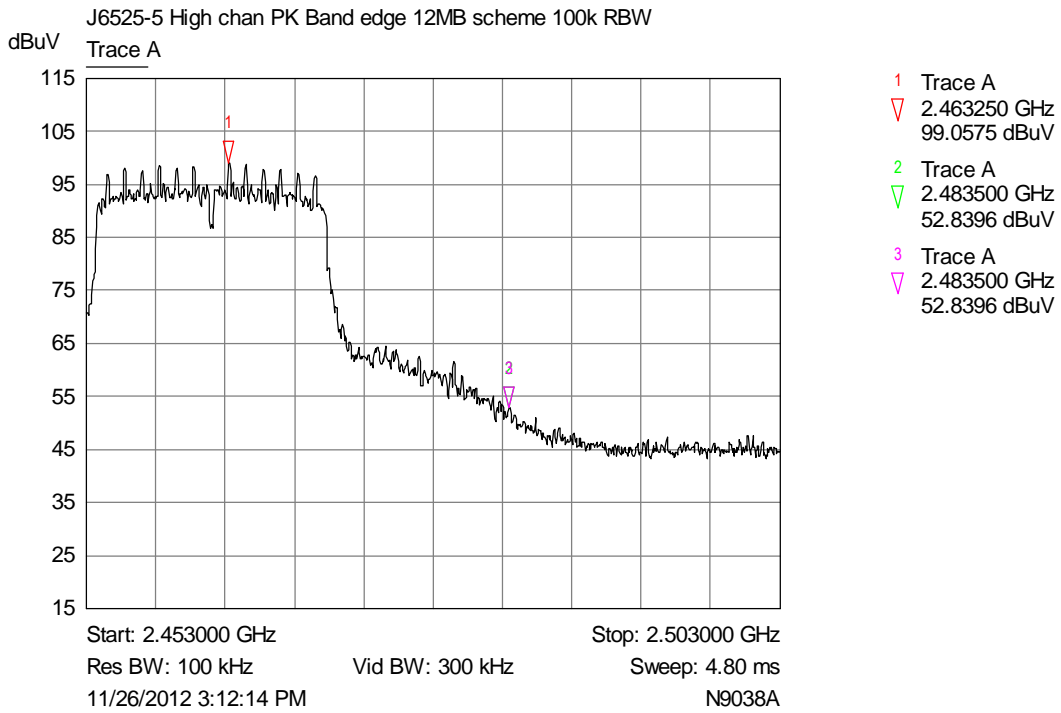

File name PURE.6525-5.DOCM

The contents of this report, apart from the referenced ANSI C63.4-2003, are beyond the scope of UKAS Testing Laboratory No. 2360 accreditation.

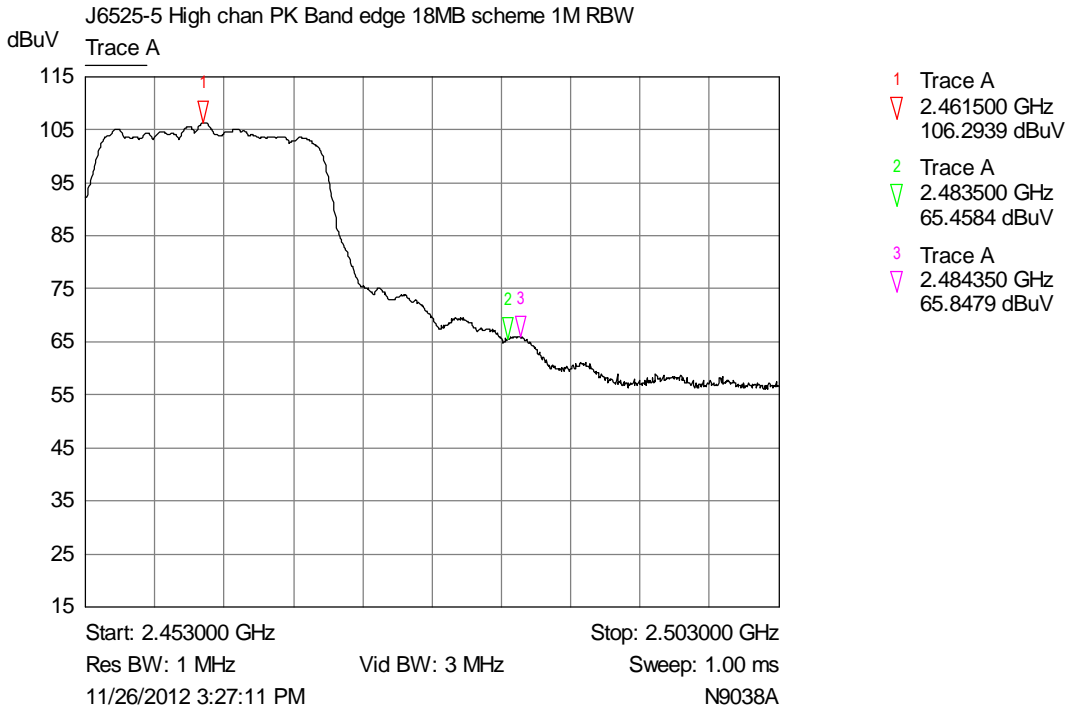
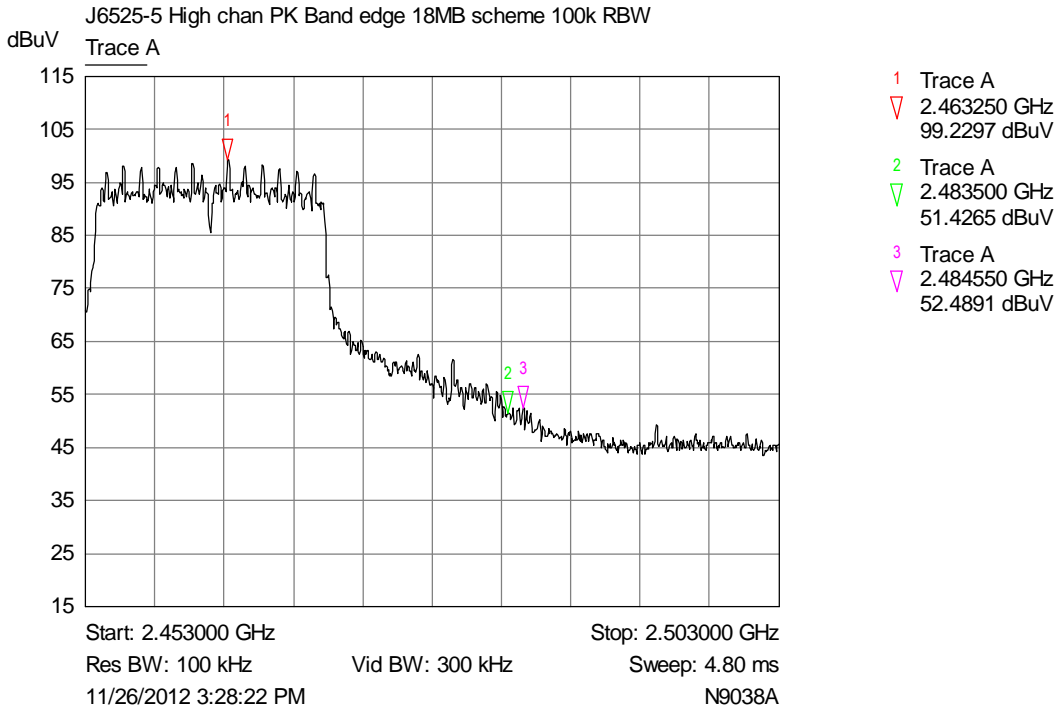

File name PURE.6525-5.DOCM

The contents of this report, apart from the referenced ANSI C63.4-2003, are beyond the scope of UKAS Testing Laboratory No. 2360 accreditation.

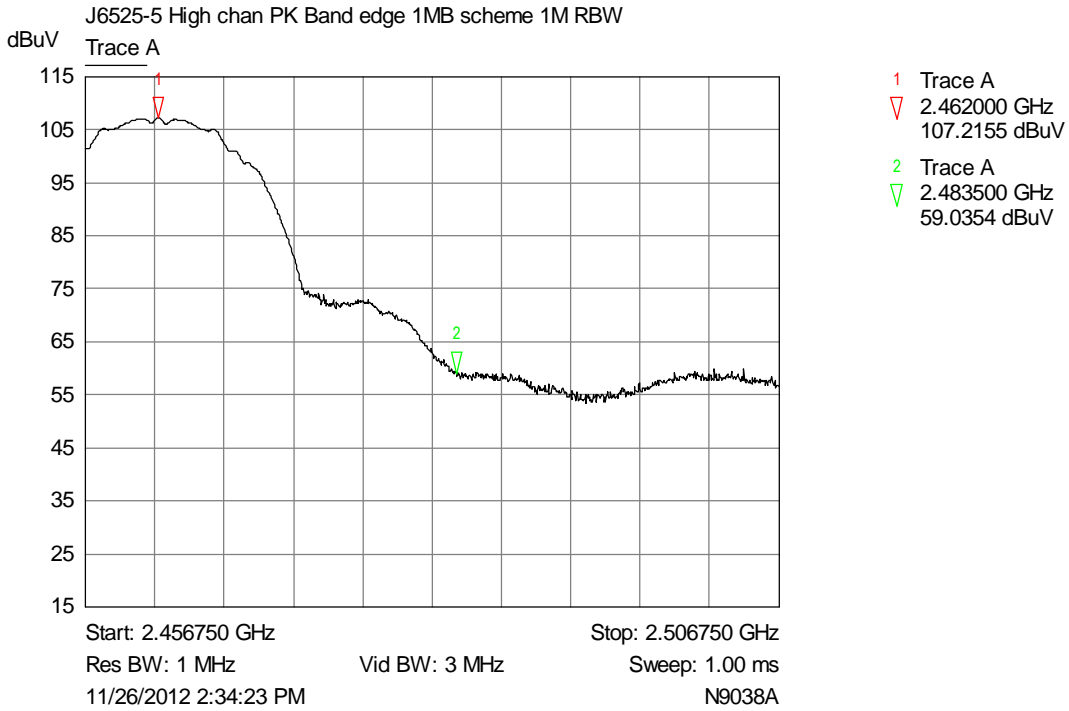
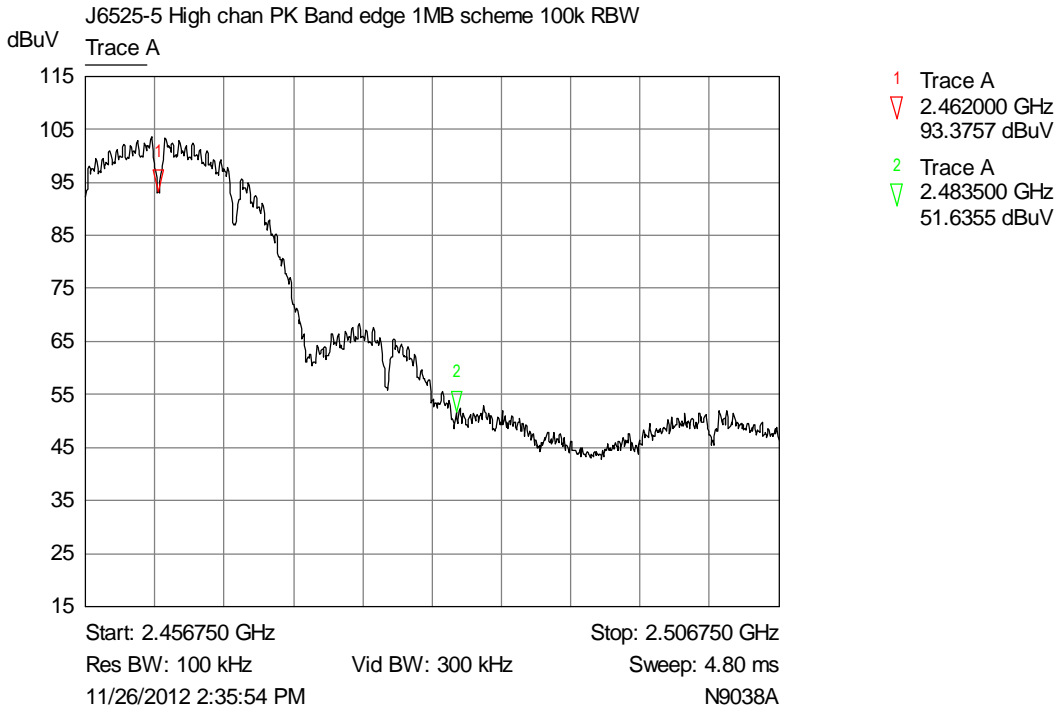

File name PURE.6525-5.DOCM

The contents of this report, apart from the referenced ANSI C63.4-2003, are beyond the scope of UKAS Testing Laboratory No. 2360 accreditation.

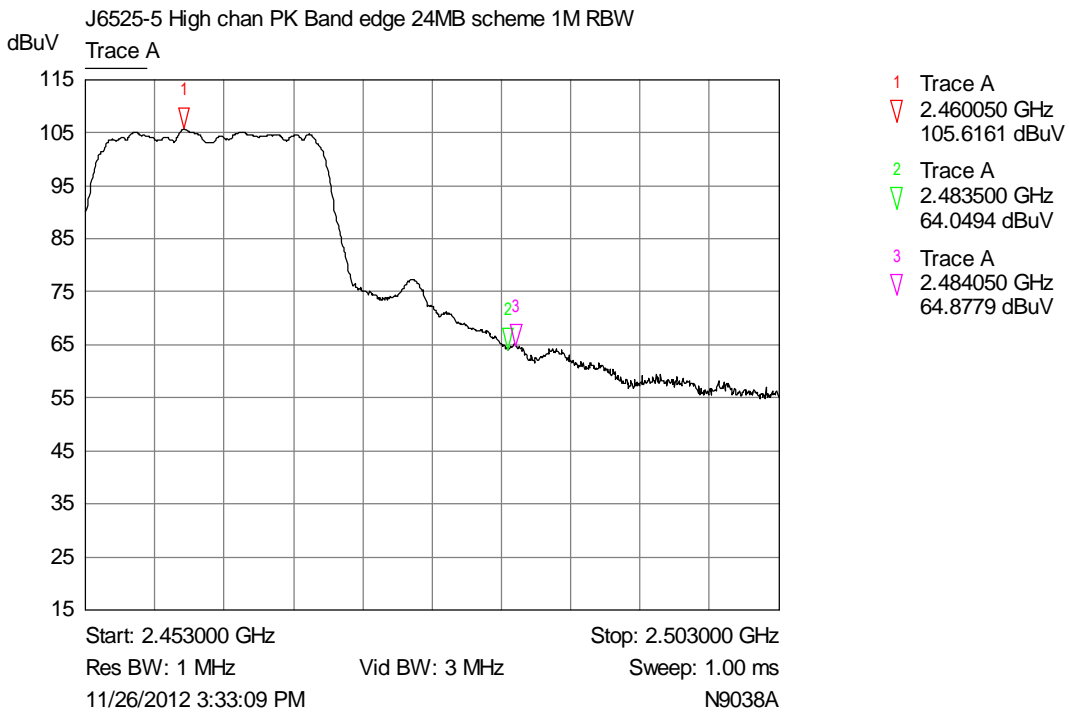
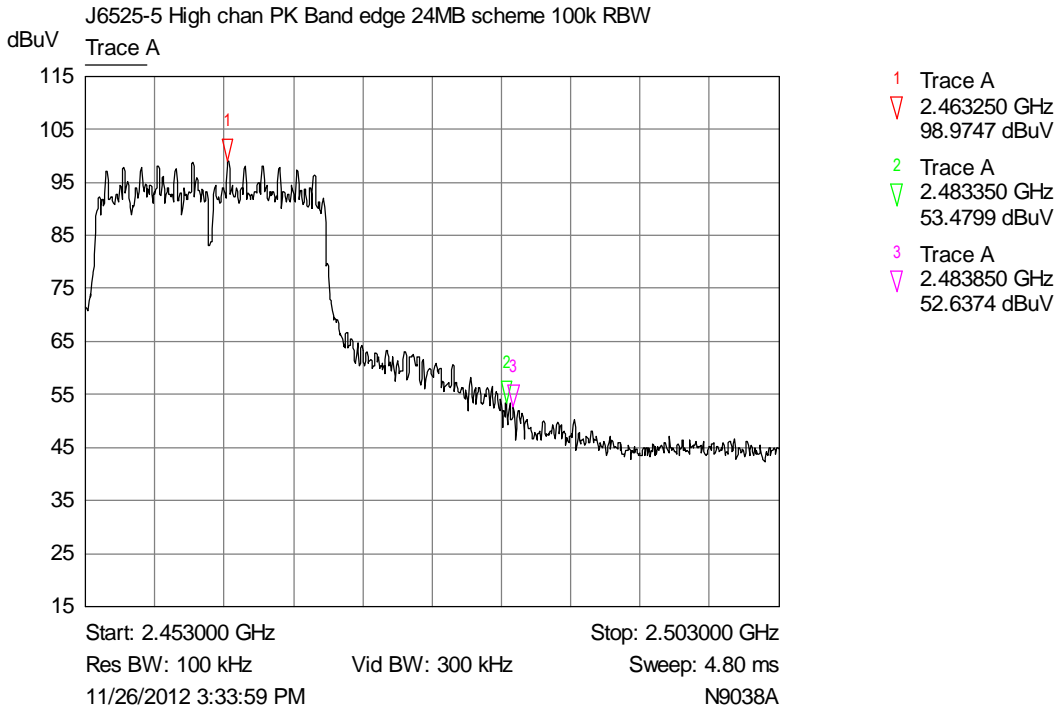

File name PURE.6525-5.DOCM

The contents of this report, apart from the referenced ANSI C63.4-2003, are beyond the scope of UKAS Testing Laboratory No. 2360 accreditation.

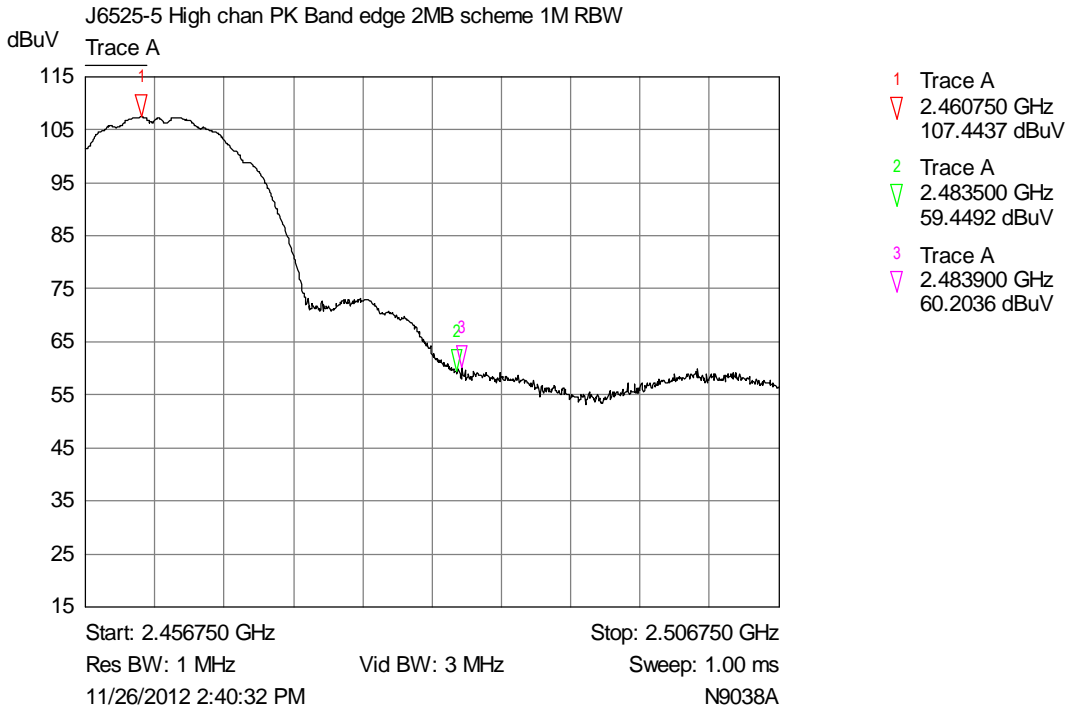
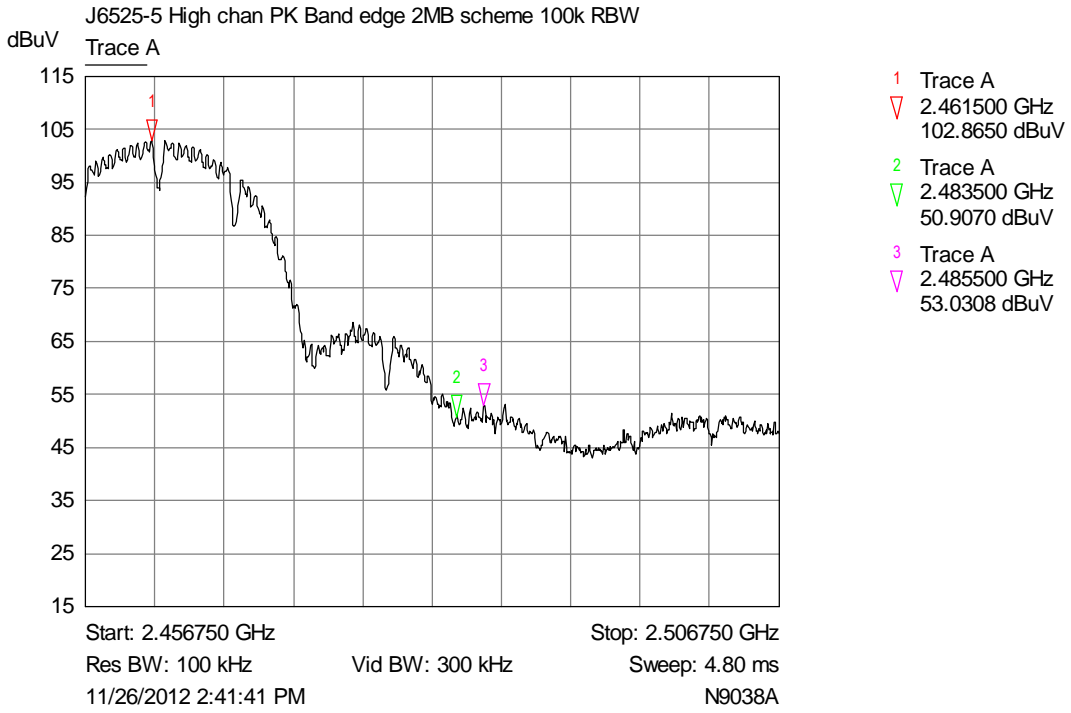

File name PURE.6525-5.DOCM

The contents of this report, apart from the referenced ANSI C63.4-2003, are beyond the scope of UKAS Testing Laboratory No. 2360 accreditation.

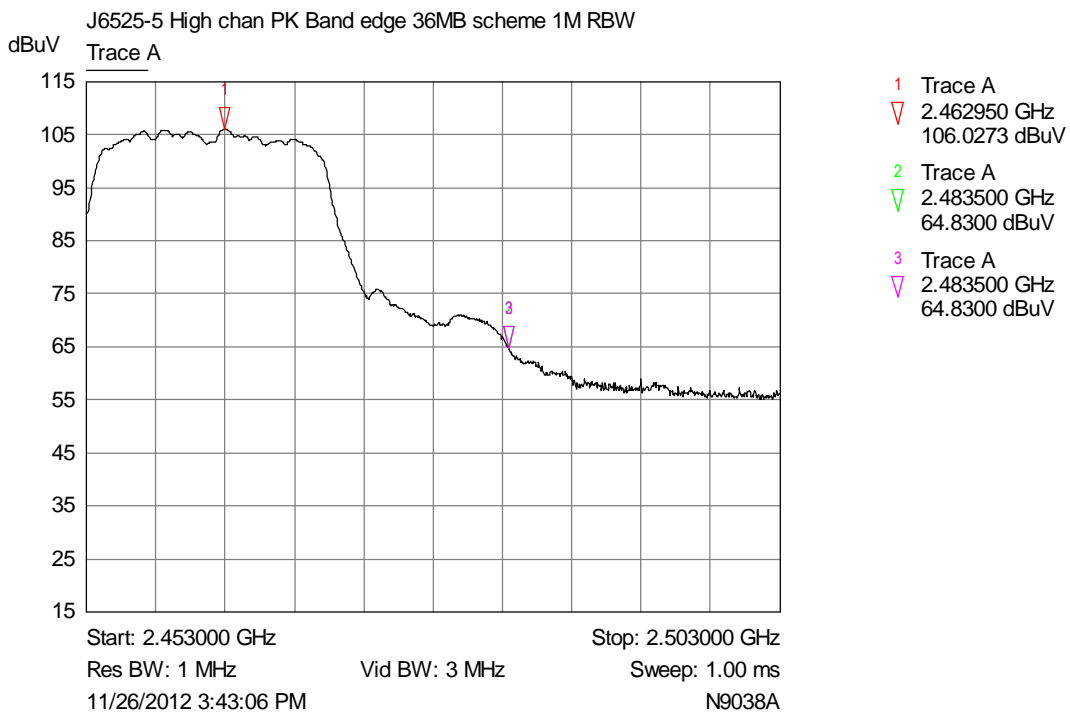
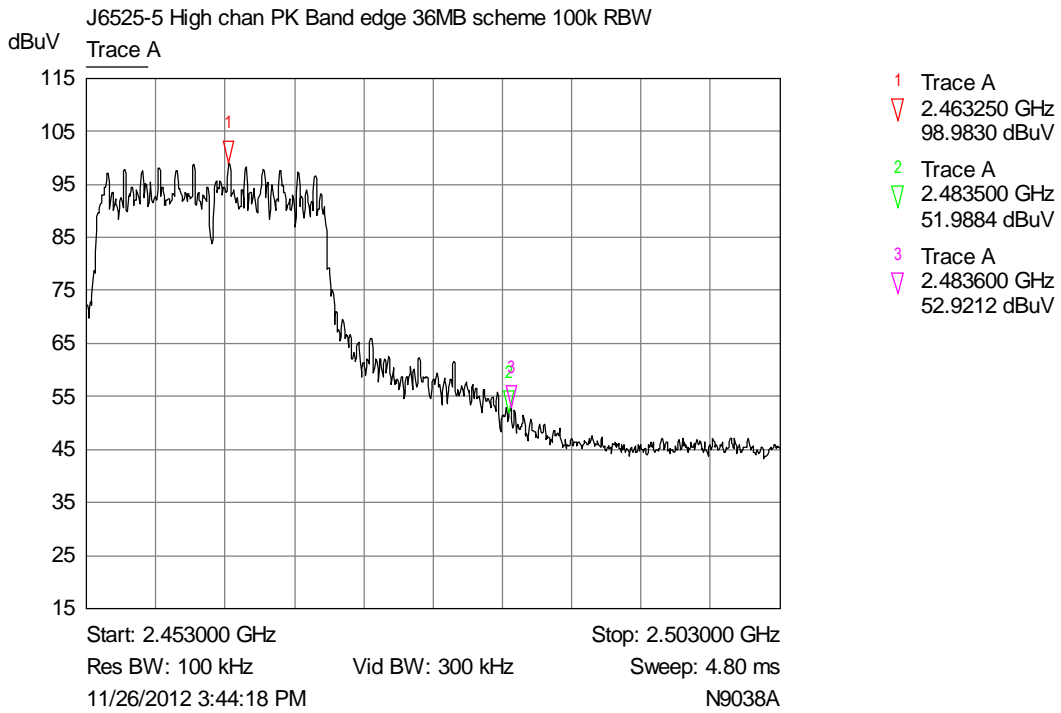

File name PURE.6525-5.DOCM

The contents of this report, apart from the referenced ANSI C63.4-2003, are beyond the scope of UKAS Testing Laboratory No. 2360 accreditation.

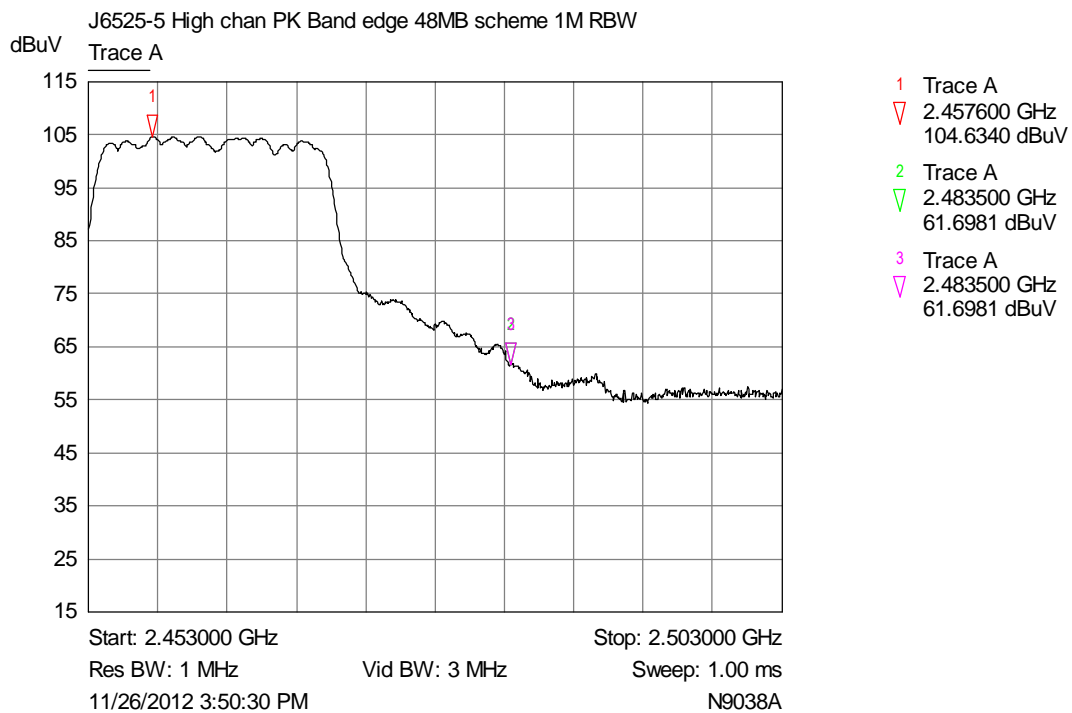
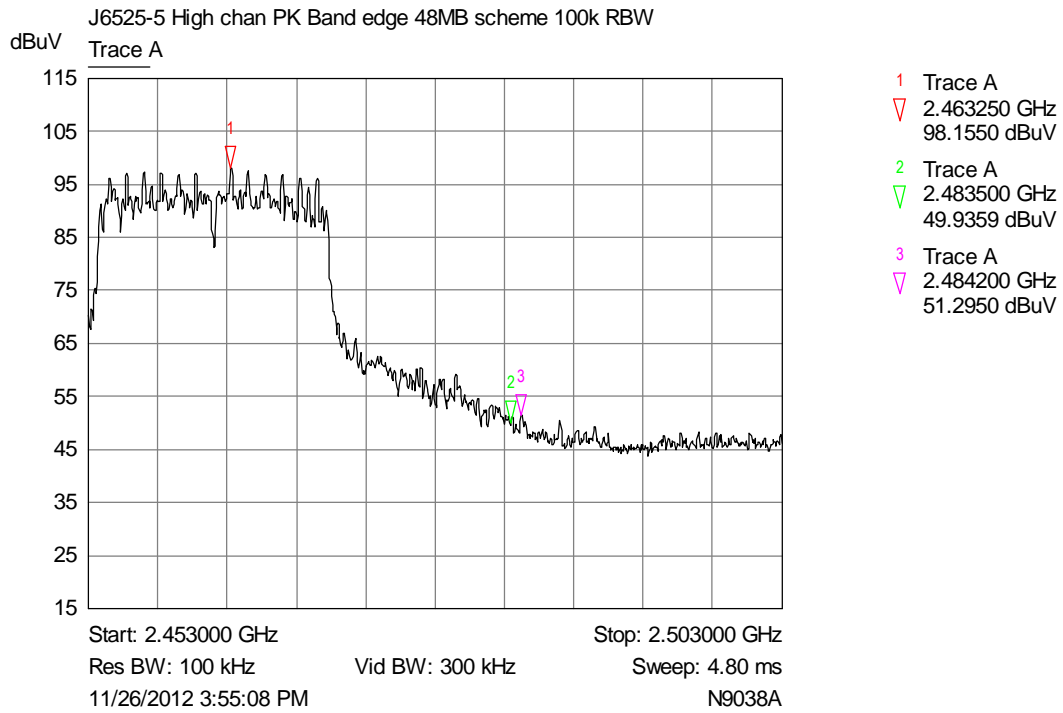

File name PURE.6525-5.DOCM

The contents of this report, apart from the referenced ANSI C63.4-2003, are beyond the scope of UKAS Testing Laboratory No. 2360 accreditation.

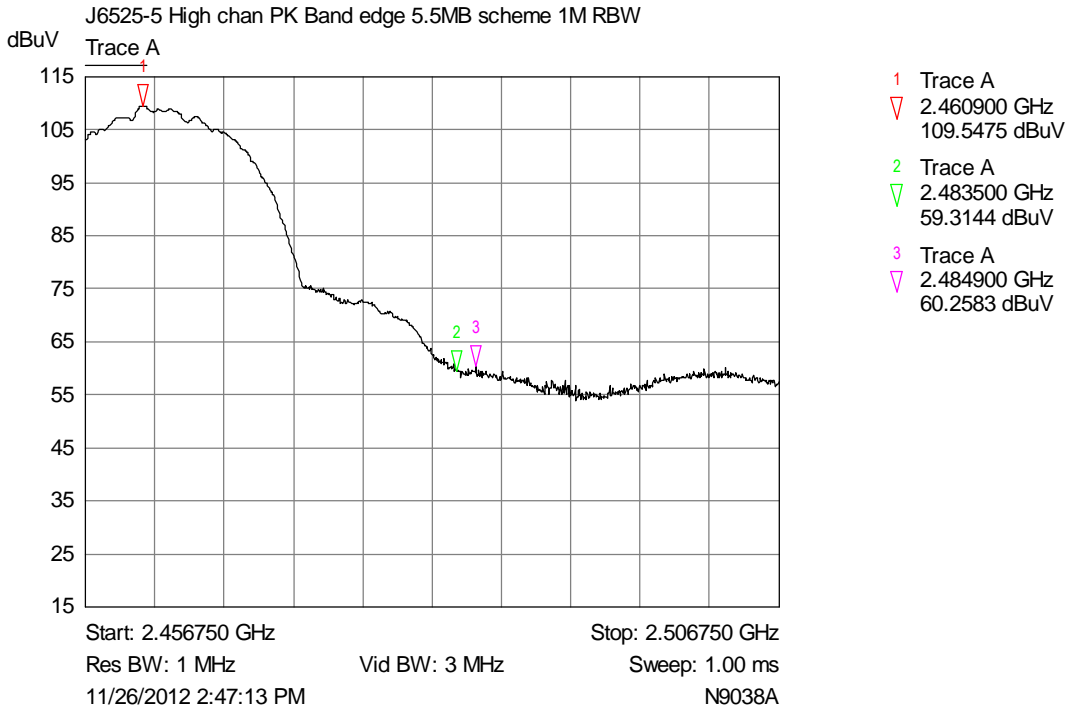
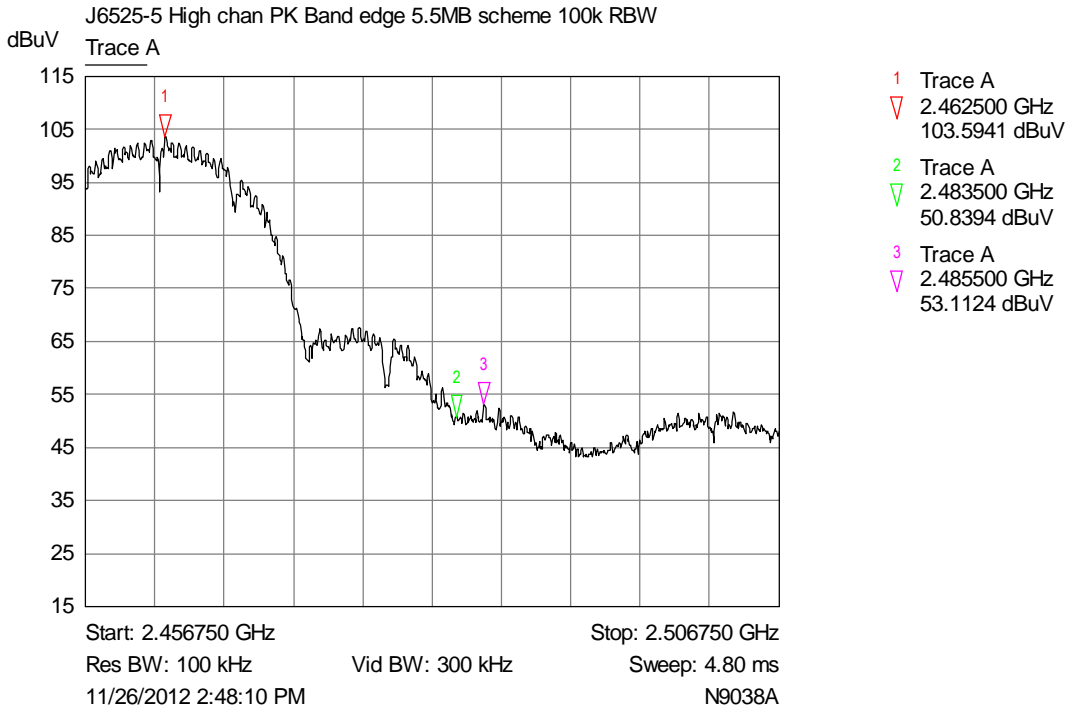

File name PURE.6525-5.DOCM

The contents of this report, apart from the referenced ANSI C63.4-2003, are beyond the scope of UKAS Testing Laboratory No. 2360 accreditation.

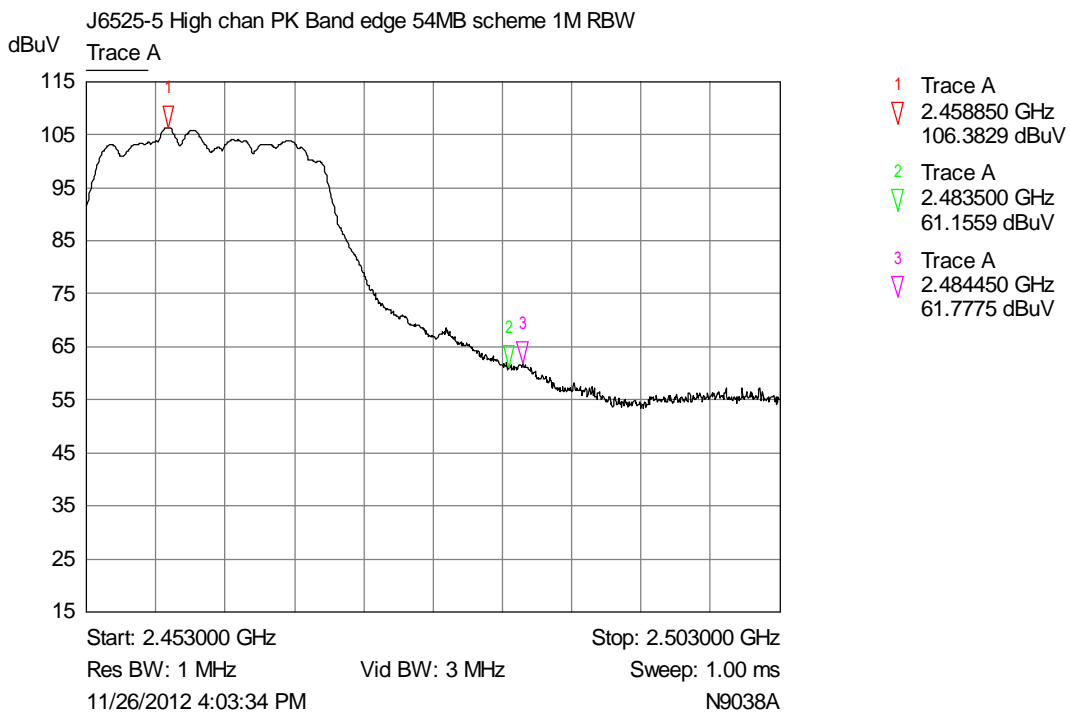
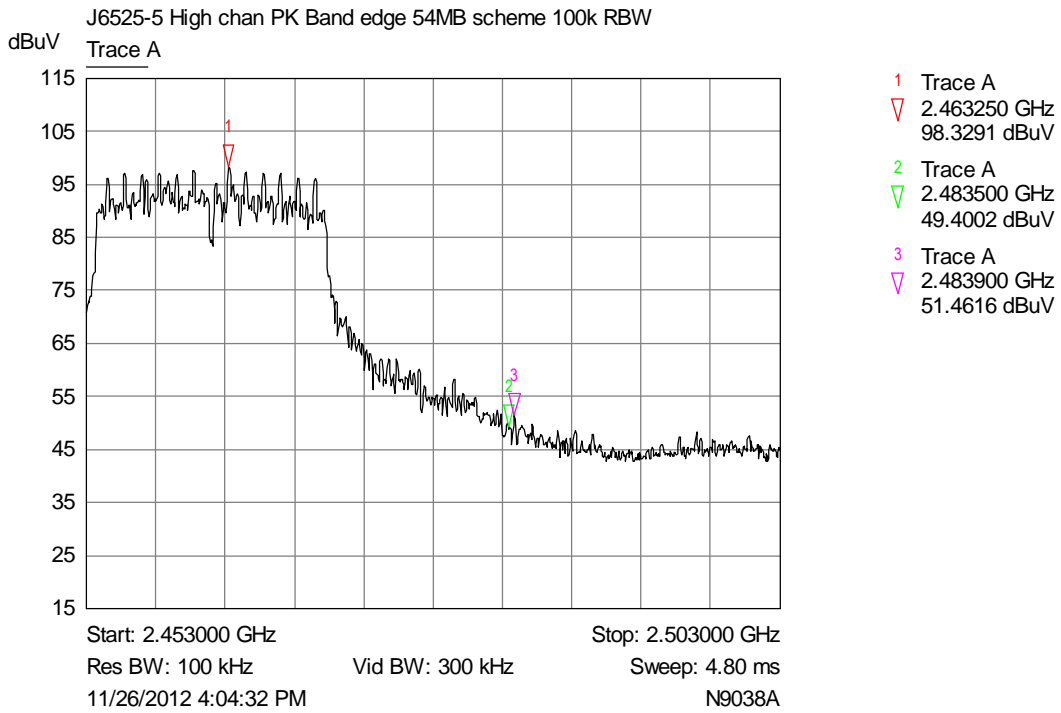

File name PURE.6525-5.DOCM

The contents of this report, apart from the referenced ANSI C63.4-2003, are beyond the scope of UKAS Testing Laboratory No. 2360 accreditation.

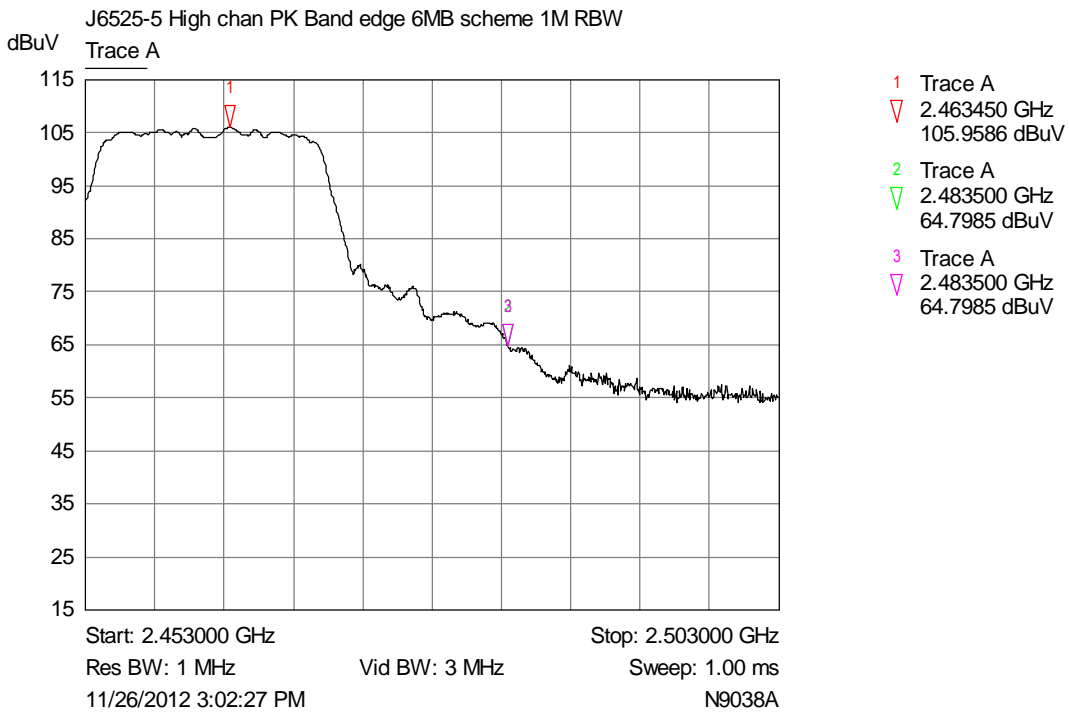
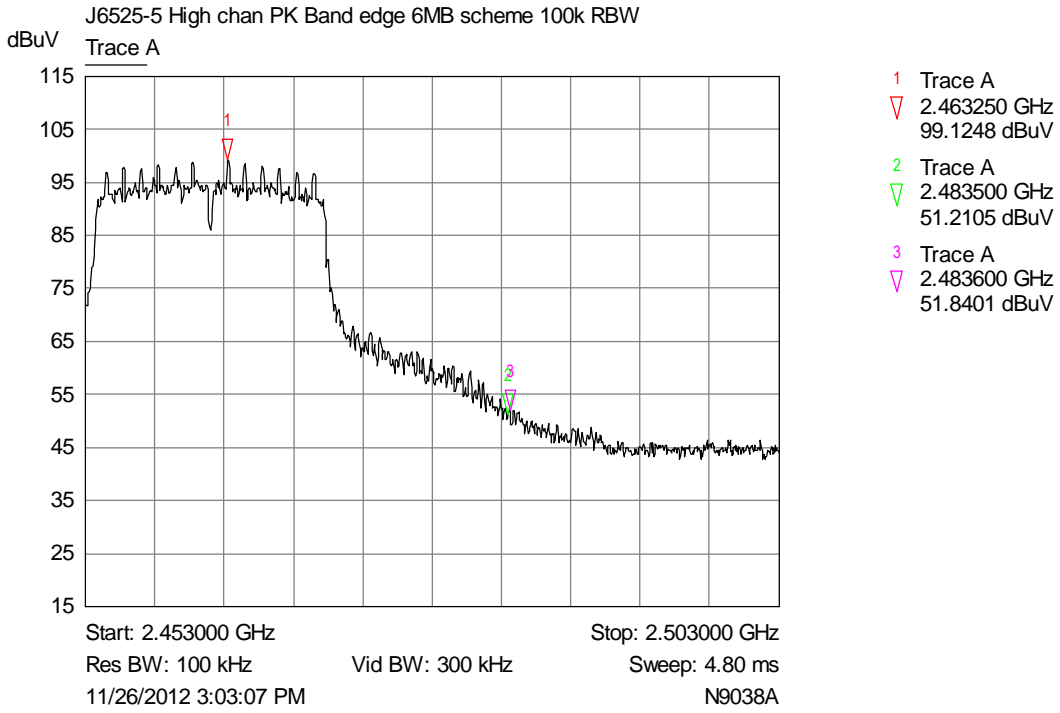

File name PURE.6525-5.DOCM

The contents of this report, apart from the referenced ANSI C63.4-2003, are beyond the scope of UKAS Testing Laboratory No. 2360 accreditation.

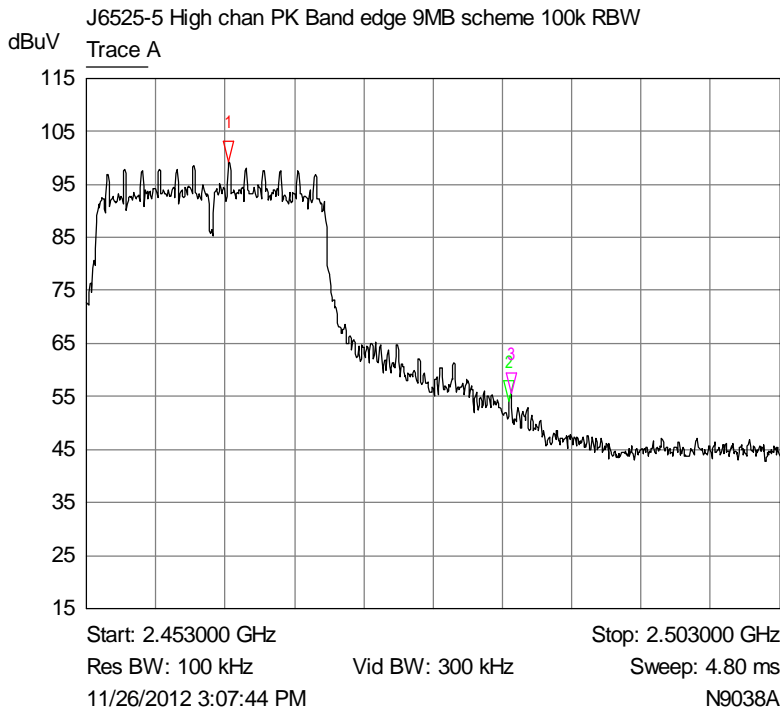

- 1 Trace A
2.463250 GHz
99.1112 dBuV
- 2 Trace A
2.483500 GHz
53.9521 dBuV
- 3 Trace A
2.483600 GHz
55.5007 dBuV

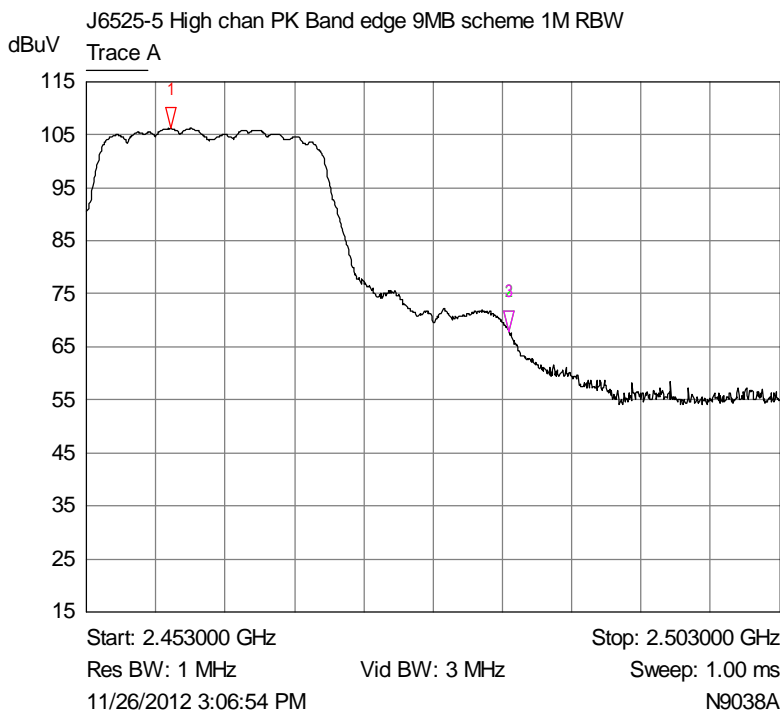

- 1 Trace A
2.459050 GHz
106.1098 dBuV
- 2 Trace A
2.483500 GHz
67.8310 dBuV
- 3 Trace A
2.483500 GHz
67.8310 dBuV

File name PURE.6525-5.DOCM

The contents of this report, apart from the referenced ANSI C63.4-2003, are beyond the scope of UKAS Testing Laboratory No. 2360 accreditation.

6.6 Spectral Power Density

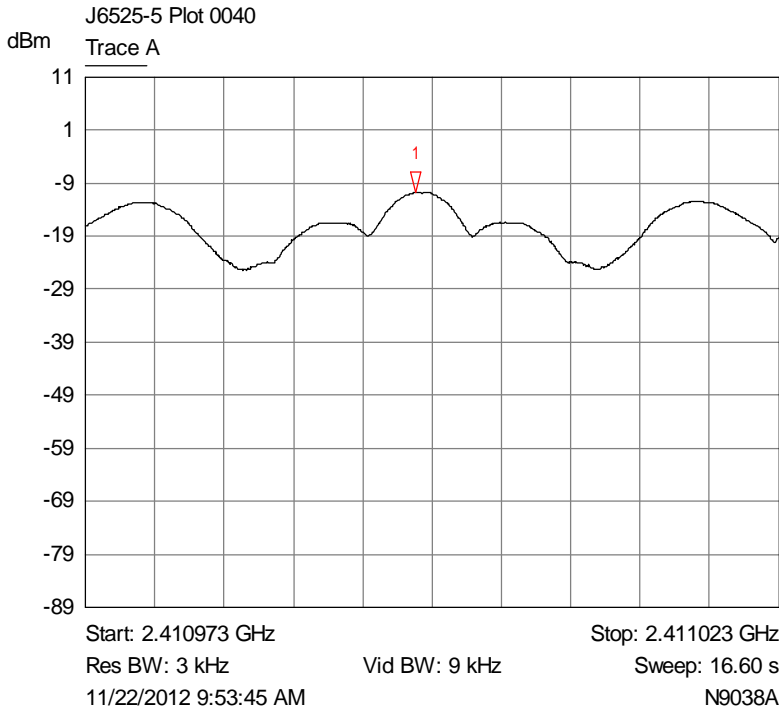

1 Trace A
▽ 2.410997 GHz
-10.8172 dBm

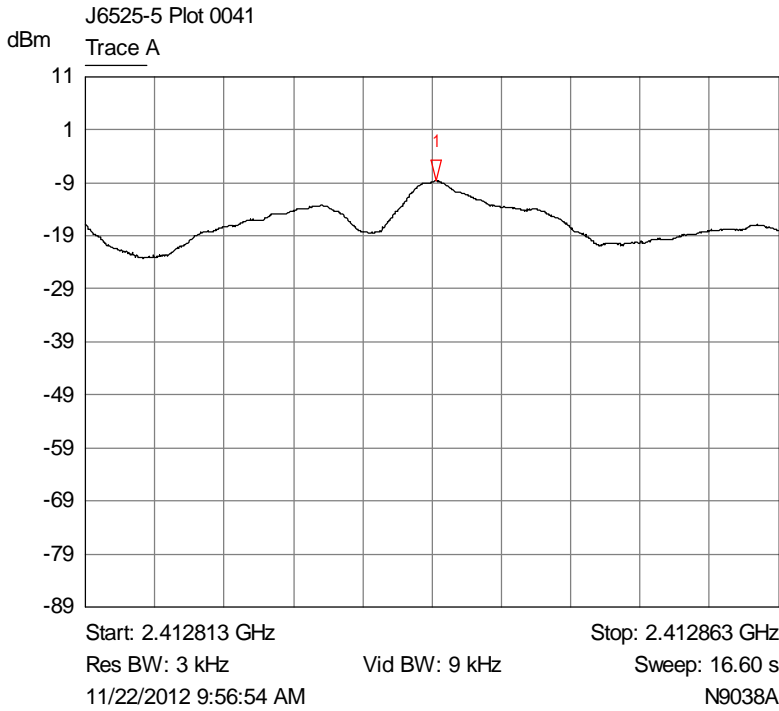

1 Trace A
▽ 2.412838 GHz
-8.7052 dBm

File name PURE.6525-5.DOCM

The contents of this report, apart from the referenced ANSI C63.4-2003, are beyond the scope of UKAS Testing Laboratory No. 2360 accreditation.

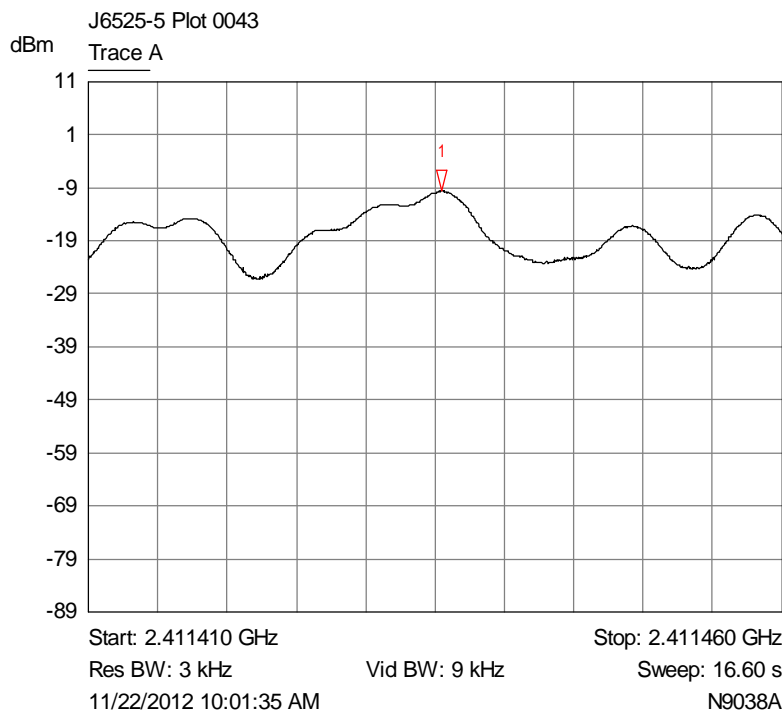
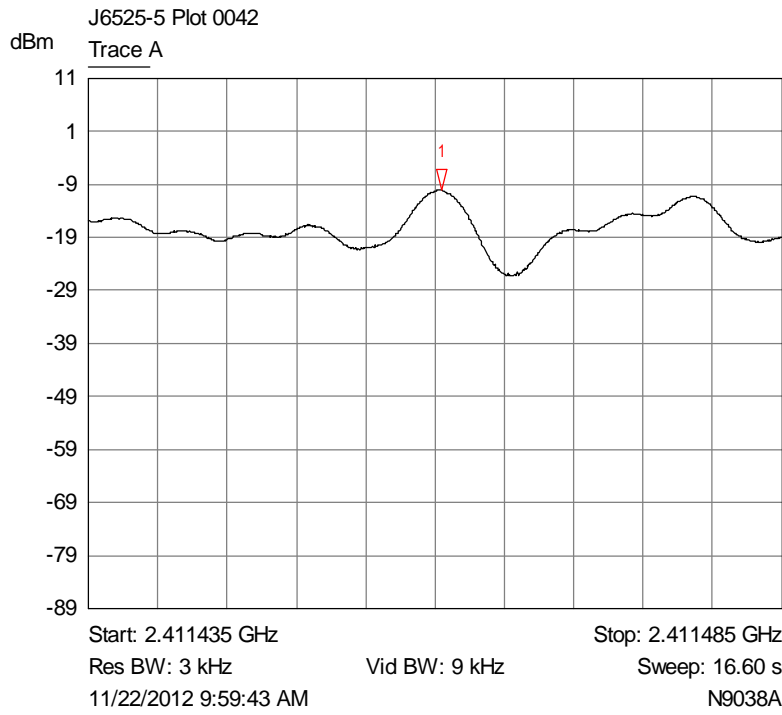

File name PURE.6525-5.DOCM

The contents of this report, apart from the referenced ANSI C63.4-2003, are beyond the scope of UKAS Testing Laboratory No. 2360 accreditation.

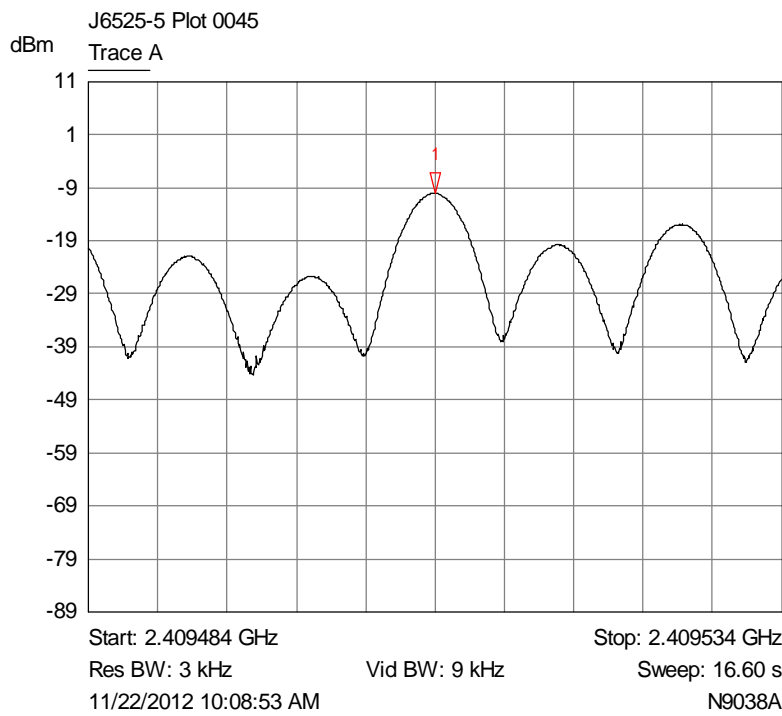
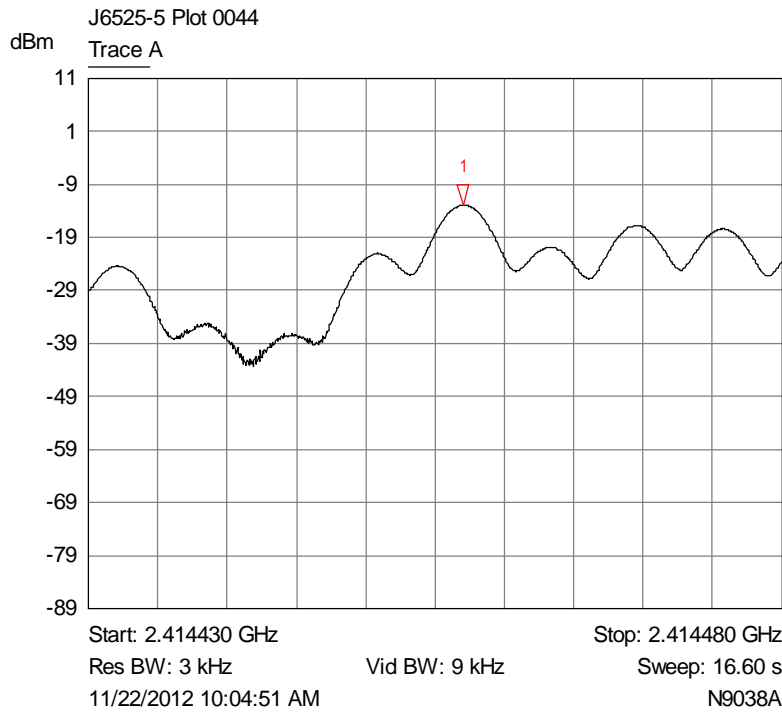

File name PURE.6525-5.DOCM

The contents of this report, apart from the referenced ANSI C63.4-2003, are beyond the scope of UKAS Testing Laboratory No. 2360 accreditation.

J6525-5 Plot 0046
Trace A

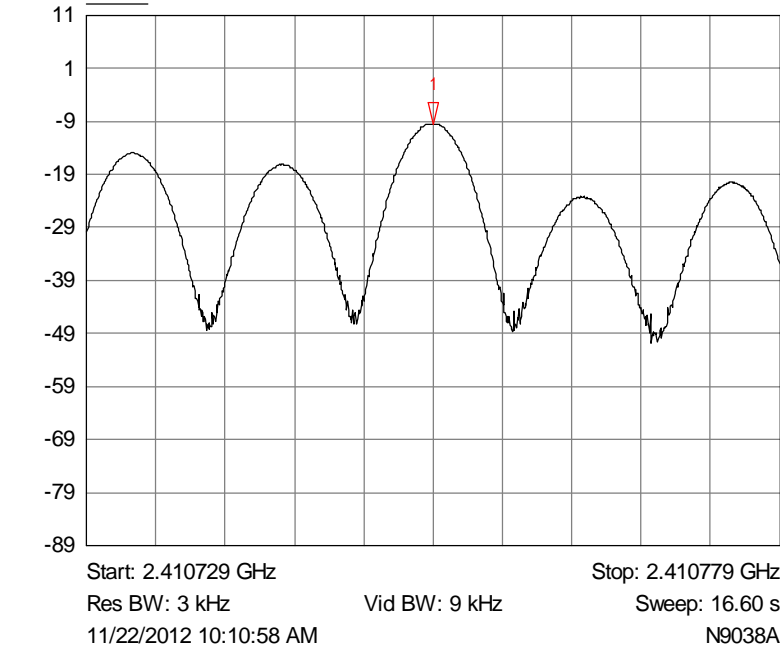

1 Trace A
▽ 2.410754 GHz
-9.4227 dBm

J6525-5 Plot 0047
Trace A

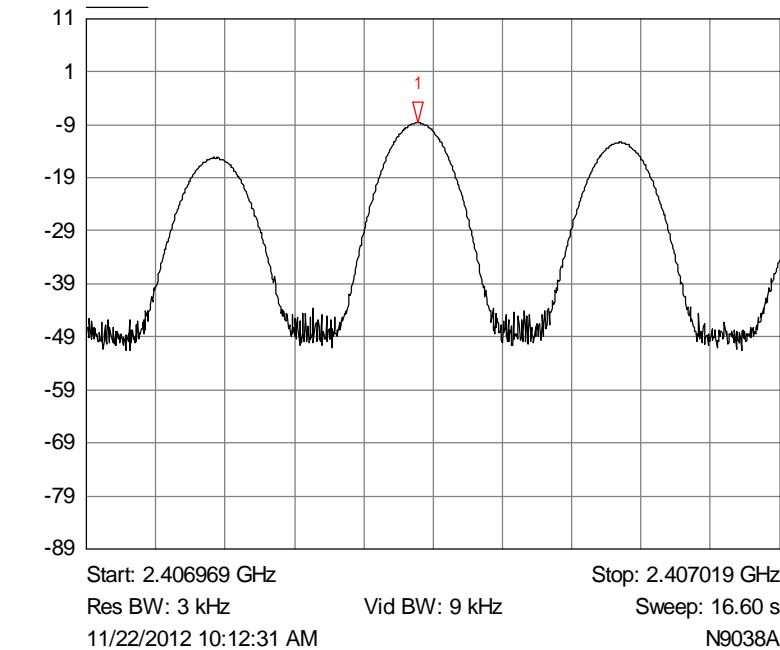

1 Trace A
▽ 2.406993 GHz
-8.6679 dBm

File name PURE.6525-5.DOCM

The contents of this report, apart from the referenced ANSI C63.4-2003, are beyond the scope of UKAS Testing Laboratory No. 2360 accreditation.

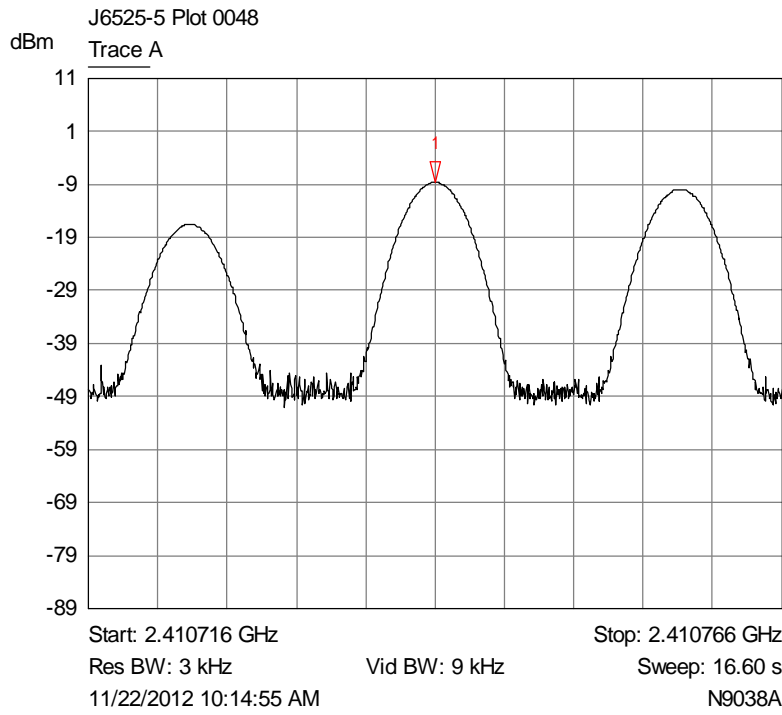

1 Trace A
▽ 2.410741 GHz
-8.6370 dBm

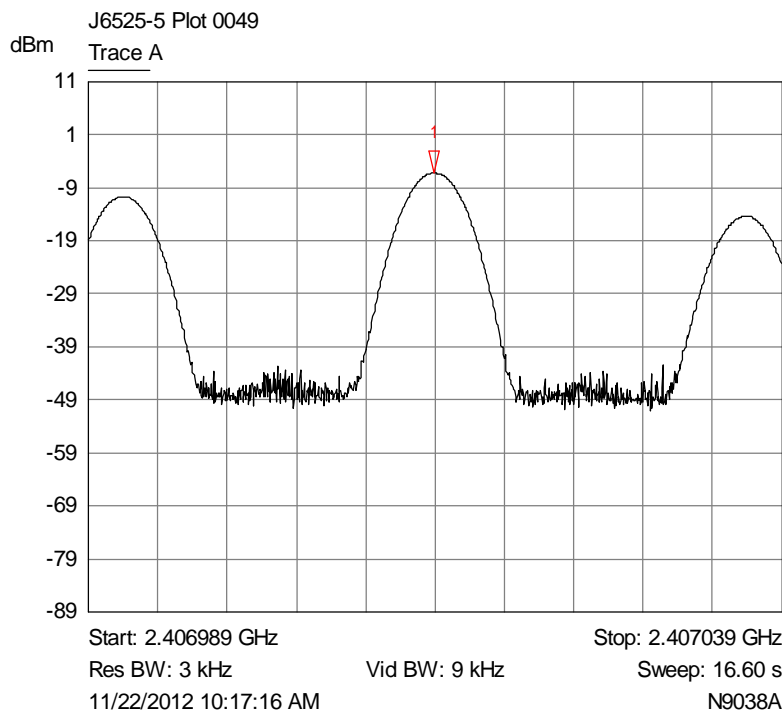

1 Trace A
▽ 2.407014 GHz
-6.2013 dBm

File name PURE.6525-5.DOCM

The contents of this report, apart from the referenced ANSI C63.4-2003, are beyond the scope of UKAS Testing Laboratory No. 2360 accreditation.

J6525-5 Plot 0050
Trace A

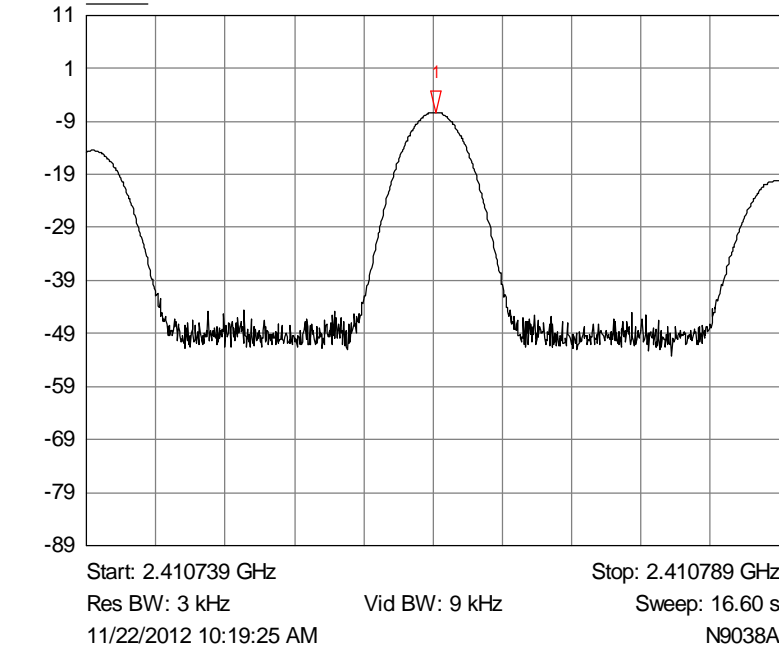

1 Trace A
▽ 2.410764 GHz
-7.2930 dBm

J6525-5 Plot 0051
Trace A

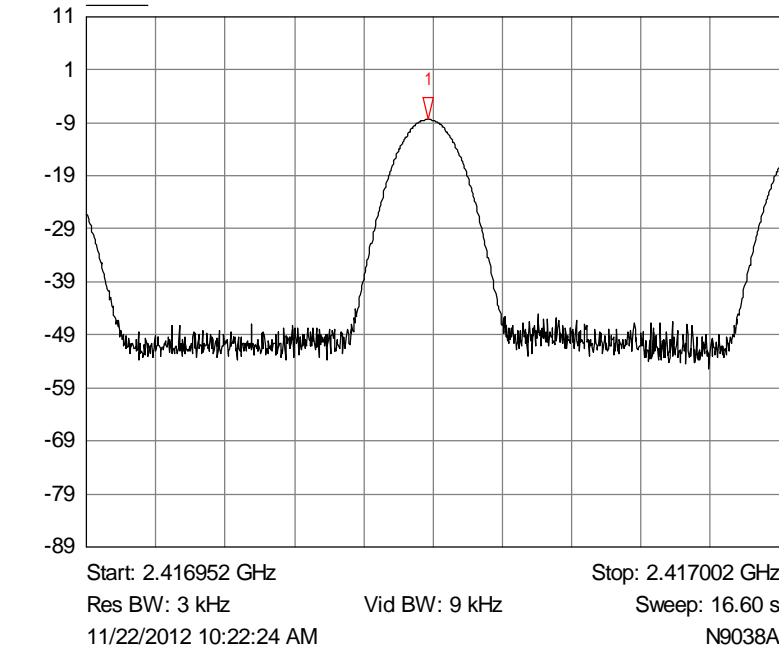

1 Trace A
▽ 2.416976 GHz
-8.3499 dBm

File name PURE.6525-5.DOCM

The contents of this report, apart from the referenced ANSI C63.4-2003, are beyond the scope of UKAS Testing Laboratory No. 2360 accreditation.

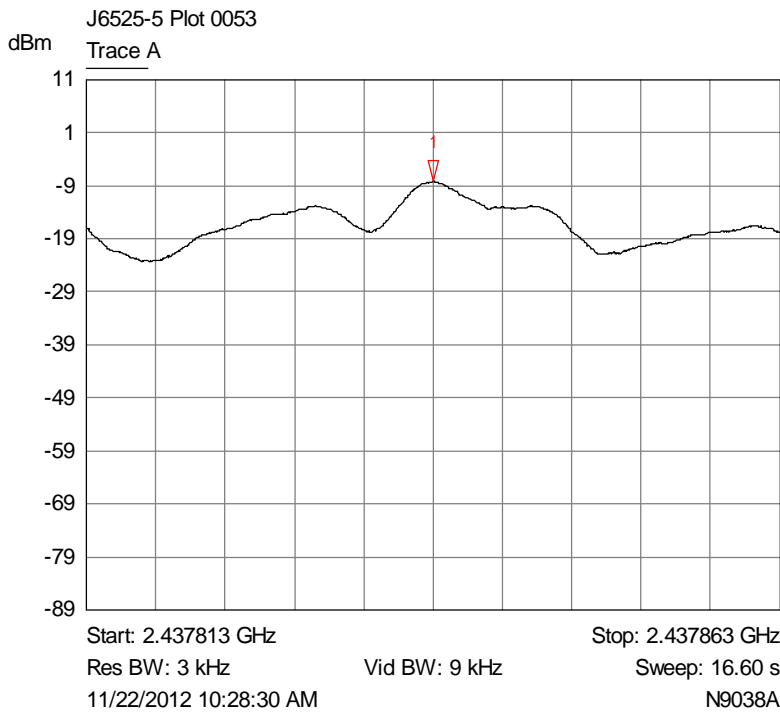
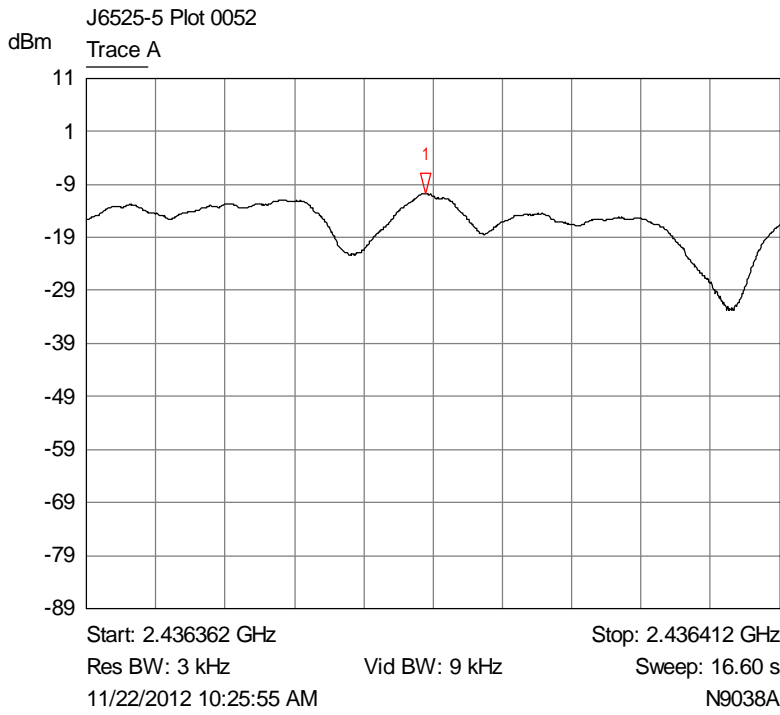

File name PURE.6525-5.DOCM

The contents of this report, apart from the referenced ANSI C63.4-2003, are beyond the scope of UKAS Testing Laboratory No. 2360 accreditation.

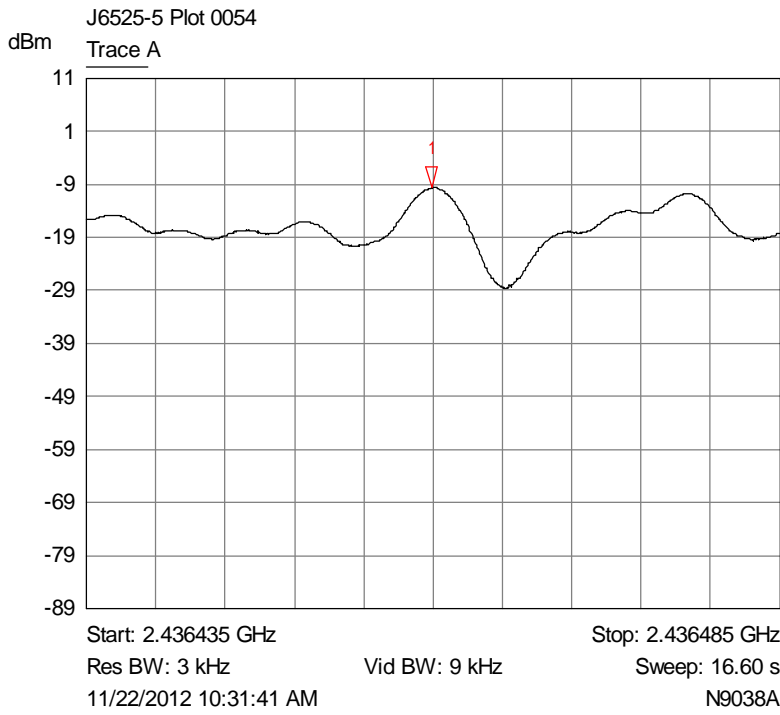

1 Trace A
▽ 2.436460 GHz
-9.7093 dBm

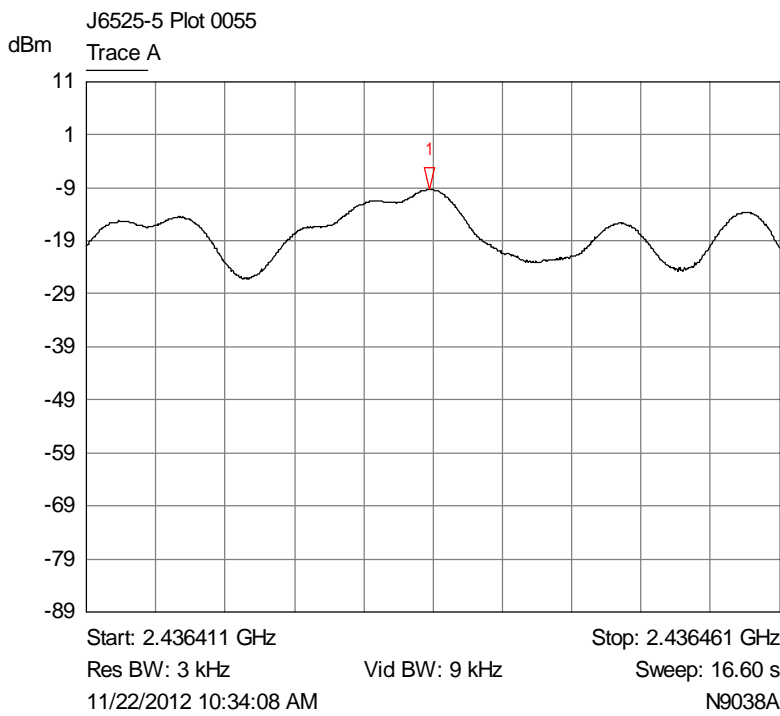

1 Trace A
▽ 2.436435 GHz
-9.3330 dBm

File name PURE.6525-5.DOCM

The contents of this report, apart from the referenced ANSI C63.4-2003, are beyond the scope of UKAS Testing Laboratory No. 2360 accreditation.

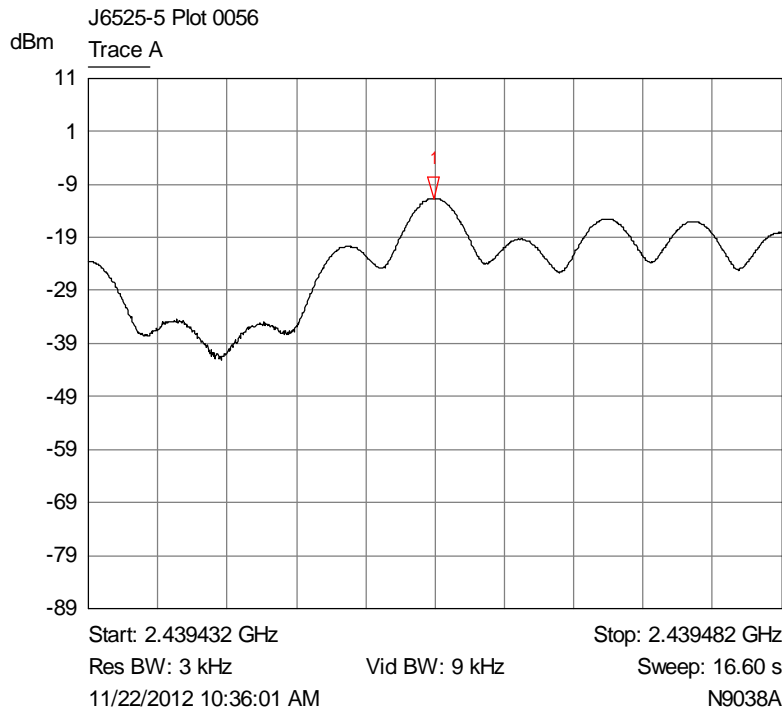

1 Trace A
▽ 2.439457 GHz
-11.6530 dBm

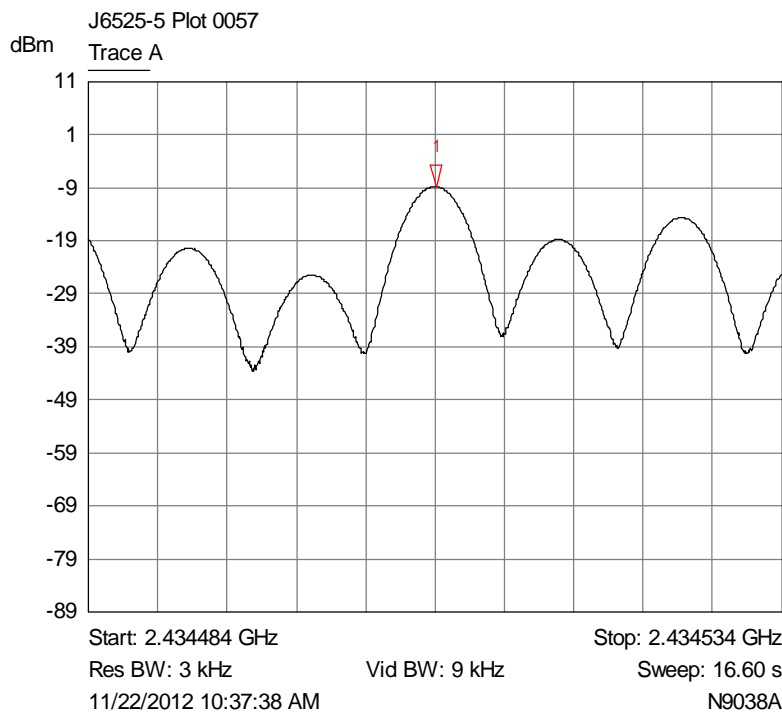

1 Trace A
▽ 2.434509 GHz
-8.7754 dBm

File name PURE.6525-5.DOCM

The contents of this report, apart from the referenced ANSI C63.4-2003, are beyond the scope of UKAS Testing Laboratory No. 2360 accreditation.

J6525-5 Plot 0058
Trace A

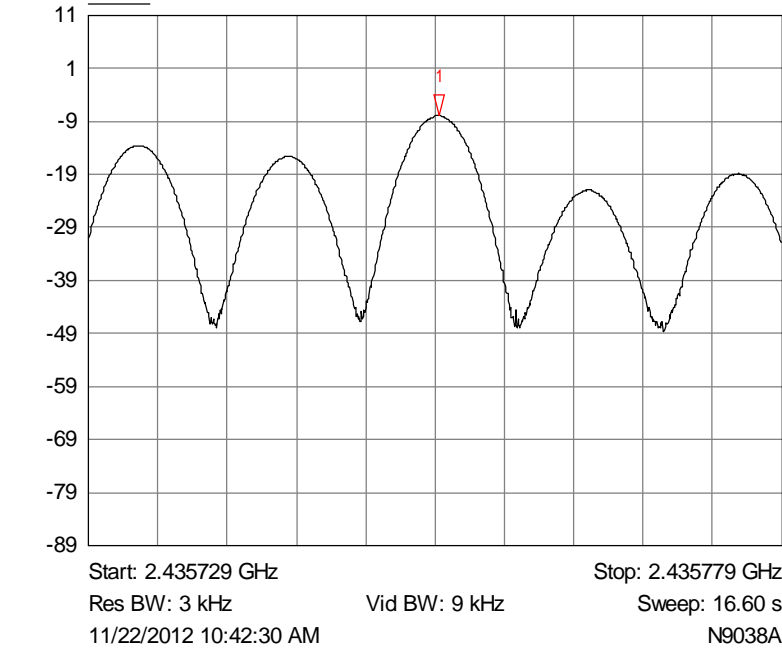

1 Trace A
▽ 2.435754 GHz
-8.0344 dBm

J6525-5 Plot 0059
Trace A

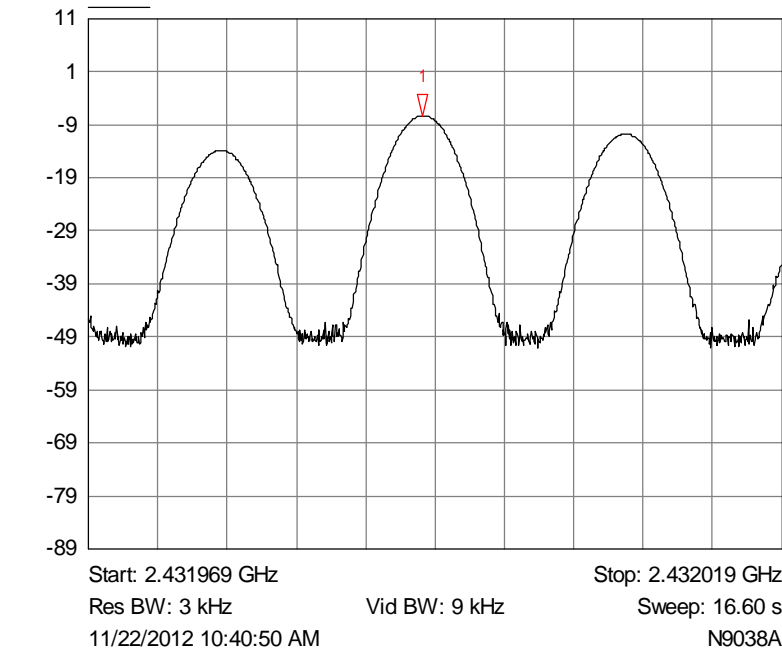

1 Trace A
▽ 2.431993 GHz
-7.3258 dBm

File name PURE.6525-5.DOCM

The contents of this report, apart from the referenced ANSI C63.4-2003, are beyond the scope of UKAS Testing Laboratory No. 2360 accreditation.

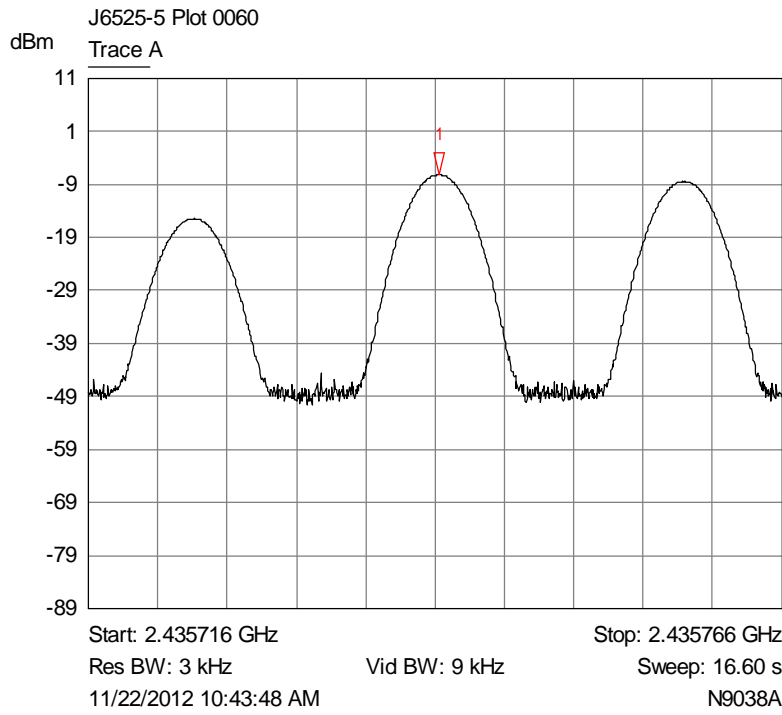

1 Trace A
▽ 2.435741 GHz
-7.2139 dBm

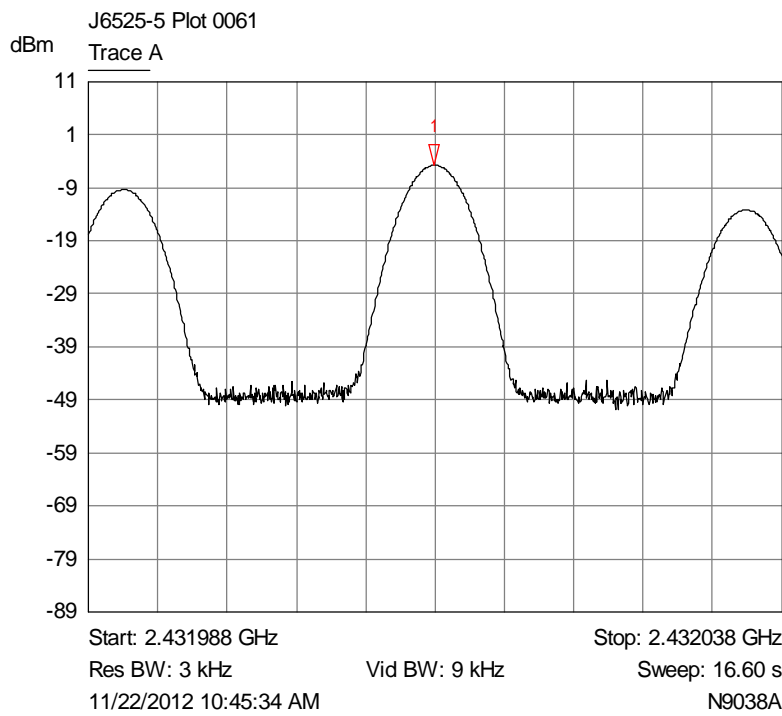

1 Trace A
▽ 2.432013 GHz
-4.8280 dBm

File name PURE.6525-5.DOCM

The contents of this report, apart from the referenced ANSI C63.4-2003, are beyond the scope of UKAS Testing Laboratory No. 2360 accreditation.

J6525-5 Plot 0062
Trace A

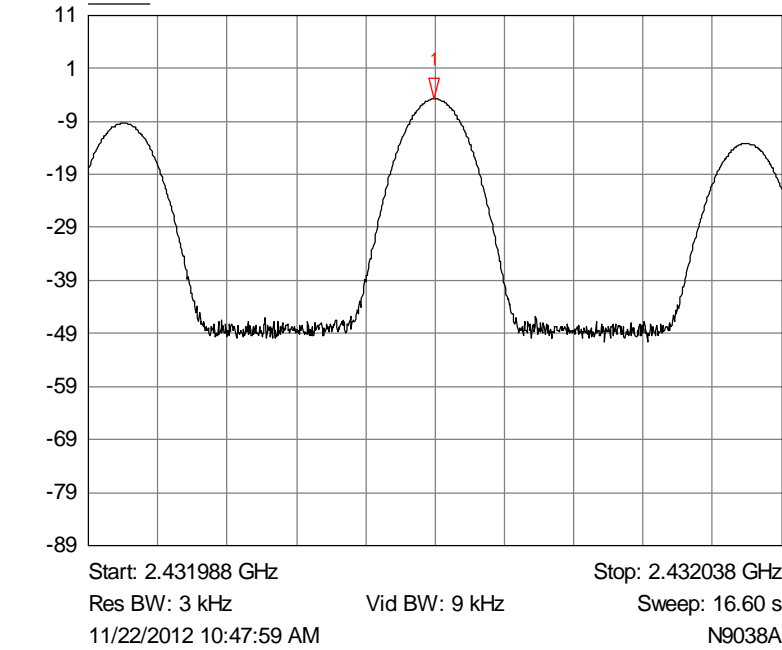

1 Trace A
2.432013 GHz
-4.8294 dBm

J6525-5 Plot 0063
Trace A

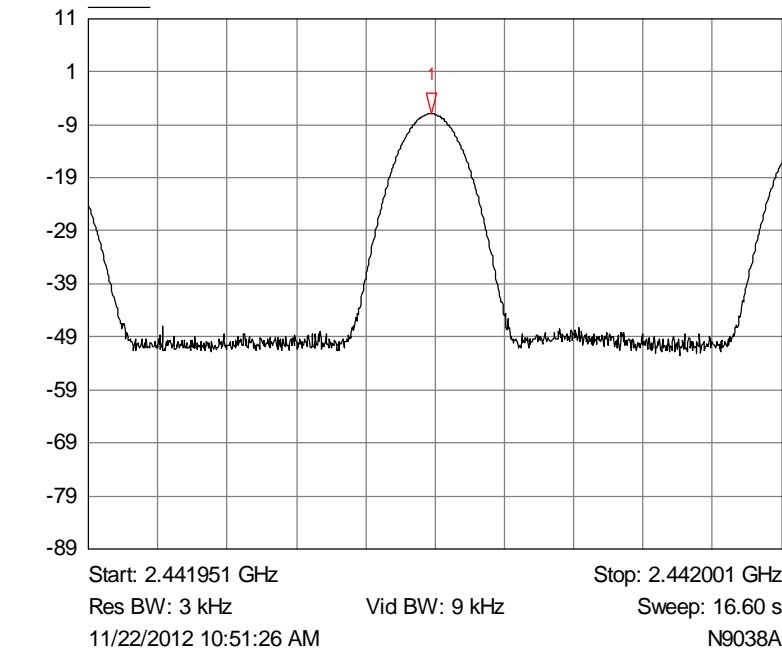

1 Trace A
2.441976 GHz
-6.9853 dBm

File name PURE.6525-5.DOCM

The contents of this report, apart from the referenced ANSI C63.4-2003, are beyond the scope of UKAS Testing Laboratory No. 2360 accreditation.

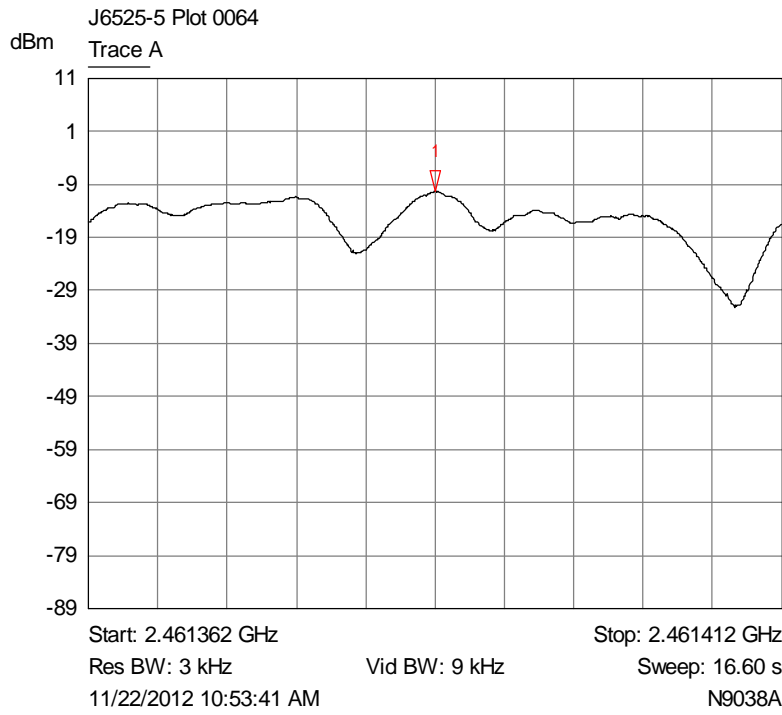

1 Trace A
▽ 2.461387 GHz
-10.3383 dBm

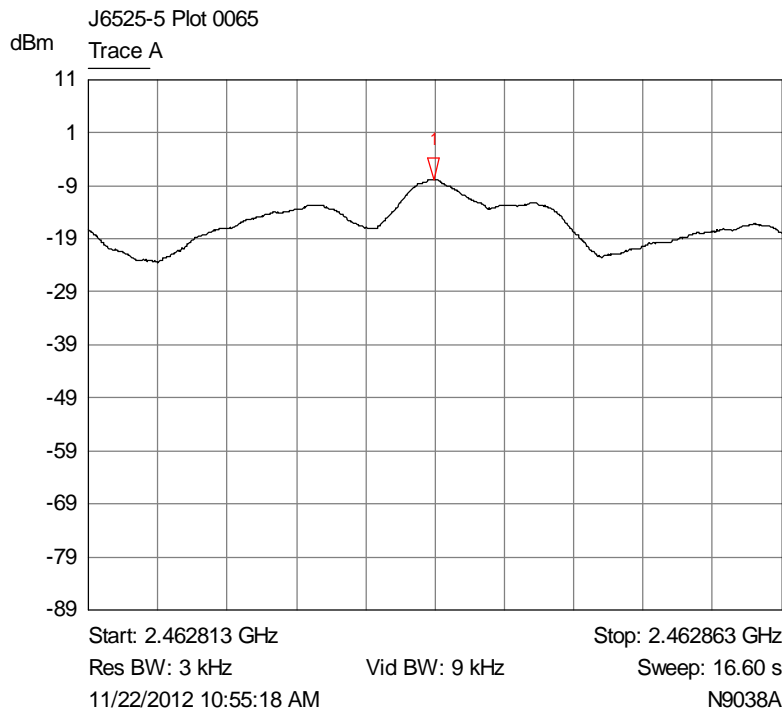

1 Trace A
▽ 2.462838 GHz
-7.8432 dBm

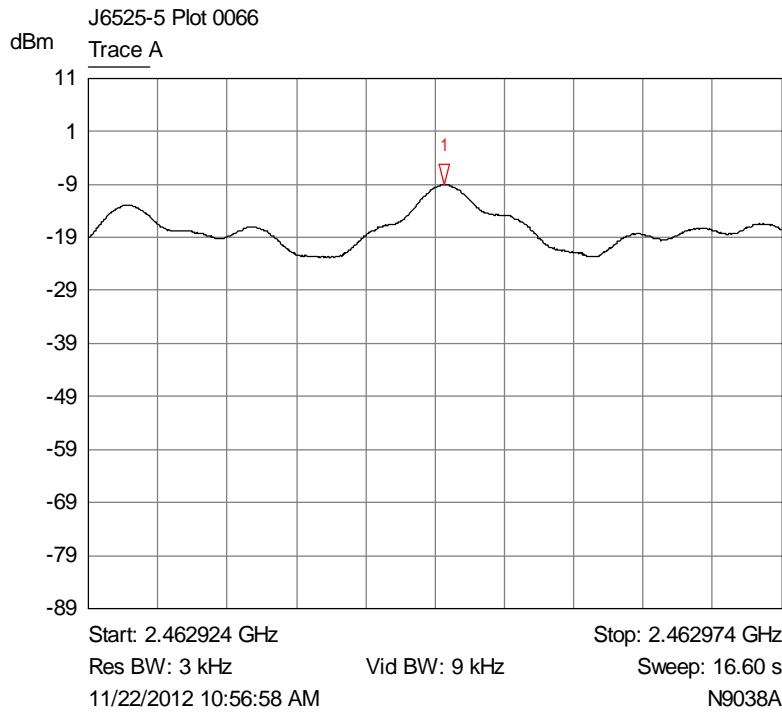

1 Trace A
▽ 2.462950 GHz
-9.1312 dBm

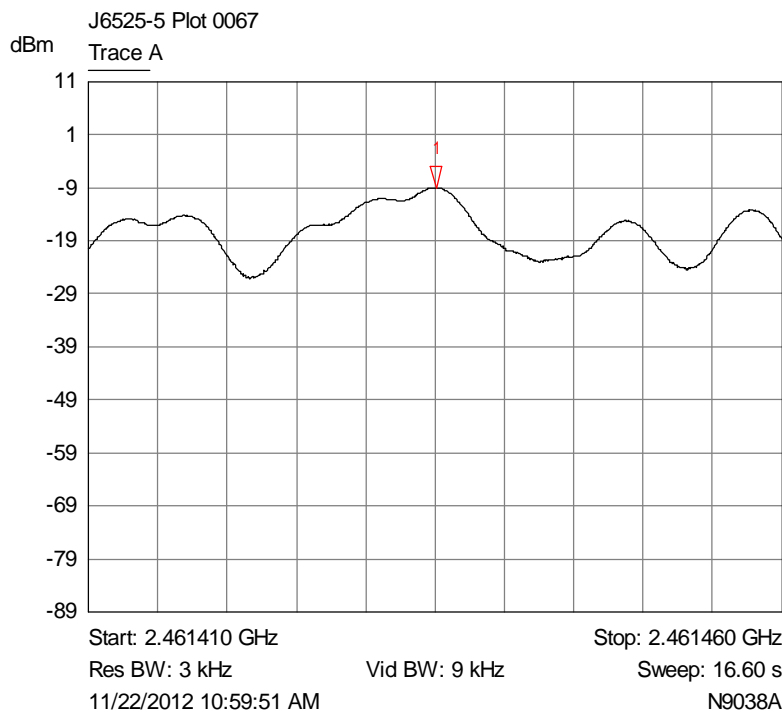

1 Trace A
▽ 2.461435 GHz
-8.9883 dBm

File name PURE.6525-5.DOCM

The contents of this report, apart from the referenced ANSI C63.4-2003, are beyond the scope of UKAS Testing Laboratory No. 2360 accreditation.

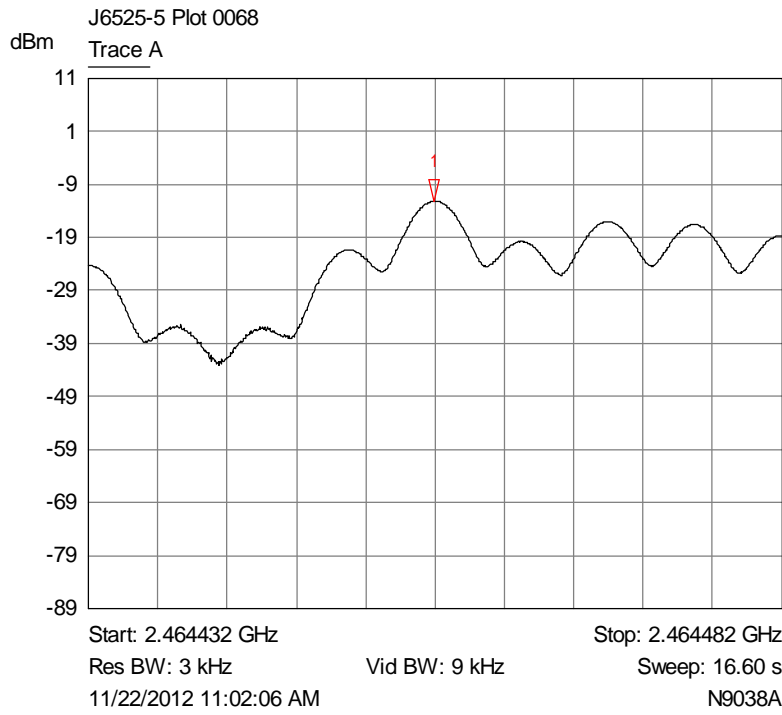

1 Trace A
▽ 2.464457 GHz
-12.2414 dBm

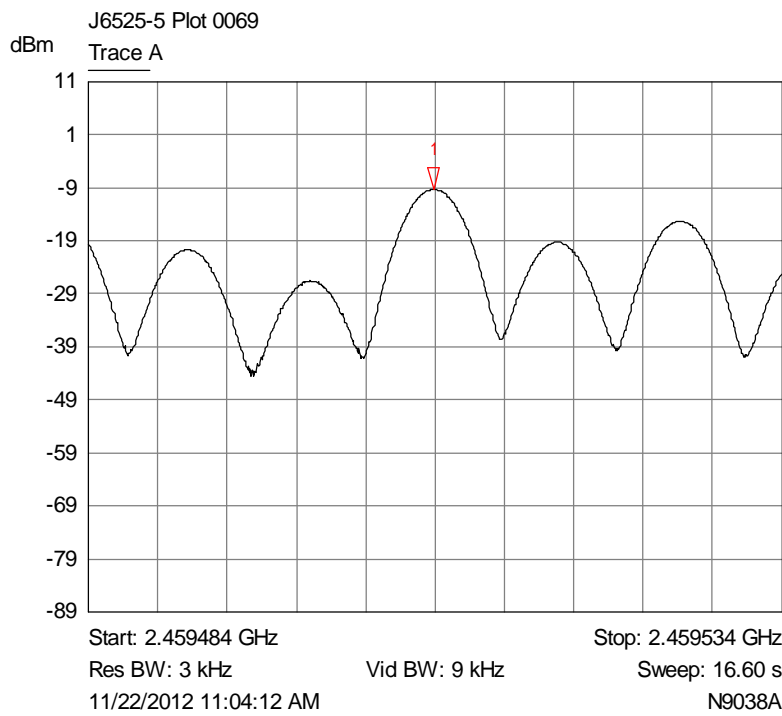

1 Trace A
▽ 2.459509 GHz
-9.3263 dBm

File name PURE.6525-5.DOCM

The contents of this report, apart from the referenced ANSI C63.4-2003, are beyond the scope of UKAS Testing Laboratory No. 2360 accreditation.

J6525-5 Plot 0070
Trace A

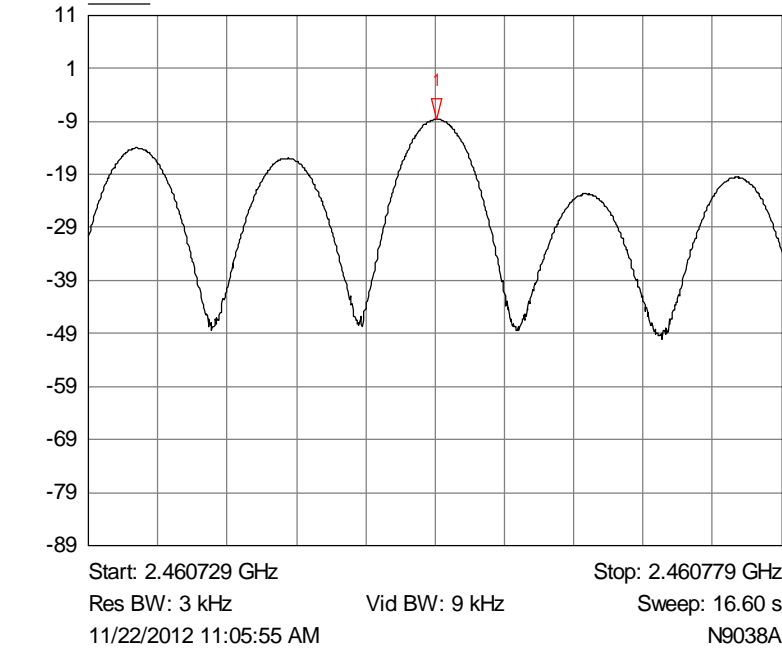

1 Trace A
▽ 2.460754 GHz
-8.6648 dBm

J6525-5 Plot 0071
Trace A

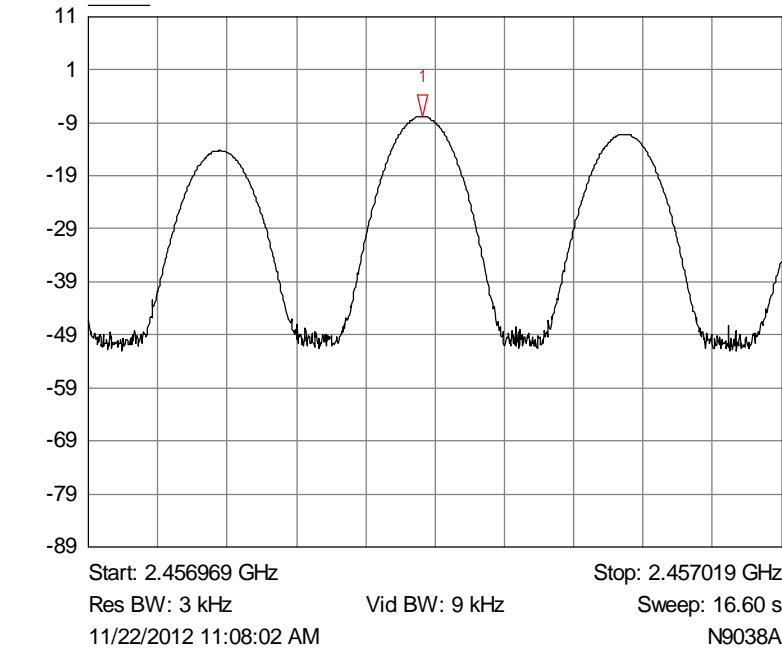

1 Trace A
▽ 2.456993 GHz
-7.8014 dBm

File name PURE.6525-5.DOCM

The contents of this report, apart from the referenced ANSI C63.4-2003, are beyond the scope of UKAS Testing Laboratory No. 2360 accreditation.

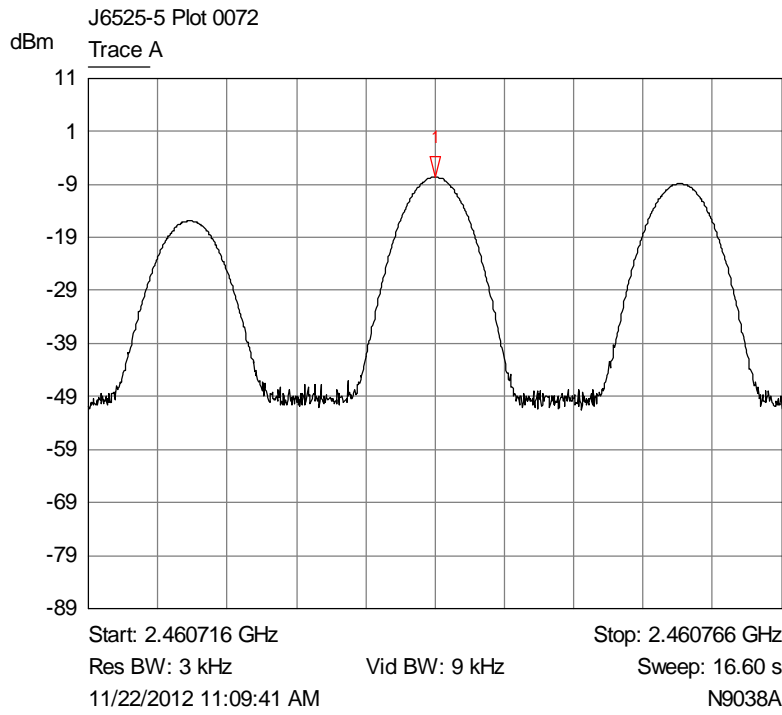

1 Trace A
▽ 2.460741 GHz
-7.6633 dBm

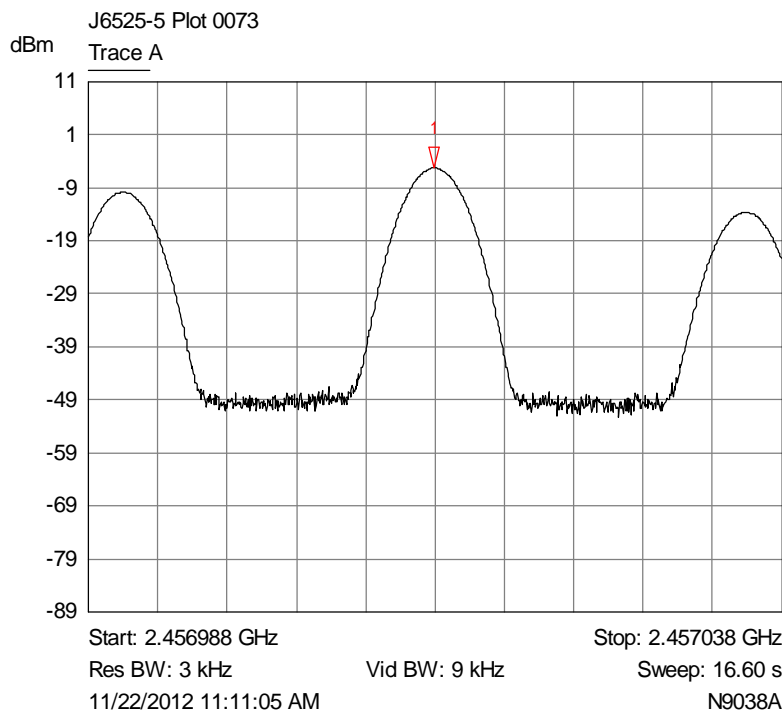

1 Trace A
▽ 2.457013 GHz
-5.3401 dBm

File name PURE.6525-5.DOCM

The contents of this report, apart from the referenced ANSI C63.4-2003, are beyond the scope of UKAS Testing Laboratory No. 2360 accreditation.

J6525-5 Plot 0074
Trace A

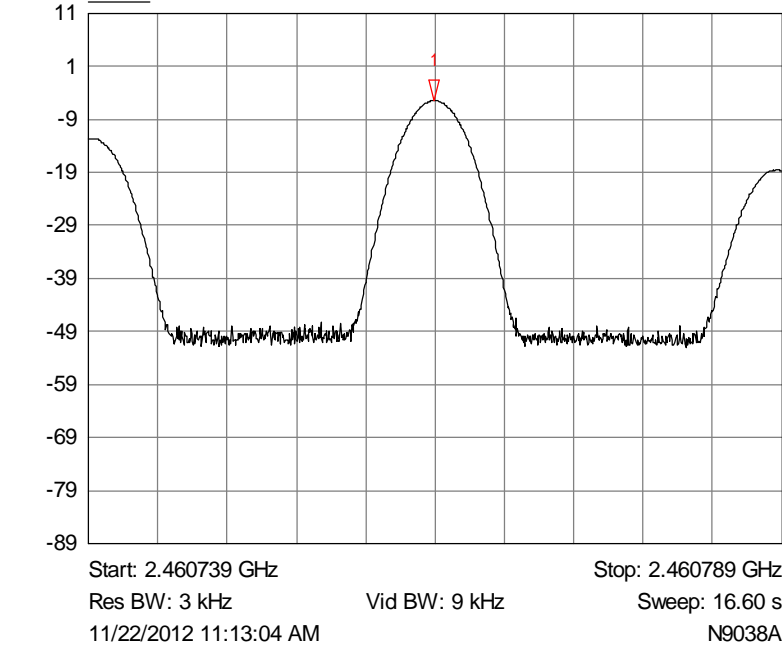

1 Trace A
▽ 2.460764 GHz
-5.4650 dBm

J6525-5 Plot 0075
Trace A

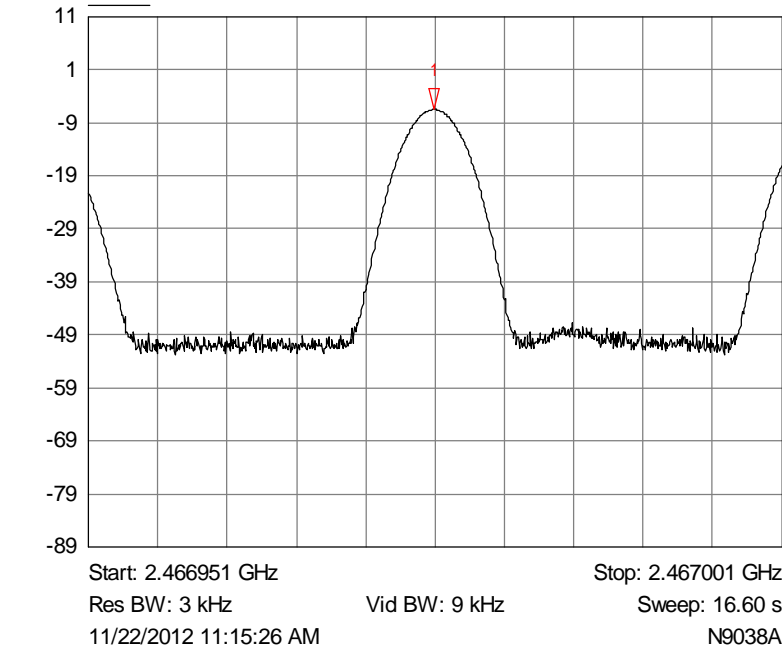

1 Trace A
▽ 2.466976 GHz
-6.5569 dBm

File name PURE.6525-5.DOCM

The contents of this report, apart from the referenced ANSI C63.4-2003, are beyond the scope of UKAS Testing Laboratory No. 2360 accreditation.

7 Explanatory Notes

7.1 Explanation of Table of Signals Measured

Measurements are made as required by the standard. These measurements are made and recorded using detectors, either peak, quasi peak or average dependant on the test. A table of results has been given following the relevant plots. This table looks similar to the one illustrated below dependant on the measurements required by the test: -

Signal No.	Freq (MHz)	Peak Amp (dB μ V)	Pk - Lim 1 (dB)	QP Amp (dB μ V)	QP - Lim1 (dB)	Av Amp (dB μ V)	Av - Lim1 (dB)
1	12345	54.9	-10.5	48.0	-12.6	37.6	-14.4

Column One - Labelled Signal No. is an incremental number that the receiver has given to each signal that has been measured.

Column Two - Labelled Freq (MHz) is the approximate frequency of the signal received.

Column Three - Labelled Peak Amp (dB μ V) is the level of received signal that was measured in dB above 1 μ V using the peak detector.

Column Four - Labelled Pk - Lim1 (dB) is the difference in level from the peak signal given to the active limit line. If this column appears in the table the peak detector measurement is required by the standard for this test. The results entered in this column indicate the signal level relative to the compliance limit required. Negative numbers indicate that the product is compliant.

Column Five - Labelled QP Amp (dB μ V) is the level of received signal that was measured in dB above 1 μ V using the quasi-peak detector.

Column Six - Labelled QP - Lim1 (dB) is the difference in level from the quasi-peak signal given to the active limit line. If this column appears in the table the quasi-peak detector measurement is required by the standard for this test. The results entered in this column indicate the signal level relative to the compliance limit required. Negative numbers indicate that the product is compliant.

Column Seven - Labelled Av Amp (dB μ V) is the level of received signal that was measured in dB above 1 μ V using the average detector.

Column Eight - Labelled Av - Lim1 (dB) is the difference in level from the average signal given to the active limit line. If this column appears in the table the average detector measurement is required by the standard for this test. The results entered in this column indicate the signal level relative to the compliance limit required. Negative numbers indicate that the product is compliant.

Only signals highlighted in red are deemed to exceed the limit of the detector required.

7.2 Explanation of limit line calculations for radiated measurements

The limits given in the test standard are normally expressed as absolute values (e.g. in μ V/m at a specified distance), whereas the measured values are expressed as peak, quasi peak or average values in dB μ V/m referenced to the measuring instrument inputs. RN Electronics calibrate the test set-up to account for any path losses, antenna gains, etc. so that the value read at the receiver relates directly to the absolute value required, except that it is expressed in dB relative to one microVolt and may need to take account of any alternative measuring distance used. Examples:

- (a) limit of 500 μ V/m equates to $20.\log(500) = 54$ dB μ V/m.
- (b) limit of 300 μ V/m at 10m equates to $20.\log(300 \cdot 10/3) = 60$ dB μ V/m at 3m
- (c) limit of 30 μ V/m at 30m, but below 30MHz, equates to $20.\log(30) + 40.\log(30/3) = 69.5$ dB μ V/m at 3m, as extrapolation factor below 30MHz is 40dB/decade per 15.31(f)(2).

File name PURE.6525-5.DOCM

The contents of this report, apart from the referenced ANSI C63.4-2003, are beyond the scope of UKAS Testing Laboratory No. 2360 accreditation.

8 Photographs

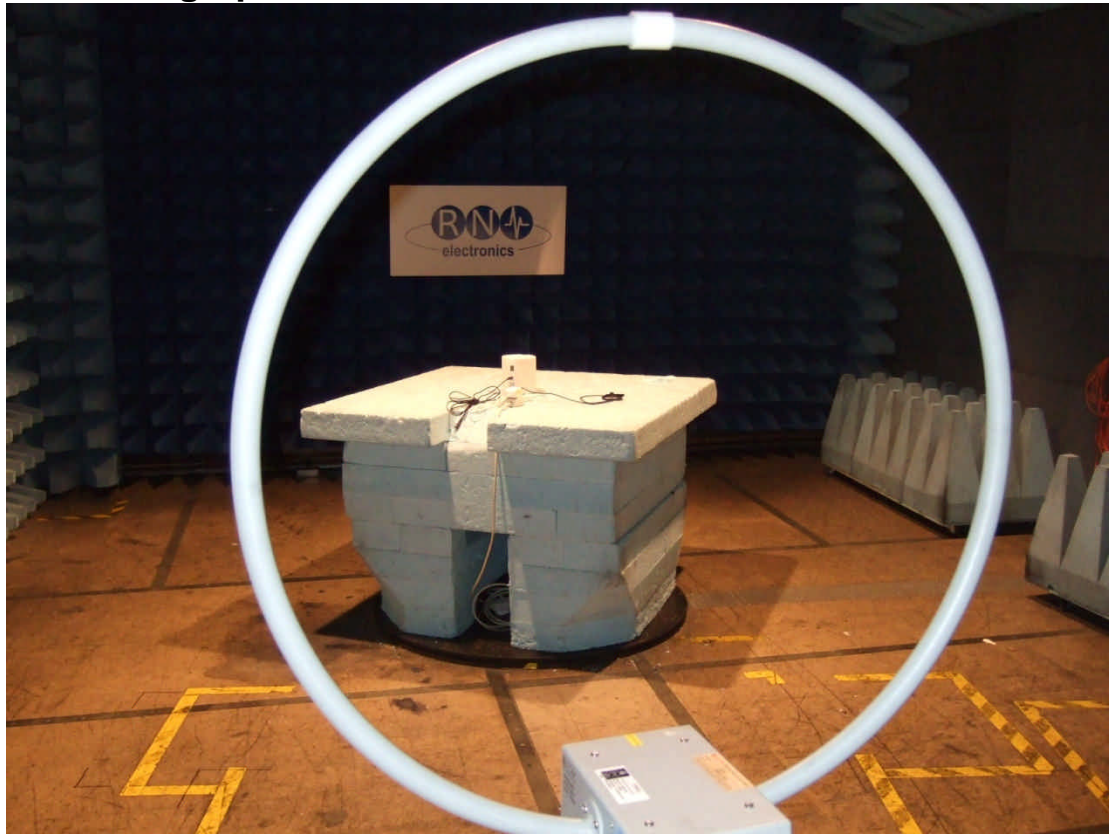

File name PURE.6525-5.DOCM

The contents of this report, apart from the referenced ANSI C63.4-2003, are beyond the scope of UKAS Testing Laboratory No. 2360 accreditation.

QMF21J – 3; 47CFR15.247, RNE ISSUE 01 SEP 2012

PAGE 127 OF 141

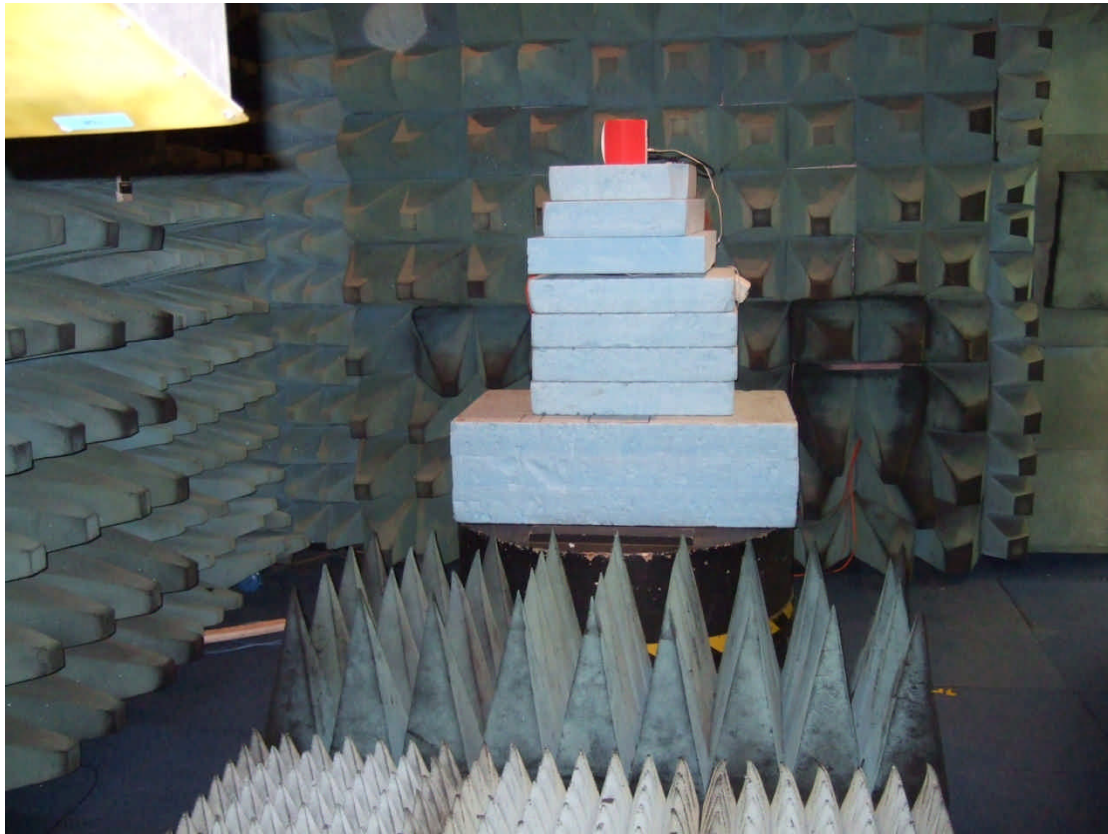

**Photographs of the EUT as viewed from in front
of the antennas, site M & B.**

File name PURE.6525-5.DOCM

The contents of this report, apart from the referenced ANSI C63.4-2003, are beyond the scope of UKAS Testing Laboratory No. 2360 accreditation.

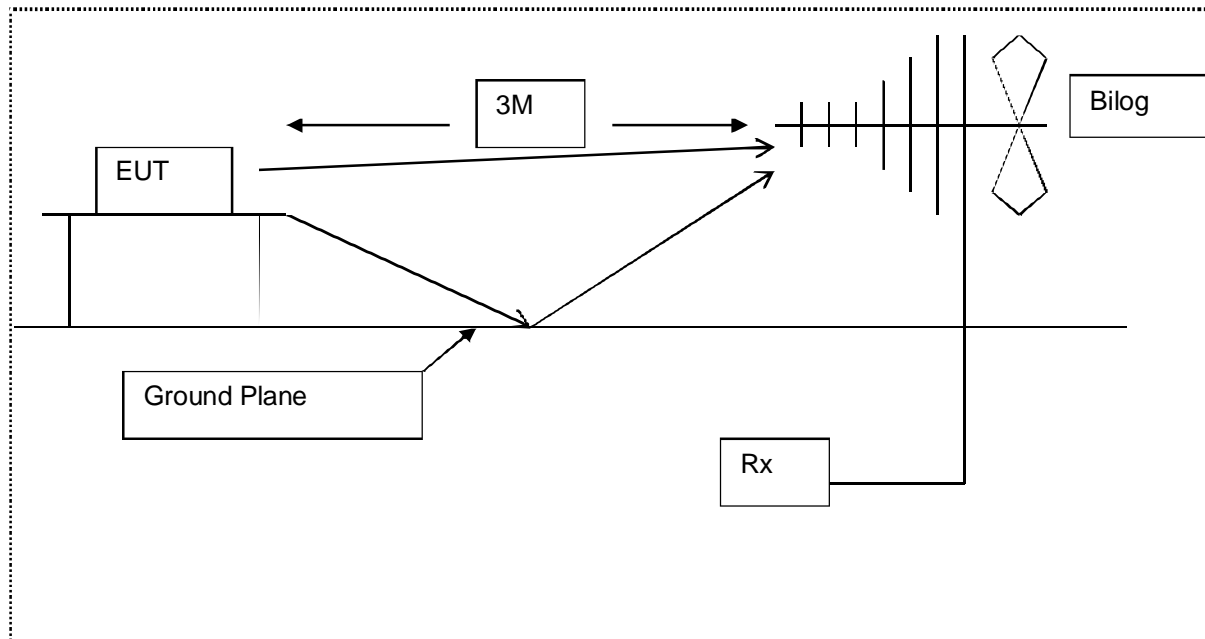

Diagram of the radiated emissions test setup.



Photograph of the EUT as viewed from screened room (conducted emissions)

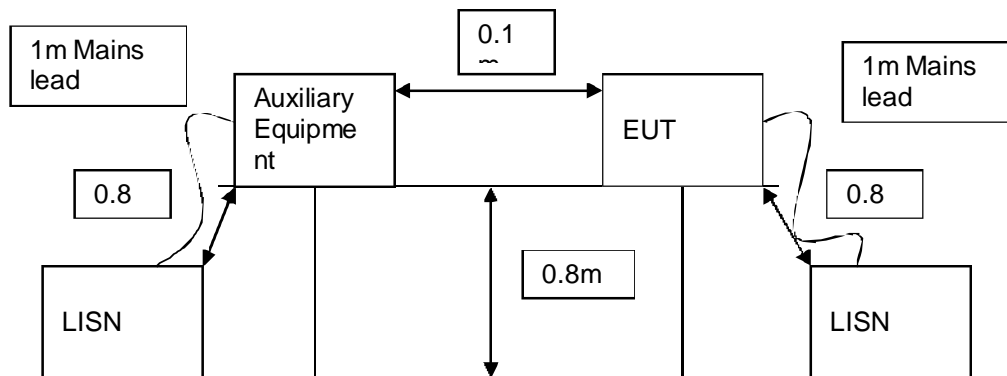

Diagram of the conducted emissions test setup.

Identifying Photographs of the EUT



File name PURE.6525-5.DOCM

The contents of this report, apart from the referenced ANSI C63.4-2003, are beyond the scope of UKAS Testing Laboratory No. 2360 accreditation.

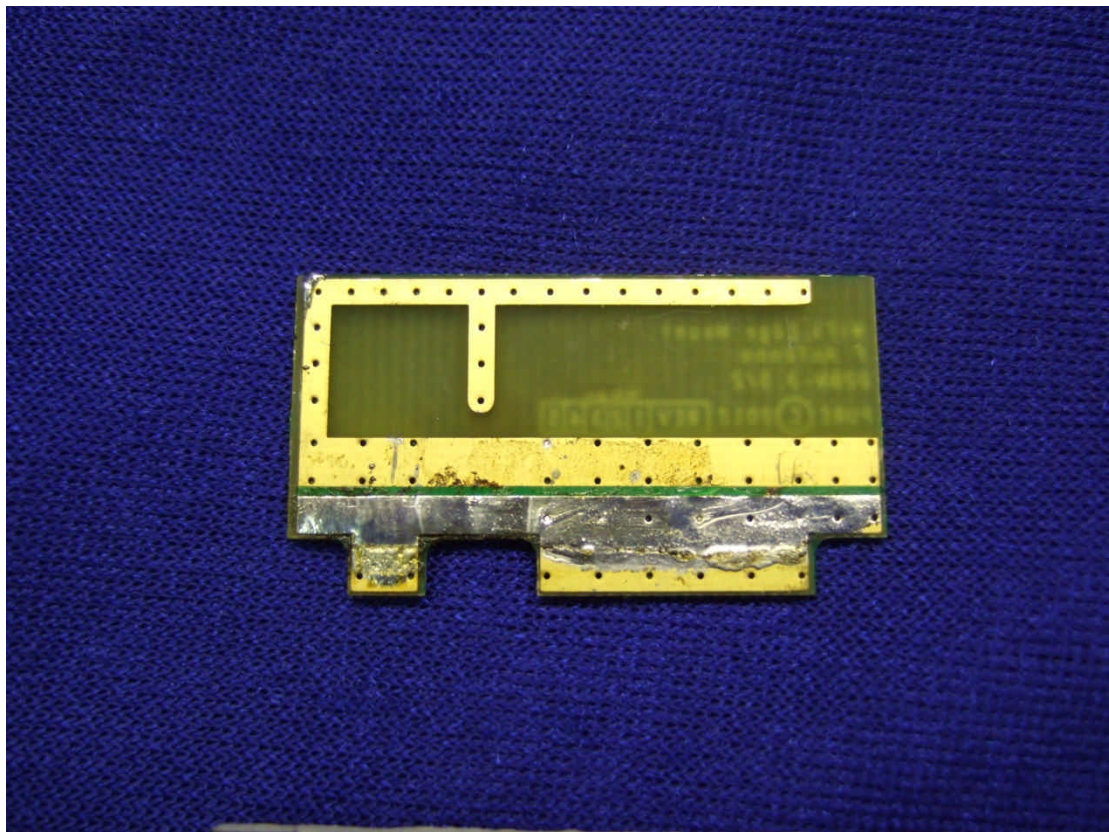
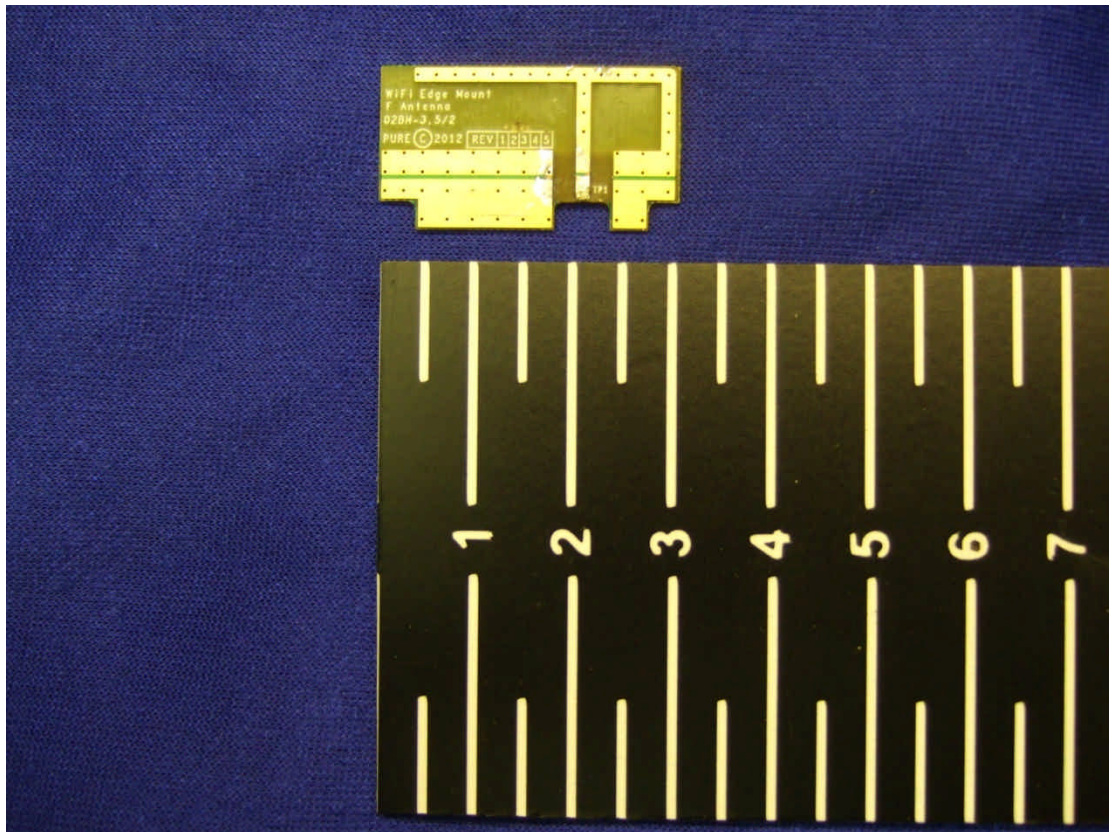

File name PURE.6525-5.DOCM

The contents of this report, apart from the referenced ANSI C63.4-2003, are beyond the scope of UKAS Testing Laboratory No. 2360 accreditation.

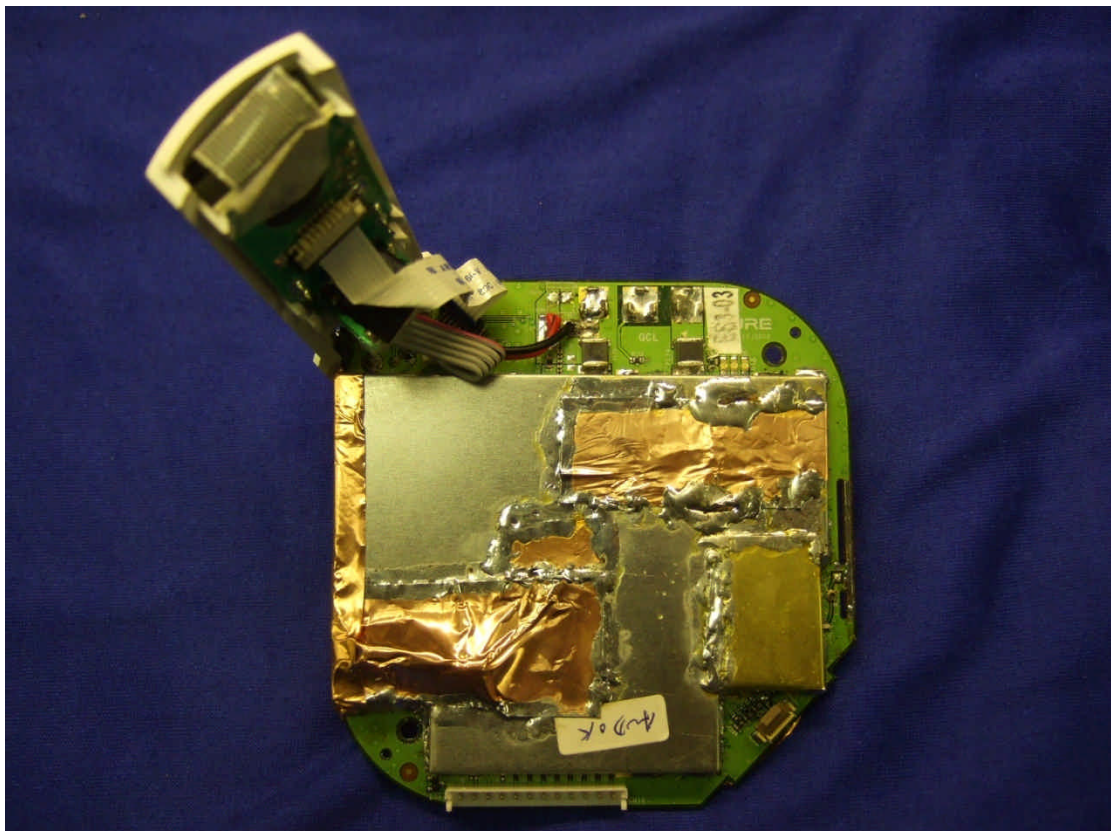
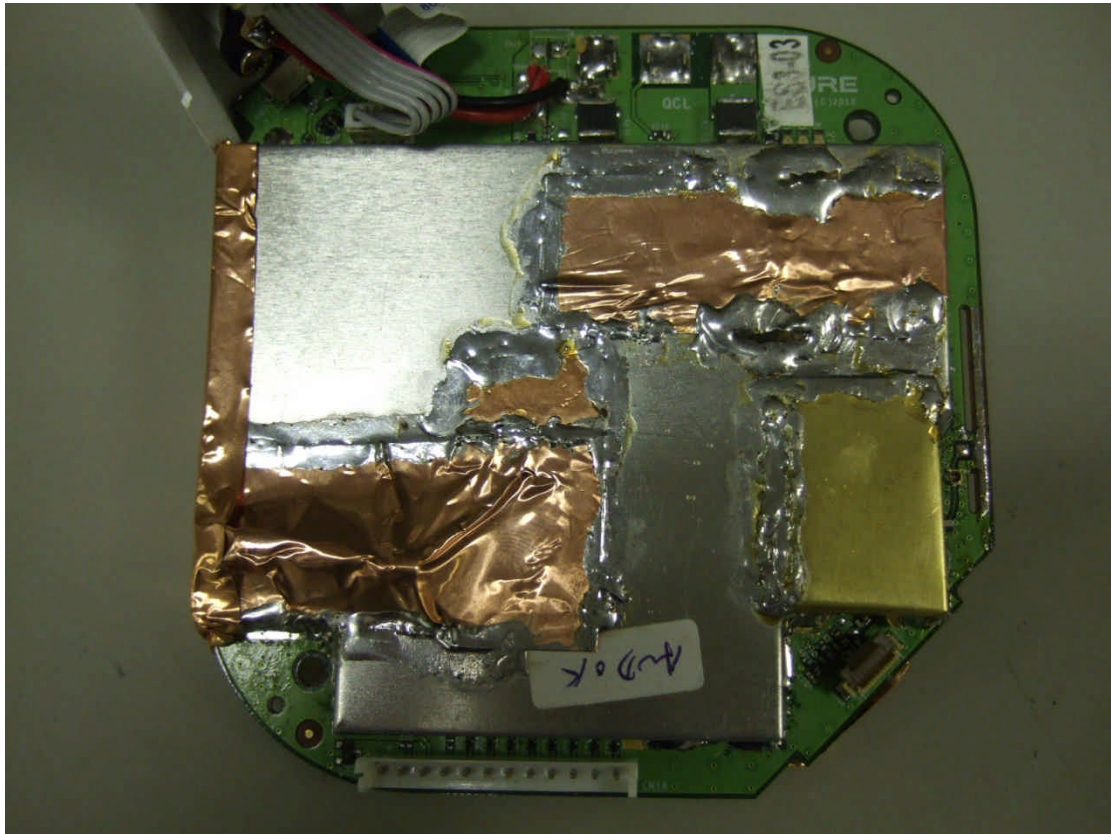

File name PURE.6525-5.DOCM

The contents of this report, apart from the referenced ANSI C63.4-2003, are beyond the scope of UKAS Testing Laboratory No. 2360 accreditation.

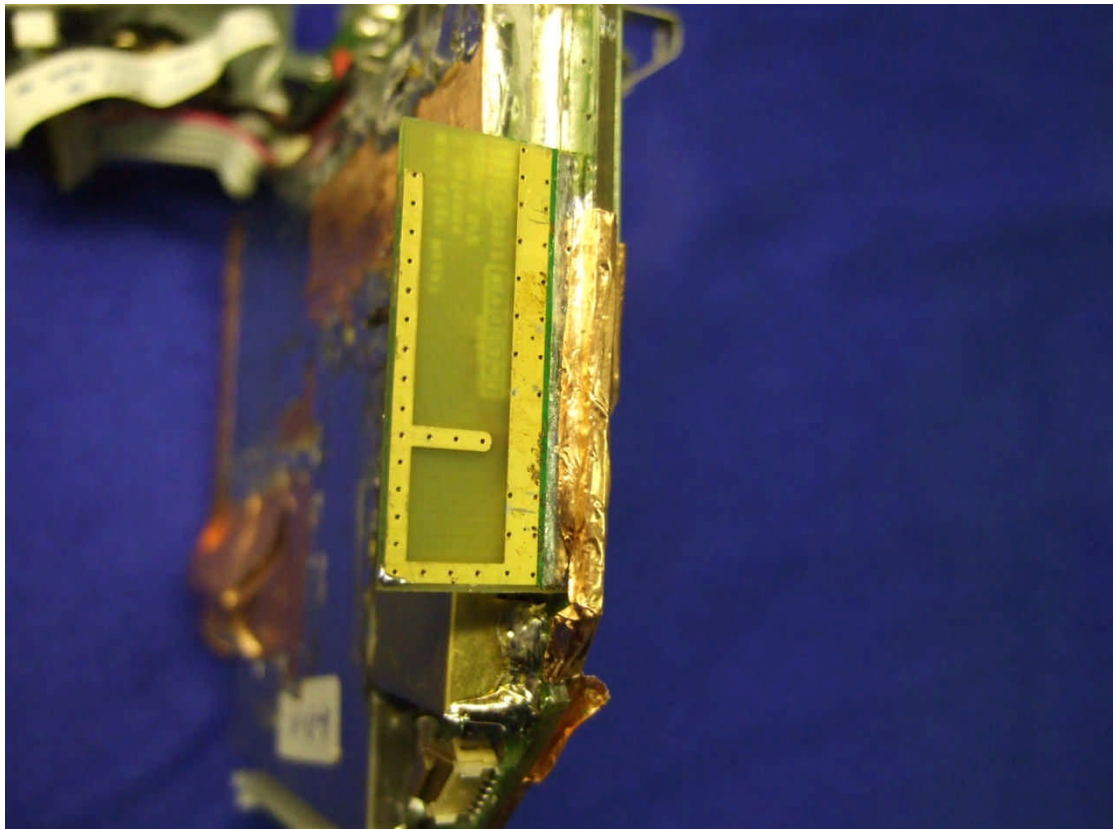
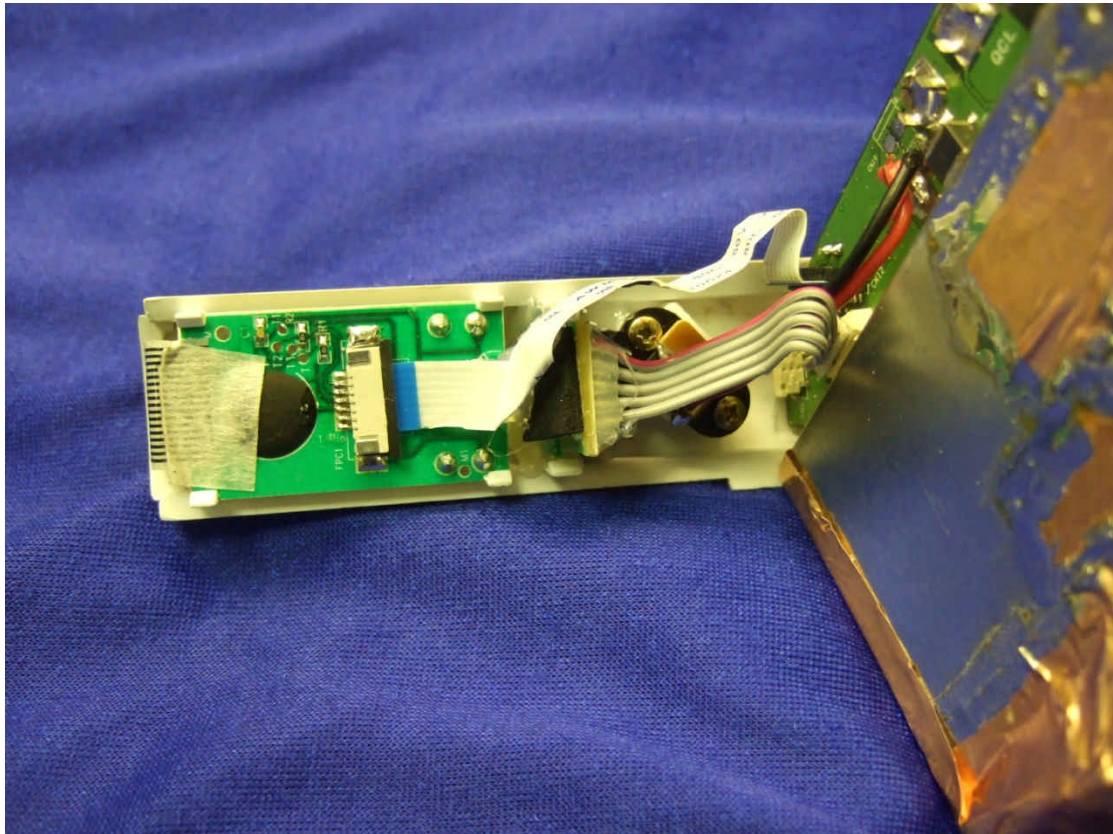

File name PURE.6525-5.DOCM

The contents of this report, apart from the referenced ANSI C63.4-2003, are beyond the scope of UKAS Testing Laboratory No. 2360 accreditation.

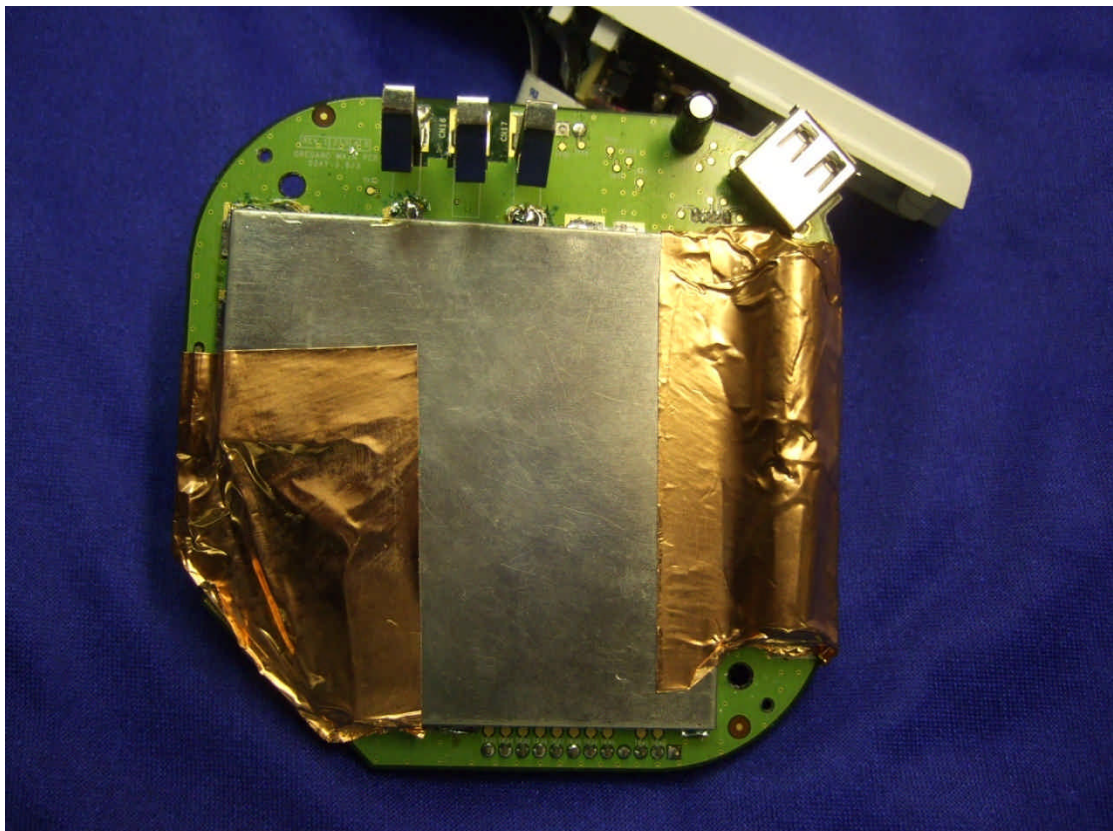
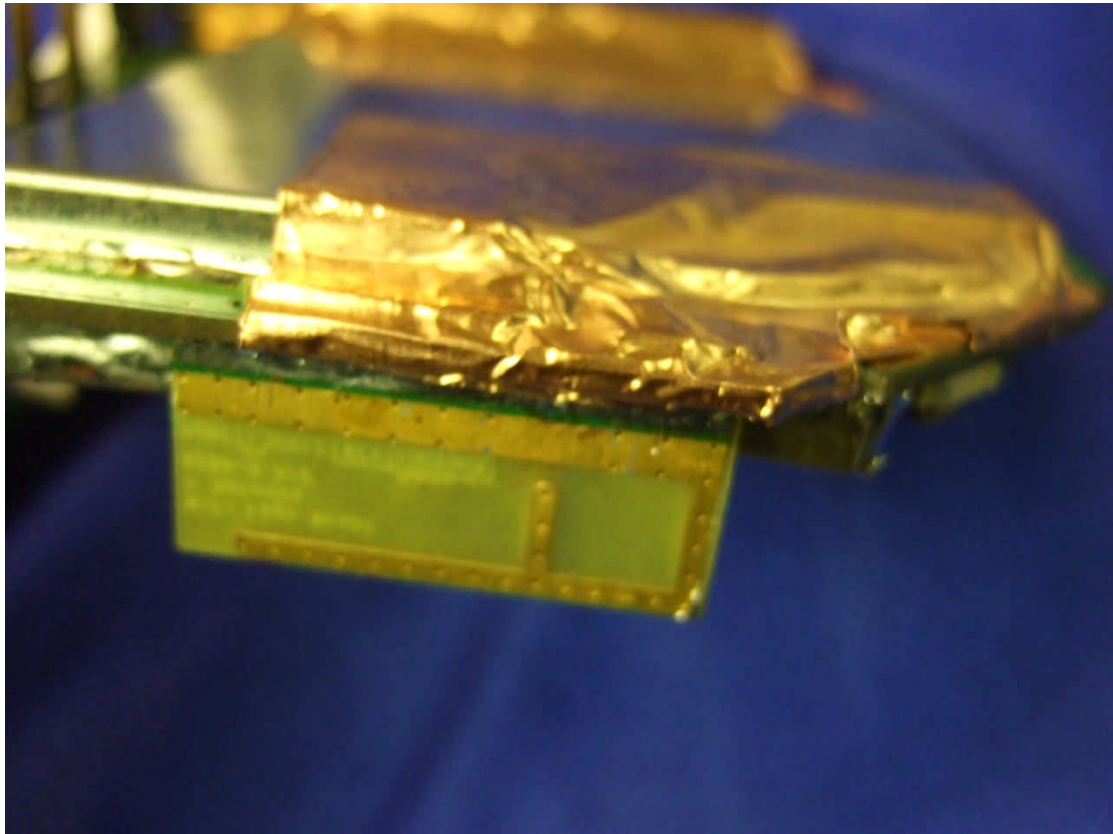

File name PURE.6525-5.DOCM

The contents of this report, apart from the referenced ANSI C63.4-2003, are beyond the scope of UKAS Testing Laboratory No. 2360 accreditation.

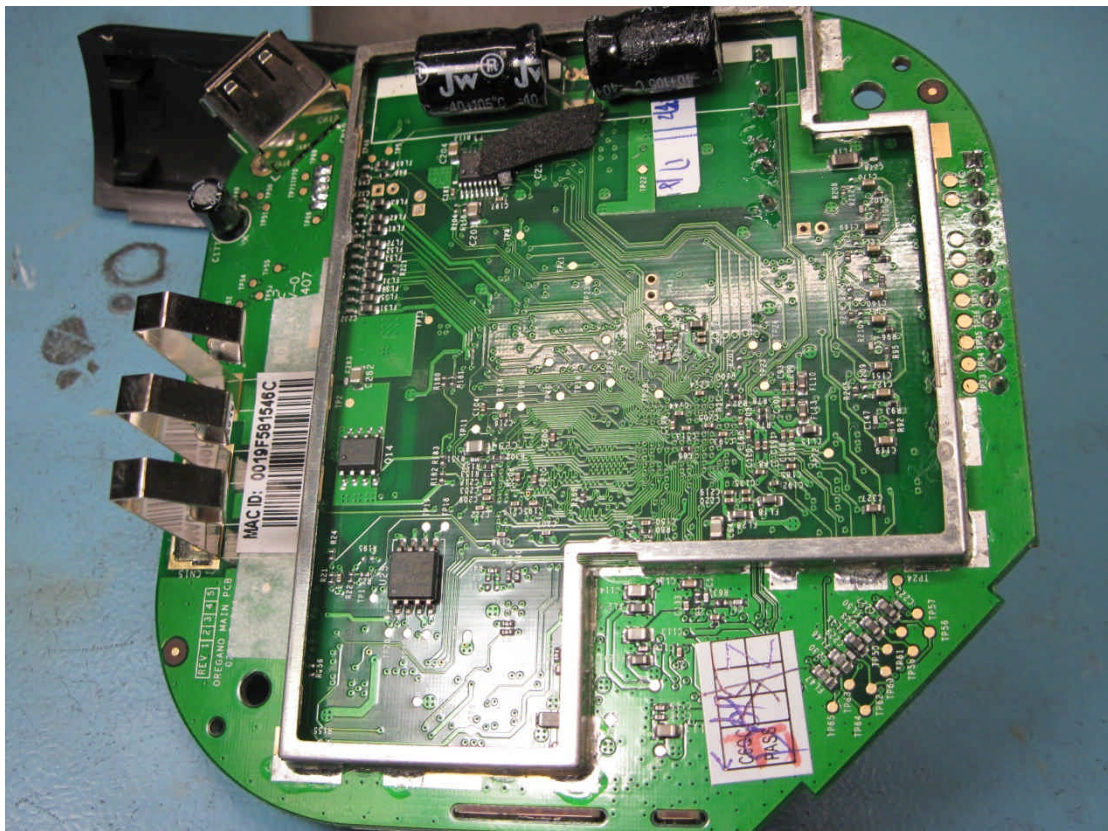
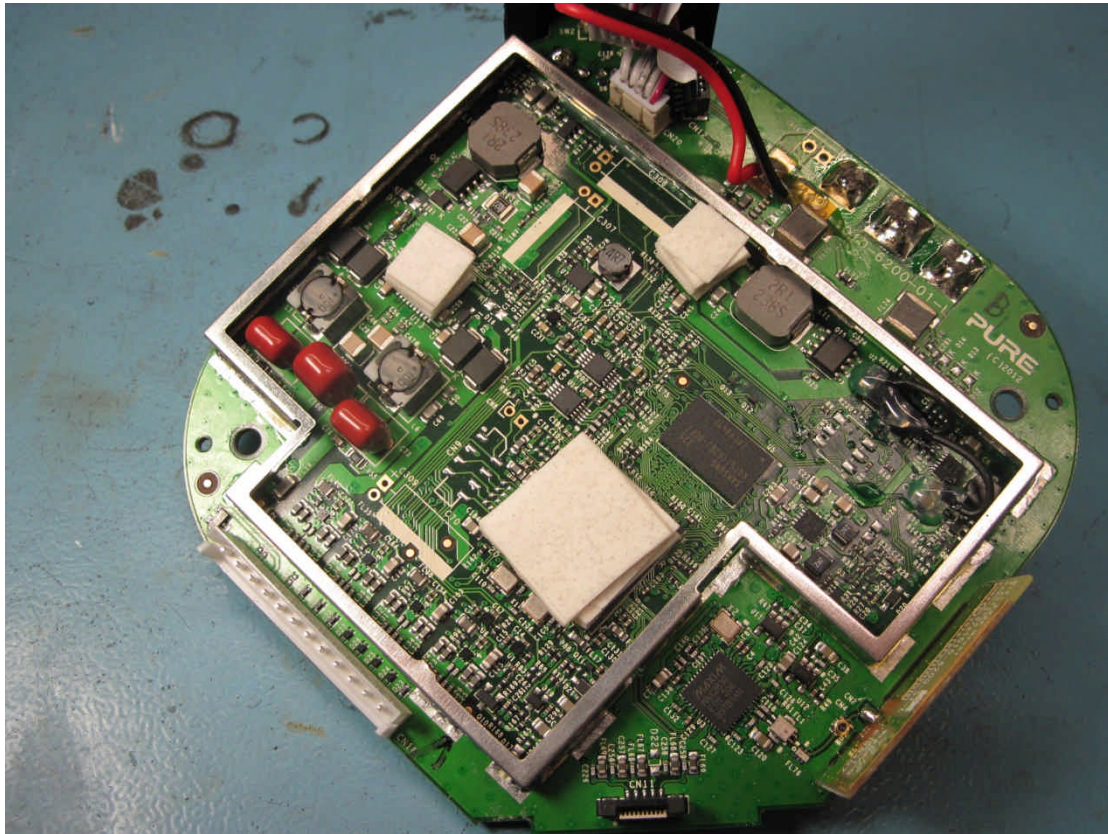

Internal Photographs of the EUT

File name PURE.6525-5.DOCM

The contents of this report, apart from the referenced ANSI C63.4-2003, are beyond the scope of UKAS Testing Laboratory No. 2360 accreditation.

QMF21J – 3; 47CFR15.247, RNE ISSUE 01 SEP 2012

PAGE 137 OF 141

9 Signal Leads

Port Name	Cable Type	Connected
AC_DC Adaptor Mains	AC/DC adaptor plug	Yes
AC_DC Adaptor DC	AC/DC adaptor plug DC out	Yes
EUT DC input	twin cable	Yes
USB	Standard USB	Yes
Auxiliary Input	3.5mm Audio coax	Yes

10 Test Equipment Calibration list

The following table lists the test equipment used, last calibration date and calibration interval. All test equipment used has been maintained within the calibration requirements of **R.N. Electronics Ltd.** test facility quality system. Calibration intervals are regularly reviewed dependent on equipment manufacturer's recommendations and actual usage of the equipment.

RNNo	Model	Description	Manufacturer	Date Calibrated	Period
E035	HP11947A	Transient Limiter + 10dB Atten.	Hewlett Packard	08-Aug-12	6
E150	MN2050	LISN 13A	Chase	02-Oct-12	12
E227	6632A	System DC Power Supply	Hewlett Packard	26-Jan-12	12
E252	6810.19.A	10 dB Attenuator	Suhner	01-May-12	12
E256	44	10 dB Attenuator	Weinschel Engineering	01-Nov-12	12
E266	2032	5.4GHz Signal Generator	Marconi Instruments	28-Jun-12	24
E268	BHA 9118	1-18 GHz Horn Antenna	Schaffner	14-Apr-11	60
E290	6914	Power Sensor	Marconi Instruments	23-Aug-11	24
E342	8563E	Spectrum Analyser 26.5 GHz	HP	29-Mar-11	24
E397	6960B	RF Power Meter	Marconi Instruments	16-Jul-11	24
E410	N5181A	3 GHz MXG Signal Generator	Agilent Technologies	18-Oct-12	12
E411	N9039A	9 kHz - 1 GHz RF Filter Section	Agilent Technologies	18-Oct-12	12
E412	E4440A	3 Hz - 26.5 GHz PSA	Agilent Technologies	18-Oct-12	12
E429	-	5 Switch Filter Box 0.91 GHz - 16.3 GHz	RN Electronics	20-Nov-12	12
E434	G3RUH	10 MHz GPS Oscillator	James Miller	no cal req'd	
E492	N9038A	20Hz - 8.4GHz MXE EMI Receiver	Agilent Technologies	06-Feb-12	12
TMS78	3160-08	Std Gain Horn Antenna 12.4-18 GHz	ETS Systems	03-Nov-12	24
TMS79	3160-09	Std Gain Horn Antenna 18-26.5 GHz	ETS Systems	03-Nov-12	24
TMS81	6502	Active Loop Antenna	EMCO	24-Oct-12	24
TMS82	8449B	Pre Amplifier 1 - 26 GHz	Agilent	19-Nov-12	12
TMS933	CBL6141A	Bilog Antenna 30MHz - 2GHz	York EMC	09-Sep-10	36

11 Auxiliary equipment

11.1 Auxiliary equipment supplied by

Auxiliary equipment used for the purpose of test supplied by the above has been listed below

Item No.	Manufacturer	Description	Model No.	Serial No.
1	Pure	USB Controller module	Modified Highway 300Di	PP061

11.2 Auxiliary equipment supplied by RN Electronics Limited

Auxiliary equipment used for the purpose of test supplied by the above has been listed below

No Auxiliary equipment supplied by RN Electronics Ltd.

File name PURE.6525-5.DOCM

The contents of this report, apart from the referenced ANSI C63.4-2003, are beyond the scope of UKAS Testing Laboratory No. 2360 accreditation.

12 Modifications

In order for the EUT to produce the results shown within this report the following modifications, if any, were implemented.

12.1 Modifications before test

The following modifications were made by a Pure representative before testing commenced:-

- Top side RF can soldered down along its edges where possible.
- RF Can extended with copper tape over the corner of the PCB and soldered down.

12.2 Modifications during test

There were no modifications made by R.N. Electronics Ltd during testing.

13 Compliance information

Products subject to the Declaration of Conformity procedure are required to be supplied with a compliance information statement. A copy of this statement may be included here:

CERTIFIED equipment – DoC not required.

14 Description of Test Sites

Site A	Radio / Calibration Laboratory and anechoic chamber
Site B	Semi-anechoic chamber
Site B1	Control Room for Site B
Site C	Transient Laboratory
Site D	Screened Room (Conducted Immunity)
Site E	Screened Room (Control Room for Site D)
Site F	Screened Room (Conducted Emissions) VCCI Registration No. C-2823
Site K	Screened Room (Control Room for Site M)
Site M	3m Semi-anechoic chamber (indoor OATS) FCC Registration No. 293246
Site Q	Fully-anechoic chamber
Site OATS	3m and 10m Open Area Test Site FCC Registration No. 293246 IC Registration No. 5612A-1 VCCI Registration No. R-2580
Site R	Screened Room (Conducted Immunity)
Site S	Safety Laboratory
Site T	Transient Laboratory

15 Abbreviations and Units

%	Percent	Hz	Hertz
µV	microVolts	IF	Intermediate Frequency
µW	microWatts	kHz	kiloHertz
AC	Alternating Current	LO	Local Oscillator
ALSE	Absorber Lined Screened Enclosure	mA	milliAmps
AM	Amplitude Modulation	max	maximum
Amb	Ambient	mbar	milliBars
ANSI	American National Standards Institute	MHz	MegaHertz
°C	Degrees Celsius	min	minimum
CFR	Code of Federal Regulations	mm	milliMetres
CS	Channel Spacing	ms	milliSeconds
CW	Continuous Wave	mW	milliWatts
dB	decibels	NA	Not Applicable
dBµV	decibels relative to 1µV	nom	Nominal
dBc	decibels relative to Carrier	nW	nanoWatt
dBm	decibels relative to 1mW	OATS	Open Area Test Site
DC	Direct Current	OFDM	Orthogonal Frequency Division Multiplexing
EIRP	Equivalent Isotropic Radiated Power	ppm	Parts per million
ERP	Effective Radiated Power	QAM	Quadrature Amplitude Modulation
EUT	Equipment Under Test	QPSK	Quadrature Phase Shift Keying
FCC	Federal Communications Commission	Ref	Reference
FM	Frequency Modulation	RF	Radio Frequency
FSK	Frequency Shift Keying	RTP	Room Temperature and Pressure
g	Grams	s	Seconds
GHz	GigaHertz	Tx	Transmitter
		V	Volts