

**C1000/C1050**  
**Bluetooth Handsfree Car Kit**  
**User Manual**

# Contents

1.	Using This Guide .....	3
2.	Declaration .....	4
3.	Certification and Safety Approvals .....	5
4.	Introduction .....	7
4.1	Bluetooth Technology .....	7
4.2	About the Mantis C1000/C1050 Bluetooth Handsfree Car Kit .....	7
4.3	Product Specifications .....	8
4.4	Package contents.....	8
5.	Installing the Handsfree Car Kit.....	11
5.1	Tools You Will Need.....	11
5.2	Mount Components .....	11
5.2.1	Mounting Location.....	11
5.2.2	Mount the Control Unit.....	13
5.2.3	Mount the Junction Box/Loudspeaker Box.....	14
5.2.4	Mount the Microphone.....	15
5.3	Connect Components.....	16
5.4	Connect Wires .....	17
6.	Using the Handsfree car Kit.....	18
6.1	Use the Control Unit.....	18
6.2	Turn On/Off the Bluetooth Handsfree Car Kit .....	18
6.2.1	Turn On .....	18
6.2.2	Turn Off .....	19
6.3	Pairing .....	19
6.4	Connecting/Disconnecting.....	20
6.4.1	Connection .....	20
6.4.2	Disconnecting.....	20
6.5	Call Functions.....	20
6.5.1	Accept or Reject and Incoming Call .....	20
6.5.2	Place an Outgoing Call.....	21
6.5.3	End a Call.....	21
6.5.4	Adjust Volume .....	21
6.5.5	Mute the Handsfree Microphone.....	21
6.5.6	Transfer Call from Your Mobile Phone to the Handsfree Car Kit .....	22
6.5.7	Advanced Call Functions .....	22
6.6	AV Mode Functions .....	22
6.6.1	Establish AV Connection .....	22
6.6.2	AV Operations .....	23

# 1. Using This Guide

**This user's guide has been specially designed to guide you through the operation of your device. Before installing or operating this device, please read this manual thoroughly.**

Without written permission from Mantis Wireless Products, reproduction, transfer, distribution or storage of part or all of the contents in this document in any form is prohibited.

Mantis Wireless Products reserves rights to make any changes and improvements to the product described in this document without prior notice.

**Notice:**

**Please make sure your mobile phone supports Bluetooth profiles and network operator supports the functions described in this manual, otherwise the relative functions cannot be realized on this Handsfree device.**

**Copyright Information:**

Rights to all technologies and products that comprise this device are the property of their respective owners.

Bluetooth® is a registered trademark of the Bluetooth SIG, Inc, worldwide.

Bluetooth QD ID: B015010

## 2. Declaration

Always comply with the following precautions and usage tips to avoid dangerous situations and ensure peak performance of your device.

- **Operate Your Vehicle Safely:**

Using any electronic device while driving, especially a mobile phone, can be extremely dangerous. In some locations, using mobile phones while operating a motor vehicle is illegal. Check the laws and regulations on the use of mobile phones and handsfree equipment in the areas where you drive. Always give full attention to driving and pull off the road and park before making or answering a call if driving conditions require.

- **Mount All Equipment Properly:**

Do not install any equipment in any location or fashion that will interfere with normal operation of your vehicle.

- **Avoid Exposing the Device to Extreme Temperatures:**

Do not install the device in very hot, very cold, or very humid environments.

- **Use Only a 12/24V Power Source:**

A power source with an incorrect voltage can seriously damage your device and/or your vehicle.

- **Use Properly-rated Fuses:**

Replace blown fuses with fuses of the same type and size. Never use a fuse with a higher rating.

- **This Device May Cause RF Interference:**

Radio frequency (RF) signals may affect improperly installed or inadequately shielded electronic systems in motor vehicles. If you notice any faults or changes in the operation of your vehicle, contact an authorised repair centre or your vehicle manufacturer immediately.

- **Consult Your Vehicle's User Manual:**

The installation instructions in this guide are general recommendations only. Consult a professional installer or your vehicle's user manual for specific details and considerations about installing this device.

# 3. Certification and Safety Approvals

**This product has been tested and found to comply with Bluetooth BQB requirements, part 15 of FCC rules, R&TTE Directive (99/5/EC) or CE marked requirements.**

**Warning: Users should not make changes or modify the device in any way. Changes or modifications without expressly approved by the party responsible for compliance could void the user's authority to operate the device.**

This device complies with part 15 of the FCC Rules. Operation is subject to the following two conditions: (1) This device may not cause harmful interference, and (2) this device must accept any interference received, including interference that may cause undesired operation.

● **FEDERAL COMMUNICATIONS COMMISSION INTERFERENCE STATEMENT:**

This equipment has been tested and found to comply with the limits for a Class B digital device, pursuant to part 15 of the FCC Rules. These limits are designed to provide reasonable protection against harmful interference in a residential installation. This equipment generates, uses and can radiate radio frequency energy and, if not installed and used in accordance with the instructions, may cause harmful interference to radio communications. However, there is no guarantee that interference will not occur in a particular installation. If this equipment does cause harmful interference to radio or television reception, which can be determined by turning the equipment off and on, the user is encouraged to try to correct the interference by one or more of the following measures:

- Reorient or relocate the receiving antenna.
- Increase the separation between the equipment and receiver.
- Connect the equipment into an outlet on a circuit different from that to which the receiver is connected.
- Consult the dealer or an experienced radio/ TV technician for help.

● **CAUTION:**

Any changes or modifications not expressly approved by the grantee of this device could void the user's authority to operate the equipment.

● **RF exposure warning:**

The equipment complies with FCC RF exposure limits set forth for an uncontrolled environment.

The equipment must not be co-located or operating in conjunction with any other antenna or transmitter.

● **CE command:**

EN 301 489-17 v1.2.1: 2002

ETSI EN 300 328 v1.6.1:2004

IEC 60950-1:2001 / EN 60950-1:2001

## 4. Introduction

Congratulations on your purchase of the Mantis C1000/C1050 Bluetooth Handsfree Car Kit. It's convenient features will allow you to enjoy safe, handsfree communication while on the move. This user's manual describes steps for installing and using your new Bluetooth Handsfree Car Kit. To ensure proper installation and use of the Bluetooth Handsfree Car Kit, please read this manual thoroughly before installing or using the device.

### 4.1 Bluetooth Technology

Bluetooth is an internationally standardized technology supporting short distance wireless communications. Any two Bluetooth-compatible equipments, such as mobile phone, PDA, PC, headset, mouse, keyboards, printer, etc. can wirelessly communicate with each other via Bluetooth connection. To ensure worldwide compatibility, Bluetooth operates on the globally available Industrial Scientific and Medical (ISM) frequency band. Within 2.4 GHz and 2.48 GHz, Bluetooth transmits data up to either 10 meters (CLASS II mode) or 100 meters (CLASS I mode) using 79 frequency hopping channels.

Though line-of-sight is not required, Bluetooth connections could be subject to interferences from obstructions such as walls, human bodies, and other electronic devices. In addition, due to variations on product implementation, it is likely that Bluetooth equipments from different manufactures have interoperability issues. In that case, you may consult with manufactures to check product compatibility.

Note that, there could be some restrictions imposing on using Bluetooth devices in some countries. Please check with your local authorities.

### 4.2 About the Mantis C1000/C1050 Bluetooth Handsfree Car Kit

The Mantis C1000/C1050 Bluetooth Handsfree Car Kit is compatible with Bluetooth-enabled mobile phones that have a Bluetooth headset profile and a Bluetooth handsfree profile. Although the Mantis C1000/C1050 Bluetooth Handsfree Car Kit will operate with many mobile phones, some features may not be available or supported for some types of mobile phones. If you have questions about using the Mantis C1000/C1050 Bluetooth Handsfree Car Kit with a mobile phone, consult your phone's user guide, the manufacturer's website, or your mobile phone dealer.

### 4.3 Product Specifications

- Bluetooth V2.0 compliant, Class II, operating range up to 10 meters
- Use either car stereo system or supplied External Speaker for audio (C1050)
- Dashboard mounted LCD display and control panel
- Display Caller ID, Call Status, etc
- Automatically mutes audio for incoming calls
- Supports mobile phone based voice commands including voice dialing
- Pairs with up to 8 Bluetooth handsets and/or devices
- DSP noise and echo suppression technology
- Listen to MP3 files stored on cell phone – via Bluetooth (A2DP and AVRCP) audio streaming
- Bluetooth audio playback pause during active calls and resumes afterward
- Complies with all Hands-free laws

### 4.4 Package contents

Ensure your package includes all the items shown below.

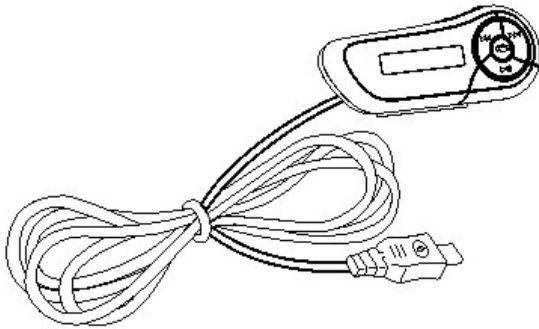

Wired Control Unit x 1

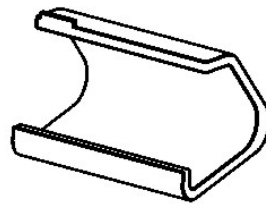

Bracket x 1

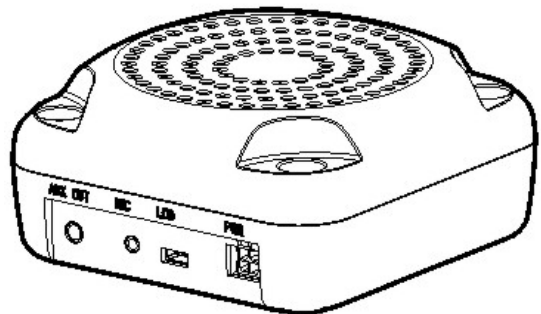
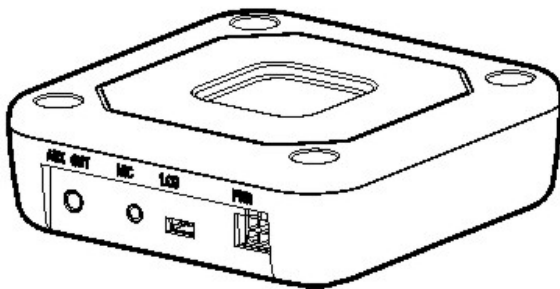



Junction Box x 1 (for C1000)

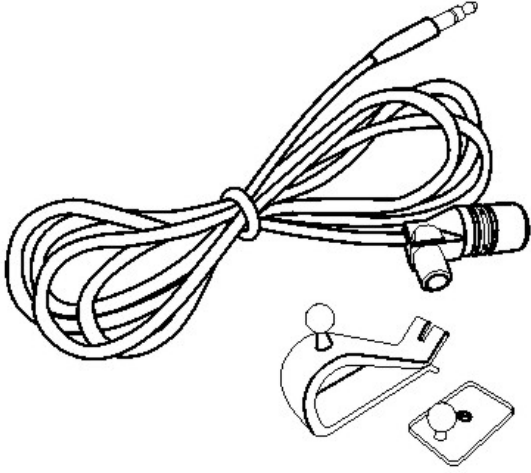

Loudspeaker Box x 1 (for C1050)

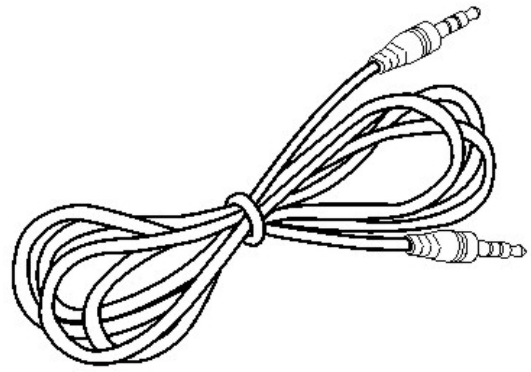

Microphone(with Mounting Clip and Mounting Plates) x 1

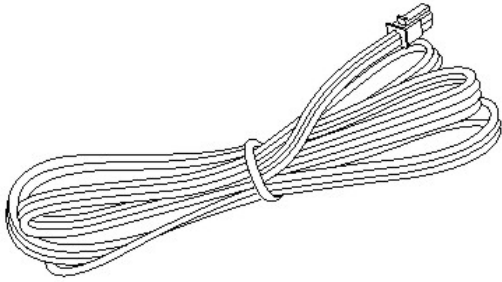

Audio Out Cable x 1

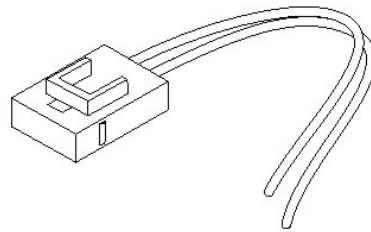

Wiring Harness x 1

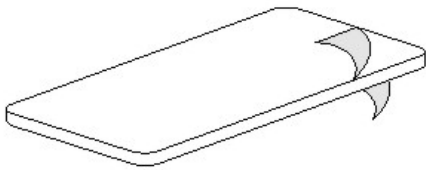

Fuse x 1

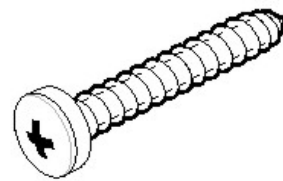

Double Side Tapes x 2

Screws x 5

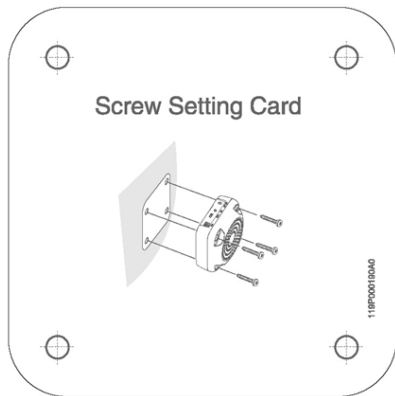

Screw Setting Card x 1

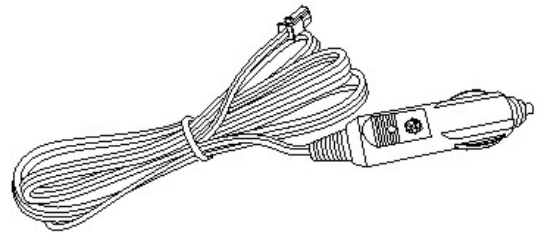

Cigarette Lighter Adapter(CLA) x 1 (for C1050)

# 5. Installing the Handsfree Car Kit

To prevent damage to your vehicle or its components, we highly recommend you have the C1000/C1050 Bluetooth Handsfree Car Kit installed by a professional installer. The installation instructions in this guide are recommendations only. Mantis is not responsible for any damage to your vehicle or the device that result from improper installation or operation.

*Note:*

*Consult your vehicle 's owner ' s manual before beginning installation of any aftermarket device. Improperly connecting this device to your vehicle ' s ignition system, stereo, and battery can cause other systems to malfunction or perform unpredictably.*

## 5.1 Tools You Will Need

The Handsfree Car Kit comes supplied with all necessary components. You will need the following items to install the Handsfree Car Kit in your vehicle:

- Electric drill and drill bits
- Star-blade screwdriver
- Wire stripper/crimper tool
- Electrical tape

## 5.2 Mount Components

### 5.2.1 Mounting Location

Choose suitable mounting locations for all components before beginning the installation. The following diagrams show recommended and alternate locations of each component.

*Notes:*

*Do not mount components in any location that interferes with safe operation of the vehicle. Mount the remote control in a location that is easily reachable and visible while driving, but does not obscure or impair control or proper operation of the vehicle. Ensure that the installation of components does not damage any electrical or mechanical system of your vehicle.*

- **Recommended Mounting Locations**

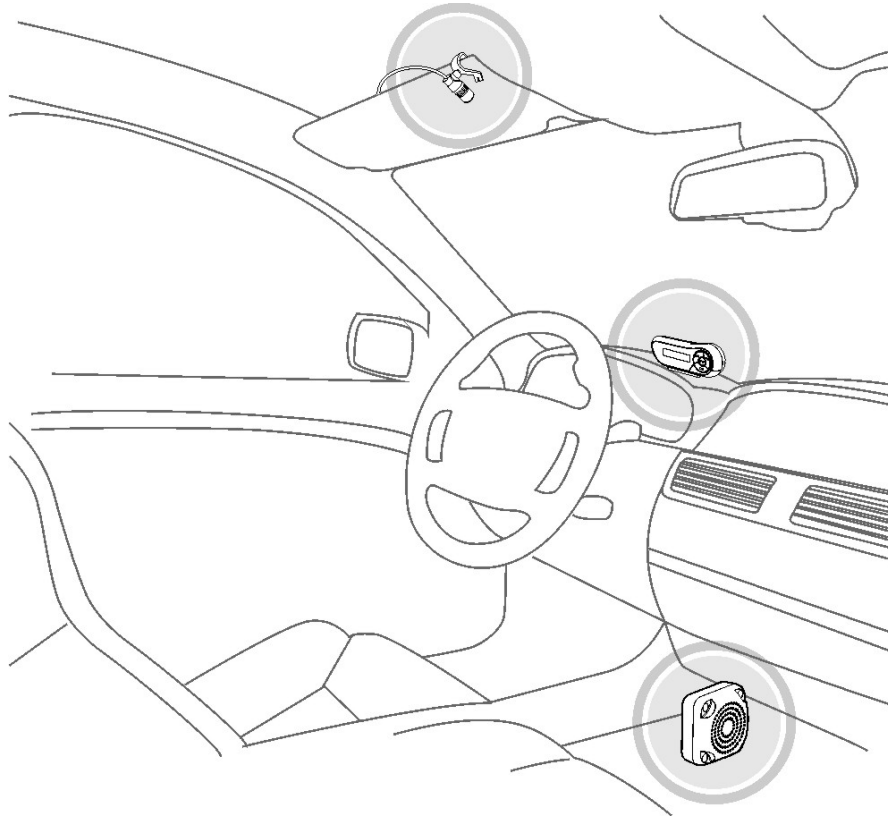

- **Alternate Mounting Locations for Control Unit and Junction Box/Loudspeaker Box**

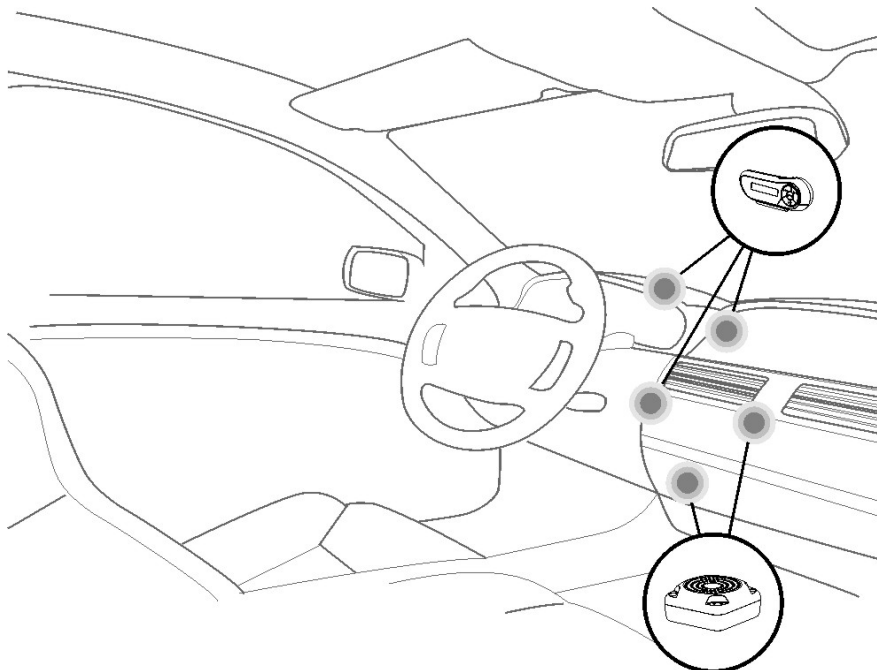

- **Alternate Mounting Location for Microphone**

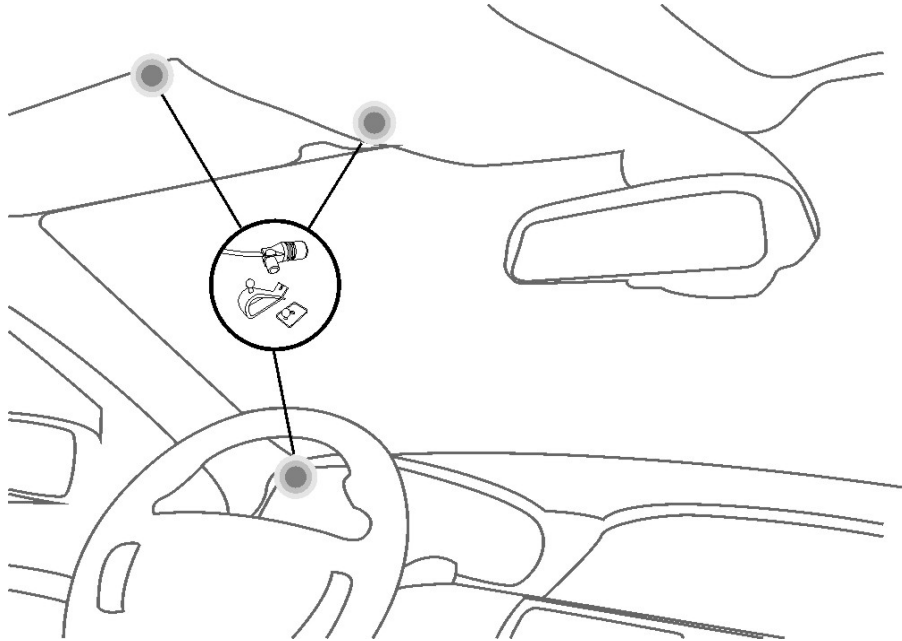

### 5.2.2 Mount the Control Unit

- **Mount the Control Unit with the Bracket**

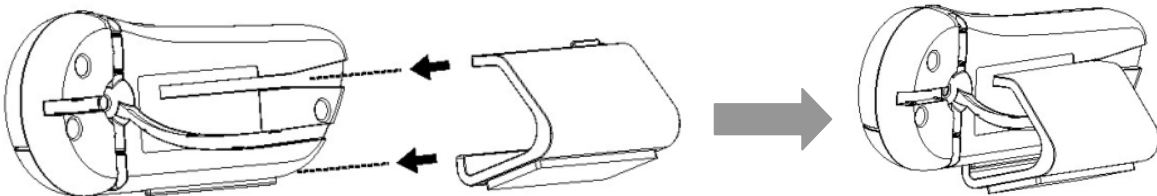

1. Ensure the surface where you will mount the Control Unit is clean and dry.
2. Slid the Bracket into the Control Unit.
3. Tear the paper off from the double-side sticker on the bracket and apply it to the mounting location. Press firmly to ensure it is securely attached.

- **Mount the Control Unit with the Double-side sticker**

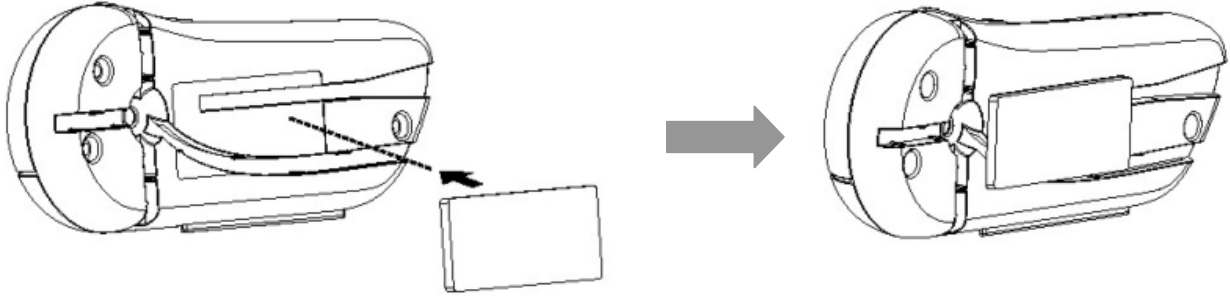

1. Ensure the surface where you will mount the Control Unit is clean and dry.
2. Place the wire of the Control Unit into one of the grooves which you want.
3. Tear the paper off from one side of the supplied Double-side sticker and apply it to the back of the Control Unit. Press firmly to ensure it is securely attached.
4. Tear the paper off from the other side of the double side tape and apply it to the mounting location. Press firmly to ensure it is securely attached.

### **5.2.3 Mount the Junction Box/Loudspeaker Box**

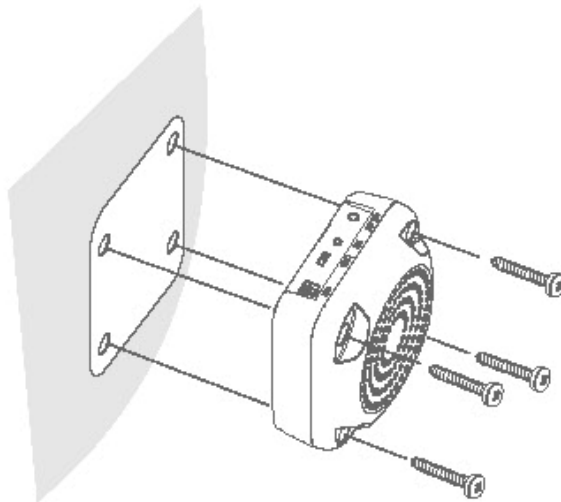

1. Position the Screws Setting Card in the location which you want to place the Junction Box/Loudspeaker Box.
2. Carefully drill holes with the help of Screws Setting Card.
3. Attach the Junction Box/Loudspeaker Box to the vehicle using the supplied screws. Tighten the screws firmly to avoid vibration while driving.

## 5.2.4 Mount the Microphone

- **Mount the Microphone to the Sun Visor**

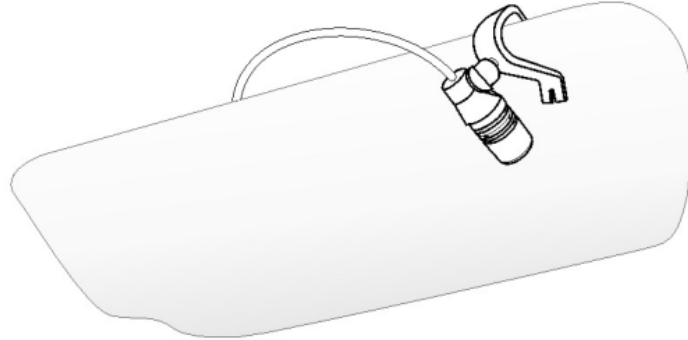

1. Fasten the mounting clip to the sun visor.
2. Mount the microphone to the mounting clip.

- **Mount the Microphone to the Dash Board**

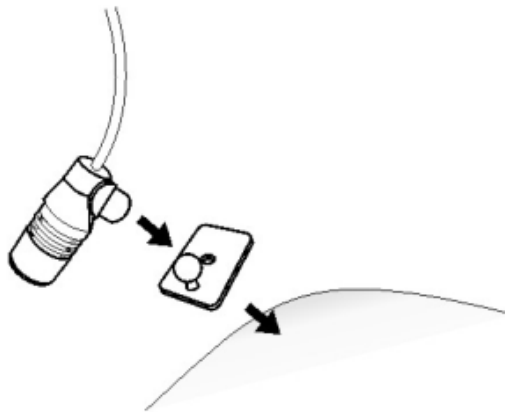

1. Ensure the surface where you will mount the microphone is clean and dry.
2. Tear the paper off from one side of the tape on the mounting plate and apply it to the mounting location. Press firmly to ensure it is securely attached.
3. Use the supplied screw to attach the mounting plate more firmly.
4. Mount the microphone to the mounting plate.

### 5.3 Connect Components

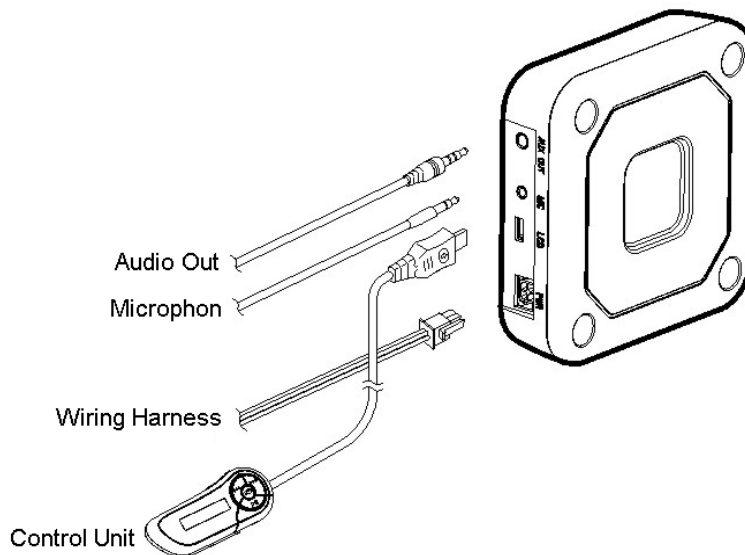

**Connect Diagram for C1000**

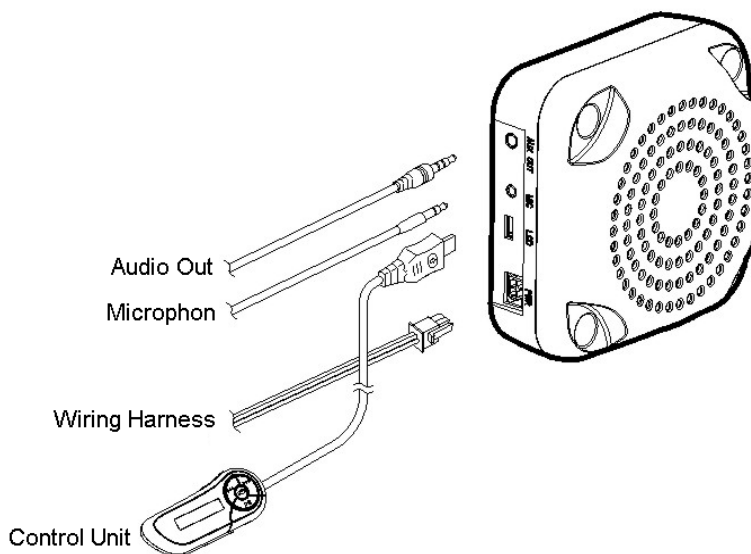

**Connect Diagram for C1050**

Connect all components as shown in the diagram. Ensure that all connecting wires are properly secured and do not interfere with normal operation of the vehicle or impair visibility.

*Note:*

*For C1000, you need to use an external speaker via the supplied Audio Out Cable.*

*For C1050, you can either use the Loudspeaker box directly or use another external speaker via the supplied Audio Out Cable.*



## 5.4 Connect Wires

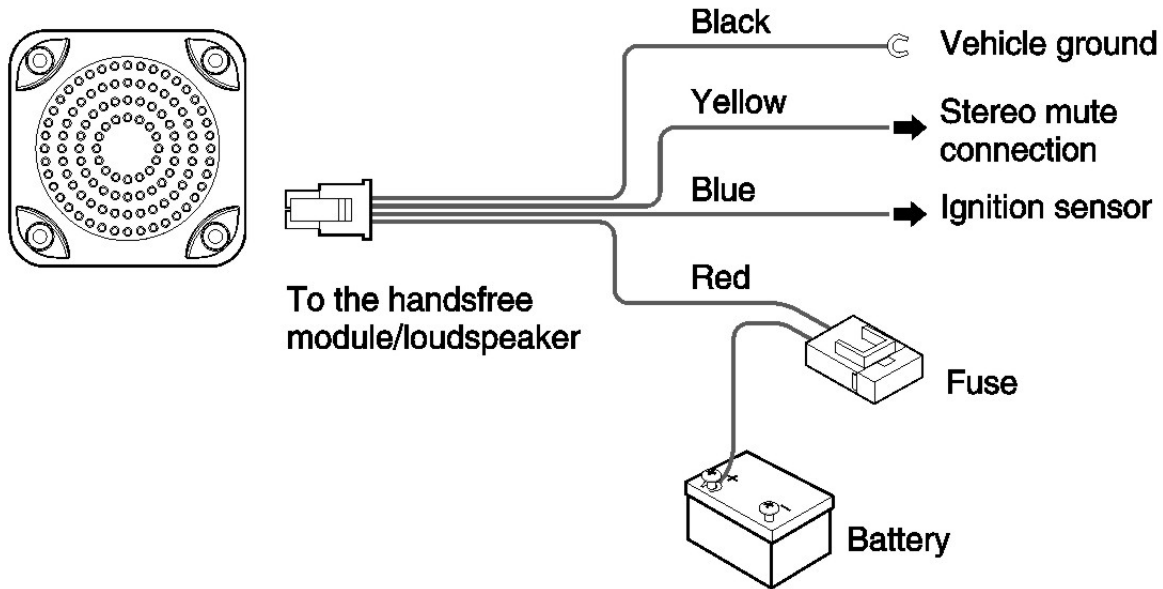

The supplied wiring harness includes four wires for connecting the Handsfree Car Kit to your vehicle:

- Black(Ground): connect this wire to the vehicle ground (GND).
- Yellow(Mute): connect this wire to the Mute connection of your car stereo.
- Blue(Ignition): connect this wire to your vehicle' s ignition sensor (see your vehicle' s user guide for more information).
- Red(Battery): connect this wire to your vehicle' s power source or battery (positive terminal); the supplied fuse holder may be wired between the Handsfree Car Kit and the vehicle battery to prevent overload to the device.

*Note:*

1. *Improperly connecting wires to your vehicle can cause damage to the Handsfree Car Kit or vehicle systems. Consult your vehicle' s user manual or a professional for installation advice. Always disconnect the vehicle' s battery before wiring electronic devices and use extreme caution when working around vehicle batteries.*
2. *For C1050, you can also use the supplied Cigarette Lighter Adapter(CLA) to supply the power for the Handsfree Car Kit directly and simply. In this case, your stereo will not be muted automatically during a call, you need to turn the stereo down or off before answering an incoming call.*

# 6. Using the Handsfree car Kit

## 6.1 Use the Control Unit

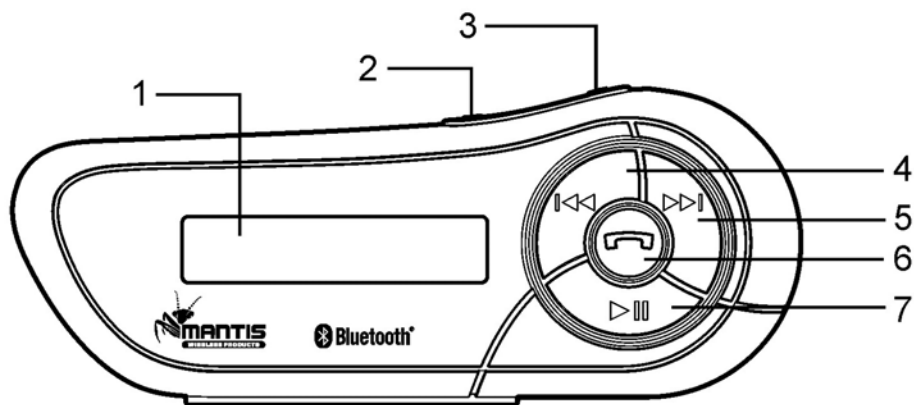

1. LCD Screen: Displays caller ID, call status, etc.
2.  $-$ : The “Volume down” button allows you to decrease the volume of the Handsfree Car Kit’s loudspeaker and mutes or unmutes the microphone during a call.
3.  $+$ : The “Volume up” button allows you to increase the volume of the Handsfree Car Kit’s loudspeaker and mutes or unmutes the microphone during a call.
4.  $\ll$ : The “Backward” button allows you to backward to the previous song or fast backward during music playing.
5.  $\gg$ : The “Forward” button allows you to forward to the next song or fast forward during music playing.
6. : Multi-function button: The “Multi-function” button allows you to dial, redial, accept, end, reject, hold or retrieve a call, or switch from your mobile phone to the Handsfree Car Kit..
7.  $\triangleright||$ : The “Forward” button allows you to play or pause the music.

## 6.2 Turn On/Off the Bluetooth Handsfree Car Kit

### 6.2.1 Turn On

Turn on the vehicle to supply power to the Bluetooth Handsfree Car Kit, you will see  displayed on the screen. This indicates the Handsfree Car Kit is power on.

*Note:*

*The first time you turn on the Handsfree Car Kit, the device will enter pairing mode in 2 seconds.*

### **6.2.2 Turn Off**



Turn off the vehicle to disconnect power supply to turn off the Bluetooth Handsfree Car Kit.

*Note:*

*For C1050, if you use the supplied Cigarette Lighter Adapter(CLA) to supply the power for the Handsfree Car Kit, you can just plug out the CLA from the Cigarette Lighter to turn off the Handsfree Car Kit.*

## **6.3 Pairing**

Before making and answering calls, you must pair your Bluetooth Handsfree Car Kit with your Bluetooth mobile phone. Pairing operations are as follows:

1. Place your mobile phone close to your Bluetooth Handsfree Car Kit, and ensure both your mobile phone and Handsfree Car Kit are power on.
2. Press and hold button  for at least 4 seconds until you hear pairing tones to indicate that the Handsfree Car Kit has successfully entered the paring mode.  will appear on the screen and Blue LED will be on. (The first time you turn on the Bluetooth Handsfree Car Kit, skip this step.)
3. Following your mobile phone's user guide to activate Bluetooth device search on the phone side, after the searching process you will see a list of Bluetooth equipment on your phone screen .Select this Bluetooth handsfree "MANTIS" from the list, and follow the instruction of your mobile phone to initiate pairing. Enter passkey "0000"and confirm to pair the Handsfree Car Kit with your handset. Once the pairing process is completed, you will hear indicating tones, and then Blue LED will be off. It indicates that the Handsfree Car Kit and the mobile phone are paired.





*Note :*

*Your handsfree will remain in the pairing mode for about 3 minutes. If paring cannot be finished within 3 minutes, the handsfree will enter into the standby mode (without Bluetooth connection in this case), and  will disappear from the screen. You need to repeat the above steps to restart the pairing process.*

## 6.4 Connecting/Disconnecting

Before making and answering calls, the Bluetooth Handsfree Car Kit must connect with your Bluetooth mobile phone.

### 6.4.1 Connection

The Bluetooth Handsfree Car Kit will attempt to make an automatic connection to your mobile phone after you have paired the devices as instructed above. If the connection is not established successfully, you can either press  to initiate a connection request or follow your mobile phone's user guide to connect the Handsfree Car Kit from the mobile phone.  will appear on the screen in the course of connecting. When the connection is established, you will hear indicating tones and  icon will appear on the screen. This indicates HF/HS connection has been successfully established between the Handsfree Car Kit and your mobile phone. If your mobile phone supports Bluetooth A2DP function, you can press  to initiate A2DP connection with your handset. Once A2DP connection is established,  will appear on the screen to indicate A2DP connection has been established between the Handsfree Car Kit and your mobile phone.

*Note:*

*Some mobile phone will get connected to A2DP as well as HF simultaneously.*





### 6.4.2 Disconnecting

When HF connection has been established between the Handsfree Car Kit and the mobile phone, you can follow your mobile phone user guide to disconnect from the mobile phone side.

After disconnected, you will hear indicating tone and  or  will disappear from the screen.

## 6.5 Call Functions

### 6.5.1 Accept or Reject and Incoming Call

When a call comes in,  will appear on the screen of the Handsfree Car Kit and then Caller ID will occur. You can either answer the call by short pressing  button or reject the call by pressing and holding the button  for one second.  will appear on the screen if the call is activated or  will appear if the call is rejected.

*Note:*

*If your Handsfree Car Kit is properly connected to your stereo's mute connection, an incoming call will automatically mute your stereo. If your stereo does not mute automatically, turn the stereo down or off before answering an incoming call.*

### **6.5.2 Place an Outgoing Call**

The Bluetooth Handsfree Car Kit is designed to allow you safe, handsfree operation of a mobile phone while driving. If you must place an outgoing call, we suggest you do so while parked.

You may place an outgoing call using the Handsfree Car Kit or your mobile phone's handset. Once the HF connection is established between the Handsfree Car Kit and your mobile phone, you may operate the Handsfree Car Kit in the following sections.

- **Make a Voice-activated Call**

If the voice recognition feature is on, you can make a voice-activated call:

1. Press and hold button  for at least 1 second to activate voice dialing.
2. Say the name of the person you wish to call.



*Note:*

*Depending on your mobile phone, this feature may not be support. Please refer to your mobile phone manual for detailed descriptions on how to set up voice dialing.*



- **Redial a Number**

The Handsfree Car Kit allows you to redial the last number you called easily by short pressing the button .



*Note:*

*Depending on your mobile phone. Some types of mobile phones, especially Samsung's mobile phone, the first time you press the button  it just display the call logs. In this case you may need press the button  again to redial the last number.*

### **6.5.3 End a Call**







To end a call, press the button .  will appear on the screen of the Handsfree Car Kit.

### **6.5.4 Adjust Volume**



When on an active call or music play mode, you can adjust sound volume up or down by pressing  or . The current volume will appear on the screen and last for one second when the adjustment has been finished.

### **6.5.5 Mute the Handsfree Microphone**

When using the Handsfree Car Kit, you can mute or unmute the handsfree microphone:





1. Press and hold the button  or ,  will appear on the screen.
2. To unmute the microphone, press and hold the button  or  again,  will disappear from the screen.

### 6.5.6 Transfer Call from Your Mobile Phone to the Handsfree Car Kit

If you want to transfer the call from your mobile phone to Handsfree Card Kit, press the button . The screen will display .

### 6.5.7 Advanced Call Functions

If your mobile phone has call waiting/conference functions, this Bluetooth Handsfree Car Kit can support these functions via the following operations:

1. When a new call comes in while you are in talk:
  - 1) Press and hold button  for at least 1 second to hold the active call and accept the new incoming call.
  - 2) Press  to reject new incoming call.
2. When two calls are in progress, one is active and the other is on hold:
  - 1) Press and hold button  for at least 1 second to toggle between the held call and the active call. If two or more held calls exist, repeat this operation to toggle the active call to another held call.
  - 2) Press button  to end the active call and accept the held call. If two or more held calls exist, repeat this operation to receive all the existing held calls one by one.

## 6.6 AV Mode Functions

This product supports AV Mode functions. When connected with a Bluetooth-enabled mobile phone or music player which must support A2DP profile, the product allows users to enjoy and remotely play stereo music from the player.

### 6.6.1 Establish AV Connection



If your handset supports Bluetooth A2DP profiles, you can establish A2DP connection between the Handsfree Car Kit and your mobile phone/music player to enjoy music on the Handsfree Car Kit while the music is played by the mobile phone/music player. Depending on you mobile phone/music player, the AV connection could be established automatically when you start playing music.

If A2DP connection is established between the Handsfree Car Kit and your mobile phone/music player, indicating icon  will appear on the screen. If your mobile phone/music player supports A2DP profile but fails the



connection while playing music, you need to follow the user guide of your mobile phone/music player to establish A2DP connection in advance of playing music.

## 6.6.2 AV Operations

If your mobile phone/music player supports Bluetooth A2DP profile as well as AVRCP profile, you can use the Handsfree Car Kit to remotely control your mobile phone/music player for music playing through following operations.



**Play:** Press . The screen displays .



**Pause:** Press . The screen displays .

**Stop:** Press and hold  for at least 1 second.  disappears from the screen.

**Volume up:** Press . The screen displays current volume.

**Volume down:** Press . The screen displays current volume.

**Backward:** Press . The screen displays .

**Forward:** Press . The screen displays .

*Note: In AV mode, if a call comes in, the music will be paused automatically and you can receive or reject calls at this time. When the call is finished, paused music will go on playing automatically.*