



A D T

FCC TEST REPORT (15.247)

REPORT NO.: RF110412C04

MODEL NO.: HiveAP 330

FCC ID: WBV-HIVEAP330

RECEIVED: Apr. 11, 2011

TESTED: Apr. 15 ~ Jun. 23, 2011

ISSUED: Jun. 30, 2011

APPLICANT: Aerohive Networks Inc.

ADDRESS: 330 Gibraltar Drive Sunnyvale, CA 94089 United States

ISSUED BY: Bureau Veritas Consumer Products Services (H.K.) Ltd., Taoyuan Branch

LAB ADDRESS: No. 47, 14th Ling, Chia Pau Tsuen, Lin Kou Hsiang, Taipei Hsien 244, Taiwan, R.O.C.

TEST LOCATION: No. 19, Hwa Ya 2nd Rd, Wen Hwa Tsuen, Kwei Shan Hsiang, Taoyuan Hsien 333, Taiwan, R.O.C.

This test report consists of 155 pages in total. It may be duplicated completely for legal use with the approval of the applicant. It should not be reproduced except in full, without the written approval of our laboratory. The client should not use it to claim product, certification, approval or endorsement by TAF or any government agency. The test results in the report only apply to the tested sample.





TABLE OF CONTENTS

RELEASE CONTROL RECORD.....	5
1. CERTIFICATION.....	6
2. SUMMARY OF TEST RESULTS	7
2.1 MEASUREMENT UNCERTAINTY	7
3. GENERAL INFORMATION.....	8
3.1 GENERAL DESCRIPTION OF EUT	8
3.2 DESCRIPTION OF TEST MODES	10
3.2.1 CONFIGURATION OF SYSTEM UNDER TEST	11
3.2.2 TEST MODE APPLICABILITY AND TESTED CHANNEL DETAIL	12
3.3 GENERAL DESCRIPTION OF APPLIED STANDARDS	16
3.4 DESCRIPTION OF SUPPORT UNITS	16
4. TEST TYPES AND RESULTS (FOR 2.4GHz BAND)	17
4.1 RADIATED EMISSION MEASUREMENT	17
4.1.1 LIMITS OF RADIATED EMISSION MEASUREMENT.....	17
4.1.2 TEST INSTRUMENTS.....	18
4.1.3 TEST PROCEDURES	19
4.1.4 DEVIATION FROM TEST STANDARD.....	19
4.1.5 TEST SETUP.....	20
4.1.6 EUT OPERATING CONDITIONS	20
4.1.7 TEST RESULTS	21
4.2 CONDUCTED EMISSION MEASUREMENT	35
4.2.1 LIMITS OF CONDUCTED EMISSION MEASUREMENT.....	35
4.2.2 TEST INSTRUMENTS.....	35
4.2.3 TEST PROCEDURES	36
4.2.4 DEVIATION FROM TEST STANDARD.....	36
4.2.5 TEST SETUP.....	37
4.2.6 EUT OPERATING CONDITIONS	37
4.2.7 TEST RESULTS	38
4.3 6dB BANDWIDTH MEASUREMENT.....	42
4.3.1 LIMITS OF 6dB BANDWIDTH MEASUREMENT	42
4.3.2 TEST INSTRUMENTS.....	42
4.3.3 TEST PROCEDURE.....	42
4.3.4 DEVIATION FROM TEST STANDARD.....	42
4.3.5 TEST SETUP.....	43
4.3.6 EUT OPERATING CONDITIONS	43
4.3.7 TEST RESULTS	44
4.4 MAXIMUM OUTPUT POWER	48



4.4.1	LIMITS OF MAXIMUM OUTPUT POWER MEASUREMENT.....	48
4.4.2	INSTRUMENTS.....	48
4.4.3	TEST PROCEDURES	48
4.4.4	DEVIATION FROM TEST STANDARD.....	49
4.4.5	TEST SETUP.....	49
4.4.6	EUT OPERATING CONDITIONS	49
4.4.7	TEST RESULTS	50
4.5	POWER SPECTRAL DENSITY MEASUREMENT	51
4.5.1	LIMITS OF POWER SPECTRAL DENSITY MEASUREMENT	51
4.5.2	TEST INSTRUMENTS.....	51
4.5.3	TEST PROCEDURE.....	51
4.5.4	DEVIATION FROM TEST STANDARD.....	52
4.5.5	TEST SETUP.....	52
4.5.6	EUT OPERATING CONDITION.....	52
4.5.7	TEST RESULTS	53
4.6	BAND EDGES MEASUREMENT	57
4.6.1	LIMITS OF BAND EDGES MEASUREMENT.....	57
4.6.2	TEST INSTRUMENTS.....	57
4.6.3	TEST PROCEDURE.....	58
4.6.4	DEVIATION FROM TEST STANDARD.....	58
4.6.5	EUT OPERATING CONDITION.....	58
4.6.6	TEST RESULTS	59
5.	TEST TYPES AND RESULTS (FOR 5.0GHz BAND).....	91
5.1	RADIATED EMISSION MEASUREMENT	91
5.1.1	LIMITS OF RADIATED EMISSION MEASUREMENT.....	91
5.1.2	TEST INSTRUMENTS.....	92
5.1.3	TEST PROCEDURES	93
5.1.4	DEVIATION FROM TEST STANDARD.....	93
5.1.5	TEST SETUP.....	94
5.1.6	EUT OPERATING CONDITIONS	94
5.1.7	TEST RESULTS	95
5.2	CONDUCTED EMISSION MEASUREMENT	105
5.2.1	LIMITS OF CONDUCTED EMISSION MEASUREMENT.....	105
5.2.2	TEST INSTRUMENTS.....	105
5.2.3	TEST PROCEDURES	106
5.2.4	DEVIATION FROM TEST STANDARD.....	106
5.2.5	TEST SETUP.....	107
5.2.6	EUT OPERATING CONDITIONS	107
5.2.7	TEST RESULTS	108
5.3	6dB BANDWIDTH MEASUREMENT.....	112



A D T

5.3.1	LIMITS OF 6dB BANDWIDTH MEASUREMENT	112
5.3.2	TEST INSTRUMENTS.....	112
5.3.3	TEST PROCEDURE.....	112
5.3.4	DEVIATION FROM TEST STANDARD.....	113
5.3.5	TEST SETUP.....	113
5.3.6	EUT OPERATING CONDITIONS	113
5.3.7	TEST RESULTS	114
5.4	MAXIMUM OUTPUT POWER.....	117
5.4.1	LIMITS OF MAXIMUM OUTPUT POWER MEASUREMENT.....	117
5.4.2	INSTRUMENTS.....	117
5.4.3	TEST PROCEDURES	117
5.4.4	DEVIATION FROM TEST STANDARD.....	118
5.4.5	TEST SETUP.....	118
5.4.6	EUT OPERATING CONDITIONS	118
5.4.7	TEST RESULTS	119
5.5	POWER SPECTRAL DENSITY MEASUREMENT.....	120
5.5.1	LIMITS OF POWER SPECTRAL DENSITY MEASUREMENT	120
5.5.2	TEST INSTRUMENTS.....	120
5.5.3	TEST PROCEDURE.....	120
5.5.4	DEVIATION FROM TEST STANDARD.....	121
5.5.5	TEST SETUP.....	121
5.5.6	EUT OPERATING CONDITION.....	121
5.5.7	TEST RESULTS	122
5.6	BAND EDGES MEASUREMENT	125
5.6.1	LIMITS OF BAND EDGES MEASUREMENT.....	125
5.6.2	TEST INSTRUMENTS.....	125
5.6.3	TEST PROCEDURE.....	126
5.6.4	DEVIATION FROM TEST STANDARD.....	127
5.6.5	EUT OPERATING CONDITION.....	127
5.6.6	TEST RESULTS	127
6.	PHOTOGRAPHS OF THE TEST CONFIGURATION.....	153
7.	INFORMATION ON THE TESTING LABORATORIES	154
8.	APPENDIX A - MODIFICATIONS RECORDERS FOR ENGINEERING CHANGES TO THE EUT BY THE LAB.....	155



A D T

RELEASE CONTROL RECORD

ISSUE NO.	REASON FOR CHANGE	DATE ISSUED
Original release	N/A	Jun. 30, 2011



A D T

1. CERTIFICATION

PRODUCT: Wireless Access Points
MODEL NO.: HiveAP 330
BRAND: Aerohive
APPLICANT: Aerohive Networks Inc.
TESTED: Apr. 15 ~ Jun. 23, 2011
TEST SAMPLE: ENGINEERING SAMPLE
STANDARDS: **FCC Part 15, Subpart C (Section 15.247)**
ANSI C63.4-2003
ANSI C63.10-2009

The above equipment (model: HiveAP 330) has been tested by **Bureau Veritas Consumer Products Services (H.K.) Ltd., Taoyuan Branch**, and found compliance with the requirement of the above standards. The test record, data evaluation & Equipment Under Test (EUT) configurations represented herein are true and accurate accounts of the measurements of the sample's EMC characteristics under the conditions specified in this report.

PREPARED BY :  , DATE : Jun. 30, 2011
Joanna Wang / Senior Specialist

APPROVED BY :  , DATE : Jun. 30, 2011
Gary Chang / Assistant Manager



2. SUMMARY OF TEST RESULTS

The EUT has been tested according to the following specifications:

APPLIED STANDARD: FCC PART 15, SUBPART C (SECTION 15.247)			
STANDARD SECTION	TEST TYPE AND LIMIT	RESULT	REMARK
15.207	AC Power Conducted Emission	PASS	Meet the requirement of limit. Minimum passing margin is -5.63dB at 0.150MHz.
15.247(a)(2)	Spectrum Bandwidth of a Direct Sequence Spread Spectrum System Limit: min. 500kHz	PASS	Meet the requirement of limit.
15.247(b)	Maximum Output Power Limit: max. 30dBm	PASS	Meet the requirement of limit.
15.247(d)	Radiated Emissions Limit: Table 15.209	PASS	Meet the requirement of limit. Minimum passing margin is -0.9dB at 5000.00MHz.
15.247(e)	Power Spectral Density Limit: max. 8dBm	PASS	Meet the requirement of limit.
15.247(d)	Band Edge Measurement Limit: 30dB less than the peak value of fundamental frequency	PASS	Meet the requirement of limit.
15.203	Antenna Requirement	PASS	No antenna connector is used.

2.1 MEASUREMENT UNCERTAINTY

Where relevant, the following measurement uncertainty levels have been estimated for tests performed on the EUT as specified in CISPR 16-4-2:

MEASUREMENT	FREQUENCY	UNCERTAINTY
Conducted emissions	9kHz~30MHz	2.44dB
Radiated emissions	30MHz ~ 200MHz	3.34dB
	200MHz ~1000MHz	3.35dB
	1GHz ~ 18GHz	2.26dB
	18GHz ~ 40GHz	1.94dB

This uncertainty represents an expanded uncertainty expressed at approximately the 95% confidence level using a coverage factor of k = 2.



A D T

3. GENERAL INFORMATION

3.1 GENERAL DESCRIPTION OF EUT

PRODUCT	Wireless Access Points
MODEL NO.	HiveAP 330
FCC ID	WBV-HIVEAP330
NOMINAL VOLTAGE	12Vdc (Adapter) 48Vdc (POE)
MODULATION TYPE	CCK, DQPSK, DBPSK for DSSS 64QAM, 16QAM, QPSK, BPSK for OFDM
MODULATION TECHNOLOGY	DSSS, OFDM
TRANSFER RATE	802.11b: 11.0/ 5.5/ 2.0/ 1.0Mbps 802.11g: 54.0/ 48.0/ 36.0/ 24.0/ 18.0/ 12.0/ 9.0/ 6.0Mbps 802.11a: 54.0/ 48.0/ 36.0/ 24.0/ 18.0/ 12.0/ 9.0/ 6.0Mbps 802.11n: up to 450.0Mbps
OPERATING FREQUENCY	2.4GHz: 2412.0 ~ 2462.0MHz 5.0GHz: 5745.0 ~ 5825.0MHz
NUMBER OF CHANNEL	2.4GHz: 11 for 802.11b, 802.11g, 802.11n (20MHz) 7 for 802.11n (40MHz) 5.0GHz: 5 for 802.11a, 802.11n (20MHz) 2 for 802.11n (40MHz)
OUTPUT POWER	916.5mW for 2412.0 ~ 2462.0MHz 833.3mW for 5745.0 ~ 5825.0MHz
ANTENNA TYPE	2.4GHz: PIFA antenna with 5dBi gain 5.0GHz: PIFA antenna with 6dBi gain
ANTENNA CONNECTER	NA
DATA CABLE	NA
I/O PORTS	Refer to user's manual
ACCESSORY DEVICES	NA

NOTE:

1. The EUT is a Wireless Access Points. The test data are separated into following test reports.

	TEST STANDARD	REFERENCE REPORT
WLAN 802.11b/g, 802.11n	FCC Part 15, Subpart C (Section 15.247)	RF110412C04
WLAN 802.11a, 802.11n (5745~5825 MHz)		
WLAN 802.11a, 802.11n (5180~ 5240MHz)	FCC Part 15, Subpart E (Section 15.407)	RF110412C04-1



A D T

2. The frequency bands used in this EUT are listed as follows:

FREQUENCY BAND (MHz)	2412~2462	5180~5240	5745~5825
802.11b	√		
802.11g	√		
802.11a		√	√
802.11n (20MHz)	√	√	√
802.11n (40MHz)	√	√	√

3. The EUT incorporates a MIMO function. Physically, the EUT provides three completed transmitters and three receivers.

MODULATION MODE	TX FUNCTION
802.11b	1TX
802.11g	1TX
802.11a	1TX
802.11n (20MHz)	3TX
802.11n (40MHz)	3TX

4. The EUT was powered by the following adapter and POE. (Not for sale)

ADAPTER	
BRAND:	DVE
MODEL:	DSA-30W-12 EU
INPUT:	100-240Vac, 50/60Hz, 0.8A
OUTPUT:	12Vdc, 2A
POWER LINE:	1.73m non-shielded cable without core

POE	
BRAND:	SL POWER and AULT
MODEL:	PENB1032E4800F02
INPUT:	100-240Vac, 50-60Hz, 1.0A
OUTPUT:	48Vdc, 0.67A

5. The above EUT information is declared by manufacturer and for more detailed features description, please refer to the manufacturer's specifications or user's manual.

3.2 DESCRIPTION OF TEST MODES

FOR 2.4GHz:

11 channels are provided for 802.11b, 802.11g and 802.11n (20MHz):

CHANNEL	FREQUENCY	CHANNEL	FREQUENCY
1	2412MHz	7	2442MHz
2	2417MHz	8	2447MHz
3	2422MHz	9	2452MHz
4	2427MHz	10	2457MHz
5	2432MHz	11	2462MHz
6	2437MHz		

7 channels are provided for 802.11n (40MHz):

CHANNEL	FREQUENCY	CHANNEL	FREQUENCY
1	2422MHz	5	2442MHz
2	2427MHz	6	2447MHz
3	2432MHz	7	2452MHz
4	2437MHz		

FOR 5.0GHz (5745 ~ 5825MHz):

5 channels are provided for 802.11a and 802.11n (20MHz):

CHANNEL	FREQUENCY	CHANNEL	FREQUENCY
149	5745MHz	161	5805MHz
153	5765MHz	165	5825MHz
157	5785MHz		

2 channels are provided for 802.11n (40MHz):

CHANNEL	FREQUENCY	CHANNEL	FREQUENCY
151	5755MHz	159	5795MHz

3.2.1 CONFIGURATION OF SYSTEM UNDER TEST

Test Mode A

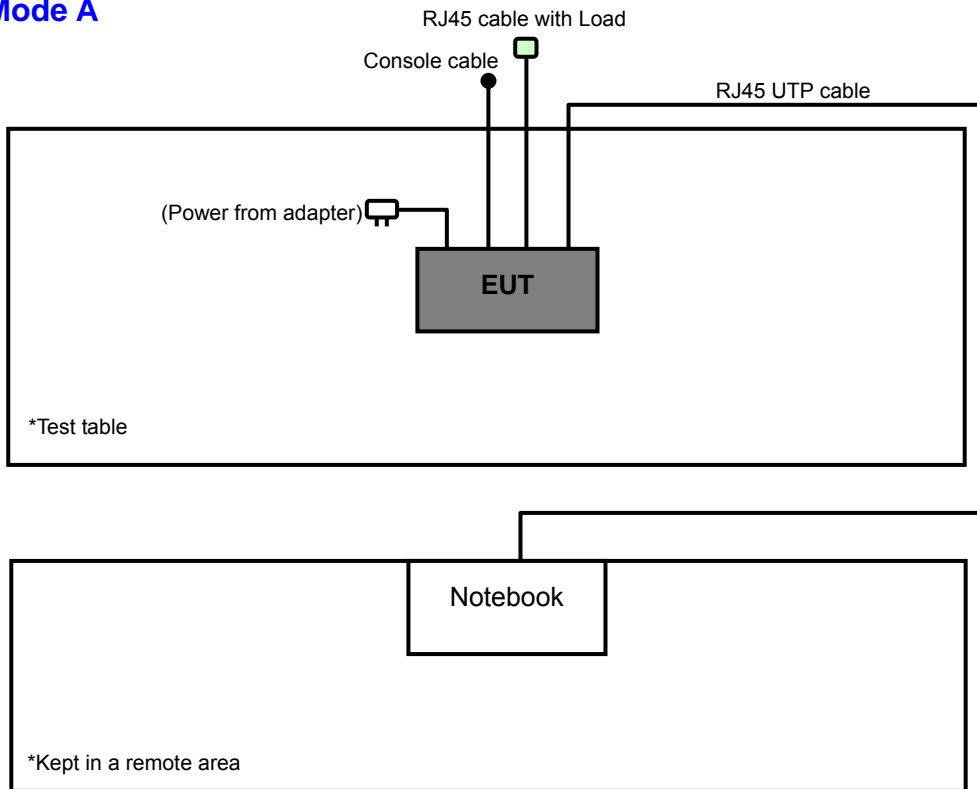

Test Mode B

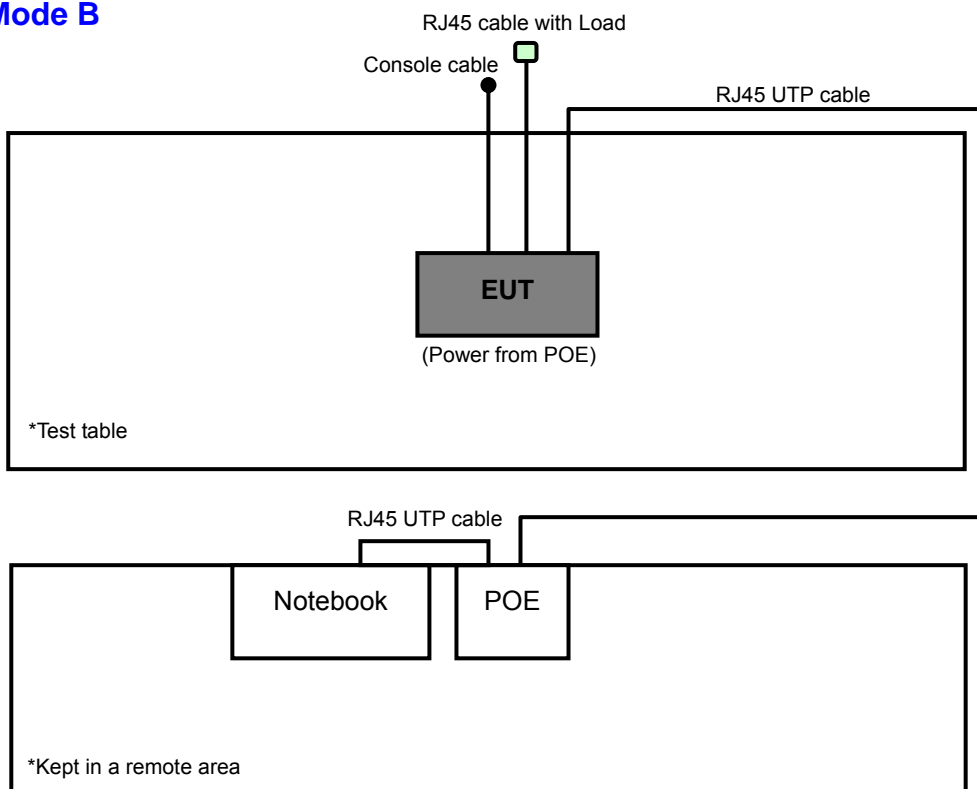



3.2.2 TEST MODE APPLICABILITY AND TESTED CHANNEL DETAIL

FOR 2.4GHz:

EUT CONFIGURE MODE	APPLICABLE TO				DESCRIPTION
	RE \geq 1G	RE<1G	PLC	APCM	
A	√	√	√	√	Adapter mode
B	-	√	√	-	POE mode

Where **RE \geq 1G**: Radiated Emission above 1GHz **RE<1G**: Radiated Emission below 1GHz
PLC: Power Line Conducted Emission **APCM**: Antenna Port Conducted Measurement

NOTE: “-” means no effect.

RADIATED EMISSION TEST (ABOVE 1GHz):

- Pre-Scan has been conducted to determine the worst-case mode from all possible combinations between available modulations, data rates, XYZ Axis and antenna ports (if EUT with antenna diversity architecture).
- Following channel(s) was (were) selected for the final test as listed below.

EUT CONFIGURE MODE	MODE	AVAILABLE CHANNEL	TESTED CHANNEL	MODULATION TECHNOLOGY	MODULATION TYPE	DATA RATE (Mbps)	AXIS
A	802.11b	1 to 11	1, 6, 11	DSSS	DBPSK	1.0	Z
A	802.11g	1 to 11	1, 6, 11	OFDM	BPSK	6.0	Z
A	802.11n (20MHz)	1 to 11	1, 6, 11	OFDM	BPSK	7.2	Z
A	802.11n (40MHz)	1 to 7	1, 4, 7	OFDM	BPSK	15.0	Z

RADIATED EMISSION TEST (BELOW 1GHz):

- Pre-Scan has been conducted to determine the worst-case mode from all possible combinations between available modulations, data rates, XYZ Axis and antenna ports (if EUT with antenna diversity architecture).
- Following channel(s) was (were) selected for the final test as listed below.

EUT CONFIGURE MODE	MODE	AVAILABLE CHANNEL	TESTED CHANNEL	MODULATION TECHNOLOGY	MODULATION TYPE	DATA RATE (Mbps)	AXIS
A, B	802.11n (40MHz)	1 to 7	4	OFDM	BPSK	15.0	Z

POWER LINE CONDUCTED EMISSION TEST:

- Pre-Scan has been conducted to determine the worst-case mode from all possible combinations between available modulations, data rates and antenna ports (if EUT with antenna diversity architecture).
- Following channel(s) was (were) selected for the final test as listed below.

EUT CONFIGURE MODE	MODE	AVAILABLE CHANNEL	TESTED CHANNEL	MODULATION TECHNOLOGY	MODULATION TYPE	DATA RATE (Mbps)
A, B	802.11n (40MHz)	1 to 7	4	OFDM	BPSK	15.0



BANDEDGE MEASUREMENT:

- Pre-Scan has been conducted to determine the worst-case mode from all possible combinations between available modulations, data rates and antenna ports (if EUT with antenna diversity architecture).
- Following channel(s) was (were) selected for the final test as listed below.

EUT CONFIGURE MODE	MODE	AVAILABLE CHANNEL	TESTED CHANNEL	MODULATION TECHNOLOGY	MODULATION TYPE	DATA RATE (Mbps)
A	802.11b	1 to 11	1, 11	DSSS	DBPSK	1.0
A	802.11g	1 to 11	1, 11	OFDM	BPSK	6.0
A	802.11n (20MHz)	1 to 11	1, 11	OFDM	BPSK	7.2
A	802.11n (40MHz)	1 to 7	1, 7	OFDM	BPSK	15.0

ANTENNA PORT CONDUCTED MEASUREMENT:

- This item includes all test value of each mode, but only includes spectrum plot of worst value of each mode.
- Pre-Scan has been conducted to determine the worst-case mode from all possible combinations between available modulations, data rates and antenna ports (if EUT with antenna diversity architecture).
- Following channel(s) was (were) selected for the final test as listed below.

EUT CONFIGURE MODE	MODE	AVAILABLE CHANNEL	TESTED CHANNEL	MODULATION TECHNOLOGY	MODULATION TYPE	DATA RATE (Mbps)
A	802.11b	1 to 11	1, 6, 11	DSSS	DBPSK	1.0
A	802.11g	1 to 11	1, 6, 11	OFDM	BPSK	6.0
A	802.11n (20MHz)	1 to 11	1, 6, 11	OFDM	BPSK	7.2
A	802.11n (40MHz)	1 to 7	1, 4, 7	OFDM	BPSK	15.0

TEST CONDITION:

APPLICABLE TO	ENVIRONMENTAL CONDITIONS	INPUT POWER	TESTED BY
RE≥1G	25deg. C, 60%RH, 1008 hPa (802.11b/g)	120Vac, 60Hz	Mitch Jen (802.11b/g)
	22deg. C, 61%RH, 1018 hPa (802.11n)	120Vac, 60Hz	Chad Lee (802.11n)
RE<1G	22deg. C, 61%RH, 1010 hPa	120Vac, 60Hz	Chad Lee
PLC	25deg. C, 65%RH, 1010 hPa	120Vac, 60Hz	Mark Liao
APCM	25deg. C, 65%RH, 1000 hPa	120Vac, 60Hz	Chad Lee



A D T

FOR 5.745 ~ 5.825GHz:

EUT CONFIGURE MODE	APPLICABLE TO				DESCRIPTION
	RE≥1G	RE<1G	PLC	APCM	
A	√	√	√	√	Adapter mode
B	-	√	√	-	POE mode

Where **RE≥1G**: Radiated Emission above 1GHz **RE<1G**: Radiated Emission below 1GHz
PLC: Power Line Conducted Emission **APCM**: Antenna Port Conducted Measurement
NOTE: "-" means no effect.

RADIATED EMISSION TEST (ABOVE 1GHz):

- Pre-Scan has been conducted to determine the worst-case mode from all possible combinations between available modulations, data rates, XYZ Axis and antenna ports (if EUT with antenna diversity architecture).
- Following channel(s) was (were) selected for the final test as listed below.

EUT CONFIGURE MODE	MODE	AVAILABLE CHANNEL	TESTED CHANNEL	MODULATION TECHNOLOGY	MODULATION TYPE	DATA RATE (Mbps)	AXIS
A	802.11a	149 to 165	149, 157, 165	OFDM	BPSK	6.0	Z
A	802.11n (20MHz)	149 to 165	149, 157, 165	OFDM	BPSK	7.2	Z
A	802.11n (40MHz)	151 to 159	151, 159	OFDM	BPSK	15.0	Z

RADIATED EMISSION TEST (BELOW 1GHz):

- Pre-Scan has been conducted to determine the worst-case mode from all possible combinations between available modulations, data rates, XYZ Axis and antenna ports (if EUT with antenna diversity architecture).
- Following channel(s) was (were) selected for the final test as listed below.

EUT CONFIGURE MODE	MODE	AVAILABLE CHANNEL	TESTED CHANNEL	MODULATION TECHNOLOGY	MODULATION TYPE	DATA RATE (Mbps)	AXIS
A, B	802.11n (20MHz)	149 to 165	157	OFDM	BPSK	7.2	Z

POWER LINE CONDUCTED EMISSION TEST:

- Pre-Scan has been conducted to determine the worst-case mode from all possible combinations between available modulations, data rates and antenna ports (if EUT with antenna diversity architecture).
- Following channel(s) was (were) selected for the final test as listed below.

EUT CONFIGURE MODE	MODE	AVAILABLE CHANNEL	TESTED CHANNEL	MODULATION TECHNOLOGY	MODULATION TYPE	DATA RATE (Mbps)
A, B	802.11n (20MHz)	149 to 165	157	OFDM	BPSK	6.0



BANDEDGE MEASUREMENT:

- Pre-Scan has been conducted to determine the worst-case mode from all possible combinations between available modulations, data rates and antenna ports (if EUT with antenna diversity architecture).
- Following channel(s) was (were) selected for the final test as listed below.

EUT CONFIGURE MODE	MODE	AVAILABLE CHANNEL	TESTED CHANNEL	MODULATION TECHNOLOGY	MODULATION TYPE	DATA RATE (Mbps)
A	802.11a	149 to 165	149, 165	OFDM	BPSK	6.0
A	802.11n (20MHz)	149 to 165	149, 165	OFDM	BPSK	7.2
A	802.11n (40MHz)	151 to 159	151, 159	OFDM	BPSK	15.0

ANTENNA PORT CONDUCTED MEASUREMENT:

- This item includes all test value of each mode, but only includes spectrum plot of worst value of each mode.
- Pre-Scan has been conducted to determine the worst-case mode from all possible combinations between available modulations, data rates and antenna ports (if EUT with antenna diversity architecture).
- Following channel(s) was (were) selected for the final test as listed below.

EUT CONFIGURE MODE	MODE	AVAILABLE CHANNEL	TESTED CHANNEL	MODULATION TECHNOLOGY	MODULATION TYPE	DATA RATE (Mbps)
A	802.11a	149 to 165	149, 157, 165	OFDM	BPSK	6.0
A	802.11n (20MHz)	149 to 165	149, 157, 165	OFDM	BPSK	7.2
A	802.11n (40MHz)	151 to 159	151, 159	OFDM	BPSK	15.0

TEST CONDITION:

APPLICABLE TO	ENVIRONMENTAL CONDITIONS	INPUT POWER	TESTED BY
RE≥1G	25deg. C, 60%RH, 1008 hPa (802.11a)	120Vac, 60Hz	Mitch Jen (802.11b/g)
	25deg. C, 65%RH, 1011 hPa (802.11n)	120Vac, 60Hz	Brad Wu (802.11n)
RE<1G	22deg. C, 61%RH, 1010 hPa	120Vac, 60Hz	Chad Lee
PLC	25deg. C, 65%RH, 1010 hPa	120Vac, 60Hz	Mark Liao
APCM	25deg. C, 65%RH, 1000 hPa	120Vac, 60Hz	Brad Wu



A D T

3.3 GENERAL DESCRIPTION OF APPLIED STANDARDS

The EUT is a RF Product. According to the specifications of the manufacturer, it must comply with the requirements of the following standards:

FCC Part 15, Subpart C (15.247)

ANSI C63.4-2003

ANSI C63.10-2009

All test items have been performed and recorded as per the above standards.

3.4 DESCRIPTION OF SUPPORT UNITS

The EUT has been tested as an independent unit together with other necessary accessories or support units. The following support units or accessories were used to form a representative test configuration during the tests.

NO.	PRODUCT	BRAND	MODEL NO.	SERIAL NO.	FCC ID
1	NOTEBOOK	DELL	D531	CN-0XM006-48643 -81U-2786	QDS-BRCM1020
2	ADAPTER	DVE	DSA-30W-12 EU	NA	NA
3	POE	SL POWER and AULT	PENB1032E4800F02	NA	NA

NO.	SIGNAL CABLE DESCRIPTION OF THE ABOVE SUPPORT UNITS
1	10m RJ45 UTP cable for test mode A, 1.5m RJ45 UTP cable for test mode B.
2	NA
3	10m RJ45 UTP cable.

NOTE:

1. All power cords of the above support units are non-shielded (1.8m).
2. Item 1~3 acted communication partners to transfer data.
3. Item 2 & 3 were provided by client.



4. TEST TYPES AND RESULTS (FOR 2.4GHz BAND)

4.1 RADIATED EMISSION MEASUREMENT

4.1.1 LIMITS OF RADIATED EMISSION MEASUREMENT

Emissions radiated outside of the specified bands, shall be according to the general radiated limits in 15.209 as following:

FREQUENCIES (MHz)	FIELD STRENGTH (microvolts/meter)	MEASUREMENT DISTANCE (meters)
0.009 ~ 0.490	2400/F(kHz)	300
0.490 ~ 1.705	24000/F(kHz)	30
1.705 ~ 30.0	30	30
30 ~ 88	100	3
88 ~ 216	150	3
216 ~ 960	200	3
Above 960	500	3

NOTE:

1. The lower limit shall apply at the transition frequencies.
2. Emission level (dBuV/m) = 20 log Emission level (uV/m).
3. As shown in 15.35(b), for frequencies above 1000MHz, the field strength limits are based on average detector, however, the peak field strength of any emission shall not exceed the maximum permitted average limits, specified above by more than 20dB under any condition of modulation.



A D T

4.1.2 TEST INSTRUMENTS

DESCRIPTION & MANUFACTURER	MODEL NO.	SERIAL NO.	DATE OF CALIBRATION	DUE DATE OF CALIBRATION
Test Receiver ROHDE & SCHWARZ	ESIB7	100212	Jul. 22, 2010	Jul. 21, 2011
Spectrum Analyzer Agilent	E4446A	MY48250266	Aug. 11, 2010	Aug. 10, 2011
BILOG Antenna SCHWARZBECK	VULB9168	9168-160	Apr. 13, 2011	Apr. 12, 2012
HORN Antenna SCHWARZBECK	9120D	9120D-405	Feb. 08, 2011	Feb. 07, 2012
HORN Antenna SCHWARZBECK	BBHA 9170	BBHA9170243	Dec. 27, 2010	Dec. 26, 2011
Preamplifier Agilent	8447D	2944A10633	Nov. 02, 2010	Nov. 01, 2011
Preamplifier Agilent	8449B	3008A01964	Nov. 02, 2010	Nov. 01, 2011
RF signal cable HUBER+SUHNNER	SUCOFLEX 104	295014/4	Sep 03, 2010	Sep 02, 2011
RF signal cable HUBER+SUHNNER	SUCOFLEX 104	12738/6	Sep 03, 2010	Sep 02, 2011
Software ADT.	ADT_Radiated_ V7.6.15.9.2	NA	NA	NA
Antenna Tower inn-co GmbH	MA 4000	013303	NA	NA
Antenna Tower Controller inn-co GmbH	CO2000	017303	NA	NA
Turn Table ADT.	TT100.	TT93021703	NA	NA
Turn Table Controller ADT.	SC100.	SC93021703	NA	NA

- NOTE:**
1. The calibration interval of the above test instruments is 12 months and the calibrations are traceable to NML/ROC and NIST/USA.
 2. The test was performed in HwaYa Chamber 3.
 3. The horn antenna and HP preamplifier (model: 8449B) are used only for the measurement of emission frequency above 1GHz if tested.
 4. The FCC Site Registration No. is 988962.
 5. The IC Site Registration No. is IC7450F-3.



4.1.3 TEST PROCEDURES

- a. The EUT was placed on the top of a rotating table 0.8 meters above the ground at a 3 meters semi-anechoic chamber. The table was rotated 360 degrees to determine the position of the highest radiation.
- b. The EUT was set 3 meters away from the interference-receiving antenna, which was mounted on the top of a variable-height antenna tower.
- c. The antenna is a broadband antenna, and its height is varied from one meter to four meters above the ground to determine the maximum value of the field strength. Both horizontal and vertical polarizations of the antenna are set to make the measurement.
- d. For each suspected emission, the EUT was arranged to its worst case and then the antenna was tuned to heights from 1 meter to 4 meters and the rotatable table was turned from 0 degrees to 360 degrees to find the maximum reading.
- e. The test-receiver system was set to Peak Detect Function and Specified Bandwidth with Maximum Hold Mode.
- f. If the emission level of the EUT in peak mode was lower than the limit specified, then testing could be stopped and the peak values of the EUT would be reported. Otherwise the emissions would be re-tested one by one using peak, quasi-peak or average method as specified and then reported in a data sheet.

NOTE:

1. The resolution bandwidth and video bandwidth of test receiver/spectrum analyzer is 120kHz for Quasi-peak detection at frequency below 1GHz.
2. The resolution bandwidth of test receiver/spectrum analyzer is 100kHz and video bandwidth is 300kHz for Peak detection at frequency above 1GHz.
3. The resolution bandwidth of test receiver/spectrum analyzer is 1MHz and the video bandwidth is 10Hz for Average detection (AV) at frequency above 1GHz.
4. All modes of operation were investigated and the worst-case emissions are reported.

4.1.4 DEVIATION FROM TEST STANDARD

No deviation

4.1.5 TEST SETUP

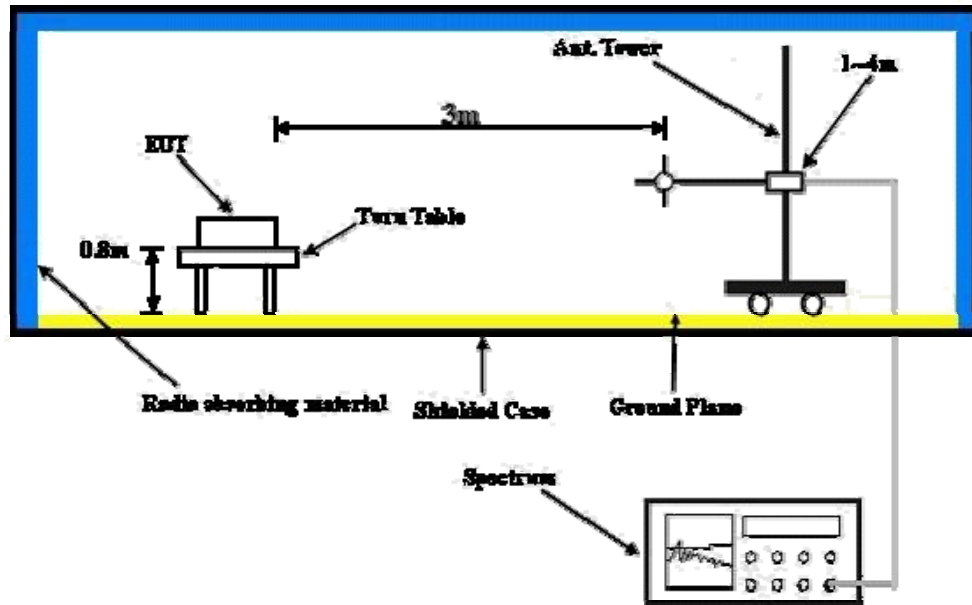

For the actual test configuration, please refer to the attached file (Test Setup Photo).

4.1.6 EUT OPERATING CONDITIONS

- a. Placed the EUT on the testing table.
- b. Prepared notebook to act as communication partner and placed it outside of testing area.
- c. The communication partner connected with EUT via a RJ45 cable and run a test program (provided by manufacturer) to enable EUT under transmission condition continuously at specific channel frequency.
- d. The communication partner sent data to EUT by command "PING".



A D T

4.1.7 TEST RESULTS

ABOVE 1GHz WORST-CASE DATA : 802.11b

EUT TEST CONDITION		MEASUREMENT DETAIL	
CHANNEL	Channel 1	FREQUENCY RANGE	1 ~ 25GHz
INPUT POWER (SYSTEM)	120Vac, 60 Hz	DETECTOR FUNCTION	Peak (PK) Average (AV)
ENVIRONMENTAL CONDITIONS	25deg. C, 60%RH 1008 hPa	TESTED BY	Mitch Jen

ANTENNA POLARITY & TEST DISTANCE: HORIZONTAL AT 3 M								
NO.	FREQ. (MHz)	EMISSION LEVEL (dBuV/m)	LIMIT (dBuV/m)	MARGIN (dB)	ANTENNA HEIGHT (m)	TABLE ANGLE (Degree)	RAW VALUE (dBuV)	CORRECTION FACTOR (dB/m)
1	2390.00	60.3 PK	74.0	-13.7	1.31 H	316	29.80	30.50
2	2390.00	52.4 AV	54.0	-1.6	1.31 H	316	21.90	30.50
3	*2412.00	111.2 PK			1.31 H	321	80.60	30.60
4	*2412.00	106.9 AV			1.31 H	321	76.30	30.60
5	4824.00	52.7 PK	74.0	-21.3	1.01 H	360	16.10	36.60
6	4824.00	48.9 AV	54.0	-5.1	1.01 H	360	12.30	36.60
ANTENNA POLARITY & TEST DISTANCE: VERTICAL AT 3 M								
NO.	FREQ. (MHz)	EMISSION LEVEL (dBuV/m)	LIMIT (dBuV/m)	MARGIN (dB)	ANTENNA HEIGHT (m)	TABLE ANGLE (Degree)	RAW VALUE (dBuV)	CORRECTION FACTOR (dB/m)
1	2390.00	58.8 PK	74.0	-15.2	1.12 V	19	28.30	30.50
2	2390.00	52.3 AV	54.0	-1.7	1.12 V	19	21.80	30.50
3	*2412.00	107.6 PK			1.12 V	19	77.00	30.60
4	*2412.00	103.2 AV			1.12 V	19	72.60	30.60
5	4824.00	51.7 PK	74.0	-22.3	1.11 V	315	15.10	36.60
6	4824.00	48.7 AV	54.0	-5.3	1.11 V	315	12.10	36.60

- REMARKS:**
1. Emission level (dBuV/m) = Raw Value (dBuV) + Correction Factor (dB/m).
 2. Correction Factor (dB/m) = Antenna Factor (dB/m) + Cable Factor (dB).
 3. The other emission levels were very low against the limit.
 4. Margin value = Emission level – Limit value.
 5. “ * “: Fundamental frequency.



A D T

EUT TEST CONDITION		MEASUREMENT DETAIL	
CHANNEL	Channel 6	FREQUENCY RANGE	1 ~ 25GHz
INPUT POWER (SYSTEM)	120Vac, 60 Hz	DETECTOR FUNCTION	Peak (PK) Average (AV)
ENVIRONMENTAL CONDITIONS	25deg. C, 60%RH 1008 hPa	TESTED BY	Mitch Jen

ANTENNA POLARITY & TEST DISTANCE: HORIZONTAL AT 3 M								
NO.	FREQ. (MHz)	EMISSION LEVEL (dBuV/m)	LIMIT (dBuV/m)	MARGIN (dB)	ANTENNA HEIGHT (m)	TABLE ANGLE (Degree)	RAW VALUE (dBuV)	CORRECTION FACTOR (dB/m)
1	2350.00	59.4 PK	74.0	-14.6	1.04 H	33	29.00	30.40
2	2350.00	52.7 AV	54.0	-1.3	1.04 H	33	22.30	30.40
3	*2437.00	108.8 PK			1.26 H	42	78.10	30.70
4	*2437.00	104.1 AV			1.26 H	42	73.40	30.70
5	4874.00	50.4 PK	74.0	-23.6	1.03 H	352	13.70	36.70
6	4874.00	40.0 AV	54.0	-14.0	1.03 H	352	3.30	36.70
ANTENNA POLARITY & TEST DISTANCE: VERTICAL AT 3 M								
NO.	FREQ. (MHz)	EMISSION LEVEL (dBuV/m)	LIMIT (dBuV/m)	MARGIN (dB)	ANTENNA HEIGHT (m)	TABLE ANGLE (Degree)	RAW VALUE (dBuV)	CORRECTION FACTOR (dB/m)
1	2351.00	59.1 PK	74.0	-14.9	1.17 V	18	28.70	30.40
2	2351.00	50.6 AV	54.0	-3.4	1.17 V	18	20.20	30.40
3	*2437.00	105.2 PK			1.17 V	18	74.50	30.70
4	*2437.00	100.3 AV			1.17 V	18	69.60	30.70
5	4874.00	49.5 PK	74.0	-24.5	1.24 V	40	12.80	36.70
6	4874.00	42.5 AV	54.0	-11.5	1.24 V	40	5.80	36.70

- REMARKS:**
1. Emission level (dBuV/m) = Raw Value (dBuV) + Correction Factor (dB/m).
 2. Correction Factor (dB/m) = Antenna Factor (dB/m) + Cable Factor (dB).
 3. The other emission levels were very low against the limit.
 4. Margin value = Emission level – Limit value.
 5. “ * “: Fundamental frequency.



A D T

EUT TEST CONDITION		MEASUREMENT DETAIL	
CHANNEL	Channel 11	FREQUENCY RANGE	1 ~ 25GHz
INPUT POWER (SYSTEM)	120Vac, 60 Hz	DETECTOR FUNCTION	Peak (PK) Average (AV)
ENVIRONMENTAL CONDITIONS	25deg. C, 60%RH 1008 hPa	TESTED BY	Mitch Jen

ANTENNA POLARITY & TEST DISTANCE: HORIZONTAL AT 3 M								
NO.	FREQ. (MHz)	EMISSION LEVEL (dBuV/m)	LIMIT (dBuV/m)	MARGIN (dB)	ANTENNA HEIGHT (m)	TABLE ANGLE (Degree)	RAW VALUE (dBuV)	CORRECTION FACTOR (dB/m)
1	2375.00	62.8 PK	74.0	-11.2	1.25 H	54	32.40	30.40
2	2375.00	52.7 AV	54.0	-1.3	1.25 H	54	22.30	30.40
3	*2462.00	105.6 PK			1.21 H	39	74.80	30.80
4	*2462.00	101.2 AV			1.21 H	39	70.40	30.80
5	2483.50	53.5 PK	74.0	-20.5	1.21 H	39	22.70	30.80
6	2483.50	44.6 AV	54.0	-9.4	1.21 H	39	13.80	30.80
7	4924.00	46.0 PK	74.0	-28.0	1.37 H	4	9.20	36.80
8	4924.00	37.7 AV	54.0	-16.3	1.37 H	4	0.90	36.80
ANTENNA POLARITY & TEST DISTANCE: VERTICAL AT 3 M								
NO.	FREQ. (MHz)	EMISSION LEVEL (dBuV/m)	LIMIT (dBuV/m)	MARGIN (dB)	ANTENNA HEIGHT (m)	TABLE ANGLE (Degree)	RAW VALUE (dBuV)	CORRECTION FACTOR (dB/m)
1	2375.00	61.2 PK	74.0	-12.8	1.14 V	16	30.80	30.40
2	2375.00	51.1 AV	54.0	-2.9	1.14 V	16	20.70	30.40
3	*2462.00	102.2 PK			1.11 V	18	71.40	30.80
4	*2462.00	98.3 AV			1.11 V	18	67.50	30.80
5	2483.50	54.3 PK	74.0	-19.7	1.11 V	18	23.50	30.80
6	2483.50	43.1 AV	54.0	-10.9	1.11 V	18	12.30	30.80
7	4924.00	46.0 PK	74.0	-28.0	1.07 V	40	9.20	36.80
8	4924.00	37.2 AV	54.0	-16.8	1.07 V	40	0.40	36.80

- REMARKS:**
1. Emission level (dBuV/m) = Raw Value (dBuV) + Correction Factor (dB/m).
 2. Correction Factor (dB/m) = Antenna Factor (dB/m) + Cable Factor (dB).
 3. The other emission levels were very low against the limit.
 4. Margin value = Emission level – Limit value.
 5. “ * “: Fundamental frequency.



A D T

802.11g

EUT TEST CONDITION		MEASUREMENT DETAIL	
CHANNEL	Channel 1	FREQUENCY RANGE	1 ~ 25GHz
INPUT POWER (SYSTEM)	120Vac, 60 Hz	DETECTOR FUNCTION	Peak (PK) Average (AV)
ENVIRONMENTAL CONDITIONS	25deg. C, 60%RH 1008 hPa	TESTED BY	Mitch Jen

ANTENNA POLARITY & TEST DISTANCE: HORIZONTAL AT 3 M								
NO.	FREQ. (MHz)	EMISSION LEVEL (dBuV/m)	LIMIT (dBuV/m)	MARGIN (dB)	ANTENNA HEIGHT (m)	TABLE ANGLE (Degree)	RAW VALUE (dBuV)	CORRECTION FACTOR (dB/m)
1	2328.00	56.8 PK	74.0	-17.2	1.29 H	79	26.50	30.30
2	2328.00	44.9 AV	54.0	-9.1	1.29 H	79	14.60	30.30
3	2390.00	72.8 PK	74.0	-1.2	1.30 H	318	42.30	30.50
4	2390.00	53.0 AV	54.0	-1.0	1.30 H	318	22.50	30.50
5	*2412.00	110.6 PK			1.30 H	318	80.00	30.60
6	*2412.00	98.7 AV			1.30 H	318	68.10	30.60
7	4824.00	50.1 PK	74.0	-23.9	1.00 H	358	13.50	36.60
8	4824.00	34.6 AV	54.0	-19.4	1.00 H	358	-2.00	36.60
ANTENNA POLARITY & TEST DISTANCE: VERTICAL AT 3 M								
NO.	FREQ. (MHz)	EMISSION LEVEL (dBuV/m)	LIMIT (dBuV/m)	MARGIN (dB)	ANTENNA HEIGHT (m)	TABLE ANGLE (Degree)	RAW VALUE (dBuV)	CORRECTION FACTOR (dB/m)
1	2328.00	55.6 PK	74.0	-18.4	1.19 V	18	25.30	30.30
2	2328.00	44.0 AV	54.0	-10.0	1.19 V	18	13.70	30.30
3	2390.00	70.8 PK	74.0	-3.2	1.14 V	20	40.30	30.50
4	2390.00	52.7 AV	54.0	-1.3	1.14 V	20	22.20	30.50
5	*2412.00	106.6 PK			1.14 V	21	76.00	30.60
6	*2412.00	94.6 AV			1.14 V	21	64.00	30.60
7	4824.00	53.0 PK	74.0	-21.0	1.58 V	20	16.40	36.60
8	4824.00	37.5 AV	54.0	-16.5	1.58 V	20	0.90	36.60

- REMARKS:**
1. Emission level (dBuV/m) = Raw Value (dBuV) + Correction Factor (dB/m).
 2. Correction Factor (dB/m) = Antenna Factor (dB/m) + Cable Factor (dB).
 3. The other emission levels were very low against the limit.
 4. Margin value = Emission level – Limit value.
 5. “ * “: Fundamental frequency.



A D T

EUT TEST CONDITION		MEASUREMENT DETAIL	
CHANNEL	Channel 6	FREQUENCY RANGE	1 ~ 25GHz
INPUT POWER (SYSTEM)	120Vac, 60 Hz	DETECTOR FUNCTION	Peak (PK) Average (AV)
ENVIRONMENTAL CONDITIONS	25deg. C, 60%RH 1008 hPa	TESTED BY	Mitch Jen

ANTENNA POLARITY & TEST DISTANCE: HORIZONTAL AT 3 M								
NO.	FREQ. (MHz)	EMISSION LEVEL (dBuV/m)	LIMIT (dBuV/m)	MARGIN (dB)	ANTENNA HEIGHT (m)	TABLE ANGLE (Degree)	RAW VALUE (dBuV)	CORRECTION FACTOR (dB/m)
1	2355.00	62.6 PK	74.0	-11.4	1.04 H	35	32.20	30.40
2	2355.00	52.8 AV	54.0	-1.2	1.04 H	35	22.40	30.40
3	2390.00	64.5 PK	74.0	-9.5	1.26 H	36	34.00	30.50
4	2390.00	51.3 AV	54.0	-2.7	1.26 H	36	20.80	30.50
5	*2437.00	113.7 PK			1.26 H	36	83.00	30.70
6	*2437.00	101.6 AV			1.26 H	36	70.90	30.70
7	4874.00	56.5 PK	74.0	-17.5	1.00 H	303	19.80	36.70
8	4874.00	40.7 AV	54.0	-13.3	1.00 H	303	4.00	36.70
ANTENNA POLARITY & TEST DISTANCE: VERTICAL AT 3 M								
NO.	FREQ. (MHz)	EMISSION LEVEL (dBuV/m)	LIMIT (dBuV/m)	MARGIN (dB)	ANTENNA HEIGHT (m)	TABLE ANGLE (Degree)	RAW VALUE (dBuV)	CORRECTION FACTOR (dB/m)
1	2355.00	60.8 PK	74.0	-13.2	1.15 V	14	30.40	30.40
2	2355.00	50.8 AV	54.0	-3.2	1.15 V	14	20.40	30.40
3	2390.00	63.1 PK	74.0	-10.9	1.15 V	14	32.60	30.50
4	2390.00	49.2 AV	54.0	-4.8	1.15 V	14	18.70	30.50
5	*2437.00	110.2 PK			1.15 V	15	79.50	30.70
6	*2437.00	98.7 AV			1.15 V	15	68.00	30.70
7	4874.00	59.7 PK	74.0	-14.3	1.25 V	56	23.00	36.70
8	4874.00	43.7 AV	54.0	-10.3	1.25 V	56	7.00	36.70

- REMARKS:**
1. Emission level (dBuV/m) = Raw Value (dBuV) + Correction Factor (dB/m).
 2. Correction Factor (dB/m) = Antenna Factor (dB/m) + Cable Factor (dB).
 3. The other emission levels were very low against the limit.
 4. Margin value = Emission level – Limit value.
 5. “ * “: Fundamental frequency.



A D T

EUT TEST CONDITION		MEASUREMENT DETAIL	
CHANNEL	Channel 11	FREQUENCY RANGE	1 ~ 25GHz
INPUT POWER (SYSTEM)	120Vac, 60 Hz	DETECTOR FUNCTION	Peak (PK) Average (AV)
ENVIRONMENTAL CONDITIONS	25deg. C, 60%RH 1008 hPa	TESTED BY	Mitch Jen

ANTENNA POLARITY & TEST DISTANCE: HORIZONTAL AT 3 M								
NO.	FREQ. (MHz)	EMISSION LEVEL (dBuV/m)	LIMIT (dBuV/m)	MARGIN (dB)	ANTENNA HEIGHT (m)	TABLE ANGLE (Degree)	RAW VALUE (dBuV)	CORRECTION FACTOR (dB/m)
1	2373.40	63.4 PK	74.0	-10.6	1.26 H	55	33.00	30.40
2	2373.40	51.5 AV	54.0	-2.5	1.26 H	55	21.10	30.40
3	*2462.00	109.5 PK			1.23 H	35	78.70	30.80
4	*2462.00	97.0 AV			1.23 H	35	66.20	30.80
5	2483.50	73.0 PK	74.0	-1.0	1.23 H	35	42.20	30.80
6	2483.50	52.6 AV	54.0	-1.4	1.23 H	35	21.80	30.80
7	4924.00	50.5 PK	74.0	-23.5	1.22 H	161	13.70	36.80
8	4924.00	36.0 AV	54.0	-18.0	1.22 H	161	-0.80	36.80
ANTENNA POLARITY & TEST DISTANCE: VERTICAL AT 3 M								
NO.	FREQ. (MHz)	EMISSION LEVEL (dBuV/m)	LIMIT (dBuV/m)	MARGIN (dB)	ANTENNA HEIGHT (m)	TABLE ANGLE (Degree)	RAW VALUE (dBuV)	CORRECTION FACTOR (dB/m)
1	2373.90	63.0 PK	74.0	-11.0	1.13 V	20	32.60	30.40
2	2373.90	50.7 AV	54.0	-3.3	1.13 V	20	20.30	30.40
3	*2462.00	106.1 PK			1.12 V	20	75.30	30.80
4	*2462.00	94.0 AV			1.12 V	20	63.20	30.80
5	2483.50	67.5 PK	74.0	-6.5	1.12 V	20	36.70	30.80
6	2483.50	49.8 AV	54.0	-4.2	1.12 V	20	19.00	30.80
7	4924.00	52.2 PK	74.0	-21.8	1.28 V	316	15.40	36.80
8	4924.00	36.3 AV	54.0	-17.7	1.28 V	316	-0.50	36.80

- REMARKS:**
1. Emission level (dBuV/m) = Raw Value (dBuV) + Correction Factor (dB/m).
 2. Correction Factor (dB/m) = Antenna Factor (dB/m) + Cable Factor (dB).
 3. The other emission levels were very low against the limit.
 4. Margin value = Emission level – Limit value.
 5. “ * “: Fundamental frequency.



A D T

802.11n (20MHz)

EUT TEST CONDITION		MEASUREMENT DETAIL	
CHANNEL	Channel 1	FREQUENCY RANGE	1 ~ 25GHz
INPUT POWER (SYSTEM)	120Vac, 60 Hz	DETECTOR FUNCTION	Peak (PK) Average (AV)
ENVIRONMENTAL CONDITIONS	22deg. C, 61%RH 1018 hPa	TESTED BY	Chad Lee

ANTENNA POLARITY & TEST DISTANCE: HORIZONTAL AT 3 M								
NO.	FREQ. (MHz)	EMISSION LEVEL (dBuV/m)	LIMIT (dBuV/m)	MARGIN (dB)	ANTENNA HEIGHT (m)	TABLE ANGLE (Degree)	RAW VALUE (dBuV)	CORRECTION FACTOR (dB/m)
1	2390.00	66.6 PK	74.0	-7.4	1.02 H	251	36.30	30.30
2	2390.00	52.1 AV	54.0	-1.9	1.02 H	251	21.80	30.30
3	*2412.00	114.4 PK			1.00 H	309	84.10	30.30
4	*2412.00	100.9 AV			1.00 H	309	70.60	30.30
5	#3216.00	49.2 PK	94.4	-45.2	1.25 H	46	16.80	32.40
6	#3216.00	46.6 AV	80.9	-34.3	1.25 H	46	14.20	32.40
7	4824.00	43.3 PK	74.0	-30.7	1.00 H	19	7.10	36.20
8	4824.00	29.9 AV	54.0	-24.1	1.00 H	19	-6.30	36.20
ANTENNA POLARITY & TEST DISTANCE: VERTICAL AT 3 M								
NO.	FREQ. (MHz)	EMISSION LEVEL (dBuV/m)	LIMIT (dBuV/m)	MARGIN (dB)	ANTENNA HEIGHT (m)	TABLE ANGLE (Degree)	RAW VALUE (dBuV)	CORRECTION FACTOR (dB/m)
1	2390.00	61.6 PK	74.0	-12.4	1.11 V	8	31.30	30.30
2	2390.00	47.2 AV	54.0	-6.8	1.11 V	8	16.90	30.30
3	*2412.00	111.0 PK			1.11 V	8	80.70	30.30
4	*2412.00	97.9 AV			1.11 V	8	67.60	30.30
5	#3216.00	51.7 PK	91.0	-39.3	1.17 V	333	19.30	32.40
6	#3216.00	49.9 AV	77.9	-28.0	1.17 V	333	17.50	32.40
7	4824.00	43.5 PK	74.0	-30.5	1.10 V	16	7.30	36.20
8	4824.00	30.1 AV	54.0	-23.9	1.10 V	16	-6.10	36.20

- REMARKS:**
1. Emission level (dBuV/m) = Raw Value (dBuV) + Correction Factor (dB/m).
 2. Correction Factor (dB/m) = Antenna Factor (dB/m) + Cable Factor (dB).
 3. The other emission levels were very low against the limit.
 4. Margin value = Emission level – Limit value.
 5. “ * “: Fundamental frequency.
 6. “#”: The radiated frequency is out the restricted band.



A D T

EUT TEST CONDITION		MEASUREMENT DETAIL	
CHANNEL	Channel 6	FREQUENCY RANGE	1 ~ 25GHz
INPUT POWER (SYSTEM)	120Vac, 60 Hz	DETECTOR FUNCTION	Peak (PK) Average (AV)
ENVIRONMENTAL CONDITIONS	22deg. C, 61%RH 1018 hPa	TESTED BY	Chad Lee

ANTENNA POLARITY & TEST DISTANCE: HORIZONTAL AT 3 M								
NO.	FREQ. (MHz)	EMISSION LEVEL (dBuV/m)	LIMIT (dBuV/m)	MARGIN (dB)	ANTENNA HEIGHT (m)	TABLE ANGLE (Degree)	RAW VALUE (dBuV)	CORRECTION FACTOR (dB/m)
1	*2437.00	113.3 PK			1.00 H	306	82.90	30.40
2	*2437.00	99.8 AV			1.00 H	306	69.40	30.40
3	#3249.00	46.7 PK	93.3	-46.6	1.25 H	43	14.30	32.40
4	#3249.00	42.3 AV	79.8	-37.5	1.25 H	43	9.90	32.40
5	4874.00	42.9 PK	74.0	-31.1	1.00 H	12	6.70	36.20
6	4874.00	30.5 AV	54.0	-23.5	1.00 H	12	-5.70	36.20
ANTENNA POLARITY & TEST DISTANCE: VERTICAL AT 3 M								
NO.	FREQ. (MHz)	EMISSION LEVEL (dBuV/m)	LIMIT (dBuV/m)	MARGIN (dB)	ANTENNA HEIGHT (m)	TABLE ANGLE (Degree)	RAW VALUE (dBuV)	CORRECTION FACTOR (dB/m)
1	*2437.00	109.9 PK			1.31 V	25	79.50	30.40
2	*2437.00	98.3 AV			1.31 V	25	67.90	30.40
3	#3249.00	49.0 PK	89.9	-40.9	1.00 V	352	16.60	32.40
4	#3249.00	45.2 AV	78.3	-33.1	1.00 V	352	12.80	32.40
5	4874.00	43.2 PK	74.0	-30.8	1.00 V	16	7.00	36.20
6	4874.00	29.8 AV	54.0	-24.2	1.00 V	16	-6.40	36.20

- REMARKS:**
1. Emission level (dBuV/m) = Raw Value (dBuV) + Correction Factor (dB/m).
 2. Correction Factor (dB/m) = Antenna Factor (dB/m) + Cable Factor (dB).
 3. The other emission levels were very low against the limit.
 4. Margin value = Emission level – Limit value.
 5. “ * “: Fundamental frequency.
 6. "#":The radiated frequency is out the restricted band.



A D T

EUT TEST CONDITION		MEASUREMENT DETAIL	
CHANNEL	Channel 11	FREQUENCY RANGE	1 ~ 25GHz
INPUT POWER (SYSTEM)	120Vac, 60 Hz	DETECTOR FUNCTION	Peak (PK) Average (AV)
ENVIRONMENTAL CONDITIONS	22deg. C, 61%RH 1018 hPa	TESTED BY	Chad Lee

ANTENNA POLARITY & TEST DISTANCE: HORIZONTAL AT 3 M								
NO.	FREQ. (MHz)	EMISSION LEVEL (dBuV/m)	LIMIT (dBuV/m)	MARGIN (dB)	ANTENNA HEIGHT (m)	TABLE ANGLE (Degree)	RAW VALUE (dBuV)	CORRECTION FACTOR (dB/m)
1	*2462.00	113.8 PK			1.00 H	305	83.30	30.50
2	*2462.00	99.0 AV			1.00 H	305	68.50	30.50
3	2483.50	61.2 PK	74.0	-12.8	1.00 H	305	30.60	30.60
4	2483.50	47.6 AV	54.0	-6.4	1.00 H	305	17.00	30.60
5	#3282.00	43.7 PK	93.8	-50.1	1.12 H	21	11.20	32.50
6	#3282.00	36.8 AV	79.0	-42.2	1.12 H	21	4.30	32.50
7	4924.00	46.0 PK	74.0	-28.0	1.00 H	16	9.70	36.30
8	4924.00	29.9 AV	54.0	-24.1	1.00 H	16	-6.40	36.30
ANTENNA POLARITY & TEST DISTANCE: VERTICAL AT 3 M								
NO.	FREQ. (MHz)	EMISSION LEVEL (dBuV/m)	LIMIT (dBuV/m)	MARGIN (dB)	ANTENNA HEIGHT (m)	TABLE ANGLE (Degree)	RAW VALUE (dBuV)	CORRECTION FACTOR (dB/m)
1	*2462.00	111.6 PK			1.06 V	26	81.10	30.50
2	*2462.00	98.5 AV			1.06 V	26	68.00	30.50
3	2483.50	63.4 PK	74.0	-10.6	1.00 V	6	32.80	30.60
4	2483.50	47.5 AV	54.0	-6.5	1.00 V	6	16.90	30.60
5	#3282.00	46.3 PK	91.6	-45.3	1.30 V	2	13.80	32.50
6	#3282.00	39.9 AV	78.5	-38.6	1.30 V	2	7.40	32.50
7	4924.00	44.3 PK	74.0	-29.7	1.00 V	20	8.00	36.30
8	4924.00	30.1 AV	54.0	-23.9	1.00 V	20	-6.20	36.30

- REMARKS:**
1. Emission level (dBuV/m) = Raw Value (dBuV) + Correction Factor (dB/m).
 2. Correction Factor (dB/m) = Antenna Factor (dB/m) + Cable Factor (dB).
 3. The other emission levels were very low against the limit.
 4. Margin value = Emission level – Limit value.
 5. “ * “: Fundamental frequency.
 6. “#”:The radiated frequency is out the restricted band.



A D T

802.11n (40MHz)

EUT TEST CONDITION		MEASUREMENT DETAIL	
CHANNEL	Channel 1	FREQUENCY RANGE	1 ~ 25GHz
INPUT POWER (SYSTEM)	120Vac, 60 Hz	DETECTOR FUNCTION	Peak (PK) Average (AV)
ENVIRONMENTAL CONDITIONS	22deg. C, 61%RH 1018 hPa	TESTED BY	Chad Lee

ANTENNA POLARITY & TEST DISTANCE: HORIZONTAL AT 3 M								
NO.	FREQ. (MHz)	EMISSION LEVEL (dBuV/m)	LIMIT (dBuV/m)	MARGIN (dB)	ANTENNA HEIGHT (m)	TABLE ANGLE (Degree)	RAW VALUE (dBuV)	CORRECTION FACTOR (dB/m)
1	2390.00	70.2 PK	74.0	-3.8	1.00 H	308	39.90	30.30
2	2390.00	53.0 AV	54.0	-1.0	1.00 H	308	22.70	30.30
3	*2422.00	109.2 PK			1.00 H	309	78.80	30.40
4	*2422.00	95.0 AV			1.00 H	309	64.60	30.40
5	#3229.00	46.3 PK	89.2	-42.9	1.00 H	47	13.90	32.40
6	#3229.00	42.9 AV	75.0	-32.1	1.00 H	47	10.50	32.40
7	4844.00	42.8 PK	74.0	-31.2	1.00 H	6	6.60	36.20
8	4844.00	29.5 AV	54.0	-24.5	1.00 H	6	-6.70	36.20
ANTENNA POLARITY & TEST DISTANCE: VERTICAL AT 3 M								
NO.	FREQ. (MHz)	EMISSION LEVEL (dBuV/m)	LIMIT (dBuV/m)	MARGIN (dB)	ANTENNA HEIGHT (m)	TABLE ANGLE (Degree)	RAW VALUE (dBuV)	CORRECTION FACTOR (dB/m)
1	2390.00	69.6 PK	74.0	-4.4	1.12 V	2	39.30	30.30
2	2390.00	50.3 AV	54.0	-3.7	1.12 V	2	20.00	30.30
3	*2422.00	106.5 PK			1.08 V	19	76.10	30.40
4	*2422.00	92.9 AV			1.08 V	19	62.50	30.40
5	#3229.00	49.7 PK	86.5	-36.8	1.00 V	349	17.30	32.40
6	#3229.00	46.9 AV	72.9	-26.0	1.00 V	349	14.50	32.40
7	4844.00	42.8 PK	74.0	-31.2	1.00 V	16	6.60	36.20
8	4844.00	30.3 AV	54.0	-23.7	1.00 V	16	-5.90	36.20

- REMARKS:**
1. Emission level (dBuV/m) = Raw Value (dBuV) + Correction Factor (dB/m).
 2. Correction Factor (dB/m) = Antenna Factor (dB/m) + Cable Factor (dB).
 3. The other emission levels were very low against the limit.
 4. Margin value = Emission level – Limit value.
 5. “ * “: Fundamental frequency.
 6. “#”: The radiated frequency is out the restricted band.



A D T

EUT TEST CONDITION		MEASUREMENT DETAIL	
CHANNEL	Channel 4	FREQUENCY RANGE	1 ~ 25GHz
INPUT POWER (SYSTEM)	120Vac, 60 Hz	DETECTOR FUNCTION	Peak (PK) Average (AV)
ENVIRONMENTAL CONDITIONS	22deg. C, 61%RH 1018 hPa	TESTED BY	Chad Lee

ANTENNA POLARITY & TEST DISTANCE: HORIZONTAL AT 3 M								
NO.	FREQ. (MHz)	EMISSION LEVEL (dBuV/m)	LIMIT (dBuV/m)	MARGIN (dB)	ANTENNA HEIGHT (m)	TABLE ANGLE (Degree)	RAW VALUE (dBuV)	CORRECTION FACTOR (dB/m)
1	*2437.00	111.4 PK			1.00 H	319	81.00	30.40
2	*2437.00	97.6 AV			1.00 H	319	67.20	30.40
3	#3249.00	47.6 PK	91.4	-43.8	1.25 H	40	15.20	32.40
4	#3249.00	43.3 AV	77.6	-34.3	1.25 H	40	10.90	32.40
5	4874.00	46.0 PK	74.0	-28.0	1.00 H	19	9.80	36.20
6	4874.00	30.0 AV	54.0	-24.0	1.00 H	19	-6.20	36.20
ANTENNA POLARITY & TEST DISTANCE: VERTICAL AT 3 M								
NO.	FREQ. (MHz)	EMISSION LEVEL (dBuV/m)	LIMIT (dBuV/m)	MARGIN (dB)	ANTENNA HEIGHT (m)	TABLE ANGLE (Degree)	RAW VALUE (dBuV)	CORRECTION FACTOR (dB/m)
1	*2437.00	109.0 PK			1.06 V	28	78.60	30.40
2	*2437.00	95.3 AV			1.06 V	28	64.90	30.40
3	#3249.00	48.9 PK	89.0	-40.1	1.00 V	354	16.50	32.40
4	#3249.00	46.1 AV	75.3	-29.2	1.00 V	354	13.70	32.40
5	4874.00	42.8 PK	74.0	-31.2	1.00 V	1	6.60	36.20
6	4874.00	30.0 AV	54.0	-24.0	1.00 V	1	-6.20	36.20

- REMARKS:**
1. Emission level (dBuV/m) = Raw Value (dBuV) + Correction Factor (dB/m).
 2. Correction Factor (dB/m) = Antenna Factor (dB/m) + Cable Factor (dB).
 3. The other emission levels were very low against the limit.
 4. Margin value = Emission level – Limit value.
 5. “ * “: Fundamental frequency.
 6. "#":The radiated frequency is out the restricted band.



A D T

EUT TEST CONDITION		MEASUREMENT DETAIL	
CHANNEL	Channel 7	FREQUENCY RANGE	1 ~ 25GHz
INPUT POWER (SYSTEM)	120Vac, 60 Hz	DETECTOR FUNCTION	Peak (PK) Average (AV)
ENVIRONMENTAL CONDITIONS	22deg. C, 61%RH 1018 hPa	TESTED BY	Chad Lee

ANTENNA POLARITY & TEST DISTANCE: HORIZONTAL AT 3 M								
NO.	FREQ. (MHz)	EMISSION LEVEL (dBuV/m)	LIMIT (dBuV/m)	MARGIN (dB)	ANTENNA HEIGHT (m)	TABLE ANGLE (Degree)	RAW VALUE (dBuV)	CORRECTION FACTOR (dB/m)
1	*2452.00	109.3 PK			1.00 H	311	78.80	30.50
2	*2452.00	95.4 AV			1.00 H	311	64.90	30.50
3	2483.50	71.3 PK	74.0	-2.7	1.19 H	301	40.70	30.60
4	2483.50	53.0 AV	54.0	-1.0	1.19 H	301	22.40	30.60
5	#3269.00	44.4 PK	89.3	-44.9	1.00 H	42	12.00	32.40
6	#3269.00	37.9 AV	75.4	-37.5	1.00 H	42	5.50	32.40
7	4904.00	43.1 PK	74.0	-30.9	1.00 H	16	6.80	36.30
8	4904.00	29.5 AV	54.0	-24.5	1.00 H	16	-6.80	36.30
ANTENNA POLARITY & TEST DISTANCE: VERTICAL AT 3 M								
NO.	FREQ. (MHz)	EMISSION LEVEL (dBuV/m)	LIMIT (dBuV/m)	MARGIN (dB)	ANTENNA HEIGHT (m)	TABLE ANGLE (Degree)	RAW VALUE (dBuV)	CORRECTION FACTOR (dB/m)
1	*2452.00	107.9 PK			1.33 V	30	77.40	30.50
2	*2452.00	93.3 AV			1.33 V	30	62.80	30.50
3	2483.50	70.8 PK	74.0	-3.2	1.31 V	15	40.20	30.60
4	2483.50	51.3 AV	54.0	-2.7	1.31 V	15	20.70	30.60
5	#3269.00	47.0 PK	87.9	-40.9	1.00 V	344	14.60	32.40
6	#3269.00	42.1 AV	73.3	-31.2	1.00 V	344	9.70	32.40
7	4904.00	43.1 PK	74.0	-30.9	1.00 V	13	6.80	36.30
8	4904.00	32.0 AV	54.0	-22.0	1.00 V	13	-4.30	36.30

- REMARKS:**
1. Emission level (dBuV/m) = Raw Value (dBuV) + Correction Factor (dB/m).
 2. Correction Factor (dB/m) = Antenna Factor (dB/m) + Cable Factor (dB).
 3. The other emission levels were very low against the limit.
 4. Margin value = Emission level – Limit value.
 5. “ * “: Fundamental frequency.
 6. “#”:The radiated frequency is out the restricted band.



A D T

BELOW 1GHz WORST-CASE DATA : 802.11n (40MHz)

EUT TEST CONDITION		MEASUREMENT DETAIL	
CHANNEL	Channel 4	FREQUENCY RANGE	Below 1000MHz
INPUT POWER (SYSTEM)	120Vac, 60 Hz	DETECTOR FUNCTION	Quasi-Peak
ENVIRONMENTAL CONDITIONS	22deg. C, 61%RH 1010 hPa	TESTED BY	Chad Lee
TEST MODE	A		

ANTENNA POLARITY & TEST DISTANCE: HORIZONTAL AT 3 M								
NO.	FREQ. (MHz)	EMISSION LEVEL (dBuV/m)	LIMIT (dBuV/m)	MARGIN (dB)	ANTENNA HEIGHT (m)	TABLE ANGLE (Degree)	RAW VALUE (dBuV)	CORRECTION FACTOR (dB/m)
1	62.95	26.2 QP	40.0	-13.8	1.50 H	220	13.30	12.90
2	144.61	28.1 QP	43.5	-15.4	2.00 H	79	13.80	14.30
3	344.87	30.9 QP	46.0	-15.1	1.00 H	112	14.80	16.10
4	543.19	31.9 QP	46.0	-14.1	1.50 H	355	10.70	21.20
5	875.67	31.6 QP	46.0	-14.4	1.50 H	67	5.00	26.60
6	945.66	35.0 QP	46.0	-11.0	1.50 H	7	7.50	27.50

ANTENNA POLARITY & TEST DISTANCE: VERTICAL AT 3 M								
NO.	FREQ. (MHz)	EMISSION LEVEL (dBuV/m)	LIMIT (dBuV/m)	MARGIN (dB)	ANTENNA HEIGHT (m)	TABLE ANGLE (Degree)	RAW VALUE (dBuV)	CORRECTION FACTOR (dB/m)
1	62.95	34.6 QP	40.0	-5.4	1.50 V	97	21.70	12.90
2	99.89	29.8 QP	43.5	-13.7	1.00 V	67	19.50	10.30
3	799.84	32.4 QP	46.0	-13.6	1.50 V	331	7.10	25.30
4	875.67	32.9 QP	46.0	-13.1	1.00 V	10	6.30	26.60
5	906.77	36.7 QP	46.0	-9.3	1.00 V	340	9.60	27.10
6	930.11	37.7 QP	46.0	-8.3	2.00 V	340	10.40	27.30

- REMARKS:**
1. Emission level (dBuV/m) = Raw Value (dBuV) + Correction Factor (dB/m).
 2. Correction Factor (dB/m) = Antenna Factor (dB/m) + Cable Factor (dB).
 3. The other emission levels were very low against the limit.
 4. Margin value = Emission level – Limit value.



A D T

EUT TEST CONDITION		MEASUREMENT DETAIL	
CHANNEL	Channel 4	FREQUENCY RANGE	Below 1000MHz
INPUT POWER (SYSTEM)	120Vac, 60 Hz	DETECTOR FUNCTION	Quasi-Peak
ENVIRONMENTAL CONDITIONS	22deg. C, 61%RH 1010 hPa	TESTED BY	Chad Lee
TEST MODE	B		

ANTENNA POLARITY & TEST DISTANCE: HORIZONTAL AT 3 M								
NO.	FREQ. (MHz)	EMISSION LEVEL (dBuV/m)	LIMIT (dBuV/m)	MARGIN (dB)	ANTENNA HEIGHT (m)	TABLE ANGLE (Degree)	RAW VALUE (dBuV)	CORRECTION FACTOR (dB/m)
1	599.58	30.7 QP	46.0	-15.3	1.50 H	31	8.20	22.50
2	799.84	31.5 QP	46.0	-14.5	1.00 H	319	6.20	25.30
3	867.89	30.2 QP	46.0	-15.8	1.50 H	100	3.80	26.40
4	906.77	31.7 QP	46.0	-14.3	1.50 H	25	4.60	27.10
5	928.16	33.8 QP	46.0	-12.2	2.00 H	4	6.50	27.30
6	959.27	36.0 QP	46.0	-10.0	2.00 H	40	8.30	27.70

ANTENNA POLARITY & TEST DISTANCE: VERTICAL AT 3 M								
NO.	FREQ. (MHz)	EMISSION LEVEL (dBuV/m)	LIMIT (dBuV/m)	MARGIN (dB)	ANTENNA HEIGHT (m)	TABLE ANGLE (Degree)	RAW VALUE (dBuV)	CORRECTION FACTOR (dB/m)
1	31.84	35.6 QP	40.0	-4.4	1.00 V	163	23.10	12.50
2	64.90	30.2 QP	40.0	-9.8	1.00 V	220	17.60	12.60
3	533.47	33.7 QP	46.0	-12.3	1.00 V	10	12.70	21.00
4	640.41	30.4 QP	46.0	-15.6	1.00 V	10	7.20	23.20
5	809.56	32.1 QP	46.0	-13.9	1.50 V	340	6.70	25.40
6	928.16	37.3 QP	46.0	-8.7	1.50 V	352	10.00	27.30

- REMARKS:**
1. Emission level (dBuV/m) = Raw Value (dBuV) + Correction Factor (dB/m).
 2. Correction Factor (dB/m) = Antenna Factor (dB/m) + Cable Factor (dB).
 3. The other emission levels were very low against the limit.
 4. Margin value = Emission level – Limit value.



4.2 CONDUCTED EMISSION MEASUREMENT

4.2.1 LIMITS OF CONDUCTED EMISSION MEASUREMENT

FREQUENCY OF EMISSION (MHz)	CONDUCTED LIMIT (dB μ V)	
	Quasi-peak	Average
0.15 ~ 0.5	66 to 56	56 to 46
0.5 ~ 5	56	46
5 ~ 30	60	50

- NOTE:** 1. The lower limit shall apply at the transition frequencies.
 2. The limit decreases in line with the logarithm of the frequency in the range of 0.15 to 0.50MHz.
 3. All emanations from a class A/B digital device or system, including any network of conductors and apparatus connected thereto, shall not exceed the level of field strengths specified above.

4.2.2 TEST INSTRUMENTS

DESCRIPTION & MANUFACTURER	MODEL NO.	SERIAL NO.	DATE OF CALIBRATION	DUE DATE OF CALIBRATION
Test Receiver ROHDE & SCHWARZ	ESCS30	100291	Nov. 30, 2010	Nov. 29, 2011
RF signal cable Woken	5D-FB	Cable-HYC01-01	Dec. 30, 2010	Dec. 29, 2011
LISN ROHDE & SCHWARZ	ESH2-Z5	100100	Jan. 06, 2011	Jan. 05, 2012
LISN ROHDE & SCHWARZ	ESH3-Z5	835239/001	Feb. 22, 2011	Feb. 21, 2012
V-LISN SCHWARZBECK	NNBL 8226-2	8226-142	Jul. 12, 2010	Jul. 11, 2011
LISN ROHDE & SCHWARZ	ENV216	100072	Jun. 10, 2011	Jun. 09, 2012
Software ADT	ADT_Cond_ V7.3.7	NA	NA	NA

- NOTE:** 1. The calibration interval of the above test instruments is 12 months and the calibrations are traceable to NML/ROC and NIST/USA.
 2. The test was performed in HwaYa Shielded Room 1.
 3. The VCCI Site Registration No. is C-2040.



A D T

4.2.3 TEST PROCEDURES

- a. The EUT was placed 0.4 meters from the conducting wall of the shielded room with EUT being connected to the power mains through a line impedance stabilization network (LISN). Other support units were connected to the power mains through another LISN. The two LISNs provide 50 ohm/ 50uH of coupling impedance for the measuring instrument.
- b. Both lines of the power mains connected to the EUT were checked for maximum conducted interference.
- c. The frequency range from 150kHz to 30MHz was searched. Emission levels under (Limit - 20dB) was not recorded.

NOTE: All modes of operation were investigated and the worst-case emissions are reported.

4.2.4 DEVIATION FROM TEST STANDARD

No deviation.

4.2.5 TEST SETUP

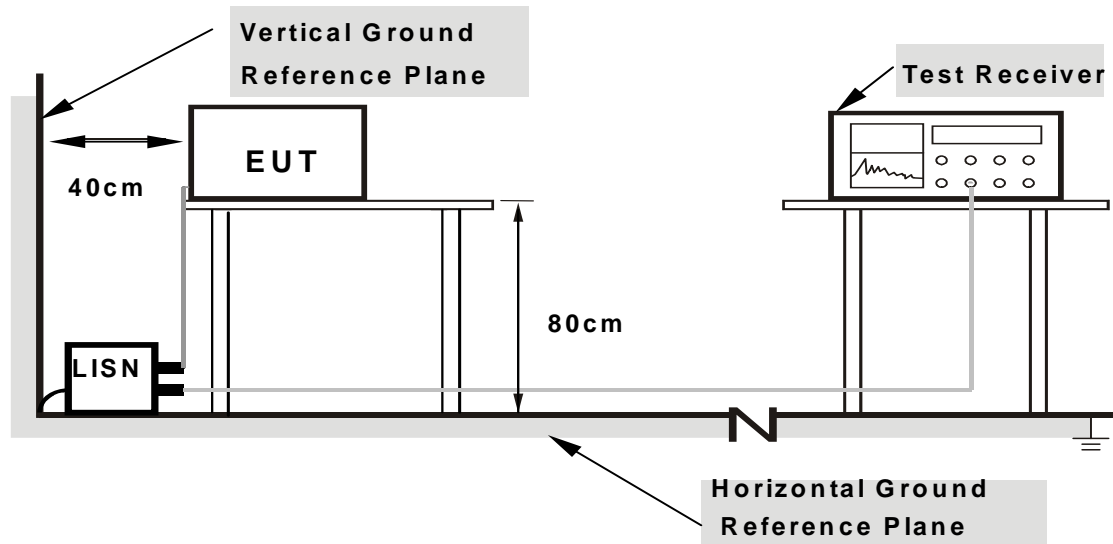

- Note:**
1. Support units were connected to second LISN.
 2. Both of LISNs (AMN) are 80 cm from EUT and at least 80 from other units and other metal planes

For the actual test configuration, please refer to the attached file (Test Setup Photo).

4.2.6 EUT OPERATING CONDITIONS

Same as 4.1.6.

4.2.7 TEST RESULTS

CONDUCTED WORST-CASE DATA : 802.11n(40MHz)

PHASE	Line 1	6dB BANDWIDTH	9kHz
TEST MODE	A		

No	Freq. [MHz]	Corr. Factor (dB)	Reading Value		Emission Level		Limit		Margin	
			[dB (uV)]		[dB (uV)]		[dB (uV)]		(dB)	
			Q.P.	AV.	Q.P.	AV.	Q.P.	AV.	Q.P.	AV.
1	0.150	0.15	60.22	35.73	60.37	35.88	66.00	56.00	-5.63	-20.12
2	0.166	0.14	58.70	33.84	58.84	33.98	65.18	55.18	-6.33	-21.19
3	0.193	0.14	56.74	27.76	56.88	27.90	63.91	53.91	-7.03	-26.01
4	0.205	0.14	56.48	32.65	56.62	32.79	63.42	53.42	-6.80	-20.63
5	0.244	0.14	54.06	27.79	54.20	27.93	61.97	51.97	-7.77	-24.04
6	0.373	0.15	45.17	-	45.32	-	58.44	48.44	-13.12	-

- REMARKS:**
1. Q.P. and AV. are abbreviations of quasi-peak and average individually.
 2. "-": The Quasi-peak reading value also meets average limit and measurement with the average detector is unnecessary.
 3. The emission levels of other frequencies were very low against the limit.
 4. Margin value = Emission level - Limit value
 5. Correction factor = Insertion loss + Cable loss
 6. Emission Level = Correction Factor + Reading Value.

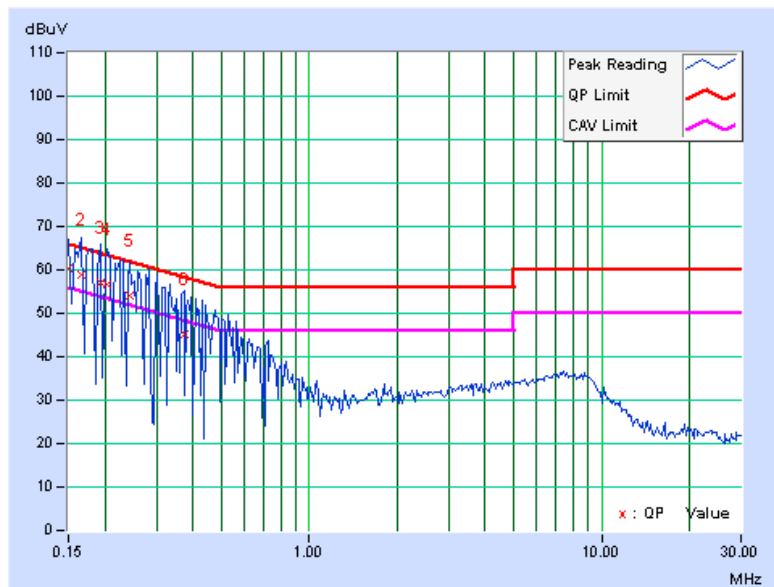

PHASE	Line 2	6dB BANDWIDTH	9kHz
TEST MODE	A		

No	Freq. [MHz]	Corr. Factor (dB)	Reading Value		Emission Level		Limit		Margin	
			[dB (uV)]		[dB (uV)]		[dB (uV)]		(dB)	
			Q.P.	AV.	Q.P.	AV.	Q.P.	AV.	Q.P.	AV.
1	0.150	0.12	59.68	34.66	59.80	34.78	66.00	56.00	-6.20	-21.22
2	0.173	0.13	57.45	32.55	57.58	32.68	64.79	54.79	-7.22	-22.12
3	0.201	0.13	55.75	29.52	55.88	29.65	63.58	53.58	-7.70	-23.93
4	0.259	0.13	52.12	31.52	52.25	31.65	61.45	51.45	-9.20	-19.80
5	0.326	0.14	47.80	-	47.94	-	59.56	49.56	-11.62	-
6	0.447	0.14	40.79	-	40.93	-	56.93	46.93	-16.00	-

- REMARKS:**
1. Q.P. and AV. are abbreviations of quasi-peak and average individually.
 2. "-": The Quasi-peak reading value also meets average limit and measurement with the average detector is unnecessary.
 3. The emission levels of other frequencies were very low against the limit.
 4. Margin value = Emission level - Limit value
 5. Correction factor = Insertion loss + Cable loss
 6. Emission Level = Correction Factor + Reading Value.

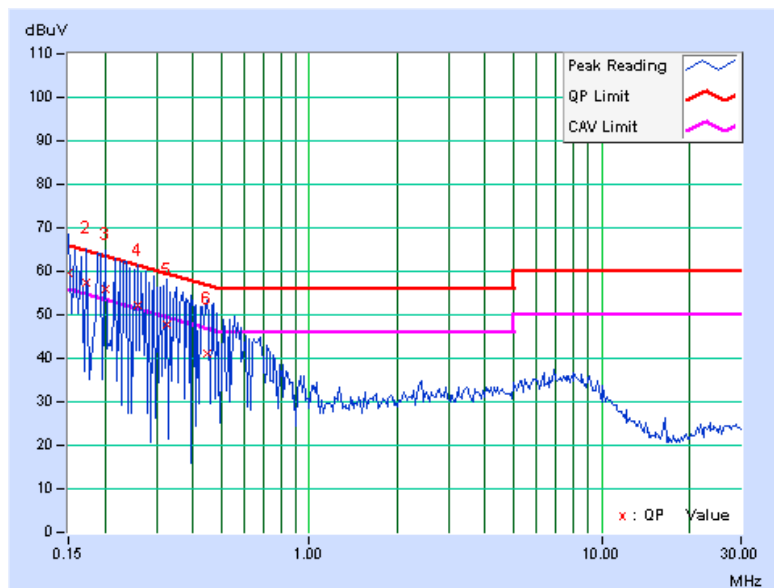

PHASE	Line 1	6dB BANDWIDTH	9kHz
TEST MODE	B		

No	Freq. [MHz]	Corr. Factor (dB)	Reading Value [dB (uV)]		Emission Level [dB (uV)]		Limit [dB (uV)]		Margin (dB)	
			Q.P.	AV.	Q.P.	AV.	Q.P.	AV.	Q.P.	AV.
1	0.150	0.15	48.73	-	48.88	-	66.00	56.00	-17.12	-
2	0.201	0.14	41.01	-	41.15	-	63.58	53.58	-22.43	-
3	0.400	0.15	44.97	-	45.12	-	57.85	47.85	-12.73	-
4	1.180	0.20	32.49	-	32.69	-	56.00	46.00	-23.31	-
5	10.098	0.81	27.88	-	28.69	-	60.00	50.00	-31.31	-
6	23.051	1.74	34.09	-	35.83	-	60.00	50.00	-24.17	-

- REMARKS:**
1. Q.P. and AV. are abbreviations of quasi-peak and average individually.
 2. "-": The Quasi-peak reading value also meets average limit and measurement with the average detector is unnecessary.
 3. The emission levels of other frequencies were very low against the limit.
 4. Margin value = Emission level - Limit value
 5. Correction factor = Insertion loss + Cable loss
 6. Emission Level = Correction Factor + Reading Value.

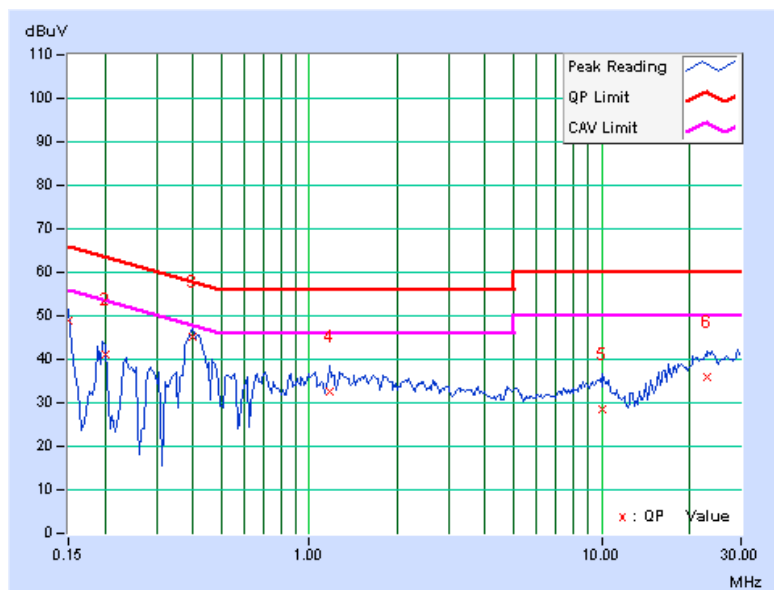

PHASE	Line 2	6dB BANDWIDTH	9kHz
TEST MODE	B		

No	Freq. [MHz]	Corr. Factor (dB)	Reading Value		Emission Level		Limit		Margin	
			[dB (uV)]		[dB (uV)]		[dB (uV)]		(dB)	
			Q.P.	AV.	Q.P.	AV.	Q.P.	AV.	Q.P.	AV.
1	0.154	0.13	46.66	-	46.79	-	65.79	55.79	-19.00	-
2	0.185	0.13	38.67	-	38.80	-	64.25	54.25	-25.45	-
3	0.404	0.14	44.04	-	44.18	-	57.77	47.77	-13.59	-
4	0.705	0.16	34.36	-	34.52	-	56.00	46.00	-21.48	-
5	10.609	0.75	29.01	-	29.76	-	60.00	50.00	-30.24	-
6	23.727	1.58	35.26	-	36.84	-	60.00	50.00	-23.16	-

- REMARKS:**
1. Q.P. and AV. are abbreviations of quasi-peak and average individually.
 2. "-": The Quasi-peak reading value also meets average limit and measurement with the average detector is unnecessary.
 3. The emission levels of other frequencies were very low against the limit.
 4. Margin value = Emission level - Limit value
 5. Correction factor = Insertion loss + Cable loss
 6. Emission Level = Correction Factor + Reading Value.

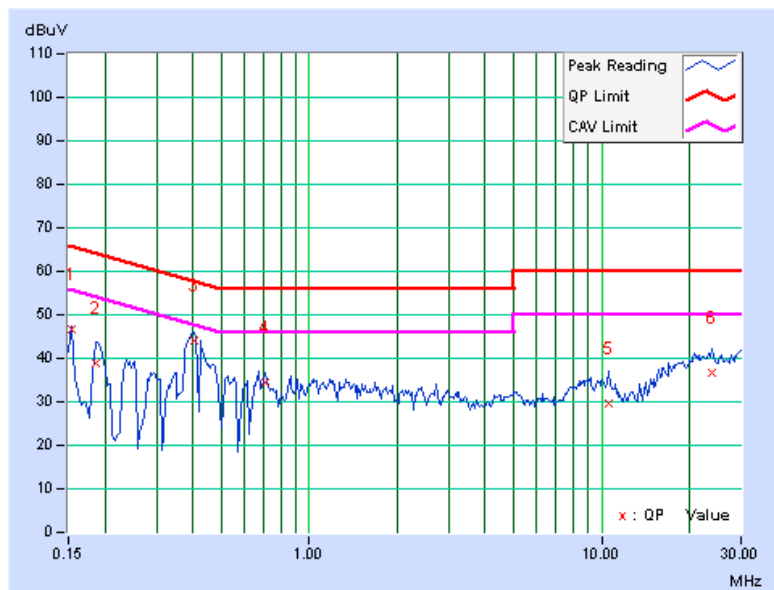



A D T

4.3 6dB BANDWIDTH MEASUREMENT

4.3.1 LIMITS OF 6dB BANDWIDTH MEASUREMENT

The minimum of 6dB Bandwidth Measurement is 0.5 MHz.

4.3.2 TEST INSTRUMENTS

DESCRIPTION & MANUFACTURER	MODEL NO.	SERIAL NO.	DATE OF CALIBRATION	DUE DATE OF CALIBRATION
SPECTRUM ANALYZER R&S	FSP40	100040	Jul. 17, 2010	Jul. 16, 2011

NOTE: The calibration interval of the above test instruments is 12 months and the calibrations are traceable to NML/ROC and NIST/USA.

4.3.3 TEST PROCEDURE

The transmitter output was connected to the spectrum analyzer through an attenuator. The bandwidth of the fundamental frequency was measured by spectrum analyzer with 100kHz RBW and 300kHz VBW. The 6dB bandwidth is defined as the total spectrum the power of which is higher than peak power minus 6dB.

4.3.4 DEVIATION FROM TEST STANDARD

No deviation.

4.3.5 TEST SETUP



4.3.6 EUT OPERATING CONDITIONS

The software provided by client to enable the EUT under transmission condition continuously at lowest, middle and highest channel frequencies individually.



A D T

4.3.7 TEST RESULTS

802.11b

CHANNEL	CHANNEL FREQUENCY (MHz)	6dB BANDWIDTH (MHz)	MINIMUM LIMIT (MHz)	PASS / FAIL
1	2412	10.11	0.5	PASS
6	2437	10.10	0.5	PASS
11	2462	10.14	0.5	PASS

CH 11

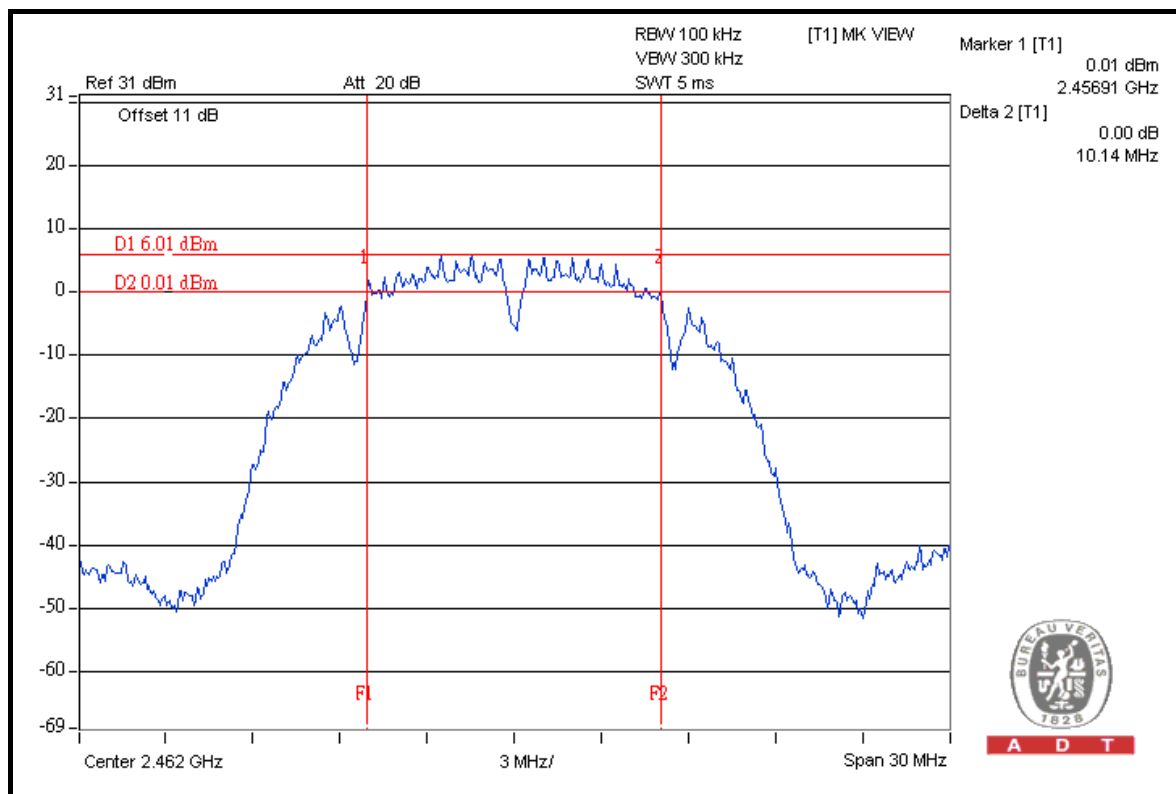



A D T

802.11g

CHANNEL	CHANNEL FREQUENCY (MHz)	6dB BANDWIDTH (MHz)	MINIMUM LIMIT (MHz)	PASS / FAIL
1	2412	16.42	0.5	PASS
6	2437	16.40	0.5	PASS
11	2462	16.46	0.5	PASS

CH 11

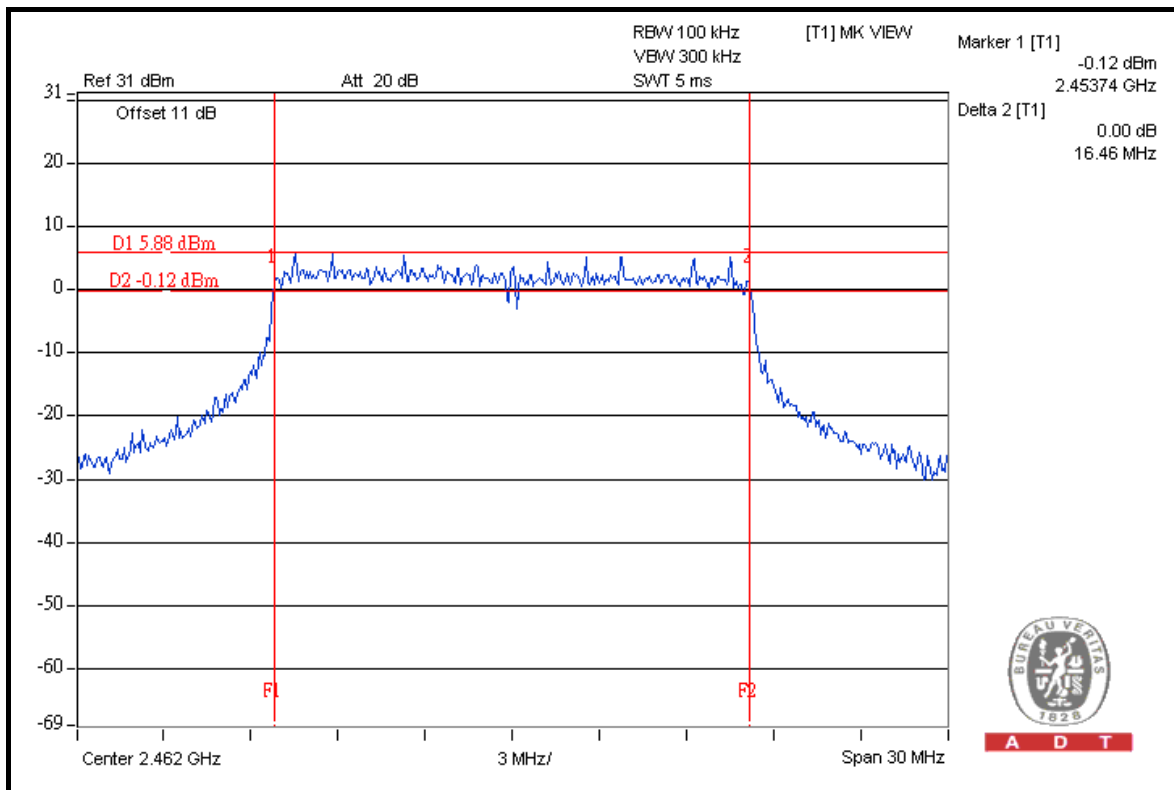

A D T



A D T

802.11n (20MHz)

CHANNEL	CHANNEL FREQUENCY (MHz)	6dB BANDWIDTH (MHz)			MINIMUM LIMIT (MHz)	PASS / FAIL
		CHAIN 0	CHAIN 1	CHAIN 2		
1	2412	17.66	17.23	17.62	0.5	PASS
6	2437	17.62	17.62	17.67	0.5	PASS
11	2462	17.62	17.61	17.66	0.5	PASS

FOR CHAIN 2: CH 6

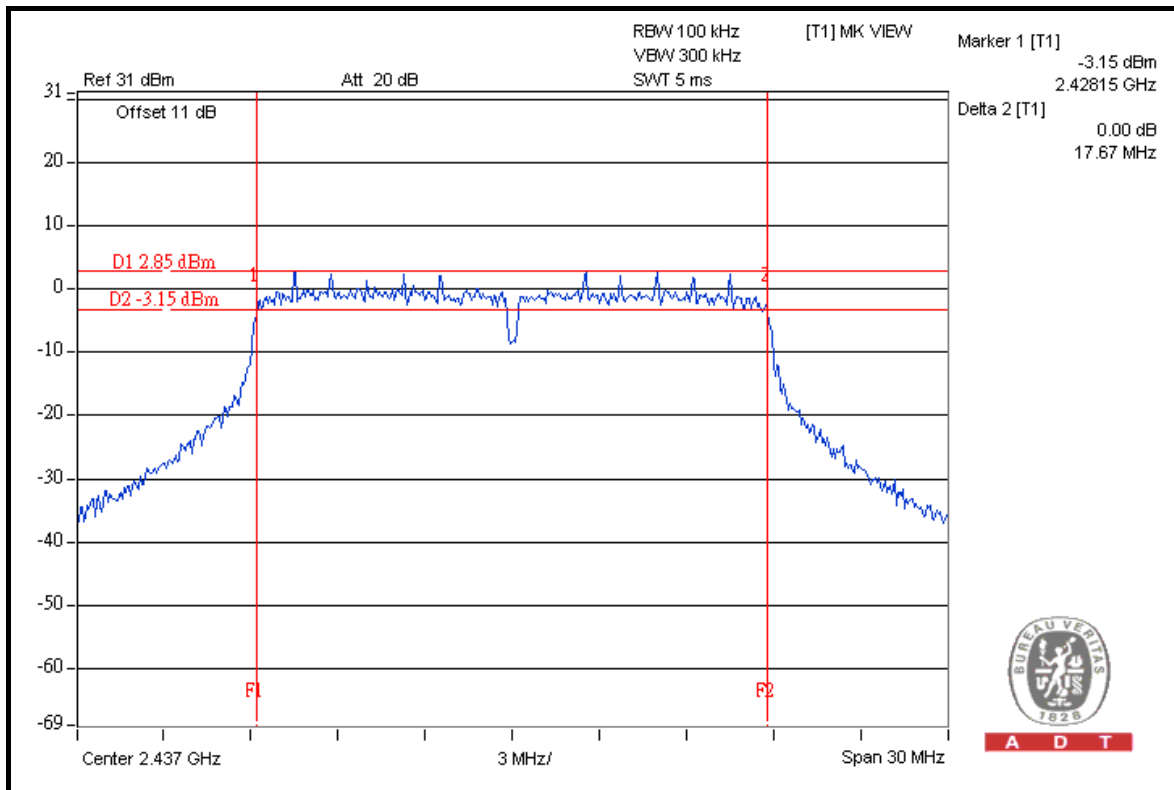

A D T



A D T

4.4 MAXIMUM OUTPUT POWER

4.4.1 LIMITS OF MAXIMUM OUTPUT POWER MEASUREMENT

The Maximum Output Power Measurement is 30dBm.

4.4.2 INSTRUMENTS

DESCRIPTION & MANUFACTURER	MODEL NO.	SERIAL NO.	DATE OF CALIBRATION	DUE DATE OF CALIBRATION
High Speed Peak Power Meter	ML2495A	0824011	Aug. 02, 2010	Aug. 01, 2011
Power Sensor	MA2411B	0738171	Aug. 02, 2010	Aug. 01, 2011

NOTE:

1. The calibration interval of the above test instruments is 12 months and the calibrations are traceable to NML/ROC and NIST/USA.
2. Measurement Bandwidth of ML2495A is 65MHz greater than 6dB bandwidth of emission.

4.4.3 TEST PROCEDURES

A power sensor was used on the output port of the EUT. A power meter was used to read the response of the power sensor. Record the power level.

4.4.4 DEVIATION FROM TEST STANDARD

No deviation.

4.4.5 TEST SETUP

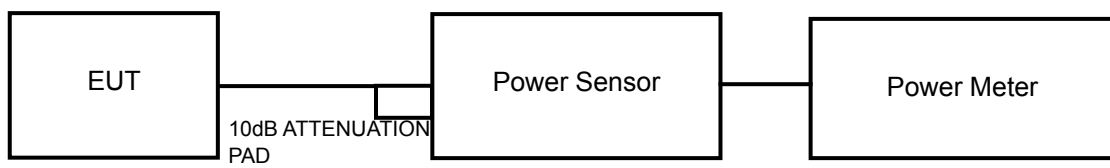

4.4.6 EUT OPERATING CONDITIONS

Same as Item 4.3.6.



4.4.7 TEST RESULTS

802.11b

CHANNEL	CHANNEL FREQUENCY (MHz)	PEAK POWER OUTPUT (mW)	PEAK POWER OUTPUT (dBm)	PEAK POWER LIMIT (dBm)	PASS/FAIL
1	2412	234.4	23.7	30	PASS
6	2437	104.7	20.2	30	PASS
11	2462	66.1	18.2	30	PASS

802.11g

CHANNEL	CHANNEL FREQUENCY (MHz)	PEAK POWER OUTPUT (mW)	PEAK POWER OUTPUT (dBm)	PEAK POWER LIMIT (dBm)	PASS/FAIL
1	2412	389.0	25.9	30	PASS
6	2437	398.1	26.0	30	PASS
11	2462	346.7	25.4	30	PASS

802.11n (20MHz)

CHAN.	CHAN. FREQ. (MHz)	POWER OUTPUT (dBm)			TOTAL POWER (mW)	TOTAL POWER (dBm)	POWER LIMIT (dBm)	PASS / FAIL
		CHAIN 0	CHAIN 1	CHAIN 2				
1	2412	24.2	24.6	24.5	833.3	29.2	30	PASS
6	2437	24.5	24.8	25.0	900.1	29.5	30	PASS
11	2462	24.1	24.5	24.6	827.3	29.2	30	PASS

802.11n (40MHz)

CHAN.	CHAN. FREQ. (MHz)	POWER OUTPUT (dBm)			TOTAL POWER (mW)	TOTAL POWER (dBm)	POWER LIMIT (dBm)	PASS / FAIL
		CHAIN 0	CHAIN 1	CHAIN 2				
1	2412	22.8	23.5	23.2	623.3	27.9	30	PASS
6	2437	24.3	25.2	25.0	916.5	29.6	30	PASS
11	2462	23.4	23.8	23.6	687.7	28.4	30	PASS



A D T

4.5 POWER SPECTRAL DENSITY MEASUREMENT

4.5.1 LIMITS OF POWER SPECTRAL DENSITY MEASUREMENT

The Maximum of Power Spectral Density Measurement is 8dBm.

4.5.2 TEST INSTRUMENTS

DESCRIPTION & MANUFACTURER	MODEL NO.	SERIAL NO.	DATE OF CALIBRATION	DUE DATE OF CALIBRATION
SPECTRUM ANALYZER R&S	FSP40	100040	Jul. 17, 2010	Jul. 16, 2011

NOTE: The calibration interval of the above test instruments is 12 months and the calibrations are traceable to NML/ROC and NIST/USA.

4.5.3 TEST PROCEDURE

The transmitter output was connected to the spectrum analyzer through an attenuator, the bandwidth of the fundamental frequency was measured with the spectrum analyzer using 3kHz RBW and 30kHz VBW, set sweep time = span/3kHz. The power spectral density was measured and recorded.

The sweep time is allowed to be longer than span/3kHz for a full response of the mixer in the spectrum analyzer.

Follow method 2 of KDB 662911 D01 Multiple Transmitter Output v01 to calculate total power density of 2 TX port.

4.5.4 DEVIATION FROM TEST STANDARD

No deviation.

4.5.5 TEST SETUP

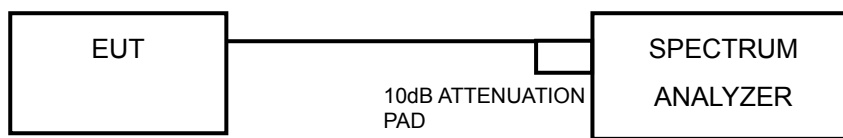

4.5.6 EUT OPERATING CONDITION

Same as Item 4.3.6



A D T

4.5.7 TEST RESULTS

802.11b

CHAN.	CHAN. FREQ. (MHz)	RF POWER LEVEL IN 3kHz BW (dBm)	MAX. LIMIT (dBm)	PASS / FAIL
1	2412	-2.4	8	PASS
6	2437	-5.7	8	PASS
11	2462	-7.9	8	PASS

CH 1

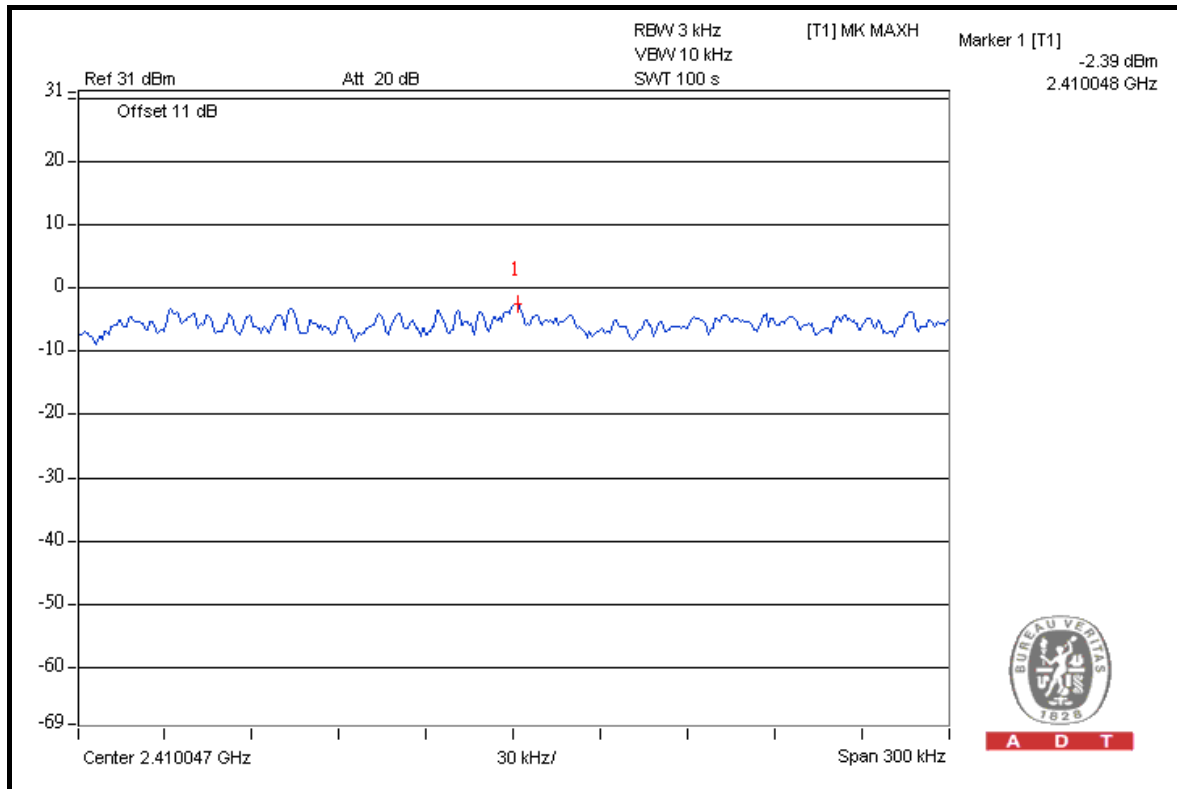



A D T

802.11g

CHAN.	CHAN. FREQ. (MHz)	RF POWER LEVEL IN 3kHz BW (dBm)	MAX. LIMIT (dBm)	PASS / FAIL
1	2412	-7.0	8	PASS
6	2437	-6.8	8	PASS
11	2462	-7.6	8	PASS

CH 6

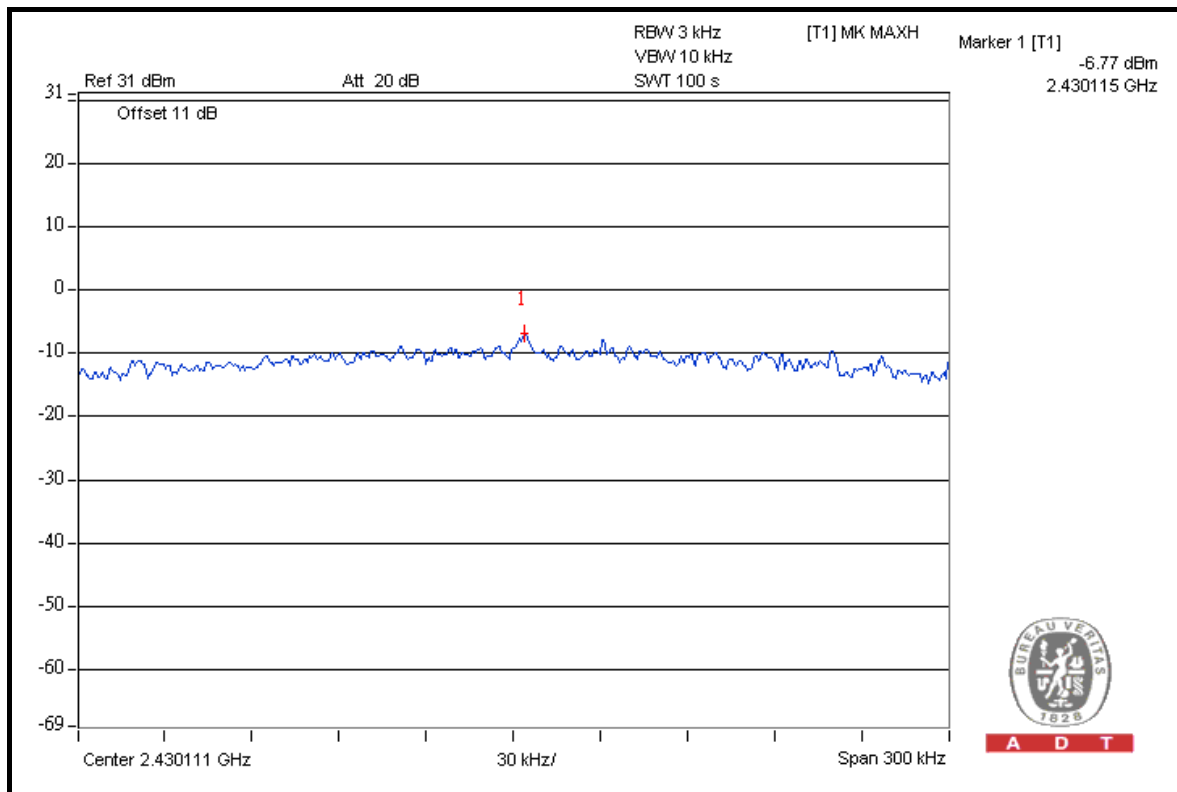

A D T



A D T

802.11n (20MHz)

CHAIN	CHAN.	CHAN. FREQ. (MHz)	RF POWER LEVEL IN 3kHz BW (dBm)		TOTAL POWER DENSITY (dBm)	MAX. LIMIT (dBm)	PASS / FAIL
			MEASURED	10 log (N=3) dB			
0	1	2412	-11.9	4.77	-7.1	8	PASS
	6	2437	-11.8	4.77	-7.0	8	PASS
	11	2462	-12.2	4.77	-7.4	8	PASS
1	1	2412	-11.0	4.77	-6.2	8	PASS
	6	2437	-10.7	4.77	-5.9	8	PASS
	11	2462	-10.9	4.77	-6.1	8	PASS
2	1	2412	-12.2	4.77	-7.4	8	PASS
	6	2437	-11.9	4.77	-7.1	8	PASS
	11	2462	-11.9	4.77	-7.1	8	PASS

FOR CHAIN 1: CH 6

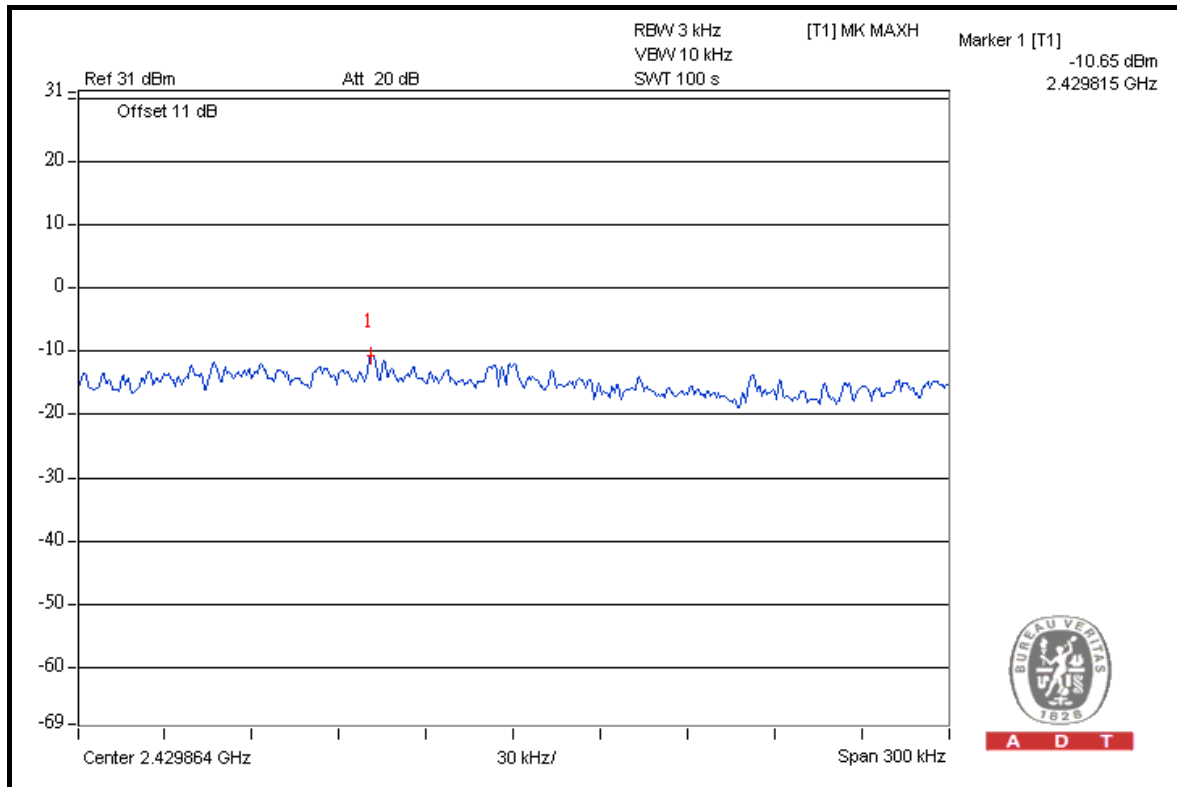



A D T

802.11n (40MHz)

CHAIN	CHAN.	CHAN. FREQ. (MHz)	RF POWER LEVEL IN 3kHz BW (dBm)		TOTAL POWER DENSITY (dBm)	MAX. LIMIT (dBm)	PASS / FAIL
			MEASURED	10 log (N=3) dB			
0	1	2422	-17.1	4.77	-12.3	8	PASS
	4	2437	-15.7	4.77	-10.9	8	PASS
	7	2452	-16.6	4.77	-11.8	8	PASS
1	1	2422	-16.2	4.77	-11.4	8	PASS
	4	2437	-14.4	4.77	-9.6	8	PASS
	7	2452	-15.7	4.77	-10.9	8	PASS
2	1	2422	-15.3	4.77	-10.5	8	PASS
	4	2437	-13.4	4.77	-8.6	8	PASS
	7	2452	-14.9	4.77	-10.1	8	PASS

FOR CHAIN 2: CH 4

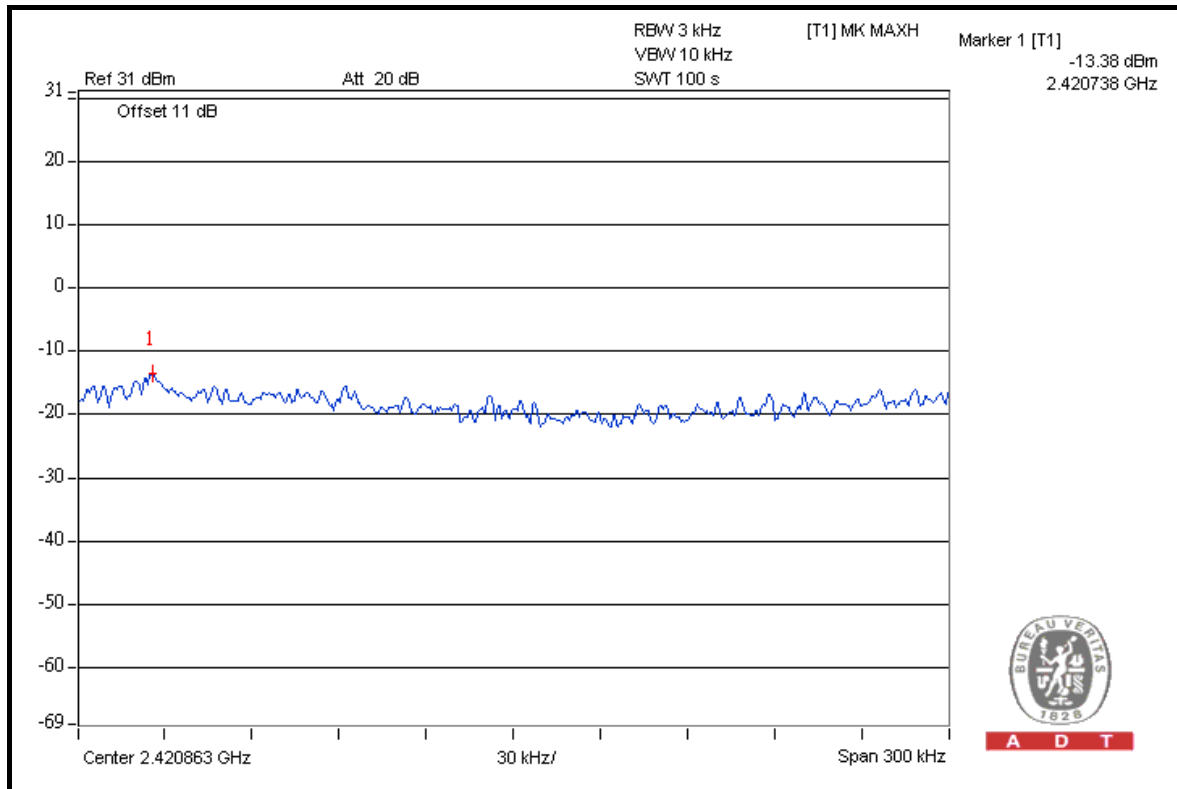

A D T



4.6 BAND EDGES MEASUREMENT

4.6.1 LIMITS OF BAND EDGES MEASUREMENT

Below -20dB of the highest emission level of operating band (in 100kHz Resolution Bandwidth).

4.6.2 TEST INSTRUMENTS

DESCRIPTION & MANUFACTURER	MODEL NO.	SERIAL NO.	DATE OF CALIBRATION	DUE DATE OF CALIBRATION
FOR CONDUCTED MEASUREMENT				
SPECTRUM ANALYZER R&S	FSP40	100040	Jul. 17, 2010	Jul. 16, 2011
FOR RADIATED MEASUREMENT				
Test Receiver ROHDE & SCHWARZ	ESIB7	100212	Jul. 22, 2010	Jul. 21, 2011
Spectrum Analyzer Agilent	E4446A	MY48250266	Aug. 11, 2010	Aug. 10, 2011
BILOG Antenna SCHWARZBECK	VULB9168	9168-160	Apr. 13, 2011	Apr. 12, 2012
HORN Antenna SCHWARZBECK	9120D	9120D-405	Feb. 08, 2011	Feb. 07, 2012
HORN Antenna SCHWARZBECK	BBHA 9170	BBHA9170243	Dec. 27, 2010	Dec. 26, 2011
Preamplifier Agilent	8447D	2944A10633	Nov. 02, 2010	Nov. 01, 2011
Preamplifier Agilent	8449B	3008A01964	Nov. 02, 2010	Nov. 01, 2011
RF signal cable HUBER+SUHNNER	SUCOFLEX 104	295014/4	Sep 03, 2010	Sep 02, 2011
RF signal cable HUBER+SUHNNER	SUCOFLEX 104	12738/6	Sep 03, 2010	Sep 02, 2011
Software ADT.	ADT_Radiated_V7.6.15.9.2	NA	NA	NA
Antenna Tower inn-co GmbH	MA 4000	013303	NA	NA
Antenna Tower Controller inn-co GmbH	CO2000	017303	NA	NA
Turn Table ADT.	TT100.	TT93021703	NA	NA
Turn Table Controller ADT.	SC100.	SC93021703	NA	NA

NOTE: The calibration interval of the above test instruments is 12 months and the calibrations are traceable to NML/ROC and NIST/USA.



4.6.3 TEST PROCEDURE

- a. The EUT was placed on the top of a rotating table 0.8 meters above the ground at a 3 meter semi-anechoic chamber. The table was rotated 360 degrees to determine the position of the highest radiation.
- b. The EUT was set 3 meters away from the interference-receiving antenna, which was mounted on the top of a variable-height antenna tower.
- c. The antenna is a broadband antenna, and its height is varied from one meter to four meters above the ground to determine the maximum value of the field strength. Both horizontal and vertical polarizations of the antenna are set to make the measurement.
- d. For each suspected emission, the EUT was arranged to its worst case and then the antenna was tuned to heights from 1 meter to 4 meters and the rotatable table was turned from 0 degrees to 360 degrees to find the maximum reading.
- e. Set both RBW and VBW of spectrum analyzer to 100kHz and 300kHz with suitable frequency span including 100MHz bandwidth from band edge. The band edges was measured and recorded.

The spectrum plots (Peak RBW = 100kHz, VBW = 300kHz) are attached on the following pages.

NOTE: The resolution bandwidth of test receiver/spectrum analyzer is 1MHz and the video bandwidth is 10Hz for Average detection (AV) at frequency above 1GHz.

4.6.4 DEVIATION FROM TEST STANDARD

No deviation.

4.6.5 EUT OPERATING CONDITION

Same as Item 4.3.6.



4.6.6 TEST RESULTS

The spectrum plots are attached on the following pages. D1 line indicates the highest level, and D2 line indicates the 20dB offset below D1. It shows compliance with the requirement in part 15.247(d).

802.11b

RESTRICT BAND (2310 ~ 2390 MHz)

FREQUENCY (MHz)	FUNDAMENTAL EMISSION (dBuV/m)	DELTA (dB)	MAXIMUM FIELD STRENGTH IN RESTRICT BAND (dBuV/m)	LIMIT (dBuV/m)
2412.00 (PK)	111.20	51.86	59.34	74.00
2412.00 (AV)	106.90	54.45	52.45	54.00

RESTRICT BAND (2483.5 ~ 2500 MHz)

FREQUENCY (MHz)	FUNDAMENTAL EMISSION (dBuV/m)	DELTA (dB)	MAXIMUM FIELD STRENGTH IN RESTRICT BAND (dBuV/m)	LIMIT (dBuV/m)
2462.00 (PK)	105.60	53.88	51.72	74.00
2462.00 (AV)	101.20	61.18	40.02	54.00

NOTE:

1. Delta = Amplitude between the peak of the fundamental and the peak of the band edge emission. Please check following 3 pages.
2. Maximum field strength in restrict band = Fundamental emission – Delta.



A D T

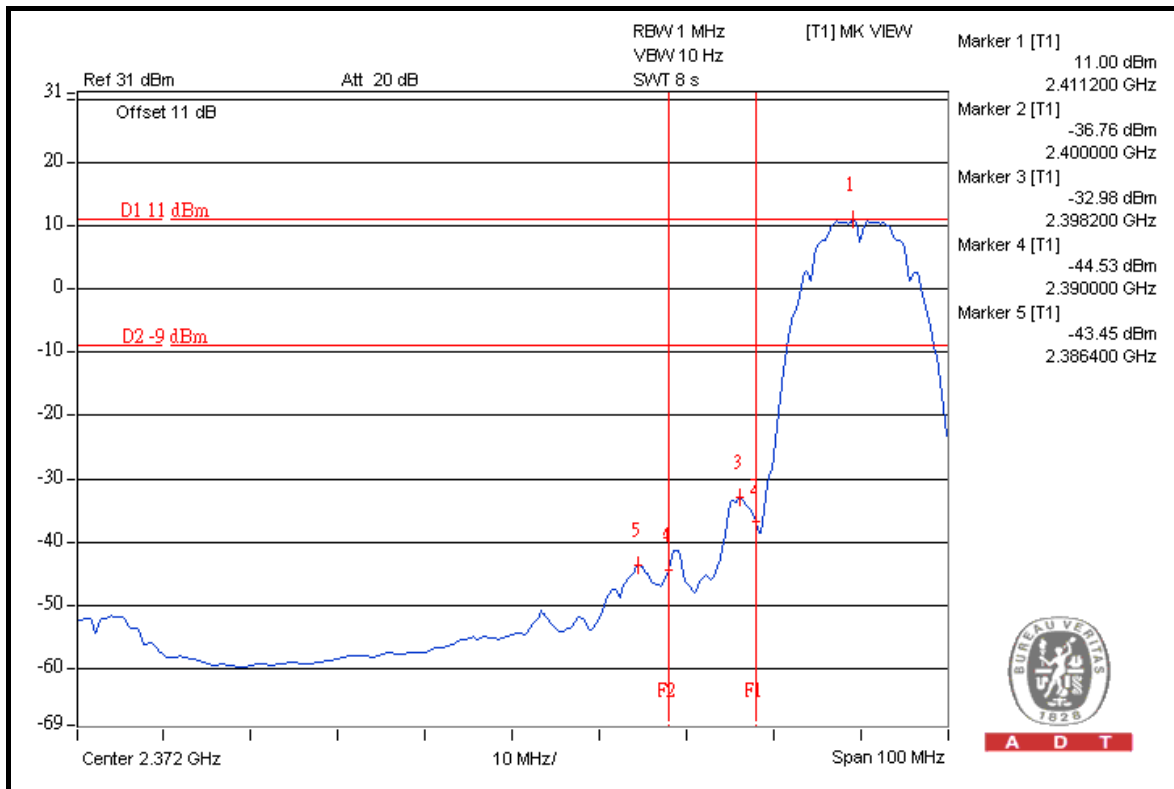
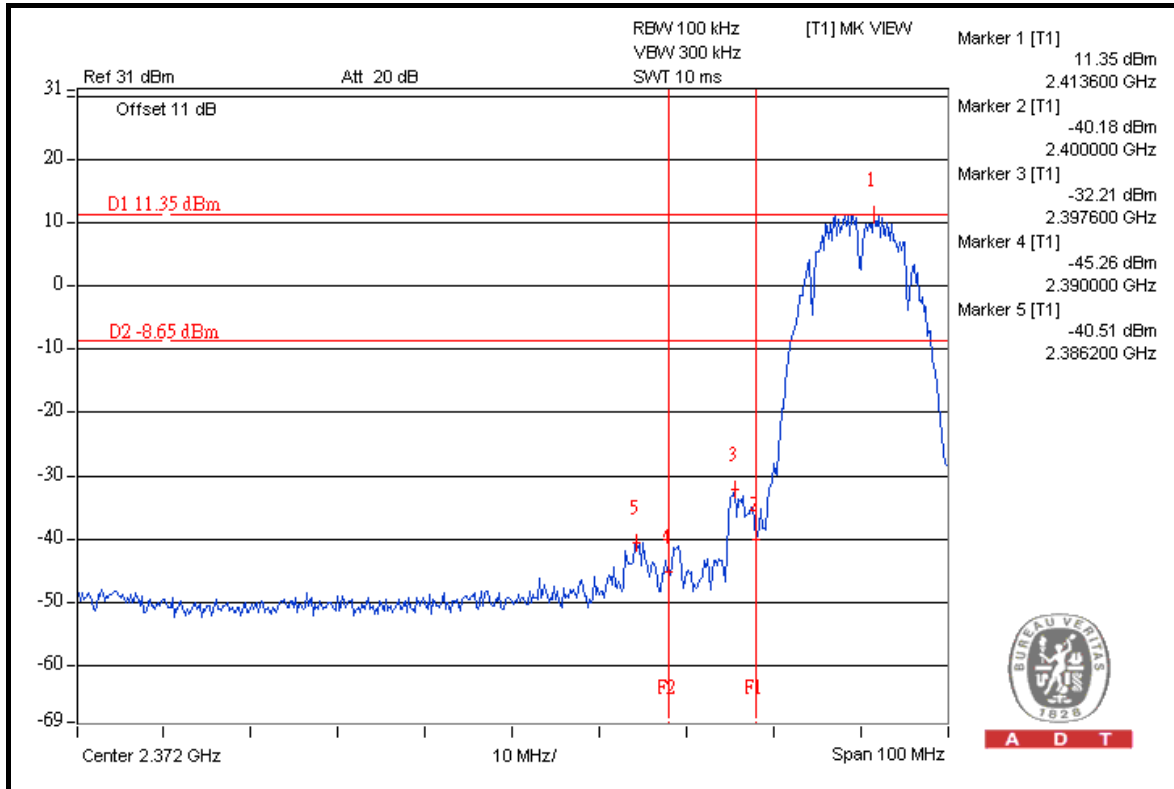



A D T

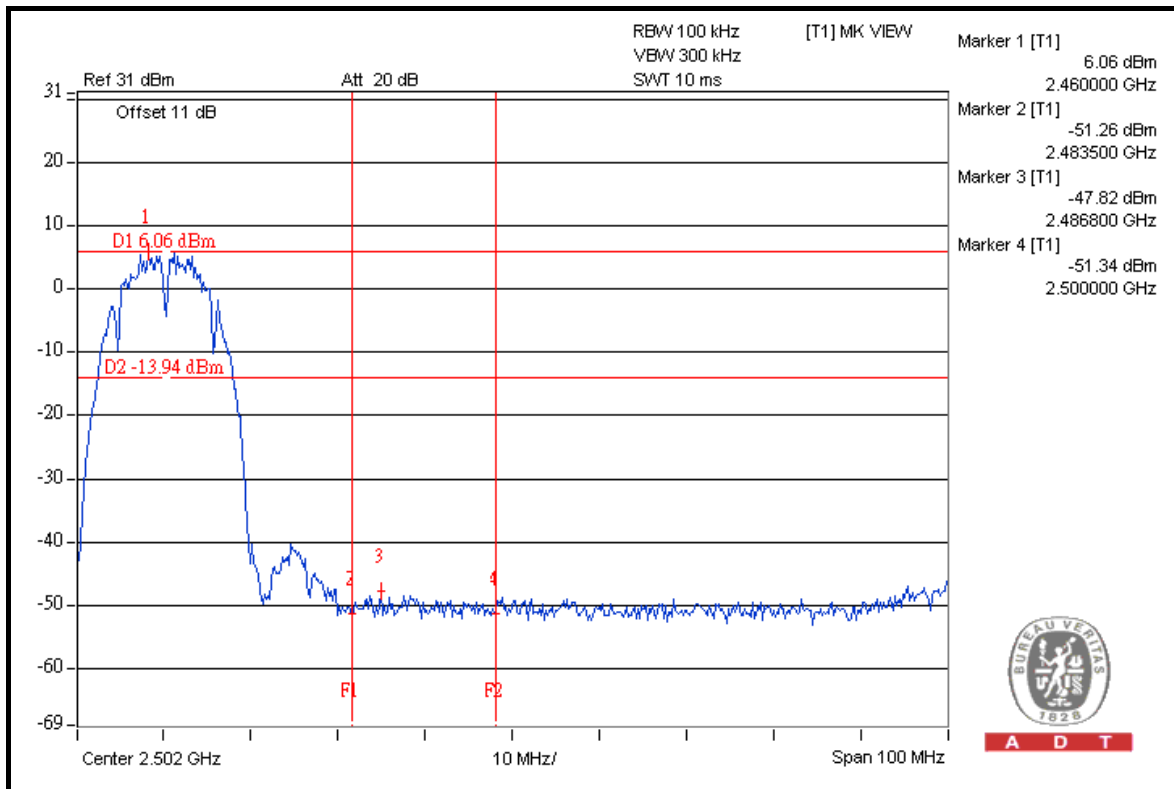
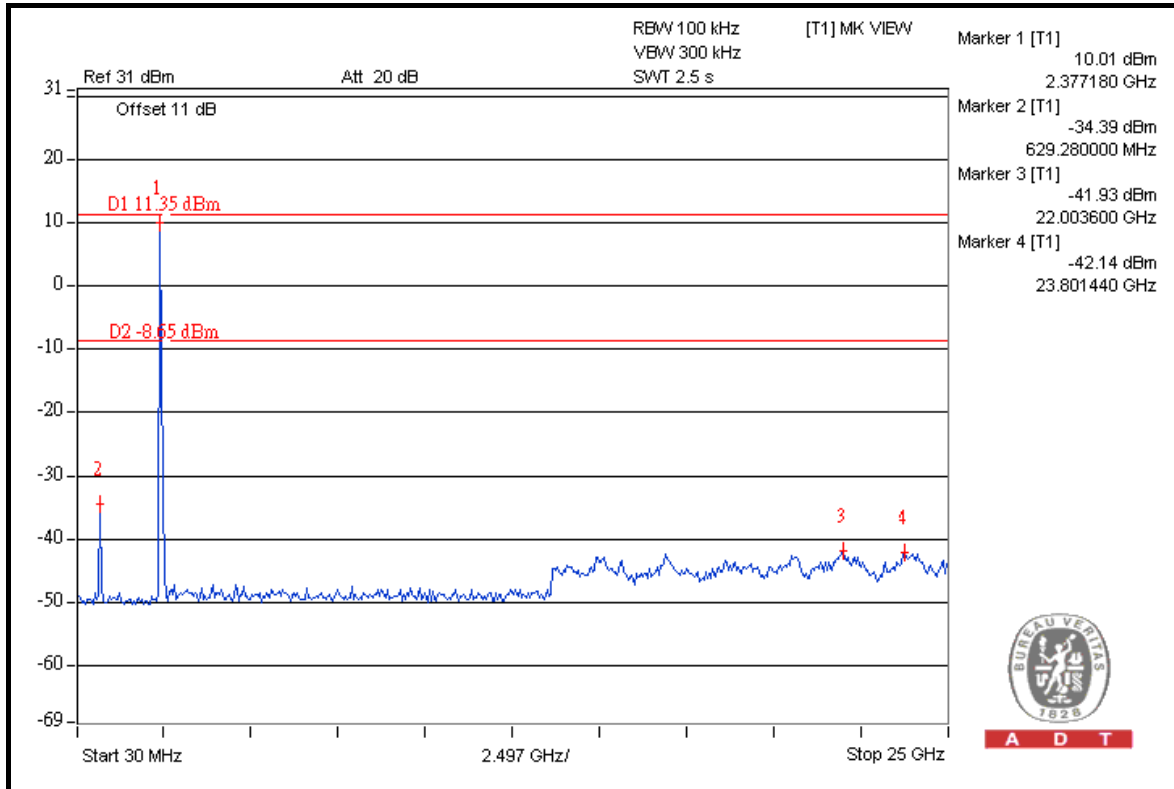



A D T

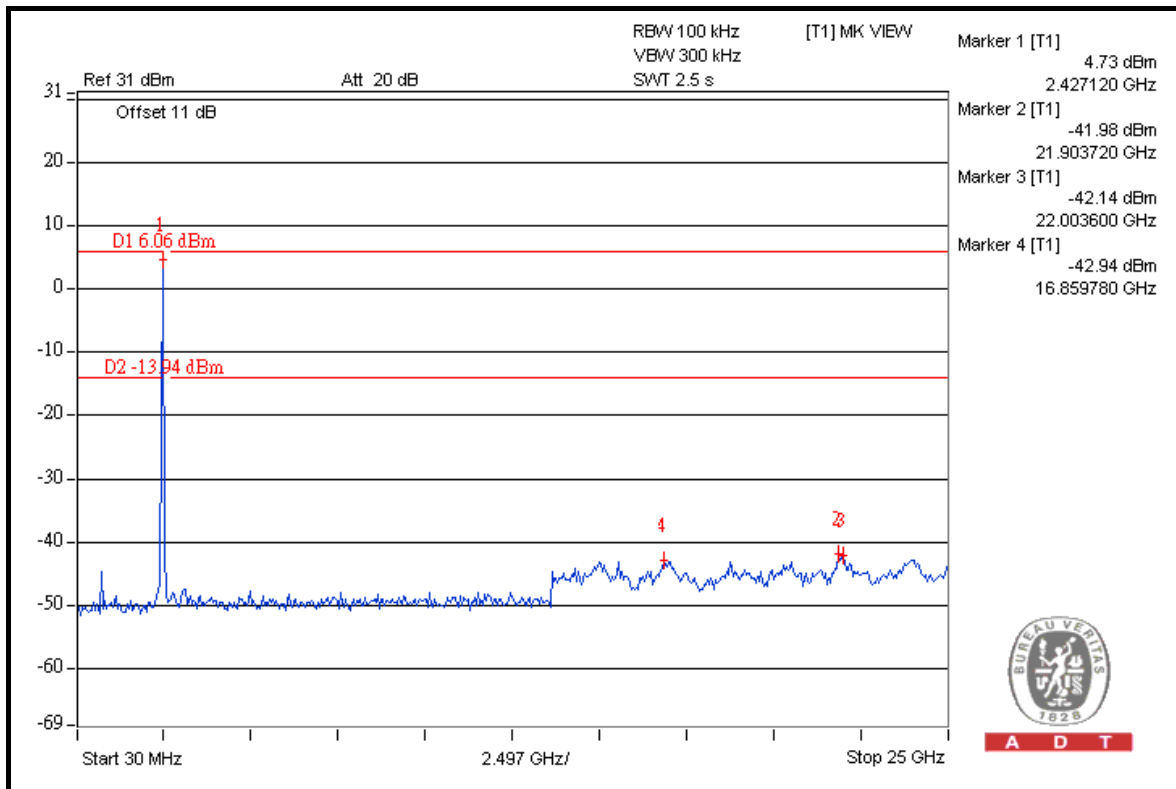
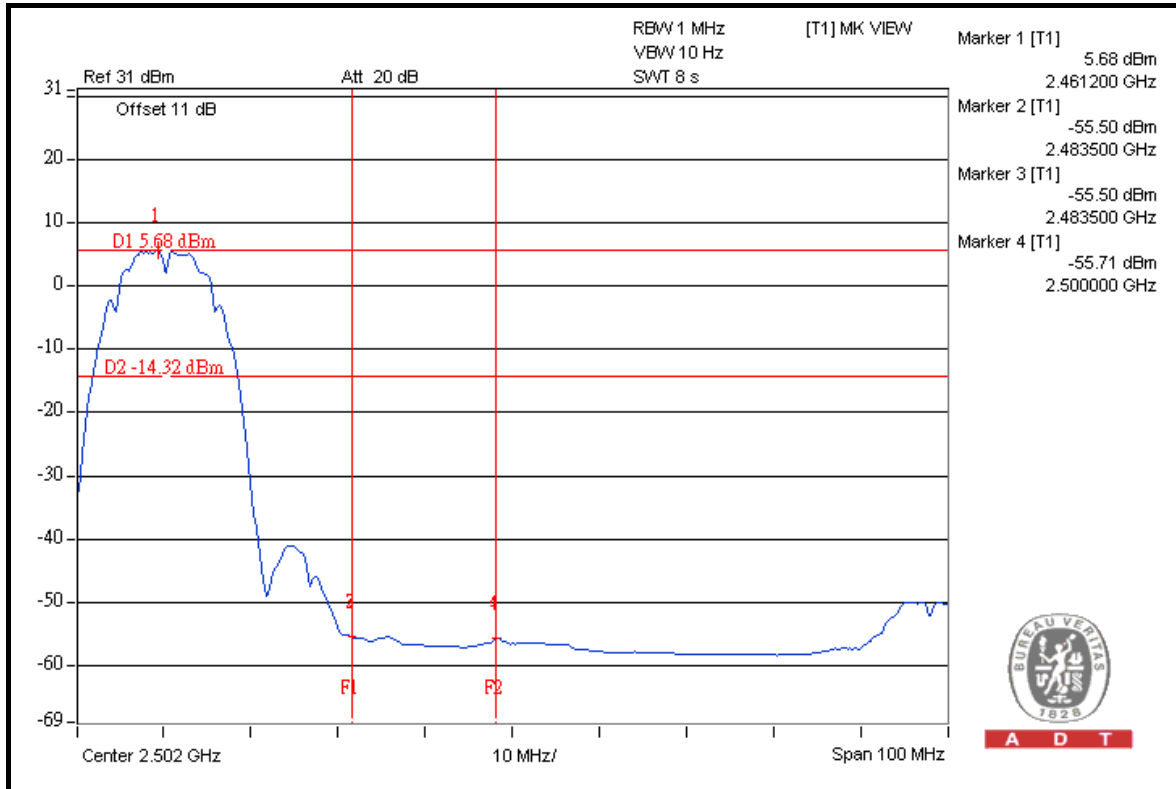



A D T

802.11g

RESTRICT BAND (2310 ~ 2390 MHz)

FREQUENCY (MHz)	FUNDAMENTAL EMISSION (dBuV/m)	DELTA (dB)	MAXIMUM FIELD STRENGTH IN RESTRICT BAND (dBuV/m)	LIMIT (dBuV/m)
2412.00 (PK)	110.60	43.78	66.82	74.00
2412.00 (AV)	98.70	45.91	52.79	54.00

RESTRICT BAND (2483.5 ~ 2500 MHz)

FREQUENCY (MHz)	FUNDAMENTAL EMISSION (dBuV/m)	DELTA (dB)	MAXIMUM FIELD STRENGTH IN RESTRICT BAND (dBuV/m)	LIMIT (dBuV/m)
2462.00 (PK)	109.50	41.67	67.83	74.00
2462.00 (AV)	97.00	45.33	51.67	54.00

NOTE:

1. Delta = Amplitude between the peak of the fundamental and the peak of the band edge emission. Please check following 3 pages.
2. Maximum field strength in restrict band = Fundamental emission – Delta.



A D T

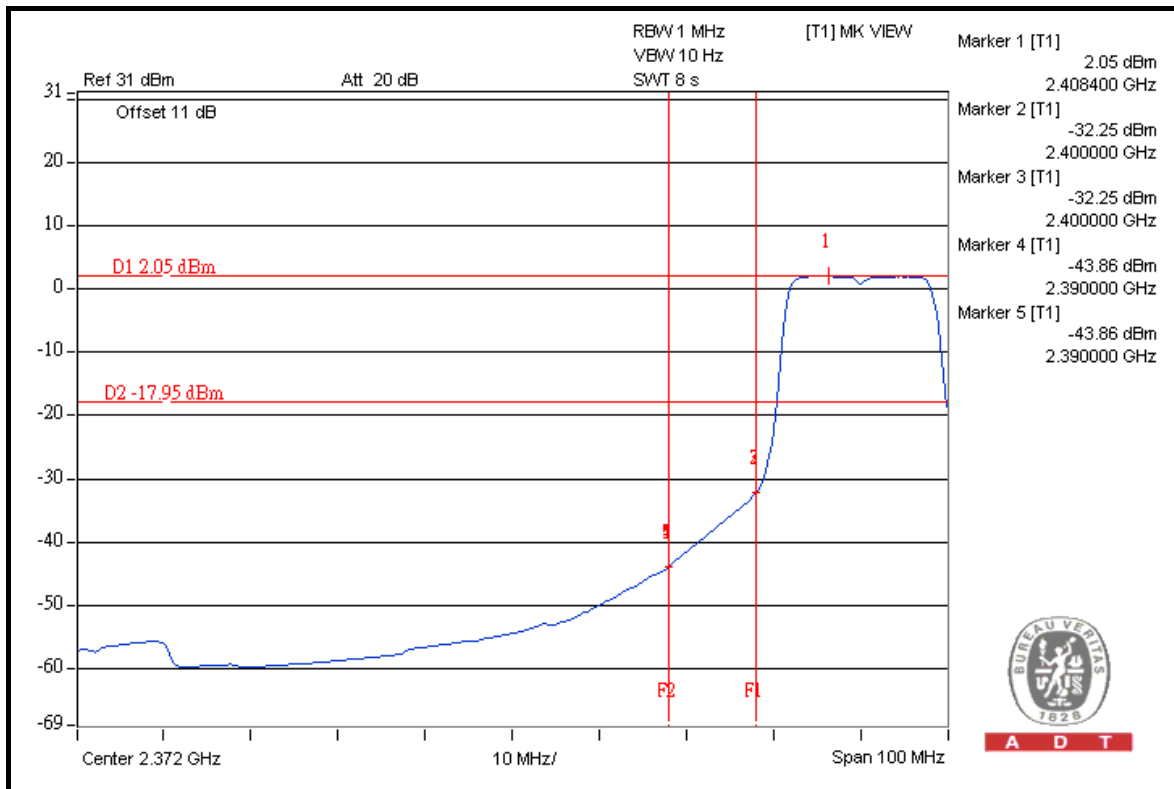
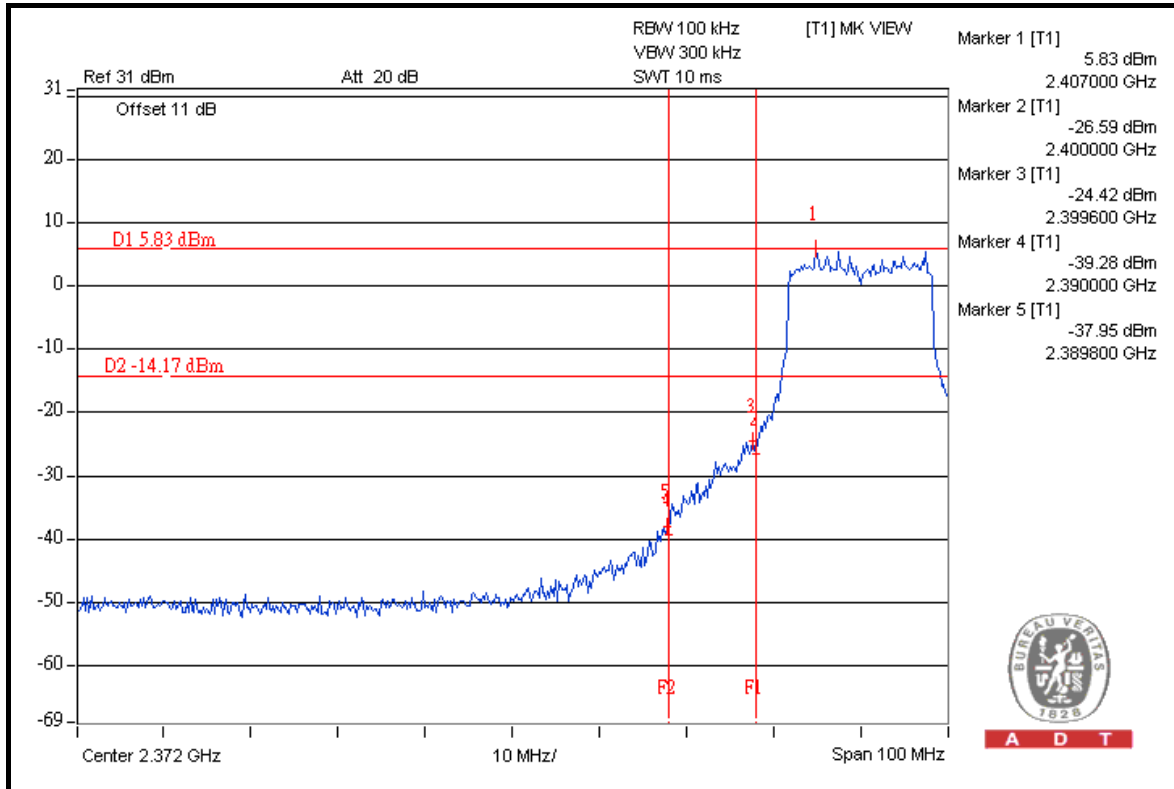



A D T

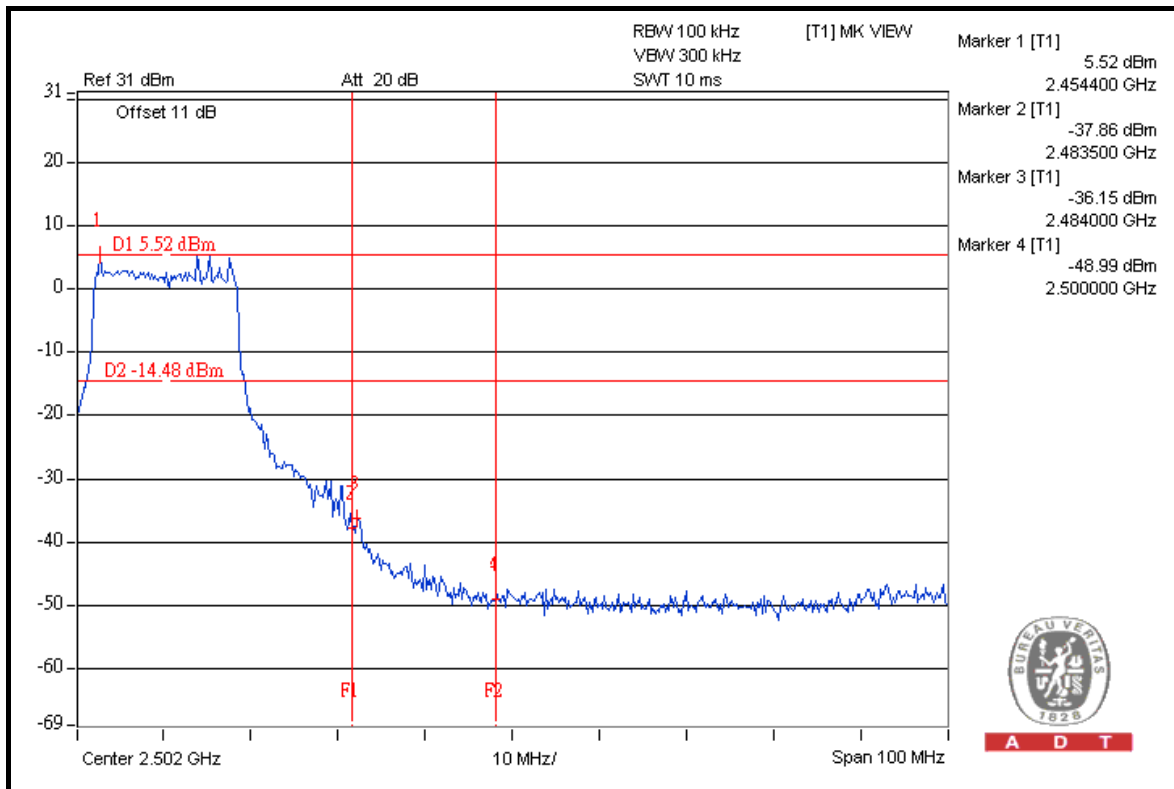
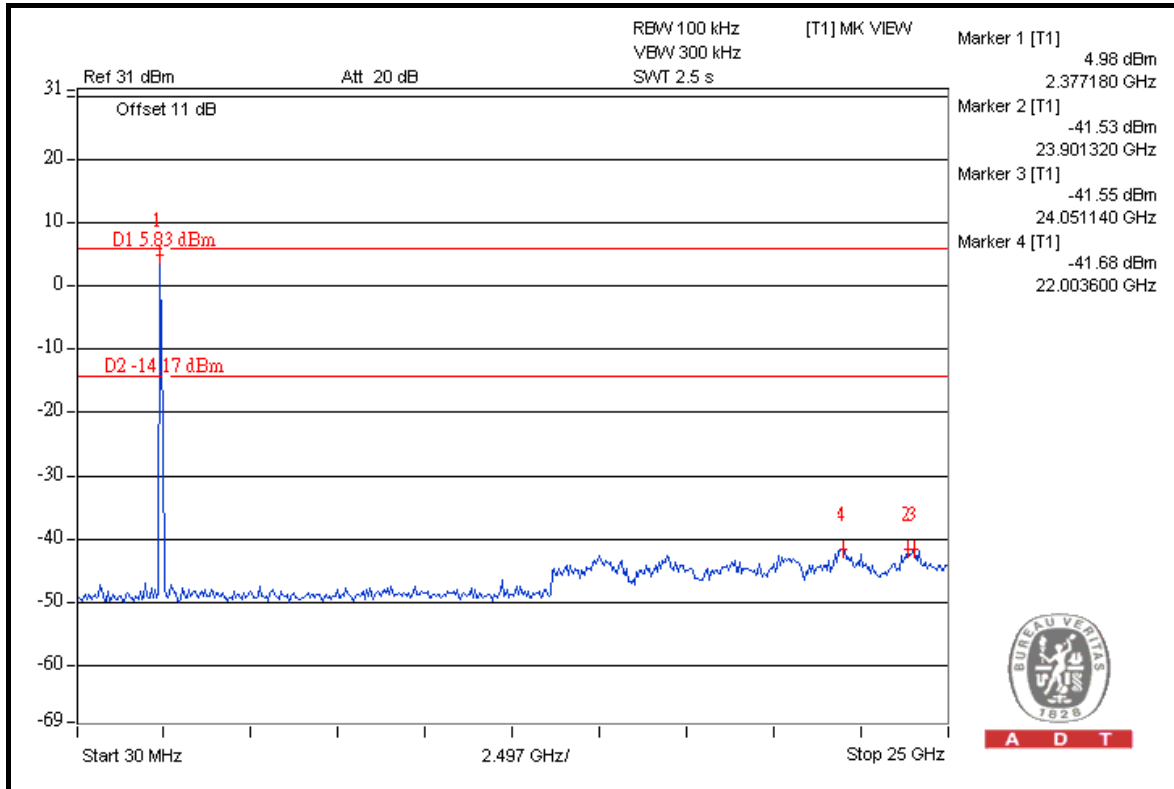



A D T

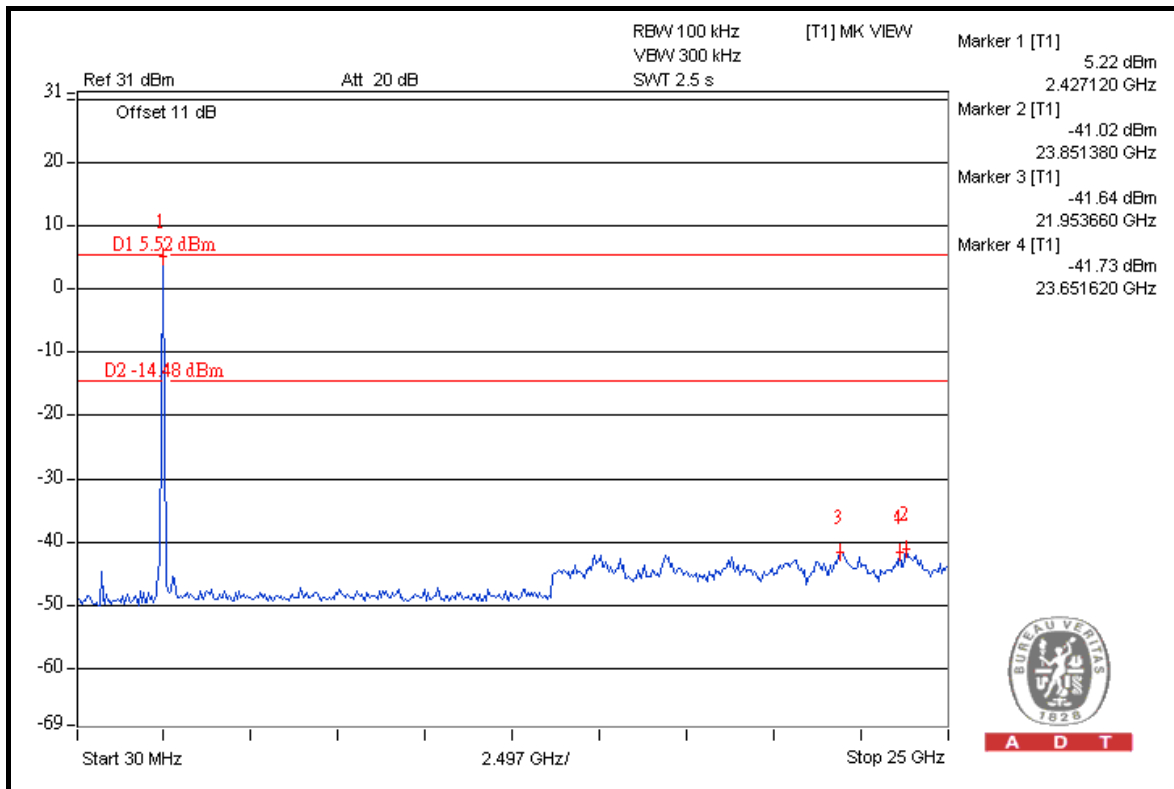
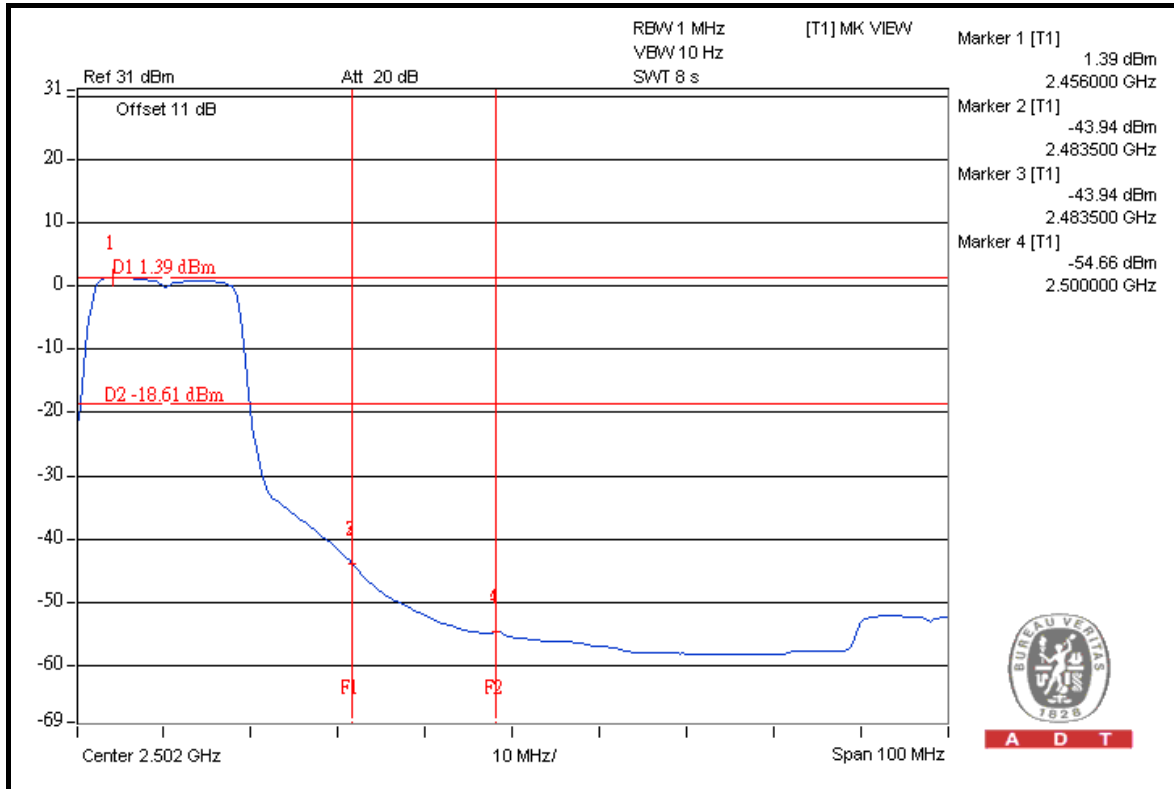



A D T

802.11n (20MHz)

RESTRICT BAND (2310 ~ 2390 MHz)

FREQUENCY (MHz)	FUNDAMENTAL EMISSION (dBuV/m)	DELTA (dB)	MAXIMUM FIELD STRENGTH IN RESTRICT BAND (dBuV/m)	LIMIT (dBuV/m)
2412.00 (PK)	114.40	45.64	68.76	74.00
2412.00 (AV)	100.90	47.51	53.39	54.00

RESTRICT BAND (2483.5 ~ 2500 MHz)

FREQUENCY (MHz)	FUNDAMENTAL EMISSION (dBuV/m)	DELTA (dB)	MAXIMUM FIELD STRENGTH IN RESTRICT BAND (dBuV/m)	LIMIT (dBuV/m)
2462.00 (PK)	113.80	47.98	65.82	74.00
2462.00 (AV)	99.00	47.40	51.60	54.00

NOTE:

1. Delta = Amplitude between the peak of the fundamental and the peak of the band edge emission. Please check following 3 pages.
2. Maximum field strength in restrict band = Fundamental emission – Delta.



A D T

FOR RADIATED MEASURED (THREE CHAINS ON)

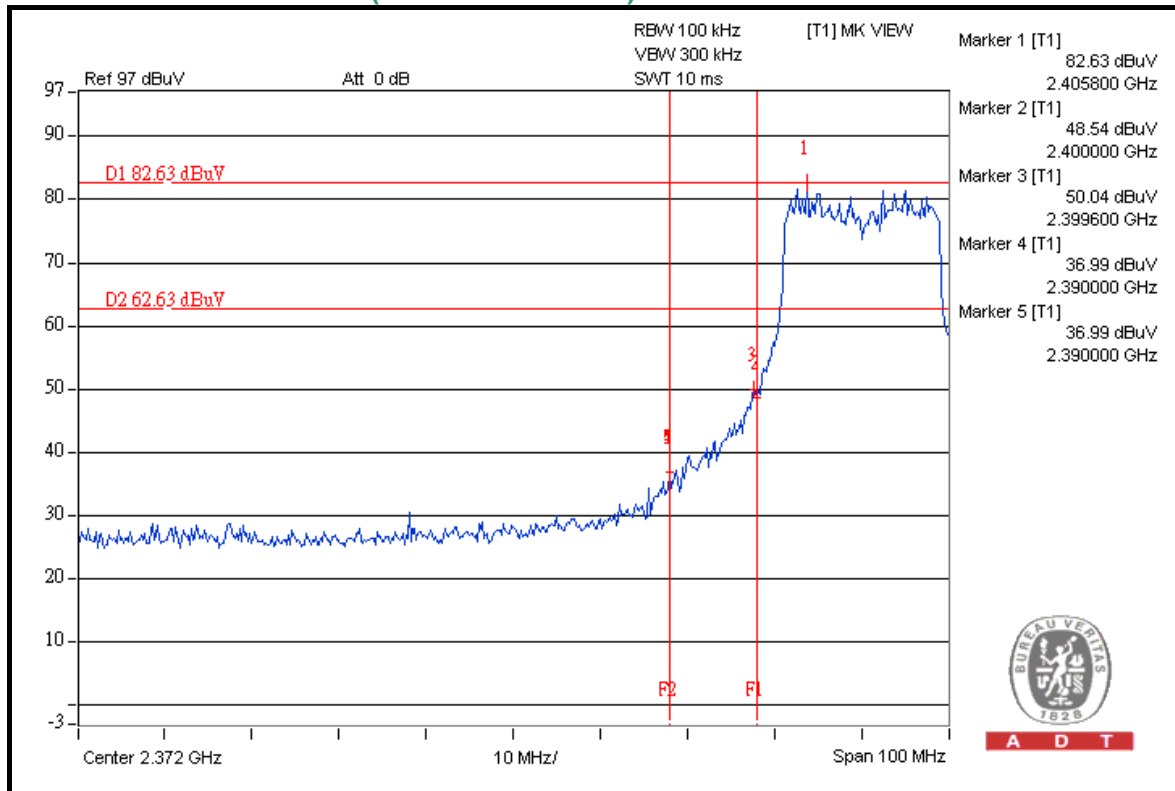

A D T

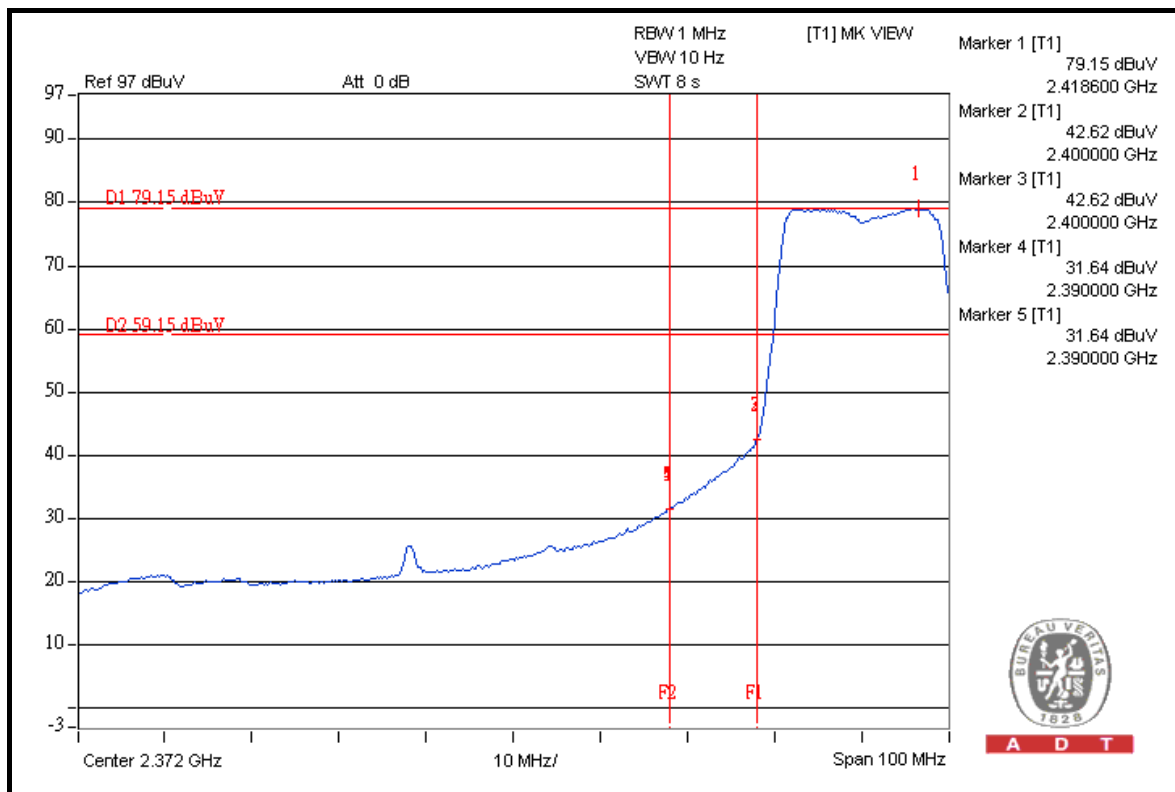

A D T



A D T

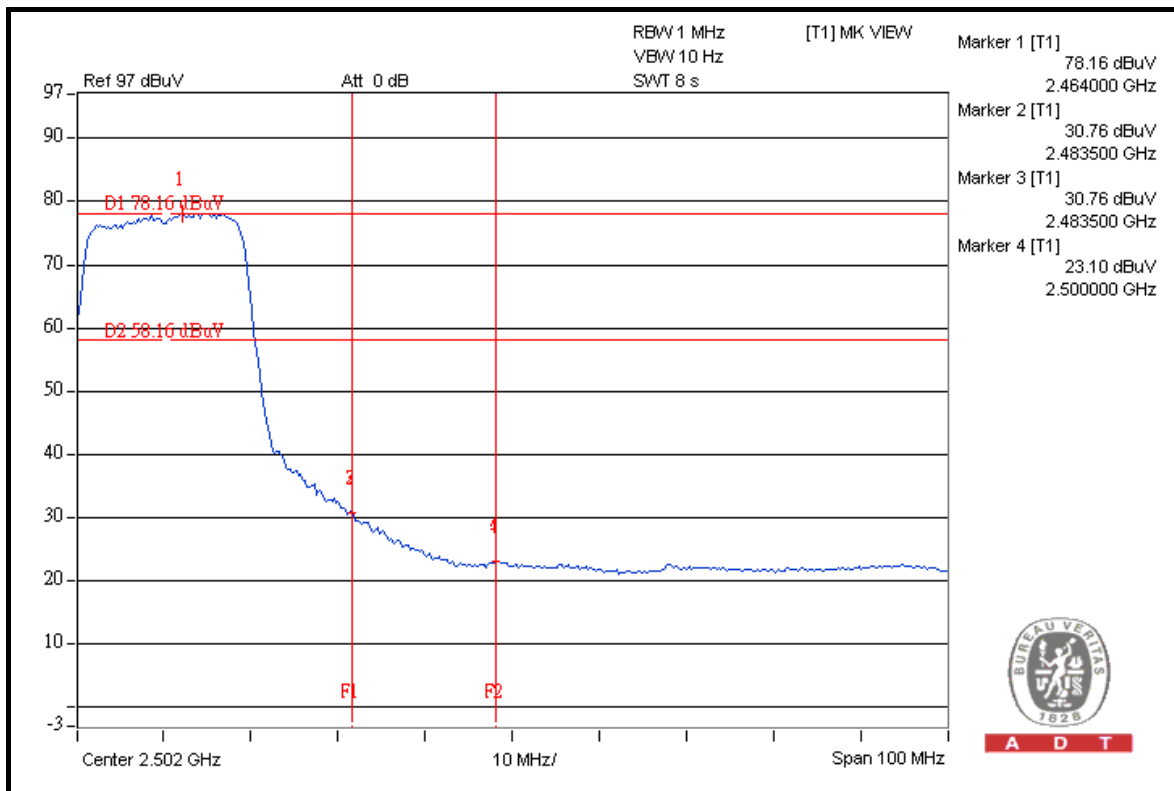
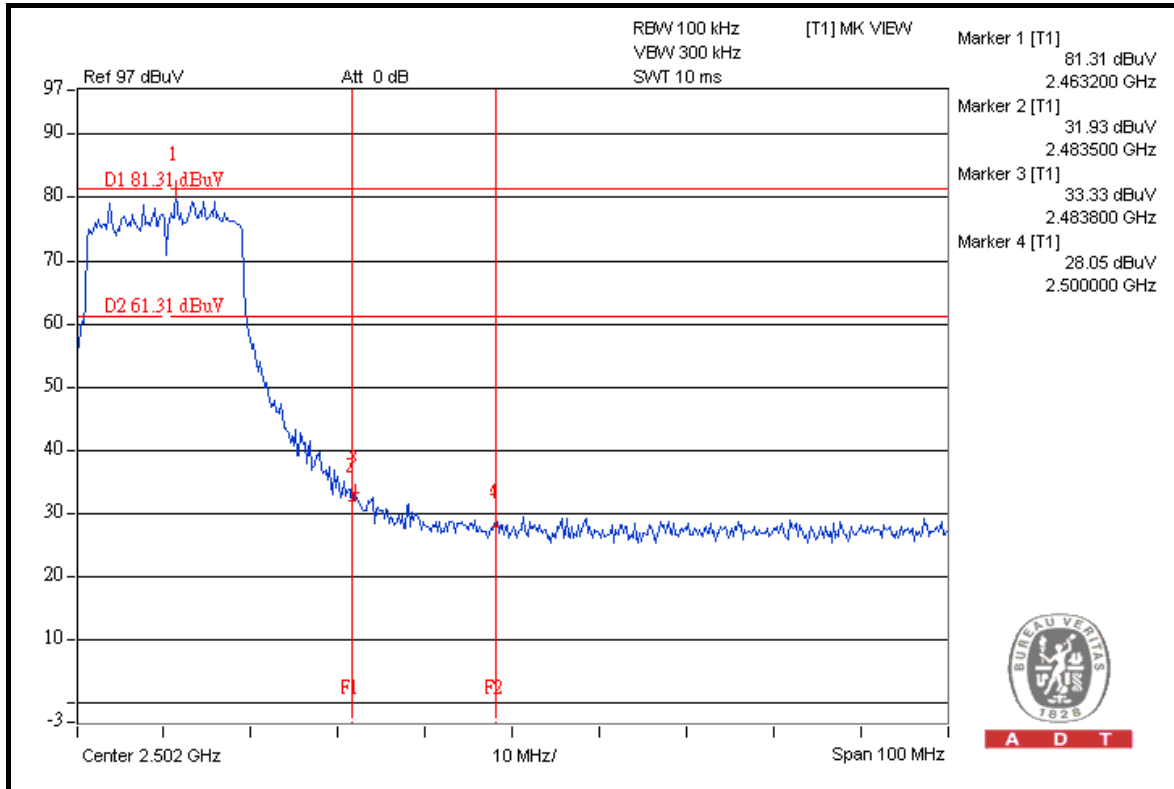



A D T

FOR CONDUCTED MEASURED

CHAIN 0

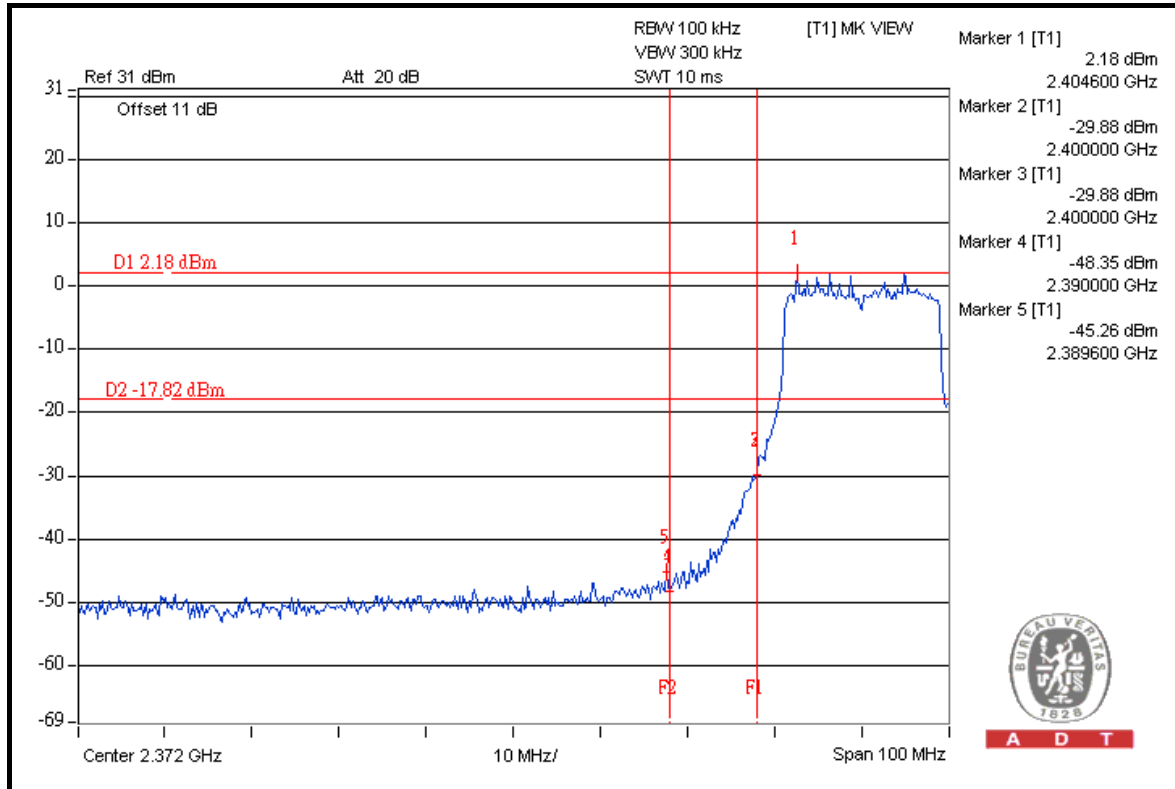

A D T

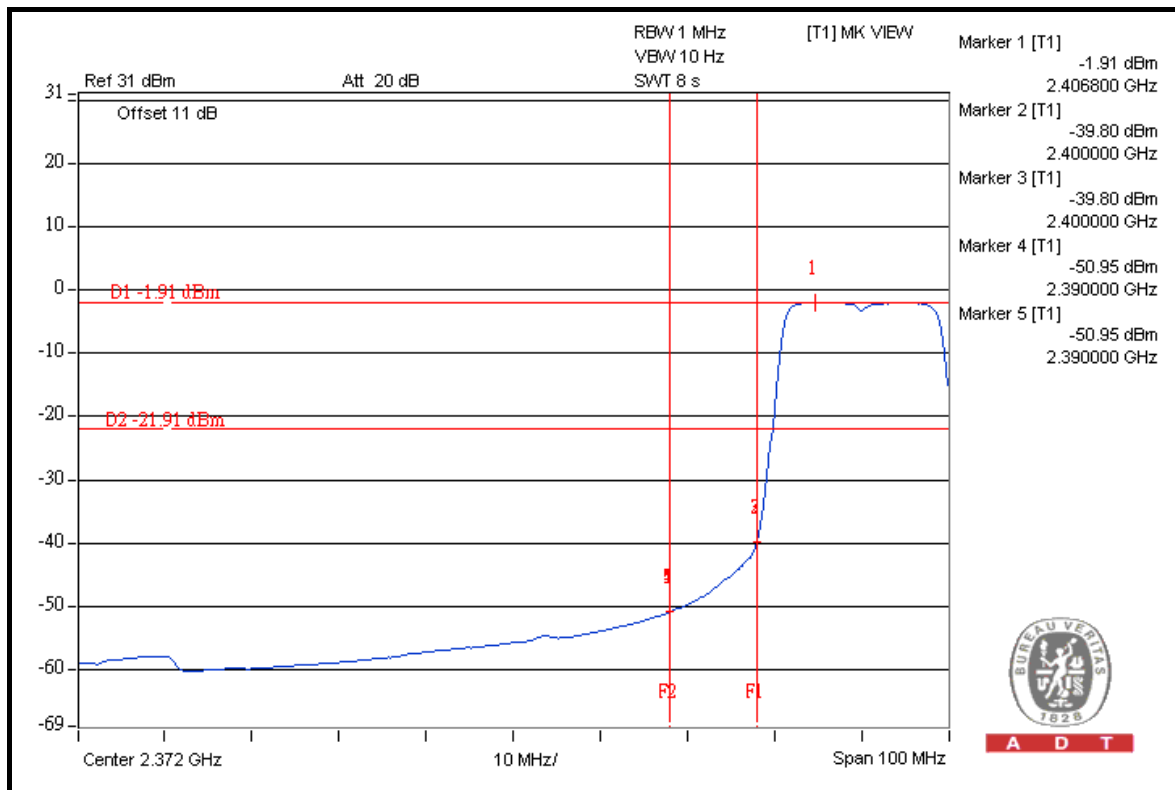

A D T



A D T

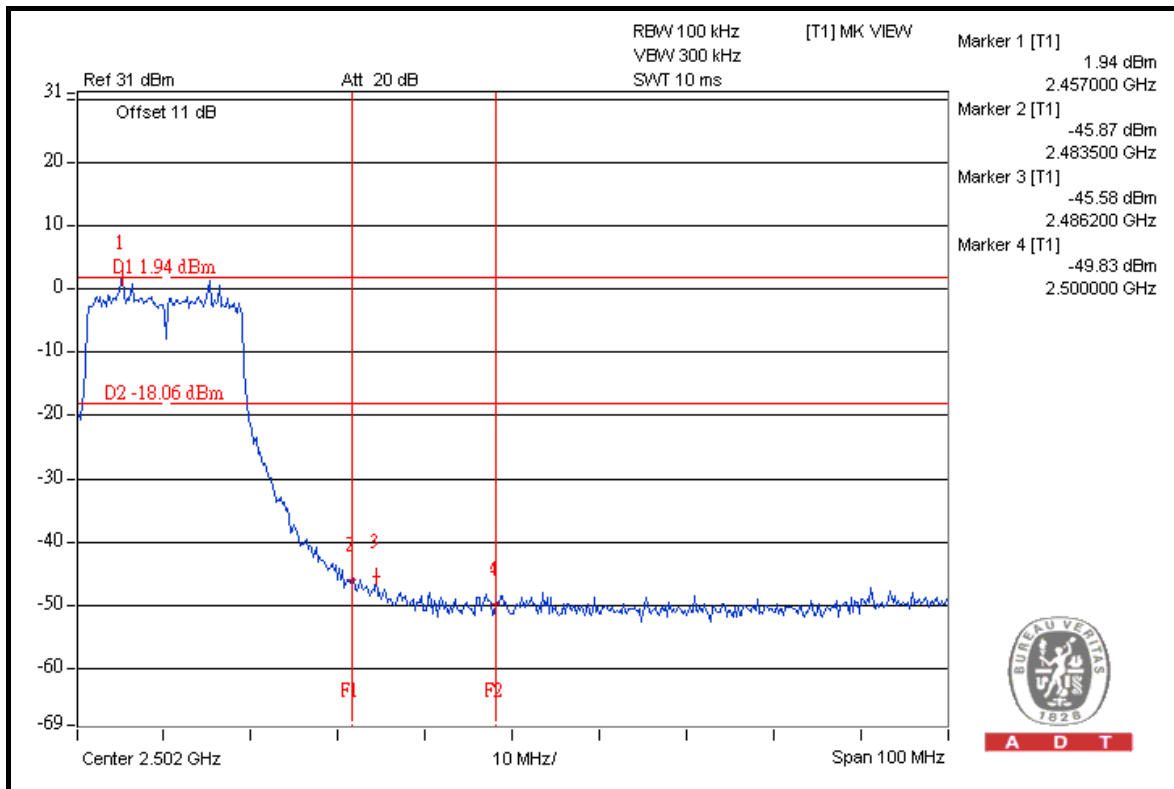
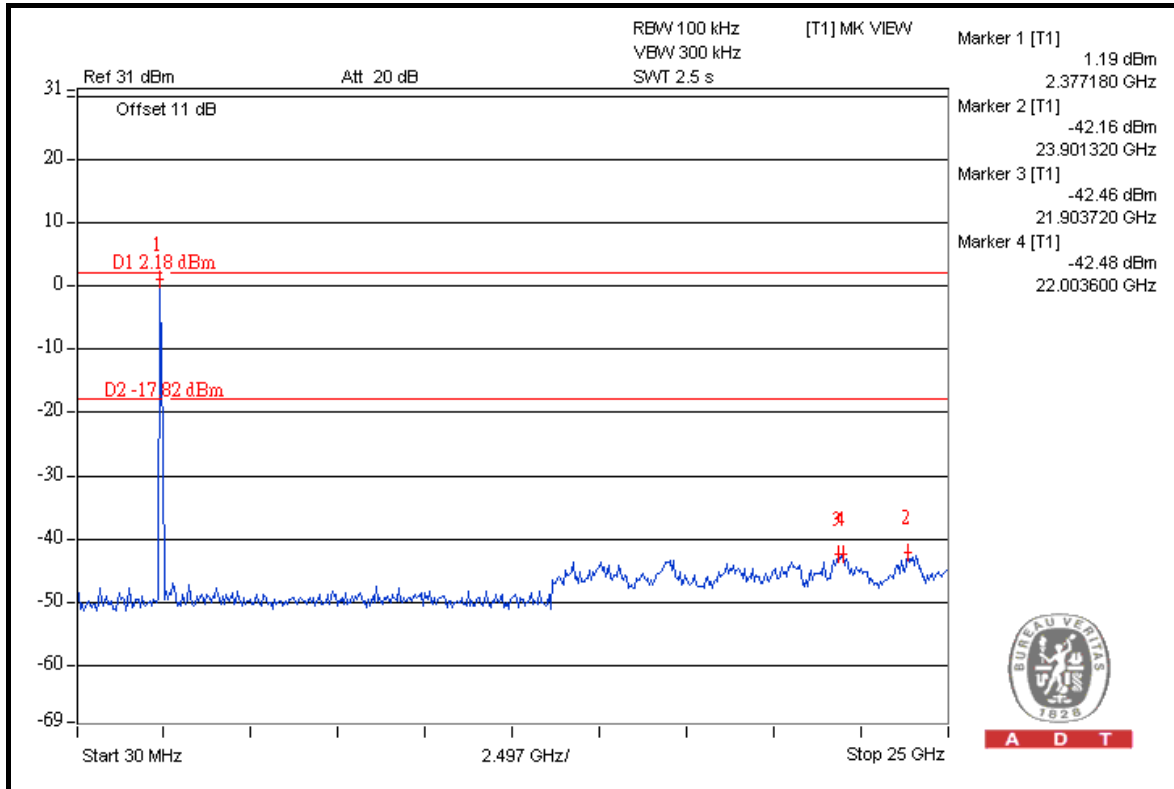



A D T

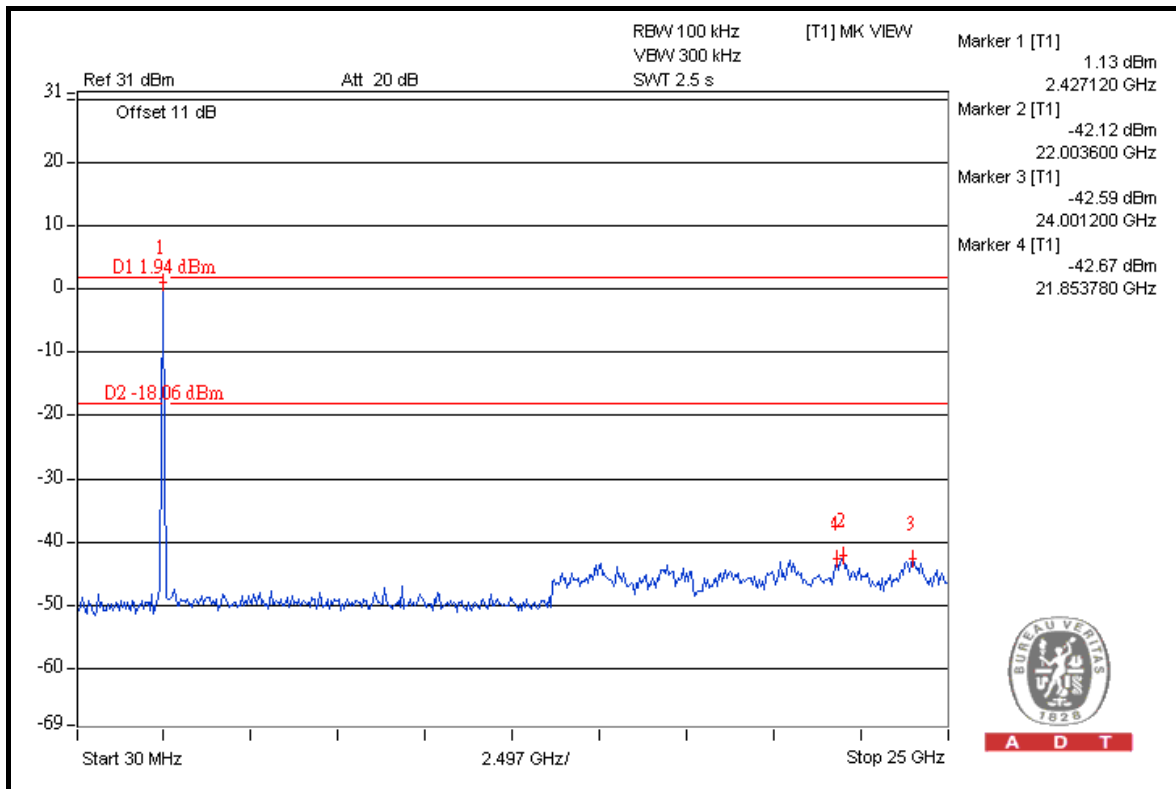
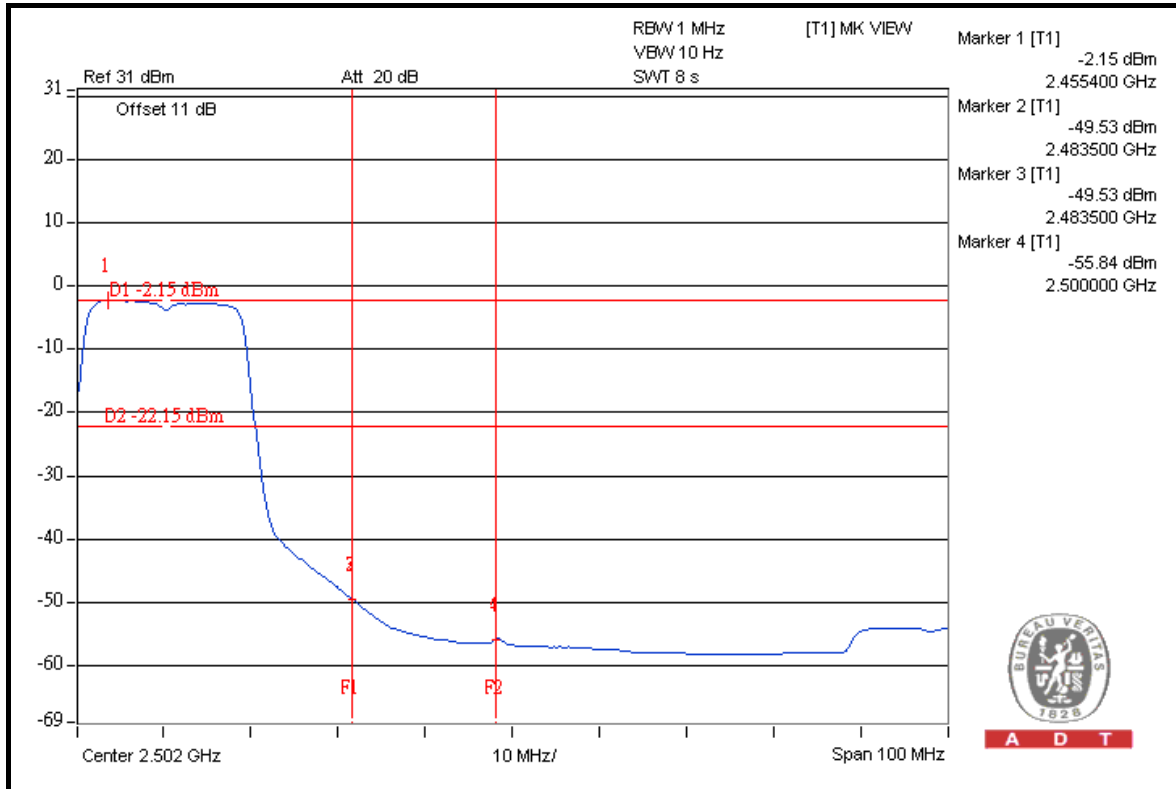



A D T

CHAIN 1

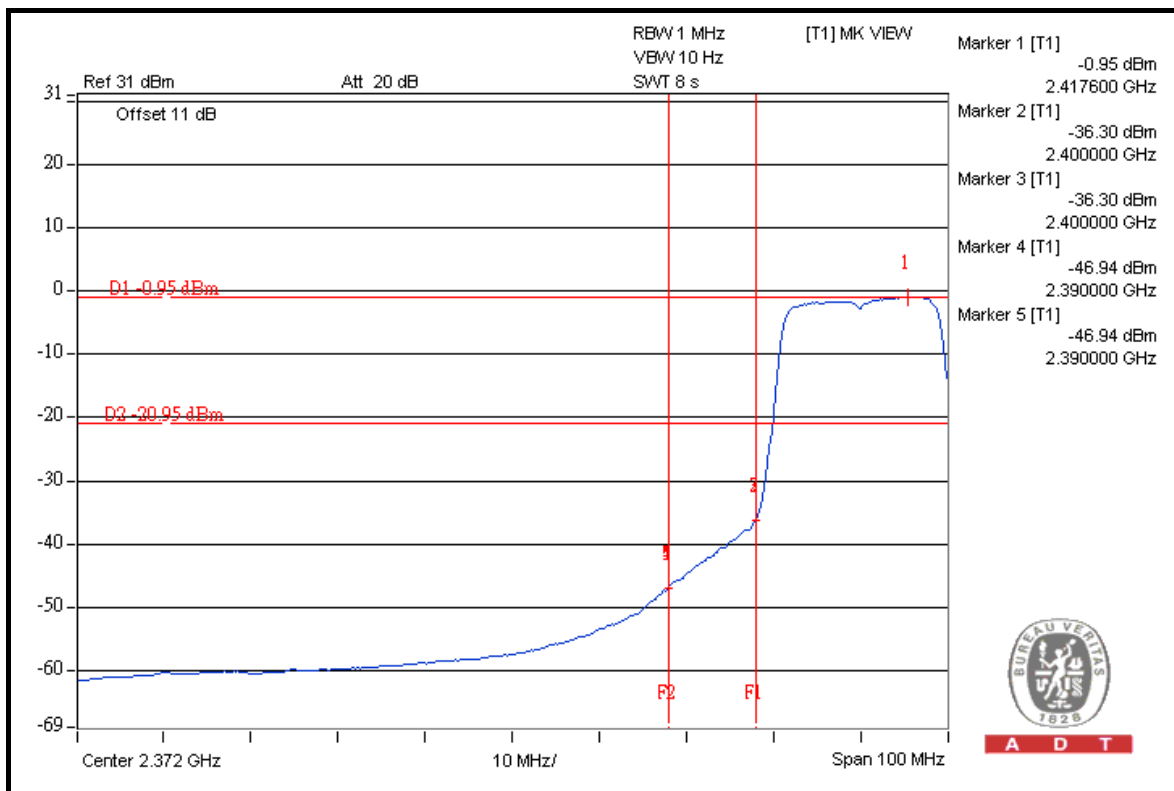
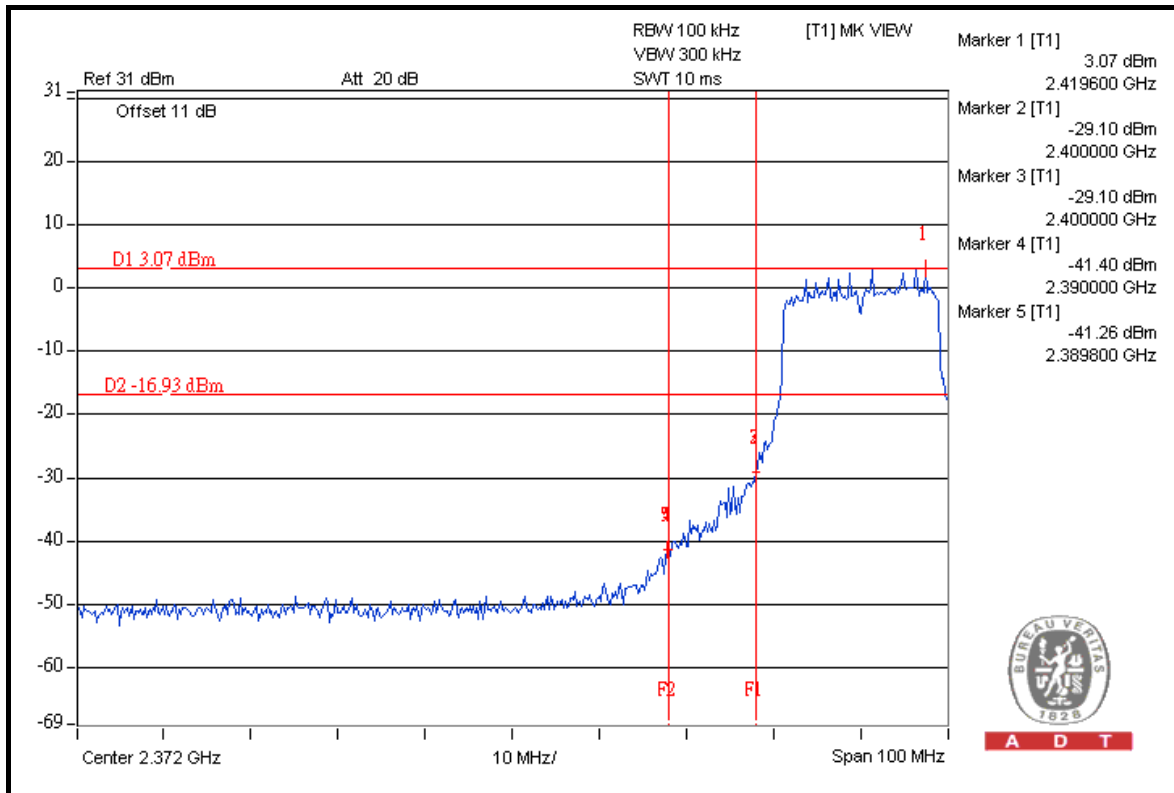



A D T

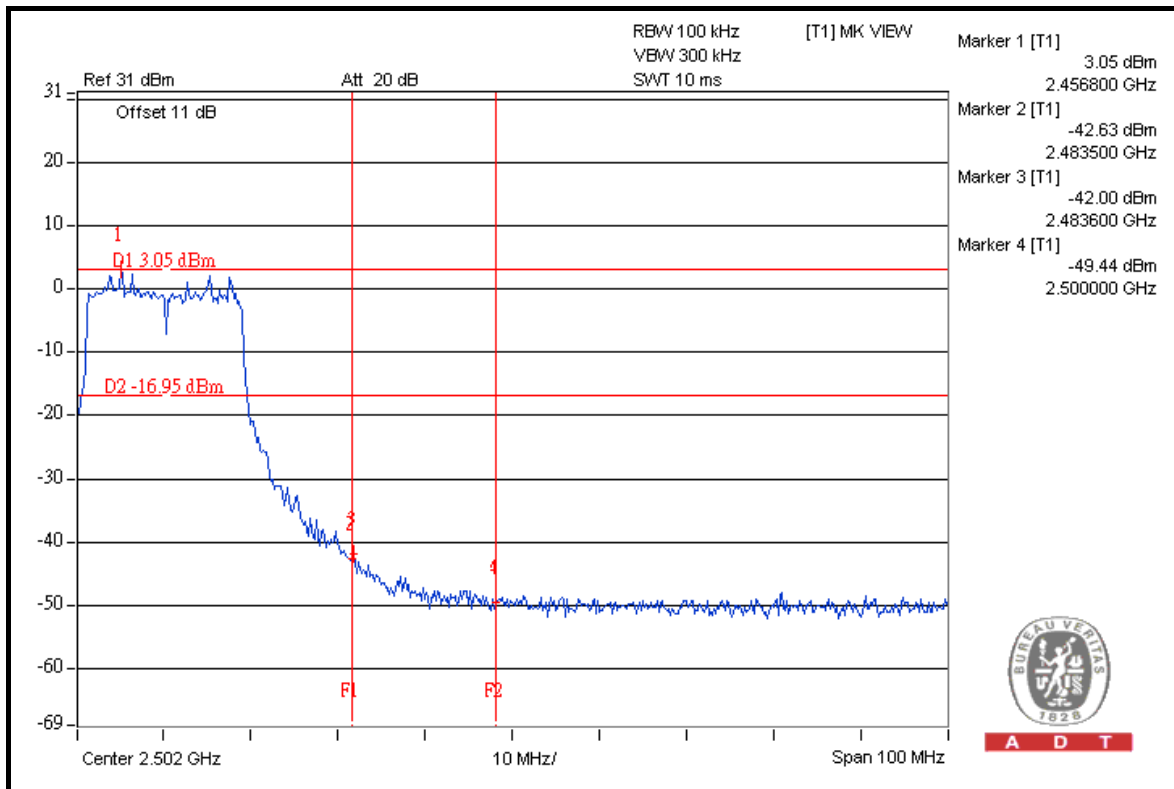
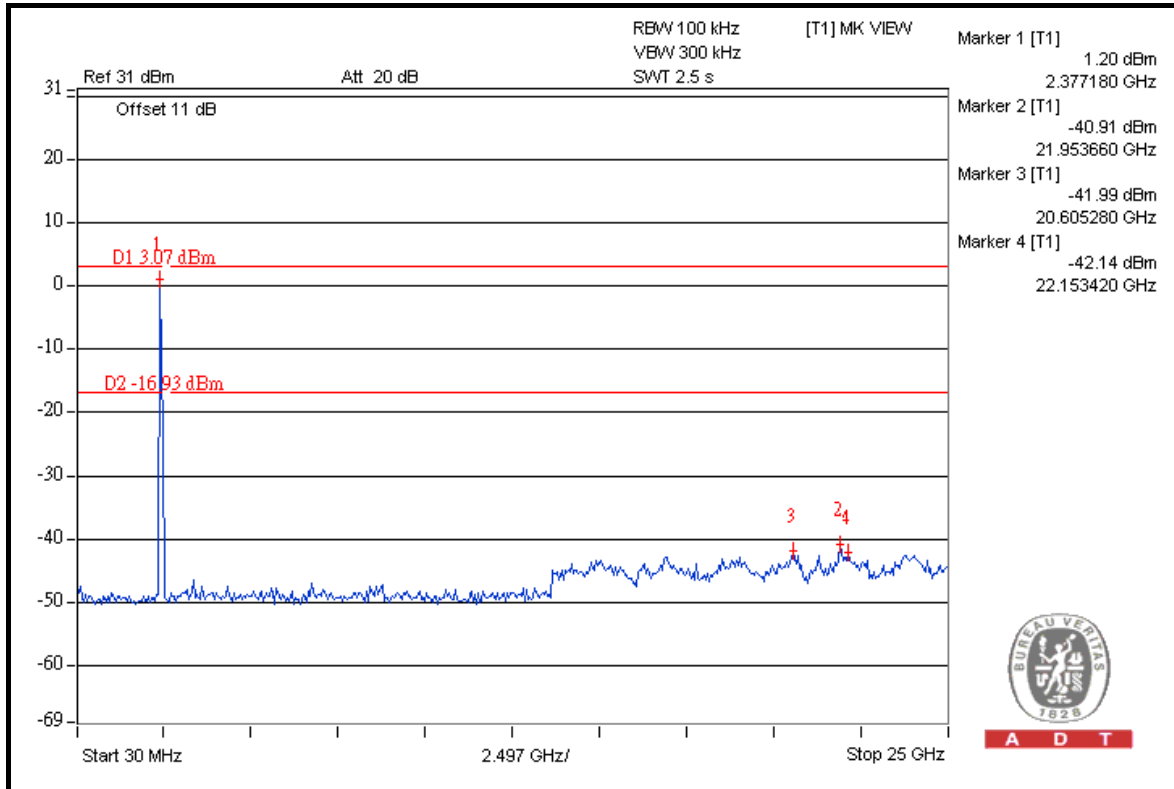



A D T

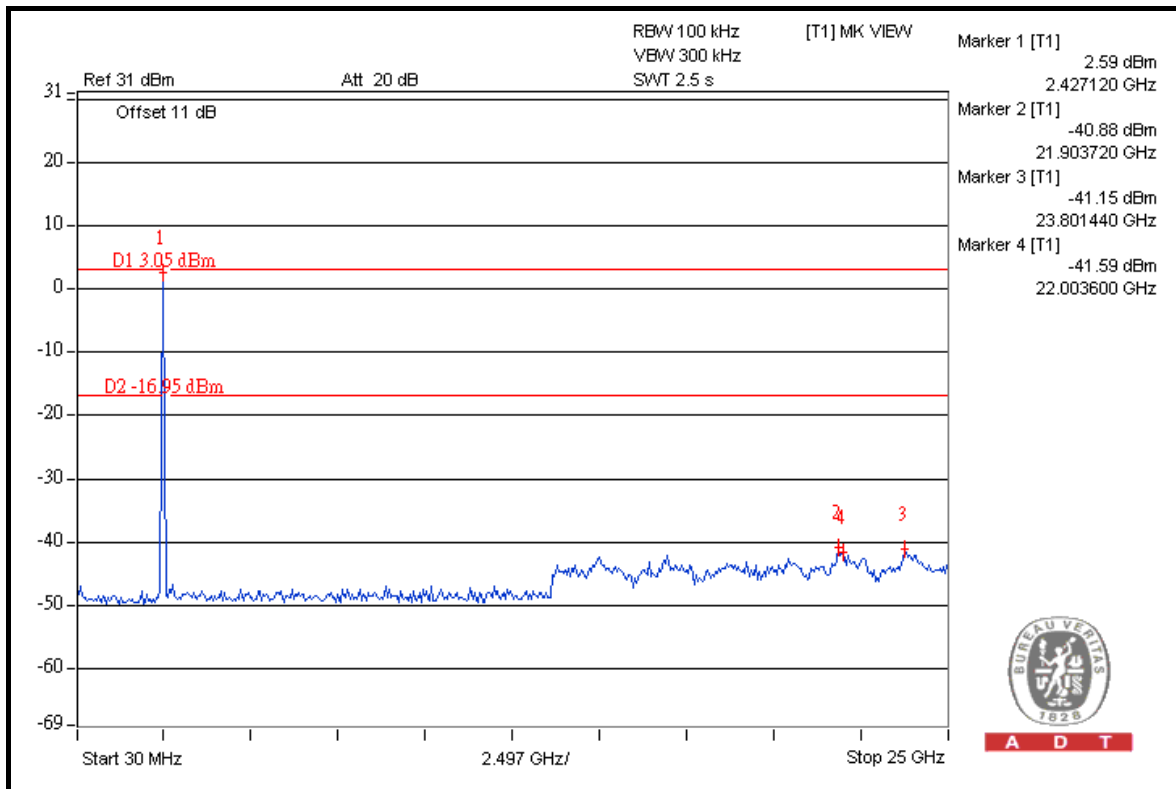
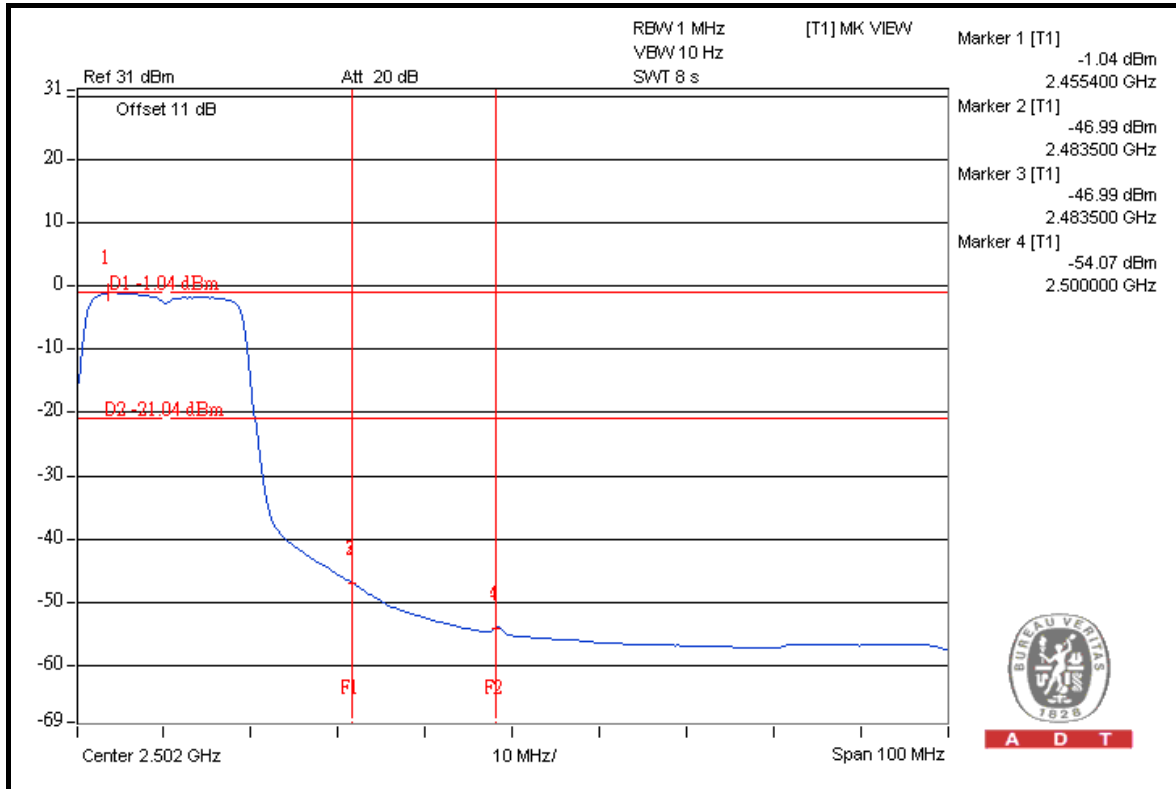



A D T

CHAIN 2

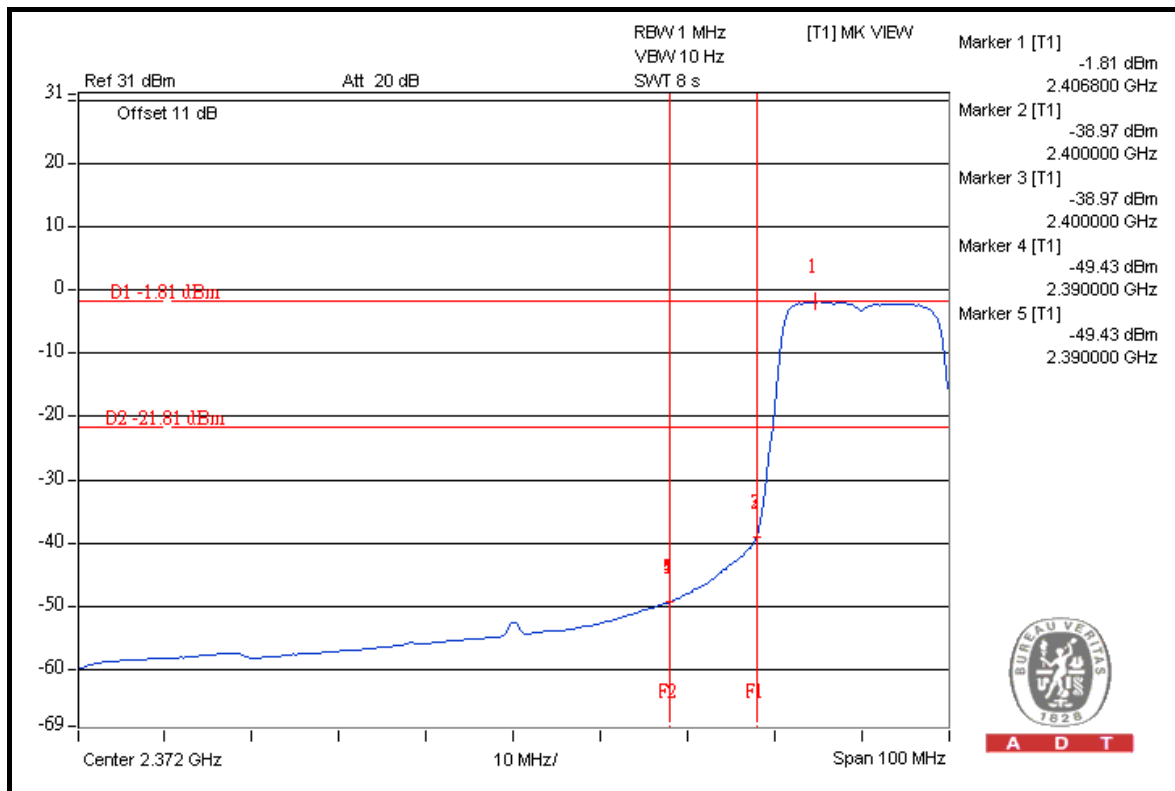
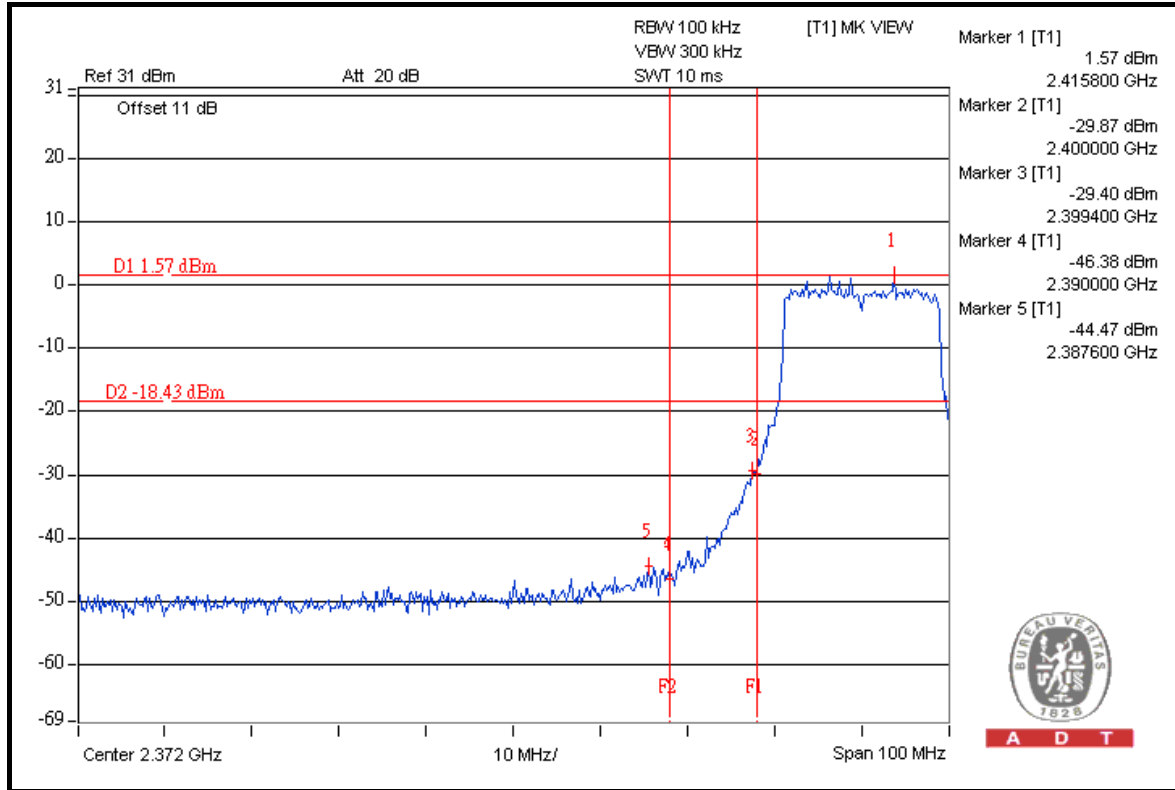



A D T

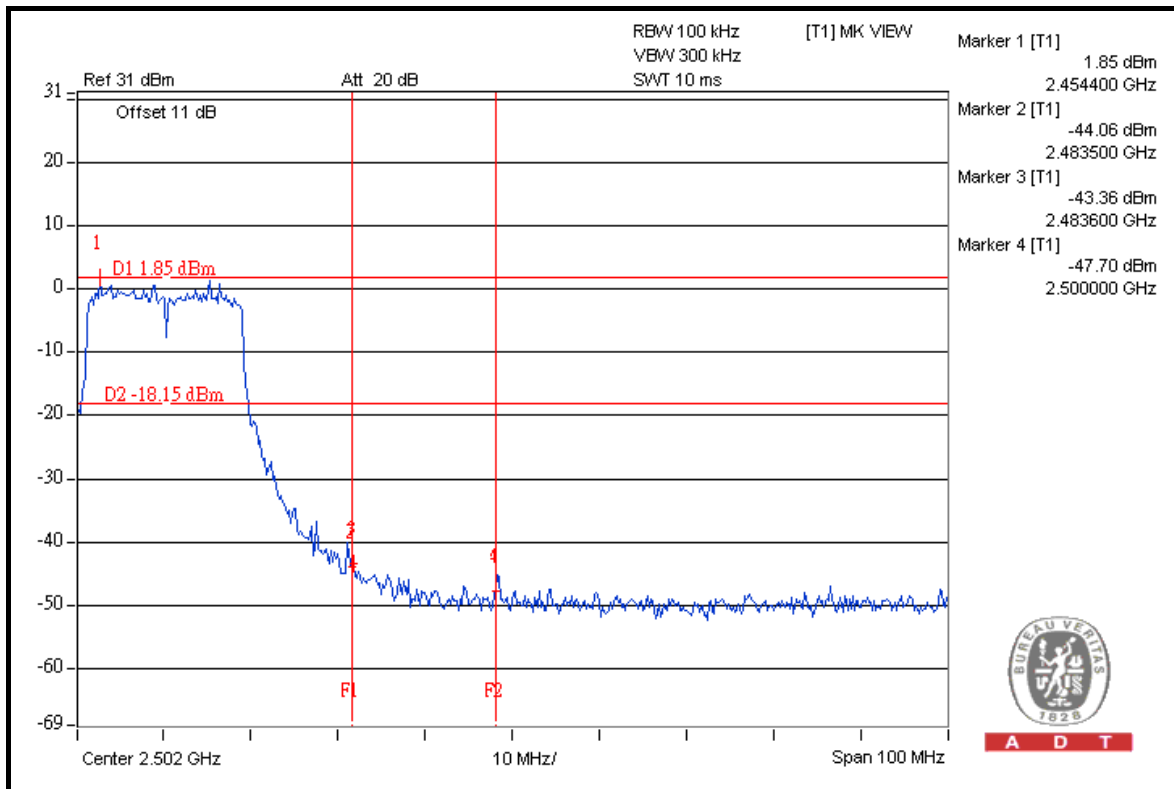
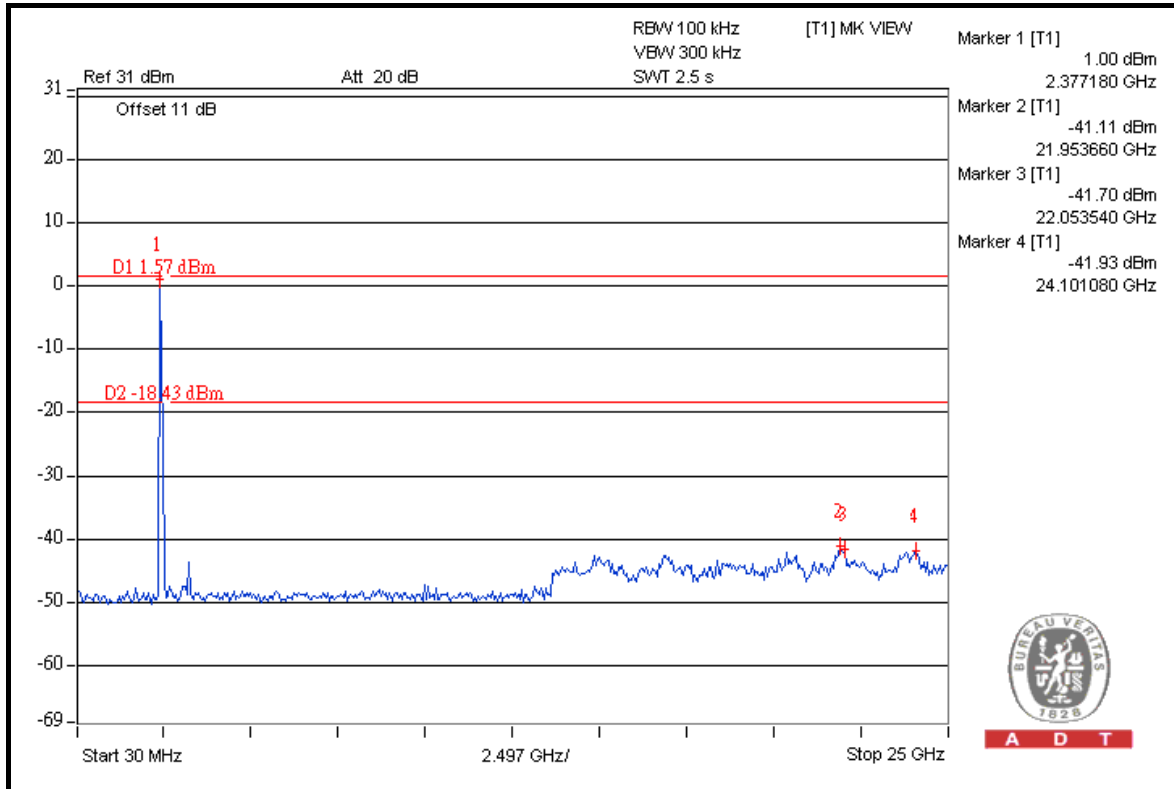



A D T

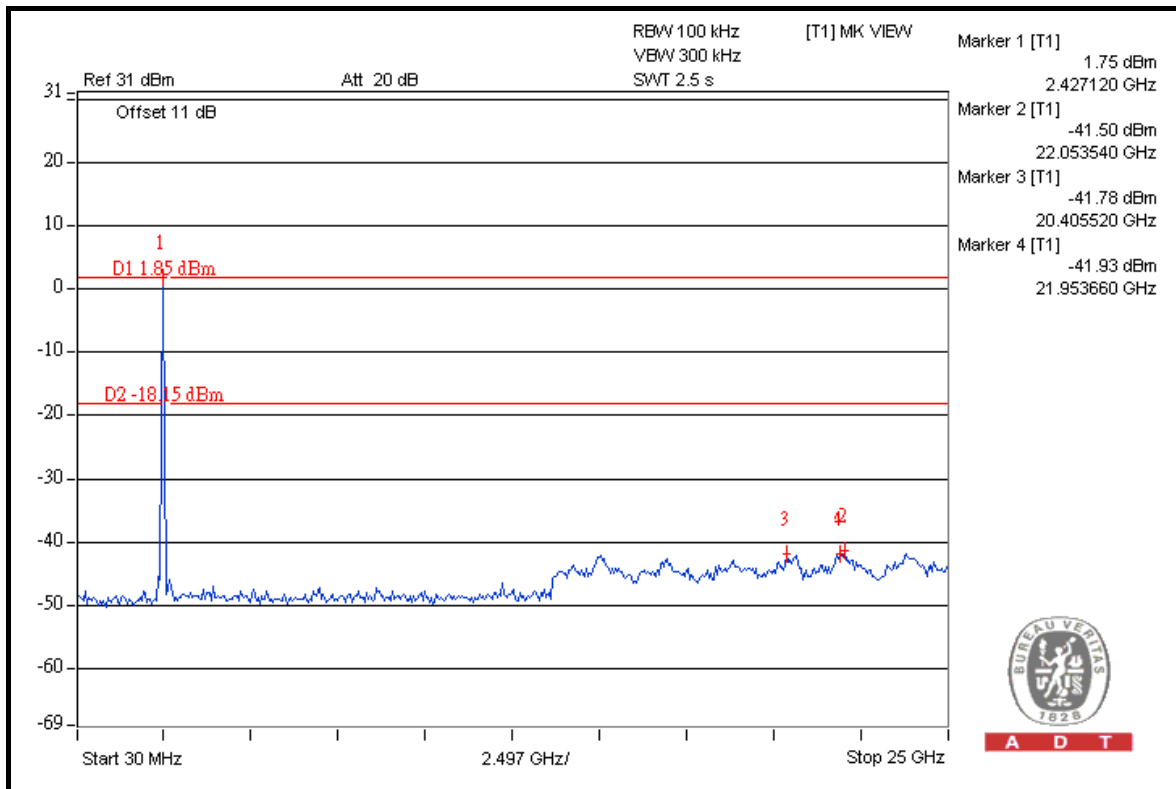
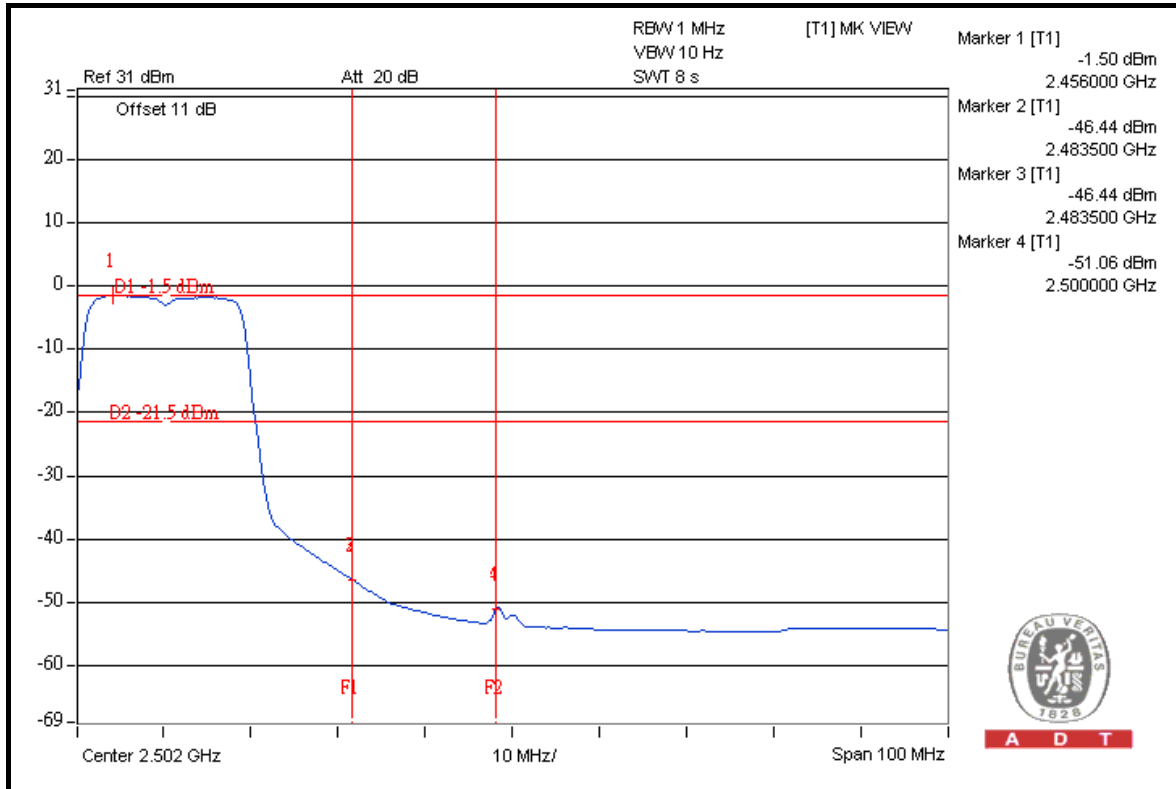



A D T

802.11n (40MHz)

RESTRICT BAND (2310 ~ 2390 MHz)

FREQUENCY (MHz)	FUNDAMENTAL EMISSION (dBuV/m)	DELTA (dB)	MAXIMUM FIELD STRENGTH IN RESTRICT BAND (dBuV/m)	LIMIT (dBuV/m)
2422.00 (PK)	109.20	42.58	66.62	74.00
2422.00 (AV)	95.00	43.66	51.34	54.00

RESTRICT BAND (2483.5 ~ 2500 MHz)

FREQUENCY (MHz)	FUNDAMENTAL EMISSION (dBuV/m)	DELTA (dB)	MAXIMUM FIELD STRENGTH IN RESTRICT BAND (dBuV/m)	LIMIT (dBuV/m)
2452.00 (PK)	109.30	42.92	66.38	74.00
2452.00 (AV)	95.40	43.43	51.97	54.00

NOTE:

1. Delta = Amplitude between the peak of the fundamental and the peak of the band edge emission. Please check following 3 pages.
2. Maximum field strength in restrict band = Fundamental emission – Delta.



A D T

FOR RADIATED MEASURED (THREE CHAINS ON)

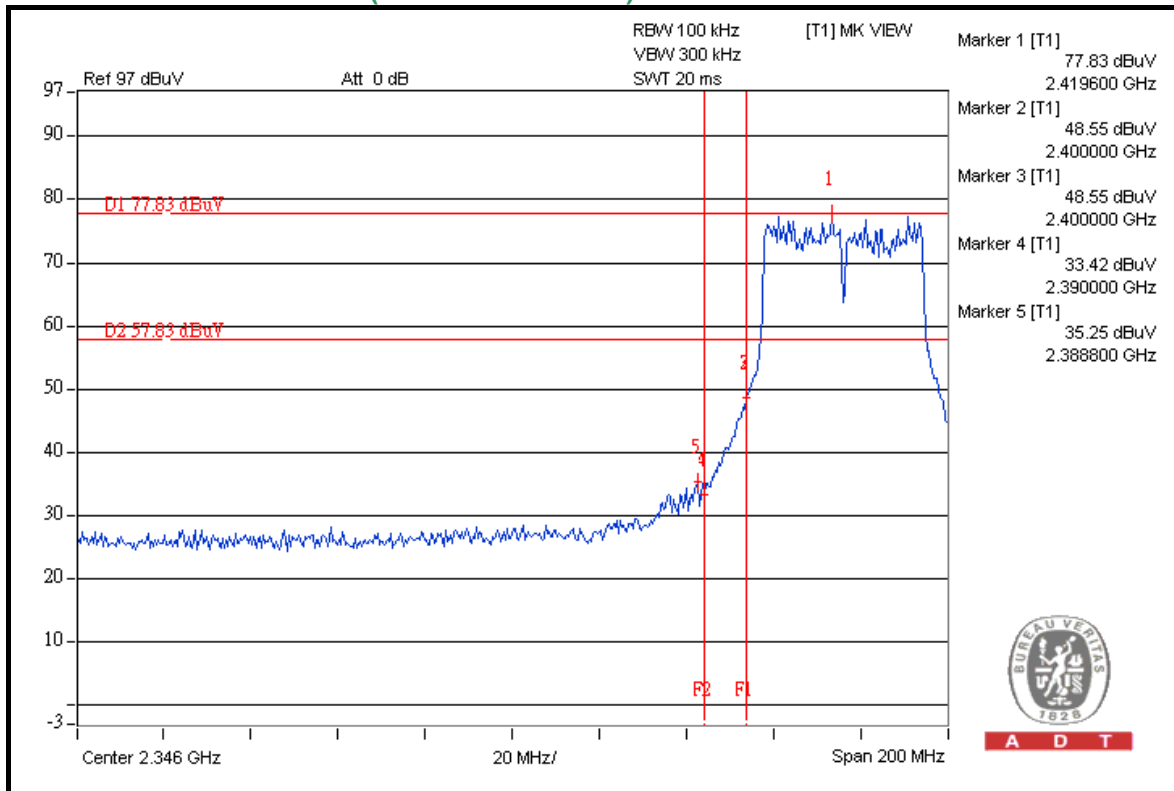

A D T

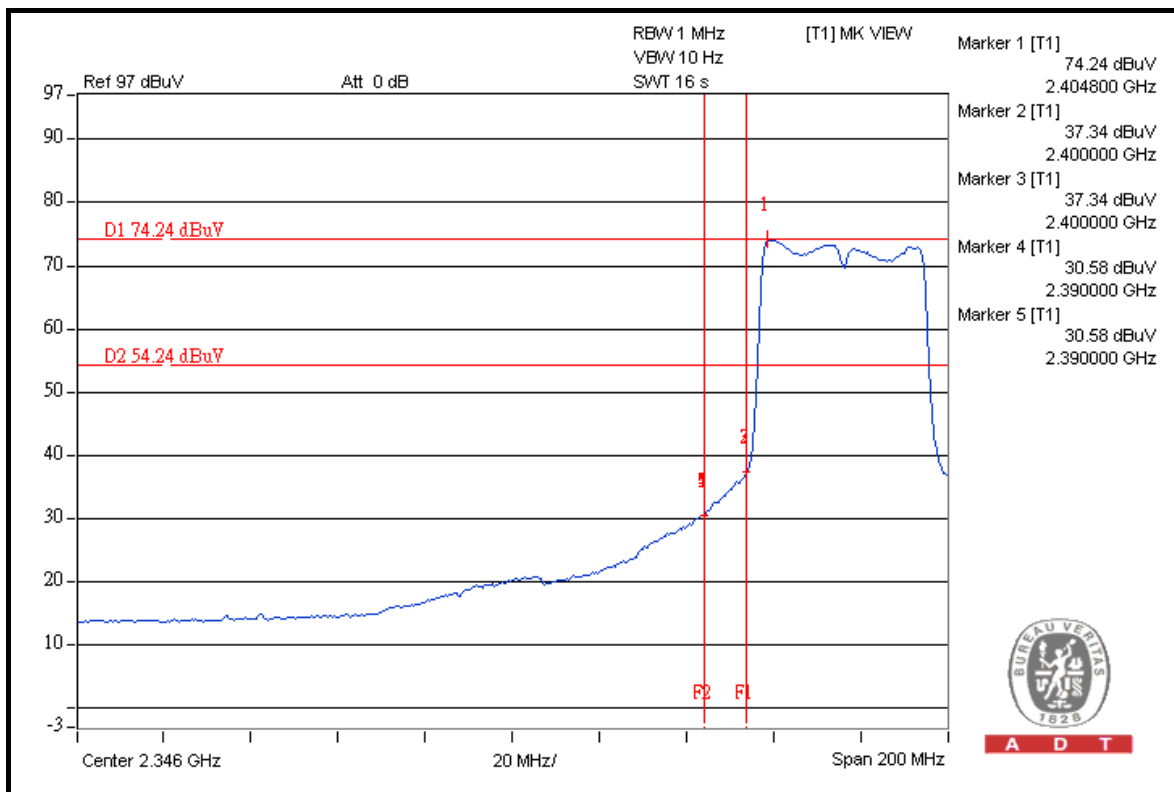

A D T



A D T

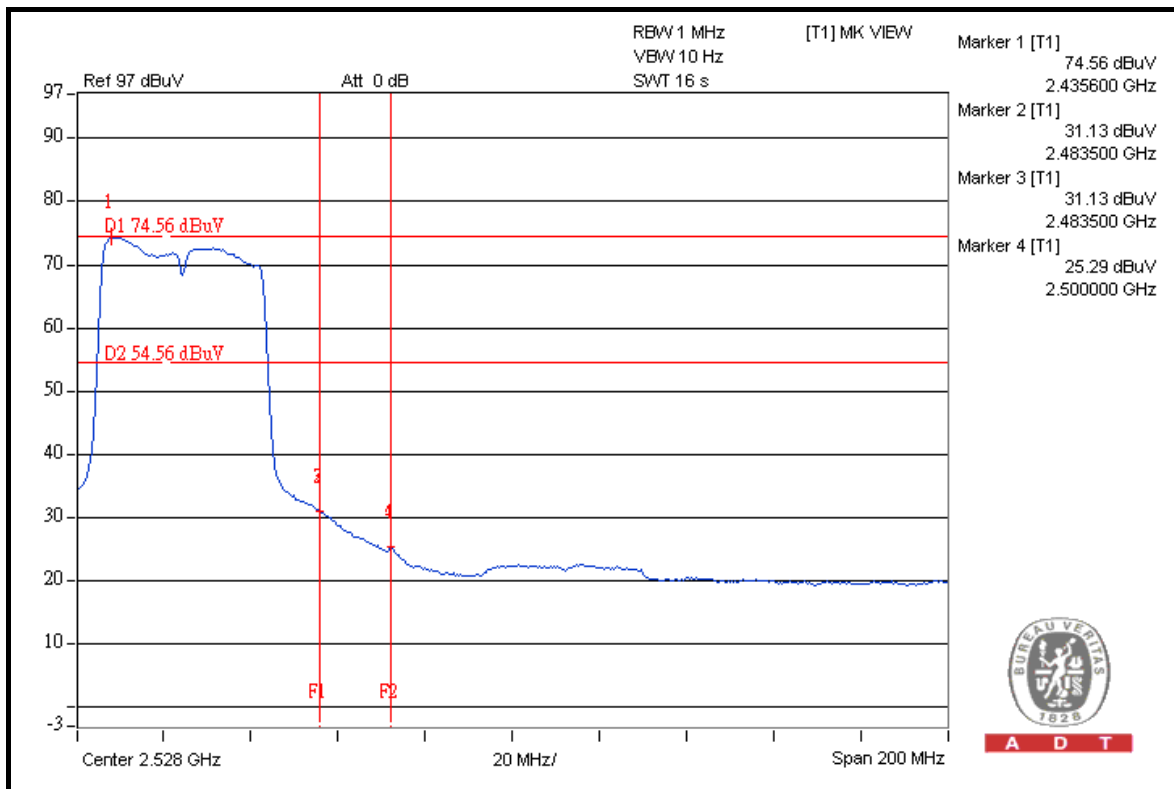
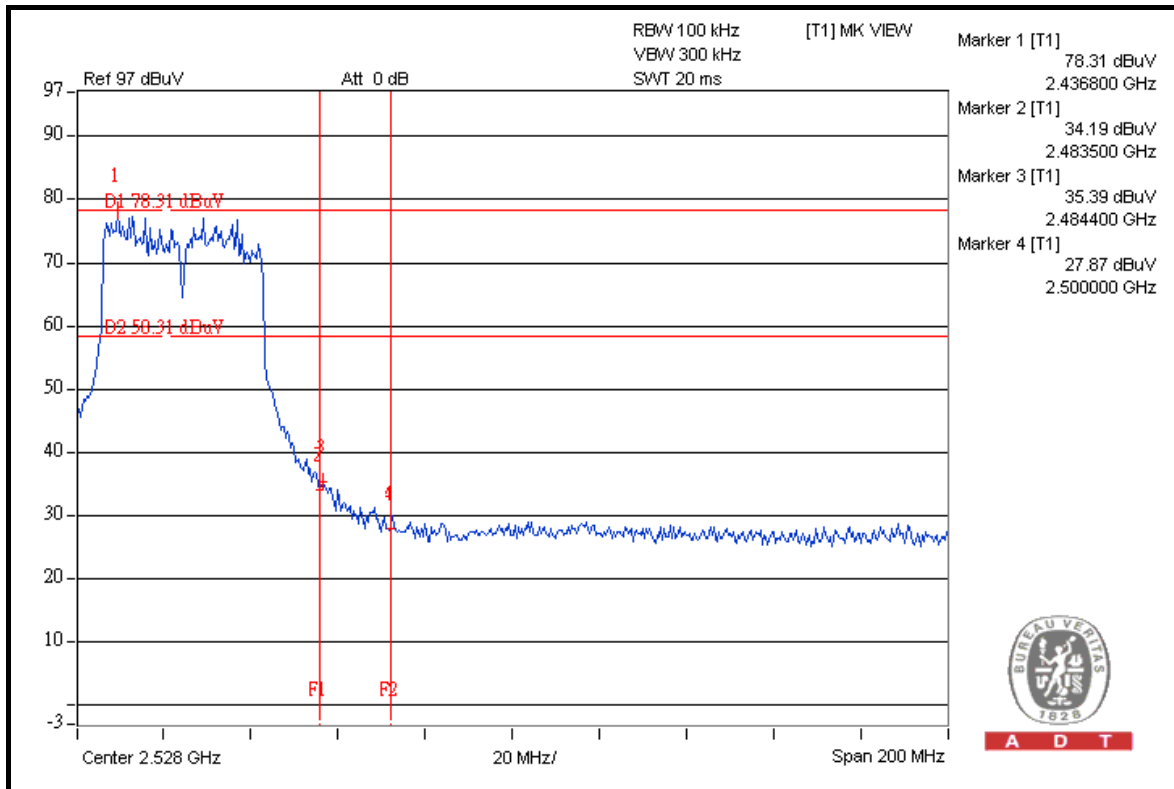



A D T

FOR CONDUCTED MEASURED

CHAIN 0

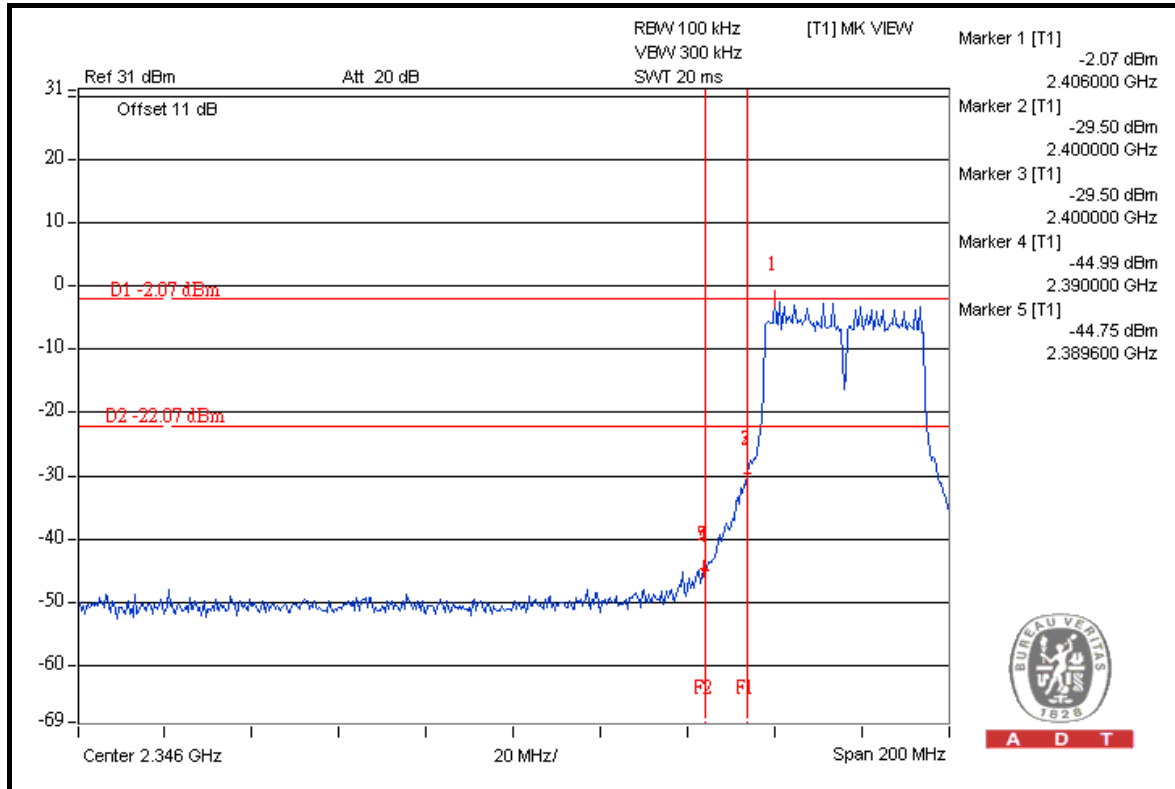

A D T

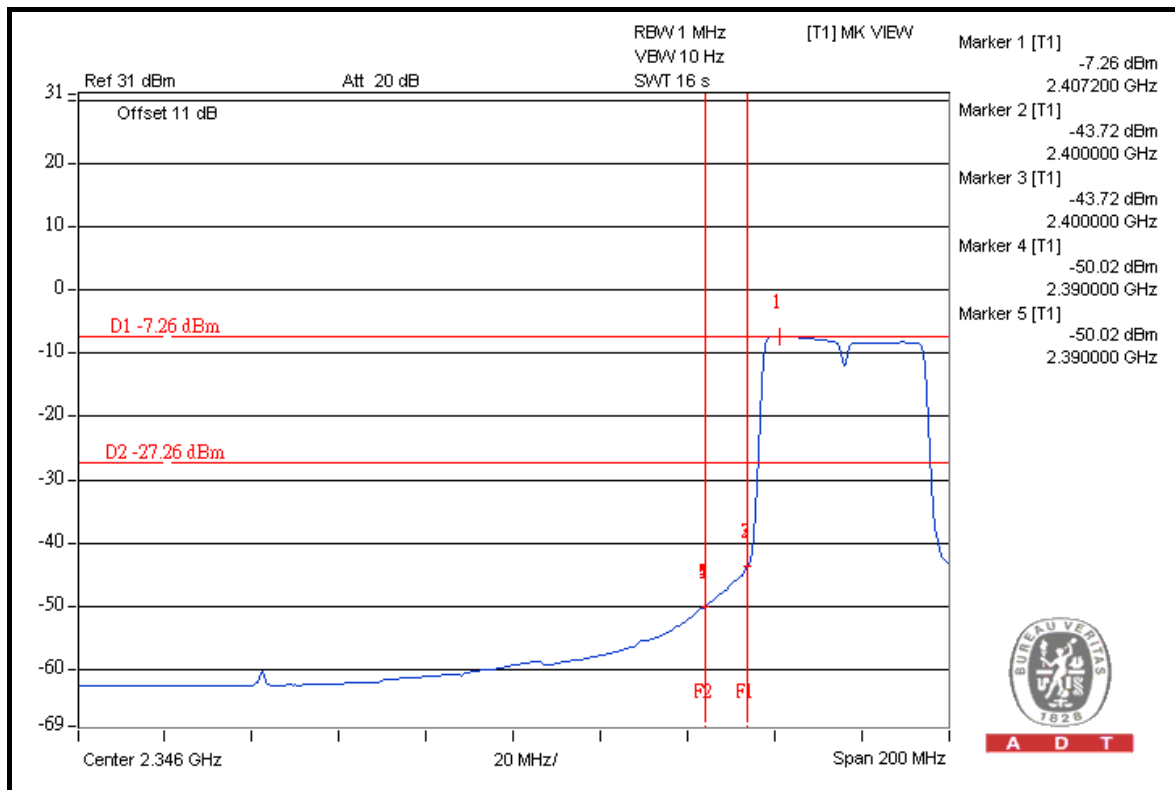

A D T



A D T

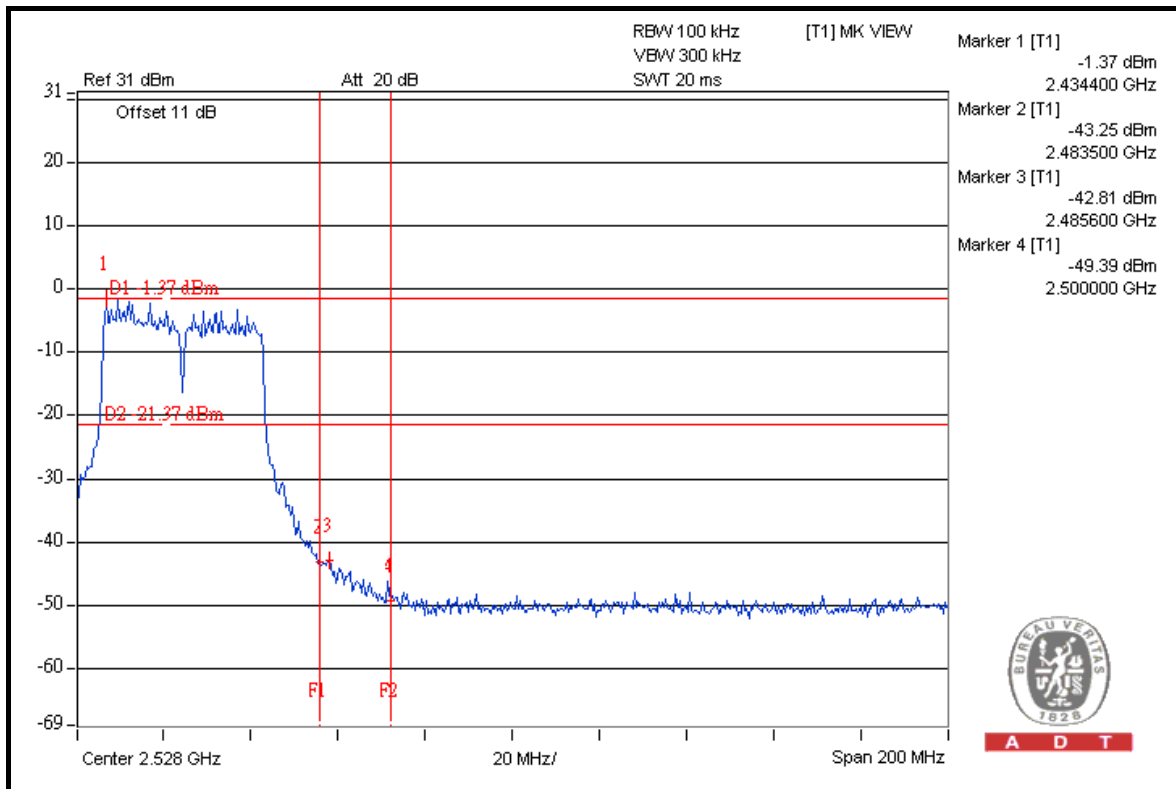
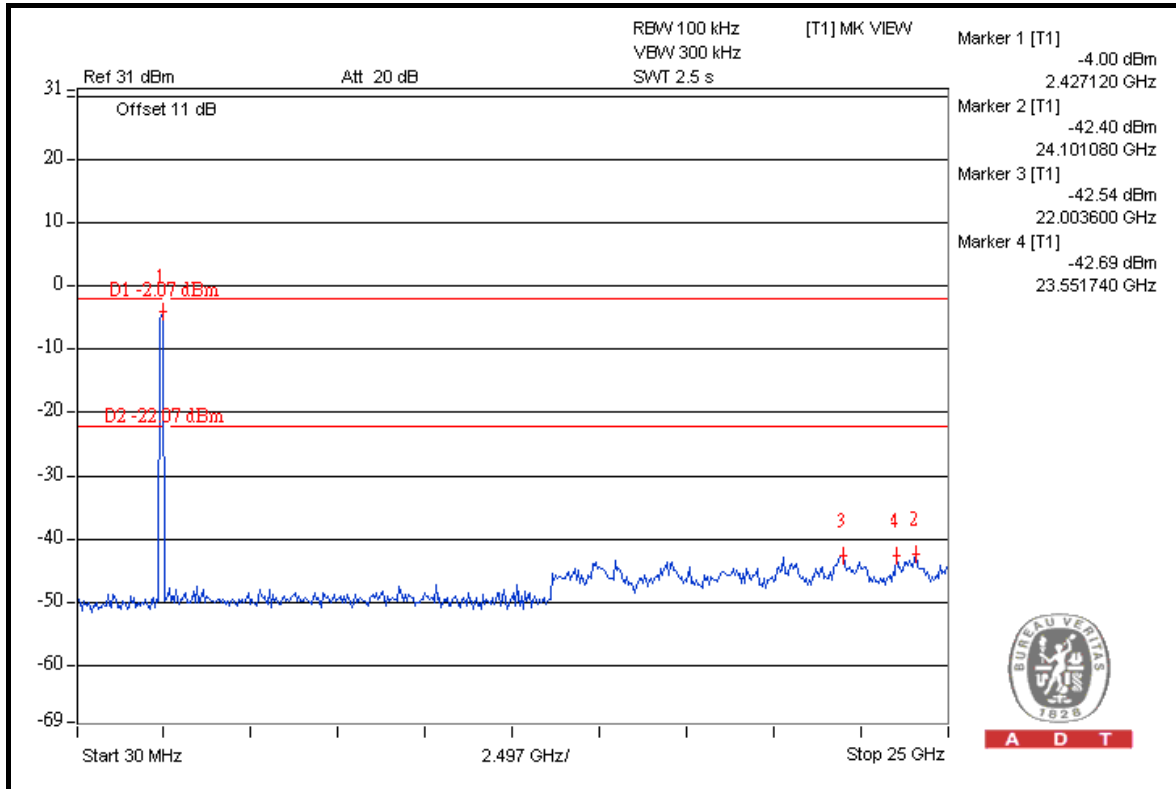



A D T

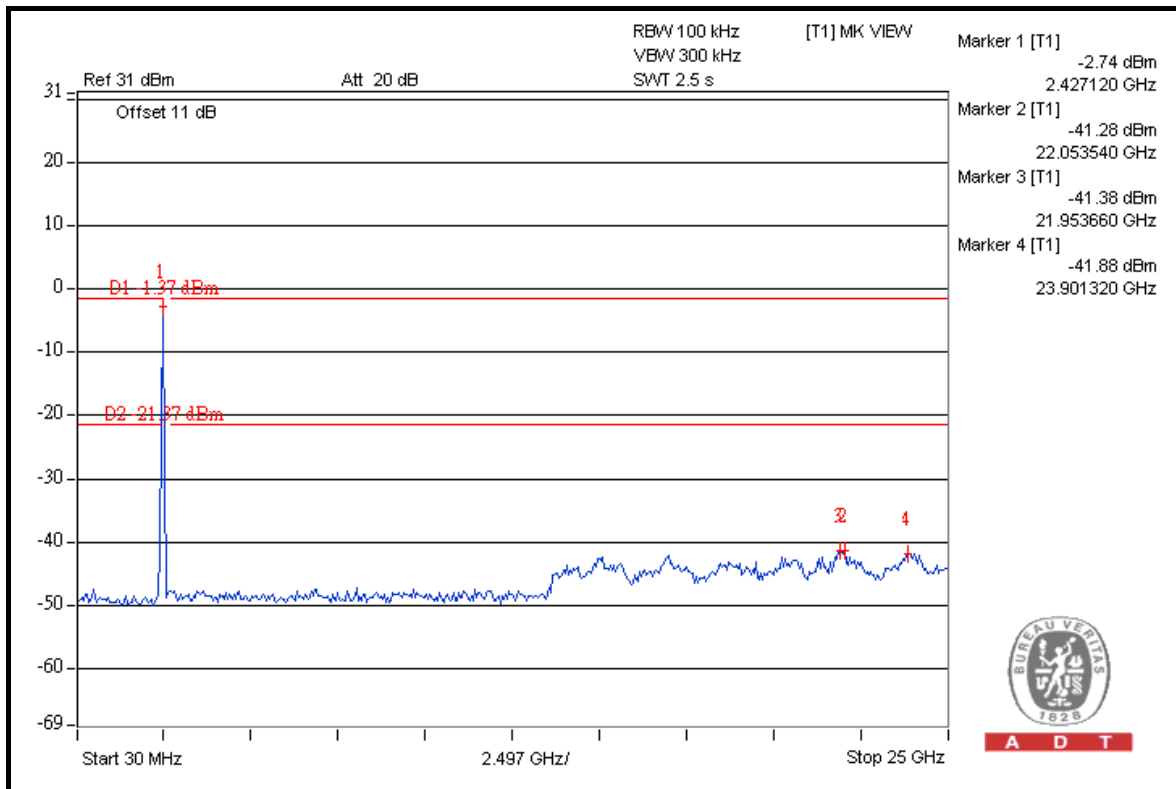
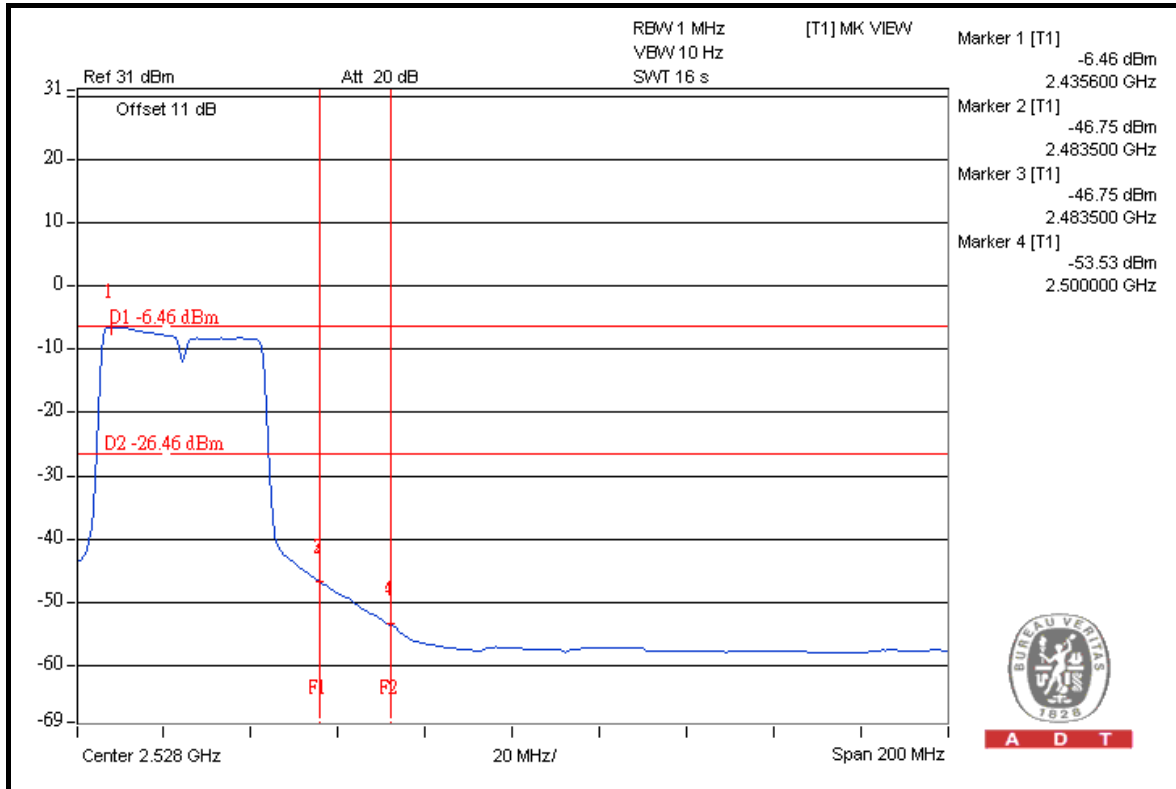



A D T

CHAIN 1

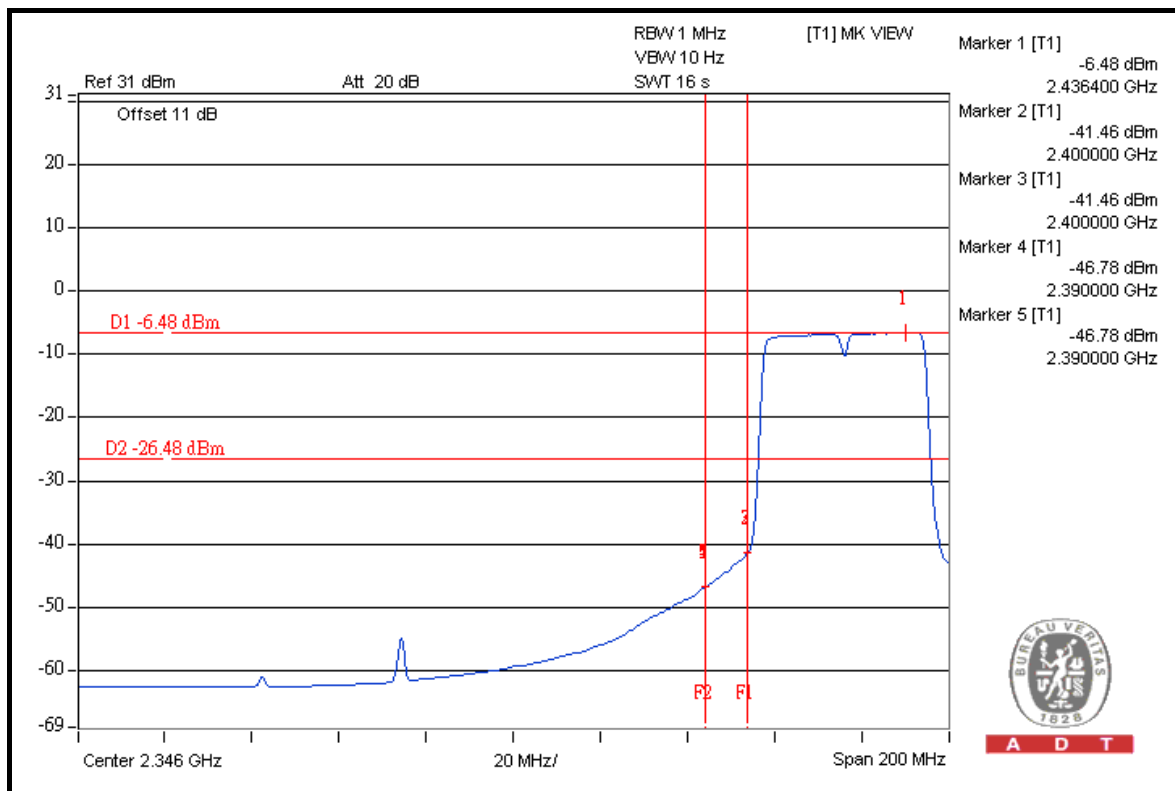
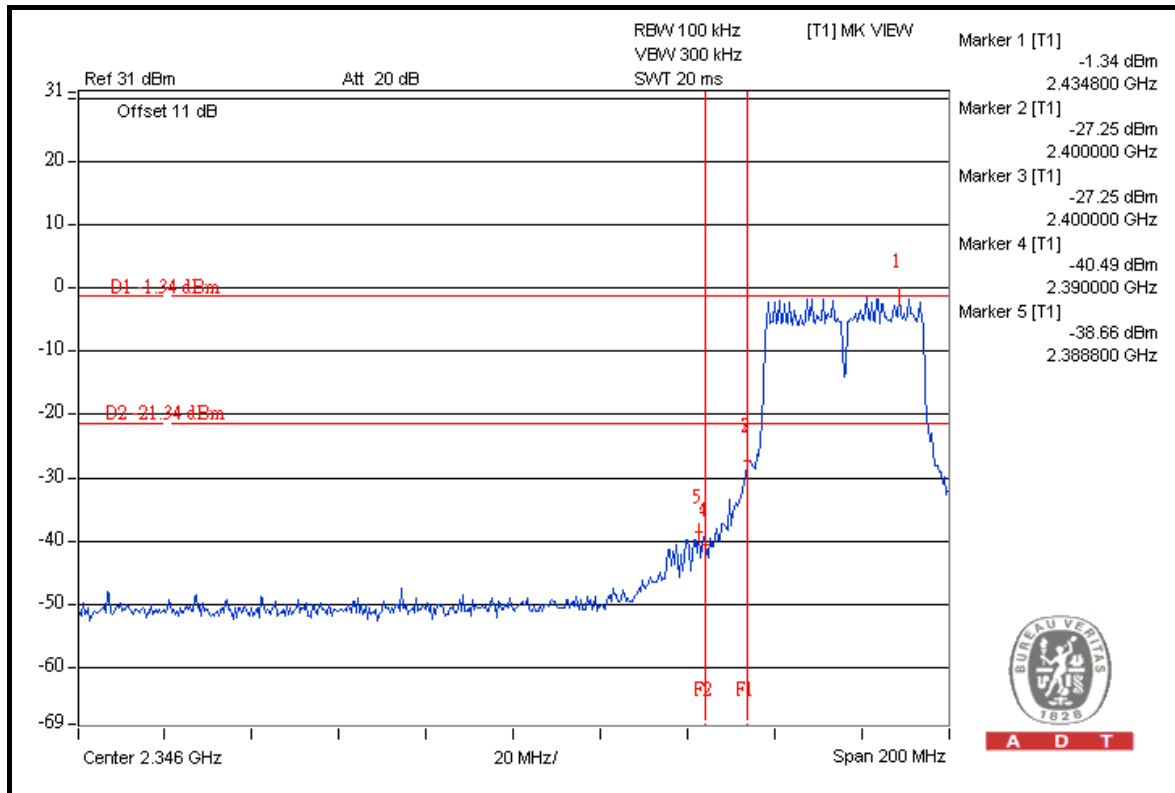



A D T

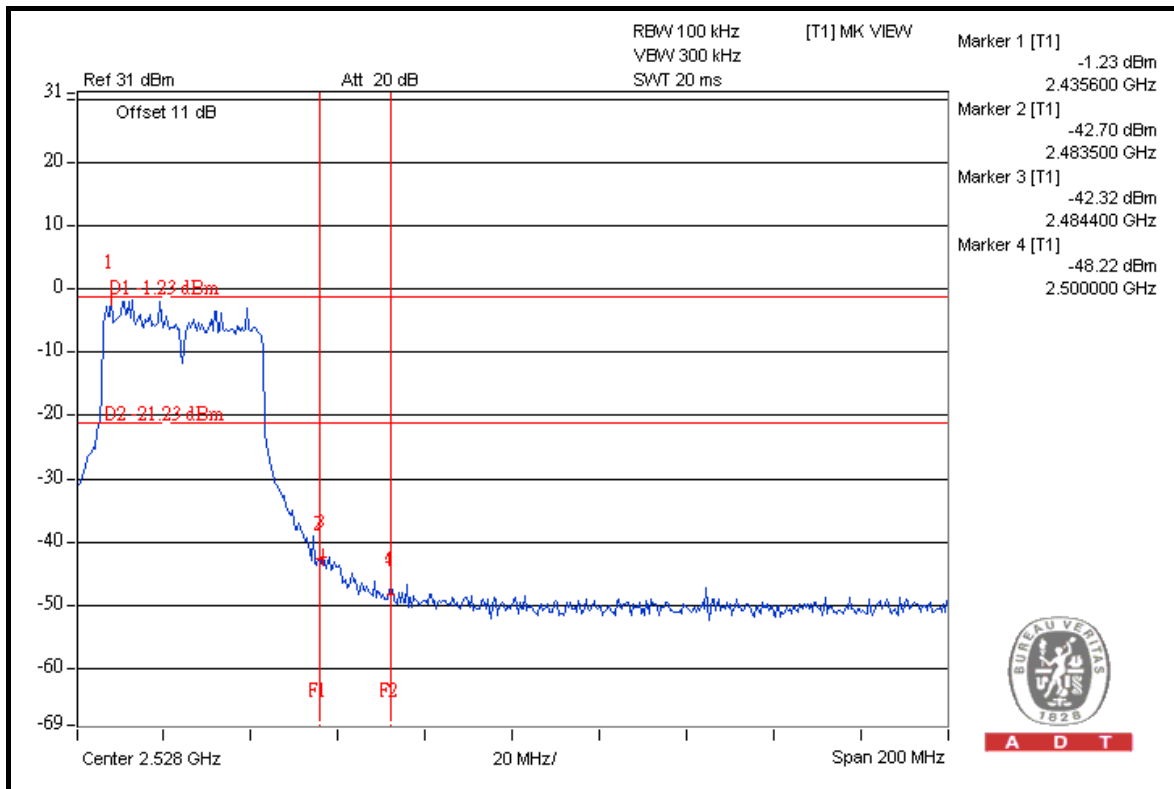
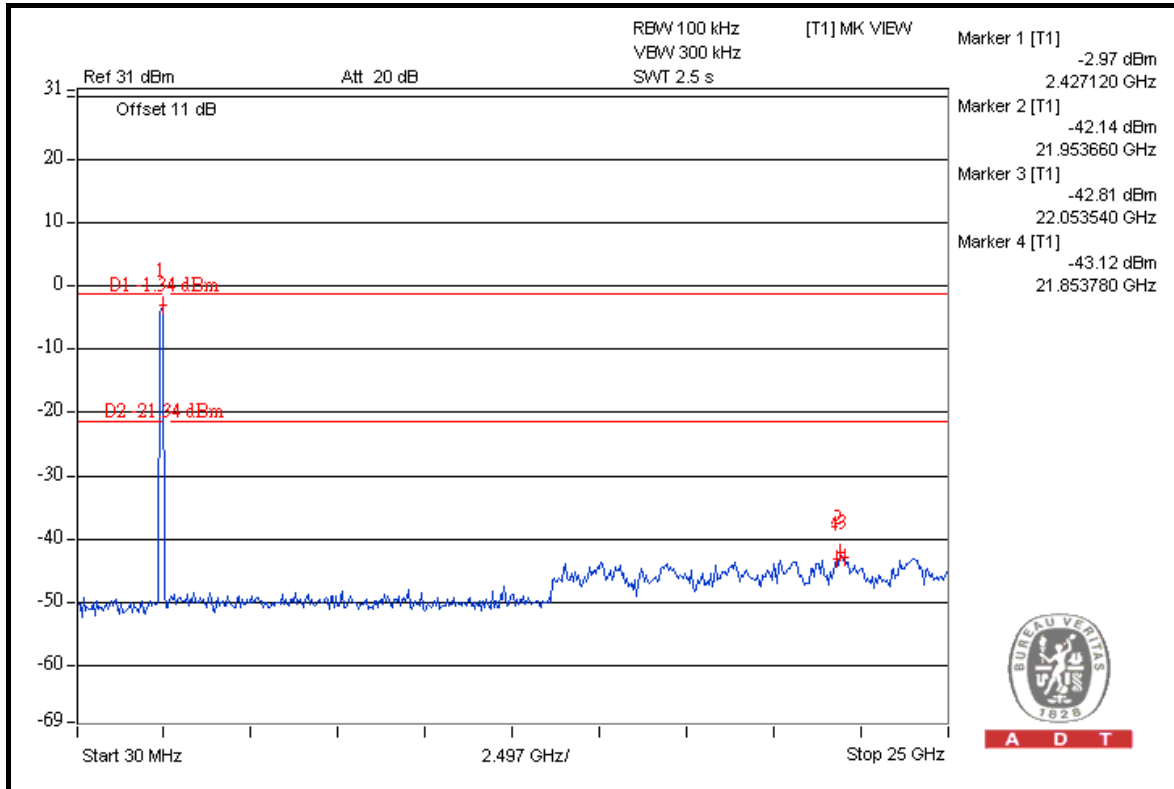



A D T

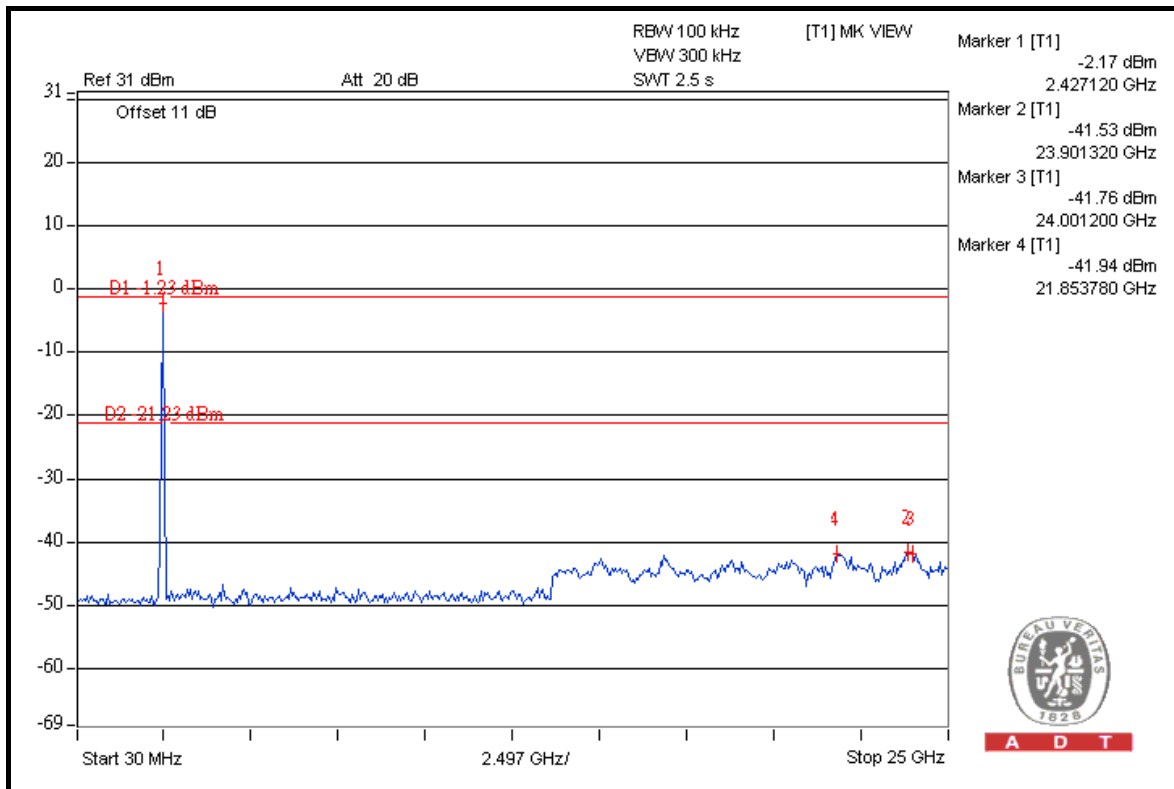
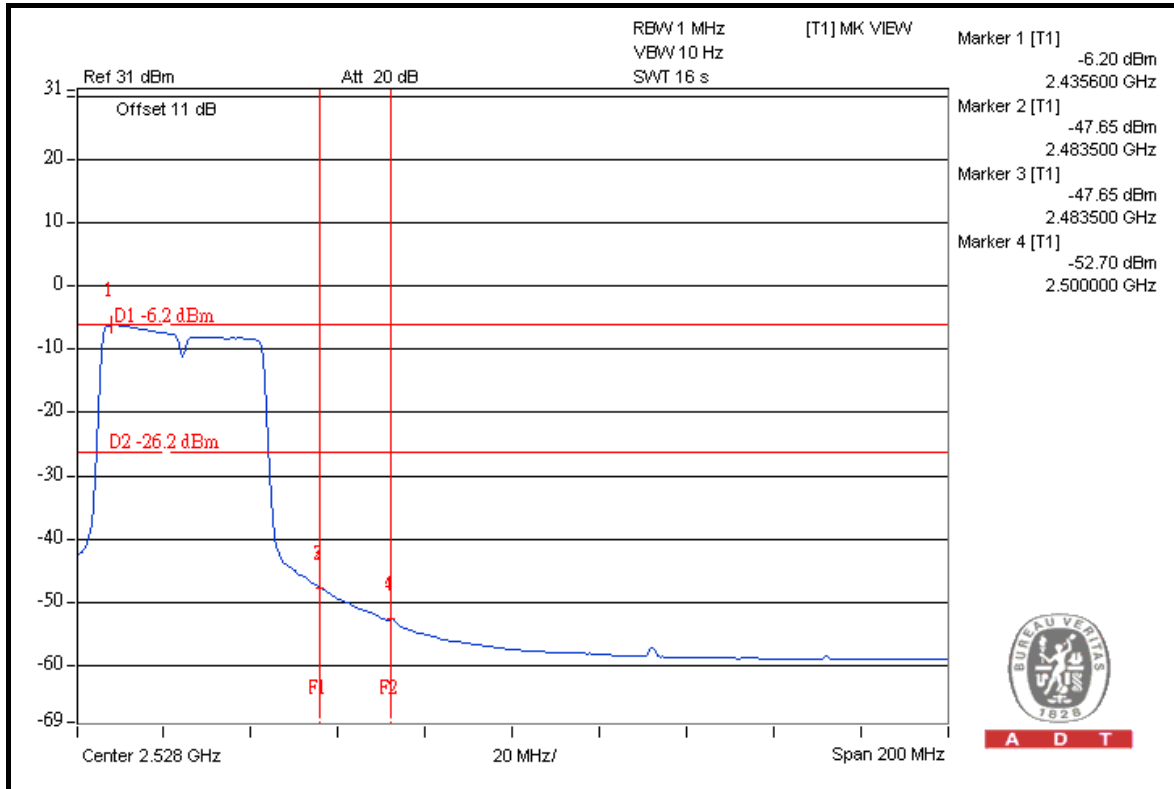



A D T

CHAIN 2

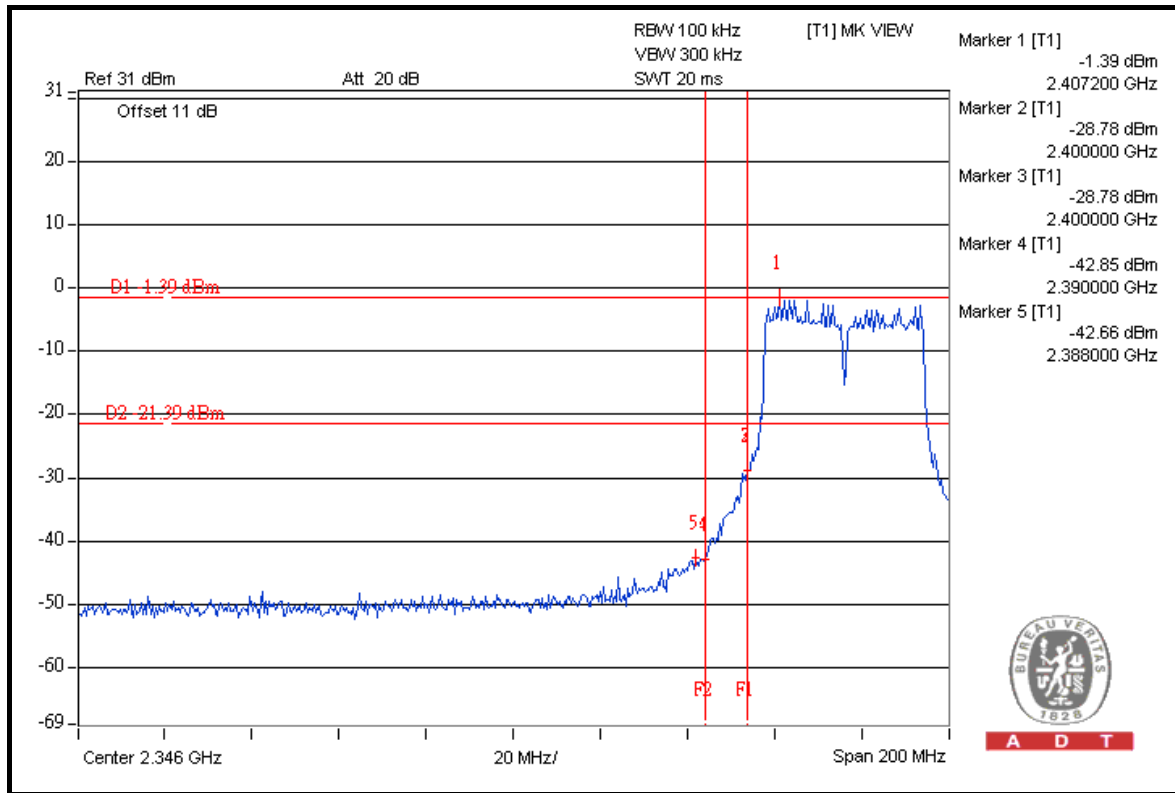

A D T

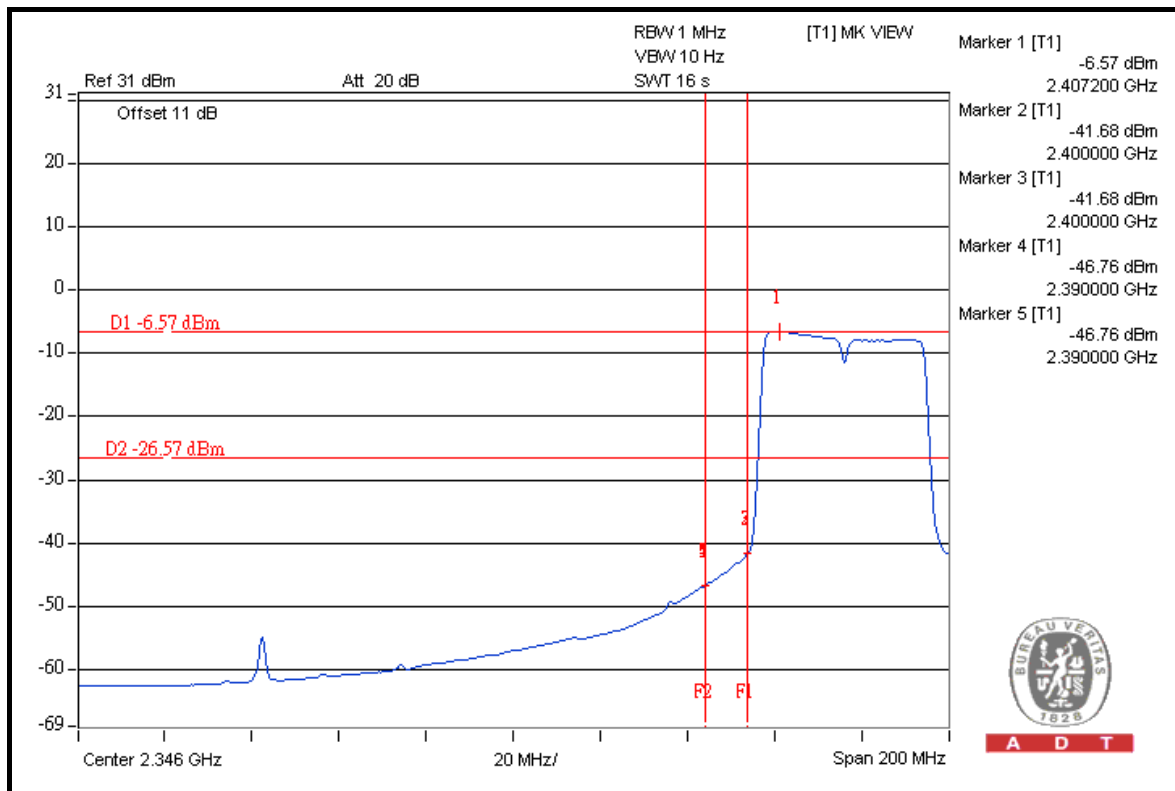

A D T



A D T

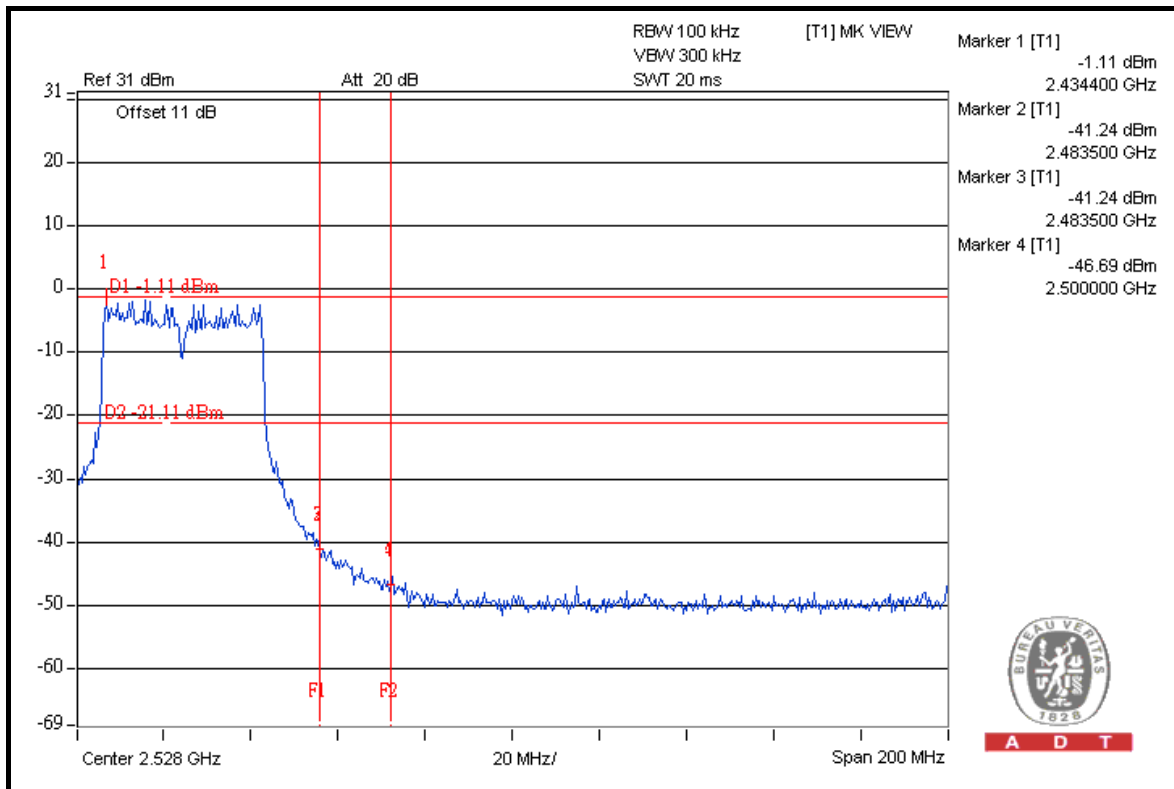
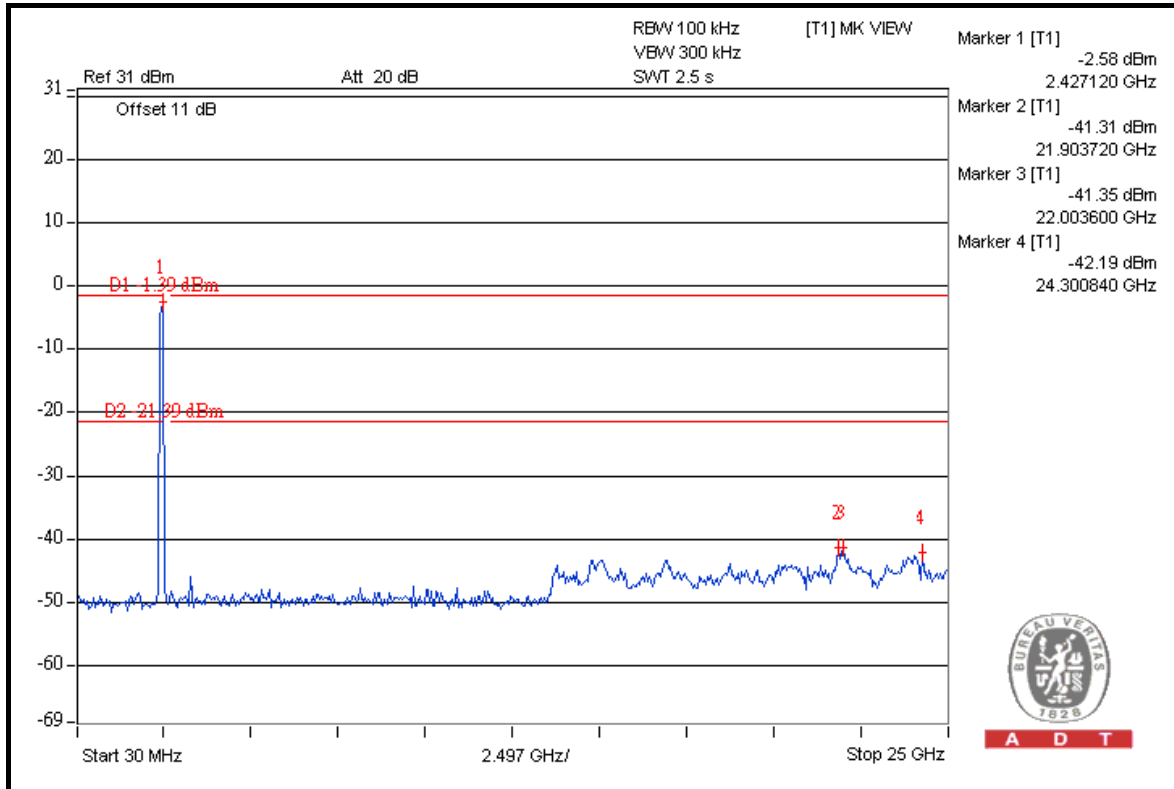



A D T

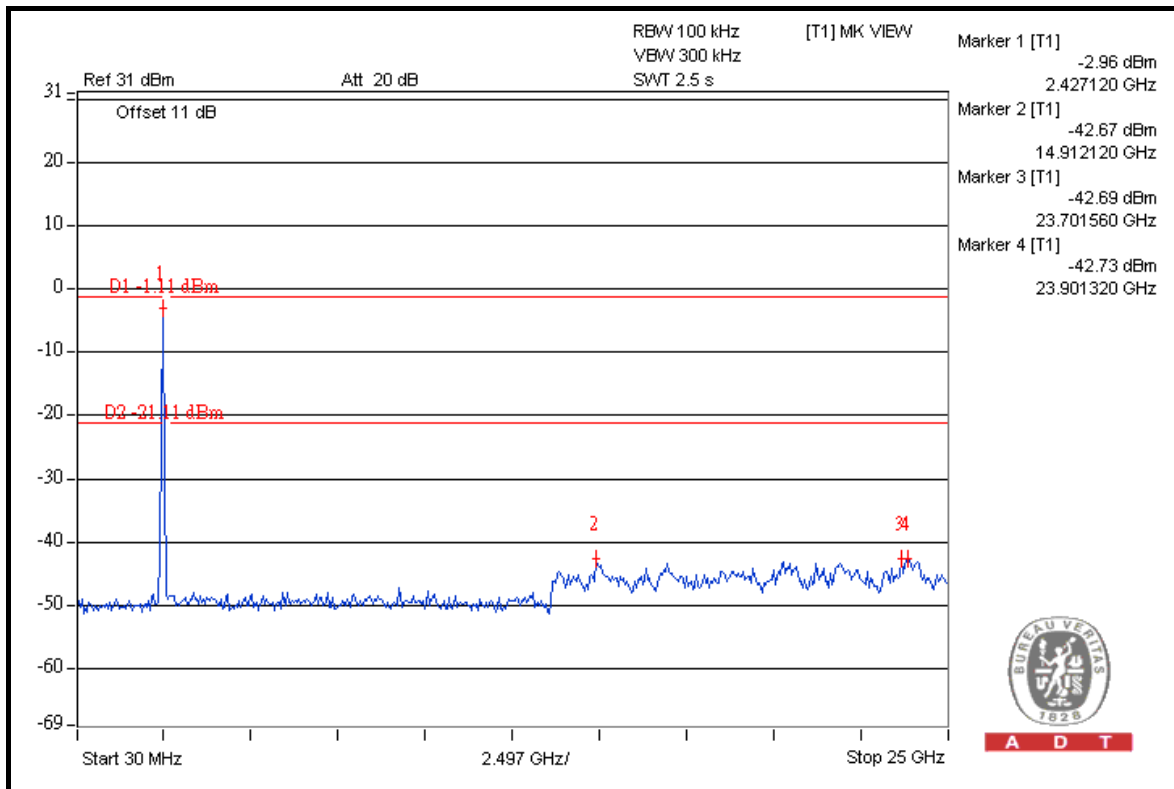
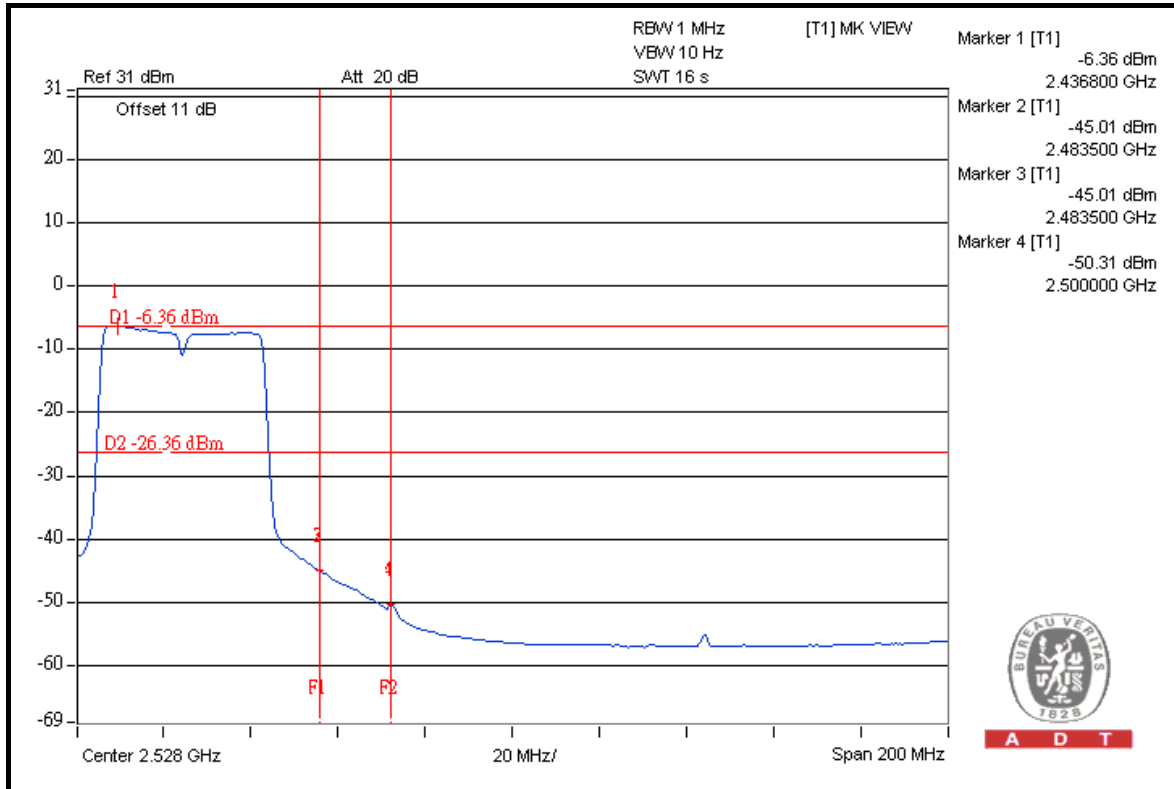



5. TEST TYPES AND RESULTS (FOR 5.0GHz BAND)

5.1 RADIATED EMISSION MEASUREMENT

5.1.1 LIMITS OF RADIATED EMISSION MEASUREMENT

Emissions radiated outside of the specified bands, shall be according to the general radiated limits in 15.209 as following:

FREQUENCIES (MHz)	FIELD STRENGTH (microvolts/meter)	MEASUREMENT DISTANCE (meters)
0.009 ~ 0.490	2400/F(kHz)	300
0.490 ~ 1.705	24000/F(kHz)	30
1.705 ~ 30.0	30	30
30 ~ 88	100	3
88 ~ 216	150	3
216 ~ 960	200	3
Above 960	500	3

NOTE:

1. The lower limit shall apply at the transition frequencies.
2. Emission level (dBuV/m) = 20 log Emission level (uV/m).
3. As shown in 15.35(b), for frequencies above 1000MHz, the field strength limits are based on average detector, however, the peak field strength of any emission shall not exceed the maximum permitted average limits, specified above by more than 20dB under any condition of modulation.



ADT

5.1.2 TEST INSTRUMENTS

DESCRIPTION & MANUFACTURER	MODEL NO.	SERIAL NO.	DATE OF CALIBRATION	DUE DATE OF CALIBRATION
Test Receiver ROHDE & SCHWARZ	ESIB7	100212	Jul. 22, 2010	Jul. 21, 2011
Spectrum Analyzer Agilent	E4446A	MY48250266	Aug. 11, 2010	Aug. 10, 2011
BILOG Antenna SCHWARZBECK	VULB9168	9168-160	Apr. 13, 2011	Apr. 12, 2012
HORN Antenna SCHWARZBECK	9120D	9120D-405	Feb. 08, 2011	Feb. 07, 2012
HORN Antenna SCHWARZBECK	BBHA 9170	BBHA9170243	Dec. 27, 2010	Dec. 26, 2011
Preamplifier Agilent	8447D	2944A10633	Nov. 02, 2010	Nov. 01, 2011
Preamplifier Agilent	8449B	3008A01964	Nov. 02, 2010	Nov. 01, 2011
RF signal cable HUBER+SUHNNER	SUCOFLEX 104	295014/4	Sep 03, 2010	Sep 02, 2011
RF signal cable HUBER+SUHNNER	SUCOFLEX 104	12738/6	Sep 03, 2010	Sep 02, 2011
Software ADT.	ADT_Radiated_ V7.6.15.9.2	NA	NA	NA
Antenna Tower inn-co GmbH	MA 4000	013303	NA	NA
Antenna Tower Controller inn-co GmbH	CO2000	017303	NA	NA
Turn Table ADT.	TT100.	TT93021703	NA	NA
Turn Table Controller ADT.	SC100.	SC93021703	NA	NA
26GHz ~ 40GHz Amplifier	EM26400	07026401	Aug. 25, 2010	Aug. 24, 2011

- NOTE:**
1. The calibration interval of the above test instruments is 12 months and the calibrations are traceable to NML/ROC and NIST/USA.
 2. The test was performed in HwaYa Chamber 3.
 3. The horn antenna and HP preamplifier (model: 8449B) are used only for the measurement of emission frequency above 1GHz if tested.
 4. The FCC Site Registration No. is 988962.
 5. The IC Site Registration No. is IC7450F-3.



5.1.3 TEST PROCEDURES

- a. The EUT was placed on the top of a rotating table 0.8 meters above the ground at a 3 meters semi-anechoic chamber. The table was rotated 360 degrees to determine the position of the highest radiation.
- b. The EUT was set 3 meters away from the interference-receiving antenna, which was mounted on the top of a variable-height antenna tower.
- c. The antenna is a broadband antenna, and its height is varied from one meter to four meters above the ground to determine the maximum value of the field strength. Both horizontal and vertical polarizations of the antenna are set to make the measurement.
- d. For each suspected emission, the EUT was arranged to its worst case and then the antenna was tuned to heights from 1 meter to 4 meters and the rotatable table was turned from 0 degrees to 360 degrees to find the maximum reading.
- e. The test-receiver system was set to Peak Detect Function and Specified Bandwidth with Maximum Hold Mode.
- f. If the emission level of the EUT in peak mode was lower than the limit specified, then testing could be stopped and the peak values of the EUT would be reported. Otherwise the emissions would be re-tested one by one using peak, quasi-peak or average method as specified and then reported in a data sheet.

NOTE:

1. The resolution bandwidth and video bandwidth of test receiver/spectrum analyzer is 120kHz for Quasi-peak detection at frequency below 1GHz.
2. The resolution bandwidth of test receiver/spectrum analyzer is 100kHz and video bandwidth is 300kHz for Peak detection at frequency above 1GHz.
3. The resolution bandwidth of test receiver/spectrum analyzer is 1MHz and the video bandwidth is 10Hz for Average detection (AV) at frequency above 1GHz.
4. All modes of operation were investigated and the worst-case emissions are reported.

5.1.4 DEVIATION FROM TEST STANDARD

No deviation.

5.1.5 TEST SETUP

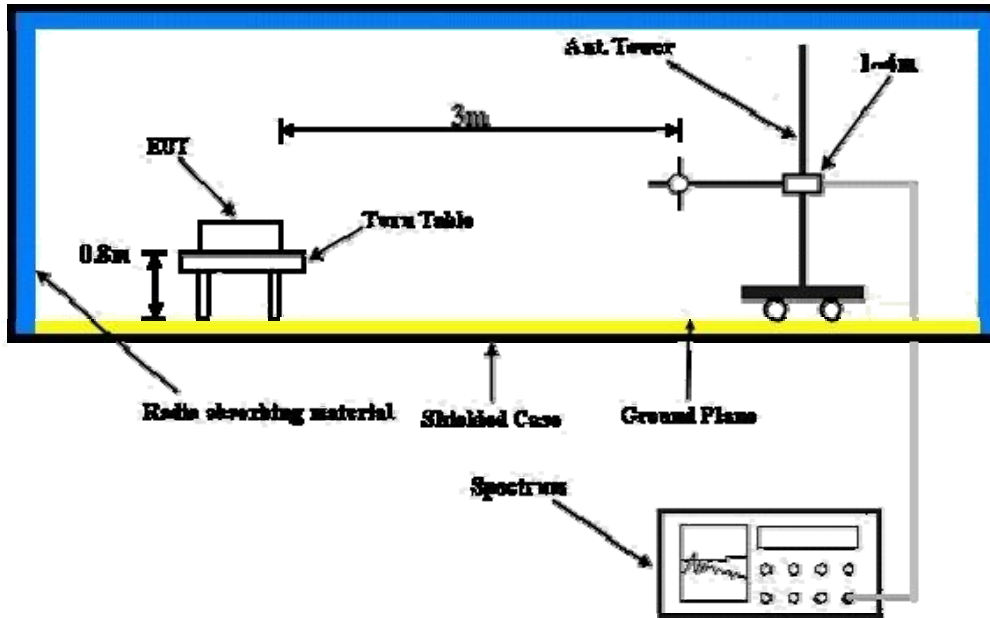

For the actual test configuration, please refer to the attached file (Test Setup Photo).

5.1.6 EUT OPERATING CONDITIONS

Same as 4.1.6



A D T

5.1.7 TEST RESULTS

ABOVE 1GHz WORST-CASE DATA : 802.11a

EUT TEST CONDITION		MEASUREMENT DETAIL	
CHANNEL	Channel 149	FREQUENCY RANGE	1 ~ 40GHz
INPUT POWER (SYSTEM)	120Vac, 60 Hz	DETECTOR FUNCTION	Peak (PK) Average (AV)
ENVIRONMENTAL CONDITIONS	25deg. C, 60%RH 1008 hPa	TESTED BY	Mitch Jen

ANTENNA POLARITY & TEST DISTANCE: HORIZONTAL AT 3 M								
NO.	FREQ. (MHz)	EMISSION LEVEL (dBuV/m)	LIMIT (dBuV/m)	MARGIN (dB)	ANTENNA HEIGHT (m)	TABLE ANGLE (Degree)	RAW VALUE (dBuV)	CORRECTION FACTOR (dB/m)
1	5000.00	58.9 PK	74.0	-15.1	1.64 H	58	22.00	36.90
2	5000.00	52.9 AV	54.0	-1.1	1.64 H	58	16.00	36.90
3	#5725.00	86.1 PK	96.7	-10.6	1.54 H	54	48.00	38.10
4	#5725.00	66.9 AV	83.8	-16.9	1.54 H	54	28.80	38.10
5	*5745.00	116.7 PK			1.52 H	58	78.50	38.20
6	*5745.00	103.8 AV			1.52 H	58	65.60	38.20
7	11490.00	57.7 PK	74.0	-16.3	1.08 H	168	8.70	49.00
8	11490.00	44.3 AV	54.0	-9.7	1.08 H	168	-4.70	49.00
ANTENNA POLARITY & TEST DISTANCE: VERTICAL AT 3 M								
NO.	FREQ. (MHz)	EMISSION LEVEL (dBuV/m)	LIMIT (dBuV/m)	MARGIN (dB)	ANTENNA HEIGHT (m)	TABLE ANGLE (Degree)	RAW VALUE (dBuV)	CORRECTION FACTOR (dB/m)
1	5000.00	61.2 PK	74.0	-12.8	1.04 V	300	24.30	36.90
2	5000.00	53.0 AV	54.0	-1.0	1.04 V	300	16.10	36.90
3	#5725.00	83.6 PK	95.4	-11.8	1.09 V	298	45.50	38.10
4	#5725.00	65.6 AV	82.5	-16.9	1.09 V	298	27.50	38.10
5	*5745.00	115.4 PK			1.10 V	300	77.20	38.20
6	*5745.00	102.5 AV			1.10 V	300	64.30	38.20
7	11490.00	56.9 PK	74.0	-17.1	1.35 V	91	7.90	49.00
8	11490.00	44.1 AV	54.0	-9.9	1.35 V	91	-4.90	49.00

- REMARKS:**
1. Emission level (dBuV/m) = Raw Value (dBuV) + Correction Factor (dB/m).
 2. Correction Factor (dB/m) = Antenna Factor (dB/m) + Cable Factor (dB).
 3. The other emission levels were very low against the limit.
 4. Margin value = Emission level – Limit value.
 5. “ * “: Fundamental frequency.
 6. The limit value is defined as per 15.247.
 7. "#":The radiated frequency is out the restricted band.



A D T

EUT TEST CONDITION		MEASUREMENT DETAIL	
CHANNEL	Channel 157	FREQUENCY RANGE	1 ~ 40GHz
INPUT POWER (SYSTEM)	120Vac, 60 Hz	DETECTOR FUNCTION	Peak (PK) Average (AV)
ENVIRONMENTAL CONDITIONS	25deg. C, 60%RH 1008 hPa	TESTED BY	Mitch Jen

ANTENNA POLARITY & TEST DISTANCE: HORIZONTAL AT 3 M								
NO.	FREQ. (MHz)	EMISSION LEVEL (dBuV/m)	LIMIT (dBuV/m)	MARGIN (dB)	ANTENNA HEIGHT (m)	TABLE ANGLE (Degree)	RAW VALUE (dBuV)	CORRECTION FACTOR (dB/m)
1	5000.00	58.1 PK	74.0	-15.9	1.73 H	287	21.10	37.00
2	5000.00	52.8 AV	54.0	-1.2	1.73 H	287	15.80	37.00
3	*5785.00	113.3 PK			1.51 H	56	75.00	38.30
4	*5785.00	100.8 AV			1.51 H	56	62.50	38.30
5	11570.00	61.2 PK	74.0	-12.8	1.15 H	305	12.30	48.90
6	11570.00	47.6 AV	54.0	-6.4	1.15 H	305	-1.30	48.90
ANTENNA POLARITY & TEST DISTANCE: VERTICAL AT 3 M								
NO.	FREQ. (MHz)	EMISSION LEVEL (dBuV/m)	LIMIT (dBuV/m)	MARGIN (dB)	ANTENNA HEIGHT (m)	TABLE ANGLE (Degree)	RAW VALUE (dBuV)	CORRECTION FACTOR (dB/m)
1	5000.00	57.5 PK	74.0	-16.5	1.03 V	304	20.50	37.00
2	5000.00	51.9 AV	54.0	-2.1	1.03 V	304	14.90	37.00
3	*5785.00	112.2 PK			1.00 V	116	73.90	38.30
4	*5785.00	99.0 AV			1.00 V	116	60.70	38.30
5	11570.00	60.0 PK	74.0	-14.0	1.12 V	318	11.10	48.90
6	11570.00	46.5 AV	54.0	-7.5	1.12 V	318	-2.40	48.90

- REMARKS:**
1. Emission level (dBuV/m) = Raw Value (dBuV) + Correction Factor (dB/m).
 2. Correction Factor (dB/m) = Antenna Factor (dB/m) + Cable Factor (dB).
 3. The other emission levels were very low against the limit.
 4. Margin value = Emission level – Limit value.
 5. “ * “: Fundamental frequency.
 6. The limit value is defined as per 15.247.



A D T

EUT TEST CONDITION		MEASUREMENT DETAIL	
CHANNEL	Channel 165	FREQUENCY RANGE	1 ~ 40GHz
INPUT POWER (SYSTEM)	120Vac, 60 Hz	DETECTOR FUNCTION	Peak (PK) Average (AV)
ENVIRONMENTAL CONDITIONS	25deg. C, 60%RH 1008 hPa	TESTED BY	Mitch Jen

ANTENNA POLARITY & TEST DISTANCE: HORIZONTAL AT 3 M								
NO.	FREQ. (MHz)	EMISSION LEVEL (dBuV/m)	LIMIT (dBuV/m)	MARGIN (dB)	ANTENNA HEIGHT (m)	TABLE ANGLE (Degree)	RAW VALUE (dBuV)	CORRECTION FACTOR (dB/m)
1	5000.00	57.9 PK	74.0	-16.1	1.70 H	293	20.90	37.00
2	5000.00	53.1 AV	54.0	-0.9	1.70 H	293	16.10	37.00
3	*5825.00	113.6 PK			1.49 H	59	75.20	38.40
4	*5825.00	101.5 AV			1.49 H	59	63.10	38.40
5	#5850.00	78.8 PK	93.6	-14.8	1.50 H	54	40.40	38.40
6	#5850.00	59.2 AV	81.5	-22.3	1.50 H	54	20.80	38.40
7	11650.00	62.5 PK	74.0	-11.5	1.27 H	306	13.80	48.70
8	11650.00	47.7 AV	54.0	-6.3	1.27 H	306	-1.00	48.70
ANTENNA POLARITY & TEST DISTANCE: VERTICAL AT 3 M								
NO.	FREQ. (MHz)	EMISSION LEVEL (dBuV/m)	LIMIT (dBuV/m)	MARGIN (dB)	ANTENNA HEIGHT (m)	TABLE ANGLE (Degree)	RAW VALUE (dBuV)	CORRECTION FACTOR (dB/m)
1	5000.00	57.7 PK	74.0	-16.3	1.30 V	302	20.70	37.00
2	5000.00	51.4 AV	54.0	-2.6	1.30 V	302	14.40	37.00
3	*5825.00	114.0 PK			1.09 V	37	75.60	38.40
4	*5825.00	100.7 AV			1.09 V	37	62.30	38.40
5	#5850.00	69.9 PK	94.0	-24.1	1.39 V	43	31.50	38.40
6	#5850.00	51.1 AV	80.7	-29.6	1.39 V	43	12.70	38.40
7	11650.00	60.2 PK	74.0	-13.8	1.17 V	312	11.50	48.70
8	11650.00	46.7 AV	54.0	-7.3	1.17 V	312	-2.00	48.70

- REMARKS:**
1. Emission level (dBuV/m) = Raw Value (dBuV) + Correction Factor (dB/m).
 2. Correction Factor (dB/m) = Antenna Factor (dB/m) + Cable Factor (dB).
 3. The other emission levels were very low against the limit.
 4. Margin value = Emission level – Limit value.
 5. “ * “: Fundamental frequency.
 6. The limit value is defined as per 15.247.
 7. "#":The radiated frequency is out the restricted band.



A D T

802.11n (20MHz)

EUT TEST CONDITION		MEASUREMENT DETAIL	
CHANNEL	Channel 149	FREQUENCY RANGE	1 ~ 40GHz
INPUT POWER (SYSTEM)	120Vac, 60 Hz	DETECTOR FUNCTION	Peak (PK) Average (AV)
ENVIRONMENTAL CONDITIONS	25deg. C, 65%RH 1011 hPa	TESTED BY	Brad Wu

ANTENNA POLARITY & TEST DISTANCE: HORIZONTAL AT 3 M								
NO.	FREQ. (MHz)	EMISSION LEVEL (dBuV/m)	LIMIT (dBuV/m)	MARGIN (dB)	ANTENNA HEIGHT (m)	TABLE ANGLE (Degree)	RAW VALUE (dBuV)	CORRECTION FACTOR (dB/m)
1	5120.00	58.0 PK	74.0	-16.0	1.30 H	88	21.30	36.70
2	5120.00	52.8 AV	54.0	-1.2	1.30 H	88	16.10	36.70
3	#5725.00	70.7 PK	94.3	-23.6	1.09 H	111	33.00	37.70
4	#5725.00	52.8 AV	82.7	-29.9	1.09 H	111	15.10	37.70
5	*5745.00	114.3 PK			1.19 H	101	76.60	37.70
6	*5745.00	102.7 AV			1.19 H	101	65.00	37.70
7	11490.00	57.8 PK	74.0	-16.2	1.06 H	235	9.60	48.20
8	11490.00	44.5 AV	54.0	-9.5	1.06 H	235	-3.70	48.20
ANTENNA POLARITY & TEST DISTANCE: VERTICAL AT 3 M								
NO.	FREQ. (MHz)	EMISSION LEVEL (dBuV/m)	LIMIT (dBuV/m)	MARGIN (dB)	ANTENNA HEIGHT (m)	TABLE ANGLE (Degree)	RAW VALUE (dBuV)	CORRECTION FACTOR (dB/m)
1	5120.00	57.2 PK	74.0	-16.8	1.15 V	190	20.50	36.70
2	5120.00	51.4 AV	54.0	-2.6	1.15 V	190	14.70	36.70
3	#5725.00	68.2 PK	92.0	-23.8	1.01 V	185	30.50	37.70
4	#5725.00	50.3 AV	80.3	-30.0	1.01 V	185	12.60	37.70
5	*5745.00	112.0 PK			1.01 V	185	74.30	37.70
6	*5745.00	100.3 AV			1.01 V	185	62.60	37.70
7	11490.00	58.2 PK	74.0	-15.8	1.04 V	236	10.00	48.20
8	11490.00	45.0 AV	54.0	-9.0	1.04 V	236	-3.20	48.20

- REMARKS:**
1. Emission level (dBuV/m) = Raw Value (dBuV) + Correction Factor (dB/m).
 2. Correction Factor (dB/m) = Antenna Factor (dB/m) + Cable Factor (dB).
 3. The other emission levels were very low against the limit.
 4. Margin value = Emission level – Limit value.
 5. " * ": Fundamental frequency.
 6. The limit value is defined as per 15.247.
 7. "#":The radiated frequency is out the restricted band.



A D T

EUT TEST CONDITION		MEASUREMENT DETAIL	
CHANNEL	Channel 157	FREQUENCY RANGE	1 ~ 40GHz
INPUT POWER (SYSTEM)	120Vac, 60 Hz	DETECTOR FUNCTION	Peak (PK) Average (AV)
ENVIRONMENTAL CONDITIONS	25deg. C, 65%RH 1011 hPa	TESTED BY	Brad Wu

ANTENNA POLARITY & TEST DISTANCE: HORIZONTAL AT 3 M								
NO.	FREQ. (MHz)	EMISSION LEVEL (dBuV/m)	LIMIT (dBuV/m)	MARGIN (dB)	ANTENNA HEIGHT (m)	TABLE ANGLE (Degree)	RAW VALUE (dBuV)	CORRECTION FACTOR (dB/m)
1	5120.00	57.4 PK	74.0	-16.6	1.25 H	113	20.70	36.70
2	5120.00	52.1 AV	54.0	-1.9	1.25 H	113	15.40	36.70
3	*5785.00	114.0 PK			1.00 H	119	76.30	37.70
4	*5785.00	102.4 AV			1.00 H	119	64.70	37.70
5	11570.00	57.8 PK	74.0	-16.2	1.06 H	53	9.80	48.00
6	11570.00	44.6 AV	54.0	-9.4	1.06 H	53	-3.40	48.00
ANTENNA POLARITY & TEST DISTANCE: VERTICAL AT 3 M								
NO.	FREQ. (MHz)	EMISSION LEVEL (dBuV/m)	LIMIT (dBuV/m)	MARGIN (dB)	ANTENNA HEIGHT (m)	TABLE ANGLE (Degree)	RAW VALUE (dBuV)	CORRECTION FACTOR (dB/m)
1	5120.00	56.6 PK	74.0	-17.4	1.13 V	185	19.90	36.70
2	5120.00	50.9 AV	54.0	-3.1	1.13 V	185	14.20	36.70
3	*5785.00	111.8 PK			1.02 V	190	74.10	37.70
4	*5785.00	100.0 AV			1.02 V	190	62.30	37.70
5	11570.00	58.6 PK	74.0	-15.4	1.09 V	242	10.60	48.00
6	11570.00	45.3 AV	54.0	-8.7	1.09 V	242	-2.70	48.00

- REMARKS:**
1. Emission level (dBuV/m) = Raw Value (dBuV) + Correction Factor (dB/m).
 2. Correction Factor (dB/m) = Antenna Factor (dB/m) + Cable Factor (dB).
 3. The other emission levels were very low against the limit.
 4. Margin value = Emission level – Limit value.
 5. “ * “: Fundamental frequency.
 6. The limit value is defined as per 15.247.



A D T

EUT TEST CONDITION		MEASUREMENT DETAIL	
CHANNEL	Channel 165	FREQUENCY RANGE	1 ~ 40GHz
INPUT POWER (SYSTEM)	120Vac, 60 Hz	DETECTOR FUNCTION	Peak (PK) Average (AV)
ENVIRONMENTAL CONDITIONS	25deg. C, 65%RH 1011 hPa	TESTED BY	Brad Wu

ANTENNA POLARITY & TEST DISTANCE: HORIZONTAL AT 3 M								
NO.	FREQ. (MHz)	EMISSION LEVEL (dBuV/m)	LIMIT (dBuV/m)	MARGIN (dB)	ANTENNA HEIGHT (m)	TABLE ANGLE (Degree)	RAW VALUE (dBuV)	CORRECTION FACTOR (dB/m)
1	5080.00	57.6 PK	74.0	-16.4	1.16 H	115	20.90	36.70
2	5080.00	52.4 AV	54.0	-1.6	1.16 H	115	15.70	36.70
3	*5825.00	113.6 PK			1.00 H	116	75.80	37.80
4	*5825.00	102.1 AV			1.00 H	116	64.30	37.80
5	#5850.00	65.5 PK	93.6	-28.1	1.00 H	116	27.70	37.80
6	#5850.00	49.2 AV	82.1	-32.9	1.00 H	116	11.40	37.80
7	11650.00	58.2 PK	74.0	-15.8	1.11 H	59	10.30	47.90
8	11650.00	45.1 AV	54.0	-8.9	1.11 H	59	-2.80	47.90
ANTENNA POLARITY & TEST DISTANCE: VERTICAL AT 3 M								
NO.	FREQ. (MHz)	EMISSION LEVEL (dBuV/m)	LIMIT (dBuV/m)	MARGIN (dB)	ANTENNA HEIGHT (m)	TABLE ANGLE (Degree)	RAW VALUE (dBuV)	CORRECTION FACTOR (dB/m)
1	5080.00	56.2 PK	74.0	-17.8	1.12 V	191	19.50	36.70
2	5080.00	50.4 AV	54.0	-3.6	1.12 V	191	13.70	36.70
3	*5825.00	111.4 PK			1.01 V	186	73.60	37.80
4	*5825.00	99.6 AV			1.01 V	186	61.80	37.80
5	#5850.00	62.8 PK	91.4	-28.6	1.01 V	186	25.00	37.80
6	#5850.00	46.4 AV	79.6	-33.2	1.01 V	186	8.60	37.80
7	11650.00	58.8 PK	74.0	-15.2	1.10 V	64	10.90	47.90
8	11650.00	45.6 AV	54.0	-8.4	1.10 V	64	-2.30	47.90

- REMARKS:**
1. Emission level (dBuV/m) = Raw Value (dBuV) + Correction Factor (dB/m).
 2. Correction Factor (dB/m) = Antenna Factor (dB/m) + Cable Factor (dB).
 3. The other emission levels were very low against the limit.
 4. Margin value = Emission level – Limit value.
 5. “ * “: Fundamental frequency.
 6. The limit value is defined as per 15.247.
 7. "#":The radiated frequency is out the restricted band.



A D T

802.11n (40MHz)

EUT TEST CONDITION		MEASUREMENT DETAIL	
CHANNEL	Channel 151	FREQUENCY RANGE	1 ~ 40GHz
INPUT POWER (SYSTEM)	120Vac, 60 Hz	DETECTOR FUNCTION	Peak (PK) Average (AV)
ENVIRONMENTAL CONDITIONS	25deg. C, 65%RH 1011 hPa	TESTED BY	Brad Wu

ANTENNA POLARITY & TEST DISTANCE: HORIZONTAL AT 3 M								
NO.	FREQ. (MHz)	EMISSION LEVEL (dBuV/m)	LIMIT (dBuV/m)	MARGIN (dB)	ANTENNA HEIGHT (m)	TABLE ANGLE (Degree)	RAW VALUE (dBuV)	CORRECTION FACTOR (dB/m)
1	5080.00	57.4 PK	74.0	-16.6	1.15 H	113	20.70	36.70
2	5080.00	50.9 AV	54.0	-3.1	1.15 H	113	14.20	36.70
3	#5725.00	75.3 PK	90.2	-14.9	1.08 H	109	37.60	37.70
4	#5725.00	56.9 AV	78.4	-21.5	1.08 H	109	19.20	37.70
5	*5755.00	110.2 PK			1.08 H	109	72.50	37.70
6	*5755.00	98.4 AV			1.08 H	109	60.70	37.70
7	11510.00	57.1 PK	74.0	-16.9	1.04 H	68	8.90	48.20
8	11510.00	44.0 AV	54.0	-10.0	1.04 H	68	-4.20	48.20
ANTENNA POLARITY & TEST DISTANCE: VERTICAL AT 3 M								
NO.	FREQ. (MHz)	EMISSION LEVEL (dBuV/m)	LIMIT (dBuV/m)	MARGIN (dB)	ANTENNA HEIGHT (m)	TABLE ANGLE (Degree)	RAW VALUE (dBuV)	CORRECTION FACTOR (dB/m)
1	5080.00	56.9 PK	74.0	-17.1	1.14 V	325	20.20	36.70
2	5080.00	50.2 AV	54.0	-3.8	1.14 V	325	13.50	36.70
3	#5725.00	73.0 PK	88.1	-15.1	1.09 V	14	35.30	37.70
4	#5725.00	54.4 AV	76.3	-21.9	1.09 V	14	16.70	37.70
5	*5755.00	108.1 PK			1.09 V	14	70.40	37.70
6	*5755.00	96.3 AV			1.09 V	14	58.60	37.70
7	11510.00	57.5 PK	74.0	-16.5	1.09 V	81	9.30	48.20
8	11510.00	44.3 AV	54.0	-9.7	1.09 V	81	-3.90	48.20

- REMARKS:**
1. Emission level (dBuV/m) = Raw Value (dBuV) + Correction Factor (dB/m).
 2. Correction Factor (dB/m) = Antenna Factor (dB/m) + Cable Factor (dB).
 3. The other emission levels were very low against the limit.
 4. Margin value = Emission level – Limit value.
 5. " * ": Fundamental frequency.
 6. The limit value is defined as per 15.247.
 7. "#": The radiated frequency is out the restricted band.



A D T

EUT TEST CONDITION		MEASUREMENT DETAIL	
CHANNEL	Channel 159	FREQUENCY RANGE	1 ~ 40GHz
INPUT POWER (SYSTEM)	120Vac, 60 Hz	DETECTOR FUNCTION	Peak (PK) Average (AV)
ENVIRONMENTAL CONDITIONS	25deg. C, 65%RH 1011 hPa	TESTED BY	Brad Wu

ANTENNA POLARITY & TEST DISTANCE: HORIZONTAL AT 3 M								
NO.	FREQ. (MHz)	EMISSION LEVEL (dBuV/m)	LIMIT (dBuV/m)	MARGIN (dB)	ANTENNA HEIGHT (m)	TABLE ANGLE (Degree)	RAW VALUE (dBuV)	CORRECTION FACTOR (dB/m)
1	5080.00	58.6 PK	74.0	-15.4	1.16 H	114	21.90	36.70
2	5080.00	52.2 AV	54.0	-1.8	1.16 H	114	15.50	36.70
3	*5795.00	110.8 PK			1.13 H	116	73.00	37.80
4	*5795.00	99.0 AV			1.13 H	116	61.20	37.80
5	#5850.00	63.5 PK	90.8	-27.3	1.08 H	116	25.70	37.80
6	#5850.00	45.7 AV	79.0	-33.3	1.08 H	116	7.90	37.80
7	11590.00	57.4 PK	74.0	-16.6	1.03 H	81	9.40	48.00
8	11590.00	44.2 AV	54.0	-9.8	1.03 H	81	-3.80	48.00
ANTENNA POLARITY & TEST DISTANCE: VERTICAL AT 3 M								
NO.	FREQ. (MHz)	EMISSION LEVEL (dBuV/m)	LIMIT (dBuV/m)	MARGIN (dB)	ANTENNA HEIGHT (m)	TABLE ANGLE (Degree)	RAW VALUE (dBuV)	CORRECTION FACTOR (dB/m)
1	5080.00	57.4 PK	74.0	-16.6	1.10 V	118	20.70	36.70
2	5080.00	50.8 AV	54.0	-3.2	1.10 V	118	14.10	36.70
3	*5795.00	108.6 PK			1.10 V	16	70.80	37.80
4	*5795.00	96.8 AV			1.10 V	16	59.00	37.80
5	#5850.00	61.2 PK	88.6	-27.4	1.10 V	16	23.40	37.80
6	#5850.00	43.4 AV	76.8	-33.4	1.10 V	16	5.60	37.80
7	11590.00	57.1 PK	74.0	-16.9	1.10 V	224	9.10	48.00
8	11590.00	43.8 AV	54.0	-10.2	1.10 V	224	-4.20	48.00

- REMARKS:**
1. Emission level (dBuV/m) = Raw Value (dBuV) + Correction Factor (dB/m).
 2. Correction Factor (dB/m) = Antenna Factor (dB/m) + Cable Factor (dB).
 3. The other emission levels were very low against the limit.
 4. Margin value = Emission level – Limit value.
 5. “ * “: Fundamental frequency.
 6. The limit value is defined as per 15.247.
 7. "#":The radiated frequency is out the restricted band.



A D T

BELOW 1GHz WORST-CASE DATA : 802.11n (20MHz)

EUT TEST CONDITION		MEASUREMENT DETAIL	
CHANNEL	Channel 157	FREQUENCY RANGE	Below 1000MHz
INPUT POWER (SYSTEM)	120Vac, 60 Hz	DETECTOR FUNCTION	Quasi-Peak
ENVIRONMENTAL CONDITIONS	22deg. C, 61%RH 1010 hPa	TESTED BY	Chad Lee
TEST MODE	A		

ANTENNA POLARITY & TEST DISTANCE: HORIZONTAL AT 3 M								
NO.	FREQ. (MHz)	EMISSION LEVEL (dBuV/m)	LIMIT (dBuV/m)	MARGIN (dB)	ANTENNA HEIGHT (m)	TABLE ANGLE (Degree)	RAW VALUE (dBuV)	CORRECTION FACTOR (dB/m)
1	41.57	24.3 QP	40.0	-15.7	1.50 H	349	9.80	14.50
2	134.89	30.0 QP	43.5	-13.5	2.00 H	91	16.20	13.80
3	624.85	30.3 QP	46.0	-15.7	1.50 H	61	7.40	22.90
4	799.84	30.4 QP	46.0	-15.6	1.00 H	283	5.10	25.30
5	875.67	30.6 QP	46.0	-15.4	1.50 H	52	4.00	26.60
6	930.11	31.8 QP	46.0	-14.2	1.50 H	10	4.50	27.30
ANTENNA POLARITY & TEST DISTANCE: VERTICAL AT 3 M								
NO.	FREQ. (MHz)	EMISSION LEVEL (dBuV/m)	LIMIT (dBuV/m)	MARGIN (dB)	ANTENNA HEIGHT (m)	TABLE ANGLE (Degree)	RAW VALUE (dBuV)	CORRECTION FACTOR (dB/m)
1	43.51	34.5 QP	40.0	-5.5	1.50 V	178	20.00	14.50
2	132.95	39.4 QP	43.5	-4.1	1.00 V	10	25.80	13.60
3	809.56	34.1 QP	46.0	-11.9	1.50 V	349	8.70	25.40
4	875.67	34.0 QP	46.0	-12.0	1.50 V	355	7.40	26.60
5	902.89	36.1 QP	46.0	-9.9	1.50 V	328	9.10	27.00
6	959.27	39.1 QP	46.0	-6.9	1.50 V	358	11.40	27.70

- REMARKS:**
1. Emission level (dBuV/m) = Raw Value (dBuV) + Correction Factor (dB/m).
 2. Correction Factor (dB/m) = Antenna Factor (dB/m) + Cable Factor (dB).
 3. The other emission levels were very low against the limit.
 4. Margin value = Emission level – Limit value.



A D T

EUT TEST CONDITION		MEASUREMENT DETAIL	
CHANNEL	Channel 157	FREQUENCY RANGE	Below 1000MHz
INPUT POWER (SYSTEM)	120Vac, 60 Hz	DETECTOR FUNCTION	Quasi-Peak
ENVIRONMENTAL CONDITIONS	22deg. C, 61%RH 1010 hPa	TESTED BY	Chad Lee
TEST MODE	B		

ANTENNA POLARITY & TEST DISTANCE: HORIZONTAL AT 3 M								
NO.	FREQ. (MHz)	EMISSION LEVEL (dBuV/m)	LIMIT (dBuV/m)	MARGIN (dB)	ANTENNA HEIGHT (m)	TABLE ANGLE (Degree)	RAW VALUE (dBuV)	CORRECTION FACTOR (dB/m)
1	86.28	24.8 QP	40.0	-15.2	2.00 H	250	15.90	8.90
2	214.61	28.8 QP	43.5	-14.7	1.00 H	82	17.60	11.20
3	599.58	30.2 QP	46.0	-15.8	1.50 H	10	7.70	22.50
4	875.67	30.3 QP	46.0	-15.7	1.50 H	67	3.70	26.60
5	897.05	32.5 QP	46.0	-13.5	2.00 H	232	5.60	26.90
6	935.94	32.0 QP	46.0	-14.0	1.50 H	13	4.60	27.40
ANTENNA POLARITY & TEST DISTANCE: VERTICAL AT 3 M								
NO.	FREQ. (MHz)	EMISSION LEVEL (dBuV/m)	LIMIT (dBuV/m)	MARGIN (dB)	ANTENNA HEIGHT (m)	TABLE ANGLE (Degree)	RAW VALUE (dBuV)	CORRECTION FACTOR (dB/m)
1	35.73	36.1 QP	40.0	-3.9	1.50 V	124	23.40	12.70
2	533.47	33.5 QP	46.0	-12.5	1.50 V	10	12.50	21.00
3	640.41	34.1 QP	46.0	-11.9	1.00 V	337	10.90	23.20
4	819.28	31.4 QP	46.0	-14.6	2.00 V	331	5.80	25.60
5	908.72	39.4 QP	46.0	-6.6	1.00 V	10	12.30	27.10
6	961.21	43.1 QP	54.0	-10.9	1.00 V	337	15.40	27.70

- REMARKS:**
1. Emission level (dBuV/m) = Raw Value (dBuV) + Correction Factor (dB/m).
 2. Correction Factor (dB/m) = Antenna Factor (dB/m) + Cable Factor (dB).
 3. The other emission levels were very low against the limit.
 4. Margin value = Emission level – Limit value.



5.2 CONDUCTED EMISSION MEASUREMENT

5.2.1 LIMITS OF CONDUCTED EMISSION MEASUREMENT

FREQUENCY OF EMISSION (MHz)	CONDUCTED LIMIT (dBµV)	
	Quasi-peak	Average
0.15 ~ 0.5	66 to 56	56 to 46
0.5 ~ 5	56	46
5 ~ 30	60	50

- NOTE:** 1. The lower limit shall apply at the transition frequencies.
 2. The limit decreases in line with the logarithm of the frequency in the range of 0.15 to 0.50MHz.
 3. All emanations from a class A/B digital device or system, including any network of conductors and apparatus connected thereto, shall not exceed the level of field strengths specified above.

5.2.2 TEST INSTRUMENTS

DESCRIPTION & MANUFACTURER	MODEL NO.	SERIAL NO.	DATE OF CALIBRATION	DUE DATE OF CALIBRATION
Test Receiver ROHDE & SCHWARZ	ESCS30	100291	Nov. 30, 2010	Nov. 29, 2011
RF signal cable Woken	5D-FB	Cable-HYC01-01	Dec. 30, 2010	Dec. 29, 2011
LISN ROHDE & SCHWARZ	ESH2-Z5	100100	Jan. 06, 2011	Jan. 05, 2012
LISN ROHDE & SCHWARZ	ESH3-Z5	835239/001	Feb. 22, 2011	Feb. 21, 2012
V-LISN SCHWARZBECK	NNBL 8226-2	8226-142	Jul. 12, 2010	Jul. 11, 2011
LISN ROHDE & SCHWARZ	ENV216	100072	Jun. 10, 2011	Jun. 09, 2012
Software ADT	ADT_Cond_ V7.3.7	NA	NA	NA

- NOTE:** 1. The calibration interval of the above test instruments is 12 months and the calibrations are traceable to NML/ROC and NIST/USA.
 2. The test was performed in HwaYa Shielded Room 1.
 3. The VCCI Site Registration No. is C-2040.



A D T

5.2.3 TEST PROCEDURES

- a. The EUT was placed 0.4 meters from the conducting wall of the shielded room with EUT being connected to the power mains through a line impedance stabilization network (LISN). Other support units were connected to the power mains through another LISN. The two LISNs provide 50 ohm/ 50uH of coupling impedance for the measuring instrument.
- b. Both lines of the power mains connected to the EUT were checked for maximum conducted interference.
- c. The frequency range from 150kHz to 30MHz was searched. Emission levels under (Limit - 20dB) was not recorded.

NOTE: All modes of operation were investigated and the worst-case emissions are reported.

5.2.4 DEVIATION FROM TEST STANDARD

No deviation.

5.2.5 TEST SETUP

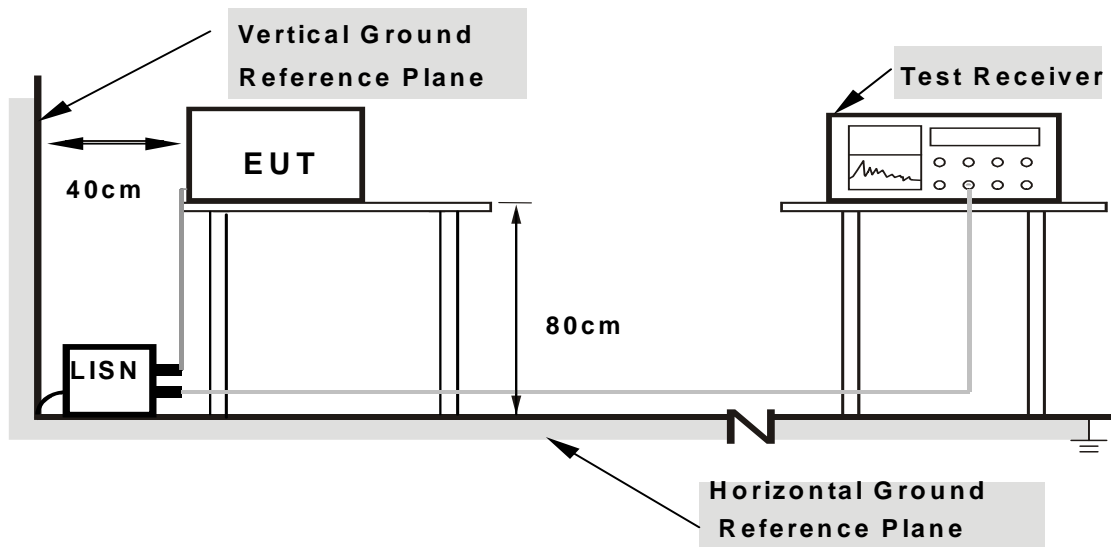

- Note:**
1. Support units were connected to second LISN.
 2. Both of LISNs (AMN) are 80 cm from EUT and at least 80 from other units and other metal planes

For the actual test configuration, please refer to the attached file (Test Setup Photo).

5.2.6 EUT OPERATING CONDITIONS

Same as 4.1.6.

5.2.7 TEST RESULTS

CONDUCTED WORST-CASE DATA : 802.11a

PHASE	Line 1	6dB BANDWIDTH	9kHz
TEST MODE	A		

No	Freq. [MHz]	Corr. Factor (dB)	Reading Value		Emission Level		Limit		Margin	
			[dB (uV)]		[dB (uV)]		[dB (uV)]		(dB)	
			Q.P.	AV.	Q.P.	AV.	Q.P.	AV.	Q.P.	AV.
1	0.158	0.14	58.21	34.48	58.35	34.62	65.58	55.58	-7.22	-20.95
2	0.173	0.14	56.77	32.66	56.91	32.80	64.79	54.79	-7.88	-21.99
3	0.201	0.14	54.08	25.60	54.22	25.74	63.58	53.58	-9.36	-27.84
4	0.220	0.14	53.11	28.30	53.25	28.44	62.81	52.81	-9.56	-24.37
5	0.248	0.14	51.03	-	51.17	-	61.84	51.84	-10.66	-
6	0.322	0.15	43.80	-	43.95	-	59.66	49.66	-15.71	-

- REMARKS:**
1. Q.P. and AV. are abbreviations of quasi-peak and average individually.
 2. "-": The Quasi-peak reading value also meets average limit and measurement with the average detector is unnecessary.
 3. The emission levels of other frequencies were very low against the limit.
 4. Margin value = Emission level - Limit value
 5. Correction factor = Insertion loss + Cable loss
 6. Emission Level = Correction Factor + Reading Value.

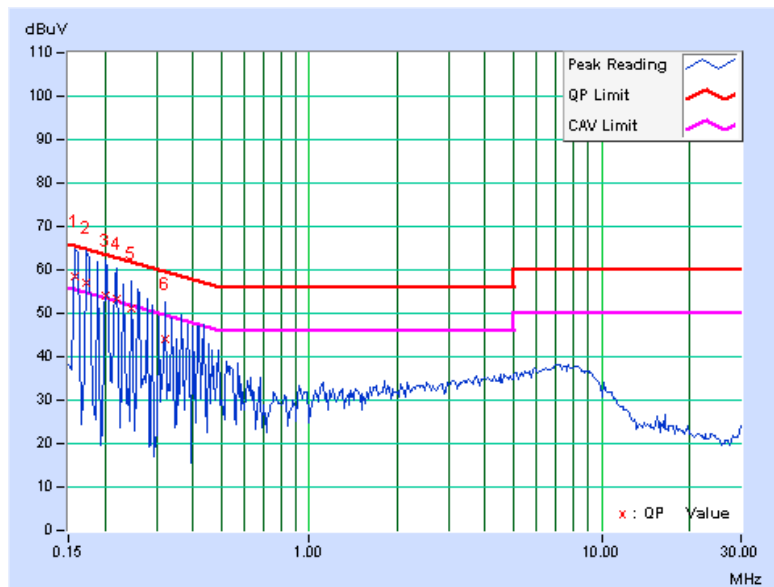



A D T

PHASE	Line 2	6dB BANDWIDTH	9kHz
TEST MODE	A		

No	Freq. [MHz]	Corr. Factor (dB)	Reading Value		Emission Level		Limit		Margin	
			[dB (uV)]		[dB (uV)]		[dB (uV)]		(dB)	
			Q.P.	AV.	Q.P.	AV.	Q.P.	AV.	Q.P.	AV.
1	0.162	0.13	57.71	34.32	57.84	34.45	65.38	55.38	-7.54	-20.93
2	0.177	0.13	53.31	-	53.44	-	64.61	54.61	-11.17	-
3	0.216	0.13	47.35	-	47.48	-	62.96	52.96	-15.47	-
4	0.279	0.13	42.27	-	42.40	-	60.85	50.85	-18.44	-
5	0.338	0.14	42.42	-	42.56	-	59.26	49.26	-16.71	-
6	0.470	0.14	31.48	-	31.62	-	56.51	46.51	-24.88	-

- REMARKS:**
1. Q.P. and AV. are abbreviations of quasi-peak and average individually.
 2. "-": The Quasi-peak reading value also meets average limit and measurement with the average detector is unnecessary.
 3. The emission levels of other frequencies were very low against the limit.
 4. Margin value = Emission level - Limit value
 5. Correction factor = Insertion loss + Cable loss
 6. Emission Level = Correction Factor + Reading Value.

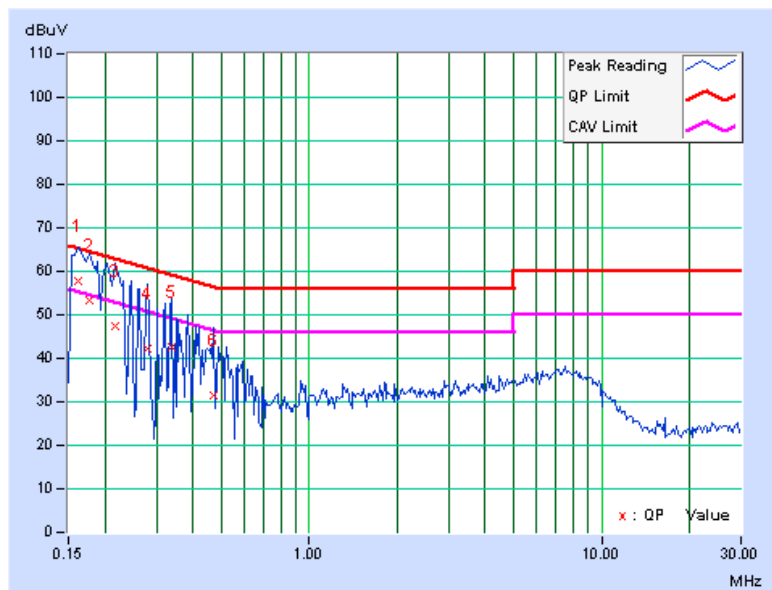

PHASE	Line 1	6dB BANDWIDTH	9kHz
TEST MODE	B		

No	Freq. [MHz]	Corr. Factor (dB)	Reading Value [dB (uV)]		Emission Level [dB (uV)]		Limit [dB (uV)]		Margin (dB)	
			Q.P.	AV.	Q.P.	AV.	Q.P.	AV.	Q.P.	AV.
1	0.158	0.14	47.77	-	47.91	-	65.58	55.58	-17.66	-
2	0.209	0.14	40.87	-	41.01	-	63.26	53.26	-22.25	-
3	0.400	0.15	44.75	-	44.90	-	57.85	47.85	-12.95	-
4	0.451	0.15	39.16	-	39.31	-	56.86	46.86	-17.55	-
5	0.666	0.17	36.54	-	36.71	-	56.00	46.00	-19.29	-
6	22.672	1.71	33.44	-	35.15	-	60.00	50.00	-24.85	-

- REMARKS:**
1. Q.P. and AV. are abbreviations of quasi-peak and average individually.
 2. "-": The Quasi-peak reading value also meets average limit and measurement with the average detector is unnecessary.
 3. The emission levels of other frequencies were very low against the limit.
 4. Margin value = Emission level - Limit value
 5. Correction factor = Insertion loss + Cable loss
 6. Emission Level = Correction Factor + Reading Value.

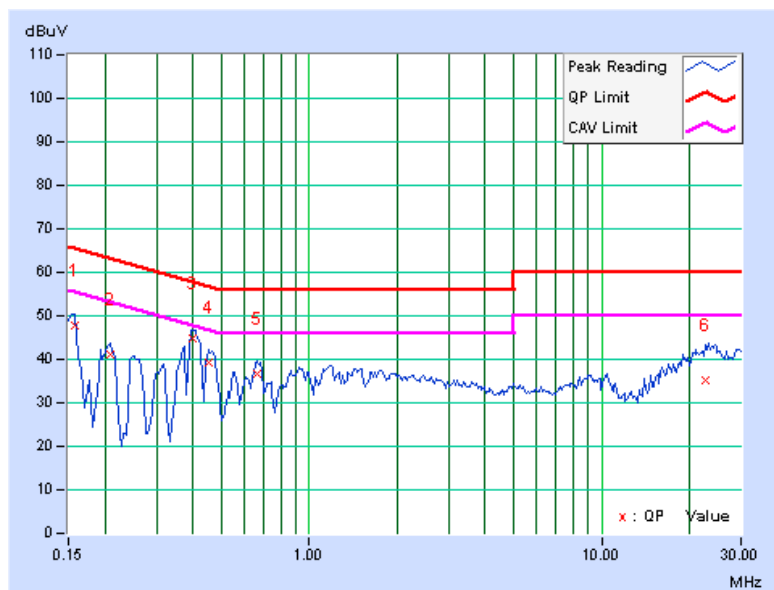



A D T

PHASE	Line 2	6dB BANDWIDTH	9kHz
TEST MODE	B		

No	Freq. [MHz]	Corr. Factor (dB)	Reading Value		Emission Level		Limit		Margin	
			[dB (uV)]		[dB (uV)]		[dB (uV)]		(dB)	
			Q.P.	AV.	Q.P.	AV.	Q.P.	AV.	Q.P.	AV.
1	0.154	0.13	48.20	-	48.33	-	65.79	55.79	-17.46	-
2	0.201	0.13	40.53	-	40.66	-	63.58	53.58	-22.92	-
3	0.412	0.14	43.21	-	43.35	-	57.61	47.61	-14.26	-
4	1.172	0.19	33.97	-	34.16	-	56.00	46.00	-21.84	-
5	8.594	0.63	30.74	-	31.37	-	60.00	50.00	-28.63	-
6	23.727	1.58	35.18	-	36.76	-	60.00	50.00	-23.24	-

- REMARKS:**
1. Q.P. and AV. are abbreviations of quasi-peak and average individually.
 2. "-": The Quasi-peak reading value also meets average limit and measurement with the average detector is unnecessary.
 3. The emission levels of other frequencies were very low against the limit.
 4. Margin value = Emission level - Limit value
 5. Correction factor = Insertion loss + Cable loss
 6. Emission Level = Correction Factor + Reading Value.

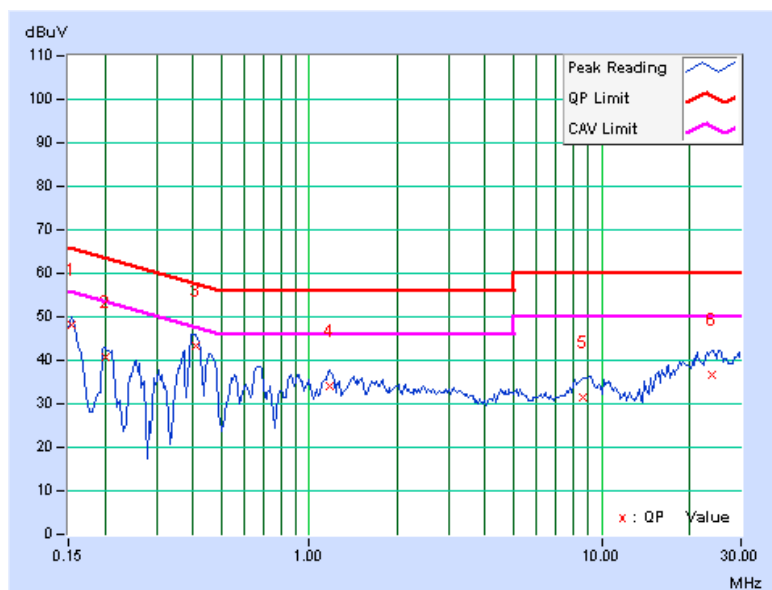



A D T

5.3 6dB BANDWIDTH MEASUREMENT

5.3.1 LIMITS OF 6dB BANDWIDTH MEASUREMENT

The minimum of 6dB Bandwidth Measurement is 0.5MHz.

5.3.2 TEST INSTRUMENTS

DESCRIPTION & MANUFACTURER	MODEL NO.	SERIAL NO.	DATE OF CALIBRATION	DUE DATE OF CALIBRATION
SPECTRUM ANALYZER R&S	FSP40	100040	Jul. 17, 2010	Jul. 16, 2011

NOTE: The calibration interval of the above test instruments is 12 months and the calibrations are traceable to NML/ROC and NIST/USA.

5.3.3 TEST PROCEDURE

The transmitter output was connected to the spectrum analyzer through an attenuator. The bandwidth of the fundamental frequency was measured by spectrum analyzer with 100kHz RBW and 300kHz VBW. The 6dB bandwidth is defined as the total spectrum the power of which is higher than peak power minus 6dB.

5.3.4 DEVIATION FROM TEST STANDARD

No deviation.

5.3.5 TEST SETUP

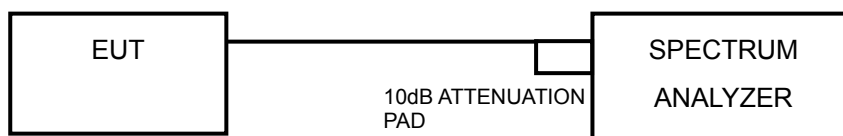

5.3.6 EUT OPERATING CONDITIONS

The software provided by client to enable the EUT under transmission condition continuously at lowest, middle and highest channel frequencies individually.



A D T

5.3.7 TEST RESULTS

802.11a

CHANNEL	CHANNEL FREQUENCY (MHz)	6dB BANDWIDTH (MHz)	MINIMUM LIMIT (MHz)	PASS / FAIL
149	5745	16.37	0.5	PASS
157	5785	16.42	0.5	PASS
165	5825	16.41	0.5	PASS

CH 157

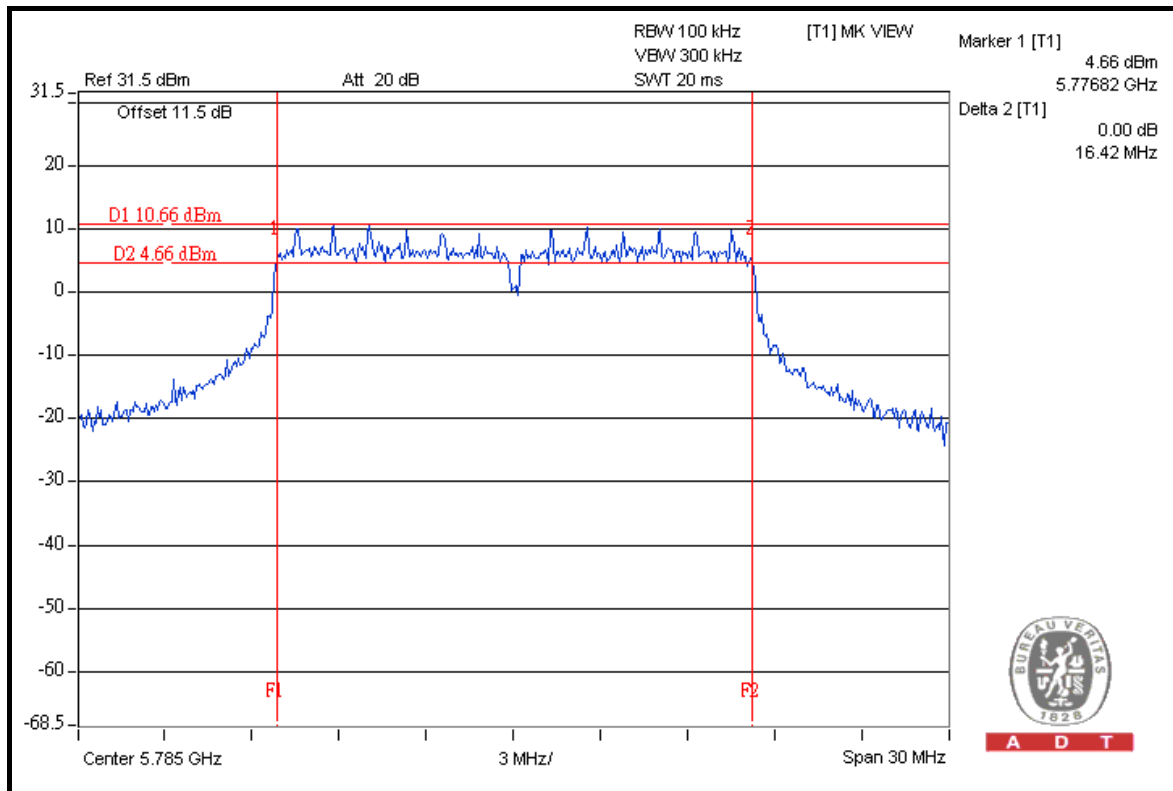



A D T

5.4 MAXIMUM OUTPUT POWER

5.4.1 LIMITS OF MAXIMUM OUTPUT POWER MEASUREMENT

The Maximum Peak Output Power Measurement is 30dBm.

5.4.2 INSTRUMENTS

DESCRIPTION & MANUFACTURER	MODEL NO.	SERIAL NO.	DATE OF CALIBRATION	DUE DATE OF CALIBRATION
High Speed Peak Power Meter	ML2495A	0842014	Apr. 21, 2010	Apr. 20, 2011
Power Sensor	MA2411B	0738404	Apr. 21, 2010	Apr. 20, 2011

NOTE:

1. The calibration interval of the above test instruments is 12 months and the calibrations are traceable to NML/ROC and NIST/USA.
2. Measurement Bandwidth of ML2495A is 65MHz greater than 6dB bandwidth of emission.

5.4.3 TEST PROCEDURES

A power sensor was used on the output port of the EUT. A power meter was used to read the response of the power sensor. Record the power level.

5.4.4 DEVIATION FROM TEST STANDARD

No deviation.

5.4.5 TEST SETUP

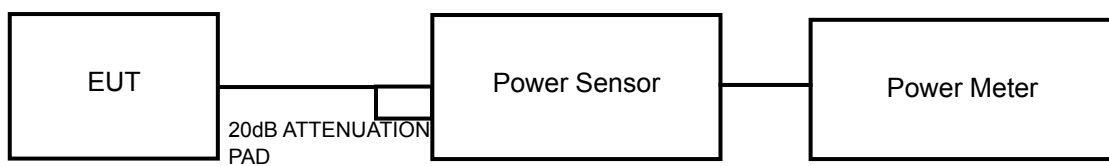

5.4.6 EUT OPERATING CONDITIONS

Same as Item 5.3.6.



5.4.7 TEST RESULTS

802.11a

CHANNEL	CHANNEL FREQUENCY (MHz)	PEAK POWER OUTPUT (mW)	PEAK POWER OUTPUT (dBm)	PEAK POWER LIMIT (dBm)	PASS/FAIL
149	5745	691.8	28.4	30	PASS
157	5785	537.0	27.3	30	PASS
165	5825	562.3	27.5	30	PASS

802.11n (20MHz)

CHAN.	CHAN. FREQ. (MHz)	POWER OUTPUT (dBm)			TOTAL POWER (mW)	TOTAL POWER (dBm)	POWER LIMIT (dBm)	PASS / FAIL
		CHAIN 0	CHAIN 1	CHAIN 2				
149	5745	24.3	23.6	24.4	773.7	28.9	30	PASS
157	5785	24.5	24.6	24.2	833.3	29.2	30	PASS
165	5825	23.4	24.2	22.7	668.0	28.2	30	PASS

802.11n (40MHz)

CHAN.	CHAN. FREQ. (MHz)	POWER OUTPUT (dBm)			TOTAL POWER (mW)	TOTAL POWER (dBm)	POWER LIMIT (dBm)	PASS / FAIL
		CHAIN 0	CHAIN 1	CHAIN 2				
151	5755	24.4	23.9	24.6	809.3	29.1	30	PASS
159	5795	24.5	24.5	23.8	803.6	29.1	30	PASS



A D T

5.5 POWER SPECTRAL DENSITY MEASUREMENT

5.5.1 LIMITS OF POWER SPECTRAL DENSITY MEASUREMENT

The Maximum of Power Spectral Density Measurement is 8dBm.

5.5.2 TEST INSTRUMENTS

DESCRIPTION & MANUFACTURER	MODEL NO.	SERIAL NO.	DATE OF CALIBRATION	DUE DATE OF CALIBRATION
SPECTRUM ANALYZER R&S	FSP40	100040	Jul. 17, 2010	Jul. 16, 2011

NOTE: The calibration interval of the above test instruments is 12 months and the calibrations are traceable to NML/ROC and NIST/USA.

5.5.3 TEST PROCEDURE

The transmitter output was connected to the spectrum analyzer through an attenuator, the bandwidth of the fundamental frequency was measured with the spectrum analyzer using 3kHz RBW and 30kHz VBW, set sweep time = span/3kHz. The power spectral density was measured and recorded.

The sweep time is allowed to be longer than span/3kHz for a full response of the mixer in the spectrum analyzer.

Follow method 2 of KDB 662911 D01 Multiple Transmitter Output v01 to calculate total power density of 2 TX port.

5.5.4 DEVIATION FROM TEST STANDARD

No deviation.

5.5.5 TEST SETUP

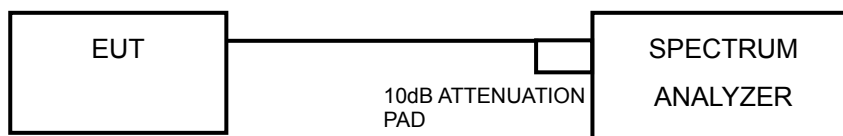

5.5.6 EUT OPERATING CONDITION

Same as Item 5.3.6.



A D T

5.5.7 TEST RESULTS

802.11a

CHANNEL	CHANNEL FREQUENCY (MHz)	RF POWER LEVEL IN 3 kHz BW (dBm)	MAXIMUM LIMIT (dBm)	PASS/FAIL
149	5745	-3.5	8	PASS
157	5785	-4.8	8	PASS
165	5825	-4.5	8	PASS

CH 149

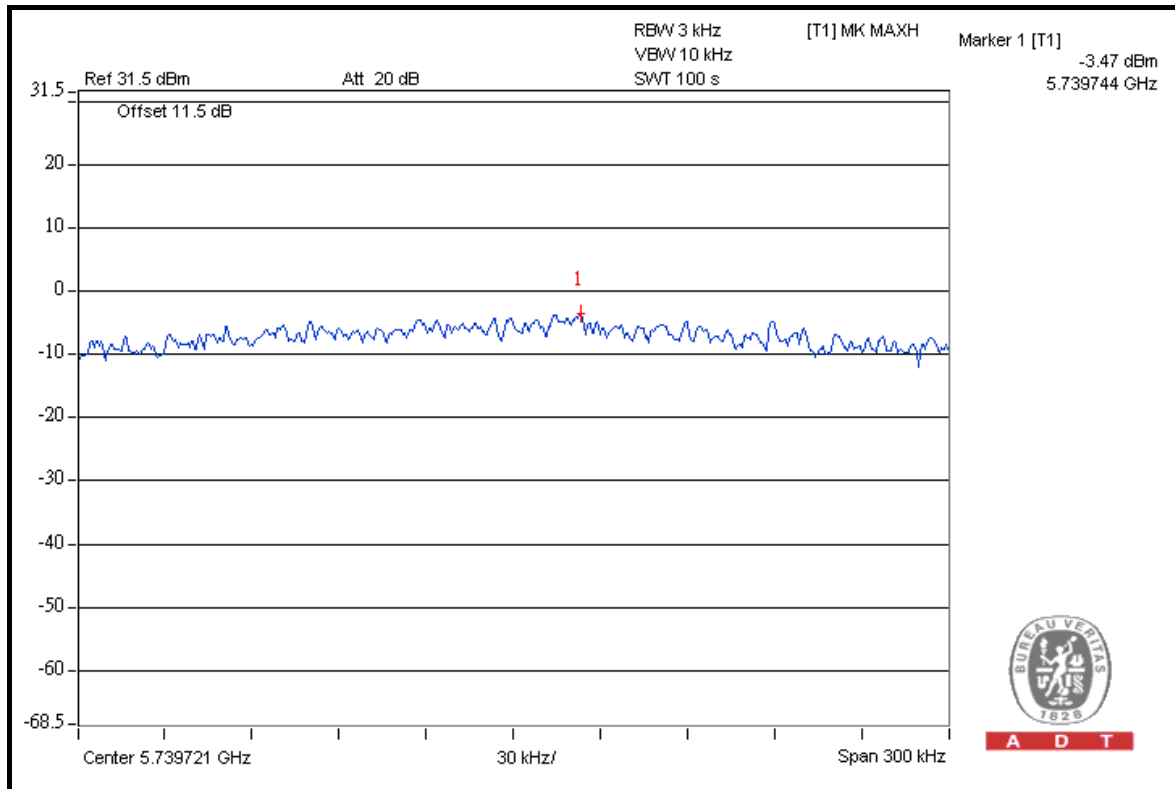



A D T

802.11n (20MHz)

CHAIN	CHAN.	CHAN. FREQ. (MHz)	RF POWER LEVEL IN 3kHz BW (dBm)		TOTAL POWER DENSITY (dBm)	MAX. LIMIT (dBm)	PASS / FAIL
			MEASURED	10 log (N=3) dB			
0	149	5745	-9.1	4.77	-4.3	8	PASS
	157	5785	-9.1	4.77	-4.3	8	PASS
	165	5825	-10.2	4.77	-5.4	8	PASS
1	149	5745	-10.9	4.77	-6.1	8	PASS
	157	5785	-9.7	4.77	-4.9	8	PASS
	165	5825	-10.2	4.77	-5.4	8	PASS
2	149	5745	-9.0	4.77	-4.2	8	PASS
	157	5785	-9.4	4.77	-4.6	8	PASS
	165	5825	-10.9	4.77	-6.1	8	PASS

FOR CHAIN 2: CH 149

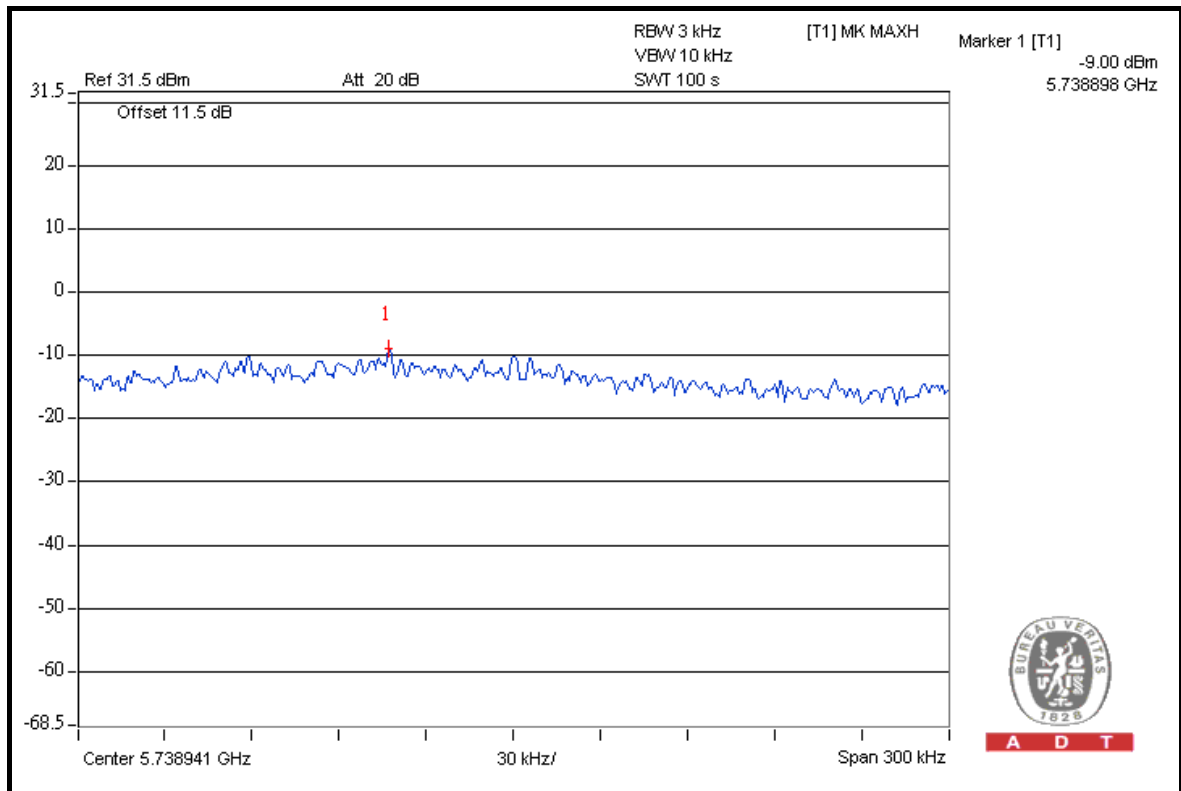

A D T



A D T

802.11n (40MHz)

CHAIN	CHAN.	CHAN. FREQ. (MHz)	RF POWER LEVEL IN 3kHz BW (dBm)		TOTAL POWER DENSITY (dBm)	MAX. LIMIT (dBm)	PASS / FAIL
			MEASURED	10 log (N=3) dB			
0	151	5755	-12.8	4.77	-8.0	8	PASS
	159	5795	-12.6	4.77	-7.8	8	PASS
1	151	5755	-14.4	4.77	-9.6	8	PASS
	159	5795	-13.6	4.77	-8.8	8	PASS
2	151	5755	-12.7	4.77	-7.9	8	PASS
	159	5795	-13.6	4.77	-8.8	8	PASS

FOR CHAIN 0: CH 159

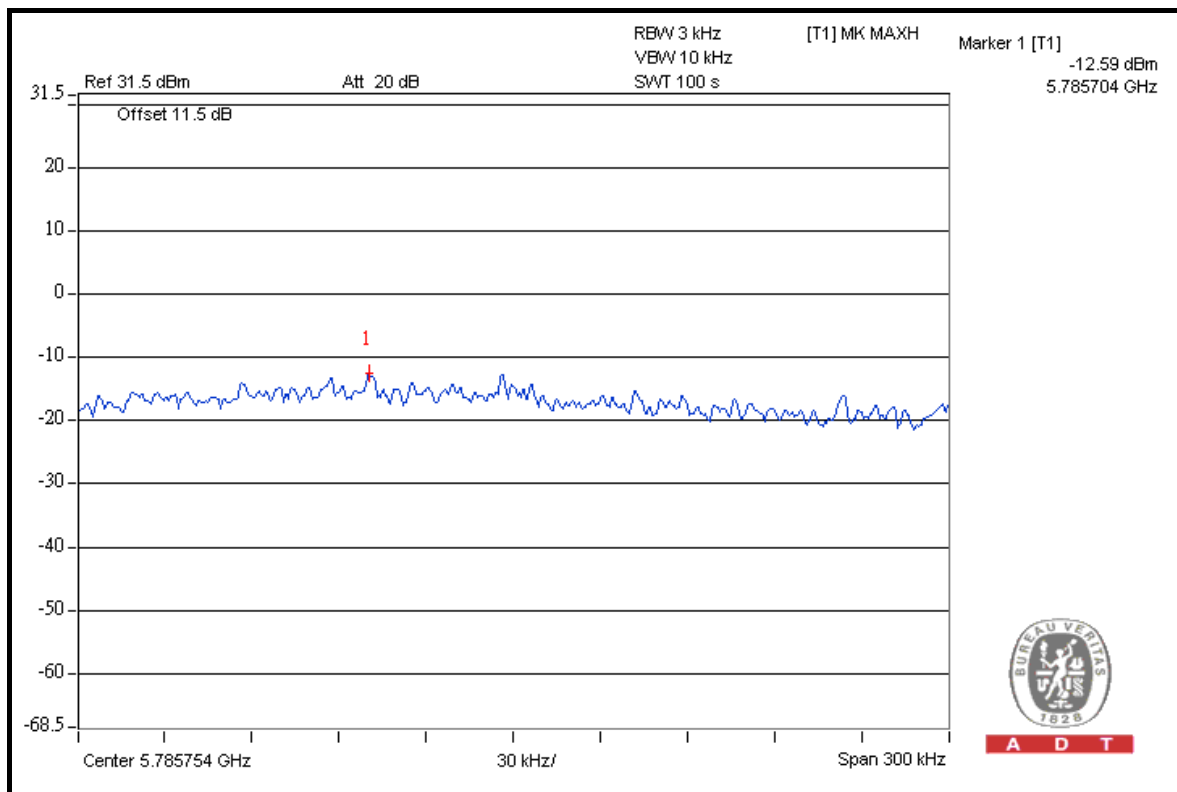

A D T



A D T

5.6 BAND EDGES MEASUREMENT

5.6.1 LIMITS OF BAND EDGES MEASUREMENT

Below -20dB of the highest emission level of operating band (in 100kHz Resolution Bandwidth).

5.6.2 TEST INSTRUMENTS

DESCRIPTION & MANUFACTURER	MODEL NO.	SERIAL NO.	DATE OF CALIBRATION	DUE DATE OF CALIBRATION
FOR CONDUCTED MEASUREMENT				
SPECTRUM ANALYZER R&S	FSP40	100040	Jul. 17, 2010	Jul. 16, 2011
FOR RADIATED MEASUREMENT				
Test Receiver ROHDE & SCHWARZ	ESIB7	100212	Jul. 22, 2010	Jul. 21, 2011
Spectrum Analyzer Agilent	E4446A	MY48250266	Aug. 11, 2010	Aug. 10, 2011
BILOG Antenna SCHWARZBECK	VULB9168	9168-160	Apr. 13, 2011	Apr. 12, 2012
HORN Antenna SCHWARZBECK	9120D	9120D-405	Feb. 08, 2011	Feb. 07, 2012
HORN Antenna SCHWARZBECK	BBHA 9170	BBHA9170243	Dec. 27, 2010	Dec. 26, 2011
Preamplifier Agilent	8447D	2944A10633	Nov. 02, 2010	Nov. 01, 2011
Preamplifier Agilent	8449B	3008A01964	Nov. 02, 2010	Nov. 01, 2011
RF signal cable HUBER+SUHNNER	SUCOFLEX 104	295014/4	Sep 03, 2010	Sep 02, 2011
RF signal cable HUBER+SUHNNER	SUCOFLEX 104	12738/6	Sep 03, 2010	Sep 02, 2011
Software ADT.	ADT_Radiated_V7.6.15.9.2	NA	NA	NA
Antenna Tower inn-co GmbH	MA 4000	013303	NA	NA
Antenna Tower Controller inn-co GmbH	CO2000	017303	NA	NA
Turn Table ADT.	TT100.	TT93021703	NA	NA
Turn Table Controller ADT.	SC100.	SC93021703	NA	NA
26GHz ~ 40GHz Amplifier	EM26400	07026401	Aug. 25, 2010	Aug. 24, 2011

NOTE: The calibration interval of the above test instruments is 12 months and the calibrations are traceable to NML/ROC and NIST/USA.



A D T

5.6.3 TEST PROCEDURE

- a. The EUT was placed on the top of a rotating table 0.8 meters above the ground at a 3 meter semi-anechoic chamber. The table was rotated 360 degrees to determine the position of the highest radiation.
- b. The EUT was set 3 meters away from the interference-receiving antenna, which was mounted on the top of a variable-height antenna tower.
- c. The antenna is a broadband antenna, and its height is varied from one meter to four meters above the ground to determine the maximum value of the field strength. Both horizontal and vertical polarizations of the antenna are set to make the measurement.
- d. For each suspected emission, the EUT was arranged to its worst case and then the antenna was tuned to heights from 1 meter to 4 meters and the rotatable table was turned from 0 degrees to 360 degrees to find the maximum reading.
- e. Set both RBW and VBW of spectrum analyzer to 100kHz and 300kHz with suitable frequency span including 100MHz bandwidth from band edge. The band edges was measured and recorded.

NOTE: The resolution bandwidth of test receiver/spectrum analyzer is 1MHz and the video bandwidth is 10Hz for Average detection (AV) at frequency above 1GHz.



A D T

5.6.4 DEVIATION FROM TEST STANDARD

No deviation.

5.6.5 EUT OPERATING CONDITION

Same as Item 5.3.6.

5.6.6 TEST RESULTS

The spectrum plots are attached on the following pages. D1 line indicates the highest level, D2 line indicates the 20dB offset below D1. It shows compliance with the requirement in part 15.247(d).



A D T

802.11a

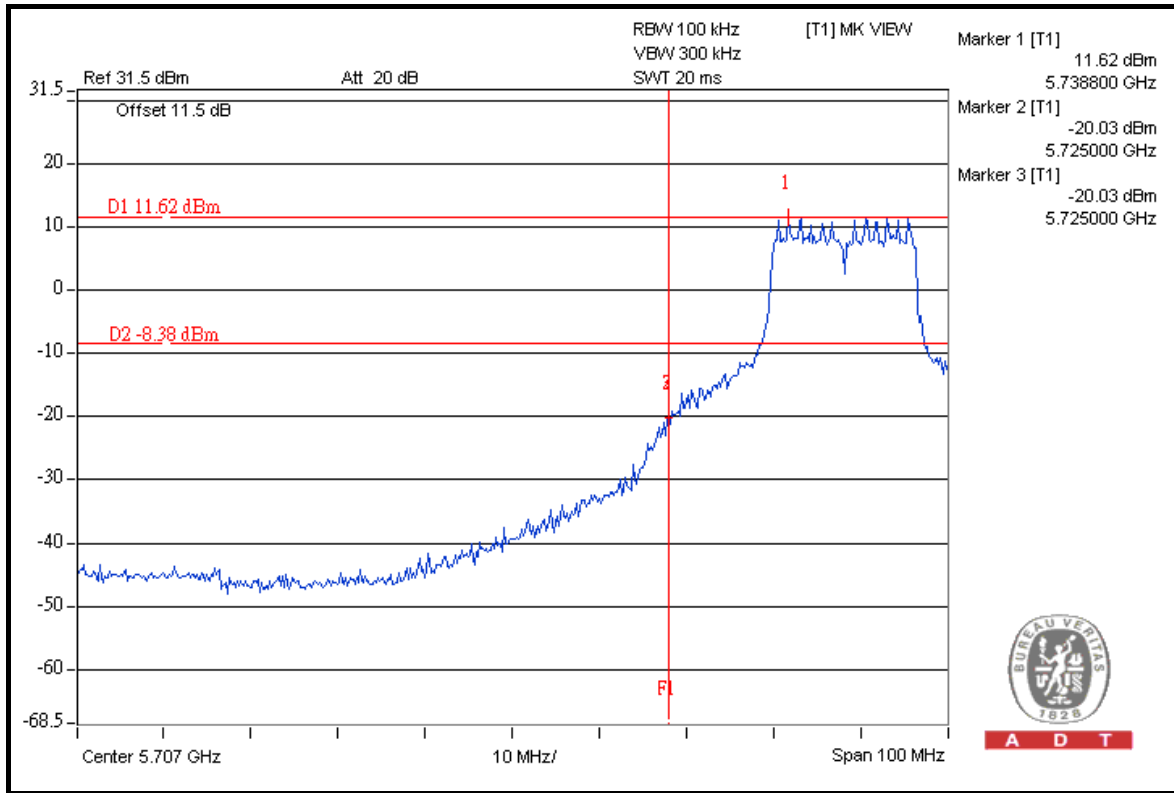

A D T

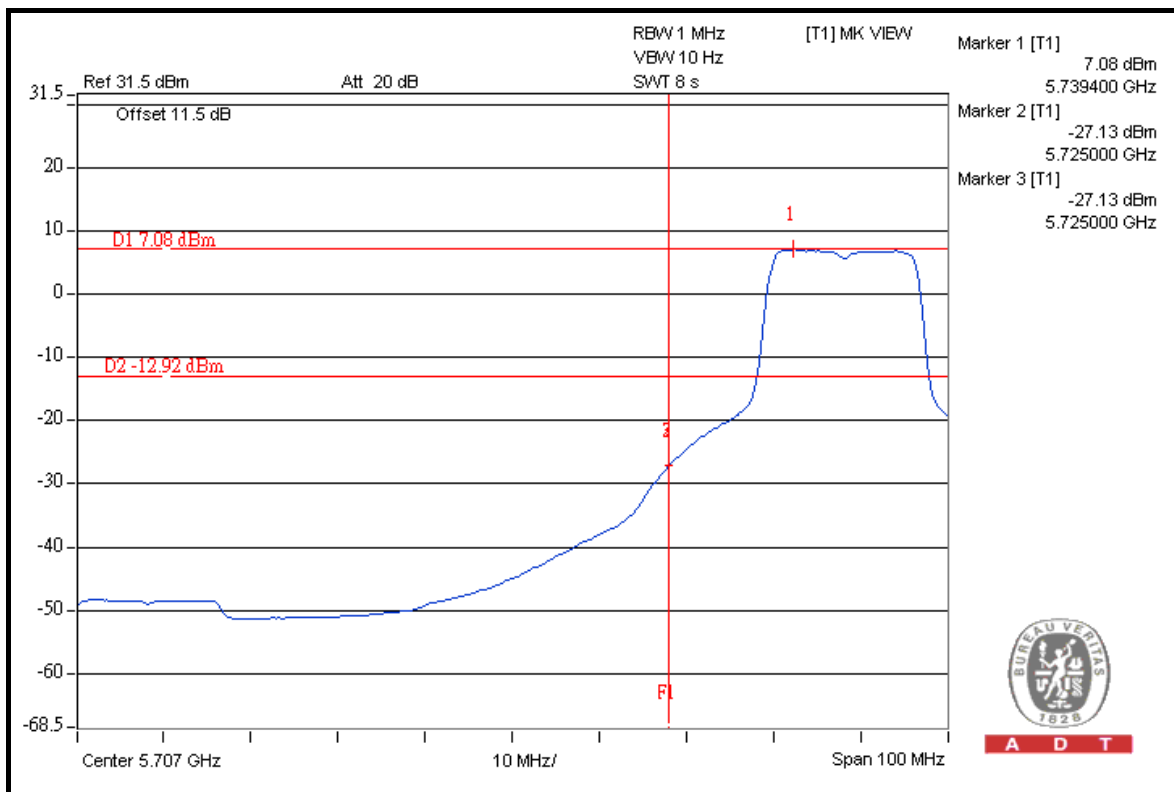

A D T



A D T

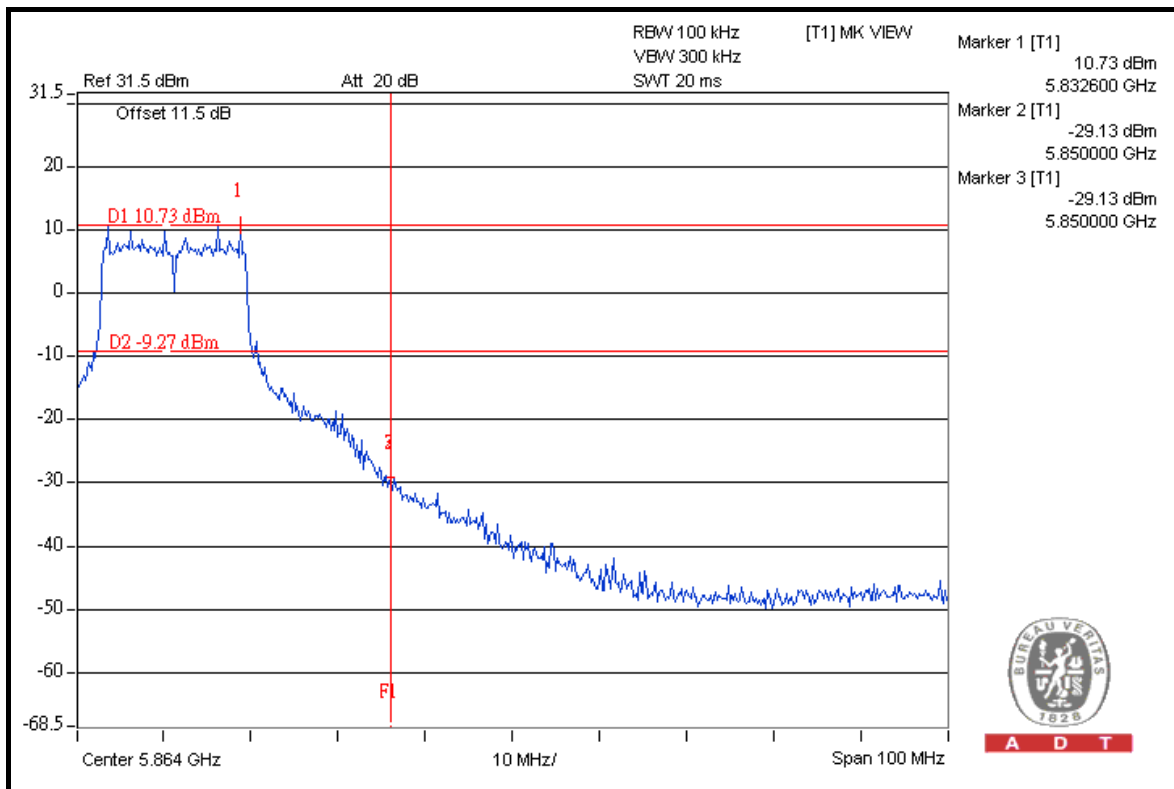
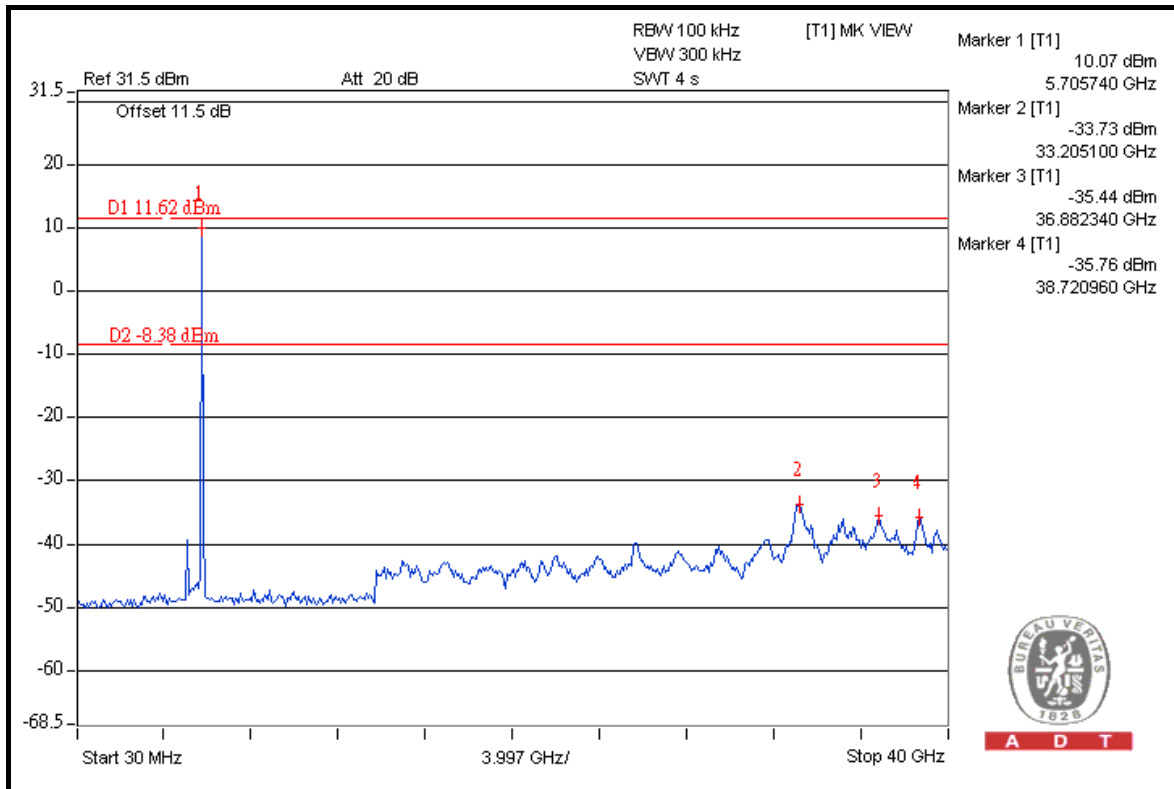



A D T

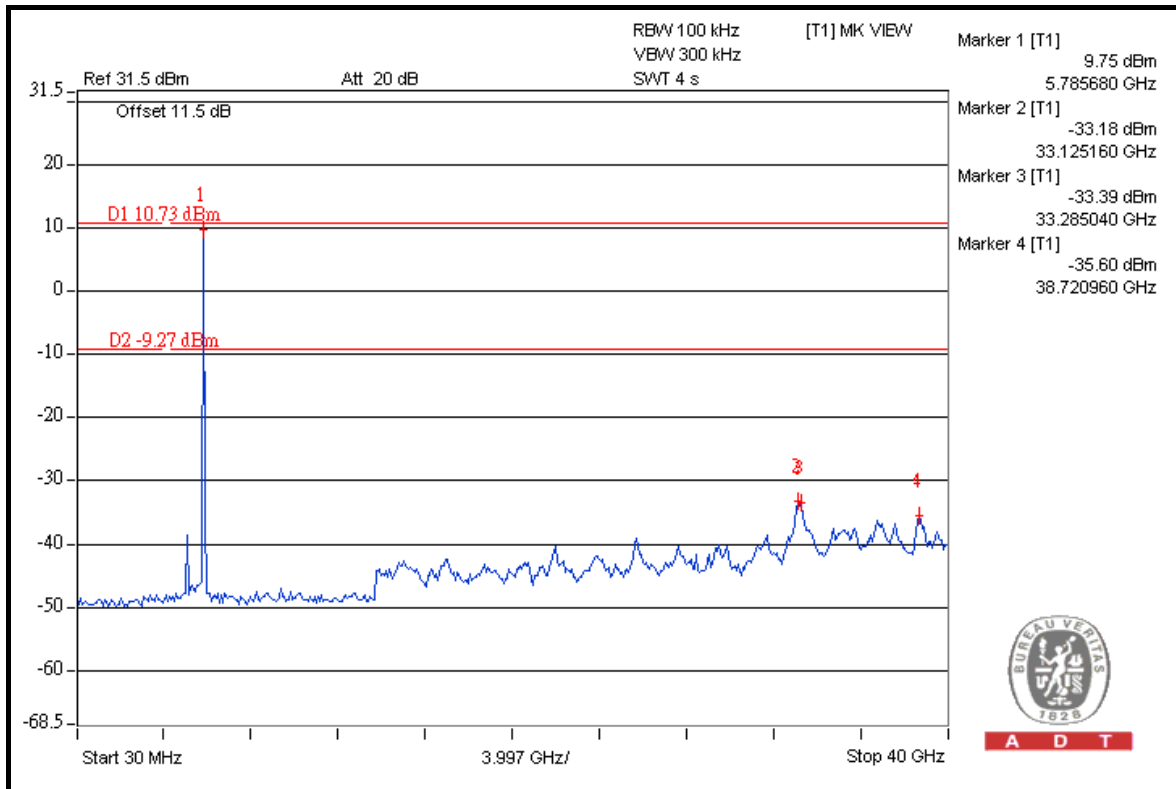
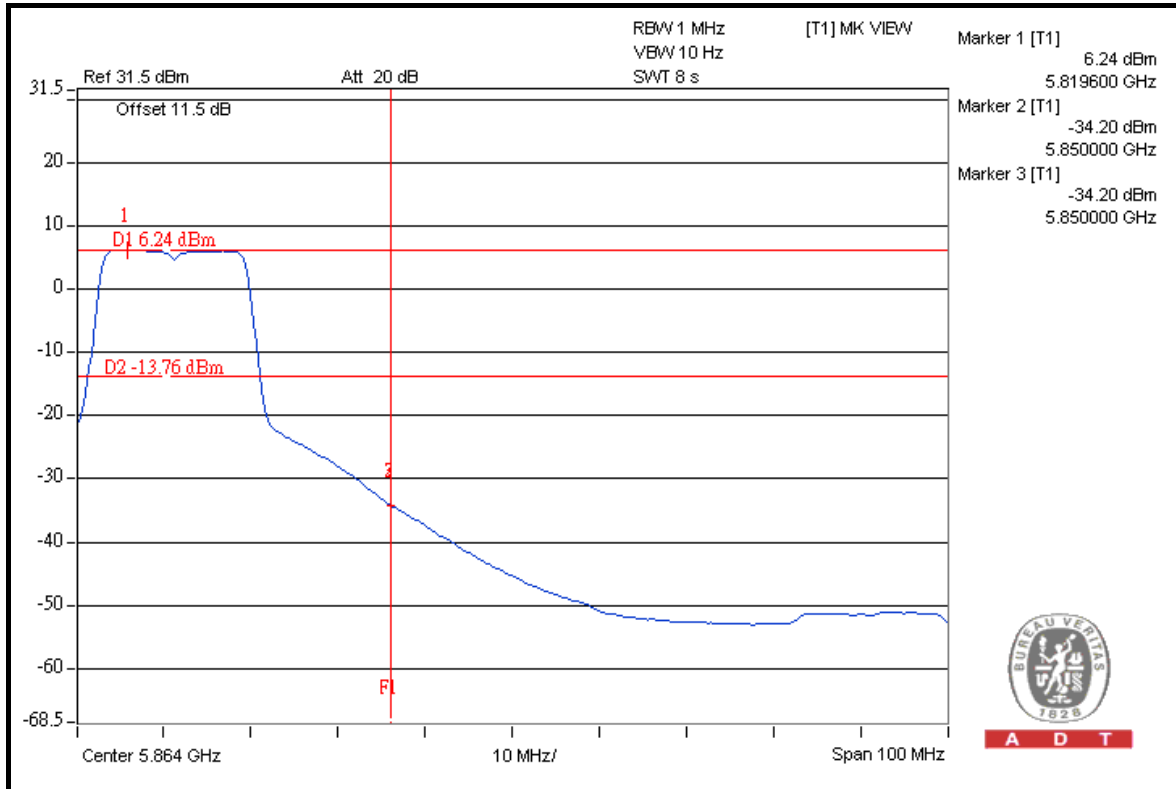



A D T

802.11n (20MHz)

FOR RADIATED MEASURED (THREE CHAINS ON)

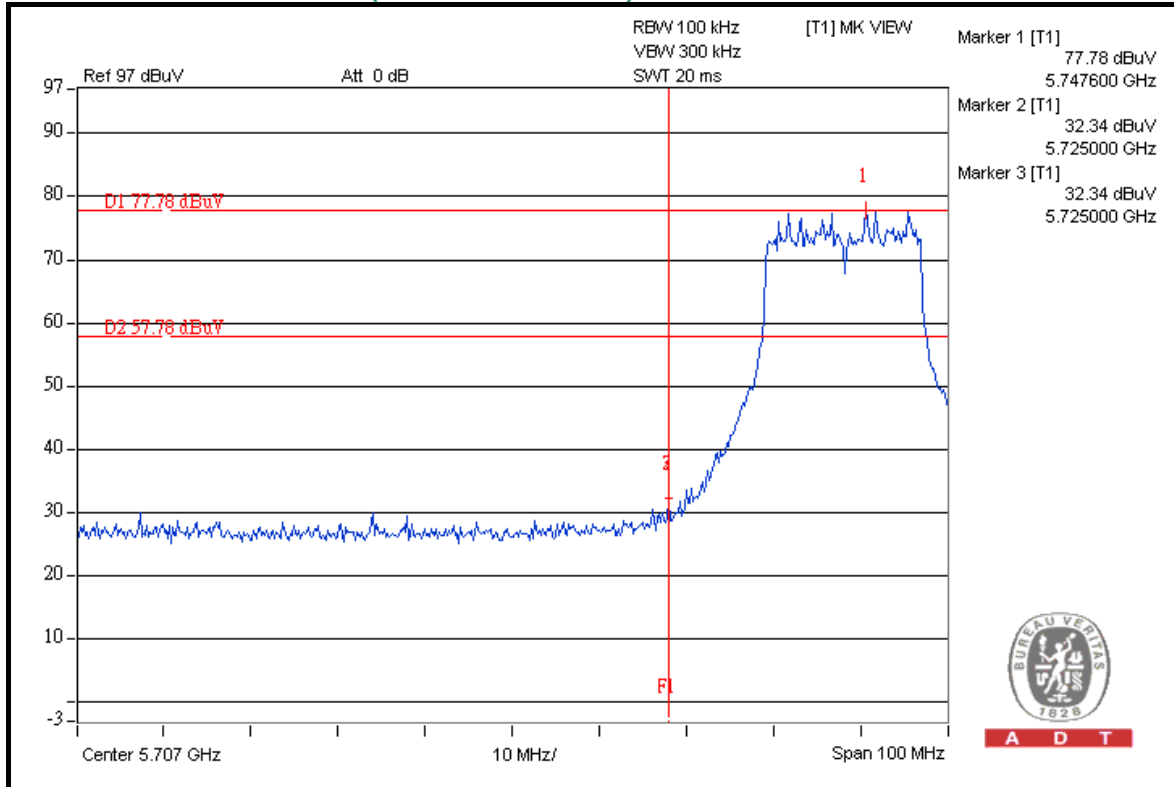

A D T

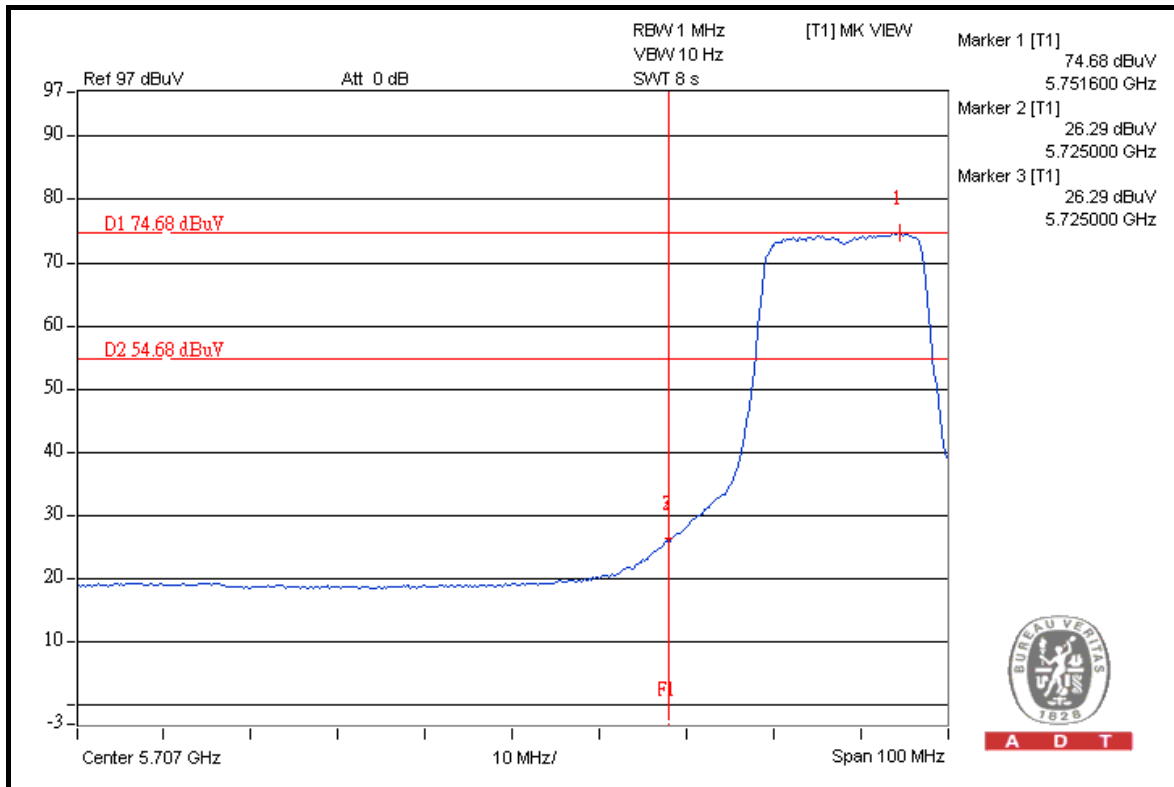

A D T



A D T

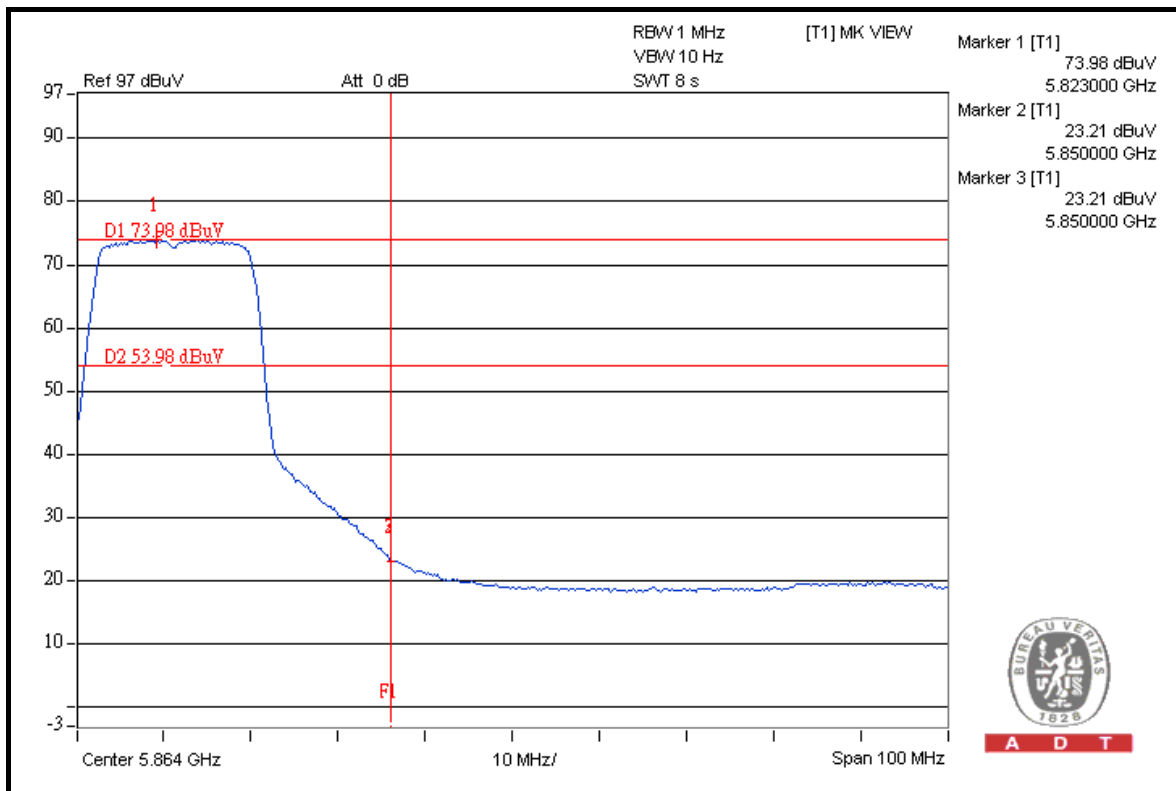
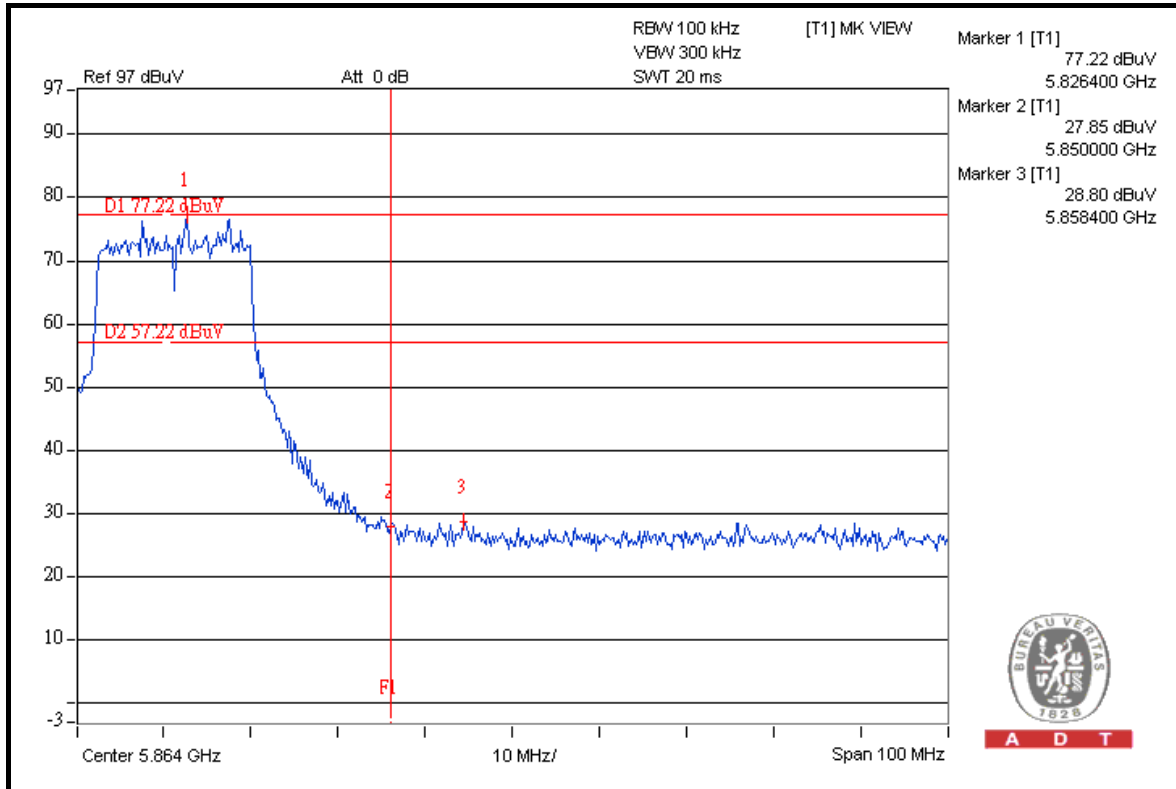



A D T

FOR CONDUCTED MEASURED

CHAIN 0

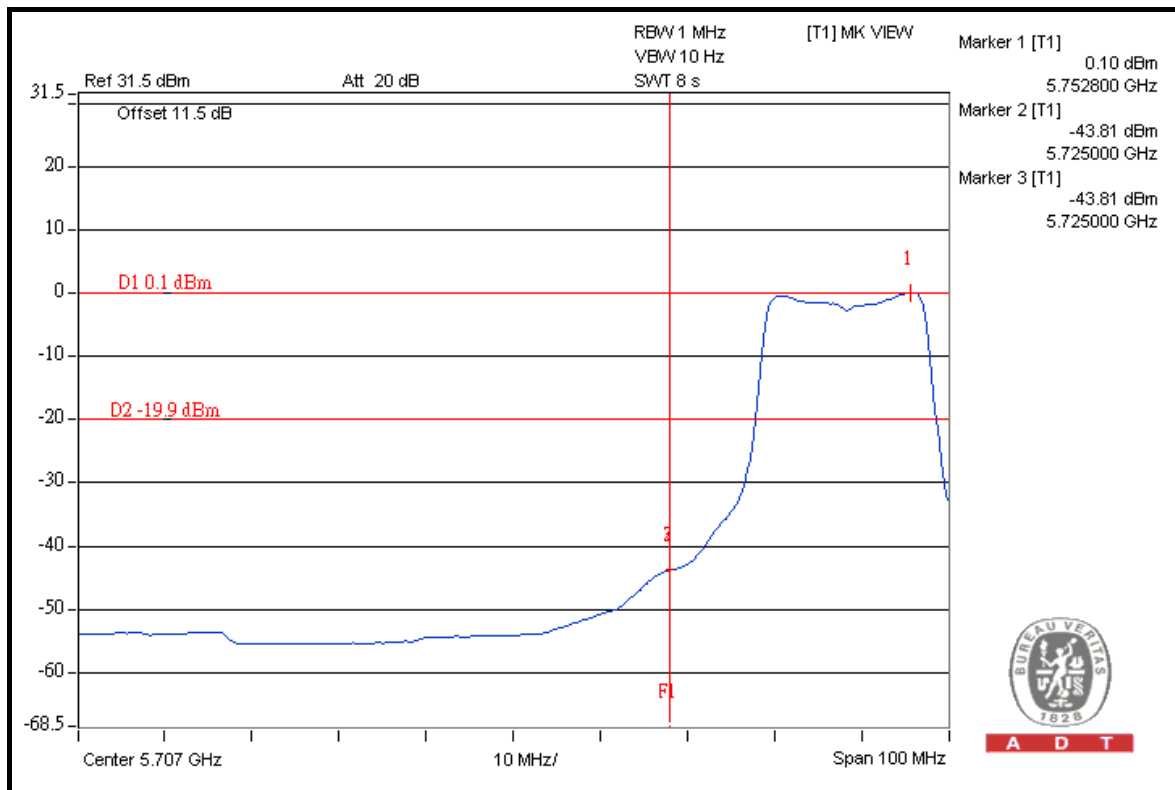
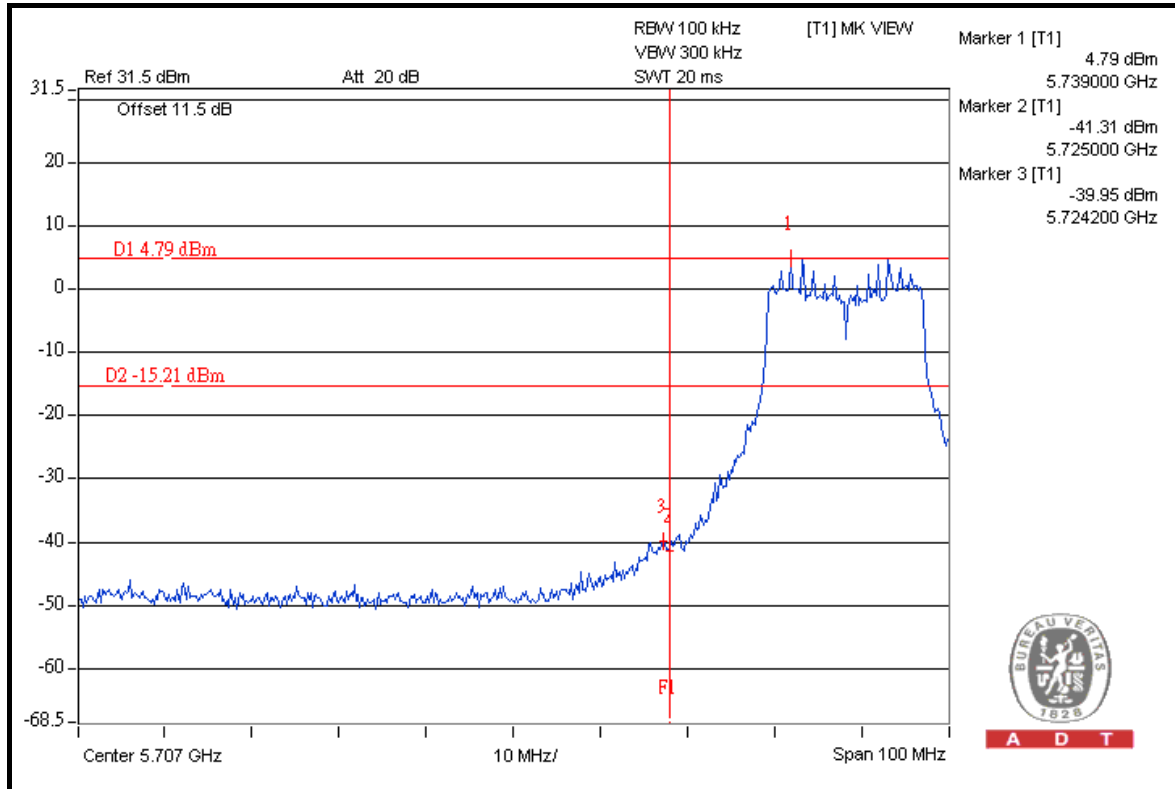



A D T

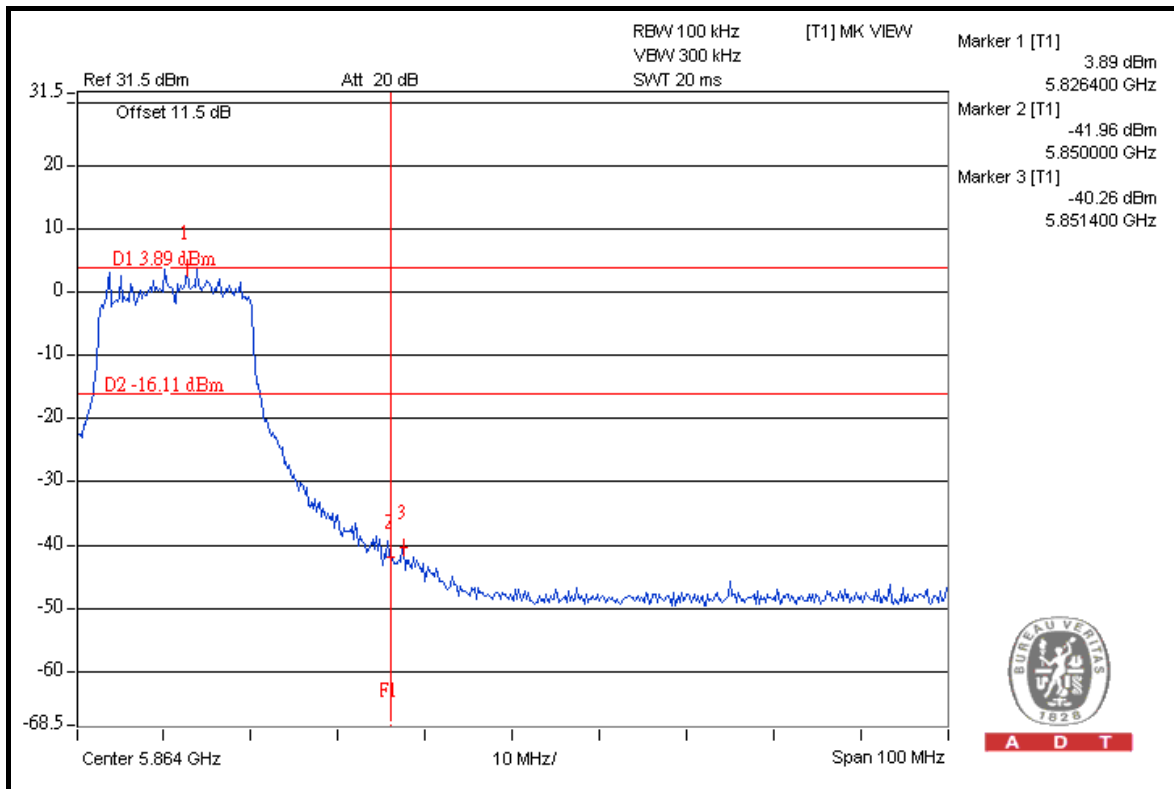
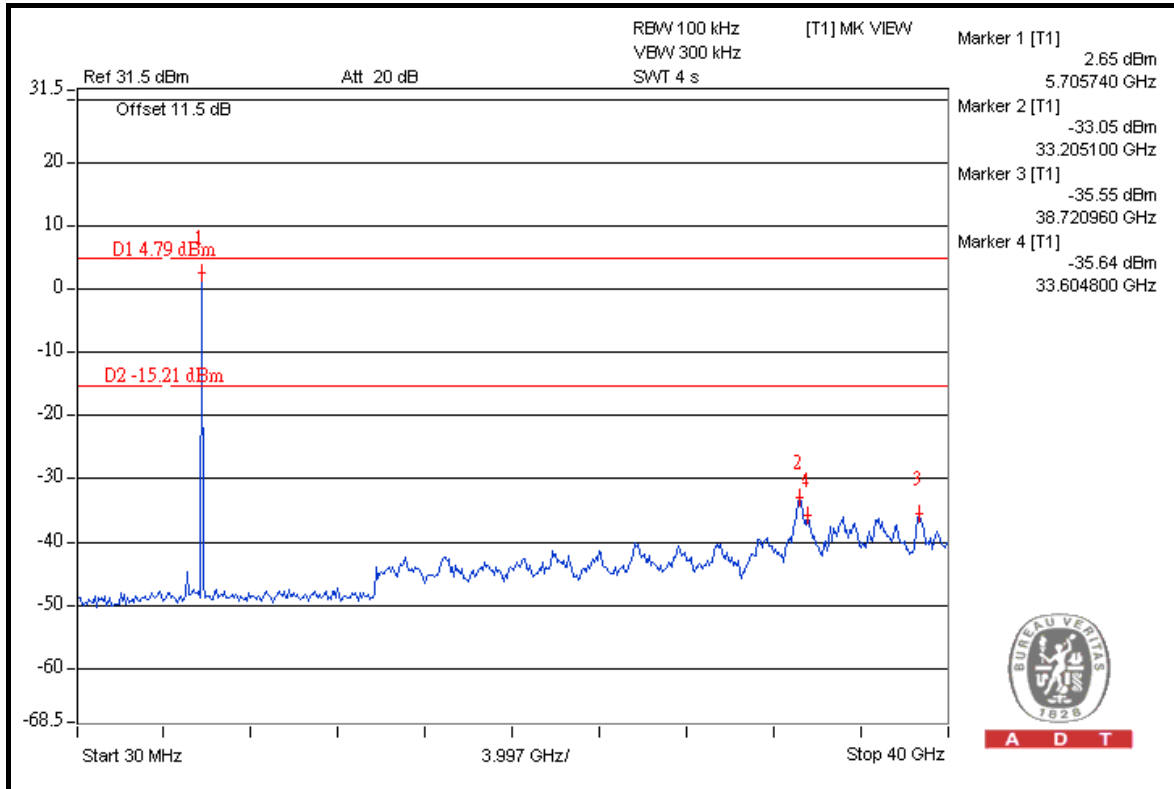



A D T

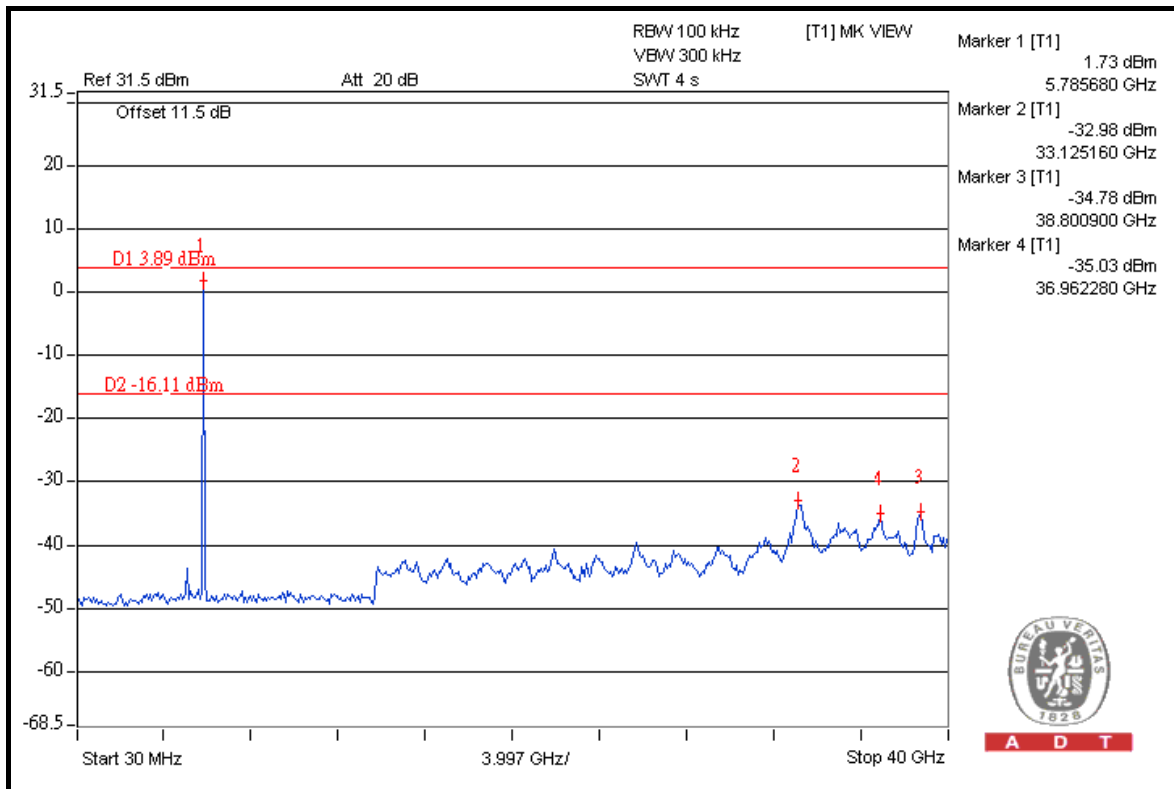
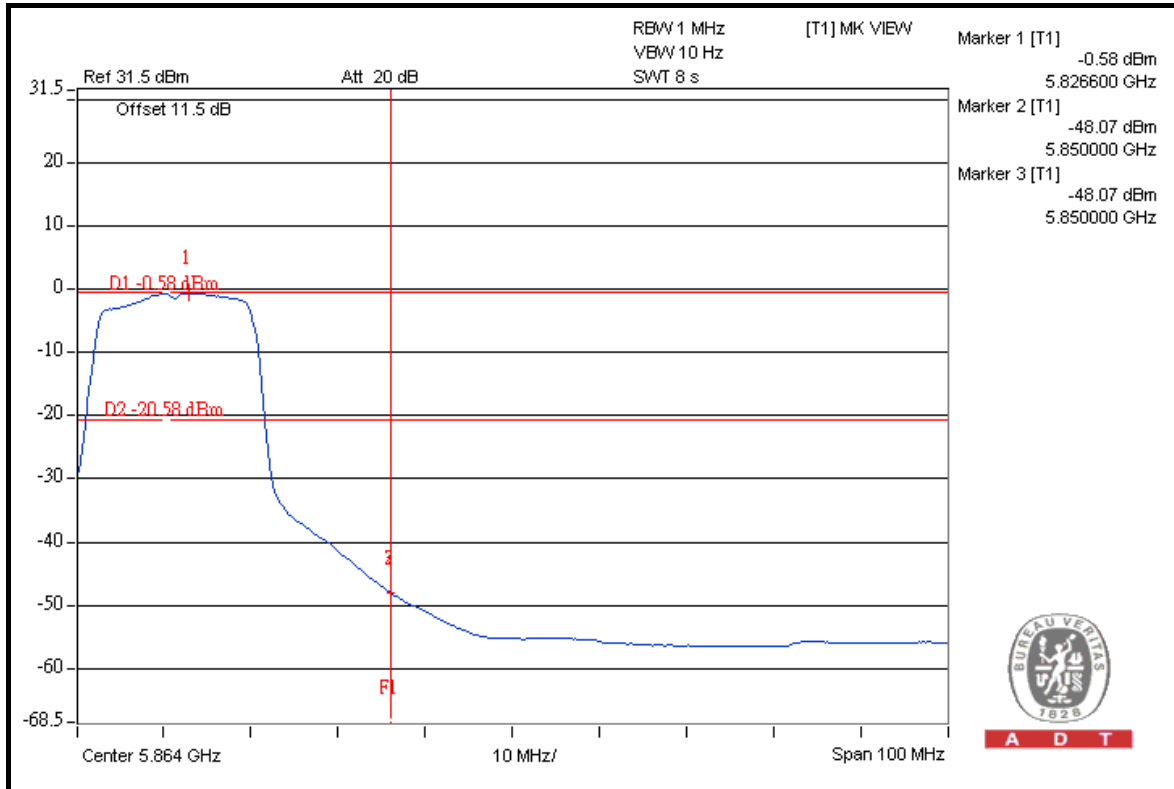



A D T

CHAIN 1

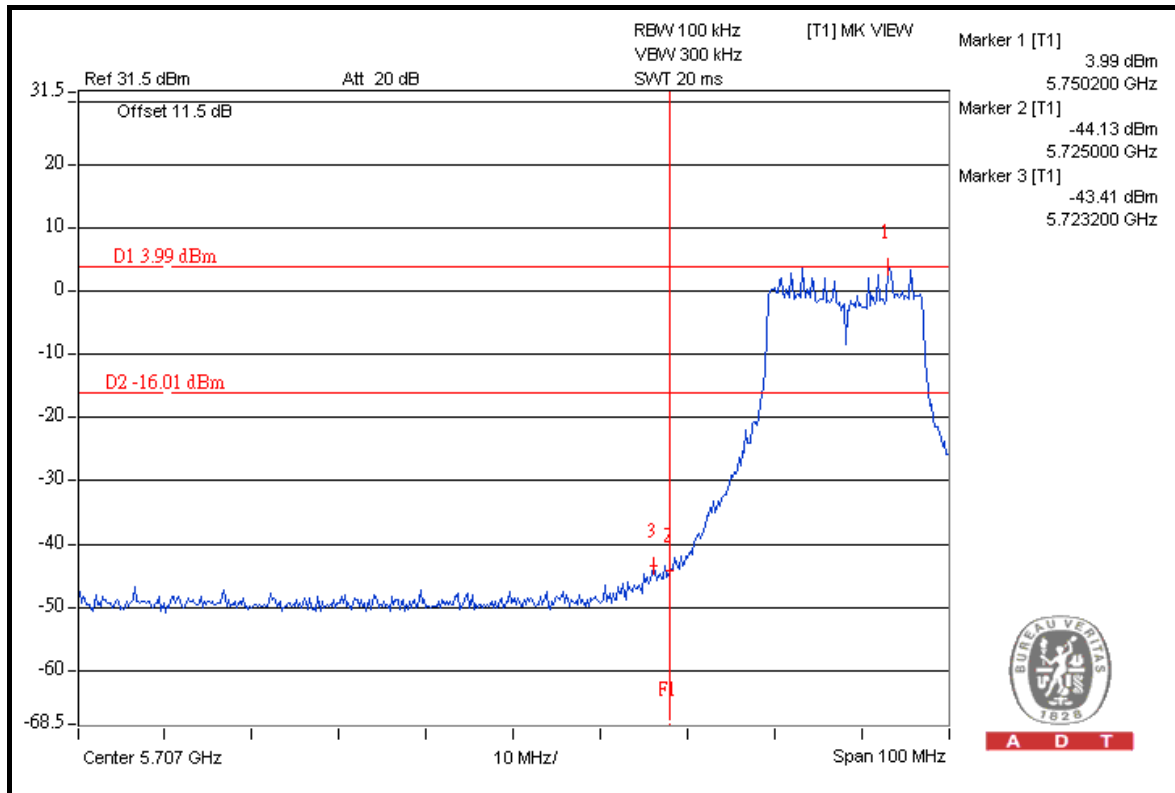

A D T

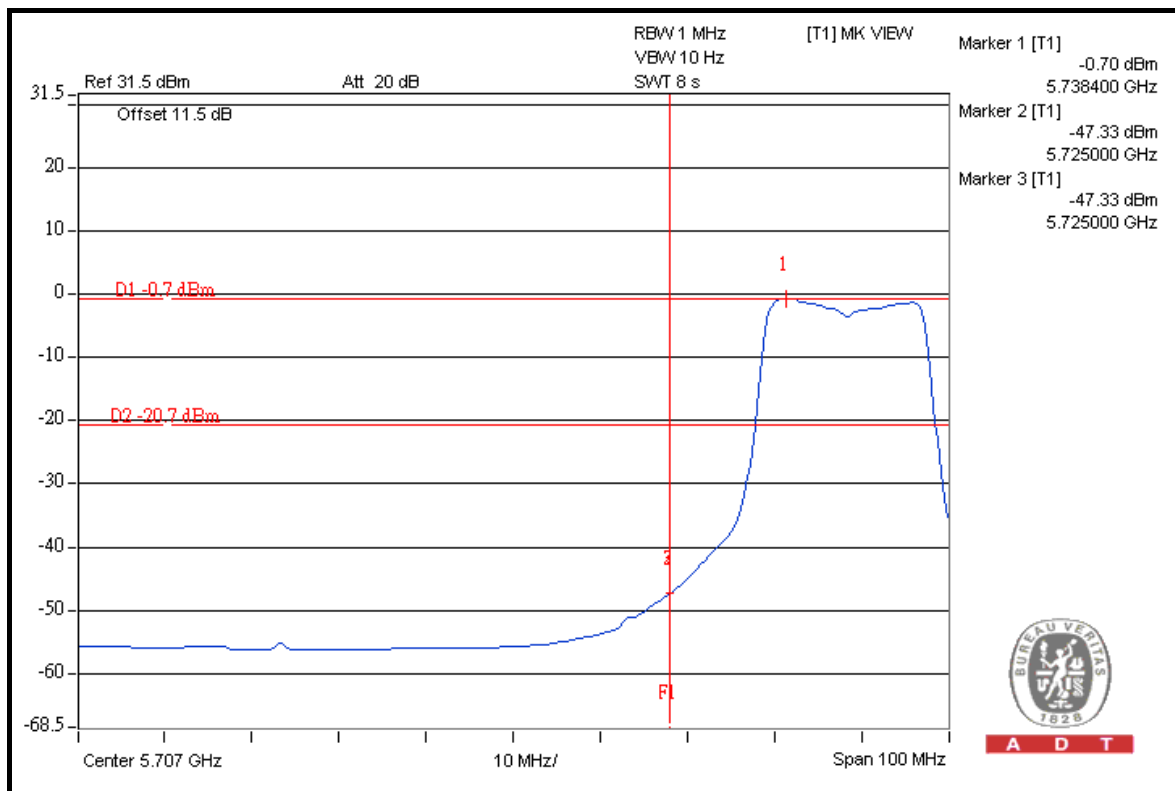

A D T



A D T

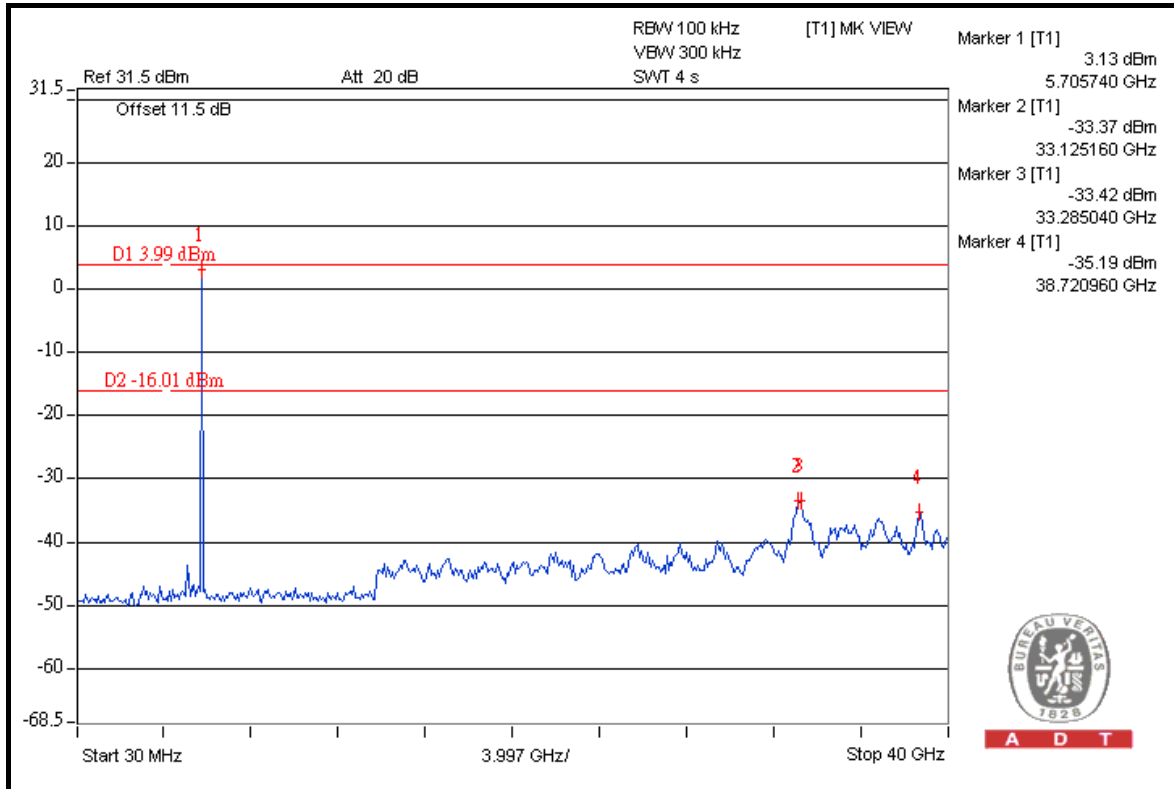

A D T

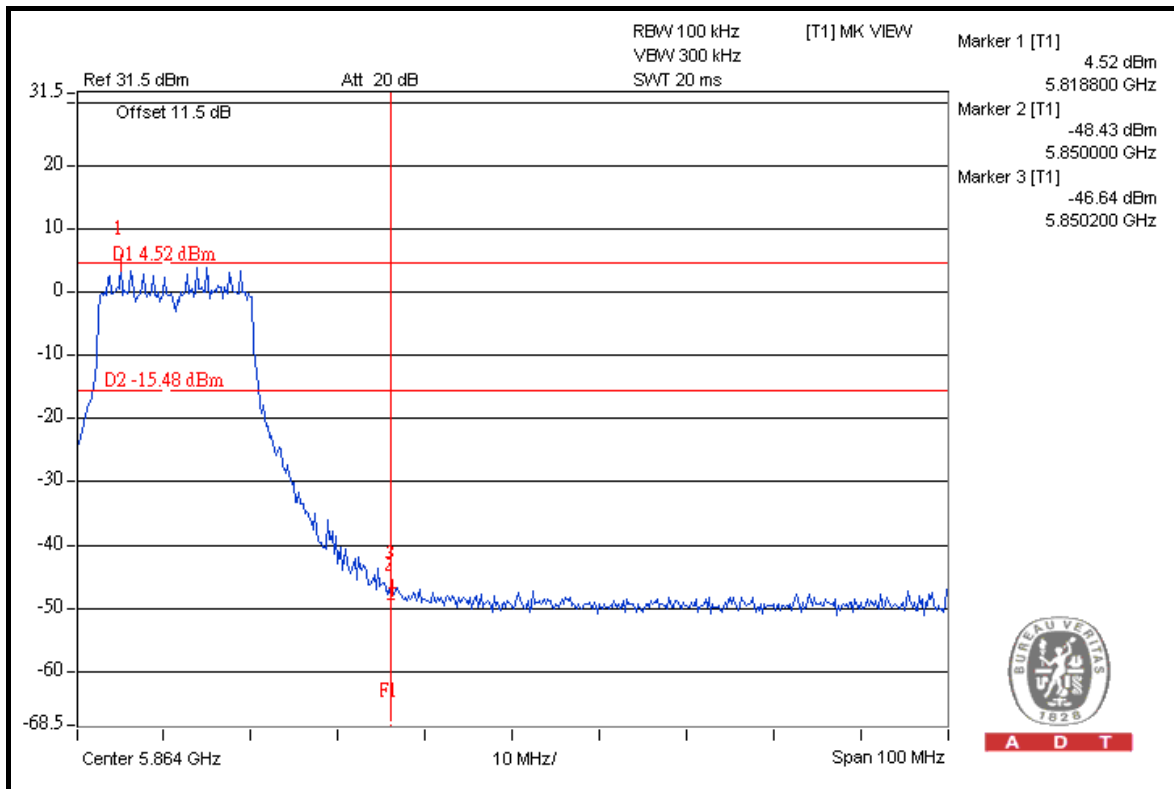

A D T



A D T

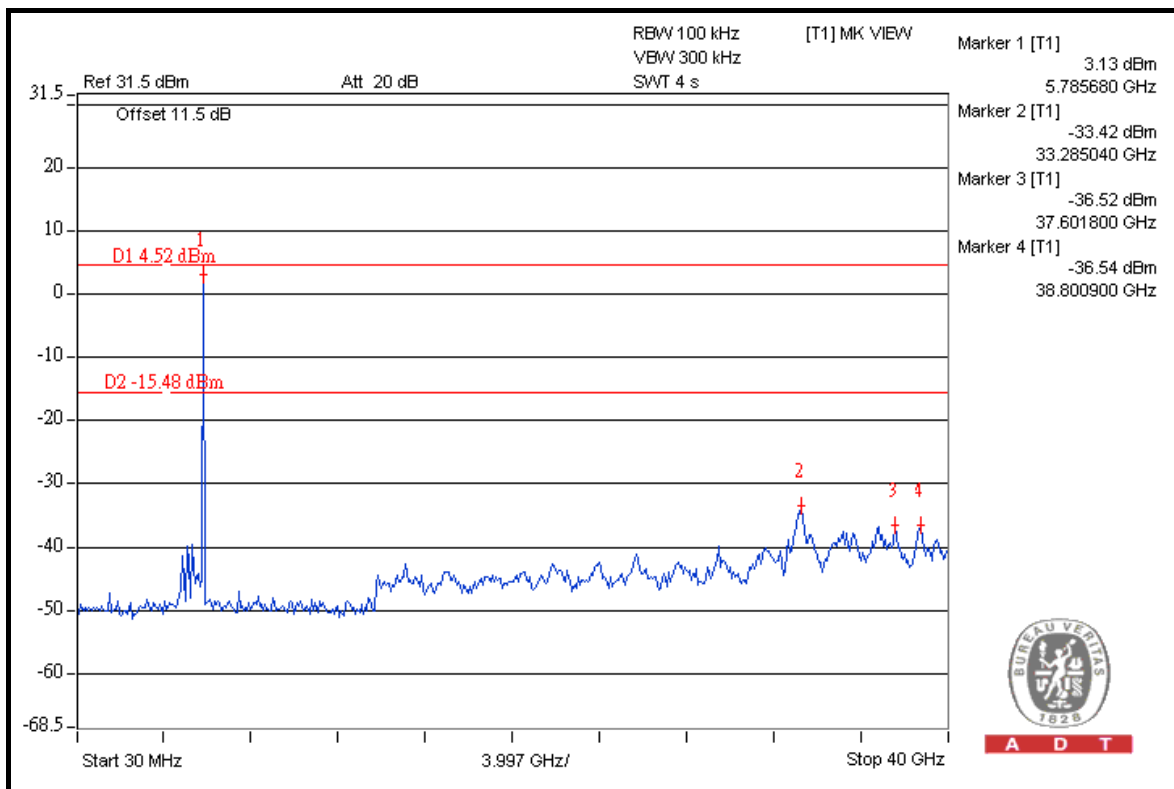
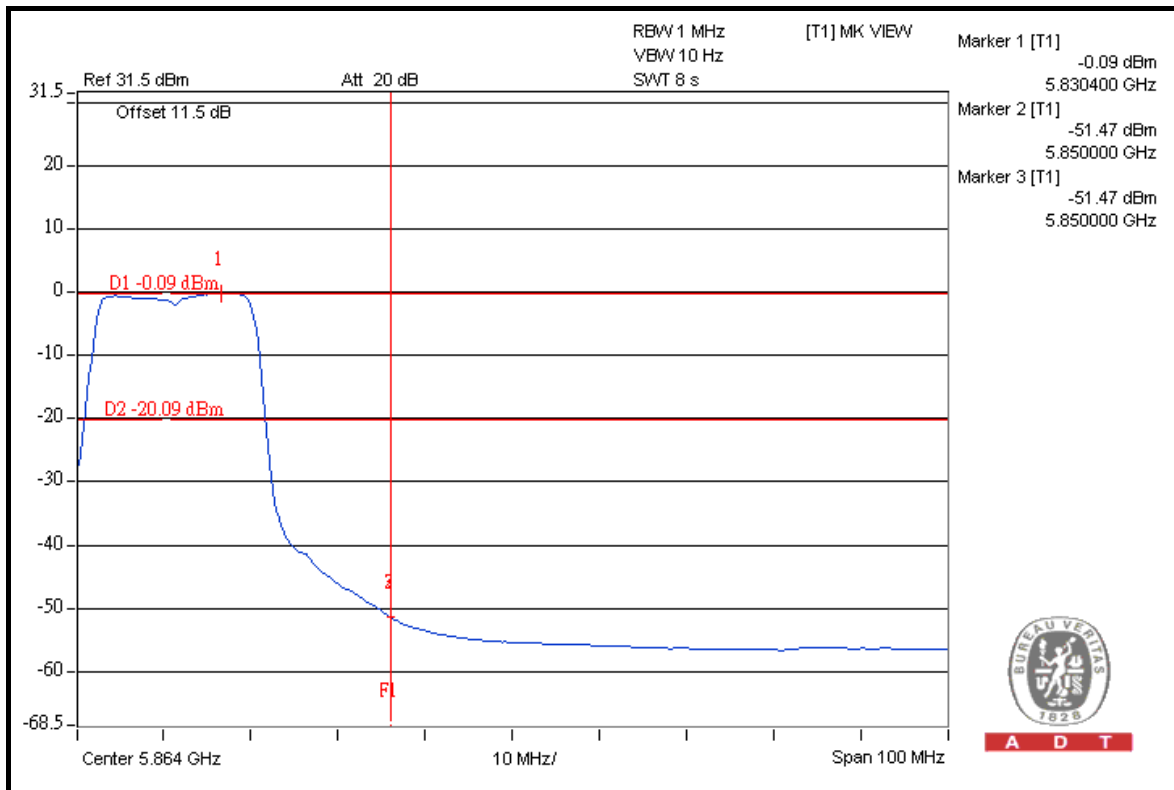



A D T

CHAIN 2

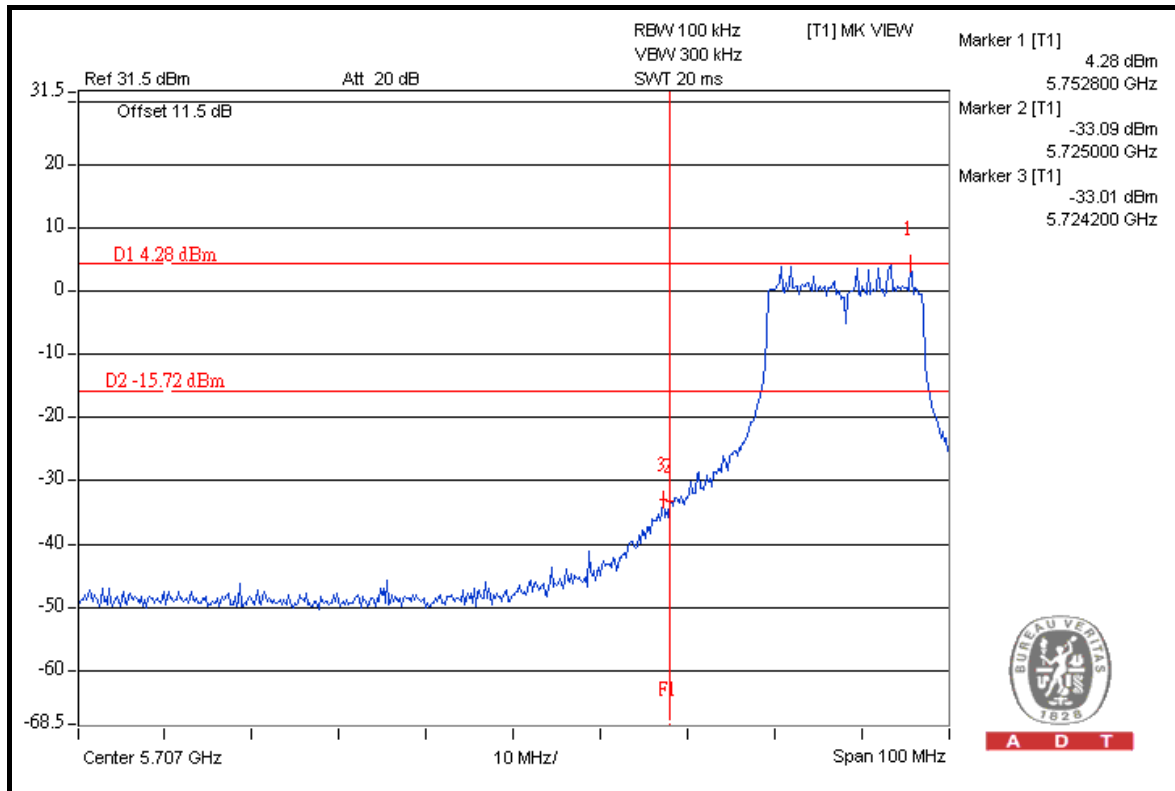

A D T

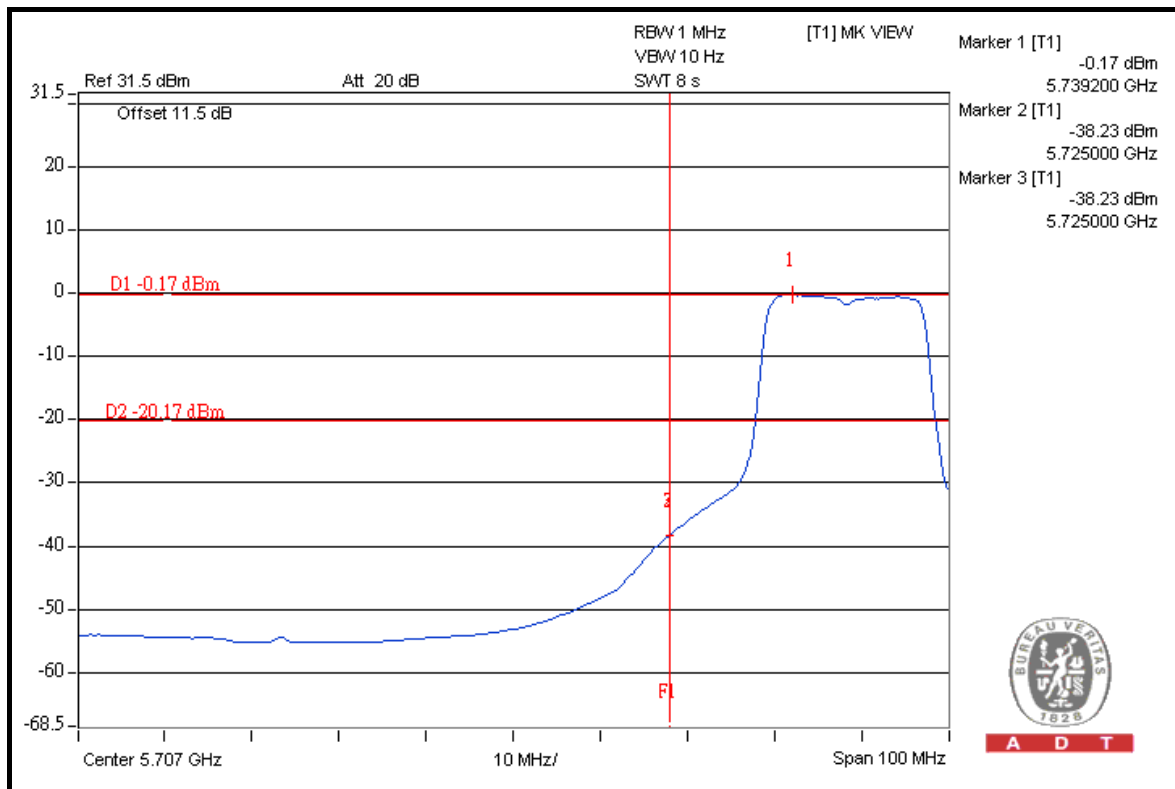

A D T



A D T

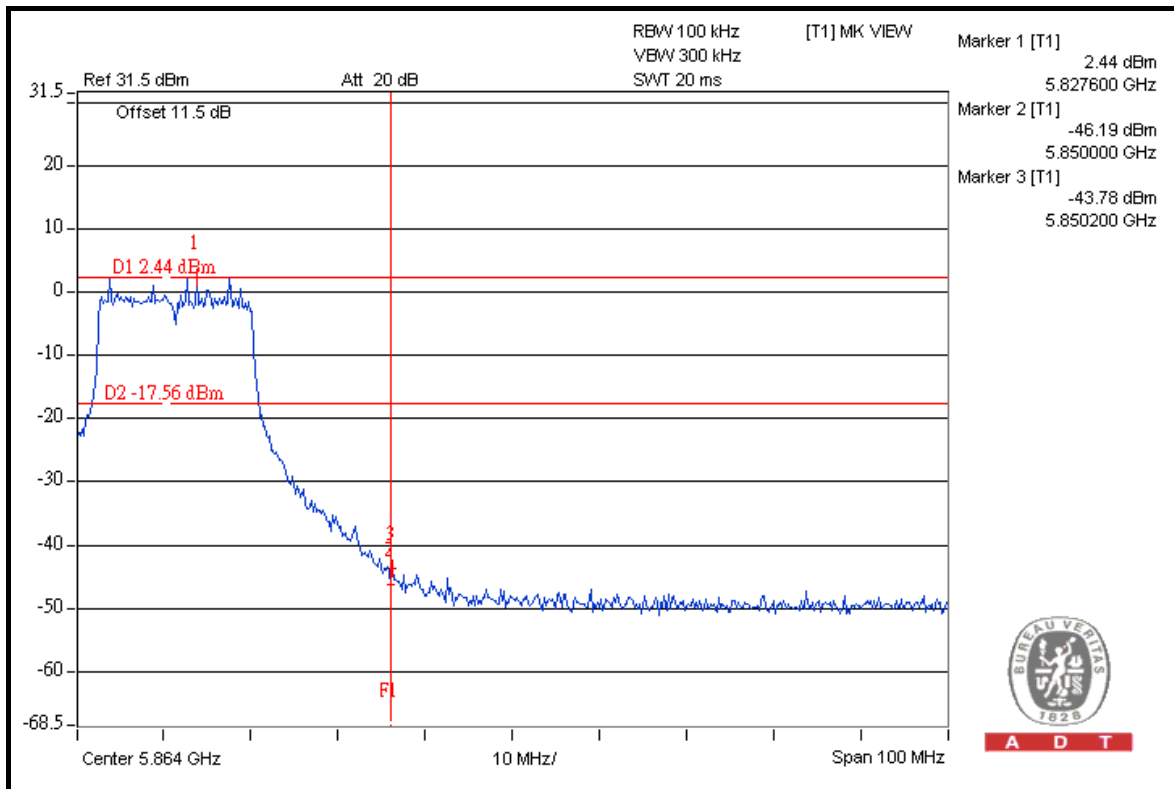
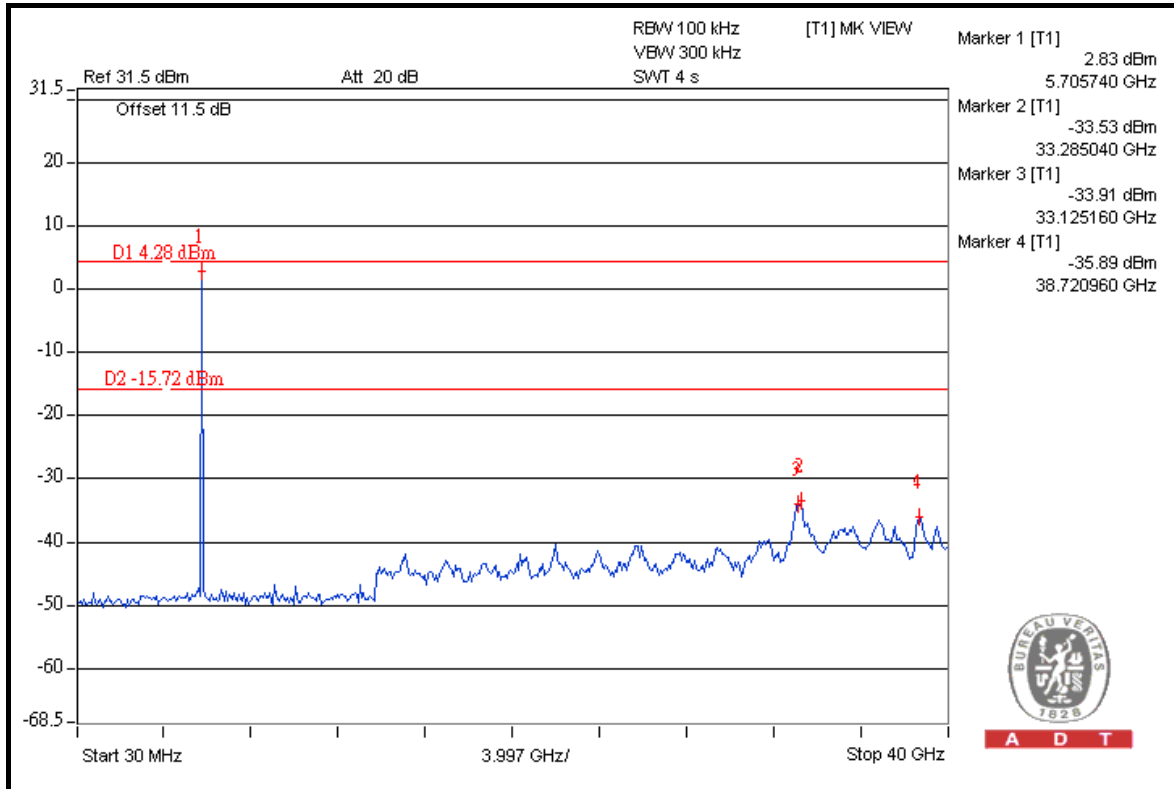



A D T

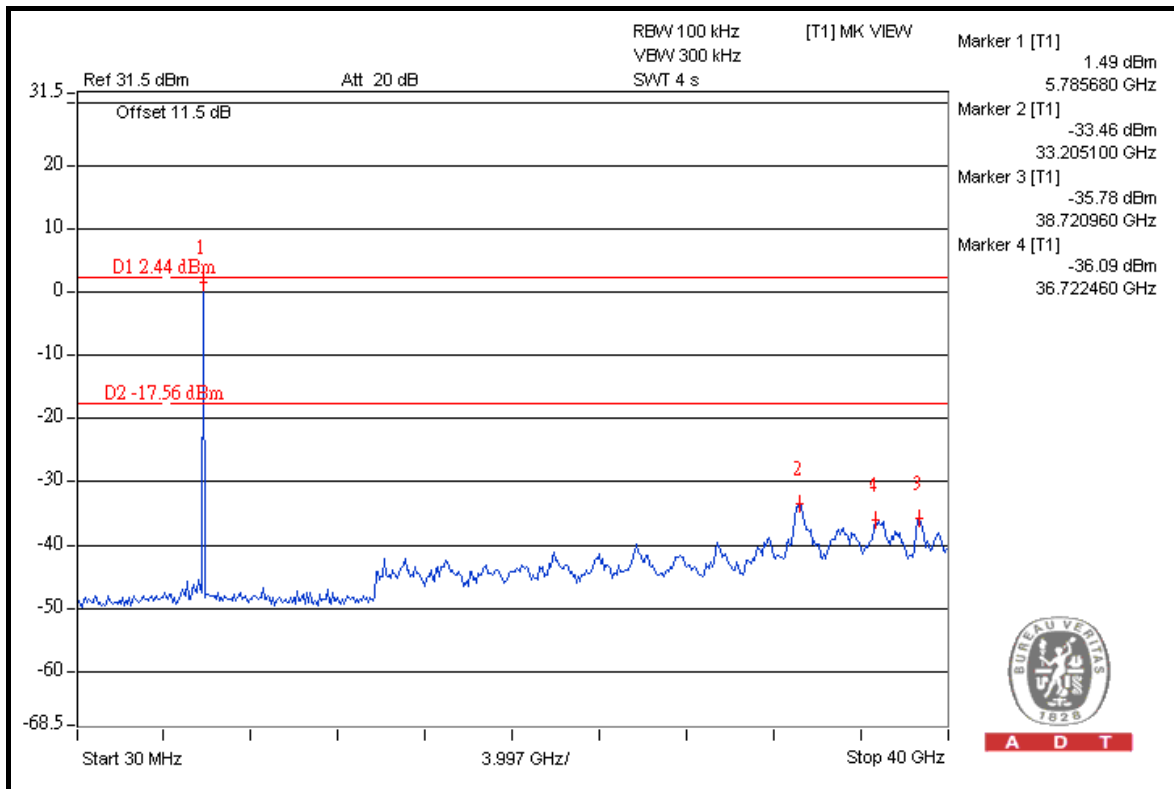
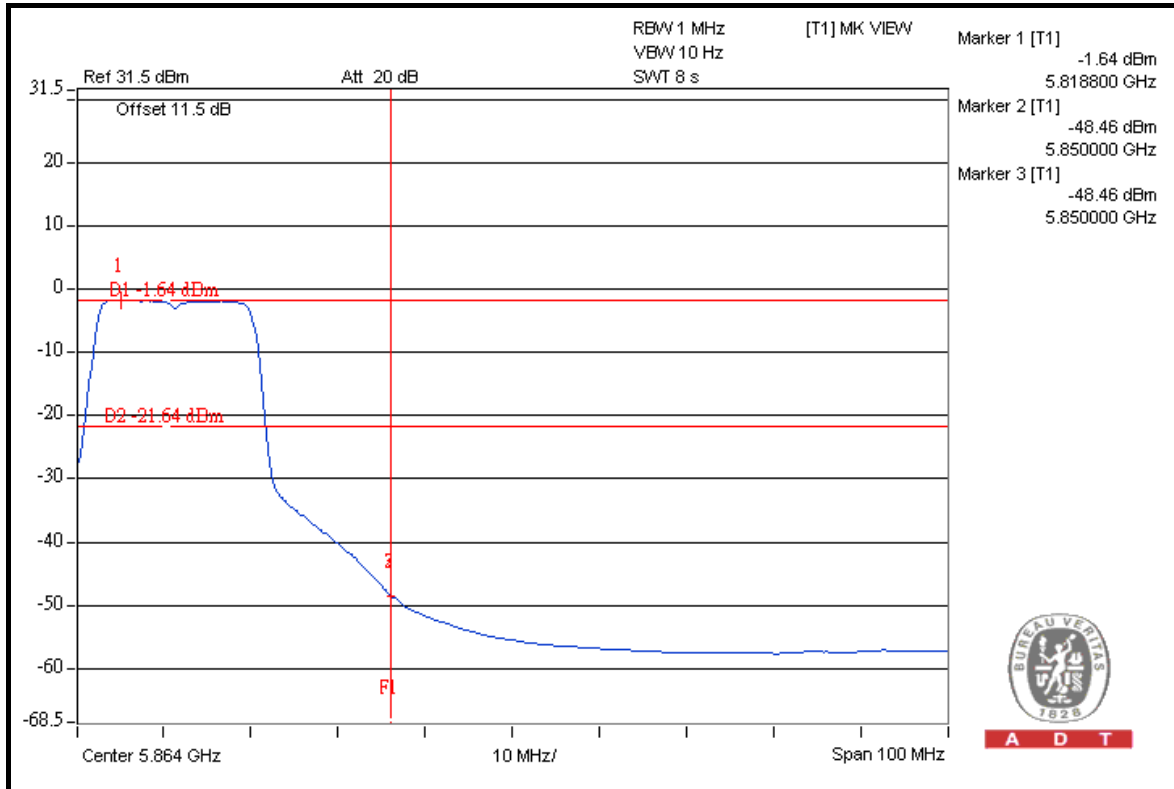



A D T

802.11n (40MHz)

FOR RADIATED MEASURED (THREE CHAINS ON)

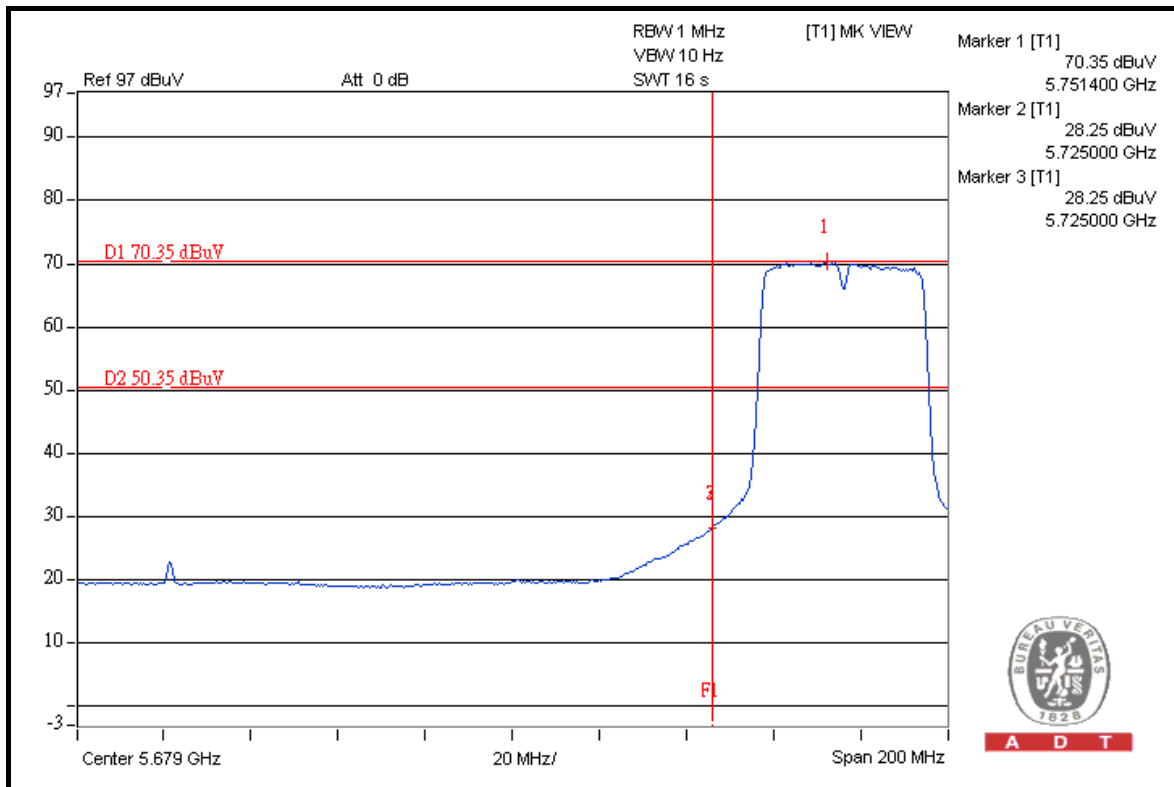
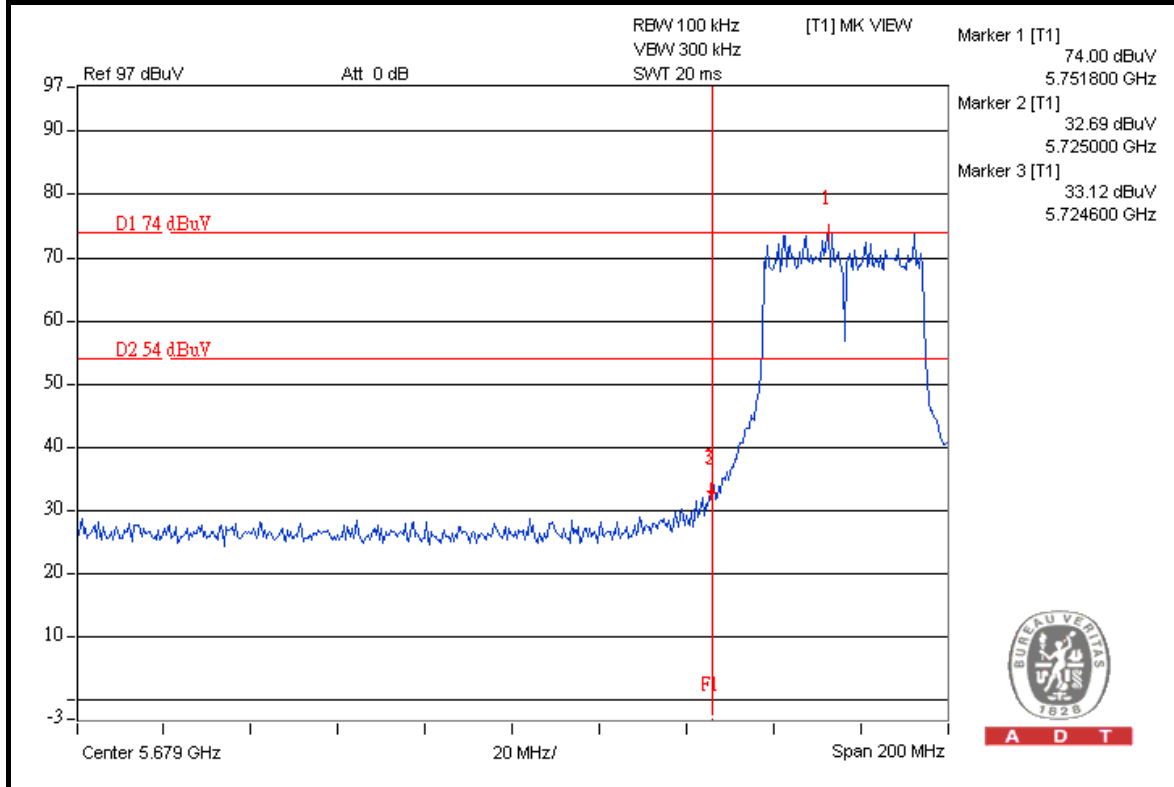



A D T

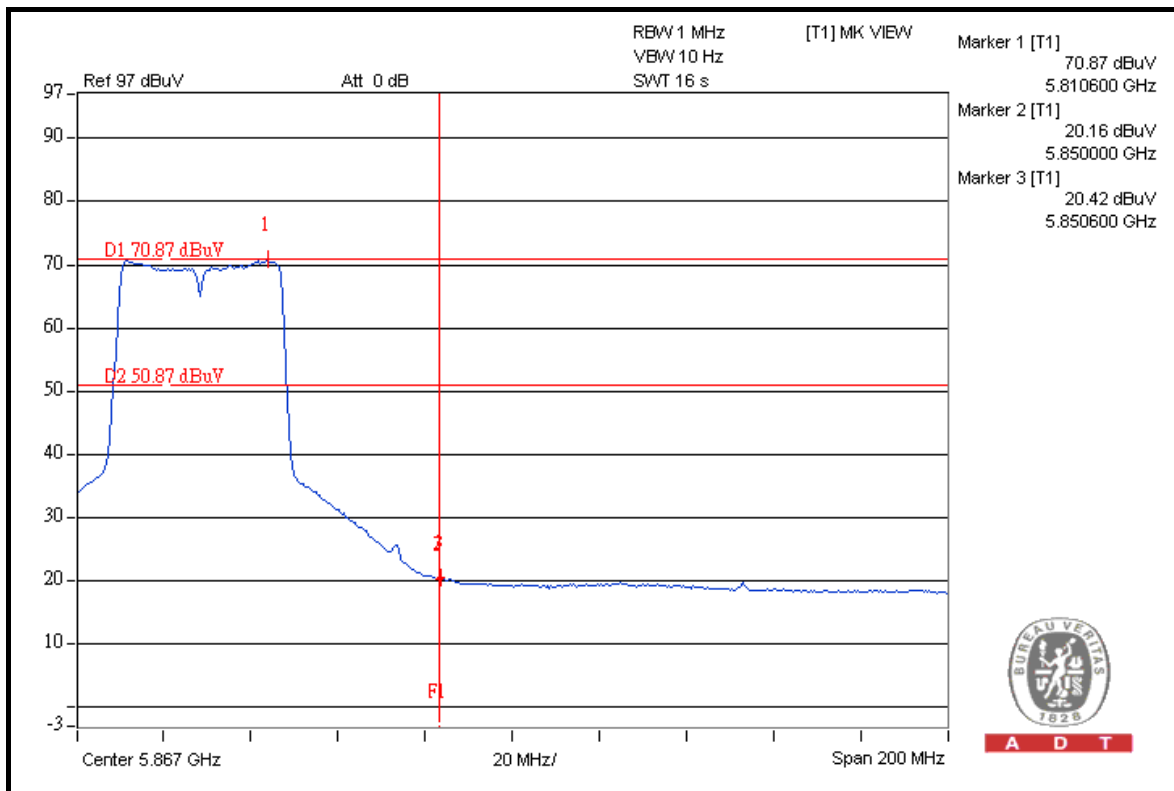
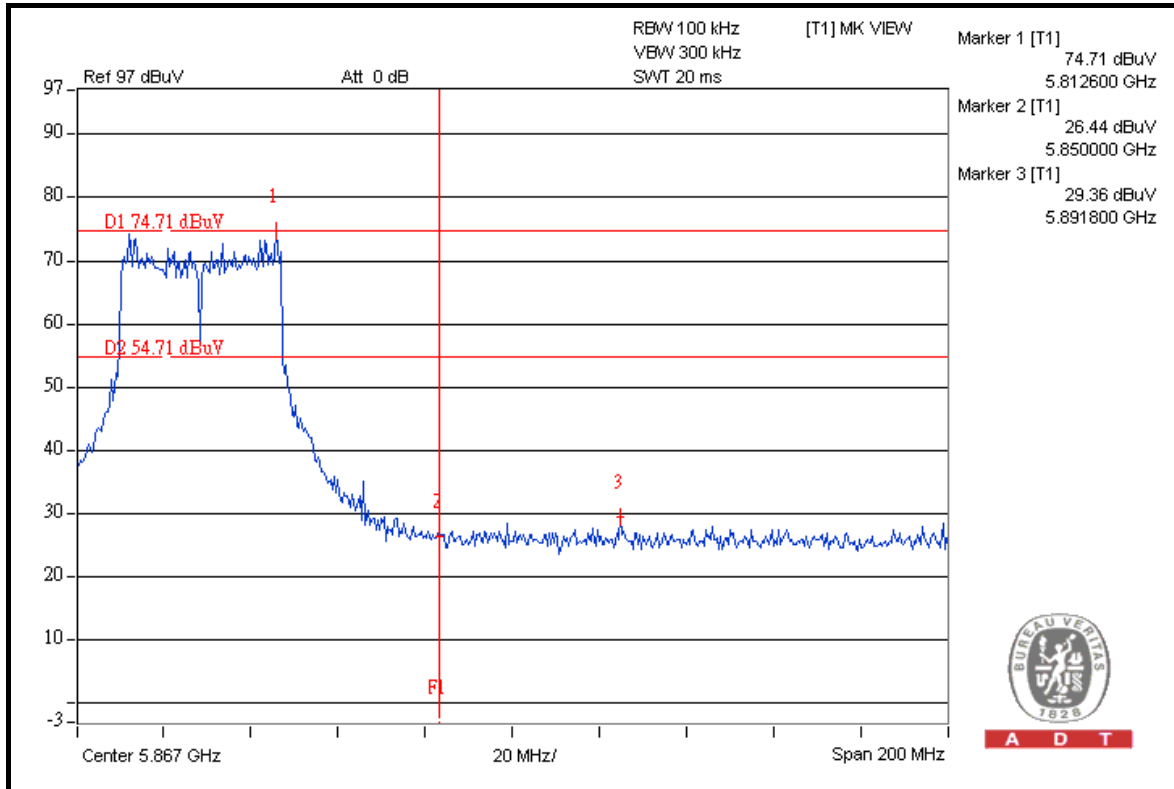



A D T

FOR CONDUCTED MEASURED

CHAIN 0

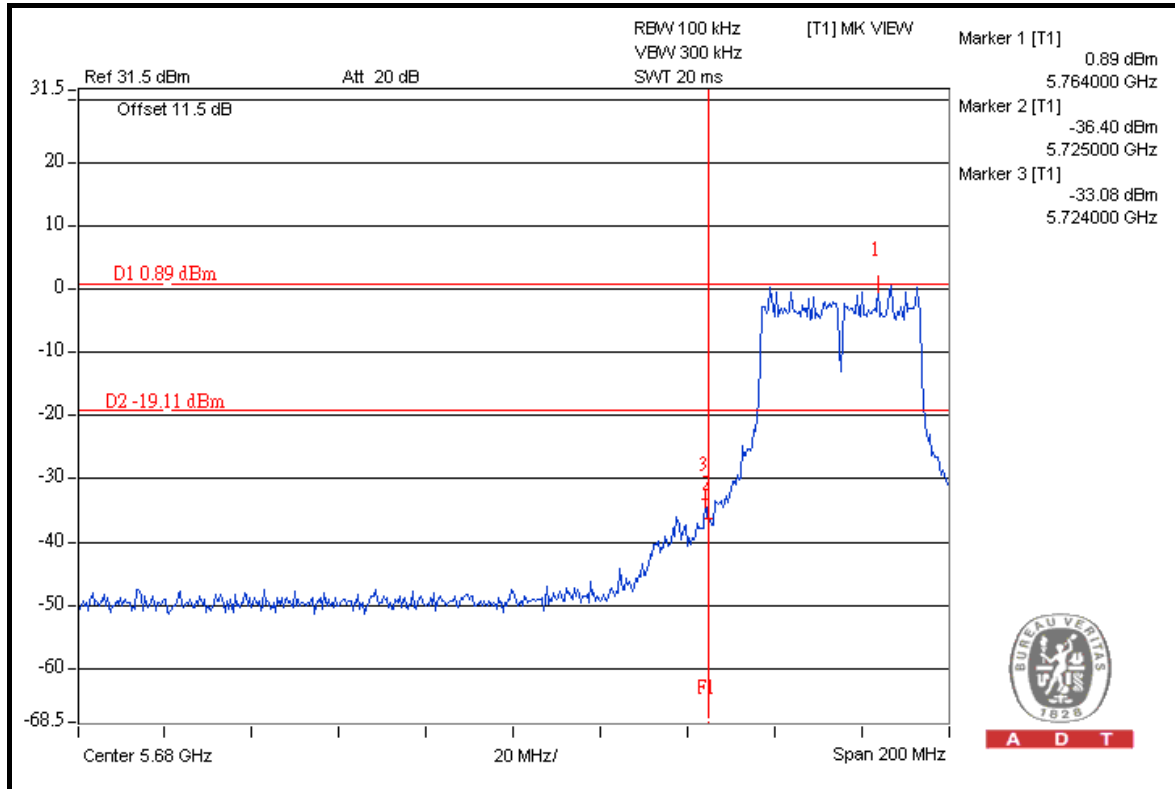

A D T

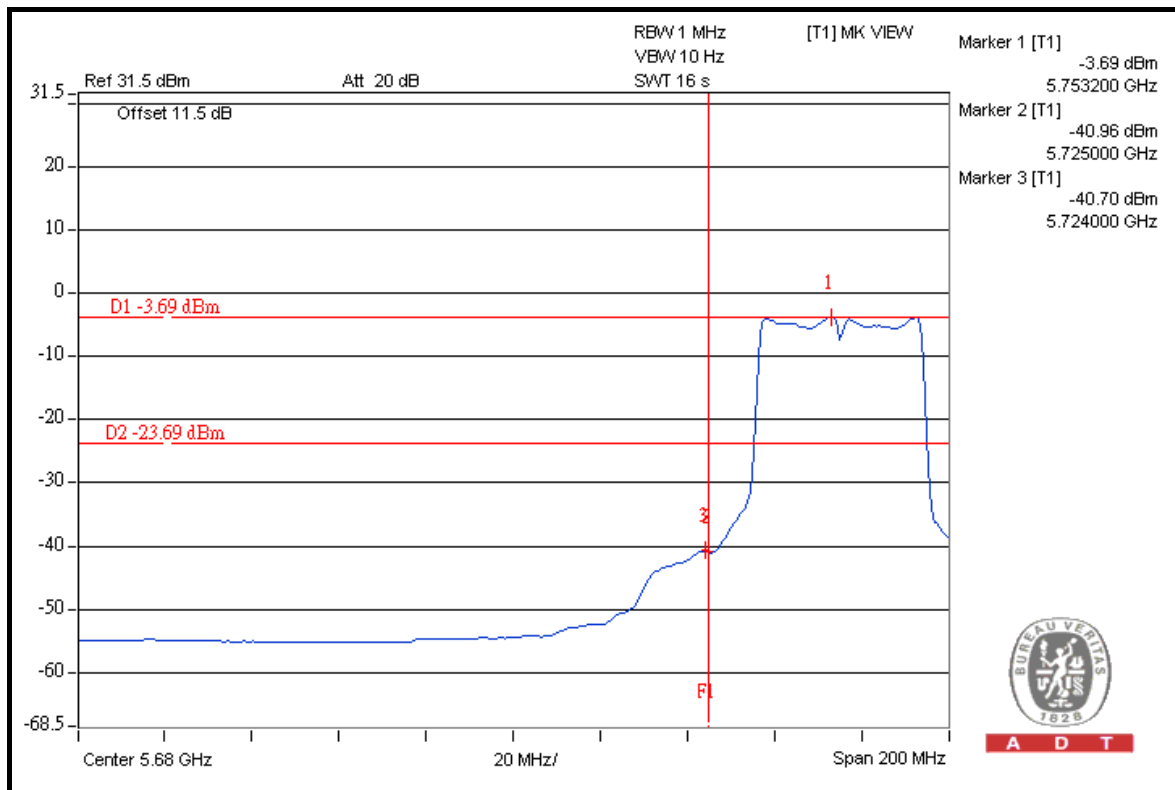

A D T



A D T

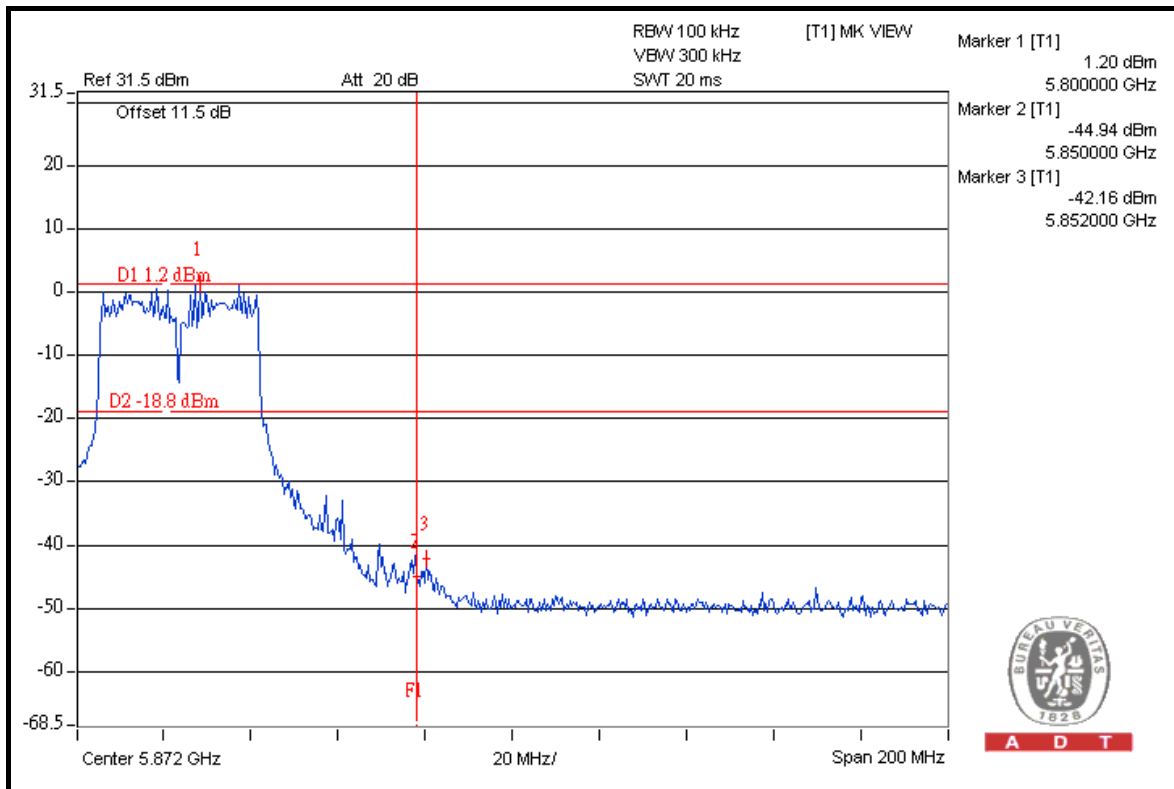
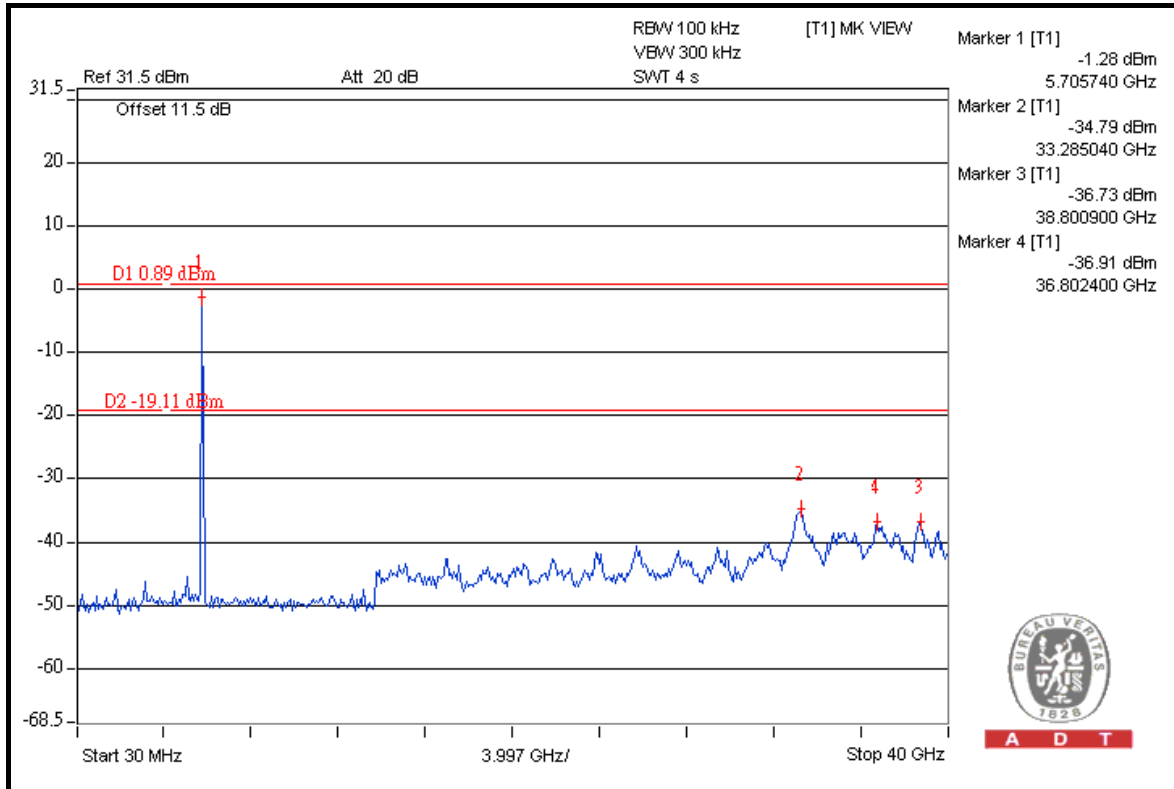



A D T

CHAIN 1

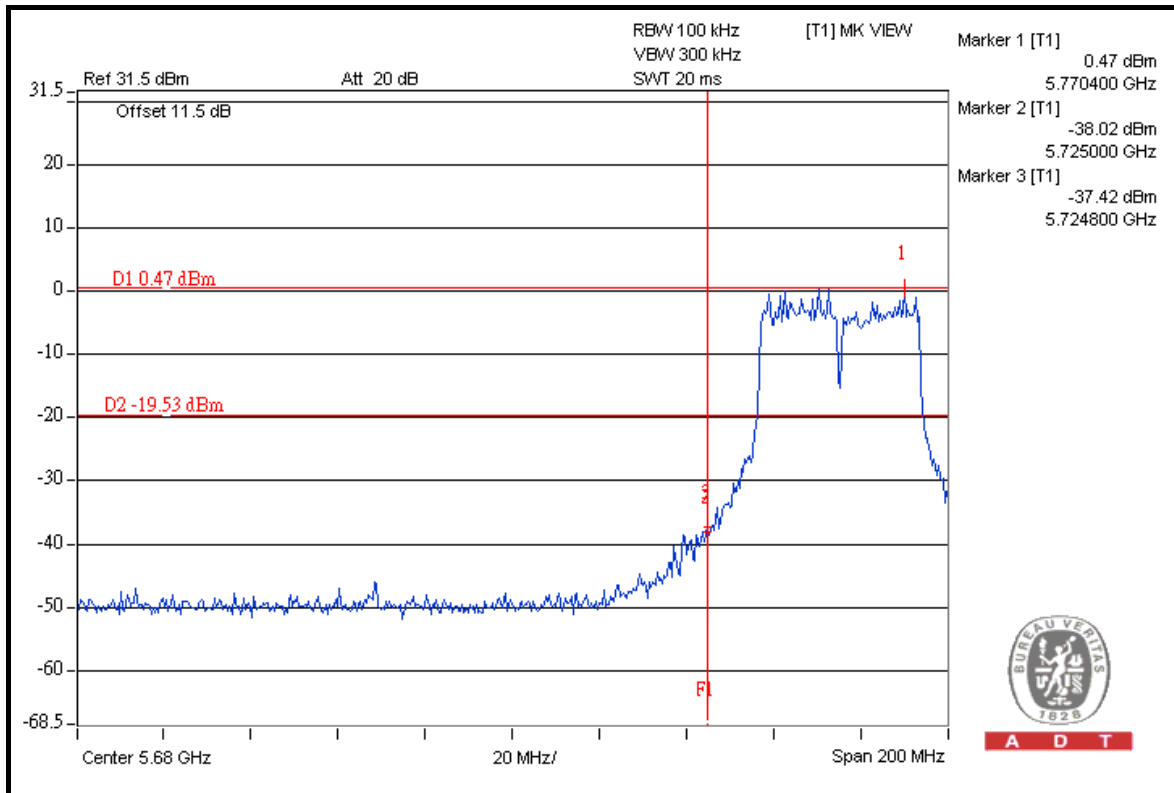

A D T

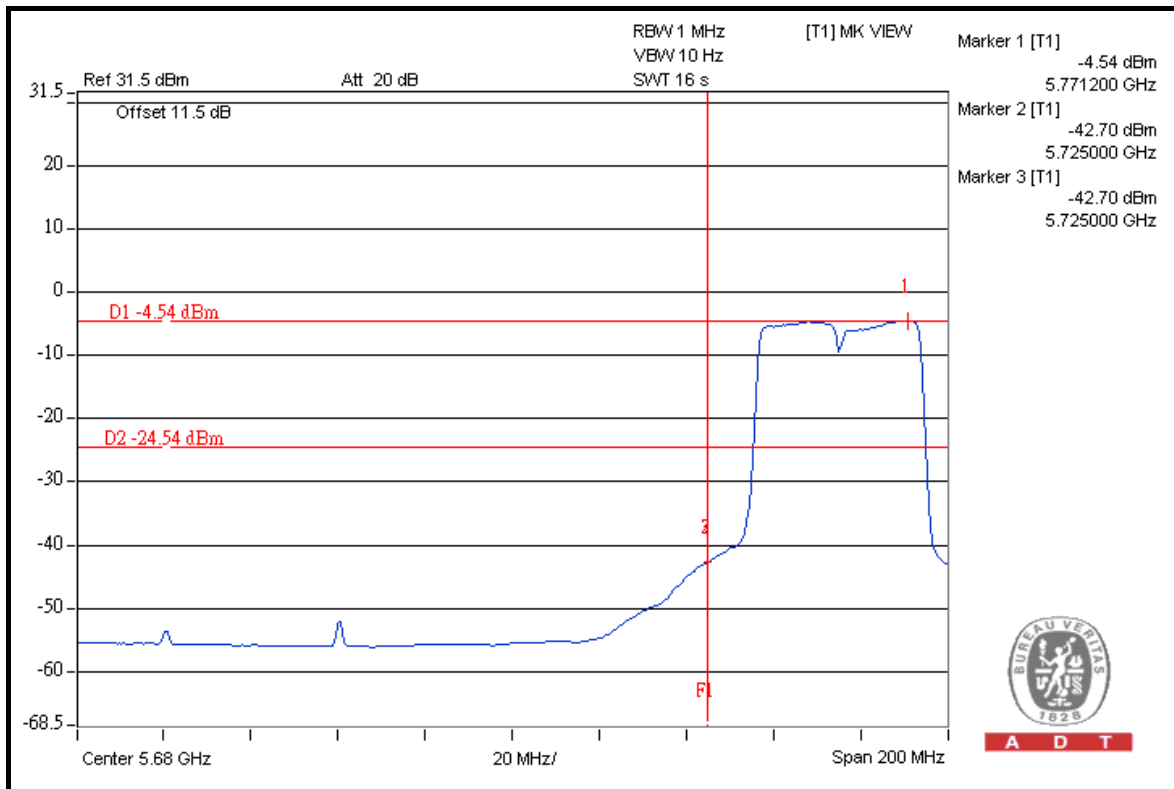

A D T



A D T

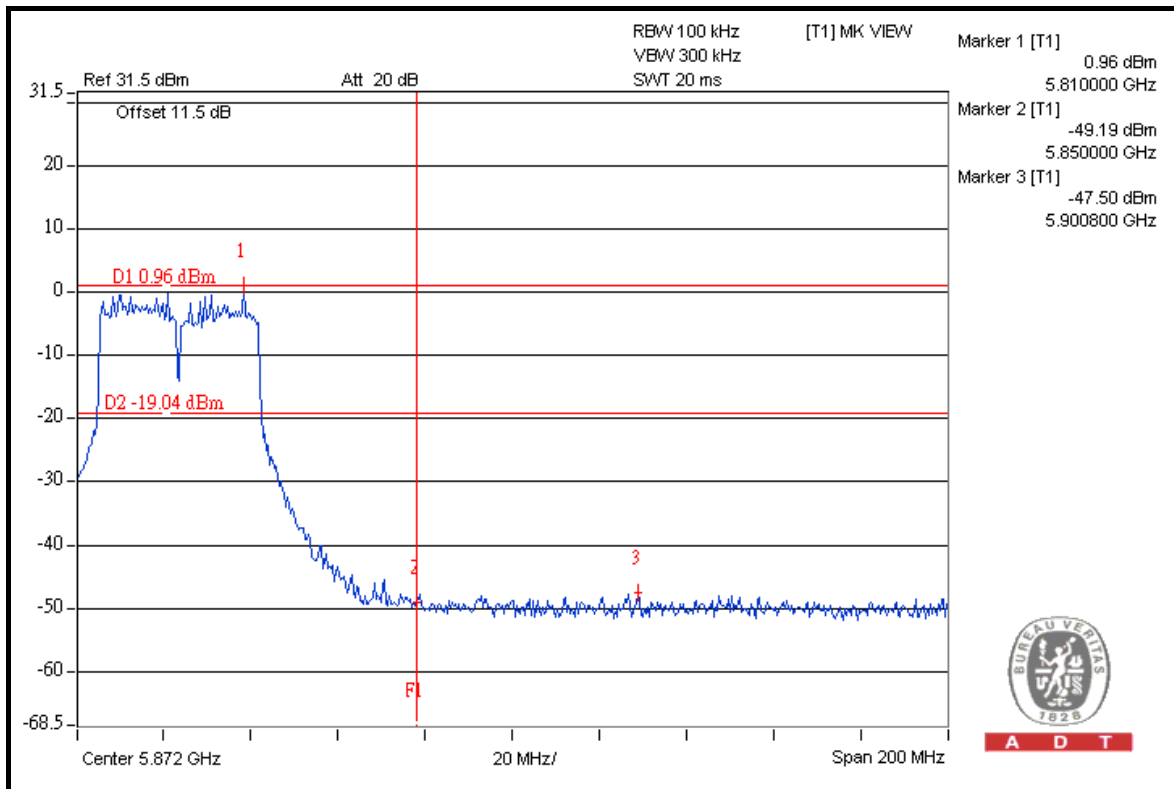
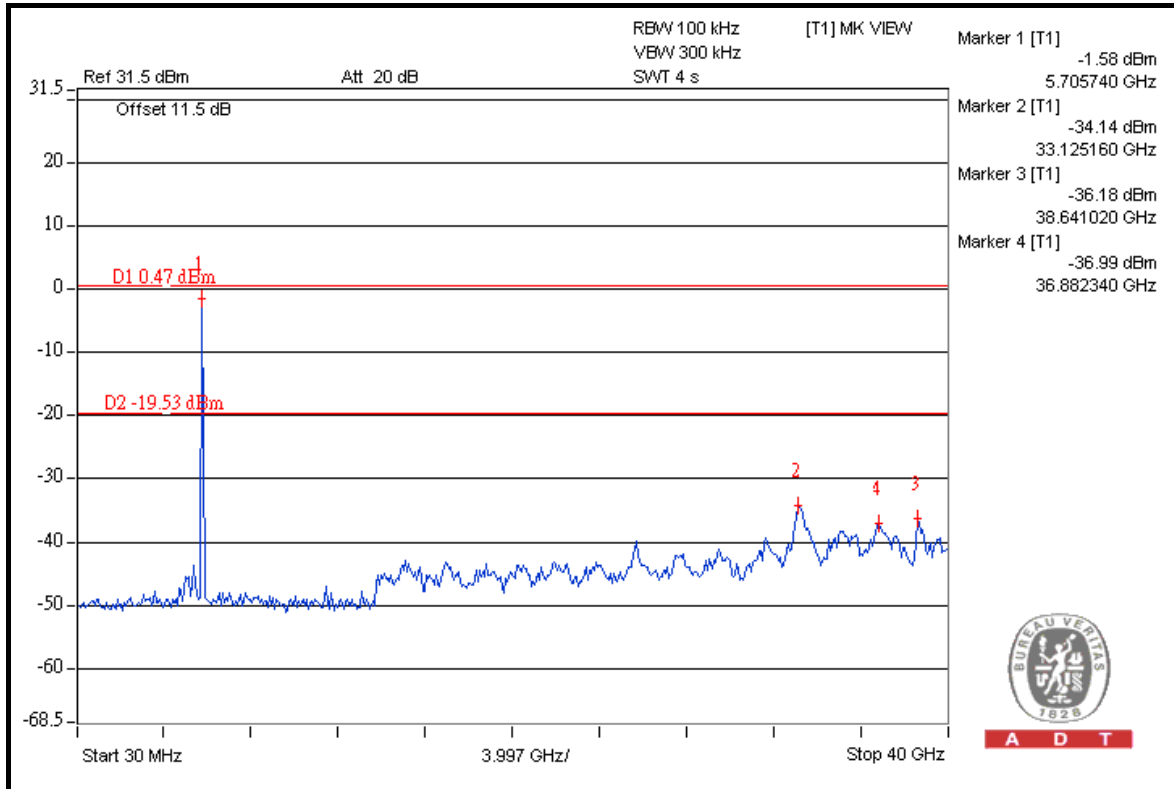



A D T

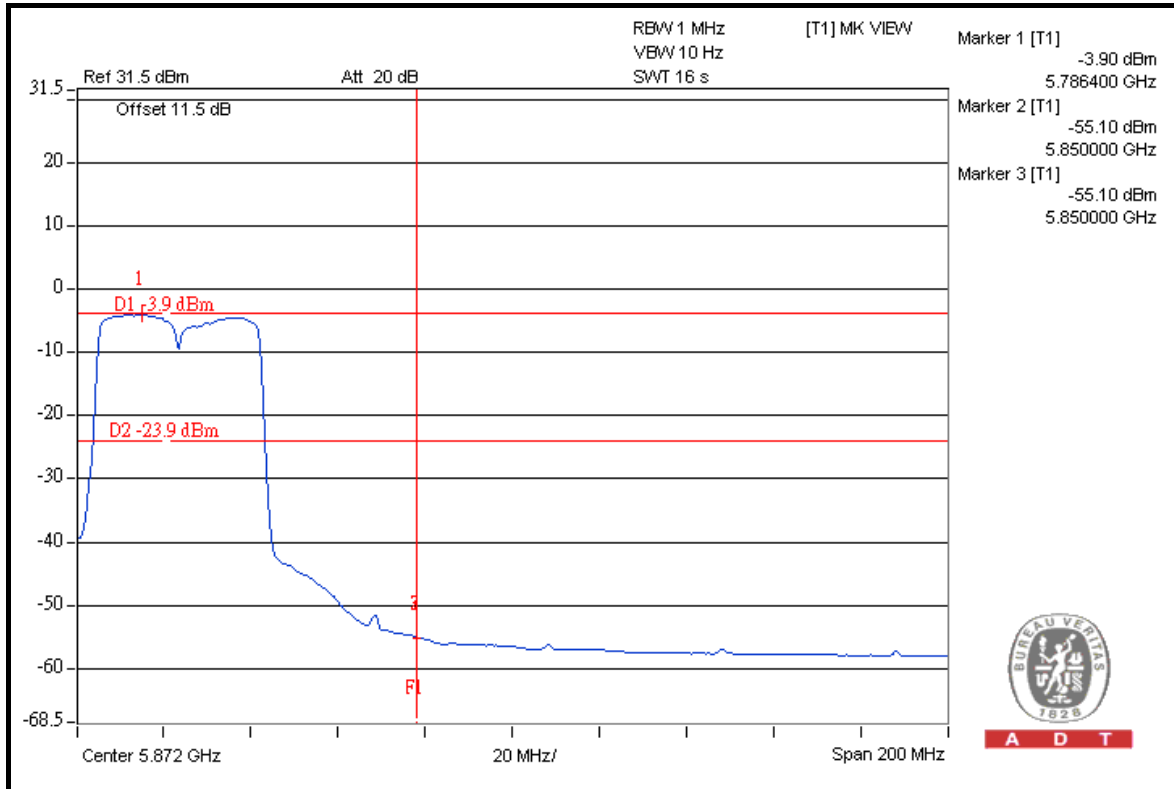

A D T

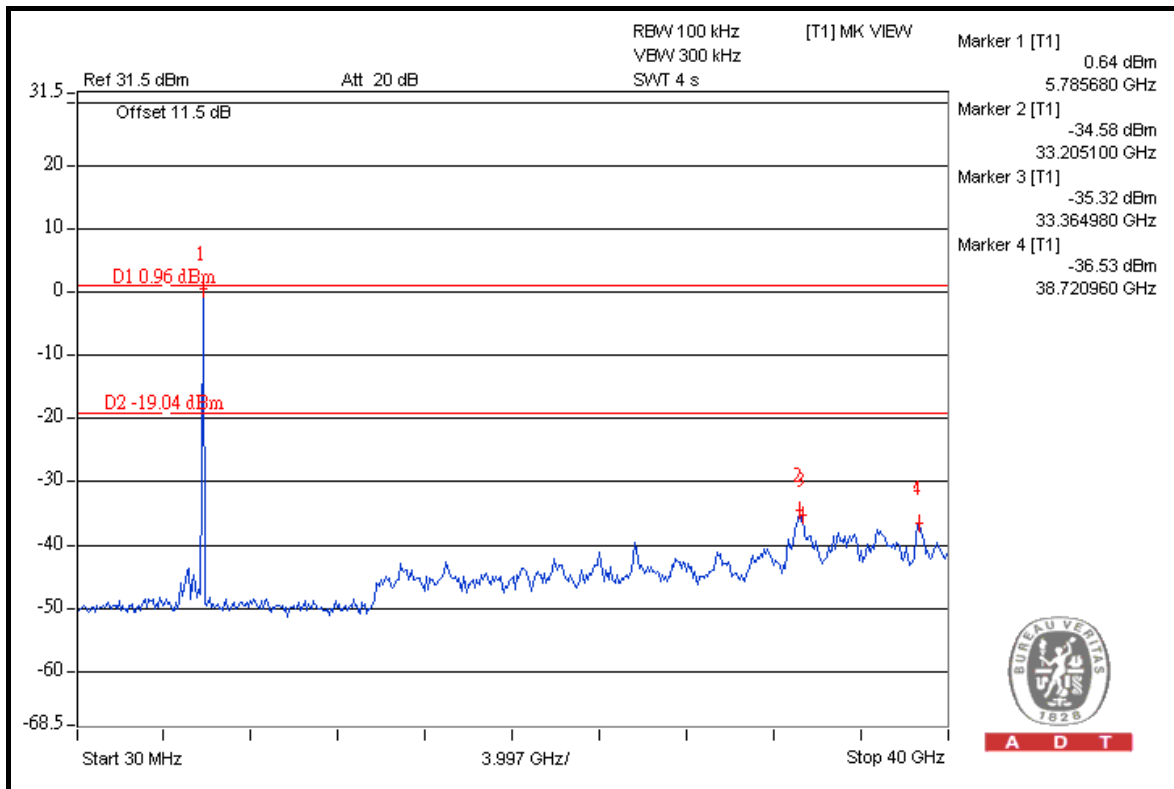

A D T



A D T

CHAIN 2

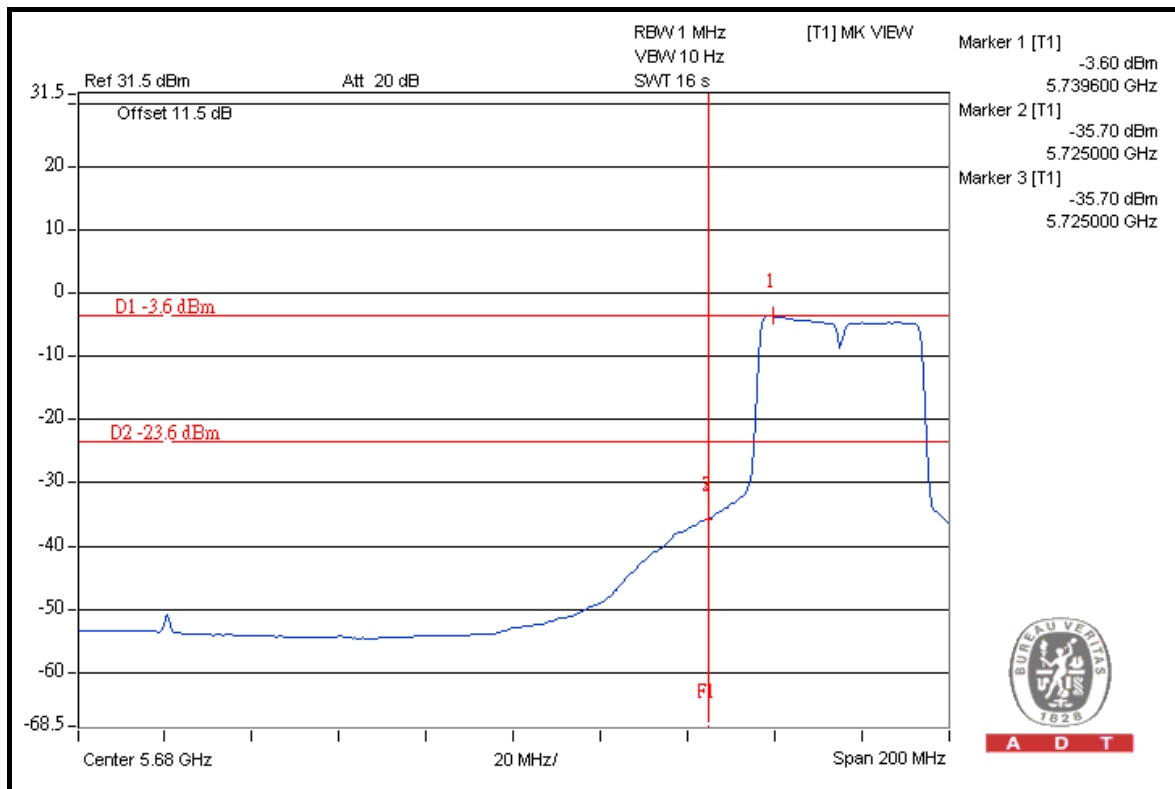
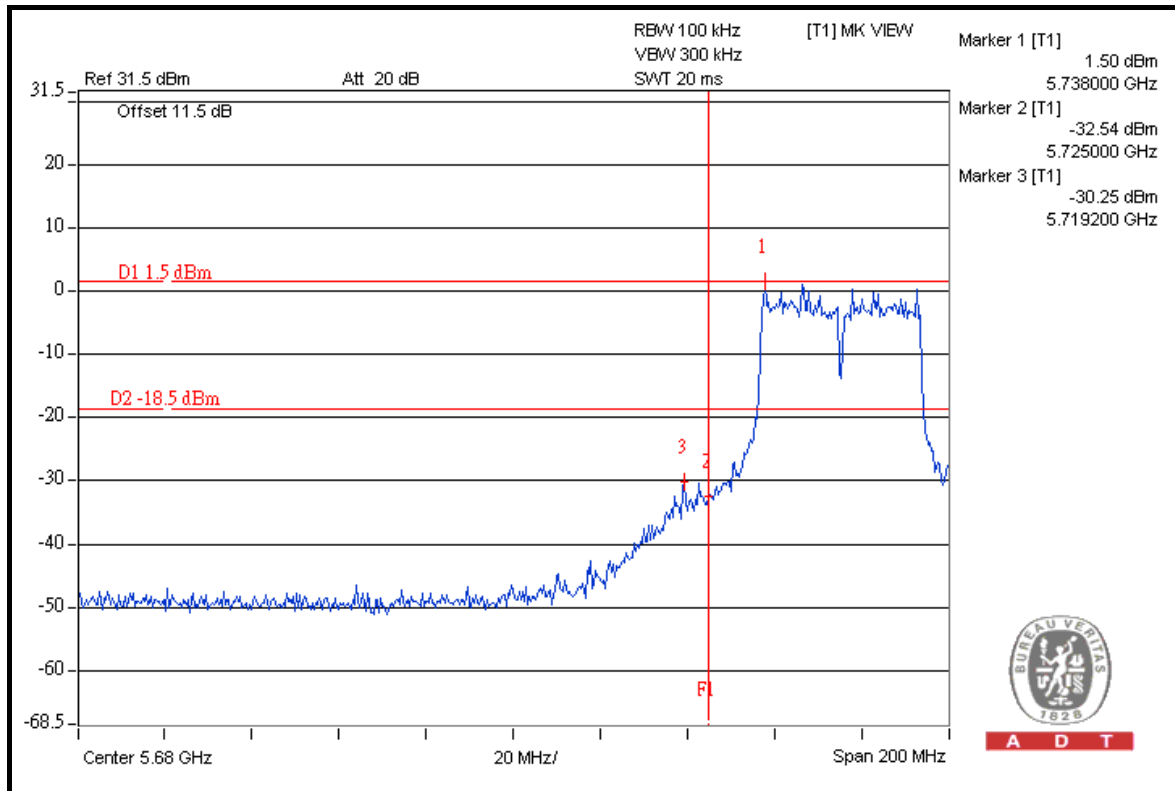



A D T

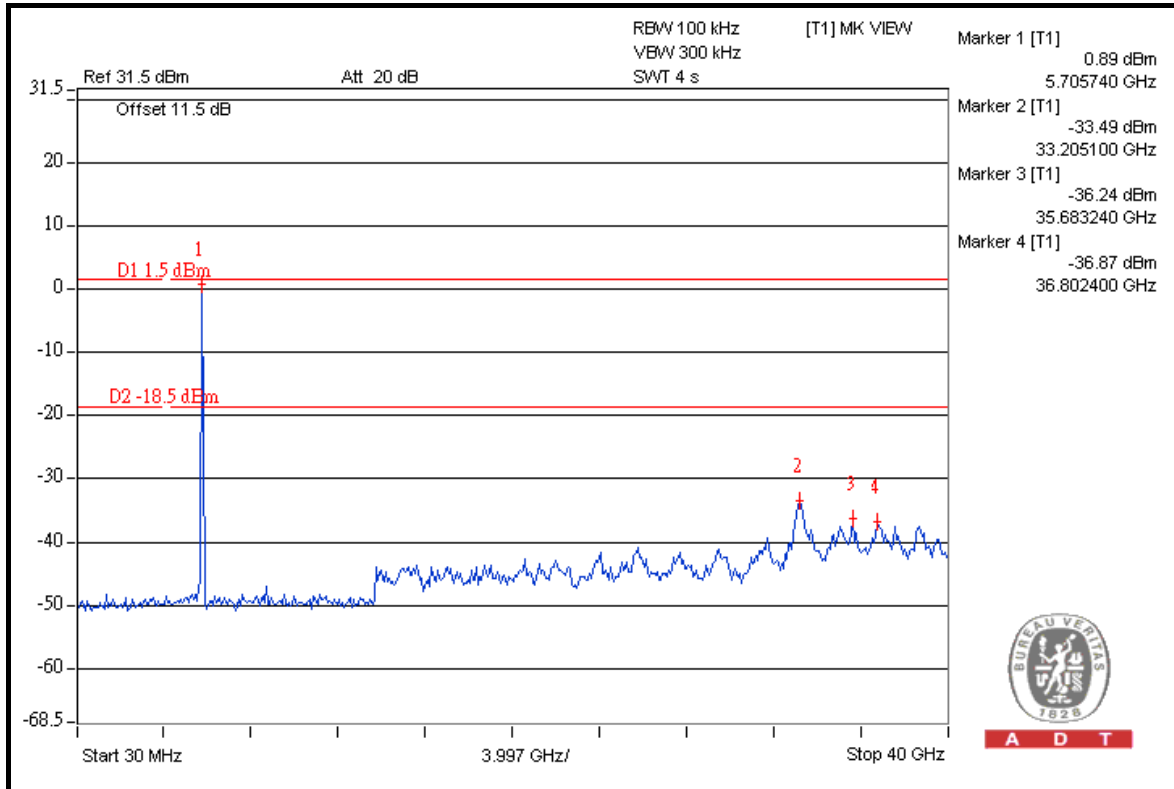

A D T

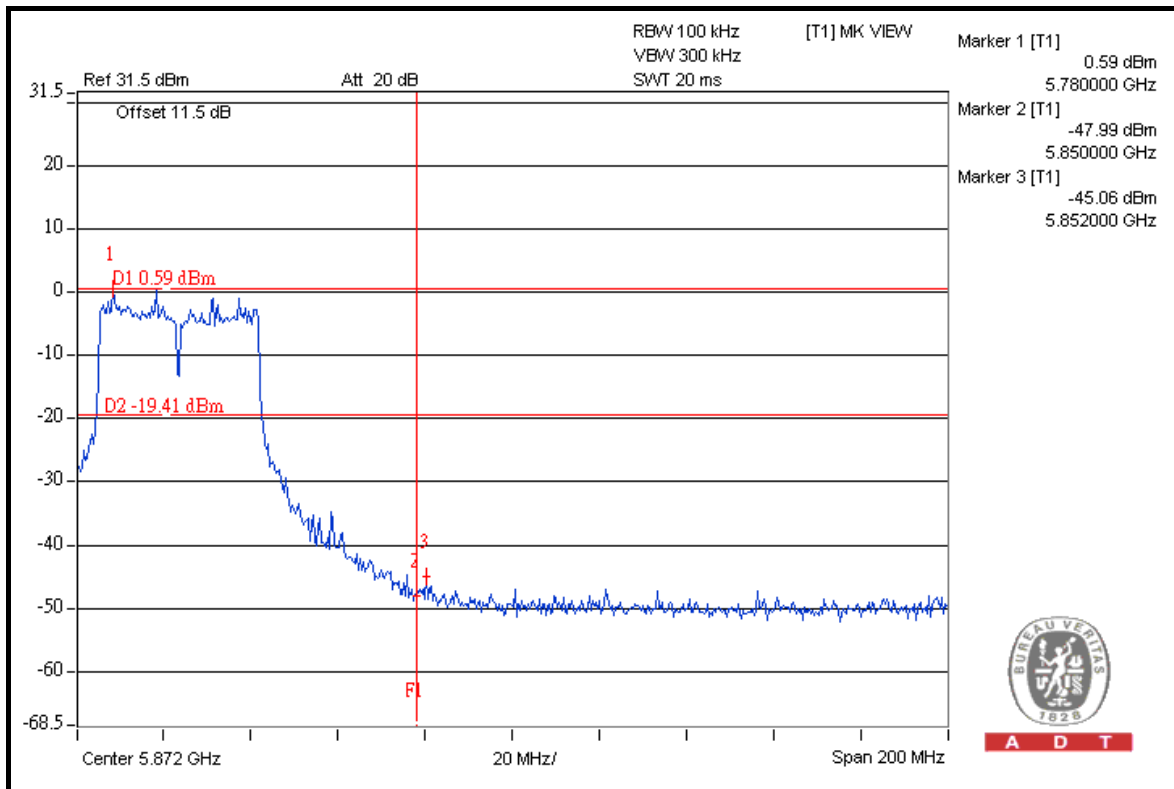

A D T



A D T

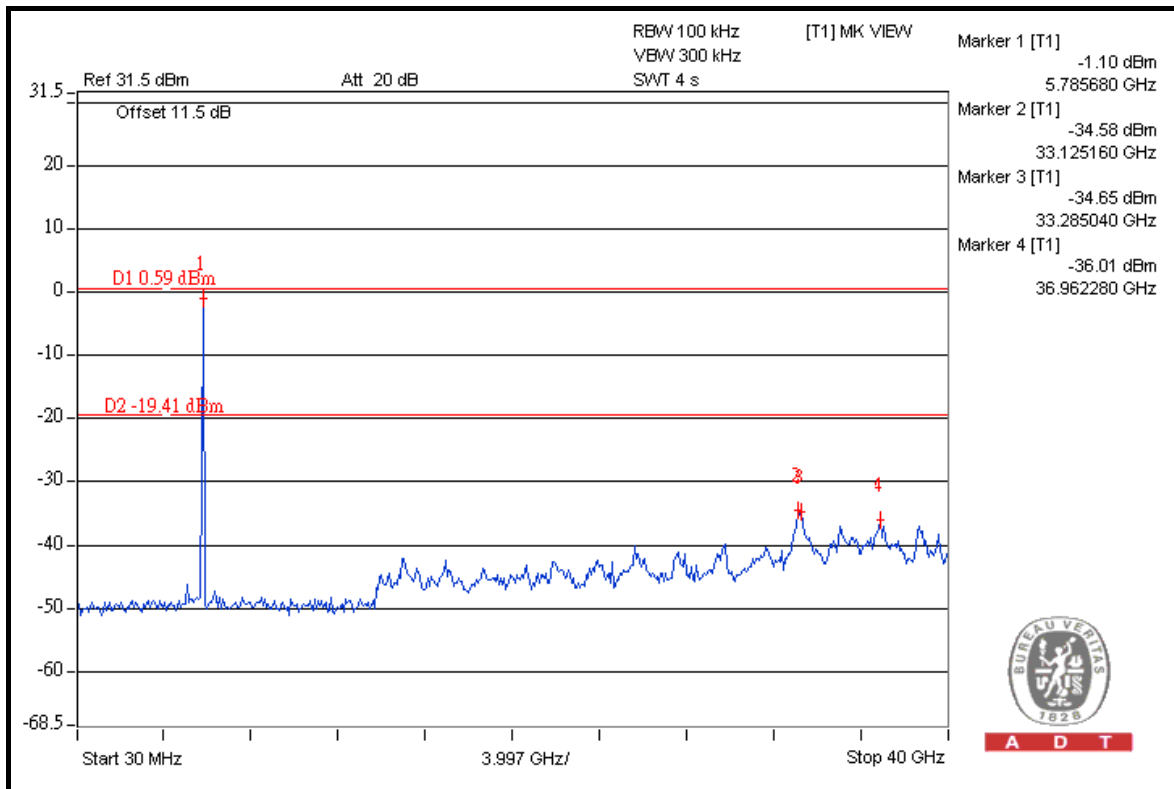
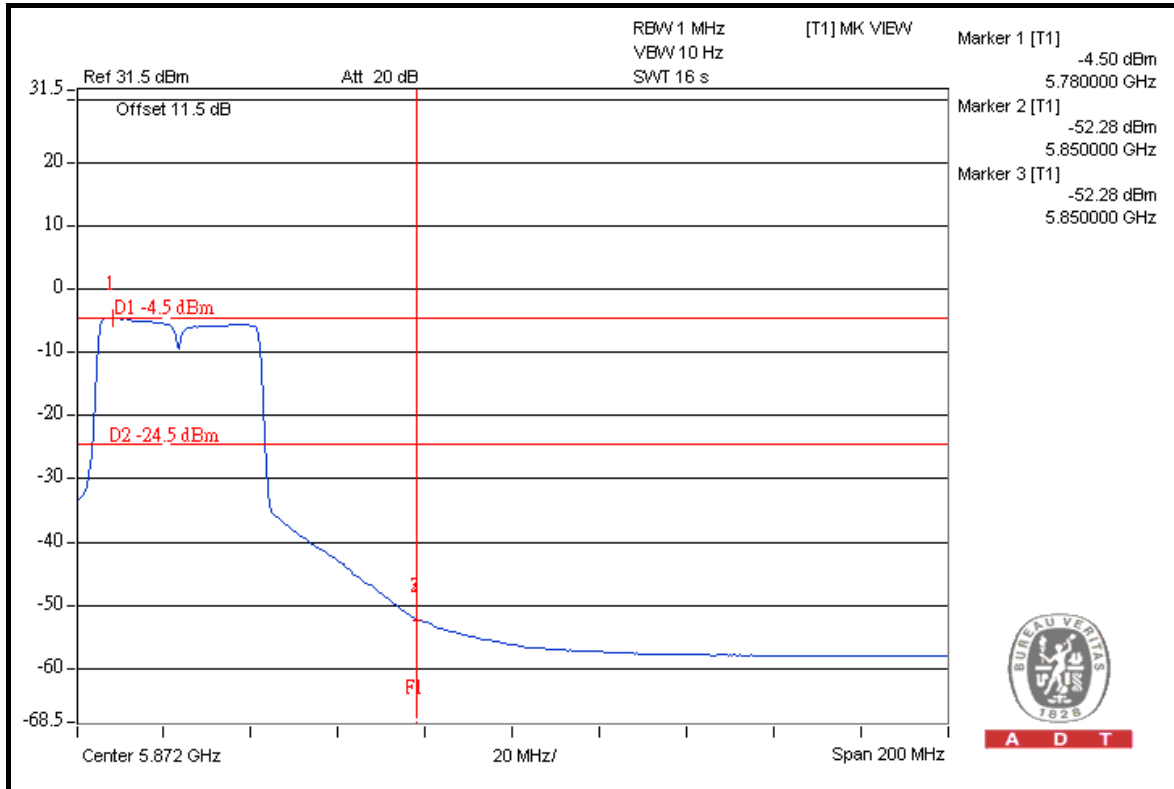



A D T

6. PHOTOGRAPHS OF THE TEST CONFIGURATION

Please refer to the attached file (Test Setup Photo).



A D T

7. INFORMATION ON THE TESTING LABORATORIES

We, Bureau Veritas Consumer Products Services (H.K.) Ltd., Taoyuan Branch, were founded in 1988 to provide our best service in EMC, Radio, Telecom and Safety consultation. Our laboratories are accredited and approved according to ISO/IEC 17025.

Copies of accreditation certificates of our laboratories obtained from approval agencies can be downloaded from our web site:

www.adt.com.tw/index.5.phtml. If you have any comments, please feel free to contact us at the following:

Linko EMC/RF Lab:

Tel: 886-2-26052180

Fax: 886-2-26051924

Hsin Chu EMC/RF Lab:

Tel: 886-3-5935343

Fax: 886-3-5935342

Hwa Ya EMC/RF/Safety Telecom Lab:

Tel: 886-3-3183232

Fax: 886-3-3185050

Email: service.adt@tw.bureauveritas.com

Web Site: www.adt.com.tw

The address and road map of all our labs can be found in our web site also.



A D T

8. APPENDIX A - MODIFICATIONS RECORDERS FOR ENGINEERING CHANGES TO THE EUT BY THE LAB

No any modifications are made to the EUT by the lab during the test.

---END---