

BTS002

Mini Bluetooth stereo speaker

User's manual

■ Brief introduction	2
1. Bluetooth wireless communication technology.....	2
2. About the speaker.....	3
■ Getting started	3
1. Overview.....	4
2. Charging the battery of the speaker.....	4
■ Using the speaker	4
1. Turning on/off the speaker.....	5
2. Pairing the speaker with Bluetooth devices.....	5
How to enter pairing mode.....	5
Pairing the speaker with Bluetooth mobile phone.....	5
Pairing the speaker with Bluetooth transmitter.....	6
3. Making a call with the speaker.....	6
4. Music playback.....	8
5. Re-connecting with a Bluetooth device.....	8
6. Auto-off.....	9
7. Using the speaker with an external device.....	9
8. Connecting with a non Bluetooth device.....	10
9. LED indicator.....	11
10. Indication tone.....	11
■ Care and maintenance	12
■ FAQs	12
■ Specifications	13

Welcome to use this Bluetooth stereo speaker, BTS002. Please read this user's manual carefully before use.

■ Brief introduction

1. Bluetooth wireless communication technology

Bluetooth is a standard of close range radio-communication technology that was drawn up by Ericsson, IBM, Intel, Nokia and Toshiba. With Bluetooth technology, we can achieve the highest transmission rate among cell phones, computers, printers, PDAs and other devices. The max transmission range of class II is 10 meters while the max transmission range of class I can reach up to 100 meters.

2. About the speaker

BTS002 is a Bluetooth stereo speaker. It supports the following profiles:

HFP—Hands-free Profile

A2DP—Advanced Audio Distribution Profile

AVRCP—Audio/Video Remote Control Profile

You can listen to music wirelessly using BTS002. It has the following features:

- 1) Pairing with a Bluetooth mobile phone or PDA supporting HFP.
 - ◆ Answer a call, end a call and reject a call
 - ◆ Redial last number
 - ◆ Voice dial
 - ◆ Adjust the volume
 - ◆ Three-way calling
 - ◆ Calls transfer
 - ◆ Microphone mute

- 2) Pairing with a Bluetooth music device or Bluetooth transmitter supporting A2DP.
 - ◆ Enjoy music wirelessly
 - ◆ Adjust the volume
 - ◆ Remote control pause/play
 - ◆ Remote control previous/next track

- 3) Easy to switch between the conversation and music, you will not miss incoming calls while listening to music.

- 4) Every time the speaker is turned on, it will connect to the last connected device automatically.

Remark:

Even though the paired device and the speaker support the same Bluetooth profiles, functions may vary due to specification differences of the paired devices.

■ **Getting started**

1. Overview



2. Charging the battery of the speaker

The speaker comes with a built-in rechargeable battery, prior to using it, it is recommendable to charge the battery fully for the first time.

Connect the USB cable to an computer USB port and the USB cable plug to the charging socket of the speaker. The LED will be red while charging. It takes about 2.5 hours to charge the battery fully. When charging has completed, the LED will be off.



When the speaker is on and the battery becomes low, the LED flashes red for twice and the speaker emits three “Dong” tones every 10 seconds. Please recharge the battery fully as described above.

Remarks:

- 1) The battery will dry up if you don't use the speaker for a long time. If this happens you have to charge the battery of the speaker for about 30 minutes before the LED indicator will be on.
- 2) Please don't attempt to take out the battery from the speaker, as this might damage it.

■ Using the speaker

1. Turning on/off the speaker

Functions	Operations	LED indicator	Indication tone
Turning on the speaker	Press and hold  button for about 3~5 seconds until the LED flashes blue	The LED flashes blue	A string of tones
Turning off the speaker	Press and hold  button for about 2~3 seconds until the LED flashes red	The LED flashes red	A string of tones

2. Pairing the speaker with Bluetooth devices

How to enter pairing mode

Function	Status of the speaker	Operation	LED indicator
Entering pairing mode	Turned on	Press and hold  button for 7~8 seconds	The LED flashes red and blue alternately

Remarks:

- 1) If the pairing can not be completed within 3 minutes, the speaker will exit pairing mode.
- 2) You will hear two “Dong” tones while the speaker enters pairing mode.
- 3) The speaker will return to pairing mode automatically if it disconnects with Bluetooth device.

Pairing the speaker with Bluetooth mobile phone

Prior to using the speaker for the first time, you have to pair it with a Bluetooth-enabled mobile phone. The pairing procedure is subject to different models of mobile phones. Please refer to your mobile phone user’s manual for details. The general pairing procedure are as follows:

- 1) Place the speaker and Bluetooth mobile phone where they are easily viewable by no more than 1 meter apart;
- 2) Make sure the speaker is off, otherwise switch it off first;
- 3) Enter the speaker’s pairing mode (please refer to “How to enter pairing mode”);
- 4) Activate your mobile phone’s Bluetooth function and set your mobile phone to search for Bluetooth devices. After the search is completed, select “BTS002” from the Bluetooth device list;
- 5) According to the indication, enter password or PIN No:”0000” and press ” Yes” or “confirm”;
- 6) Go back to your mobile phone’s main menu. For certain mobile phone models, a speaker icon will be shown on the screen. You should now be able to listen to music and make calls using the speaker.

Remarks:

- ◆ If the pairing is failed, please turn off the speaker first and then re-pair according to steps 1~6 mentioned above.
- ◆ After pairing is successful, the speaker and the mobile phone will remember each other, the speaker will not need to re-pair next time. The speaker can remember 8 paired devices. When the number of paired.
- ◆ Every time the speaker is turned on, it will connect to the last connected device automatically. If you want to pair it with other devices, please turn

off the Bluetooth function of the last connected devices first and pair the speaker with the new device according to steps 1~6 mentioned above.

Pairing the speaker with Bluetooth transmitter

You can connect the speaker to a Bluetooth transmitter to enjoy music wirelessly. Hereby taken BTT001 iPod Bluetooth transmitter for example. The pairing procedure are as follows:





- 1) Place the speaker and Bluetooth transmitter where they are easily viewable by no more than 1 meter apart;
- 2) Enter the speaker's pairing mode (Please refer to "How to enter pairing mode");
- 3) Turn on the Bluetooth transmitter. It will search for Bluetooth devices automatically and send a pairing request;
- 4) When the speaker requests to enter a PIN No., the transmitter will response "0000" automatically;
- 5) After successful pairing and connecting, the LED will flash blue for twice every 4 seconds.











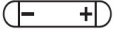



Remarks:

- ◆ The pairing password of BTS002 is "0000". So, BTS002 can only pair with Bluetooth transmitters whose pairing password is "0000", too.
- ◆ If pairing still fails after several tries, refer to the Bluetooth transmitter's user's manual for further information.

3. Making a call with the speaker

Functions	Status of the speaker	Operations
Basic conversation functions		
Answer a call	Incoming ring	Short press  button once
Reject a call	Incoming ring	Press and hold  button for about 2 seconds until you hear indication tone
Cancel calling	Calling	Short press  button once
End a call	During a call	Short press  button once





Adjust the volume	During a call	Press  button to adjust the volume
Microphone mute	During a call	Short press  button twice quickly
Cancel mute	Microphone mute	Short press  button twice quickly
Call transfer (speaker to mobile phone)	During a call (speaker)	Press and hold  button for about 2 seconds until you hear indication tone
Call transfer (mobile phone to speaker)	During a call (mobile phone)	Press and hold  button for about 2 seconds until you hear indication tone
Redial last number	Standby mode and connected	Press and hold  button once
Voice dial	Standby mode and connected	Short press  button twice quickly
Three-way calling function		
Answer a new incoming call and end current call	There is a new incoming call	Short press  button
Reject a new incoming call and continue current call	There is a new incoming call	Press and hold  button
Answer a new incoming call and keep current call	There is a new incoming call	Short press  button
Switch between two calls	During a call (Keeping a call)	Short press  button
End current call and switch to the keeping call	During a call (Keeping a call)	Short press  button

Remarks:

- 1) Not all mobile phones support all functions listed above. Please refer to your mobile phone's user's manual for further information.
- 2) When pressing the answer button on some mobile phones, the call will be sent to the mobile phone. You have to switch the call to the speaker manually then. Please refer to your mobile phone's user's manual for further information.

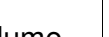
4. Music playback

After connecting the speaker to a Bluetooth mobile phone or Bluetooth transmitter supporting A2DP, you can enjoy music with the speaker. If you want to remote control previous/next track, pause/play, it needs the Bluetooth mobile phone or Bluetooth transmitter paired with the speaker to support AVRCP.

Functions	Status of the speaker	Operation
Adjust the volume	Playing music	Press  button to adjust the volume
Previous track	Playing music	Short press  button once
Next track	Playing music	Short press  button once
Pause	Playing music	Short press  button once
Play	Pausing	Short press  button once

Remark:When playing music on some mobile phones, the music will be transmitted to the mobile phone's speaker instead to the speaker. You have to select to transmit the sound via Bluetooth in the settings menu then and choose "BTS002" as speaker device. The music will be transmitted to the speaker then. Please refer to the your mobile phone's user manual for further information.

5. Re-connecting with a Bluetooth device



1) Automatic connecting

Every time the speaker is turned on, it will connect to the last connected device automatically.

2) Connecting manually

When the speaker is in standby mode, press **MFB** button once to connect the speaker to the last connected device.

Remarks:

- ◆ Short press  button once, the speaker will connect to last connected HFP device automatically. Short press  once, the speaker will connect to last connected A2DP device.
- ◆ Before connecting to a Bluetooth device, please switch on the Bluetooth device's Bluetooth function.
- ◆ On some Bluetooth devices, take some Nokia mobile phones for example, you have to allow automatic connecting in the mobile phone's settings. Please refer to the mobile phone's manual for further information.

6. Auto-off

The speaker will turn off automatically if no devices can be connected after 5 minutes in order to save power.

Remark: When the speaker disconnects with a Bluetooth device, it will return to pairing mode for 3 minutes then return to standby mode for 5 minutes, at last it will turn off automatically.

7. Using the speaker with an external device

You can listen to music through your car audio system or home audio system from your stereo speaker.

Step 1: Turn LINE IN/OUT button to “OUT” as the following picture shows:

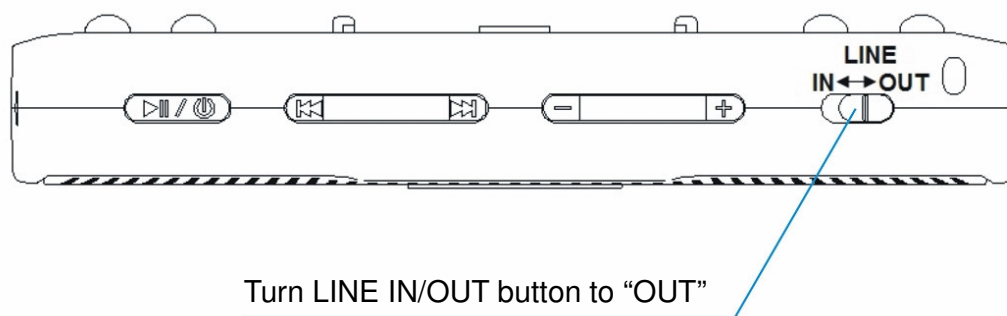

Step 2: Use a Line-out cable to connect the LINE port to your car audio system or home audio system as the following picture shows:

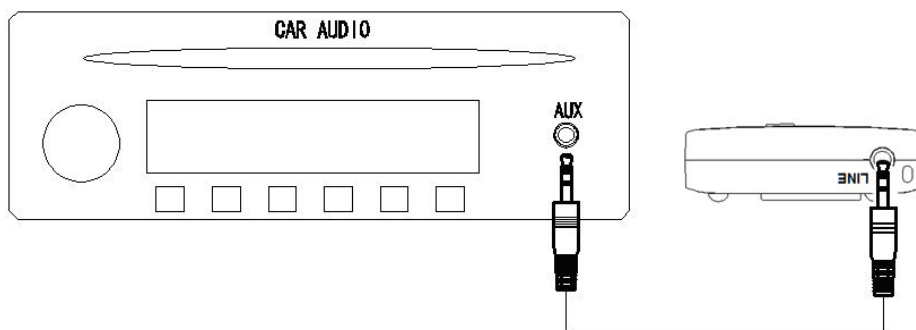

Please read your car audio system's user manual or home audio system's user manual to understand how to activate and use the stereo Line in function.

8. Connecting with a non Bluetooth device

You can listen to music through the stereo speaker from an external device that does not even support the Bluetooth function.

Step 1: Turn LINE IN/OUT button to “IN” as the following picture shows:

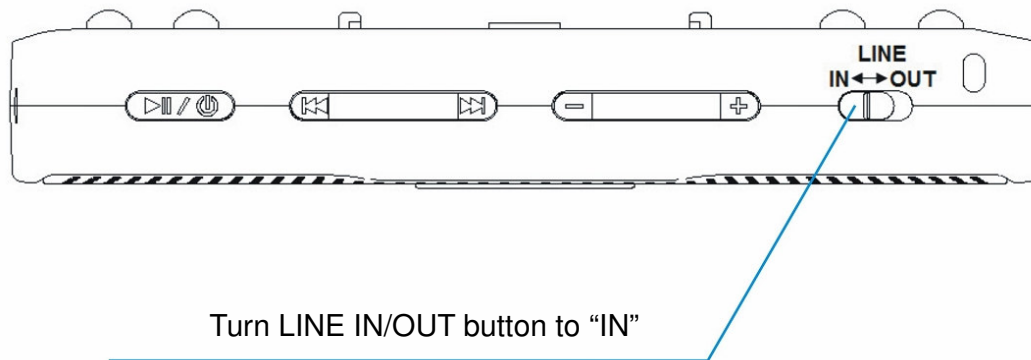

Step 2: Use a Line-in cable to connect the Line-out port of the external music player to the LINE port of the speaker as the following picture shows:



Step 3: Play music from your music player.

Remarks:

- 1) When using Line-in function, the speaker LED will be red, and the speaker will not turn off automatically.
- 2) When using Line-in function, the speaker will disconnect with Bluetooth device. When unplug the Line-in cable, the speaker will connect to the last connected device automatically.

9. LED indicator

While the speaker is charging

LED indicator	Status of the speaker
The LED is red	Charging in progress
The LED is off	Finish charging

While the speaker is not charging

LED indicator	Status of the speaker
The LED flashes red and blue alternately	Pairing mode
The LED flashes blue for twice every 2 seconds	Not connected
The LED flashes blue for twice every 5 seconds	Set up HFP connection
The LED flashes blue for twice every 5 seconds	Set up A2DP connection
The LED flashes blue for 3 times every 2 seconds	Incoming call/calling
The LED flashes blue for once every 3 seconds	During a call
The LED flashes red for twice every 10 seconds	Low power
The LED is red	Plug Line-in cable

10. Indication tone

Indication tone	Status of the speaker
Emits 2 “DU” tones every 5 seconds	Microphone mute
Emits 3 “Dong” tones every 10 seconds	Low power

■ Care and maintenance

Read the following recommendations before using the speaker. Following these you will be able to enjoy our product for many years.

- ◆ Do not expose the speaker to liquid, moisture or humidity to avoid the product's internal circuit being affected.
- ◆ Don't use abrasive cleaning solvents to clean the speaker.
- ◆ Do not expose the speaker to extremely high or low temperatures as this will shorten the life of electronic devices, destroy the battery or distort certain plastic parts
- ◆ Don't dispose of the speaker in a fire as it will result in an explosion
- ◆ Don't expose the speaker to contact with sharp objects as this will cause scratches and damage.
- ◆ Don't let it fall down onto the floor. The internal circuit might get damaged.
- ◆ Don't attempt to disassemble the product as it may get damaged if you are not professional.

In case the speaker doesn't function properly, send it to the store you bought it. The staff will help you to solve the problem.

■ FAQs

1. What to do when my mobile phone can not search the speaker?

- a) Make sure the speaker has entered pairing mode;
- b) Ensure the speaker is in the effective working range.

2. What to do when the effect of conversation is not satisfactory?

- a) Make sure the speaker is in strong-signal area;
- b) Ensure the speaker is in the effective working range.

3. How far is the effective range between the speaker and a Bluetooth mobile phone?

According to the Bluetooth standard, the max. controllable range of Class2 Bluetooth product is 10 meters. It varies with different environments and paired cell phones.

4. Why is there no sound when making a call with the speaker?

- a) Make sure the speaker has connected with the mobile phone;
- b) Ensure the volume of the speaker has been adjusted to proper position.

- 5. Why is there no sound when playing music with the speaker?**
- Make sure the speaker has connected with Bluetooth device well;
 - Ensure the paired device supports A2DP.
- 6. Why can't I remotely control the pause, play, previous track and next track functions with the speaker when playing music?**
- The function needs the Bluetooth device paired with the speaker to support AVRCP (Audio/Video Remote Control Profile). Please make sure your mobile phone or Bluetooth transmitter supports AVRCP.

■ Specifications

Bluetooth specification	Bluetooth V2.1
Bluetooth profiles	HFP, A2DP, and AVRCP
Bluetooth frequency range	2.402GHz~2.480GHz
Operating distance	10 meters
Talk time	Up to 6 hours
Music playing time	Up to 6 hours
Charing input	DC 5V  500 mA
Charging time	Approx 2.5 hours
Dimensions	94×50×16mm
Weight	56.2g

This device complies with Part 15 of the FCC Rules. Operation is subject to the following two conditions: (1) this device may not cause harmful interference, and (2) this device must accept any interference received, including interference that may cause undesired operation.

Changes or modifications not expressly approved by the party responsible for compliance could void the user's authority to operate the equipment.