



FCC TEST REPORT

**Test report
On Behalf of
Zhongshan K-mate General Electronics Co., Ltd.
For
Bluetooth Stereo Headset
Model No.: BTH152R

FCC ID: WAD-BTH152R**

Prepared for : Zhongshan K-mate General Electronics Co., Ltd.
NO.2, 5th Xinsheng Street, Gangkou Town, Zhongshan City, Guangdong, China

Prepared By : Shenzhen HUAKE Testing Technology Co., Ltd.
1F, B2 Building, Junfeng Zhongcheng Zhizao Innovation Park, Fuhai Street,
Bao'an District, Shenzhen City, China

Date of Test: Oct. 13, 2018 ~ Oct. 25, 2018
Date of Report: Nov. 01, 2018
Report Number: HK1810121270E



Table of Contents	Page
1 . TEST SUMMARY	5
2 . GENERAL INFORMATION	6
2.1 . GENERAL DESCRIPTION OF EUT	6
2.2 . CARRIER FREQUENCY OF CHANNELS	7
2.3 . OPERATION OF EUT DURING TESTING	7
2.4 . DESCRIPTION OF TEST SETUP	8
2.5. EQUIPMENT USED IN EUT SYSTEM	8
2.6. MEASUREMENT INSTRUMENTS LIST	9
3. ANTENNA REQUIREMENT	10
4. RADIATED EMISSION	11
4.1 LIMITS	11
4.2 MEASUREMENT PROCEDURE	11
4.3 TEST SETUP	12
4.4 TEST RESULT (Worst Modulation: GFSK)	14
5. BAND EDGE EMISSION	26
5.1. MEASUREMENT PROCEDURE	26
5.2. TEST SET-UP	26
5.3. TEST RESULT	27
6. 6DB BANDWIDTH	31
6.1. TEST PROCEDURE	31
6.2. SUMMARY OF TEST RESULTS/PLOTS	31
7. CONDUCTED OUTPUT POWER	33
7.1. MEASUREMENT PROCEDURE	33
7.2. TEST SET-UP (BLOCK DIAGRAM OF CONFIGURATION)	33
7.3. LIMITS AND MEASUREMENT RESULT	34
8. CONDUCTED SPURIOUS EMISSION	36
8.1. MEASUREMENT PROCEDURE	36
8.2. TEST SET-UP (BLOCK DIAGRAM OF CONFIGURATION)	36
8.3. LIMITS AND MEASUREMENT RESULT	36
9. CONDUCTED OUTPUT POWER SPECTRAL DENSITY	40
9.1 MEASUREMENT PROCEDURE	40
9.2 TEST SET-UP (BLOCK DIAGRAM OF CONFIGURATION)	40
9.3 LIMITS AND MEASUREMENT RESULT	40
10. LINE CONDUCTED EMISSION TEST	43



Table of Contents	Page
10.1 LIMITS	43
10.2 TEST SETUP	43
10.3 PRELIMINARY PROCEDURE	44
10.4 FINAL TEST PROCEDURE	44
10.5 TEST RESULT OF POWER LINE	44
11. ANTENNA REQUIREMENT	45
12. PHOTOGRAPH OF TEST	46
13. PHOTOGRAPHS OF EUT	48



1. TEST SUMMARY

1.1. TEST PROCEDURES AND RESULTS

DESCRIPTION OF TEST	RESULT
ANTENNA REQUIREMENT	COMPLIANT
RADIATED EMISSION	COMPLIANT
BAND EDGES	COMPLIANT
6 DB BANDWIDTH	COMPLIANT
CONDUCTED OUTPUT POWER	COMPLIANT
CONDUCTED SPURIOUS EMISSION	COMPLIANT
CONDUCTED POWER SPECTRAL DENSITY	COMPLIANT
LINE CONDUCTION EMISSION	N/A
ANTENNA REQUIREMENT	COMPLIANT

Note: N/A means it's not applicable to this item.

1.2. TEST FACILITY

Test Firm : Shenzhen HUAKE Testing Technology Co., Ltd.

Address : 1F, B2 Building, Junfeng Zhongcheng Zhizao Innovation Park,
Fuhai Street, Bao'an District, Shenzhen City, China

Designation Number: : CN1229

Test Firm Registration Number : 616276

1.3. MEASUREMENT UNCERTAINTY

Measurement Uncertainty

Conducted Emission Expanded Uncertainty = 2.23dB, k=2

Radiated emission expanded uncertainty(9kHz-30MHz) = 3.08dB, k=2

Radiated emission expanded uncertainty(30MHz-1000MHz) = 4.42dB, k=2

Radiated emission expanded uncertainty(Above 1GHz) = 4.06dB, k=2



2. GENERAL INFORMATION

2.1. GENERAL DESCRIPTION OF EUT

Operation Frequency	2.402 GHz to 2.480GHz
RF Output Power	4.12dBm(Max)
Bluetooth Version	V5.0
Modulation	BR <input type="checkbox"/> GFSK, EDR <input type="checkbox"/> π /4-DQPSK, <input type="checkbox"/> 8DPSK BLE <input checked="" type="checkbox"/> GFSK
Number of channels	40 for BLE
Hardware Version	BTH132RMB-V06
Software Version	BTH152R-V08
Antenna Designation	Fixed Antenna
Antenna Gain	2dBi
Power Supply	DC 3.7V by battery
Note: The USB port only used for charging and can't be used to transfer data with PC.	



2.2. CARRIER FREQUENCY OF CHANNELS

BLE Channel List

Frequency Band	Channel Number	Frequency
2400~2483.5MHz	0	2402MHz
	1	2404MHz
	:	:
	38	2478 MHz
	39	2480 MHz

2.3. OPERATION OF EUT DURING TESTING

NO.	TEST MODE DESCRIPTION
1	Low channel GFSK
2	Middle channel GFSK
3	High channel GFSK
4	BT Link(Hopping mode)

Note:

1. All the test modes can be supply by battery, only the result of the worst case was recorded in the report, if no other cases.
2. For Radiated Emission, 3axis were chosen for testing for each applicable mode.
3. The EUT used fully-charged battery when tested.



2.4. DESCRIPTION OF TEST SETUP

Configure 1: (Normal hopping)



Configure 2: (Control continuous TX)

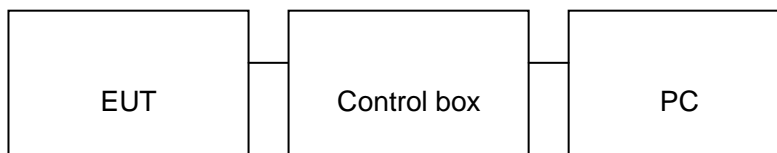

2.5. EQUIPMENT USED IN EUT SYSTEM

Item	Equipment	Mfr/Brand	Model/Type No.	Remark
1	Bluetooth Stereo	K-mate	BTH152R	EUT
2	Battery	ZWD	12130	Accessory
3	PC	APPLE	A1465	A.E
4	Control box	DOFLY	N/A	A.E
5	IPOD	APPLE	A1367	A.E

Note: The temporary antenna connector is a RF SMA connector with fifty ohm resistor, which is welded to the PCB board or module.

**2.6. MEASUREMENT INSTRUMENTS LIST****TEST EQUIPMENT OF RADIATED EMISSION TEST**

Item	Equipment	Manufacturer	Model No.	Lab Equipment No.	Last Cal.	Cal. Interval
1.	Spectrum analyzer	Agilent	N9020A	HKE-048	Dec. 28, 2017	1 Year
2.	Preamplifier	Schwarzbeck	BBV 9743	HKE-006	Dec. 28, 2017	1 Year
3.	EMI Test Receiver	Rohde & Schwarz	ESCI 7	HKE-010	Dec. 28, 2017	1 Year
4.	Bilog Broadband Antenna	Schwarzbeck	VULB9163	HKE-012	Dec. 28, 2017	1 Year
5.	Loop Antenna	Schwarzbeck	FMZB 1519 B	HKE-014	Dec. 28, 2017	1 Year
6.	Horn Antenna	Schwarzbeck	9120D	HKE-013	Dec. 28, 2017	1 Year
7.	Broad-band Horn Antenna	A-INFOMW	LB-180400-K F	HKE-031	Dec. 28, 2017	1 Year
8.	Pre-amplifier	EMCI	EMC051845S E	HKE-015	Dec. 28, 2017	1 Year
9.	Pre-amplifier	Agilent	83051A	HKE-016	Dec. 28, 2017	1 Year
10.	Radiation Cable 1	MXT	HK1	R05	N/A	N/A
11.	Radiation Cable 2	MXT	HK1	R06	N/A	N/A



3. ANTENNA REQUIREMENT

3.1. STANDARD APPLICABLE

According to FCC 15.203, An intentional radiator shall be designed to ensure that no antenna other than that furnished by the responsible party shall be used with the device. The use of a permanently attached antenna or of an antenna that uses a unique coupling to the intentional radiator shall be considered sufficient to comply with the provisions of this Section. The manufacturer may design the unit so that a broken antenna can be replaced by the user, but the use of a standard antenna jack or electrical connector is prohibited. This requirement does not apply to carrier current devices or to devices operated under the provisions of Sections 15.211, 15.213, 15.217, 15.219, or 15.221. Further, this requirement does not apply to intentional radiators that must be professionally installed, such as perimeter protection systems and some field disturbance sensors, or to other intentional radiators which, in accordance with Section 15.31(d), must be measured at the installation site. However, the installer shall be responsible for ensuring that the proper antenna is employed so that the limits in this Part are not exceeded.

3.2. TEST RESULT

This product has a permanent antenna, fulfill the requirement of this section.



4. RADIATED EMISSION

4.1 LIMITS

Frequency (MHz)	Distance Meters	Field Strengths Limit	
		μ V/m	dB(μ V)/m
0.009 ~ 0.490	300	2400/F(kHz)	---
0.490 ~ 1.705	30	24000/F(kHz)	---
1.705 ~ 30	30	30	---
30 ~ 88	3	100	40.0
88 ~ 216	3	150	43.5
216 ~ 960	3	200	46.0
960 ~ 1000	3	500	54.0
Above 1000	3	Other:74.0 dB(μ V)/m (Peak) 54.0 dB(μ V)/m (Average)	

Remark : (1) Emission level dB μ V = 20 log Emission level μ V/m
(2) The smaller limit shall apply at the cross point between two frequency bands.
(3) Distance is the distance in meters between the measuring instrument, antenna and the closest point of any part of the device or system.

4.2 MEASUREMENT PROCEDURE

1. The measuring distance of 3m shall be used for measurements. The EUT was placed on the top of a rotating table 0.8 meter above the ground at a 3 meter semi-anechoic chamber. The table was rotated 360 degrees to determine the position of the highest radiation(Below 1GHz)
2. The measuring distance of 3m shall used for measurements. The EUT was placed on the top of a rotating table 1.5 meter above the ground at a 3 meter semi-anechoic chamber. The table was rotated 360 degrees to determine the position of the highest radiation(Above 1GHz)
3. The height of the test antenna shall vary between 1m to 4m.Both horizontal and vertical polarization Of the antenna are set to make the measurement.
4. The initial step in collecting radiated emission data is a receive peak detector mode. Pre-scanning the measurement frequency range. Significant peaks are then marked and then Quasi Peak detector mode re-measured.
5. All readings are peak unless otherwise stated QP in column of Note. Peak denoted that the Peak reading compliance with the QP limits and then QP Mode measurement didn't perform(Below 1GHz)
6. All readings are Peak mode value unless otherwise stated AVG in column of Note. If the Peak mode measured value compliance with the Peak limits and lower than AVG Limits, the EUT shall be deemed to meet Peak&AVG limits and then only Peak mode was measured, but AVG mode didn't perform.(Above 1GHz)

4.3 TEST SETUP

RADIATED EMISSION TEST SETUP BELOW 30MHz

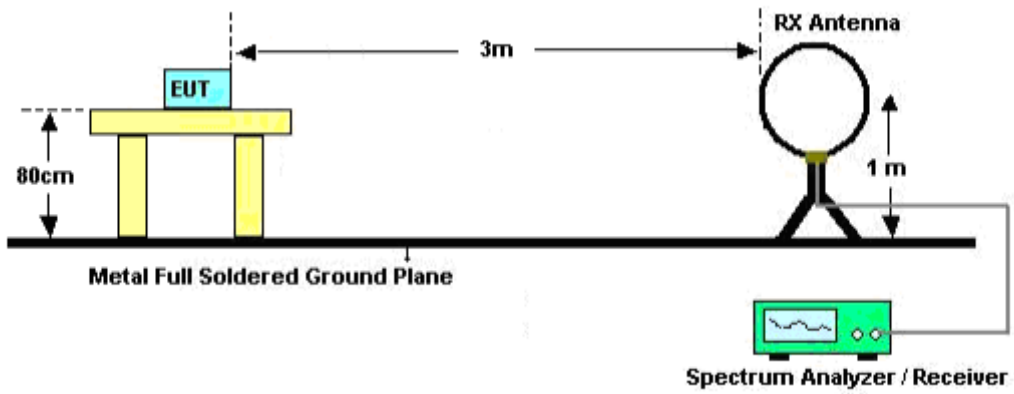

RADIATED EMISSION TEST SETUP 30MHz-1000MHz

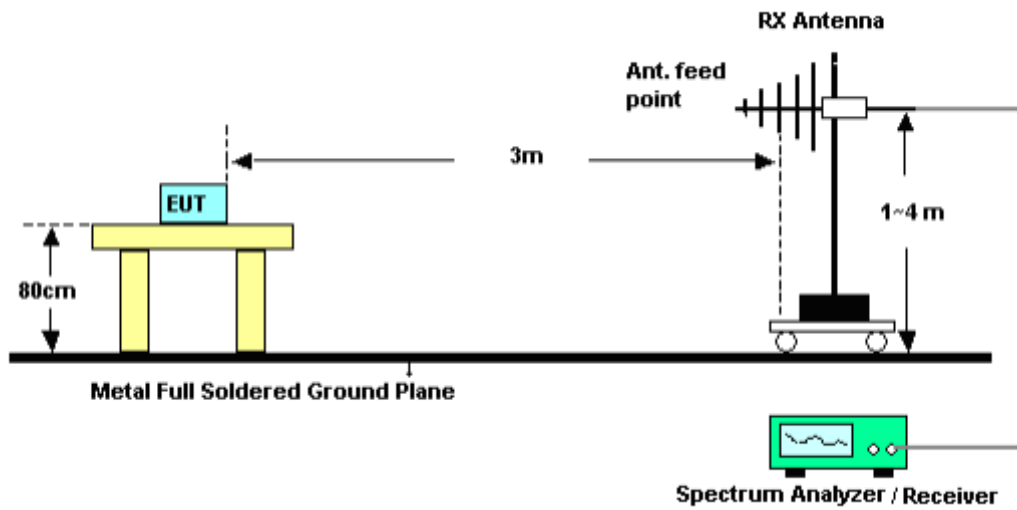



RADIATED EMISSION TEST SETUP ABOVE 1000MHz

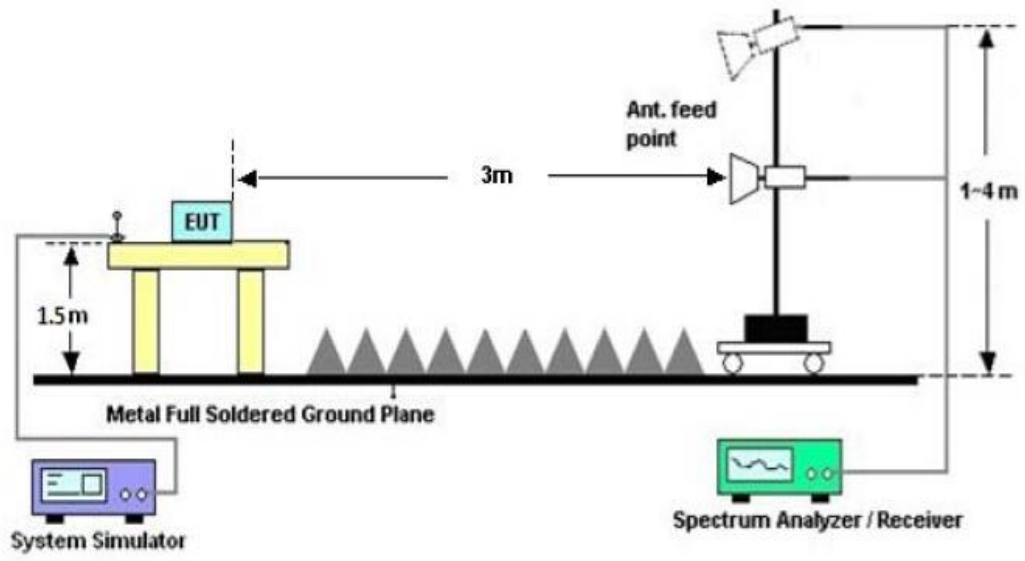



4.4 TEST RESULT

RADIATED EMISSION BELOW 30MHz

No emission found between lowest internal used/generated frequencies to 30MHz.

RADIATED EMISSION BELOW 1GHz

RADIATED EMISSION TEST- (30MHz-1GHz)-LOW CHANNEL-HORIZONTAL

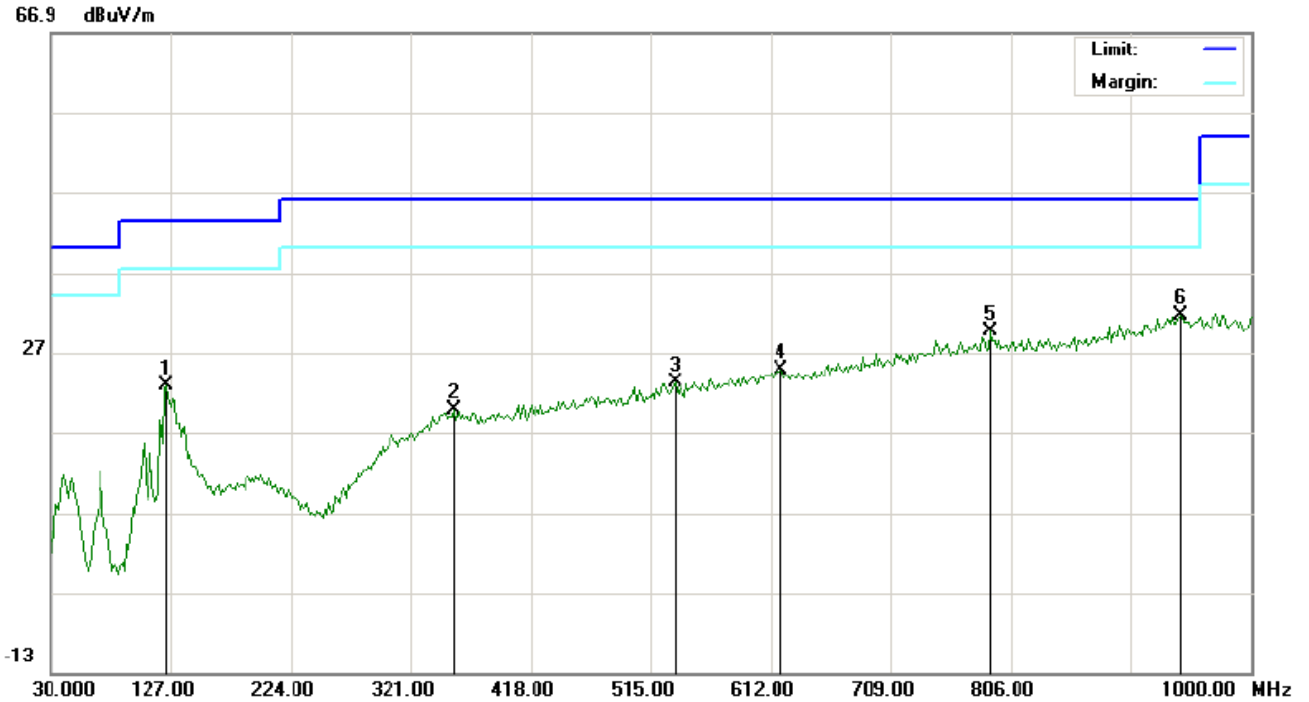

No.	Mk	Freq.	Reading	Factor	Measurement	Limit	Over	Detector	Antenna Height	Table Degree	Comment
		MHz	dBuV	dB/m	dBuV/m	dBuV/m	dB		cm	degree	
1		123.7667	15.13	7.62	22.75	43.50	-20.75	peak			
2		356.5667	0.95	18.78	19.73	46.00	-26.27	peak			
3		534.4000	1.15	22.06	23.21	46.00	-22.79	peak			
4		620.0833	1.00	23.78	24.78	46.00	-21.22	peak			
5		789.8333	2.34	27.18	29.52	46.00	-16.48	peak			
6	*	943.4167	1.70	29.82	31.52	46.00	-14.48	peak			

RESULT: PASS



RADIATED EMISSION TEST- (30MHz-1GHz)-LOW CHANNEL -VERTICAL

66.9 dBuV/m

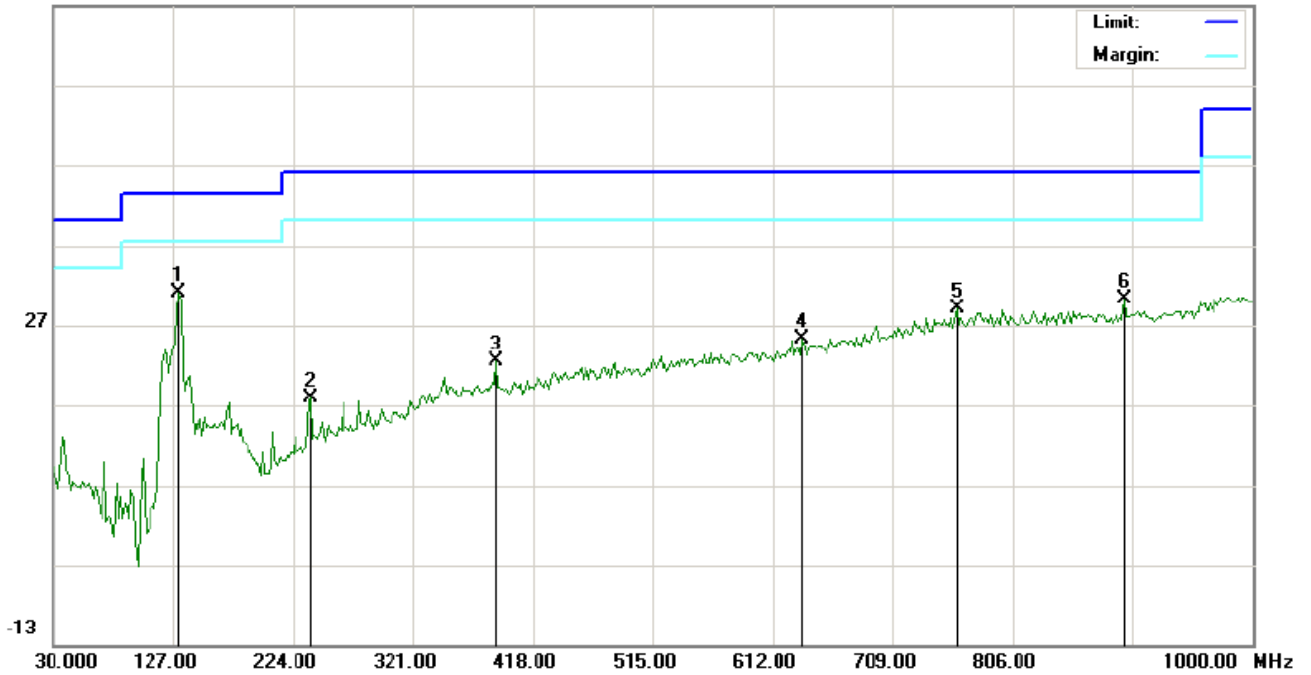

No.	Mk	Freq.	Reading	Factor	Measurement	Limit	Over	Detector	Antenna Height	Table Degree	Comment
		MHz	dBuV	dB/m	dBuV/m	dBuV/m	dB		cm	degree	
1	*	131.8500	19.11	11.80	30.91	43.50	-12.59	peak			
2		238.5500	4.97	12.78	17.75	46.00	-28.25	peak			
3		388.9000	3.40	19.00	22.40	46.00	-23.60	peak			
4		636.2500	1.66	23.54	25.20	46.00	-20.80	peak			
5		760.7333	2.20	26.78	28.98	46.00	-17.02	peak			
6		896.5333	1.62	28.52	30.14	46.00	-15.86	peak			

RESULT: PASS

Note: 1. Factor=Antenna Factor + Cable loss, Margin=Measurement-Limit.

2. The "Factor" value can be calculated automatically by software of measurement system.



RADIATED EMISSION TEST- (30MHz-1GHz)-MIDDLE CHANNEL-HORIZONTAL

66.9 dBuV/m

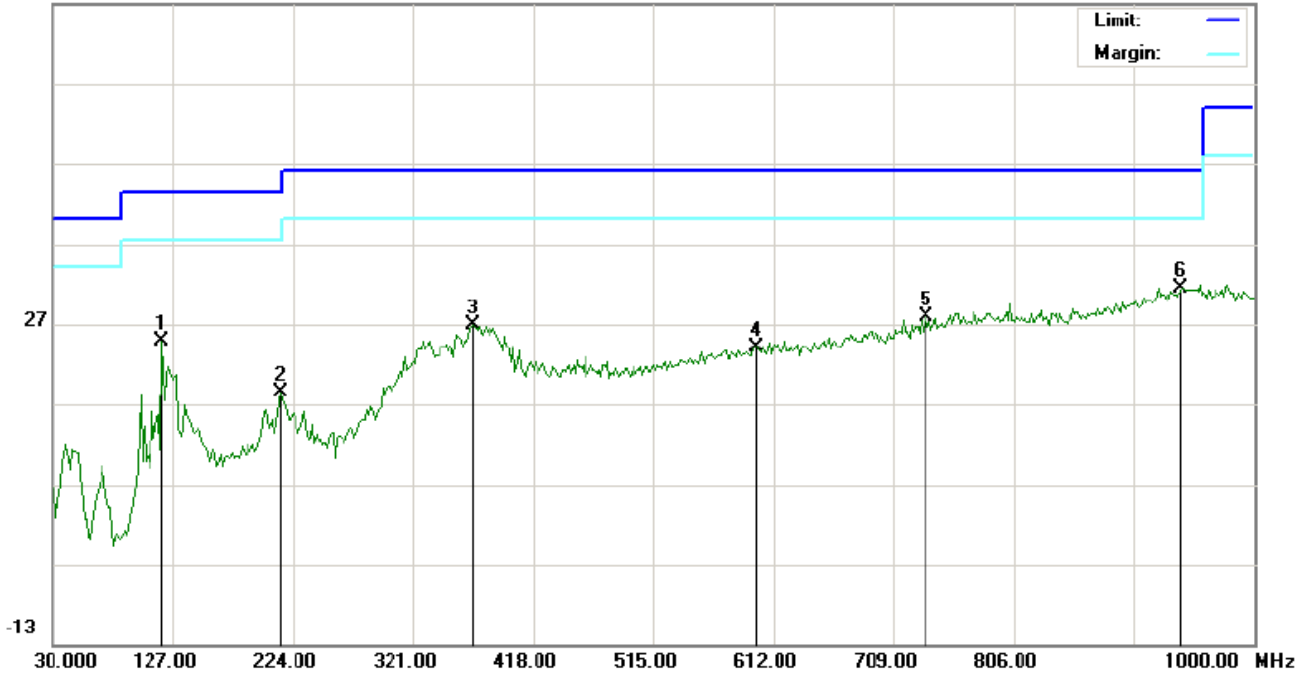

No.	Mk	Freq.	Reading	Factor	Measurement	Limit	Over	Detector	Antenna Height	Table Degree	Comment
		MHz	dBuV	dB/m	dBuV/m	dBuV/m	dB		cm	degree	
1		118.9167	18.65	6.11	24.76	43.50	-18.74	peak			
2		214.3000	7.81	10.54	18.35	43.50	-25.15	peak			
3		369.5000	7.99	18.87	26.86	46.00	-19.14	peak			
4		599.0666	0.29	23.71	24.00	46.00	-22.00	peak			
5		734.8667	1.66	26.20	27.86	46.00	-18.14	peak			
6	*	941.7999	1.61	29.77	31.38	46.00	-14.62	peak			

RESULT: PASS



RADIATED EMISSION TEST- (30MHz-1GHz)- MIDDLE CHANNEL -VERTICAL

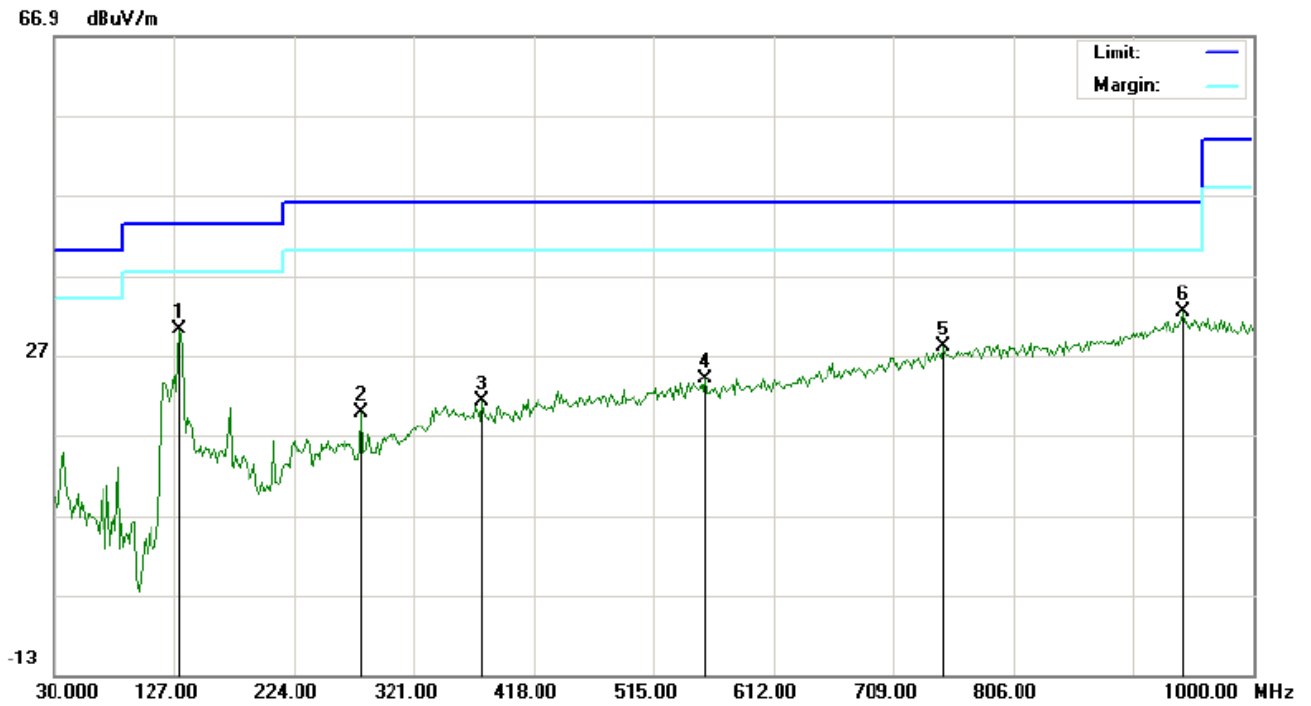

No.	Mk	Freq.	Reading	Factor	Measurement	Limit	Over	Detector	Antenna Height	Table Degree	Comment
		MHz	dBuV	dB/m	dBuV/m	dBuV/m	dB		cm	degree	
1	*	131.8500	18.41	11.80	30.21	43.50	-13.29	peak			
2		278.9667	5.00	14.77	19.77	46.00	-26.23	peak			
3		375.9667	2.38	18.91	21.29	46.00	-24.71	peak			
4		557.0333	1.41	22.52	23.93	46.00	-22.07	peak			
5		749.4167	1.33	26.61	27.94	46.00	-18.06	peak			
6		943.4167	2.60	29.82	32.42	46.00	-13.58	peak			

RESULT: PASS

Note: 1. Factor=Antenna Factor + Cable loss, Margin=Measurement-Limit.

2. The "Factor" value can be calculated automatically by software of measurement system.



RADIATED EMISSION TEST- (30MHz-1GHz)-HIGH CHANNEL-HORIZONTAL

66.9 dBuV/m



No.	Mk	Freq.	Reading	Factor	Measurement	Limit	Over	Detector	Antenna Height	Table Degree	Comment
		MHz	dBuV	dB/m	dBuV/m	dBuV/m	dB		cm	degree	
1		123.7667	17.13	7.62	24.75	43.50	-18.75	peak			
2		266.0332	12.35	9.63	21.98	46.00	-24.02	peak			
3		418.0000	3.28	19.62	22.90	46.00	-23.10	peak			
4		552.1833	-1.16	22.53	21.37	46.00	-24.63	peak			
5		789.8333	-1.16	27.18	26.02	46.00	-19.98	peak			
6	*	894.9166	2.02	28.48	30.50	46.00	-15.50	peak			

RESULT: PASS



RADIATED EMISSION TEST- (30MHz-1GHz)-HIGH CHANNEL -VERTICAL

66.9 dBuV/m

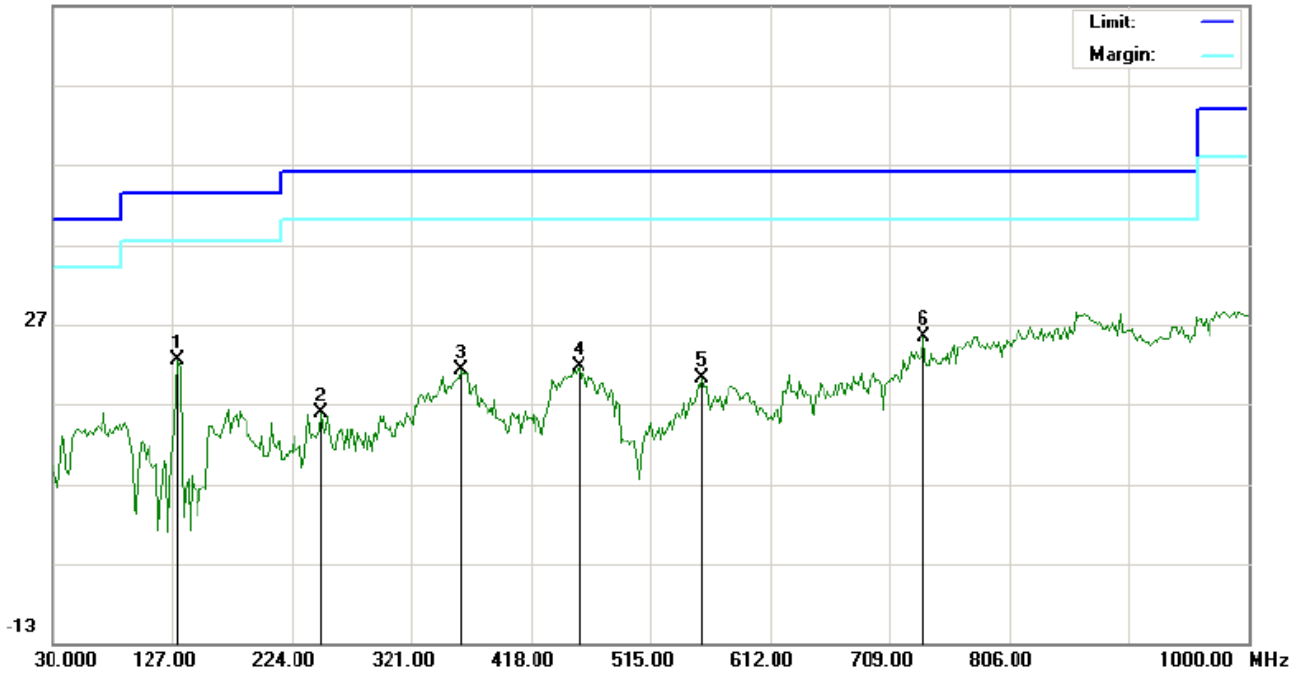

No.	Mk	Freq.	Reading	Factor	Measurement	Limit	Over	Detector	Antenna Height	Table Degree	Comment
		MHz	dBuV	dB/m	dBuV/m	dBuV/m	dB		cm	degree	
1		131.8499	10.61	11.80	22.41	43.50	-21.09	peak			
2		248.2500	2.06	13.73	15.79	46.00	-30.21	peak			
3		361.4166	2.37	18.82	21.19	46.00	-24.81	peak			
4		456.8000	0.86	20.66	21.52	46.00	-24.48	peak			
5		557.0333	-2.41	22.52	20.11	46.00	-25.89	peak			
6	*	736.4832	-0.85	26.24	25.39	46.00	-20.61	peak			

RESULT: PASS

Note: 1. Factor=Antenna Factor + Cable loss, Margin=Measurement-Limit.

2. The "Factor" value can be calculated automatically by software of measurement system.



RADIATED EMISSION ABOVE 1GHz
RADIATED EMISSION TEST- (ABOVE 1GHz)-LOW CHANNEL-HORIZONTAL

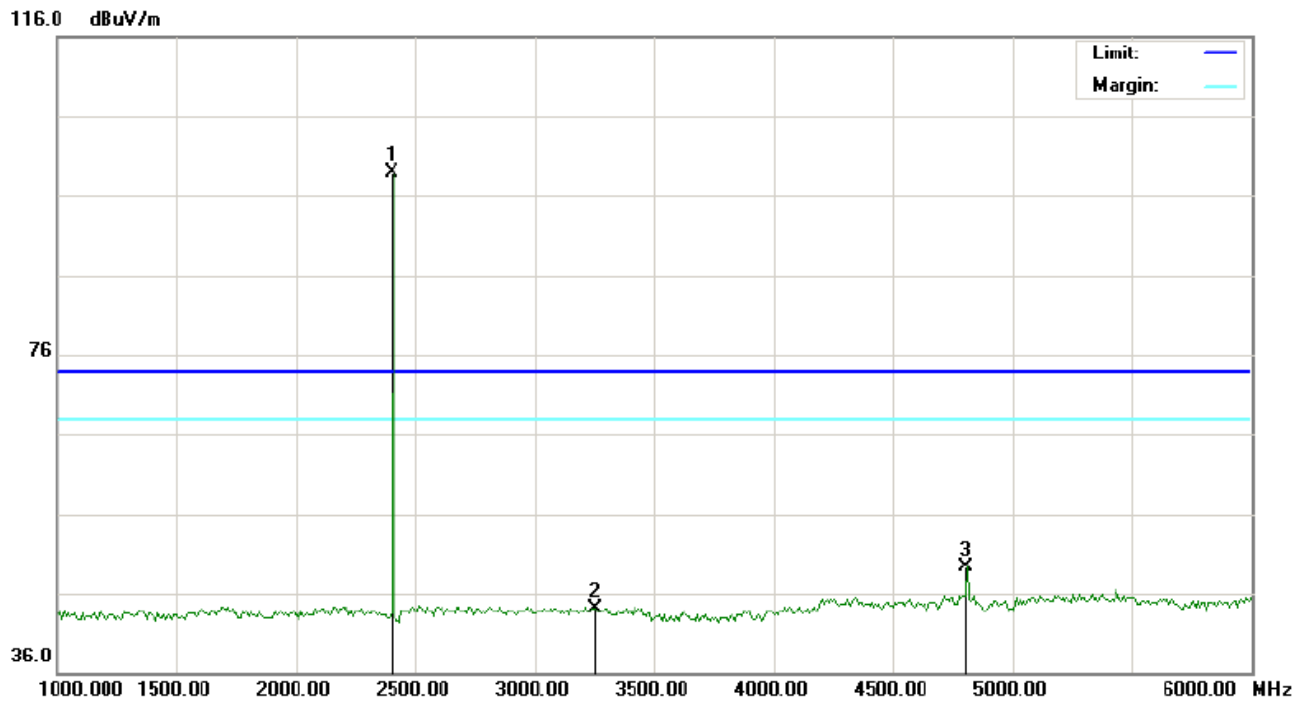

No.	Mk	Freq.	Reading	Factor	Measurement	Limit	Over	Detector	Antenna Height	Table Degree	Comment
		MHz	dBuV	dB/m	dBuV/m	dBuV/m	dB		cm	degree	
1	*	2402.000	88.49	10.32	98.81	74.00	24.81	peak			
2		3256.000	32.21	11.88	44.09	74.00	-29.91	peak			
3		4804.000	41.71	7.69	49.40	74.00	-24.60	peak			

RESULT: PASS



RADIATED EMISSION TEST-(ABOVE 1GHz)-LOW CHANNEL-VERTICAL

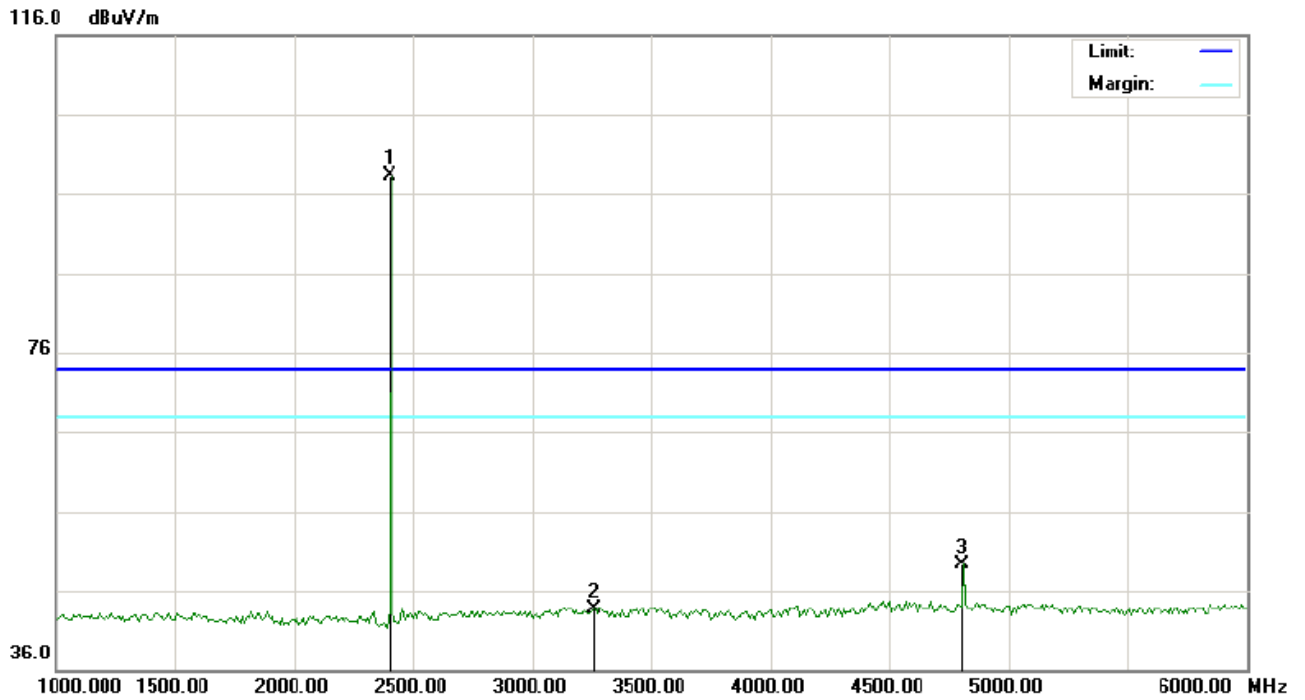

No.	Mk	Freq.	Reading	Factor	Measurement	Limit	Over	Detector	Antenna Height	Table Degree	Comment
		MHz	dBuV	dB/m	dBuV/m	dBuV/m	dB		cm	degree	
1	*	2402.000	88.03	10.32	98.35	74.00	24.35	peak			
2		3265.000	31.79	11.89	43.68	74.00	-30.32	peak			
3		4804.000	41.55	7.69	49.24	74.00	-24.76	peak			

RESULT: PASS

Note: 1. Factor=Antenna Factor + Cable loss, Margin=Measurement-Limit.

2. The “Factor” value can be calculated automatically by software of measurement system.



RADIATED EMISSION TEST-(ABOVE 1GHz)-MIDDLE CHANNEL-HORIZONTAL

116.0 dBuV/m

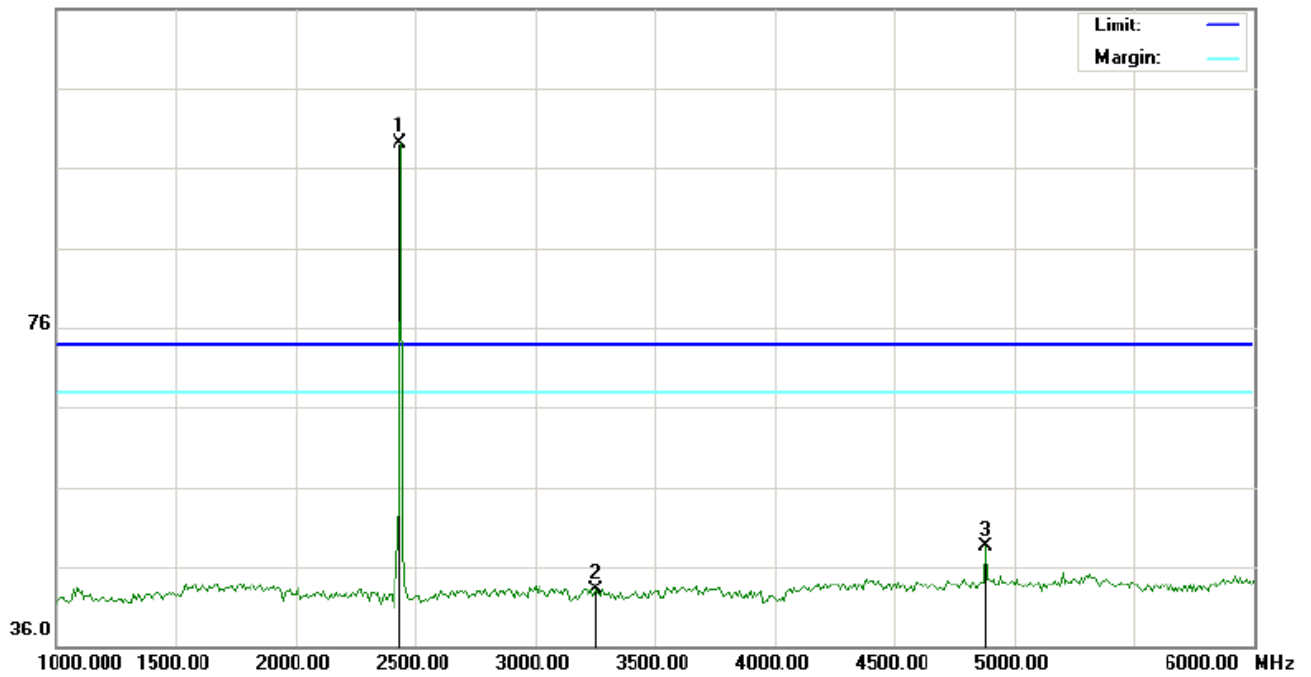

No.	Mk	Freq.	Reading	Factor	Measurement	Limit	Over	Detector	Antenna Height	Table Degree	Comment
		MHz	dBuV	dB/m	dBuV/m	dBuV/m	dB		cm	degree	
1	*	2440.000	88.79	10.36	99.15	74.00	25.15	peak			
2		3256.000	31.23	11.88	43.11	74.00	-30.89	peak			
3		4880.000	40.66	7.89	48.55	74.00	-25.45	peak			

RESULT: PASS



RADIATED EMISSION TEST-(ABOVE 1GHz)-MIDDLE CHANNEL-VERTICAL

116.0 dBuV/m

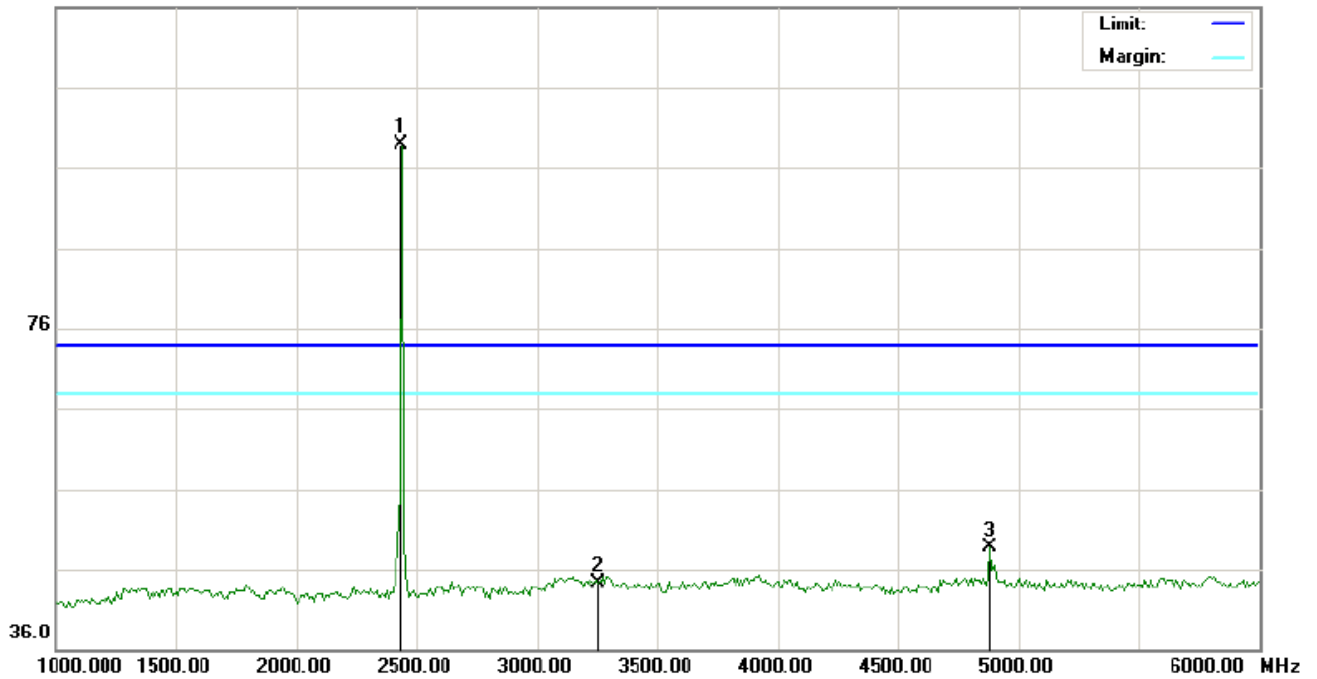

No.	Mk	Freq.	Reading	Factor	Measurement	Limit	Over	Detector	Antenna Height	Table Degree	Comment
		MHz	dBuV	dB/m	dBuV/m	dBuV/m	dB		cm	degree	
1	*	2440.000	88.49	10.36	98.85	74.00	24.85	peak			
2		3256.000	32.37	11.88	44.25	74.00	-29.75	peak			
3		4880.000	40.89	7.89	48.78	74.00	-25.22	peak			

RESULT: PASS

Note: 1. Factor=Antenna Factor + Cable loss, Margin=Measurement-Limit.

2. The "Factor" value can be calculated automatically by software of measurement system.



RADIATED EMISSION TEST-(ABOVE 1GHz)-HIGH CHANNEL-HORIZONTAL

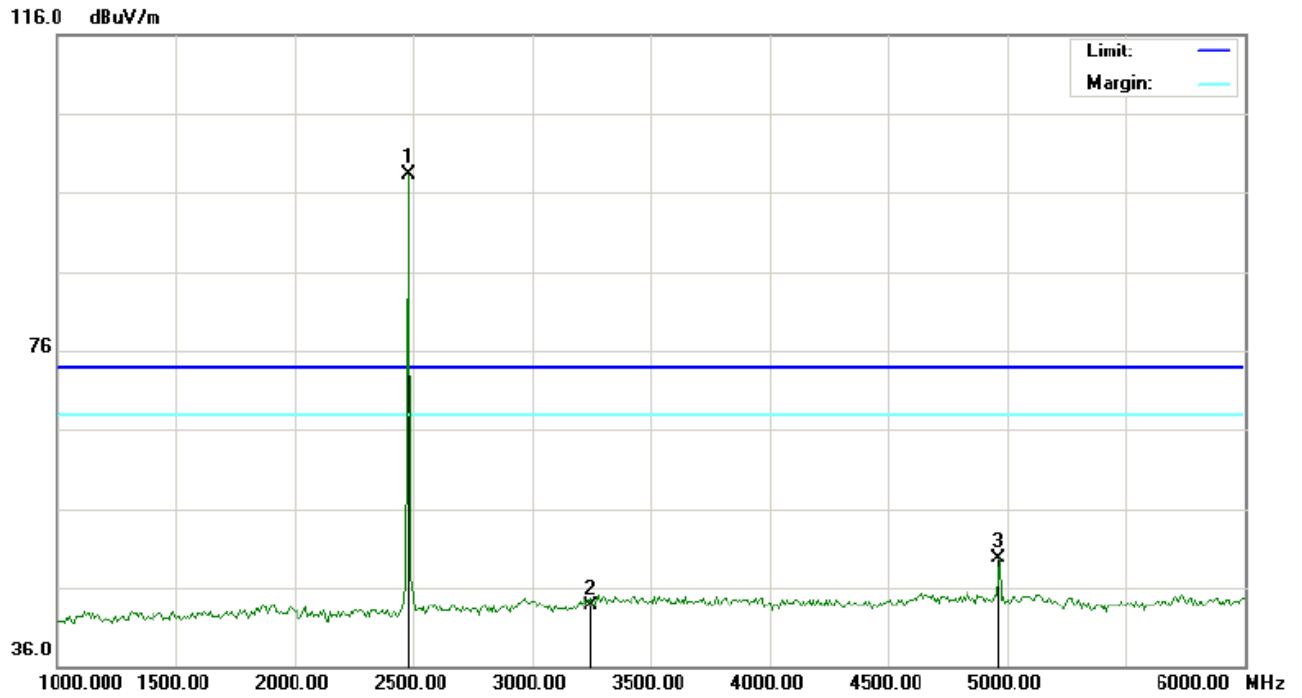

No.	Mk	Freq.	Reading	Factor	Measurement	Limit	Over	Detector	Antenna Height	Table Degree	Comment
		MHz	dBuV	dB/m	dBuV/m	dBuV/m	dB		cm	degree	
1	*	2480.000	87.93	10.41	98.34	74.00	24.34	peak			
2		3251.000	31.91	11.88	43.79	74.00	-30.21	peak			
3		4960.000	41.60	8.09	49.69	74.00	-24.31	peak			

RESULT: PASS



RADIATED EMISSION TEST-(ABOVE 1GHz)-HIGH CHANNEL-VERTICAL

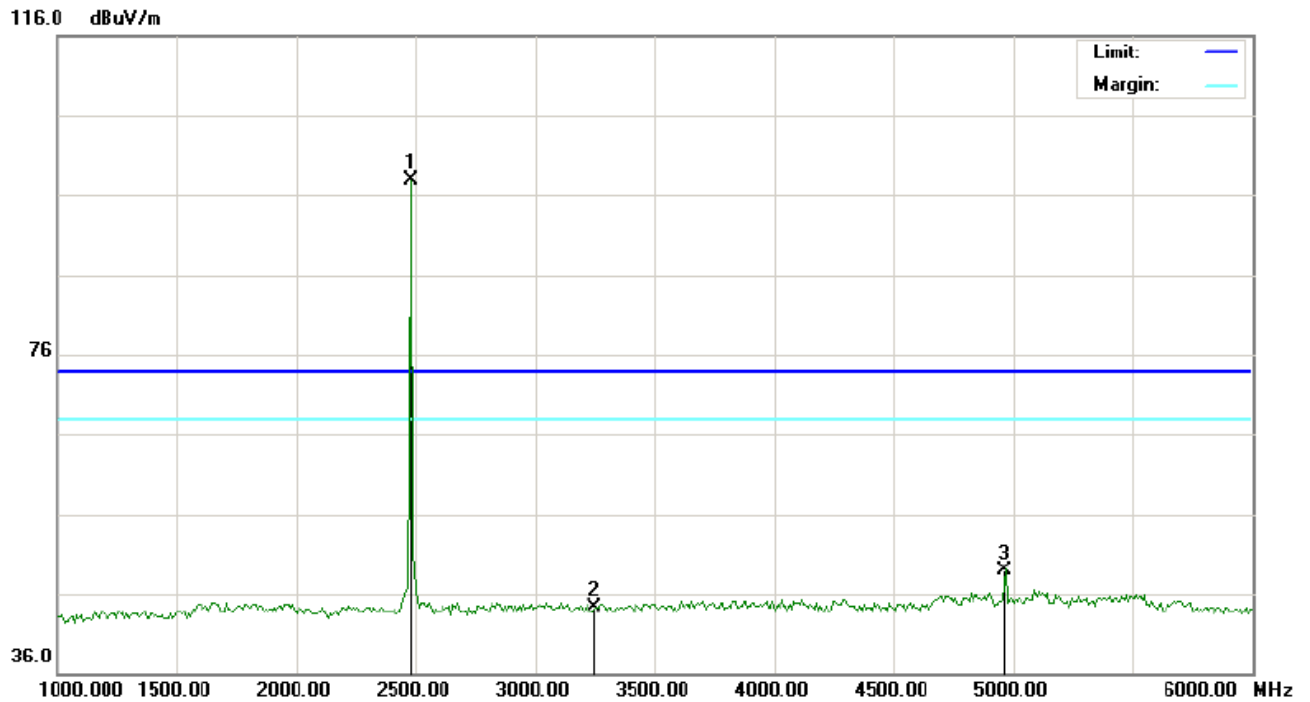

No.	Mk	Freq.	Reading	Factor	Measurement	Limit	Over	Detector	Antenna Height	Table Degree	Comment
		MHz	dBuV	dB/m	dBuV/m	dBuV/m	dB		cm	degree	
1	*	2480.000	87.50	10.41	97.91	74.00	23.91	peak			
2		3251.000	32.45	11.88	44.33	74.00	-29.67	peak			
3		4960.000	40.91	8.09	49.00	74.00	-25.00	peak			

RESULT: PASS

Note: 6~25GHz at least have 20dB margin. No recording in the test report.

Factor=Antenna Factor+ Cable loss-Amplifier gain,

Margin=Measurement-Limit.

The "Factor" value can be calculated automatically by software of measurement system.

5. BAND EDGE EMISSION

5.1. MEASUREMENT PROCEDURE

1. Set the EUT Work on the top, the bottom operation frequency individually.
2. Set SPA Start or Stop Frequency=Operation Frequency,
For unrestricted band: RBW=100kHz, VBW=300kHz
For restricted band: RBW=1MHz, VBW=3*RBW
Center frequency =Operation frequency
3. The band edges was measured and recorded.

5.2. TEST SET-UP

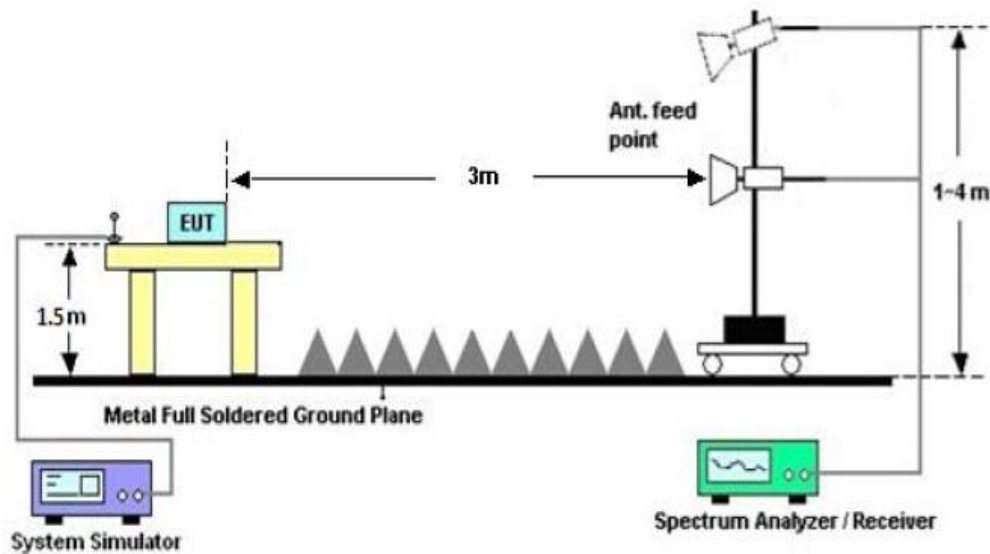



5.3. TEST RESULT

TEST PLOT OF BAND EDGE FOR LOW CHANNEL –Horizontal

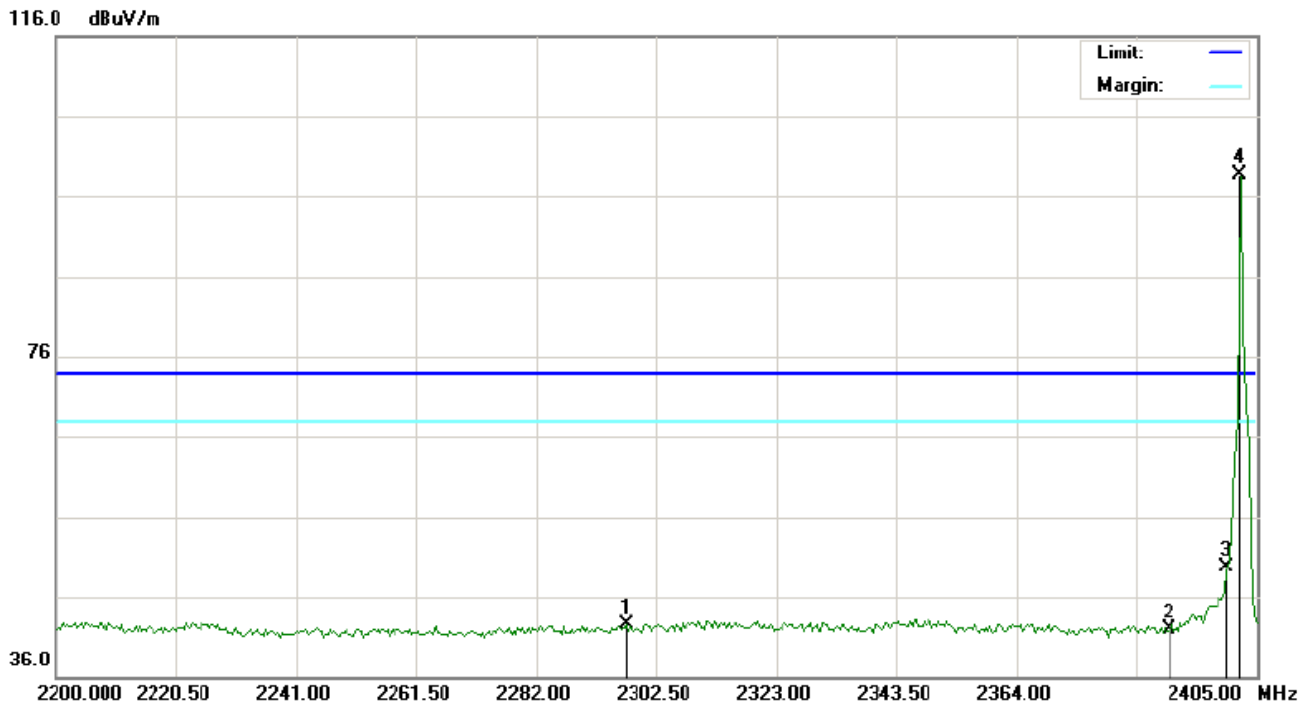

No.	Mk	Freq.	Reading	Factor	Measurement	Limit	Over	Detector	Antenna Height	Table Degree	Comment
		MHz	dBuV	dB/m	dBuV/m	dBuV/m	dB		cm	degree	
1		2297.375	32.28	10.21	42.49	74.00	-31.51	peak			
2		2390.000	31.50	10.31	41.81	74.00	-32.19	peak			
3		2400.000	39.47	10.32	49.79	74.00	-24.21	peak			
4	*	2402.000	88.43	10.32	98.75	74.00	24.75	peak			



TEST PLOT OF BAND EDGE FOR LOW CHANNEL - Vertical

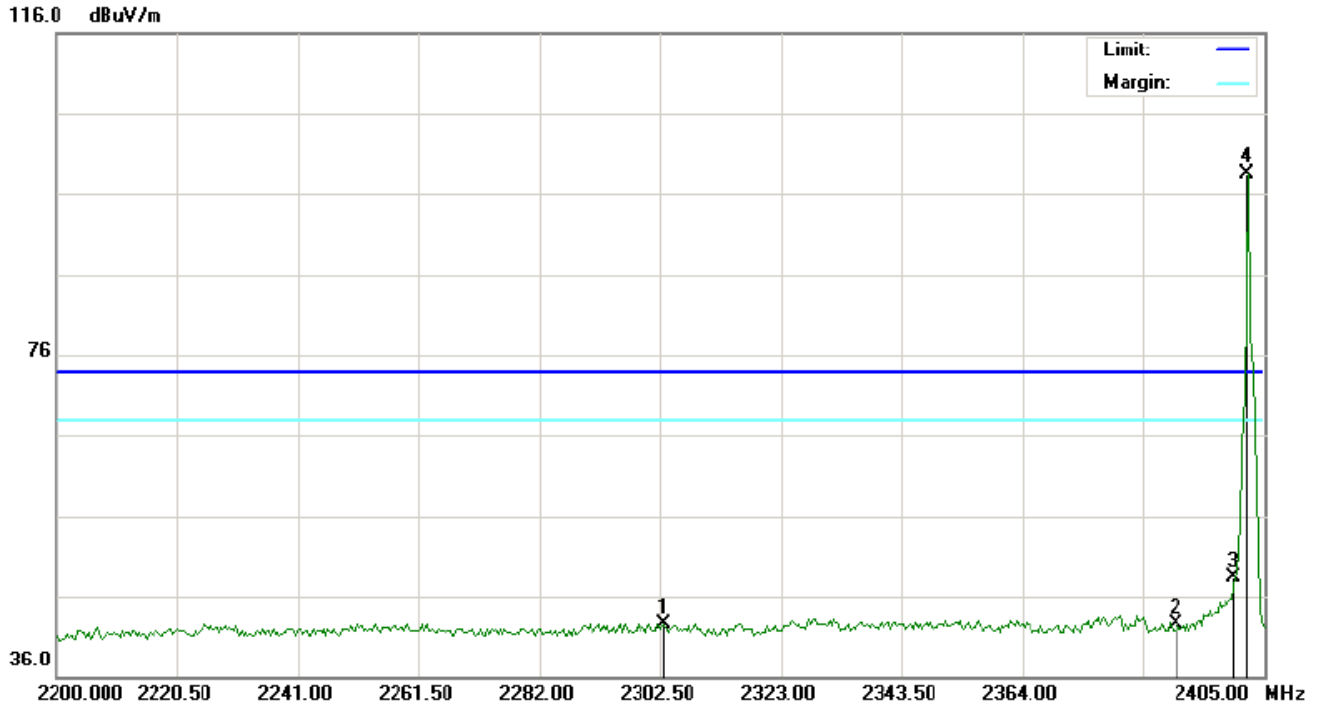

No.	Mk	Freq.	Reading	Factor	Measurement	Limit	Over	Detector	Antenna Height	Table Degree	Comment
		MHz	dBuV	dB/m	dBuV/m	dBuV/m	dB		cm	degree	
1		2303.183	32.27	10.21	42.48	74.00	-31.52	peak			
2		2390.000	32.21	10.31	42.52	74.00	-31.48	peak			
3		2400.000	38.06	10.32	48.38	74.00	-25.62	peak			
4	*	2402.000	88.09	10.32	98.41	74.00	24.41	peak			

RESULT: PASS



TEST PLOT OF BAND EDGE FOR HIGH CHANNEL –Horizontal

116.0 dBuV/m

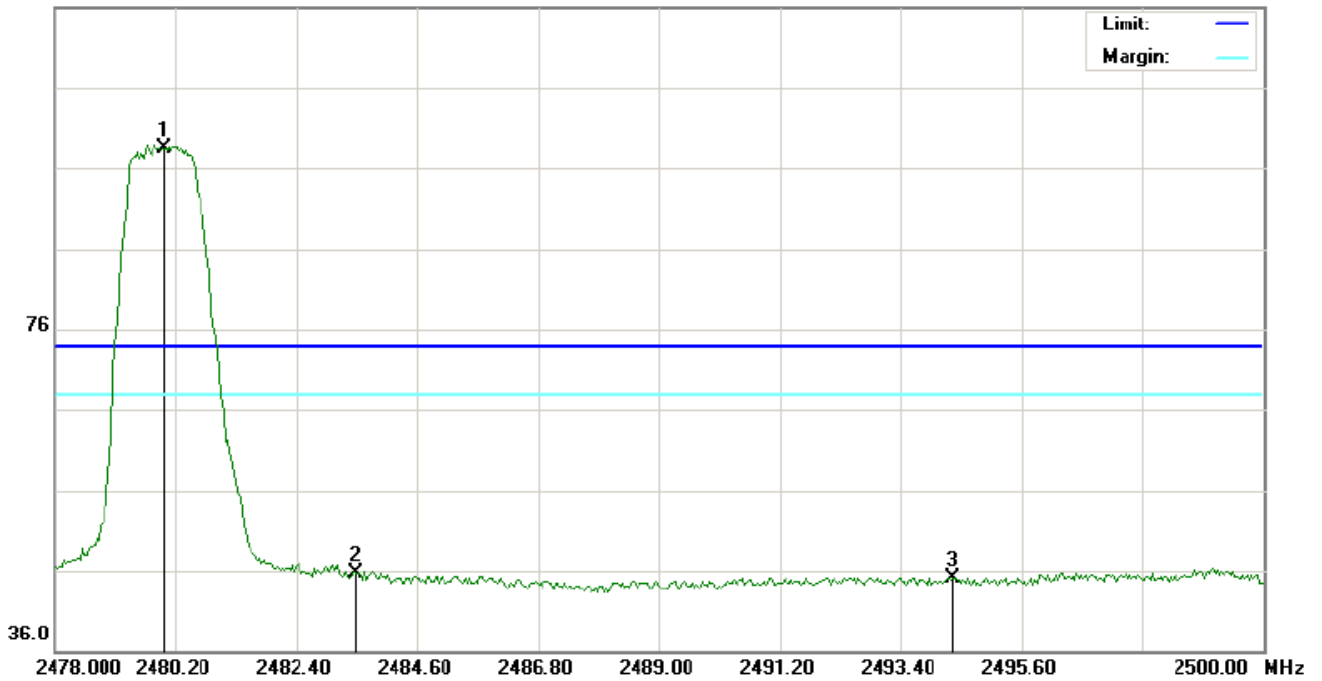

No.	Mk	Freq.	Reading	Factor	Measurement	Limit	Over	Detector	Antenna Height	Table Degree	Comment
		MHz	dBuV	dB/m	dBuV/m	dBuV/m	dB		cm	degree	
1	*	2480.000	88.05	10.41	98.46	74.00	24.46	peak			
2		2483.500	35.19	10.41	45.60	74.00	-28.40	peak			
3		2494.353	34.77	10.42	45.19	74.00	-28.81	peak			



TEST PLOT OF BAND EDGE FOR HIGH CHANNEL -Vertical

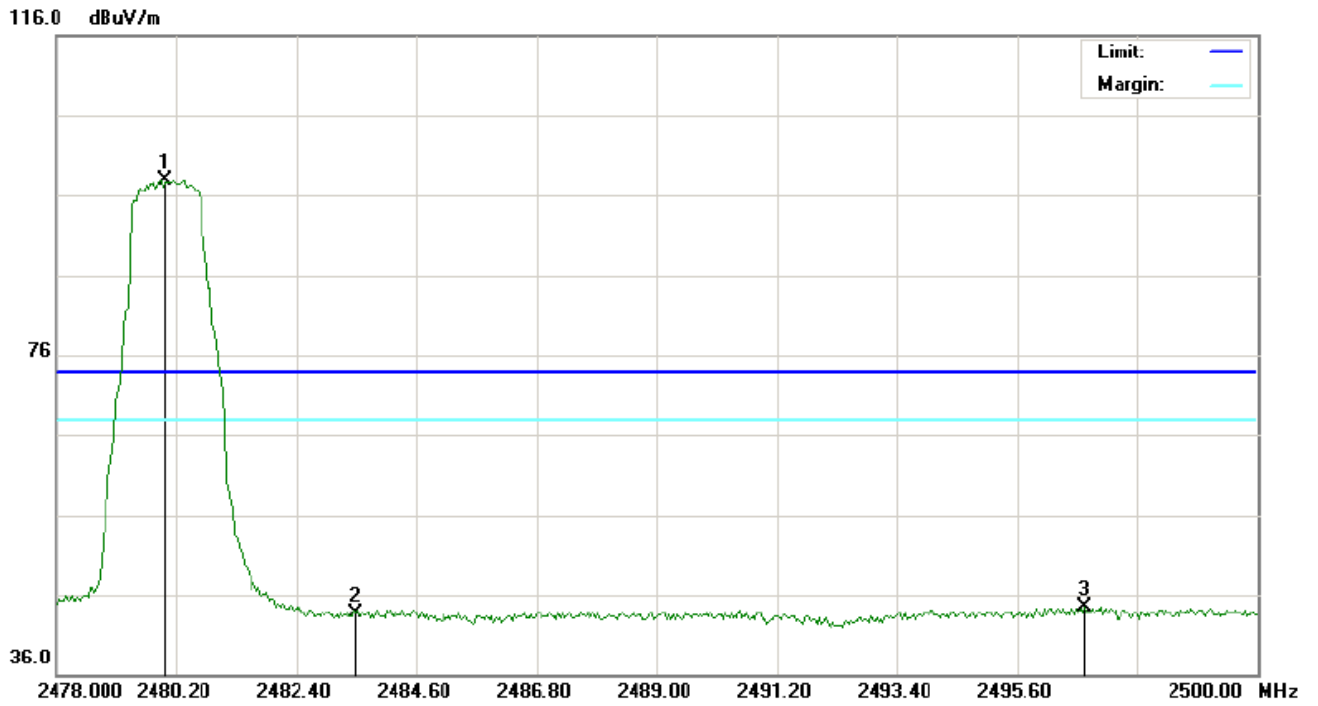

No.	Mk	Freq.	Reading	Factor	Measurement	Limit	Over	Detector	Antenna Height	Table Degree	Comment
		MHz	dBuV	dB/m	dBuV/m	dBuV/m	dB		cm	degree	
1	*	2480.000	87.45	10.41	97.86	74.00	23.86	peak			
2		2483.500	33.26	10.41	43.67	74.00	-30.33	peak			
3		2496.847	34.03	10.43	44.46	74.00	-29.54	peak			

RESULT: PASS



6. 6DB BANDWIDTH

6.1. TEST PROCEDURE

1. Connect EUT RF output port to the Spectrum Analyzer through an RF attenuator
2. Set the EUT Work on the top, the middle and the bottom operation frequency individually.
3. Set SPA Centre Frequency = Operation Frequency, RBW= 100 KHz, VBW ≥ 3 *RBW.
4. Set SPA Trace 1 Max hold, then View.

6.2. SUMMARY OF TEST RESULTS/PLOTS

Channel	6dB Bandwidth (KHz)	Minimum Limit (KHz)	Pass/Fail
Low	538	500KHz	Pass
Middle	532		Pass
High	538		Pass

TEST PLOT OF BANDWIDTH FOR LOW CHANNEL

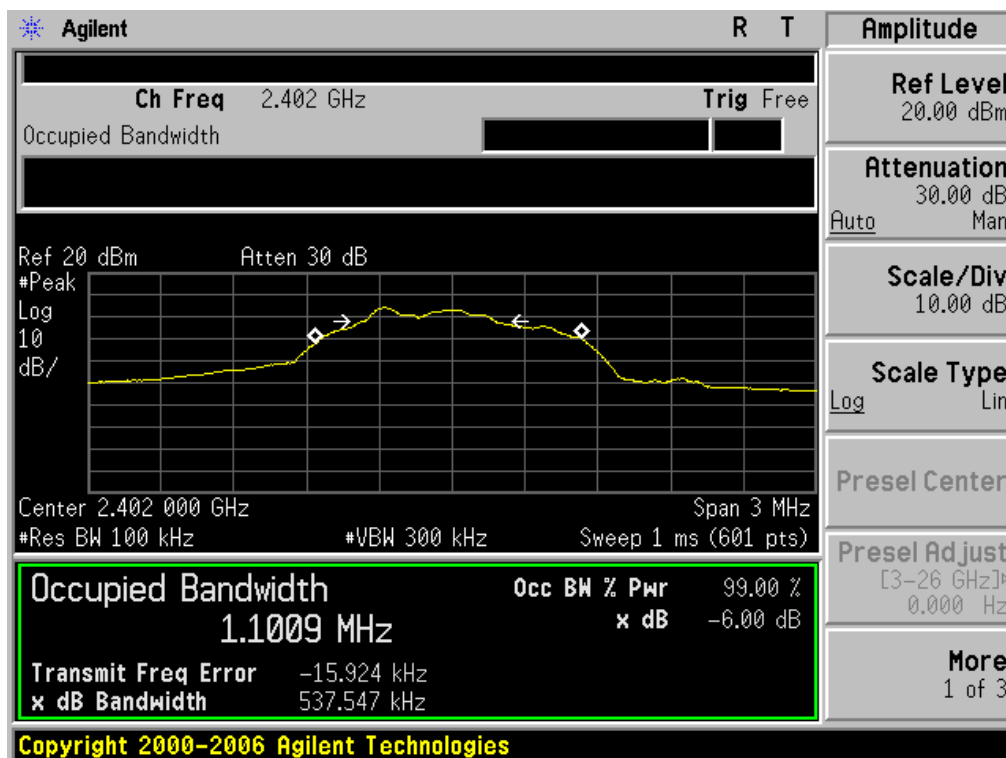



TEST PLOT OF BANDWIDTH FOR MIDDLE CHANNEL

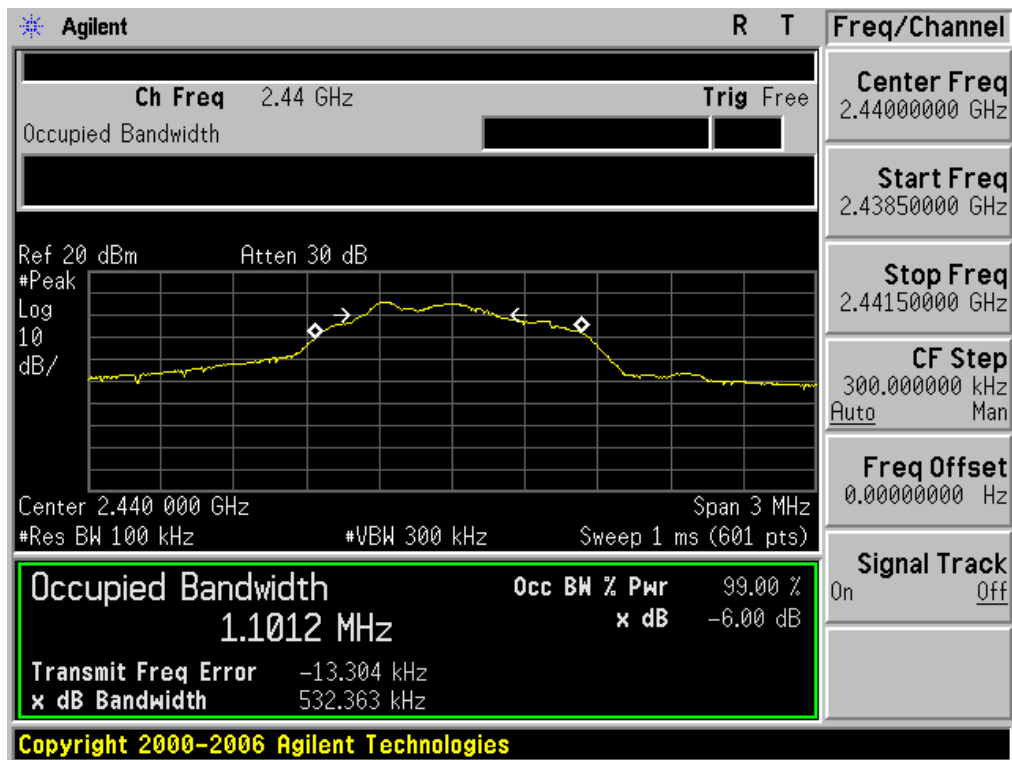

TEST PLOT OF BANDWIDTH FOR HIGH CHANNEL

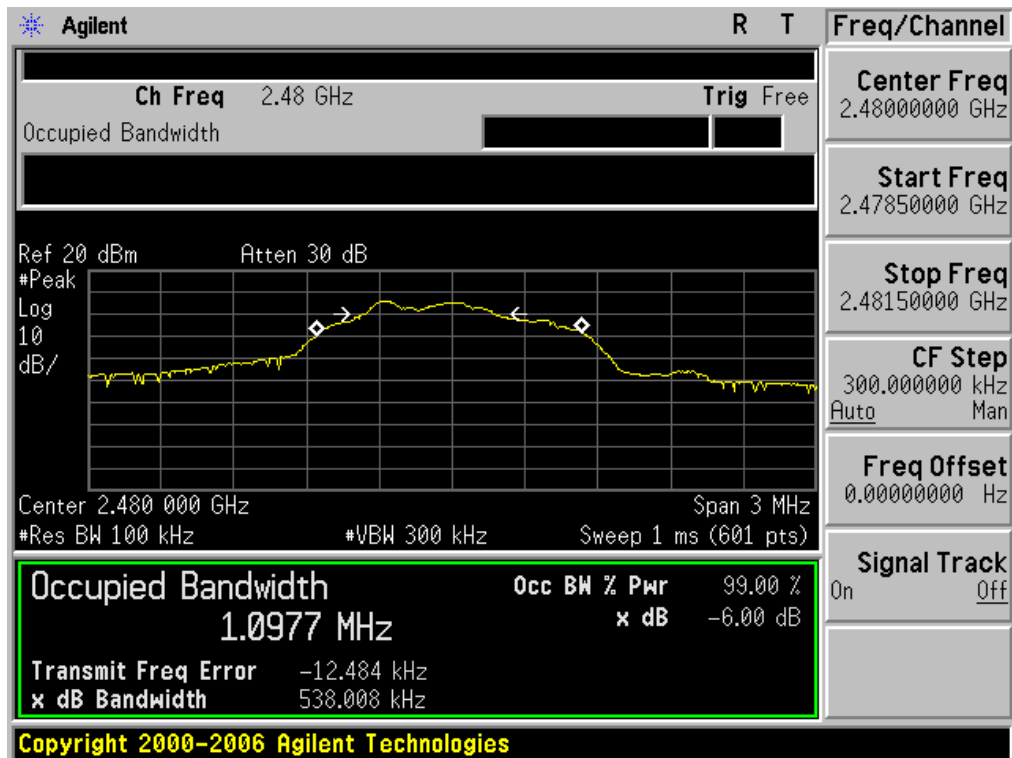



7. CONDUCTED OUTPUT POWER

7.1. MEASUREMENT PROCEDURE

1. Connect EUT RF output port to the Spectrum Analyzer through an RF attenuator
2. Set the EUT Work on the top, middle and the bottom operation frequency individually.
3. Use the following spectrum analyzer settings:
 - a) Set the RBW \geq DTS bandwidth.
 - b) Set VBW \geq 3 RBW.
 - c) Set span \geq 3 x RBW
 - d) Sweep time = auto couple.
 - e) Detector = peak.
 - f) Trace mode = max hold.
 - g) Allow trace to fully stabilize.
 - h) Use peak marker function to determine the peak amplitude level.
4. Allow the trace to stabilize.
5. Record the result form the Spectrum Analyzer.

7.2. TEST SET-UP (BLOCK DIAGRAM OF CONFIGURATION)

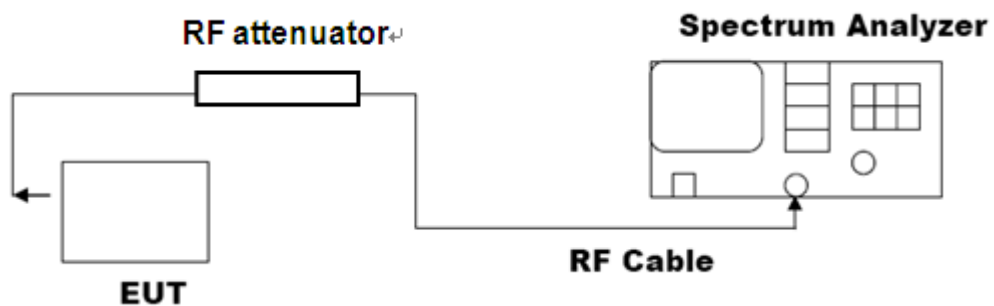



7.3. LIMITS AND MEASUREMENT RESULT

Channel	Peak Power (dBm)	Applicable Limits (dBm)	Pass/Fail
Low Channel	3.64	30	Pass
Middle Channel	4.12	30	Pass
High Channel	3.19	30	Pass

The Low Channel Result

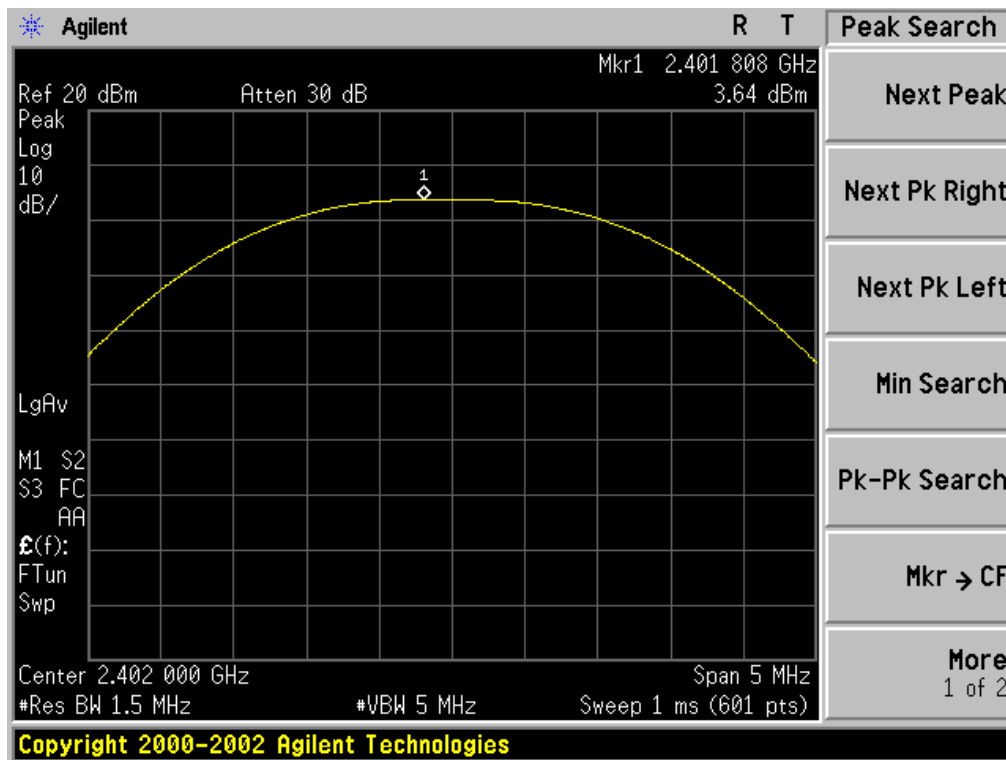



The Middle Channel Result

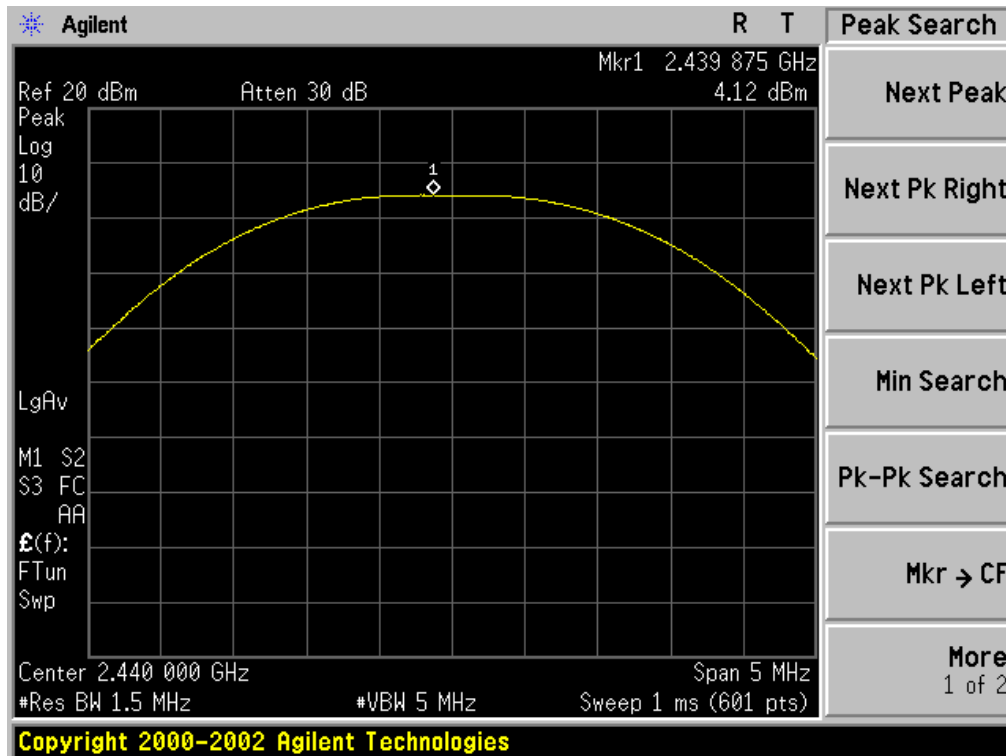

The High Channel Result

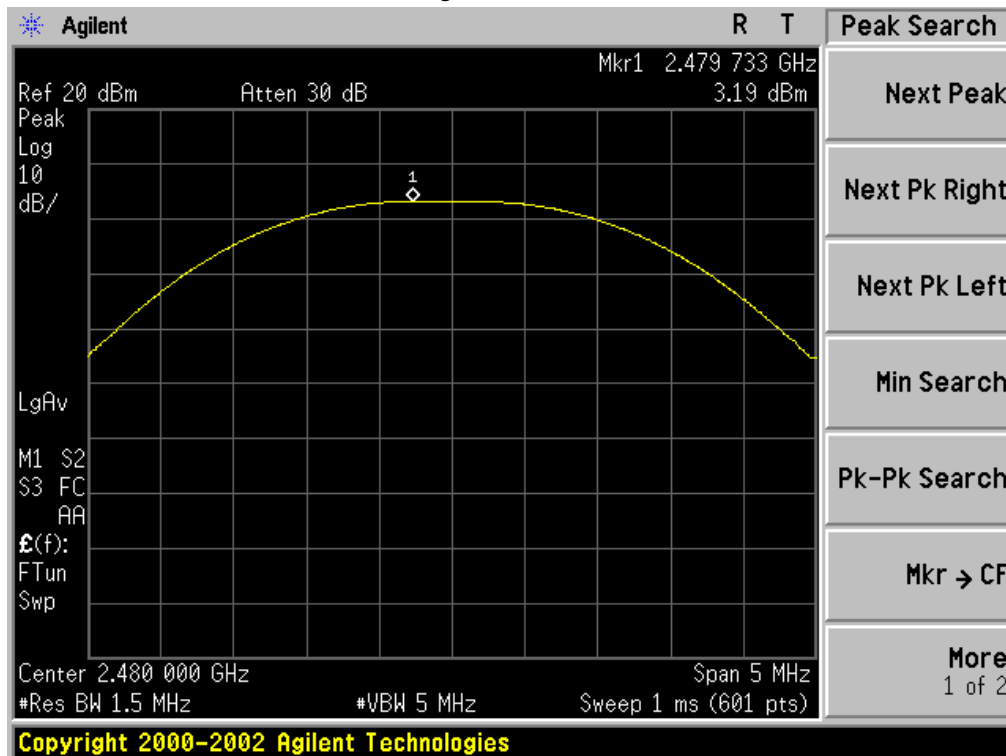



8. CONDUCTED SPURIOUS EMISSION

8.1. MEASUREMENT PROCEDURE

1. Connect EUT RF output port to the Spectrum Analyzer through an RF attenuator
2. Set the EUT Work on the top, the Middle and the bottom operation frequency individually.
3. Set the Span = wide enough to capture the peak level of the in-band emission and all spurious emissions from the lowest frequency generated in the EUT up through the 10th harmonic.
RBW = 100kHz; VBW \geq 3 RBW; Sweep = auto; Detector function = peak.
4. Set SPA Trace 1 Max hold, then View.

8.2. TEST SET-UP (BLOCK DIAGRAM OF CONFIGURATION)

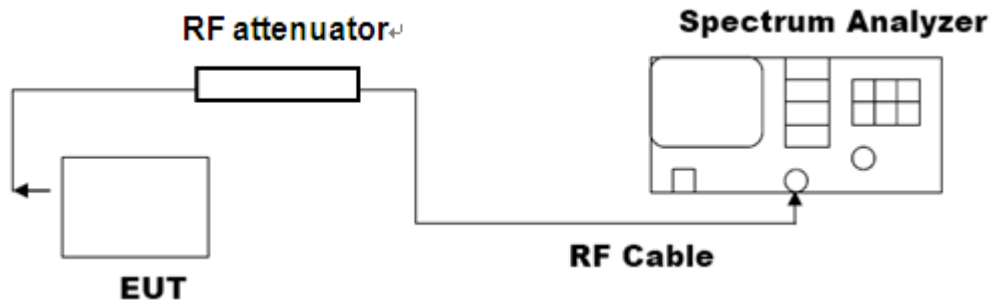

8.3. LIMITS AND MEASUREMENT RESULT

LIMITS AND MEASUREMENT RESULT		
Applicable Limits	Measurement Result	
	Test Data	Result
In any 100 KHz Bandwidth Outside the frequency band in which the spread spectrum intentional radiator is operating, the radio frequency power that is produce by the intentional radiator shall be at least 20 dB below that in 100KHz bandwidth within the band that contains the highest level of the desired power. In addition, radiation emissions which fall in the restricted bands, as defined in §15.205(a), must also comply with the radiated emission limits specified in§15.209(a)	At least -20dBc than the limit Specified on the BOTTOM Channel	PASS
	At least -20dBc than the limit Specified on the TOP Channel	PASS



TEST PLOT OF OUT OF BAND EMISSIONS WITH THE WORST CASE OF GFSK MODULATION IN LOW CHANNEL

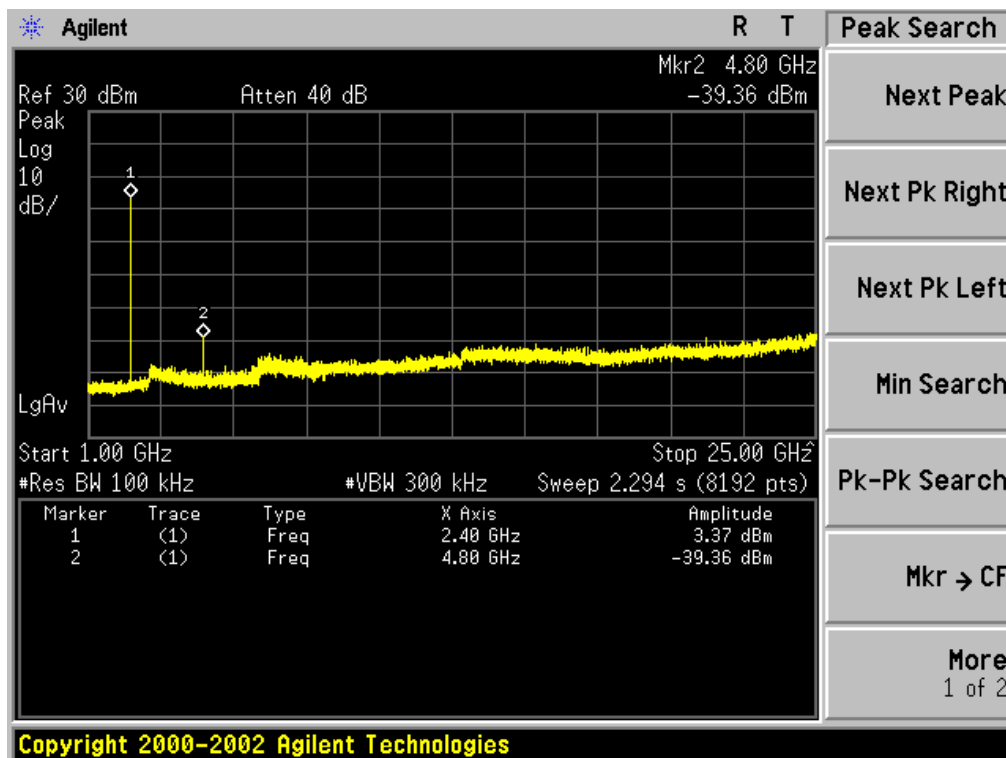
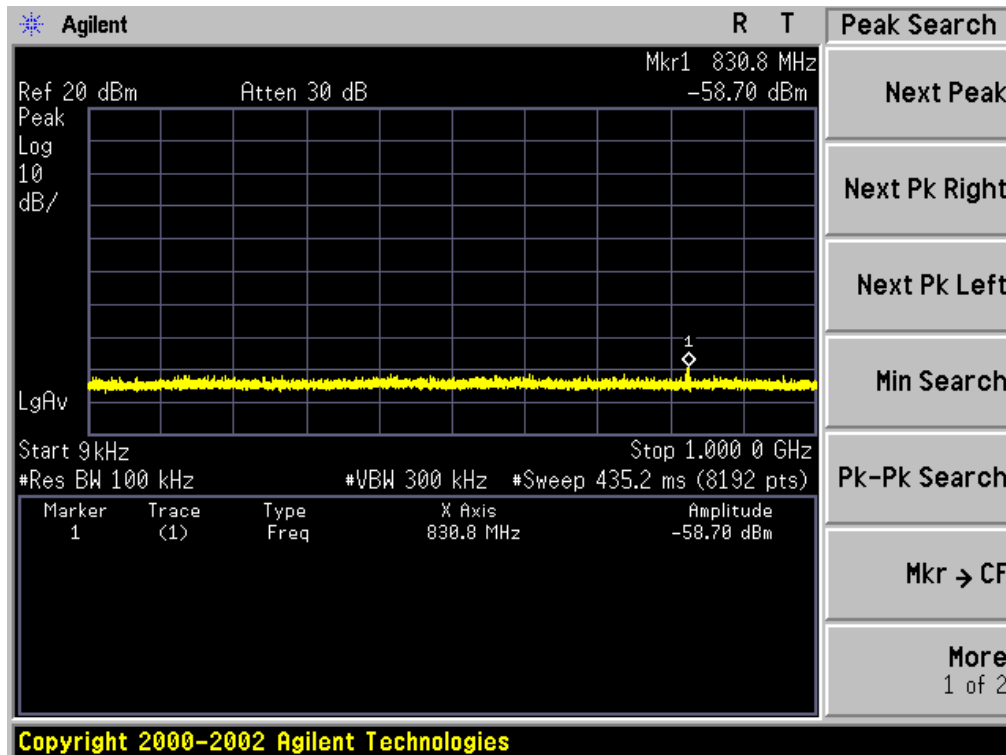



TEST PLOT OF OUT OF BAND EMISSIONS OF GFSK MODULATION IN MIDDLE CHANNEL

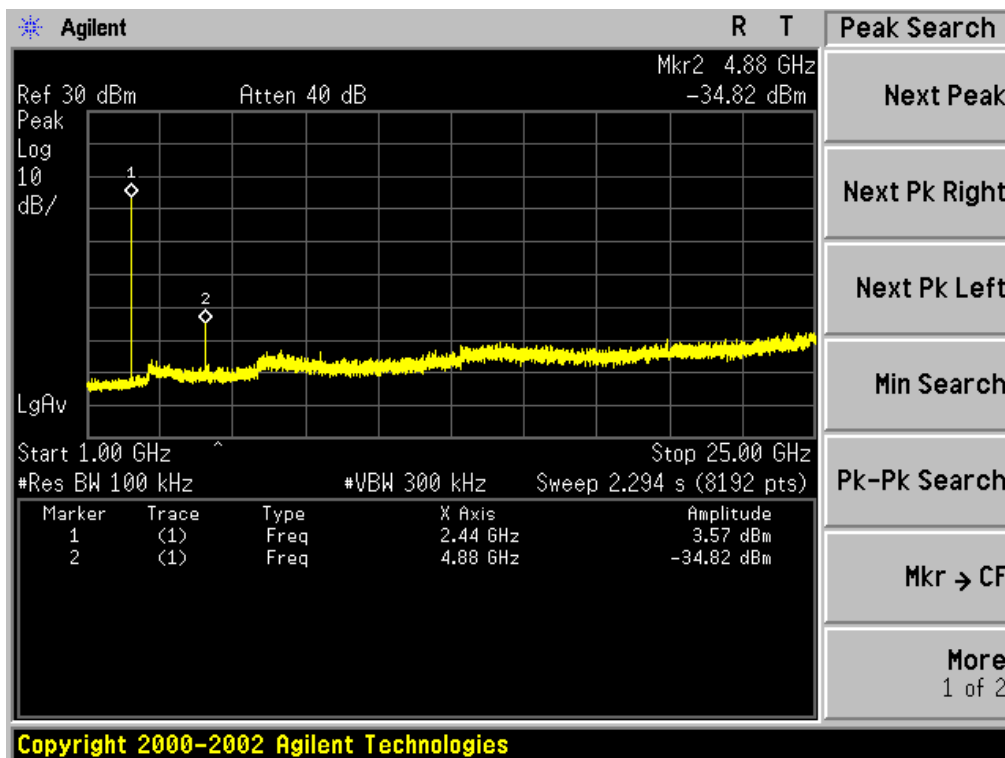
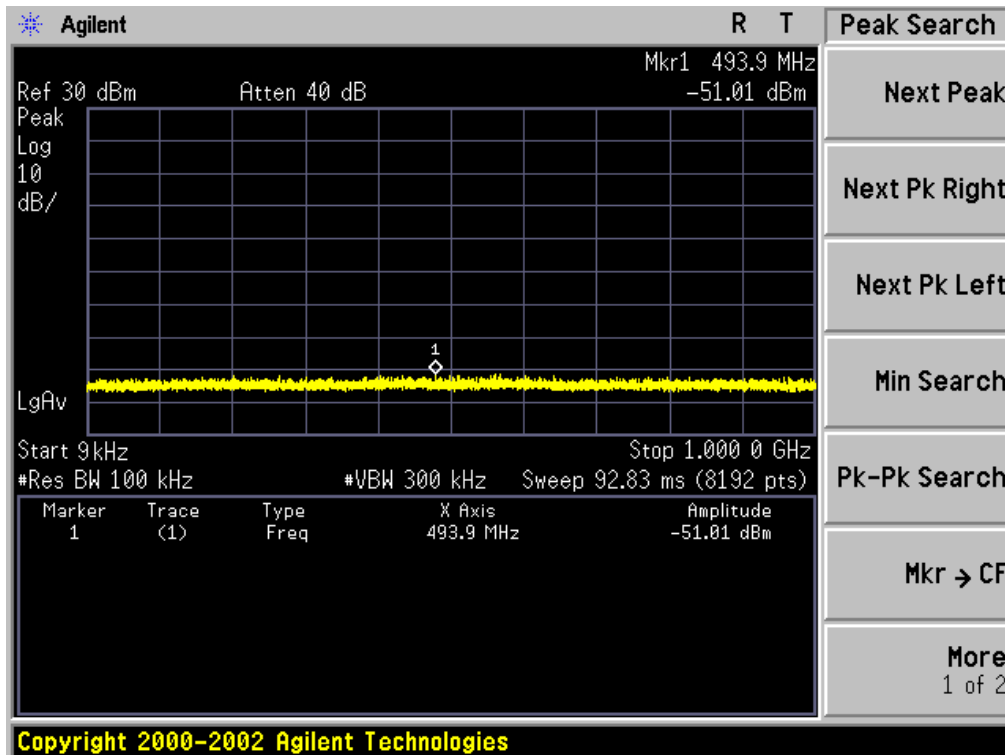



TEST PLOT OF OUT OF BAND EMISSIONS OF GFSK MODULATION IN HIGH CHANNEL

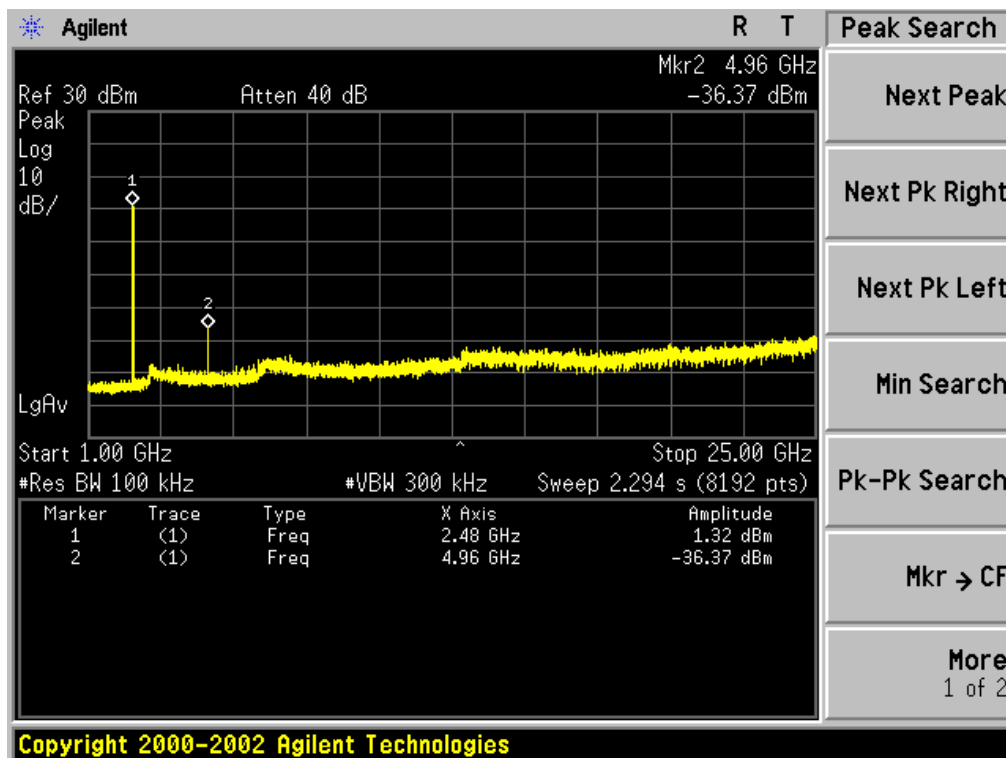
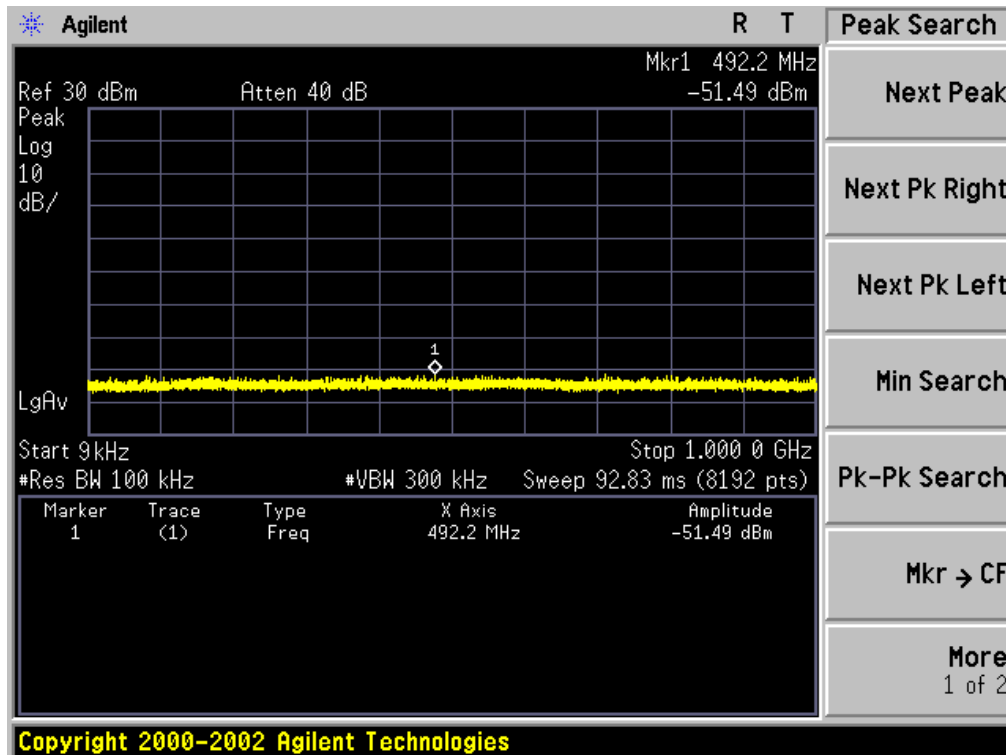



9. CONDUCTED OUTPUT POWER SPECTRAL DENSITY

9.1 MEASUREMENT PROCEDURE

- (1). Connect EUT RF output port to the Spectrum Analyzer through an RF attenuator
- (2). Set the EUT Work on the top, the middle and the bottom operation frequency individually.
- (3). Set the span to 1.5times the DTS bandwidth, RBW: $3\text{kHz} \leq \text{RBW} \leq 100\text{kHz}$, VBW $\geq 3 \times \text{RBW}$
- (4). Set SPA Trace 1 Max hold, then View.

Note: The EUT was tested according to KDB 558074 for compliance to FCC 47CFR 15.247 requirements.

9.2 TEST SET-UP (BLOCK DIAGRAM OF CONFIGURATION)

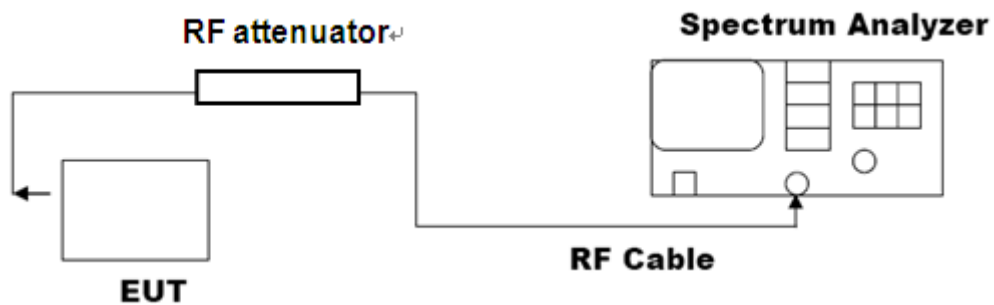

9.3 LIMITS AND MEASUREMENT RESULT

Channel No.	PSD (dBm/3KHz)	Limit (dBm/3KHz)	Result
Low Channel	-11.51	8	Pass
Middle Channel	-11.85	8	Pass
High Channel	-12.32	8	Pass



TEST PLOT OF SPECTRAL DENSITY FOR LOW CHANNEL

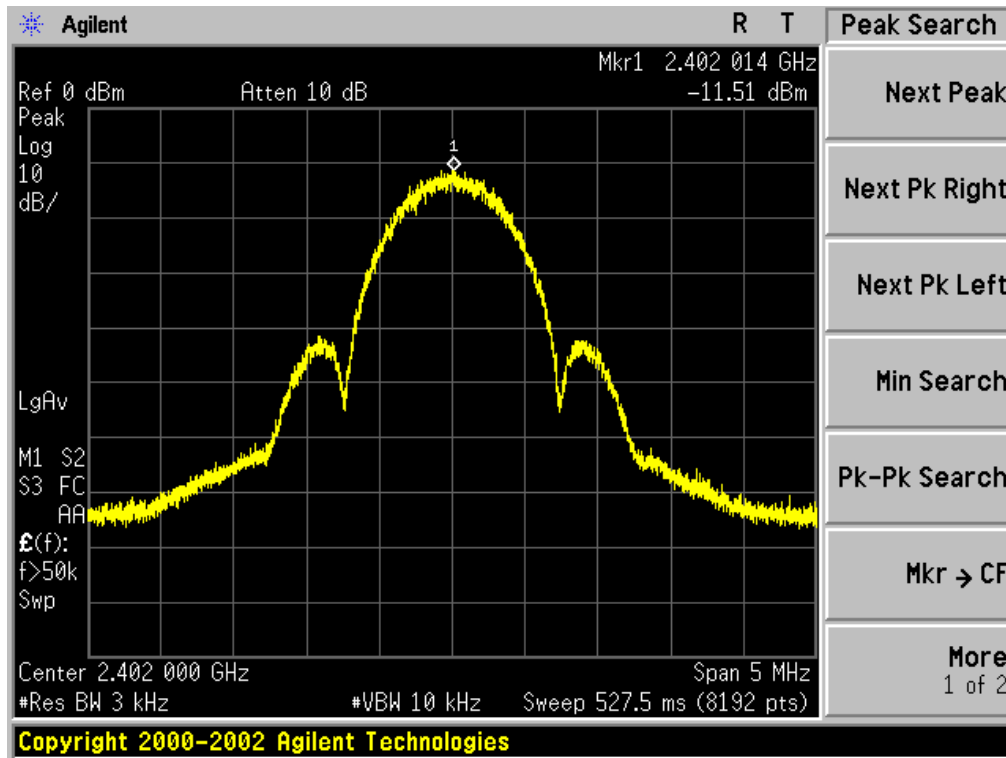

TEST PLOT OF SPECTRAL DENSITY FOR MIDDLE CHANNEL

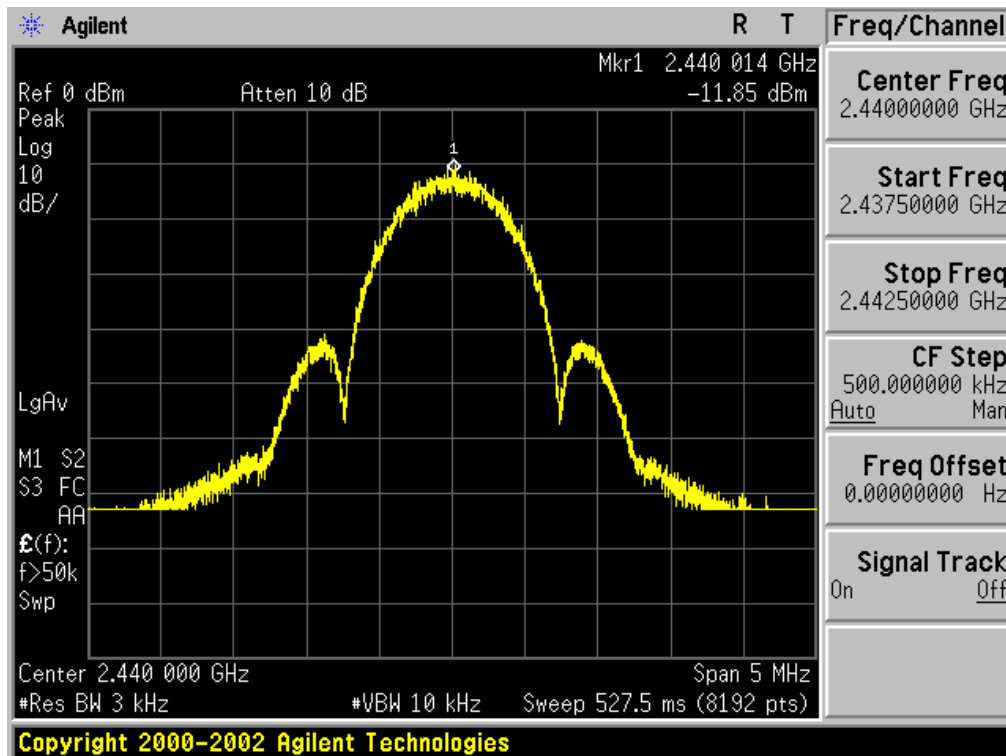



TEST PLOT OF SPECTRAL DENSITY FOR HIGH CHANNEL

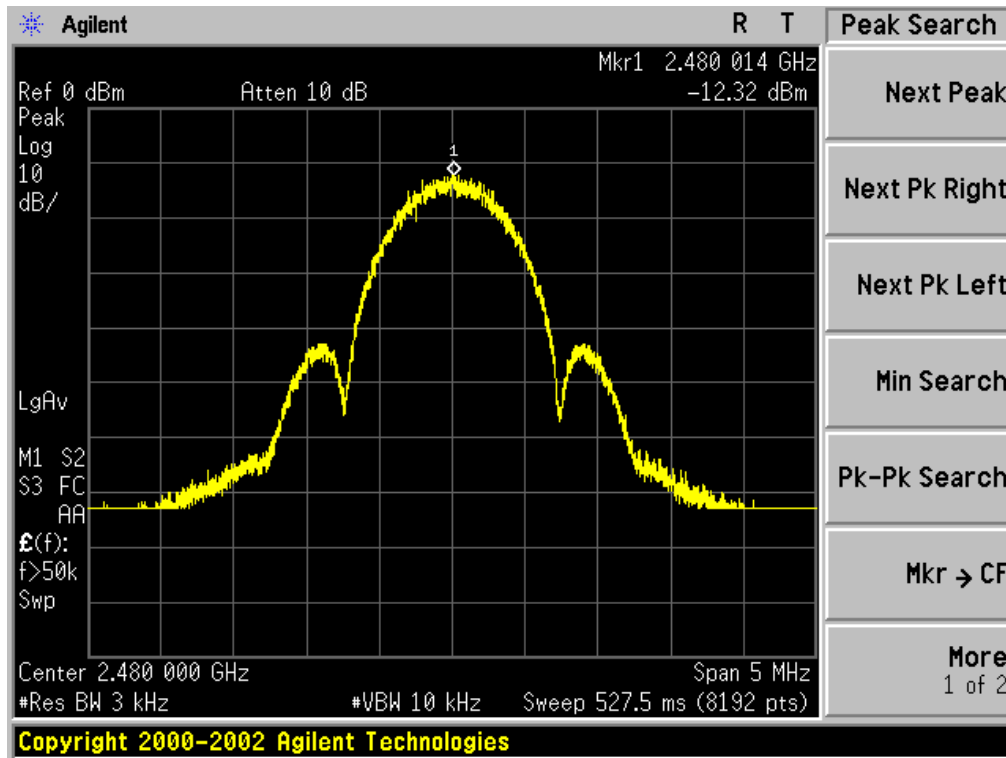

10. LINE CONDUCTED EMISSION TEST

10.1 LIMITS

Frequency	Maximum RF Line Voltage	
	Q.P.(dBuV)	Average(dBuV)
150kHz~500kHz	66-56	56-46
500kHz~5MHz	56	46
5MHz~30MHz	60	50

Note: 1. The lower limit shall apply at the transition frequency.

2. The limit decreases linearly with the logarithm of the frequency in the range 0.15 MHz to 0.50 MHz

10.2 TEST SETUP

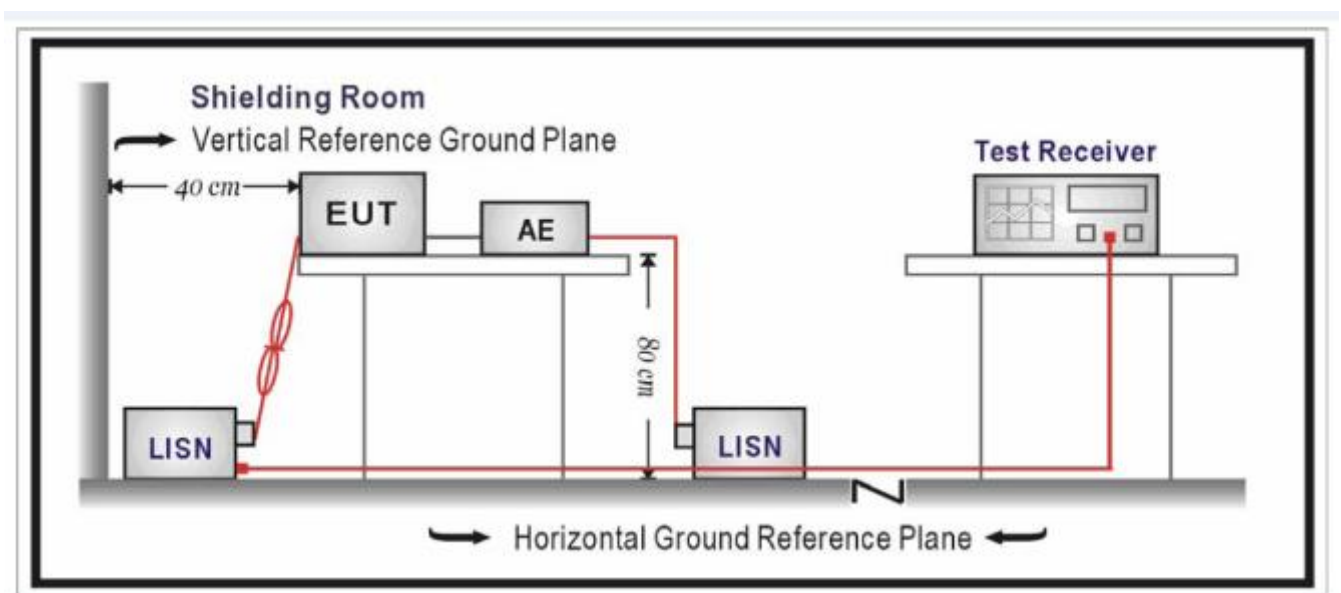



10.3 PRELIMINARY PROCEDURE

- 1) The equipment was set up as per the test configuration to simulate typical actual usage per the user's manual. When the EUT is a tabletop system, a wooden table with a height of 0.8 meters is used and is placed on the ground plane as per ANSI C63.10 (see Test Facility for the dimensions of the ground plane used). When the EUT is a floor-standing equipment, it is placed on the ground plane which has a 3-12 mm non-conductive covering to insulate the EUT from the ground plane.
- 2) Support equipment, if needed, was placed as per ANSI C63.10.
- 3) All I/O cables were positioned to simulate typical actual usage as per ANSI C63.10.
- 4) All support equipments received AC120V/60Hz power from a LISN, if any.
- 5) The EUT received DC charging voltage by adapter which received 120V/60Hz power by a LISN.
- 6) The test program was started. Emissions were measured on each current carrying line of the EUT using a spectrum Analyzer / Receiver connected to the LISN powering the EUT. The LISN has two monitoring points: Line 1 (Hot Side) and Line 2 (Neutral Side). Two scans were taken: one with Line 1 connected to Analyzer / Receiver and Line 2 connected to a 50 ohm load; the second scan had Line 1 connected to a 50 ohm load and Line 2 connected to the Analyzer / Receiver.
- 7) Analyzer / Receiver scanned from 150 kHz to 30MHz for emissions in each of the test modes.
- 8) During the above scans, the emissions were maximized by cable manipulation.
- 9) The following test mode(s) were scanned during the preliminary test.
Then, the EUT configuration and cable configuration of the above highest emission level were recorded for reference of final testing.

10.4 FINAL TEST PROCEDURE

- 1) EUT and support equipment was set up on the test bench as per step 2 of the preliminary test.
- 2) A scan was taken on both power lines, Line 1 and Line 2, recording at least the six highest emissions. Emission frequency and amplitude were recorded into a computer in which correction factors were used to calculate the emission level and compare reading to the applicable limit. If EUT emission level was less -2dB to the A.V. limit in Peak mode, then the emission signal was re-checked using Q.P and Average detector.
- 3) The test data of the worst case condition(s) was reported on the Summary Data page.

10.5 TEST RESULT OF POWER LINE

N/A

Note: The BT function of EUT didn't work when charging.

11. ANTENNA REQUIREMENT

Standard Applicable

For intentional device, according to FCC 47 CFR Section 15.203, an intentional radiator shall be designed to ensure that no antenna other than that furnished by the responsible party shall be used with the device.

Refer to statement below for compliance.

The manufacturer may design the unit so that the user can replace a broken antenna, but the use of a standard antenna jack or electrical connector is prohibited. Further, this requirement does not apply to intentional radiators that must be professionally installed.

ANTENNA

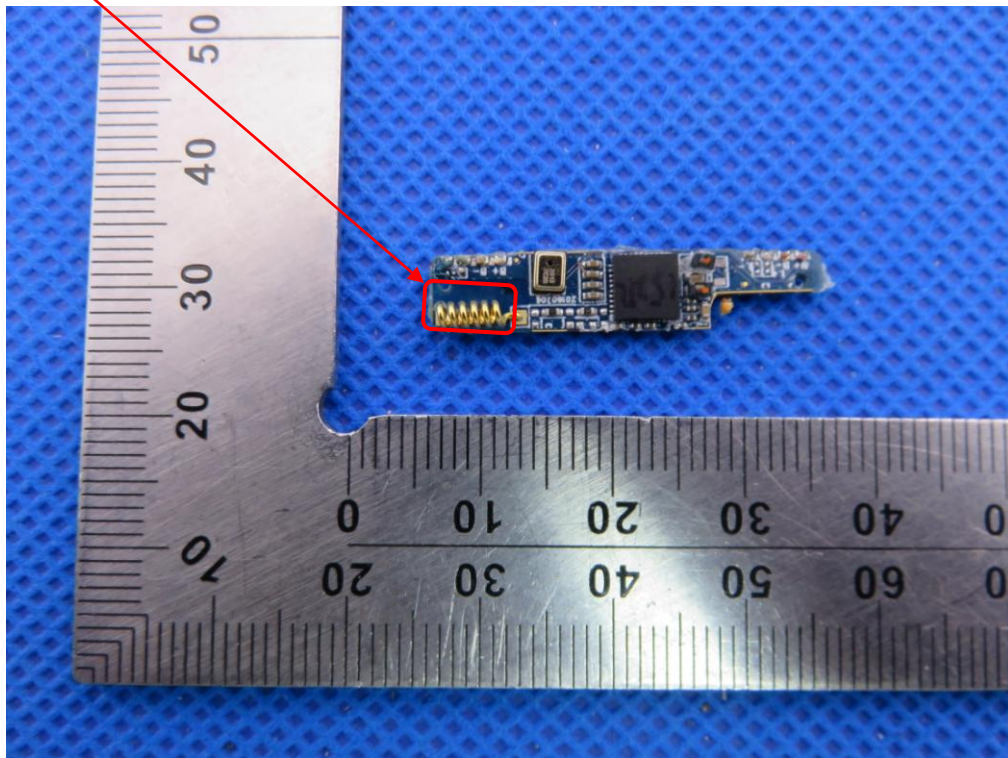

12. PHOTOGRAPH OF TEST

FCC RADIATED EMISSION TEST SETUP

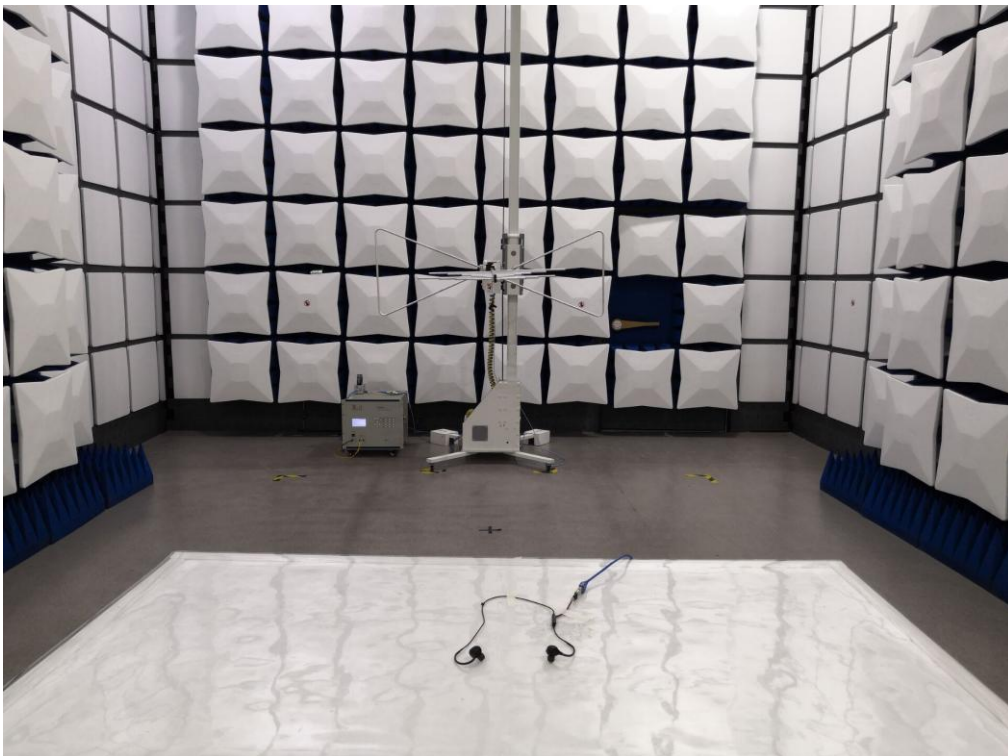
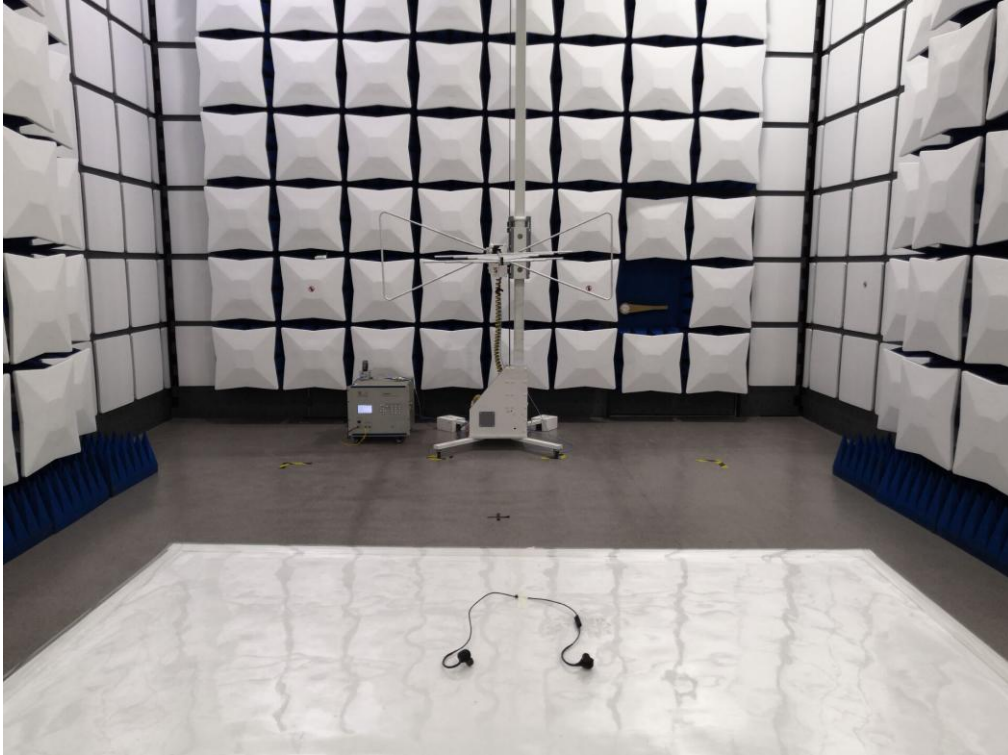



13. PHOTOGRAPHS OF EUT

TOP VIEW OF EUT



BOTTOM VIEW OF EUT





FRONT VIEW OF EUT



BACK VIEW OF EUT





LEFT VIEW OF EUT



RIGHT VIEW OF EUT



VIEW OF EUT (PORT)



OPEN VIEW OF EUT





VIEW OF BATTERY-1

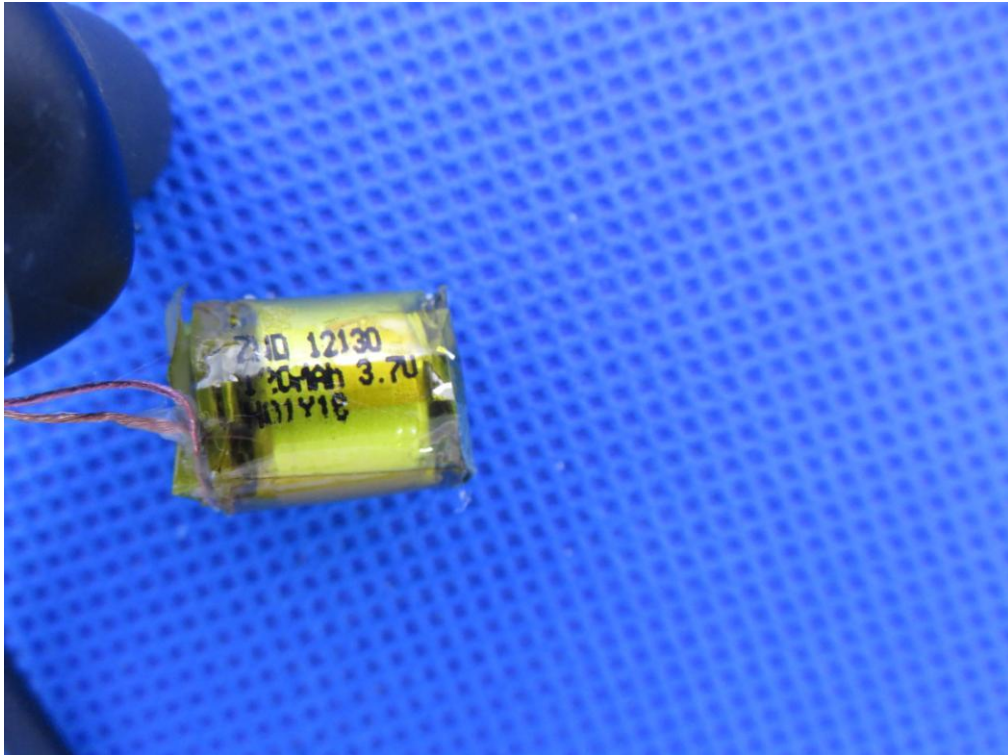

VIEW OF BATTERY-2

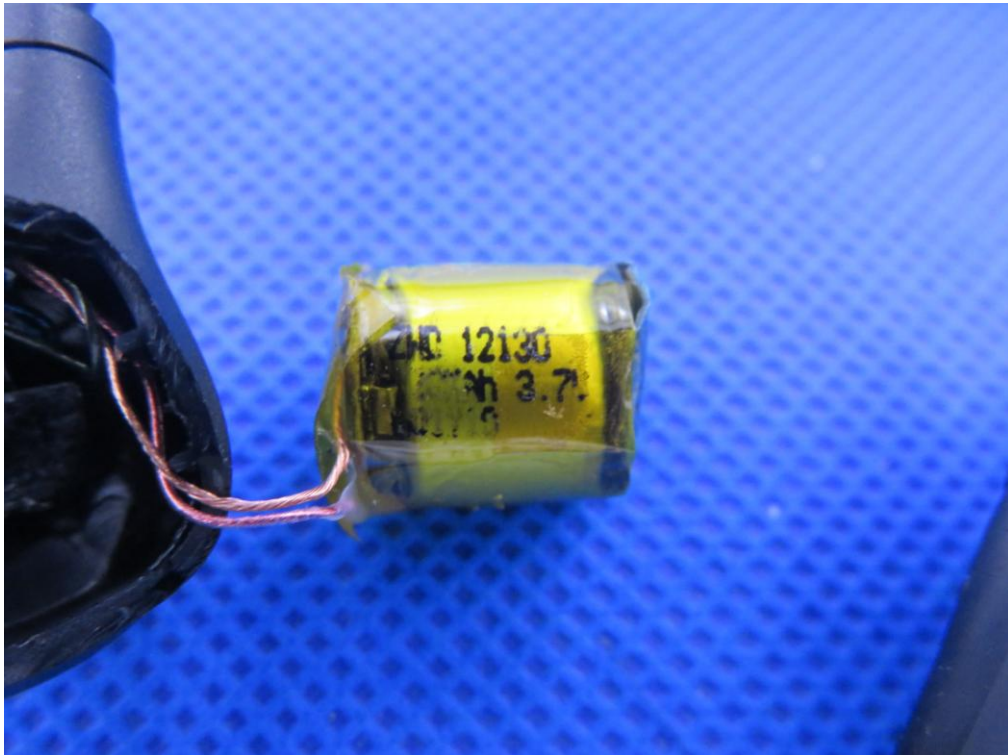

INTERNAL VIEW OF EUT-1

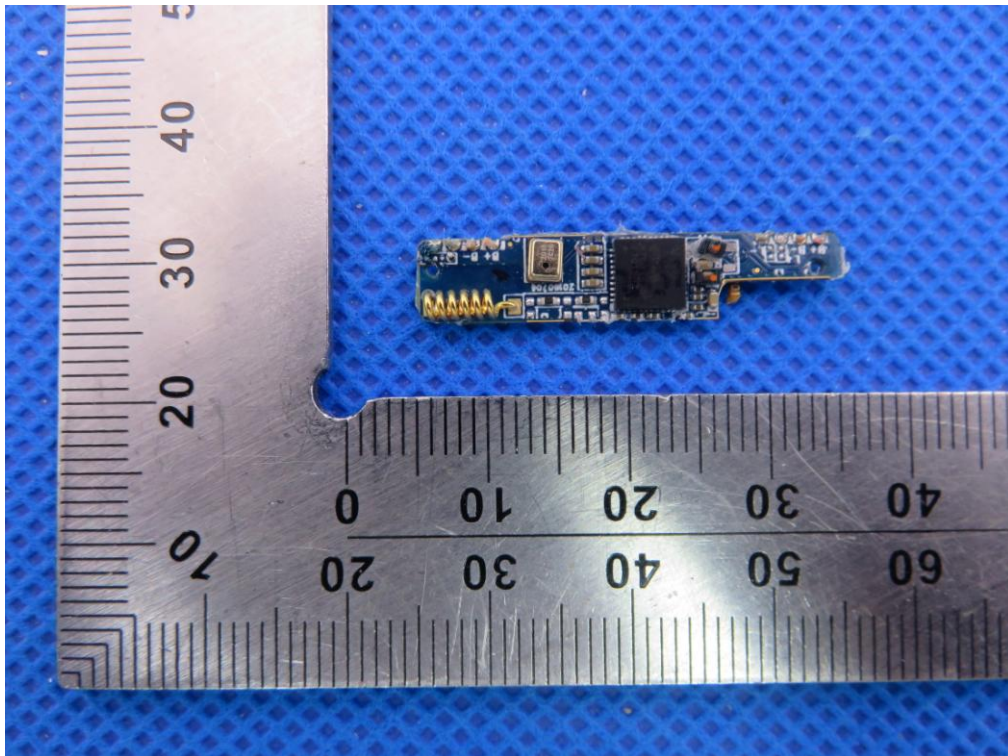

INTERNAL VIEW OF EUT-2

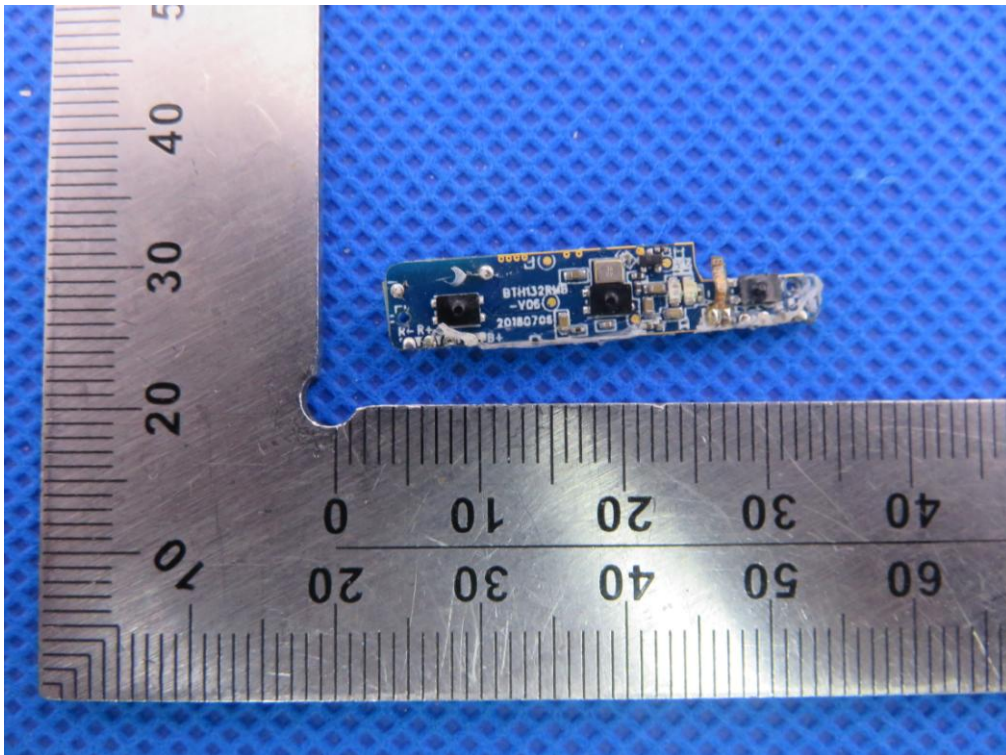



INTERNAL VIEW OF EUT-3

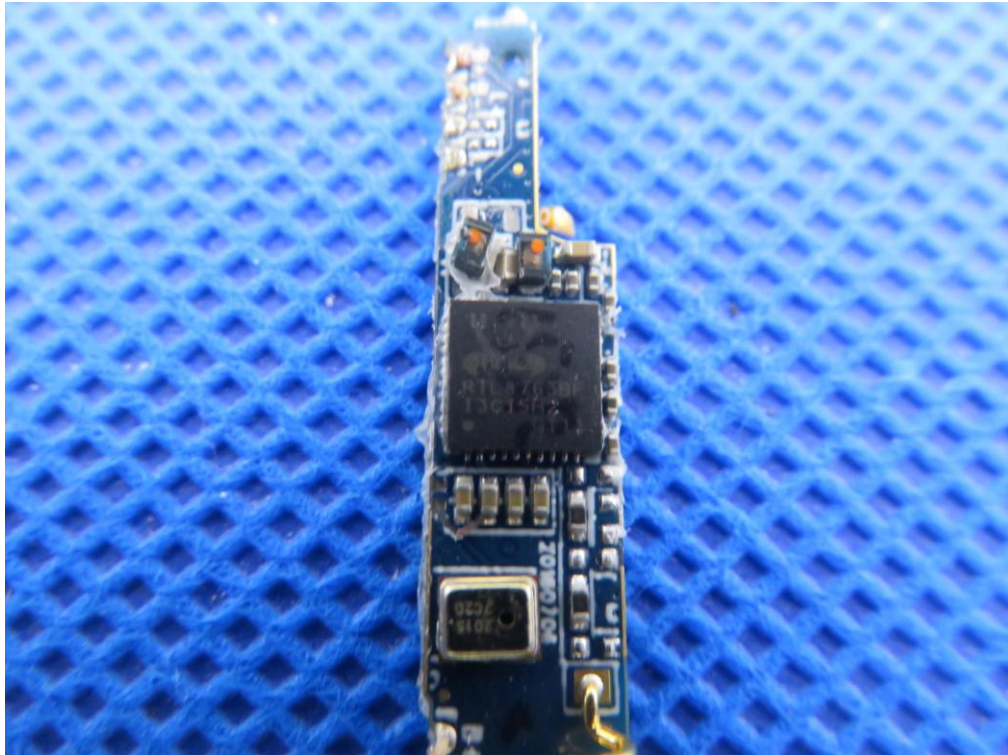



Series Model
BTH132R
TOP VIEW OF EUT



BOTTOM VIEW OF EUT





FRONT VIEW OF EUT



BACK VIEW OF EUT



LEFT VIEW OF EUT



RIGHT VIEW OF EUT





VIEW OF EUT (PORT)



OPEN VIEW OF EUT





VIEW OF BATTERY-1



VIEW OF BATTERY-2

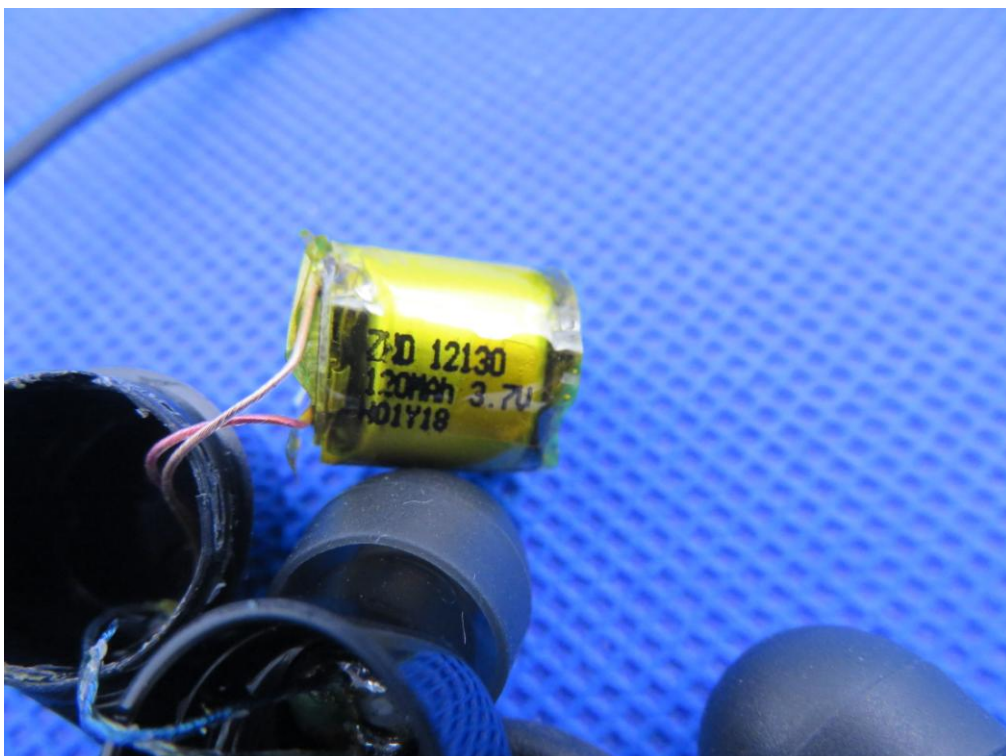

INTERNAL VIEW OF EUT-1

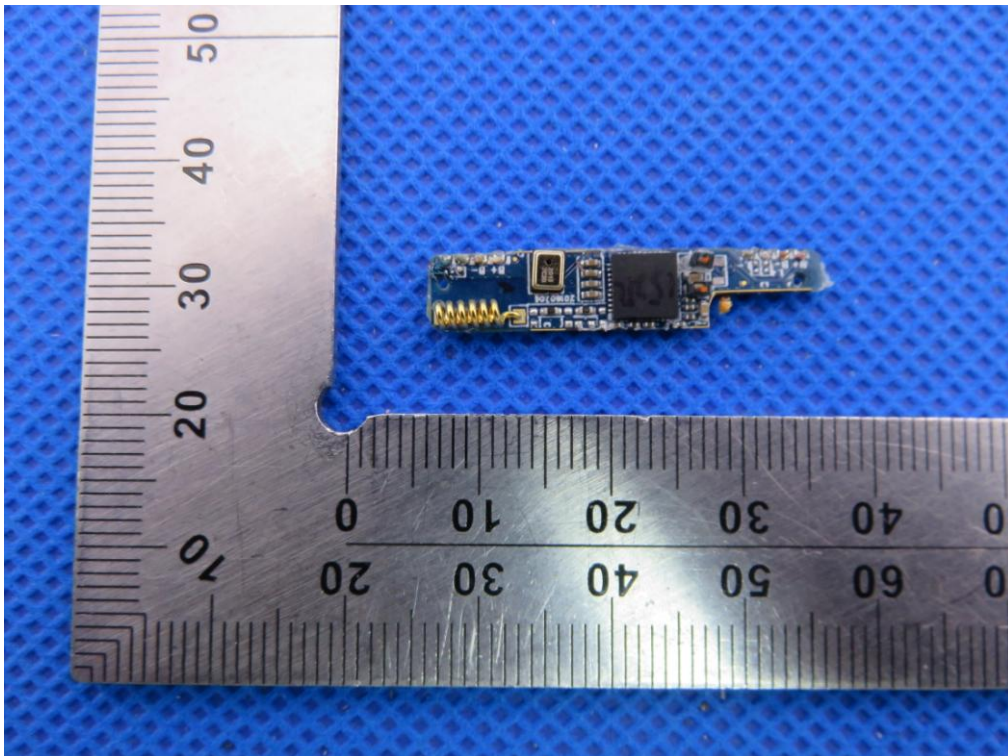

INTERNAL VIEW OF EUT-2

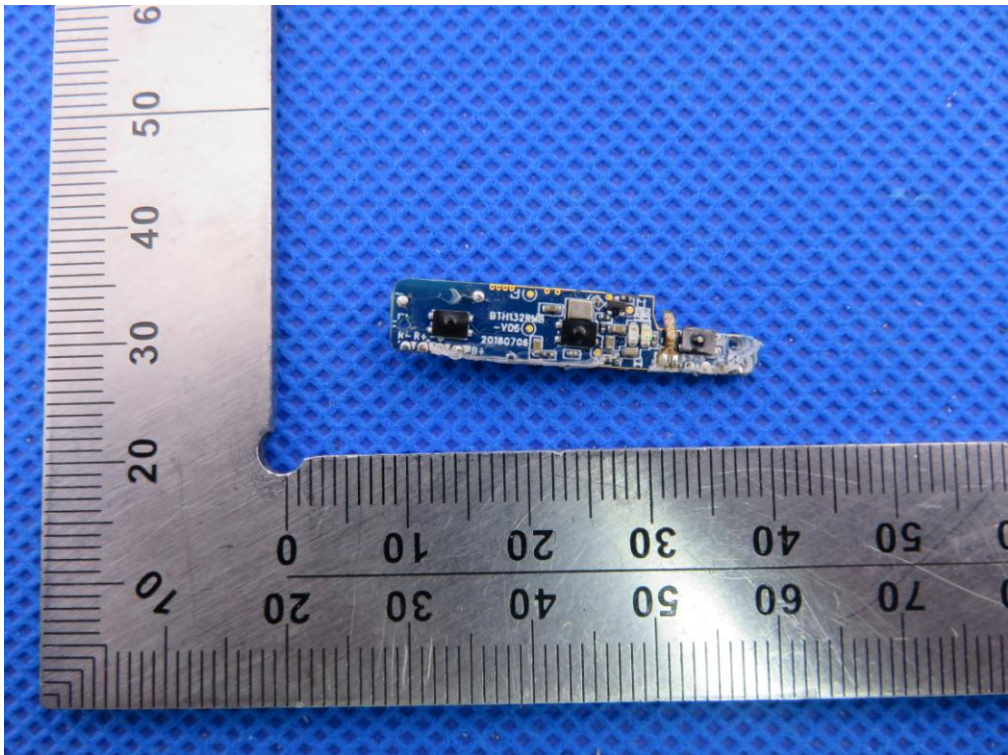



INTERNAL VIEW OF EUT-3

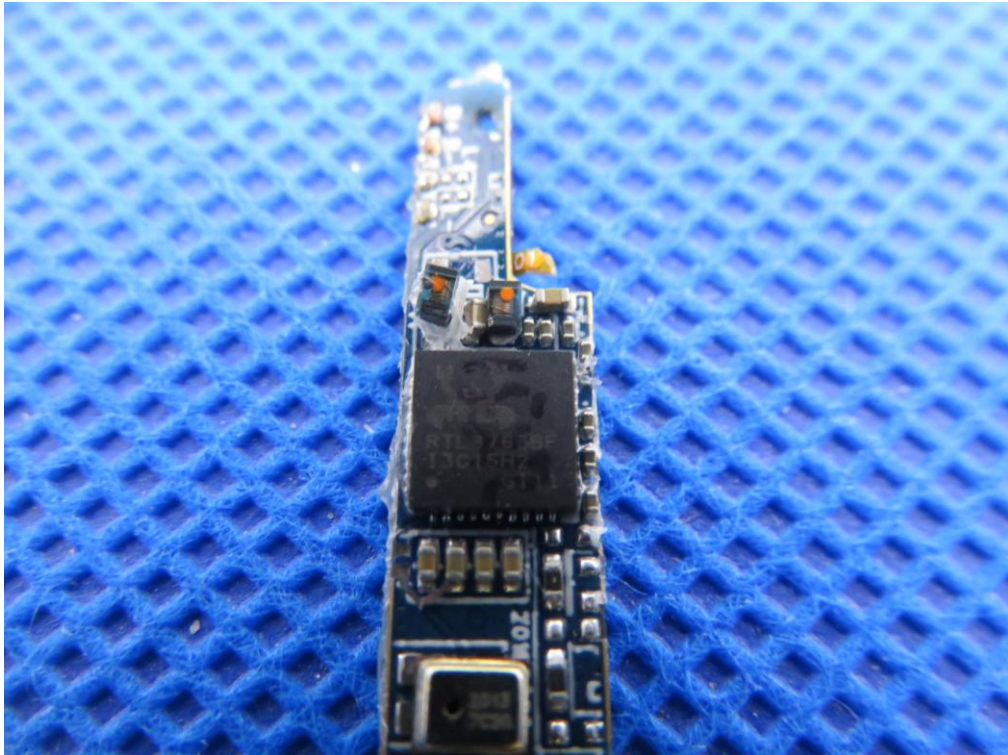

---END OF REPORT---