



**CFR 47 FCC PART 15 SUBPART C
ISED RSS-247 ISSUE 2**

CERTIFICATION TEST REPORT

For

TCL Zoom remote

MODEL NUMBER: TCL ZOOM

**FCC ID: W8UTCLZOOM
IC: 25533-TCLZOOM**

REPORT NUMBER: 4789237289-2

ISSUE DATE: January 07, 2020

Prepared for

**TTE Technology, Inc.
1860 Compton Ave Corona, CA 92881**

Prepared by

**UL Verification Services (Guangzhou) Co., Ltd, Song Shan Lake Branch
Building 10, Innovation Technology Park, No. 1, Li Bin Road,
Song Shan Lake Hi-Tech Development Zone, Dongguan, People's Republic of China
Tel: +86 769-22038881
Fax: +86 769 33244054
Website: www.ul.com**



Revision History

<u>Rev.</u>	<u>Issue Date</u>	<u>Revisions</u>	<u>Revised By</u>
V0	01/07/2020	Initial Issue	



Summary of Test Results			
Clause	Test Items	FCC/ISED Rules	Test Results
1	6dB Bandwidth and 99% Occupied Bandwidth	FCC Part 15.247 (a) (2) RSS-247 Clause 5.2 (a) ISED RSS-Gen Clause 6.7	Pass
2	Peak Conducted Output Power	FCC Part 15.247 (b) (3) RSS-247 Clause 5.4 (d)	Pass
3	Power Spectral Density	FCC Part 15.247 (e) RSS-247 Clause 5.2 (b)	Pass
4	Conducted Bandedge and Spurious Emission	FCC Part 15.247 (d) RSS-247 Clause 5.5	Pass
5	Radiated Bandedge and Spurious Emission	FCC Part 15.247 (d) FCC Part 15.209 FCC Part 15.205 RSS-247 Clause 5.5 RSS-GEN Clause 8.9	Pass
6	Conducted Emission Test For AC Power Port	FCC Part 15.207 RSS-GEN Clause 8.8	Not Applicable
7	Antenna Requirement	FCC Part 15.203 RSS-GEN Clause 6.8	Pass
Note: This test report is only published to and used by the applicant, and it is not for evidence purpose in China.			



TABLE OF CONTENTS

1. ATTESTATION OF TEST RESULTS	6
2. TEST METHODOLOGY	7
3. FACILITIES AND ACCREDITATION	7
4. CALIBRATION AND UNCERTAINTY	8
4.1. <i>MEASURING INSTRUMENT CALIBRATION</i>	<i>8</i>
4.2. <i>MEASUREMENT UNCERTAINTY.....</i>	<i>8</i>
5. EQUIPMENT UNDER TEST	9
5.1. <i>DESCRIPTION OF EUT</i>	<i>9</i>
5.2. <i>MAXIMUM OUTPUT POWER.....</i>	<i>9</i>
5.3. <i>CHANNEL LIST</i>	<i>9</i>
5.4. <i>TEST CHANNEL CONFIGURATION.....</i>	<i>10</i>
5.5. <i>THE WORSE CASE POWER SETTING PARAMETER.....</i>	<i>10</i>
5.6. <i>DESCRIPTION OF AVAILABLE ANTENNAS</i>	<i>10</i>
5.7. <i>WORST-CASE CONFIGURATIONS.....</i>	<i>10</i>
5.8. <i>TEST ENVIRONMENT</i>	<i>10</i>
5.9. <i>DESCRIPTION OF TEST SETUP.....</i>	<i>11</i>
6. MEASURING INSTRUMENT AND SOFTWARE USED	12
7. ANTENNA PORT TEST RESULTS	14
7.1. <i>ON TIME AND DUTY CYCLE.....</i>	<i>14</i>
7.2. <i>6 dB DTS BANDWIDTH AND 99% BANDWIDTH</i>	<i>16</i>
7.3. <i>PEAK CONDUCTED OUTPUT POWER.....</i>	<i>18</i>
7.4. <i>POWER SPECTRAL DENSITY</i>	<i>20</i>
7.5. <i>CONDUCTED BANDEDGE AND SPURIOUS EMISSIONS.....</i>	<i>22</i>
8. RADIATED TEST RESULTS.....	24
8.1. <i>RESTRICTED BANDEDGE</i>	<i>29</i>
8.2. <i>SPURIOUS EMISSIONS (1~3GHz).....</i>	<i>35</i>
8.3. <i>SPURIOUS EMISSIONS (3~18GHz).....</i>	<i>41</i>
8.4. <i>SPURIOUS EMISSIONS 18G ~ 26GHz.....</i>	<i>47</i>
8.5. <i>SPURIOUS EMISSIONS 30M ~ 1 GHz</i>	<i>49</i>
8.6. <i>SPURIOUS EMISSIONS BELOW 30M.....</i>	<i>51</i>
9. ANTENNA REQUIREMENTS.....	54
Appendix A): <i>6dB Bandwidth.....</i>	<i>55</i>



Appendix B): Occupied Bandwidth	57
Appendix C): Band-edge for RF Conducted Emissions	59
Appendix D): RF Conducted Spurious Emissions	61
Appendix E): Maximum Power Spectral Density	66



1. ATTESTATION OF TEST RESULTS

Applicant Information

Company Name: TTE Technology, Inc.
Address: 1860 Compton Ave Corona, CA 92881

Manufacturer Information

Company Name: TCL KING ELECTRICAL APPLIANCES (HUIZHOU) CO LTD
Address: NO.78 4TH HUIFENG RD, ZHONGKAI NEW & HIGH-TECH INDUSTRIES DEVELOPMENT ZONE, HUIZHOU, GUANGDONG 516006 CHINA

EUT Information

EUT Name: TCL Zoom remote
Model: TCL ZOOM
Sample Status: Normal
Sample ID: 2664026
Sample Received Date: November 13, 2019
Date of Tested: November 14, 2019 ~January 06, 2020

APPLICABLE STANDARDS	
STANDARD	TEST RESULTS
CFR 47 FCC PART 15 SUBPART C	PASS
ISED RSS-247 Issue 2	PASS
ISED RSS-GEN Issue 5	PASS

Prepared By:

Kebo Zhang
Project Engineer

Checked By:

Shawn Wen
Laboratory Leader

Approved By:

Stephen Guo
Laboratory Manager



2. TEST METHODOLOGY

The tests documented in this report were performed in accordance with KDB 558074 D01 15.247 Meas Guidance v05r02, KDB 414788 D01 Radiated Test Site v01r01, CFR 47 FCC Part 2, CFR 47 FCC Part 15, ANSI C63.10-2013, ISED RSS-247 Issue 2 and ISED RSS-GEN Issue 5.

3. FACILITIES AND ACCREDITATION

Accreditation Certificate	<p>A2LA (Certificate No.: 4102.01) UL Verification Services (Guangzhou) Co., Ltd. Song Shan Lake Branch. has been assessed and proved to be in compliance with A2LA.</p> <p>FCC (FCC Designation No.: CN1187) UL Verification Services (Guangzhou) Co., Ltd. Song Shan Lake Branch. Has been recognized to perform compliance testing on equipment subject to the Commission's Declaration of Conformity (DoC) and Certification rules</p> <p>ISED(Company No.: 21320) UL Verification Services (Guangzhou) Co., Ltd. Song Shan Lake Branch. has been registered and fully described in a report filed with ISED. The Company Number is 21320.</p> <p>VCCI (Registration No.: G-20019, R-20004, C-20012 and T-20011) UL Verification Services (Guangzhou) Co., Ltd. Song Shan Lake Branch. has been assessed and proved to be in compliance with VCCI, the Membership No. is 3793. Facility Name: Chamber D, the VCCI registration No. is G-20019 and R-20004 Shielding Room B , the VCCI registration No. is C-20012 and T-20011</p>
---------------------------	---

Note 1: All tests measurement facilities use to collect the measurement data are located at Building 10, Innovation Technology Park, Song Shan Lake Hi tech Development Zone, Dongguan, 523808, China

Note 2: The test anechoic chamber in UL Verification Services (Guangzhou) Co., Ltd. Song Shan Lake Branch had been calibrated and compared to the open field sites and the test anechoic chamber is shown to be equivalent to or worst case from the open field site.

Note 3: For below 30MHz, lab had performed measurements at test anechoic chamber and comparing to measurements obtained on an open field site. And these measurements below 30MHz had been correlated to measurements performed on an OFS.



4. CALIBRATION AND UNCERTAINTY

4.1. MEASURING INSTRUMENT CALIBRATION

The measuring equipment utilized to perform the tests documented in this report has been calibrated in accordance with the manufacturer's recommendations, and is traceable to recognize national standards.

4.2. MEASUREMENT UNCERTAINTY

Where relevant, the following measurement uncertainty levels have been estimated for tests performed on the apparatus:

Test Item	Uncertainty
Conduction emission	3.62dB
Radiation Emission test(include Fundamental emission) (9kHz-30MHz)	2.2dB
Radiation Emission test(include Fundamental emission) (30MHz-1GHz)	4.00dB
Radiation Emission test (1GHz to 26GHz)(include Fundamental emission)	5.78dB (1GHz-18Gz)
	5.23dB (18GHz-26Gz)
Note: This uncertainty represents an expanded uncertainty expressed at approximately the 95% confidence level using a coverage factor of k=2.	



5. EQUIPMENT UNDER TEST

5.1. DESCRIPTION OF EUT

EUT Name	TCL Zoom remote		
Model	TCL ZOOM		
Product Description	Operation Frequency	2402 MHz ~ 2480 MHz	
	Modulation Type	Data Rate	
	GFSK	1Mbps	
Power Supply	Battery	DC 3V	

5.2. MAXIMUM OUTPUT POWER

Bluetooth Mode	Frequency (MHz)	Channel Number	Max Output Power (dBm)	EIRP (dBm)
BLE	2402-2480	0-39[40]	2.785	2.785

5.3. CHANNEL LIST

Channel	Frequency (MHz)	Channel	Frequency (MHz)	Channel	Frequency (MHz)	Channel	Frequency (MHz)
0	2402	11	2424	22	2446	33	2468
1	2404	12	2426	23	2448	34	2470
2	2406	13	2428	24	2450	35	2472
3	2408	14	2430	25	2452	36	2474
4	2410	15	2432	26	2454	37	2476
5	2412	16	2434	27	2456	38	2478
6	2414	17	2436	28	2458	39	2480
7	2416	18	2438	29	2460	/	/
8	2418	19	2440	30	2462	/	/
9	2420	20	2442	31	2464	/	/
10	2422	21	2444	32	2468	/	/



5.4. TEST CHANNEL CONFIGURATION

Test Mode	Test Channel	Frequency
GFSK	CH 0, CH 19, CH 39/ Low, Middle, High	2402MHz, 2440MHz, 2480MHz

5.5. THE WORSE CASE POWER SETTING PARAMETER

The Worst Case Power Setting Parameter under 2400 ~ 2483.5MHz Band				
Test Software		Ampak RFTTestTool		
Modulation Type	Transmit Antenna Number	Test Channel Power Setting		
		CH 0	CH 19	CH 39
GFSK	1	Default	Default	Default

5.6. DESCRIPTION OF AVAILABLE ANTENNAS

Antenna	Frequency (MHz)	Antenna Type	MAX Antenna Gain (dBi)
1	2402-2480	Chip Antenna	0

Test Mode	Transmit and Receive Mode	Description
GFSK	1TX, 1RX	Chain 1 can be used as transmitting/receiving antenna.

5.7. WORST-CASE CONFIGURATIONS

Bluetooth Mode	Modulation Technology	Modulation Type	Data Rate (Mbps)
BLE	DTS	GFSK	1Mbit/s

5.8. TEST ENVIRONMENT

Environment Parameter	Selected Values During Tests	
Relative Humidity	45 ~ 70%	
Atmospheric Pressure:	1025Pa	
Temperature	TN	22 ~ 28°C
Voltage :	VL	N/A
	VN	DC 3V
	VH	N/A

Note: VL= Lower Extreme Test Voltage
VN= Nominal Voltage
VH= Upper Extreme Test Voltage
TN= Normal Temperature

5.9. DESCRIPTION OF TEST SETUP

SUPPORT EQUIPMENT

Item	Equipment	Brand Name	Model Name	P/N
1	PC	Dell	Vostro 3902	8KNDDDB2
2	USB TO CSR	/	USB_SPI_TOOLS	/

I/O CABLES

Cable No	Port	Connector Type	Cable Type	Cable Length(m)	Remarks
1	USB	/	/	1.0	/

ACCESSORY

Item	Accessory	Brand Name	Model Name	Description
1	/	/	/	/

TEST SETUP

The EUT can work in engineering mode with a software through a Laptop.

SETUP DIAGRAM FOR TEST

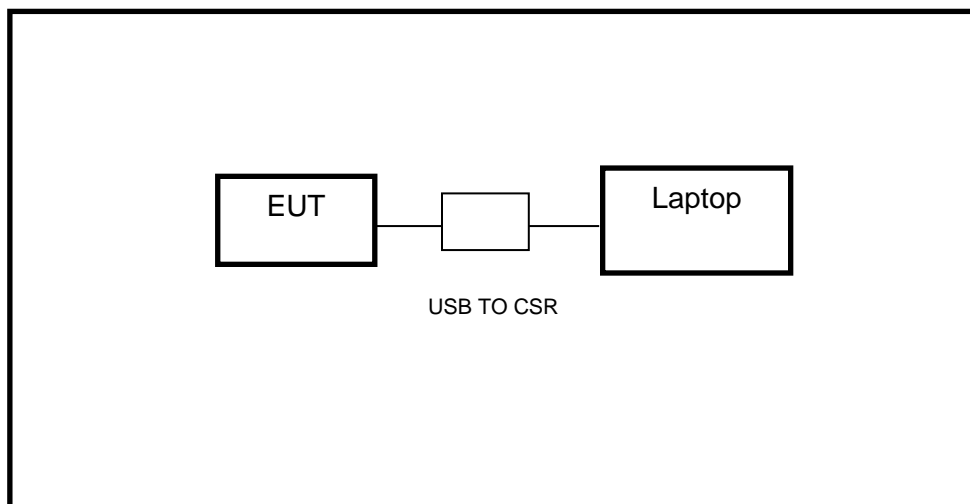



6. MEASURING INSTRUMENT AND SOFTWARE USED

Conducted Emissions							
Instrument							
Used	Equipment	Manufacturer	Model No.	Serial No.	Upper Last Cal.	Last Cal.	Next Cal.
<input checked="" type="checkbox"/>	EMI Test Receiver	R&S	ESR3	101961	Dec.10,2018	Dec.05,2019	Dec.05,2020
<input checked="" type="checkbox"/>	Two-Line V-Network	R&S	ENV216	101983	Dec.10,2018	Dec.05,2019	Dec.05,2020
<input checked="" type="checkbox"/>	Artificial Mains Networks	Schwarzbeck	NSLK 8126	8126465	Dec.10,2018	Dec.05,2019	Dec.05,2020
Software							
Used	Description			Manufacturer	Name	Version	
<input checked="" type="checkbox"/>	Test Software for Conducted disturbance			Farad	EZ-EMC	Ver. UL-3A1	
Radiated Emissions							
Instrument							
Used	Equipment	Manufacturer	Model No.	Serial No.	Upper Last Cal.	Last Cal.	Next Cal.
<input checked="" type="checkbox"/>	MXE EMI Receiver	KESIGHT	N9038A	MY56400036	Dec.10,2018	Dec.06,2019	Dec.05,2020
<input checked="" type="checkbox"/>	Hybrid Log Periodic Antenna	TDK	HLP-3003C	130960	Sep.17,2018	Sep.17,2018	Sep.17,2021
<input checked="" type="checkbox"/>	Preamplifier	HP	8447D	2944A09099	Dec.10,2018	Dec.05,2019	Dec.05,2020
<input checked="" type="checkbox"/>	EMI Measurement Receiver	R&S	ESR26	101377	Dec.10,2018	Dec.05,2019	Dec.05,2020
<input checked="" type="checkbox"/>	Horn Antenna	TDK	HRN-0118	130939	Sep.17,2018	Sep.17,2018	Sep.17,2021
<input checked="" type="checkbox"/>	High Gain Horn Antenna	Schwarzbeck	BBHA-9170	691	Aug.11,2018	Aug.11,2018	Aug.11,2021
<input checked="" type="checkbox"/>	Preamplifier	TDK	PA-02-0118	TRS-305-00067	Dec.10,2018	Dec.05,2019	Dec.05,2020
<input checked="" type="checkbox"/>	Preamplifier	TDK	PA-02-2	TRS-307-00003	Dec.10,2018	Dec.05,2019	Dec.05,2020
<input checked="" type="checkbox"/>	Loop antenna	Schwarzbeck	1519B	00008	Jan.07,2019	Jan.07,2019	Jan.07,2022
<input checked="" type="checkbox"/>	Band Reject Filter	Wainwright	WRCJV8-2350-2400-2483.5-2533.5-40SS	4	Dec.10,2018	Dec.05,2019	Dec.05,2020
<input checked="" type="checkbox"/>	High Pass Filter	Wi	WHKX10-2700-3000-18000-40SS	23	Dec.10,2018	Dec.05,2019	Dec.05,2020
Software							
Used	Description			Manufacturer	Name	Version	
<input checked="" type="checkbox"/>	Test Software for Radiated disturbance			Farad	EZ-EMC	Ver. UL-3A1	



Other instruments							
Used	Equipment	Manufacturer	Model No.	Serial No.	Upper Last Cal.	Last Cal.	Next Cal.
<input checked="" type="checkbox"/>	Spectrum Analyzer	Keysight	N9030A	MY55410512	Dec.10,2018	Dec.06,2019	Dec.05,2020
<input checked="" type="checkbox"/>	Power Meter	Keysight	N1911A	MY55416024	Dec.10,2018	Dec.06,2019	Dec.05,2020
<input checked="" type="checkbox"/>	Power Sensor	Keysight	U2021XA	MY58100022	Dec.10,2018	Dec.06,2019	Dec.05,2020



7. ANTENNA PORT TEST RESULTS

7.1. ON TIME AND DUTY CYCLE

LIMITS

None; for reporting purposes only

PROCEDURE

KDB 558074 Zero-Span Spectrum Analyzer Method

TEST SETUP

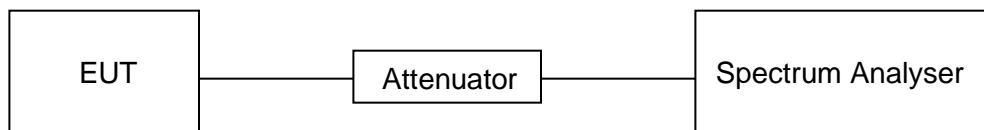

TEST ENVIRONMENT

Temperature	25.1°C	Relative Humidity	55%
Atmosphere Pressure	101kPa	Test Voltage	DC 3V

RESULTS

Mode	On Time (msec)	Period (msec)	Duty Cycle x (Linear)	Duty Cycle (%)	Duty Cycle Correction Factor (db)	1/T Minimum VBW (KHz)	Final setting For VBW (KHz)
BLE	0.428	0.631	0.678	67.8	1.69	2.34	3

Note:

Duty Cycle Correction Factor=10log(1/x).

Where: x is Duty Cycle(Linear)

Where: T is On Time (transmit duration)

If that calculated VBW is not available on the analyzer then the next higher value should be used.



ON TIME AND DUTY CYCLE MID CH

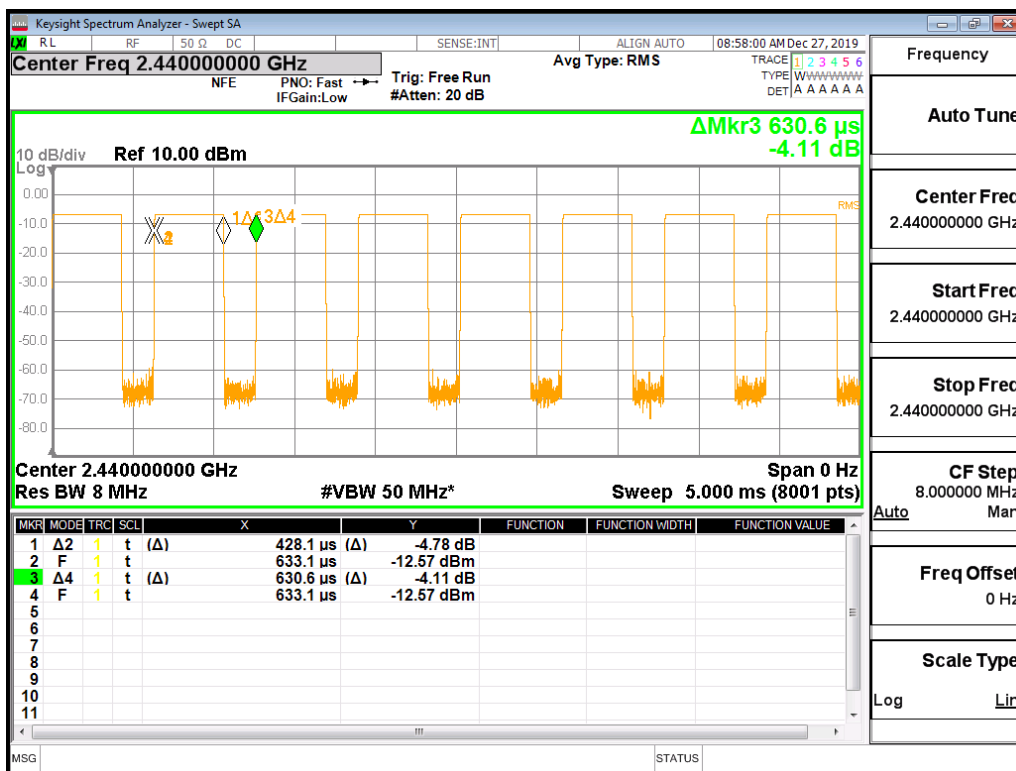

7.2. 6 dB DTS BANDWIDTH AND 99% BANDWIDTH

LIMITS

CFR 47FCC Part15 (15.247) Subpart C ISED RSS-247 ISSUE 2			
Section	Test Item	Limit	Frequency Range (MHz)
CFR 47 FCC 15.247(a)(2) ISED RSS-247 5.2 (a)	6dB Bandwidth	$\geq 500\text{KHz}$	2400-2483.5
ISED RSS-Gen Clause 6.7	99% Occupied Bandwidth	For reporting purposes only.	2400-2483.5

TEST PROCEDURE

Connect the UUT to the spectrum analyser and use the following settings:

Center Frequency	The center frequency of the channel under test
Detector	Peak
RBW	For 6 dB Bandwidth :100kHz For 99% Occupied Bandwidth :1% to 5% of the occupied bandwidth
VBW	For 6dB Bandwidth : $\geq 3 \times \text{RBW}$ For 99% Occupied Bandwidth : $\geq 3 \times \text{RBW}$
Trace	Max hold
Sweep	Auto couple

Allow the trace to stabilize and measure the maximum width of the emission that is constrained by the frequencies associated with the two outermost amplitude points (upper and lower frequencies) that are attenuated by 6 dB/99% relative to the maximum level measured in the fundamental emission.

TEST SETUP

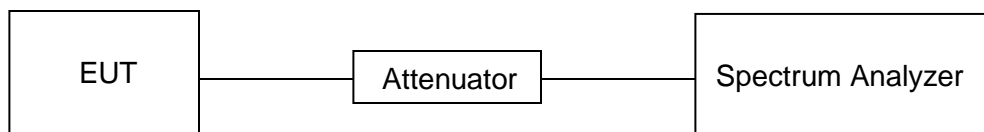



TEST ENVIRONMENT

Temperature	25.1°C	Relative Humidity	55%
Atmosphere Pressure	101kPa	Test Voltage	DC 3V

RESULTS

Please refer to appendix A and B.



7.3. PEAK CONDUCTED OUTPUT POWER

LIMITS

CFR 47 FCC Part15 (15.247) Subpart C ISED RSS-247 ISSUE 2			
Section	Test Item	Limit	Frequency Range (MHz)
CFR 47 FCC 15.247(b)(3) ISED RSS-247 5.4 (d)	Peak Output Power	1 watt or 30dBm	2400-2483.5

TEST PROCEDURE

Place the EUT on the table and set it in the transmitting mode.
Remove the antenna from the EUT and then connect a low loss RF cable from the antenna port to the Power sensor.
Measure peak power each channel.

TEST SETUP

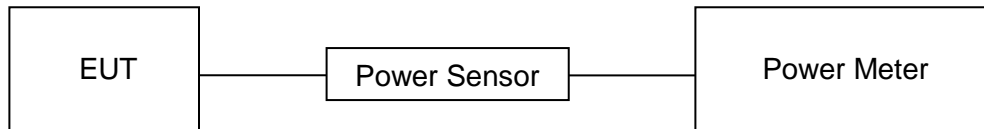

TEST ENVIRONMENT

Temperature	25.1°C	Relative Humidity	55%
Atmosphere Pressure	101kPa	Test Voltage	DC 3V



RESULTS

Test Channel	Maximum Conducted Output Power(PK)	EIRP	LIMIT
	(dBm)	(dBm)	dBm
Low	2.785	2.785	30
Middle	2.498	2.498	30
High	2.684	2.684	30

7.4. POWER SPECTRAL DENSITY

LIMITS

CFR 47 FCC Part15 (15.247) Subpart C ISED RSS-247 ISSUE 2			
Section	Test Item	Limit	Frequency Range (MHz)
CFR 47 FCC §15.247 (e) ISED RSS-247 5.2 (b)	Power Spectral Density	8 dBm in any 3 kHz band	2400-2483.5

TEST PROCEDURE

Connect the UUT to the spectrum analyser and use the following settings:

Center Frequency	The center frequency of the channel under test
Detector	Peak
RBW	$3 \text{ kHz} \leq \text{RBW} \leq 100 \text{ kHz}$
VBW	$\geq 3 \times \text{RBW}$
Span	1.5 x DTS bandwidth
Trace	Max hold
Sweep time	Auto couple.

Allow trace to fully stabilize and use the peak marker function to determine the maximum amplitude level within the RBW.

If measured value exceeds limit, reduce RBW (no less than 3 kHz) and repeat.

TEST SETUP

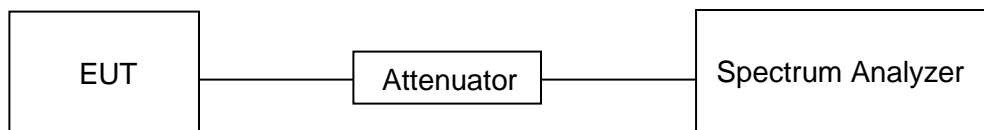



TEST ENVIRONMENT

Temperature	25.1°C	Relative Humidity	55%
Atmosphere Pressure	101kPa	Test Voltage	DC 3V

RESULTS

Please refer to appendix E.



7.5. CONDUCTED BANDEGE AND SPURIOUS EMISSIONS

LIMITS

CFR 47 FCC Part15 (15.247) Subpart C ISED RSS-247 ISSUE 2		
Section	Test Item	Limit
CFR 47 FCC §15.247 (d) ISED RSS-247 5.5	Conducted Bandedge and Spurious Emissions	at least 20 dB below that in the 100 kHz bandwidth within the band that contains the highest level of the desired power

TEST PROCEDURE

Connect the UUT to the spectrum analyser and use the following settings:

Center Frequency	The center frequency of the channel under test
Detector	Peak
RBW	100kHz
VBW	$\geq 3 \times \text{RBW}$
Span	$\geq 1.5 \times \text{DTS bandwidth}$
Trace	Max hold
Sweep time	Auto couple

Use the peak marker function to determine the maximum PSD level.

Span	Set the center frequency and span to encompass frequency range to be measured
Detector	Peak
RBW	100kHz
VBW	$\geq 3 \times \text{RBW}$
measurement points	$\geq \text{span}/\text{RBW}$
Trace	Max hold
Sweep time	Auto couple

Use the peak marker function to determine the maximum amplitude level.



TEST SETUP

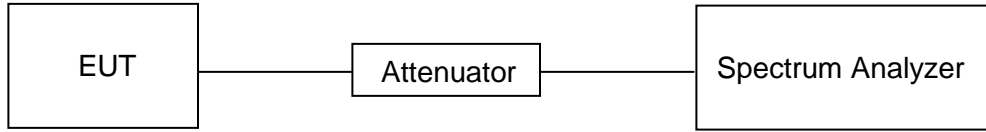

TEST ENVIRONMENT

Temperature	25.1°C	Relative Humidity	55%
Atmosphere Pressure	101kPa	Test Voltage	DC 3V

RESULTS

Please refer to appendix C and D.

8. RADIATED TEST RESULTS

LIMITS

Please refer to CFR 47 FCC §15.205 and §15.209

Please refer to ISED RSS-GEN Clause 8.9 and Clause 8.10

Radiation Disturbance Test Limit for FCC (Class B)(9kHz-1GHz)

Frequency (MHz)	Field Strength (microvolts/meter)	Measurement Distance (meters)
0.009~0.490	2400/F(kHz)	300
0.490~1.705	24000/F(kHz)	30
1.705~30.0	30	30
30~88	100	3
88~216	150	3
216~960	200	3
960~1000	500	3

Note: 1) At frequencies at or above 30 MHz, measurements may be performed at a distance other than what is specified provided: measurements are not made in the near field except where it can be shown that near field measurements are appropriate due to the characteristics of the device; and it can be demonstrated that the signal levels needed to be measured at the distance employed can be detected by the measurement equipment. Measurements shall not be performed at a distance greater than 30 meters unless it can be further demonstrated that measurements at a distance of 30 meters or less are impractical. When performing measurements at a distance other than that specified, the results shall be extrapolated to the specified distance using an extrapolation factor of 20 dB/decade (inverse linear-distance for field strength measurements; inverse-linear-distance-squared for power density measurements).

(2) At frequencies below 30 MHz, measurements may be performed at a distance closer than that specified in the regulations; however, an attempt should be made to avoid making measurements in the near field. Pending the development of an appropriate measurement procedure for measurements performed below 30 MHz, when performing measurements at a closer distance than specified, the results shall be extrapolated to the specified distance by either making measurements at a minimum of two distances on at least one radial to determine the proper extrapolation factor or by using the square of an inverse linear distance extrapolation factor (40 dB/decade). This paragraph (f) shall not apply to Access BPL devices operating below 30 MHz.

Radiation Disturbance Test Limit for FCC (Above 1GHz)

Frequency (MHz)	dB(uV/m) (at 3 meters)	
	Peak	Average
Above 1000	74	54

About Restricted bands of operation please refer to RSS-Gen section 8.10 and FCC §15.205 (a)

TEST SETUP AND PROCEDURE

Below 30MHz

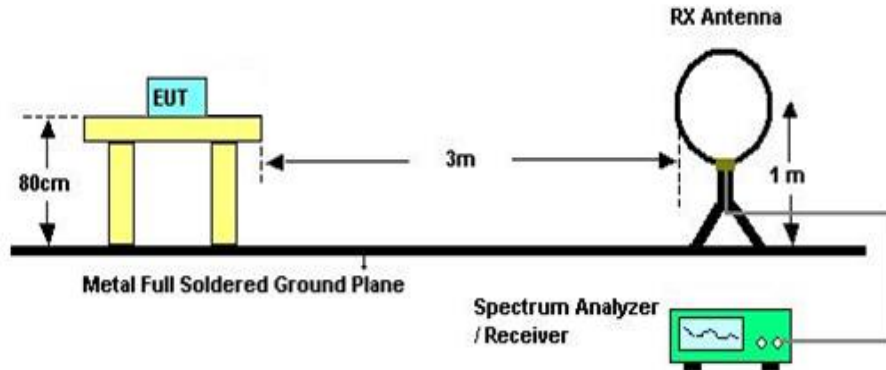

The setting of the spectrum analyser

RBW	200Hz (From 9kHz to 0.15MHz)/ 9kHz (From 0.15MHz to 30MHz)
VBW	200Hz (From 9kHz to 0.15MHz)/ 9kHz (From 0.15MHz to 30MHz)
Sweep	Auto
Trace	Max hold

1. The testing follows the guidelines in ANSI C63.10-2013
2. The EUT was arranged to its worst case and then turntable (from 0 degree to 360 degrees) to find the maximum reading. A pre-amp and a high pass filter are used for the test in order to get better signal level. Both Horizontal, Face-on and Face-off polarizations of the antenna are set to make the measurement.
3. The EUT was placed on a turntable with 80cm above ground.
4. The EUT was set 3 meters from the interference receiving antenna, which was mounted on the top of 1 meter height antenna tower.
5. The radiated emission limits are based on measurements employing a CISPR quasi-peak detector except for the frequency bands 9-90 kHz, 110-490 kHz and above 1000 MHz. Radiated emission limits in these three bands are based on measurements employing an average detector.
6. For measurement below 1GHz, the initial step in collecting conducted emission data is a spectrum analyzer peak detector mode pre-scanning the measurement frequency range. Significant peaks are then marked and then Quasi Peak and average detector mode re-measured. If the emission level of the EUT measured by the peak detector is 3 dB lower than the applicable limit, the peak emission level will be reported. Otherwise, the emission measurement will be repeated using the quasi-peak and average detector and reported.
7. Although these tests were performed other than open field site, adequate comparison measurements were confirmed against 30m open field site. Therefore sufficient tests were made to demonstrate that the alternative site produces results that correlate with the ones of tests made in an open field site based on KDB 414788.

Below 1G and above 30MHz

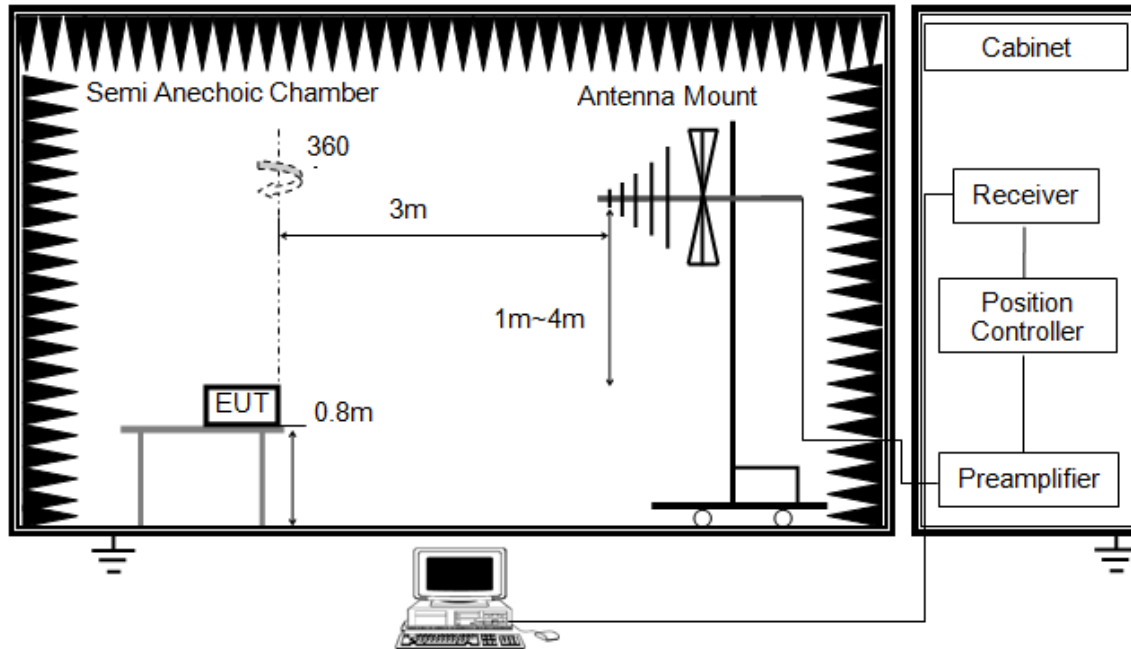

The setting of the spectrum analyser

RBW	120kHz
VBW	300kHz
Sweep	Auto
Detector	Peak/QP
Trace	Max hold

1. The testing follows the guidelines in ANSI C63.10-2013.
2. The EUT was arranged to its worst case and then tune the antenna tower (from 1 m to 4 m) and turntable (from 0 degree to 360 degrees) to find the maximum reading. A pre-amp and a high pass filter are used for the test in order to get better signal level. Both horizontal and vertical polarizations of the antenna are set to make the measurement.
3. The EUT was placed on a turntable with 80cm above ground.
4. The EUT was set 3 meters from the interference receiving antenna, which was mounted on the top of a variable height antenna tower.
5. For measurement below 1GHz, the initial step in collecting conducted emission data is a spectrum analyzer peak detector mode pre-scanning the measurement frequency range. Significant peaks are then marked and then Quasi Peak detector mode re-measured. If the emission level of the EUT measured by the peak detector is 3 dB lower than the applicable limit, the peak emission level will be reported. Otherwise, the emission measurement will be repeated using the quasi-peak detector and reported.

Above 1G

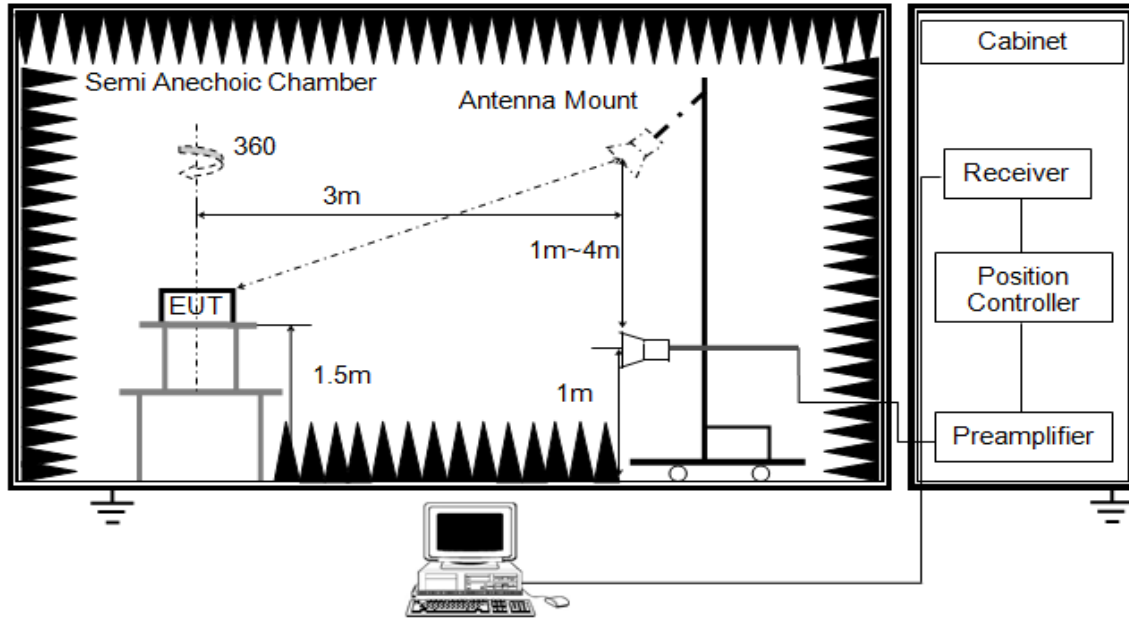

The setting of the spectrum analyser

RBW	1MHz
VBW	PEAK: 3MHz AVG: see note 6
Sweep	Auto
Detector	Peak
Trace	Max hold

1. The testing follows the guidelines in ANSI C63.10-2013.
2. The EUT was arranged to its worst case and then tune the antenna tower (1.5 m) and turntable (from 0 degree to 360 degrees) to find the maximum reading. A pre-amp and a high pass filter are used for the test in order to get better signal level. Both horizontal and vertical polarizations of the antenna are set to make the measurement.
3. The EUT was placed on a turntable with 1.5m above ground.
4. The EUT was set 3 meters from the interference receiving antenna, which was mounted on the top of a variable height antenna tower.
5. For measurement above 1GHz, the emission measurement will be measured by the peak detector. This peak level, once corrected, must comply with the limit specified in Section 15.209.
6. For measurements above 1 GHz the resolution bandwidth is set to 1 MHz, then the video bandwidth is set to 3 MHz for peak measurements and 1 MHz resolution bandwidth with 1/T video bandwidth with peak detector for average measurements. For the Duty Cycle please refer to clause 7.1.ON TIME AND DUTY CYCLE.

X axis, Y axis, Z axis positions:

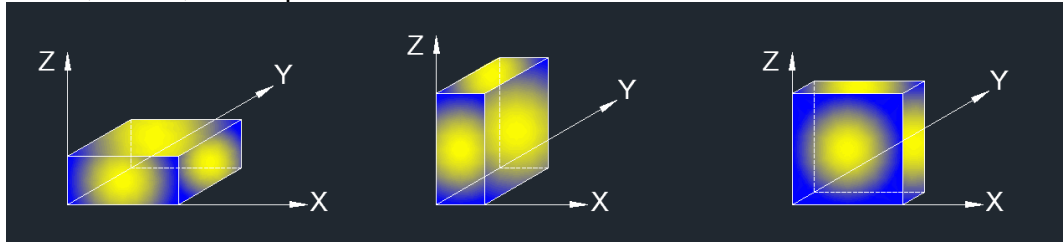

Note 1: For all radiated test, EUT in each of three orthogonal axis emissions had been tested, but only the worst case (X axis) data recorded in the report.

Note 2: The EUT does not support simultaneous transmission.

Note 3: The EUT was fully exercised with external accessories during the test. In the case of multiple accessory external ports, an external accessory shall be connected to one of each type of port.

TEST ENVIRONMENT

Temperature	25.1°C	Relative Humidity	55%
Atmosphere Pressure	101kPa	Test Voltage	DC 3V

RESULTS



8.1. RESTRICTED BANDEGE

RESTRICTED BANDEGE (LOW CHANNEL, HORIZONTAL)

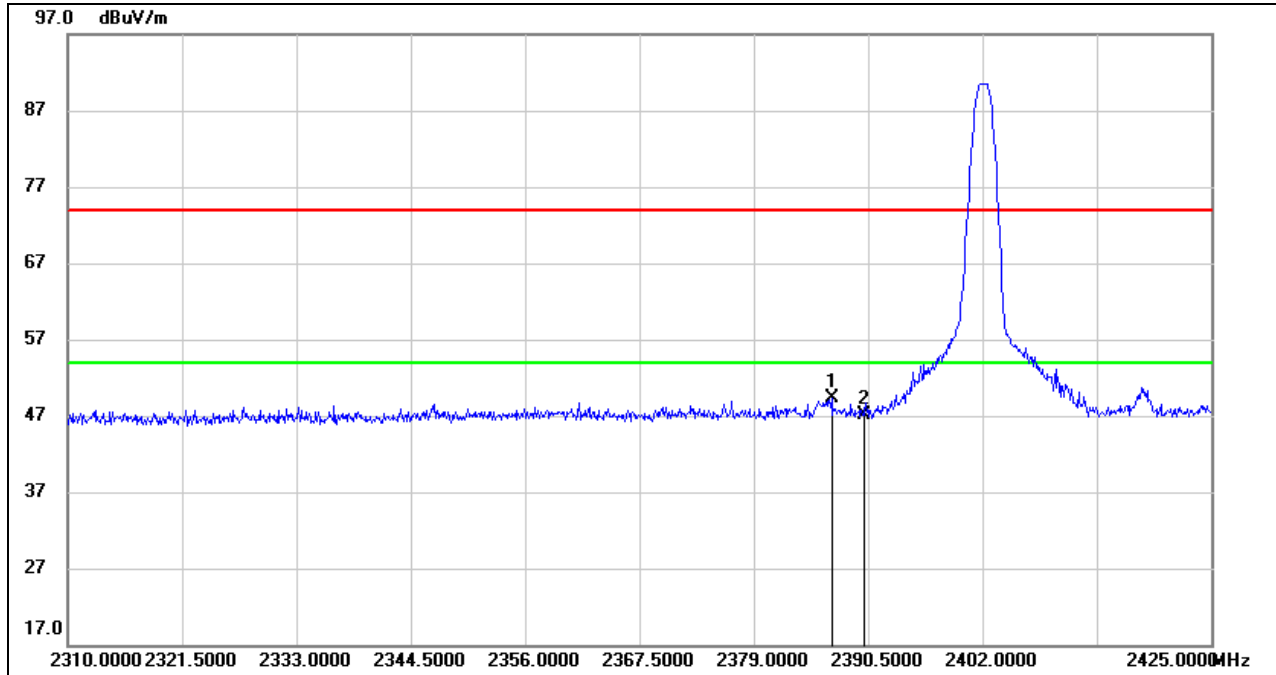

No.	Frequency (MHz)	Reading (dBuV)	Correct (dB/m)	Result (dBuV/m)	Limit (dBuV/m)	Margin (dB)	Remark
1	2386.820	16.33	32.94	49.27	74.00	-24.73	peak
2	2390.000	14.16	32.94	47.10	74.00	-26.90	peak

- Note: 1. Measurement = Reading Level + Correct Factor.
 2. If Peak Result complies with AV limit, AV Result is deemed to comply with AV limit.
 3. Peak: Peak detector.
 4. Only the worst case emission will be recorder, if it complies with the limit, the other emissions deemed to comply with the limit.



RESTRICTED BANDEDGE (LOW CHANNEL, VERTICAL)

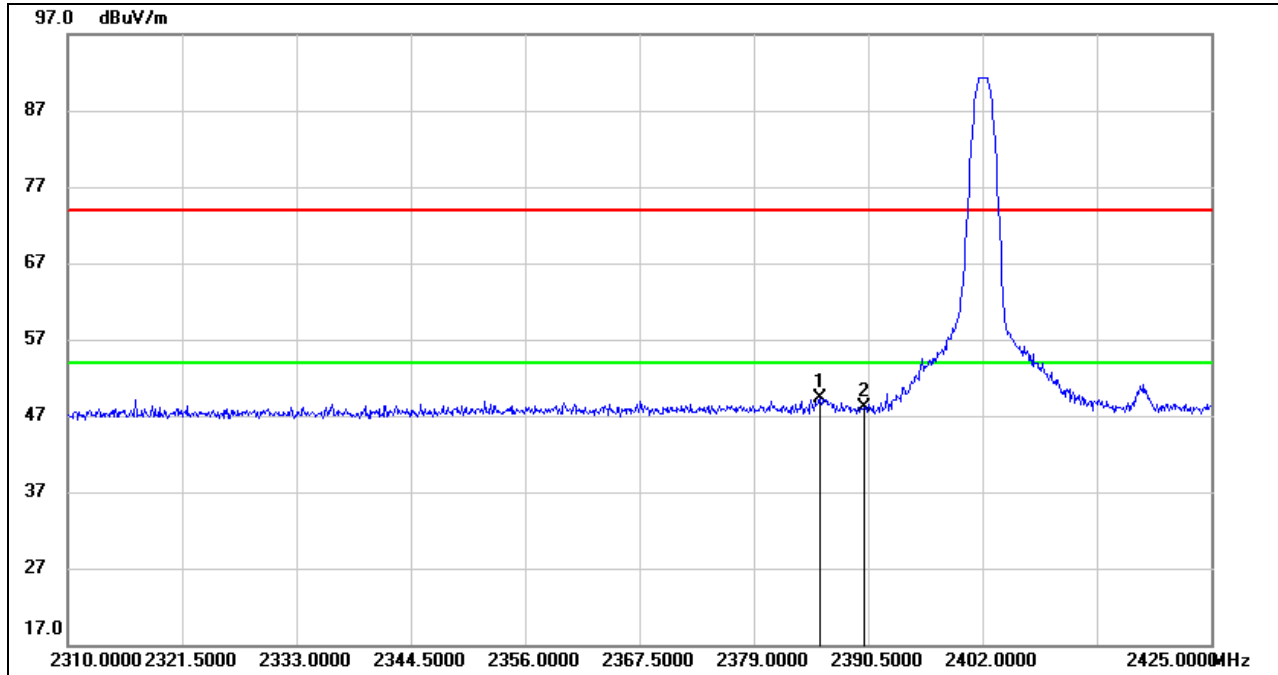

No.	Frequency (MHz)	Reading (dBuV)	Correct (dB/m)	Result (dBuV/m)	Limit (dBuV/m)	Margin (dB)	Remark
1	2385.670	16.33	32.93	49.26	74.00	-24.74	peak
2	2390.000	15.11	32.94	48.05	74.00	-25.95	peak

Note: 1. Measurement = Reading Level + Correct Factor.
 2. If Peak Result complies with AV limit, AV Result is deemed to comply with AV limit.
 3. Peak: Peak detector.
 4. Only the worst case emission will be recorder, if it complies with the limit, the other emissions deemed to comply with the limit.



RESTRICTED BANDEDGE (HIGH CHANNEL, HORIZONTAL)

PEAK

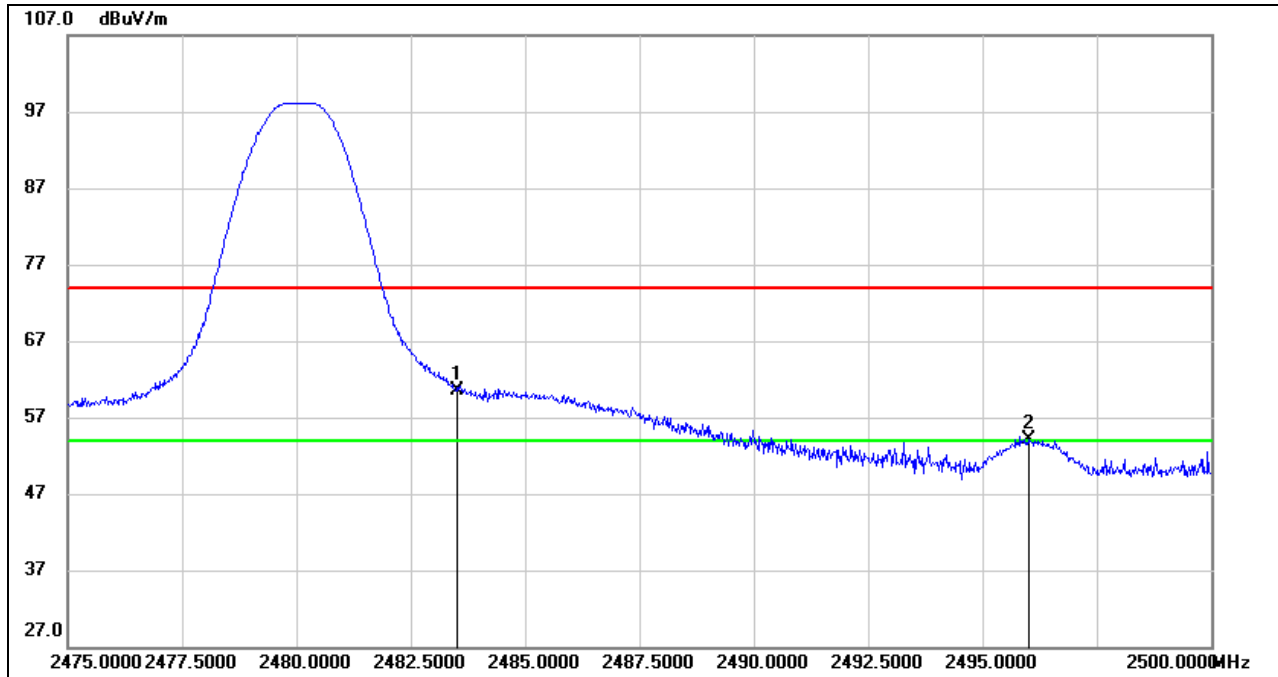

No.	Frequency (MHz)	Reading (dBuV)	Correct (dB/m)	Result (dBuV/m)	Limit (dBuV/m)	Margin (dB)	Remark
1	2483.500	26.89	33.58	60.47	74.00	-13.53	peak
2	2495.975	20.48	33.67	54.15	74.00	-19.85	peak

- Note: 1. Measurement = Reading Level + Correct Factor.
 2. If Peak Result complies with AV limit, AV Result is deemed to comply with AV limit.
 3. Peak: Peak detector.
 4. Only the worst case emission will be recorder, if it complies with the limit, the other emissions deemed to comply with the limit.



AVG

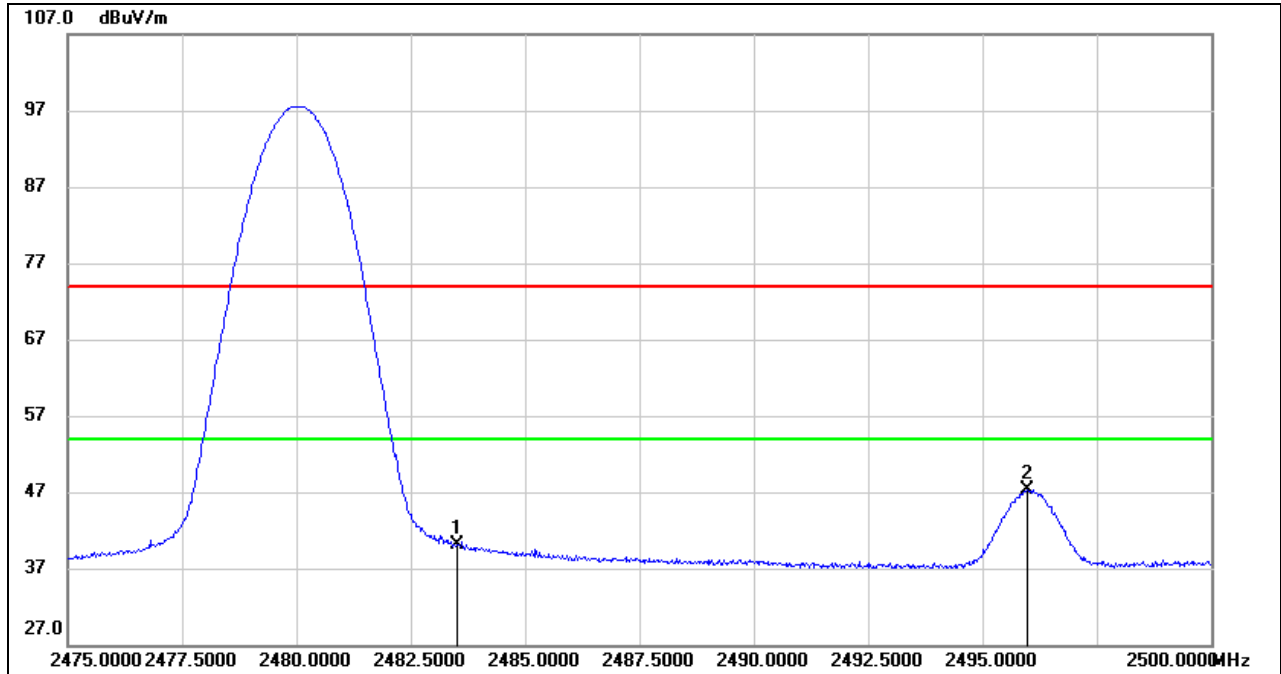

No.	Frequency (MHz)	Reading (dBuV)	Correct (dB/m)	Result (dBuV/m)	Limit (dBuV/m)	Margin (dB)	Remark
1	2483.500	6.57	33.58	40.15	54.00	-13.85	AVG
2	2495.975	13.56	33.67	47.23	54.00	-6.77	AVG

- Note: 1. Measurement = Reading Level + Correct Factor.
 2. If Peak Result complies with AV limit, AV Result is deemed to comply with AV limit.
 3. Peak: Peak detector.
 4. AVG: $VBW=1/Ton$, where: Ton is the transmitting duration.
 5. For the transmitting duration, please refer to clause 7.1.
 6. Only the worst emission was recorded, if it complies with the limit, the other emissions deemed to comply with the limit.



RESTRICTED BANDEDGE (HIGH CHANNEL, VERTICAL)

PEAK

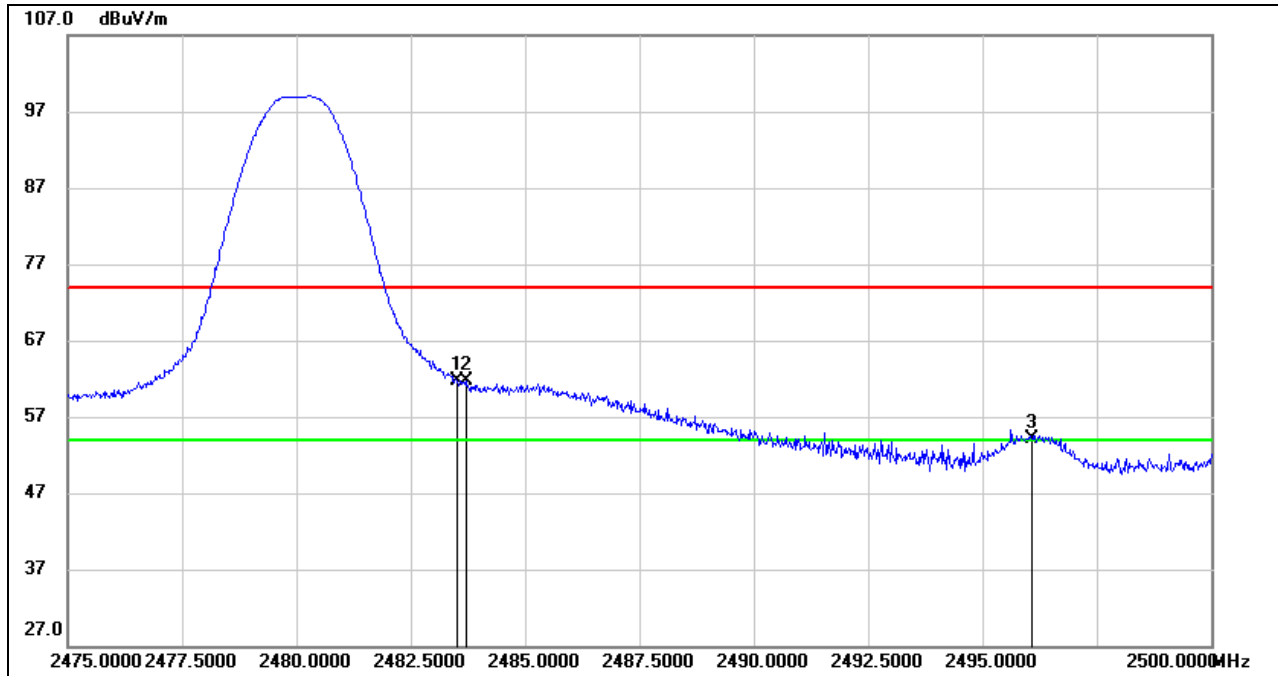

No.	Frequency (MHz)	Reading (dBuV)	Correct (dB/m)	Result (dBuV/m)	Limit (dBuV/m)	Margin (dB)	Remark
1	2483.500	28.17	33.58	61.75	74.00	-12.25	peak
2	2483.700	28.09	33.58	61.67	74.00	-12.33	peak
3	2496.075	20.48	33.67	54.15	74.00	-19.85	peak

- Note: 1. Measurement = Reading Level + Correct Factor.
 2. If Peak Result complies with AV limit, AV Result is deemed to comply with AV limit.
 3. Peak: Peak detector.
 4. Only the worst case emission will be recorder, if it complies with the limit, the other emissions deemed to comply with the limit.



AVG

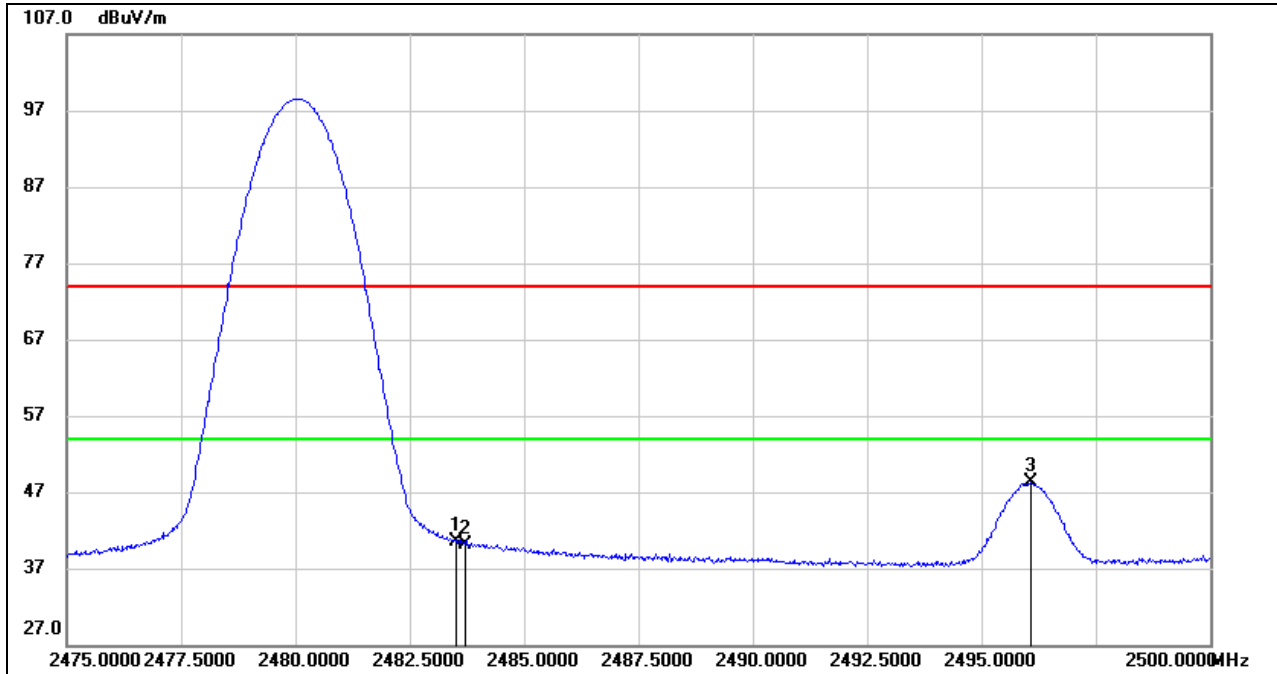

No.	Frequency (MHz)	Reading (dBuV)	Correct (dB/m)	Result (dBuV/m)	Limit (dBuV/m)	Margin (dB)	Remark
1	2483.500	6.90	33.58	40.48	54.00	-13.52	AVG
2	2483.700	6.48	33.58	40.06	54.00	-13.94	AVG
3	2496.075	14.59	33.67	48.26	54.00	-5.74	AVG

- Note: 1. Measurement = Reading Level + Correct Factor.
 2. If Peak Result complies with AV limit, AV Result is deemed to comply with AV limit.
 3. Peak: Peak detector.
 4. AVG: $VBW=1/Ton$, where: Ton is the transmitting duration.
 5. For the transmitting duration, please refer to clause 7.1.
 6. Only the worst emission was recorded, if it complies with the limit, the other emissions deemed to comply with the limit.



8.2. SPURIOUS EMISSIONS (1~3GHz)

HARMONICS AND SPURIOUS EMISSIONS (LOW CHANNEL, HORIZONTAL)

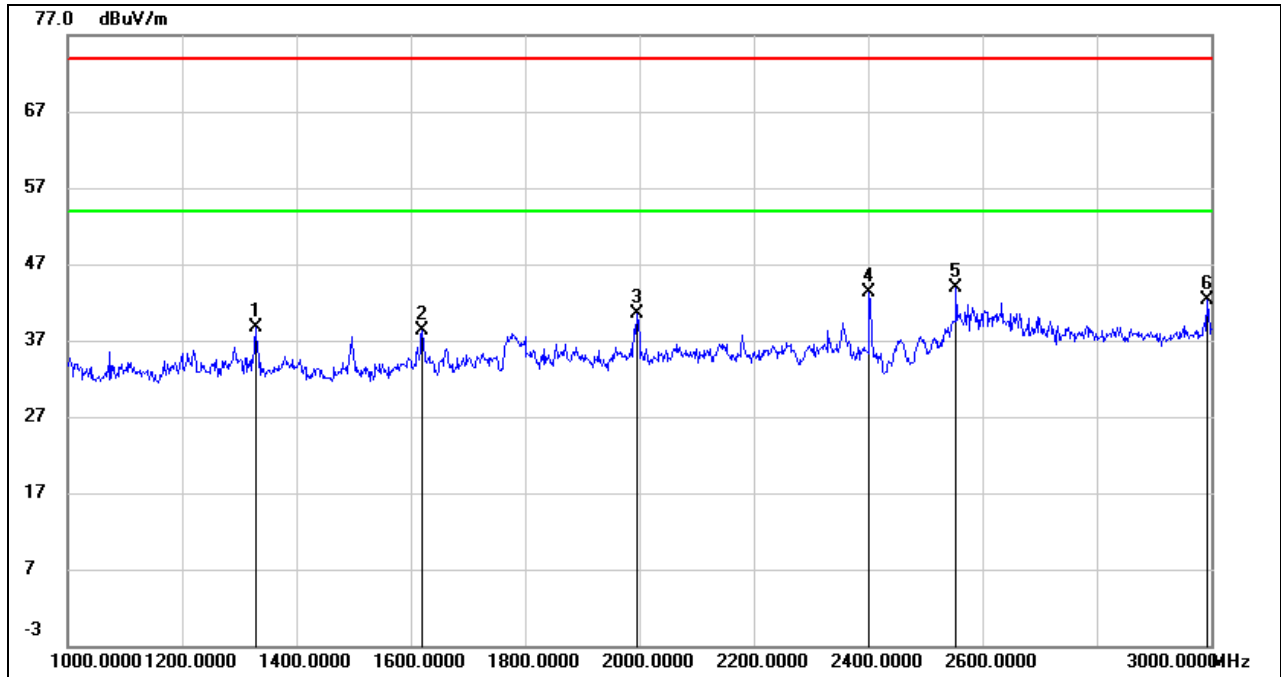

No.	Frequency (MHz)	Reading (dBuV)	Correct (dB/m)	Result (dBuV/m)	Limit (dBuV/m)	Margin (dB)	Remark
1	1328.000	51.27	-12.59	38.68	74.00	-35.32	peak
2	1620.000	49.72	-11.50	38.22	74.00	-35.78	peak
3	1996.000	50.57	-10.01	40.56	74.00	-33.44	peak
4	2402.000	51.18	-7.95	43.23	/	/	fundamental
5	2554.000	51.47	-7.53	43.94	74.00	-30.06	peak
6	2992.000	47.62	-5.30	42.32	74.00	-31.68	peak

- Note: 1. Peak Result = Reading Level + Correct Factor.
 2. If Peak Result complies with AV limit, AV Result is deemed to comply with AV limit.
 3. Peak: Peak detector.
 4. Filter losses were only considered in the spurious frequency bands and the authorized band was not corrected for Band Reject Filter losses.
 5. Proper operation of the transmitter prior to adding the filter to the measurement chain.



HARMONICS AND SPURIOUS EMISSIONS (LOW CHANNEL, VERTICAL)

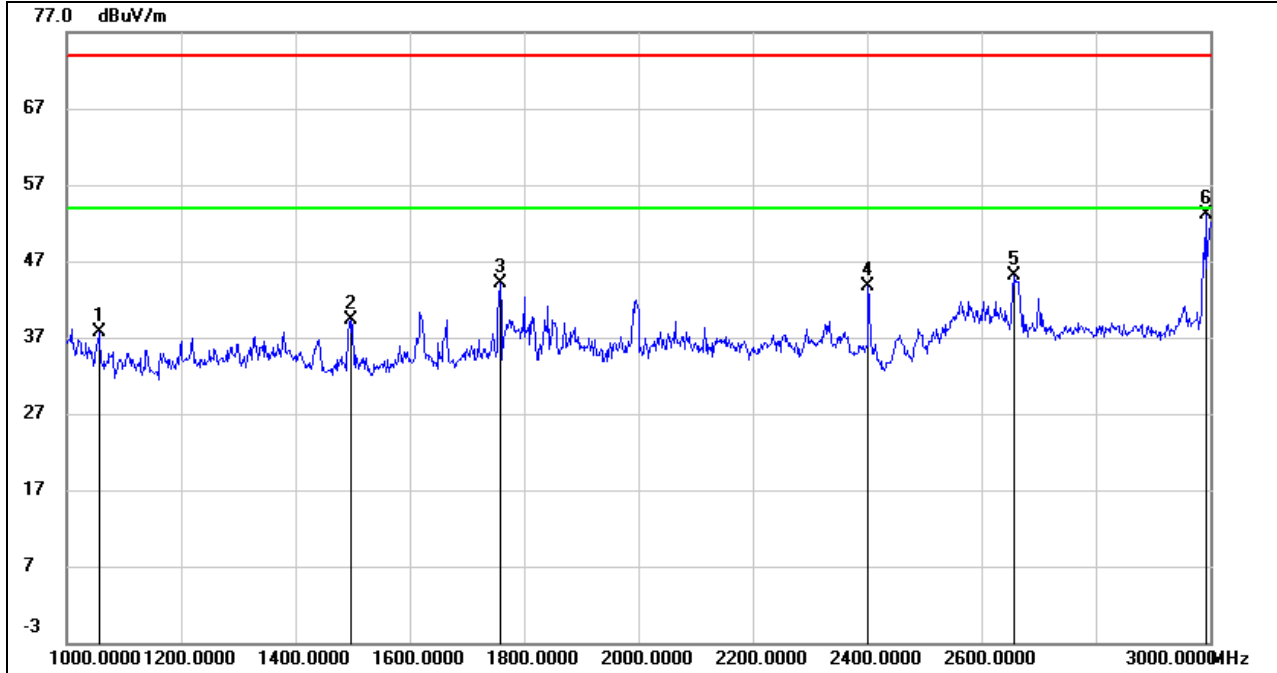

No.	Frequency (MHz)	Reading (dBuV)	Correct (dB/m)	Result (dBuV/m)	Limit (dBuV/m)	Margin (dB)	Remark
1	1056.000	51.59	-13.81	37.78	74.00	-36.22	peak
2	1498.000	51.67	-12.43	39.24	74.00	-34.76	peak
3	1758.000	54.58	-10.53	44.05	74.00	-29.95	peak
4	2402.000	51.61	-7.95	43.66	/	/	fundamental
5	2658.000	52.51	-7.42	45.09	74.00	-28.91	peak
6	2992.000	58.38	-5.30	53.08	74.00	-20.92	peak

- Note: 1. Peak Result = Reading Level + Correct Factor.
 2. If Peak Result complies with AV limit, AV Result is deemed to comply with AV limit.
 3. Peak: Peak detector.
 4. Filter losses were only considered in the spurious frequency bands and the authorized band was not corrected for Band Reject Filter losses.
 5. Proper operation of the transmitter prior to adding the filter to the measurement chain.



HARMONICS AND SPURIOUS EMISSIONS (MID CHANNEL, HORIZONTAL)

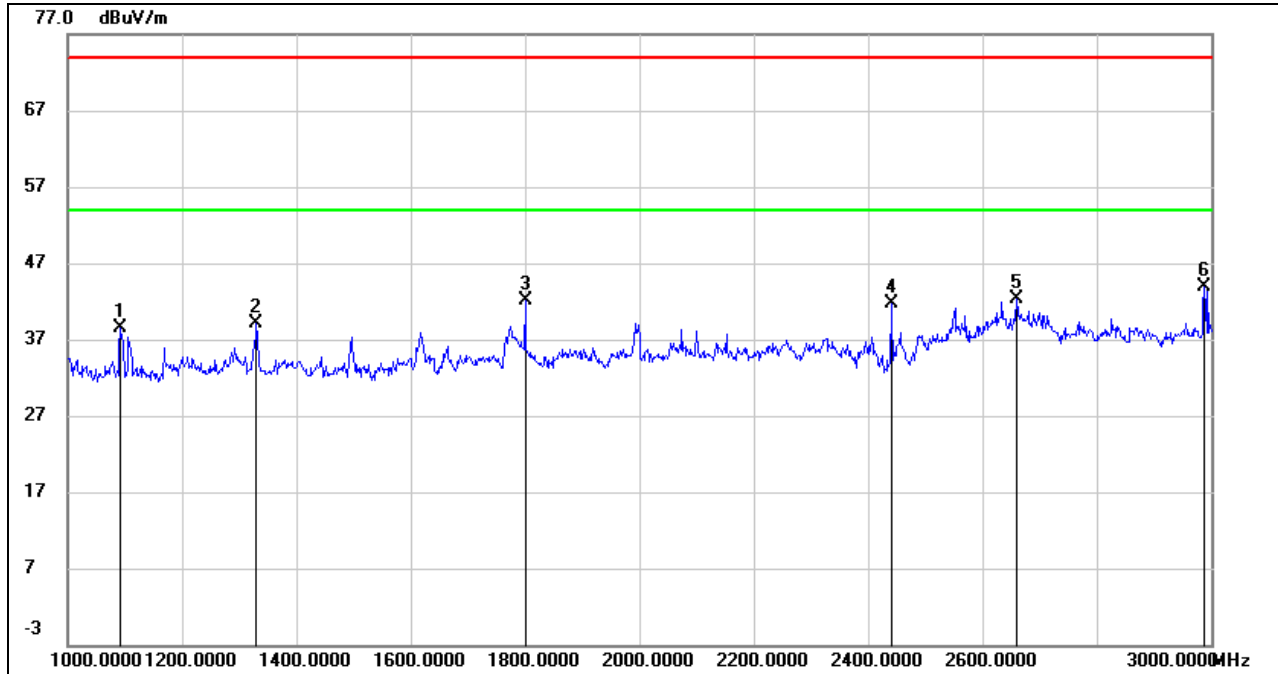

No.	Frequency (MHz)	Reading (dBuV)	Correct (dB/m)	Result (dBuV/m)	Limit (dBuV/m)	Margin (dB)	Remark
1	1092.000	52.26	-13.77	38.49	74.00	-35.51	peak
2	1330.000	51.79	-12.59	39.20	74.00	-34.80	peak
3	1800.000	52.23	-10.11	42.12	74.00	-31.88	peak
4	2440.000	49.45	-7.68	41.77	/	/	fundamental
5	2660.000	49.75	-7.40	42.35	74.00	-31.65	peak
6	2988.000	49.23	-5.31	43.92	74.00	-30.08	peak

- Note: 1. Peak Result = Reading Level + Correct Factor.
 2. If Peak Result complies with AV limit, AV Result is deemed to comply with AV limit.
 3. Peak: Peak detector.
 4. Filter losses were only considered in the spurious frequency bands and the authorized band was not corrected for Band Reject Filter losses.
 5. Proper operation of the transmitter prior to adding the filter to the measurement chain.



HARMONICS AND SPURIOUS EMISSIONS (MID CHANNEL, VERTICAL)

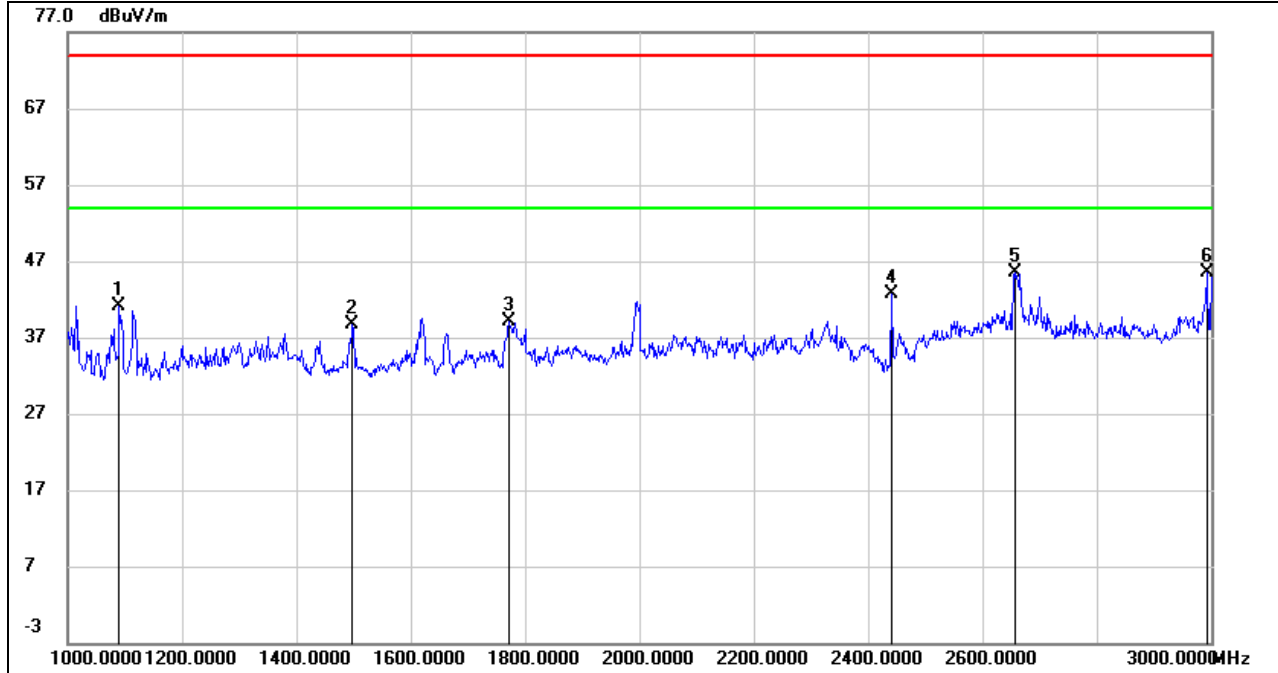

No.	Frequency (MHz)	Reading (dBuV)	Correct (dB/m)	Result (dBuV/m)	Limit (dBuV/m)	Margin (dB)	Remark
1	1090.000	54.83	-13.78	41.05	74.00	-32.95	peak
2	1498.000	51.19	-12.43	38.76	74.00	-35.24	peak
3	1772.000	49.45	-10.40	39.05	74.00	-34.95	peak
4	2440.000	50.46	-7.68	42.78	/	/	fundamental
5	2656.000	52.87	-7.43	45.44	74.00	-28.56	peak
6	2992.000	50.80	-5.30	45.50	74.00	-28.50	peak

- Note: 1. Peak Result = Reading Level + Correct Factor.
 2. If Peak Result complies with AV limit, AV Result is deemed to comply with AV limit.
 3. Peak: Peak detector.
 4. Filter losses were only considered in the spurious frequency bands and the authorized band was not corrected for Band Reject Filter losses.
 5. Proper operation of the transmitter prior to adding the filter to the measurement chain.



HARMONICS AND SPURIOUS EMISSIONS (HIGH CHANNEL, HORIZONTAL)

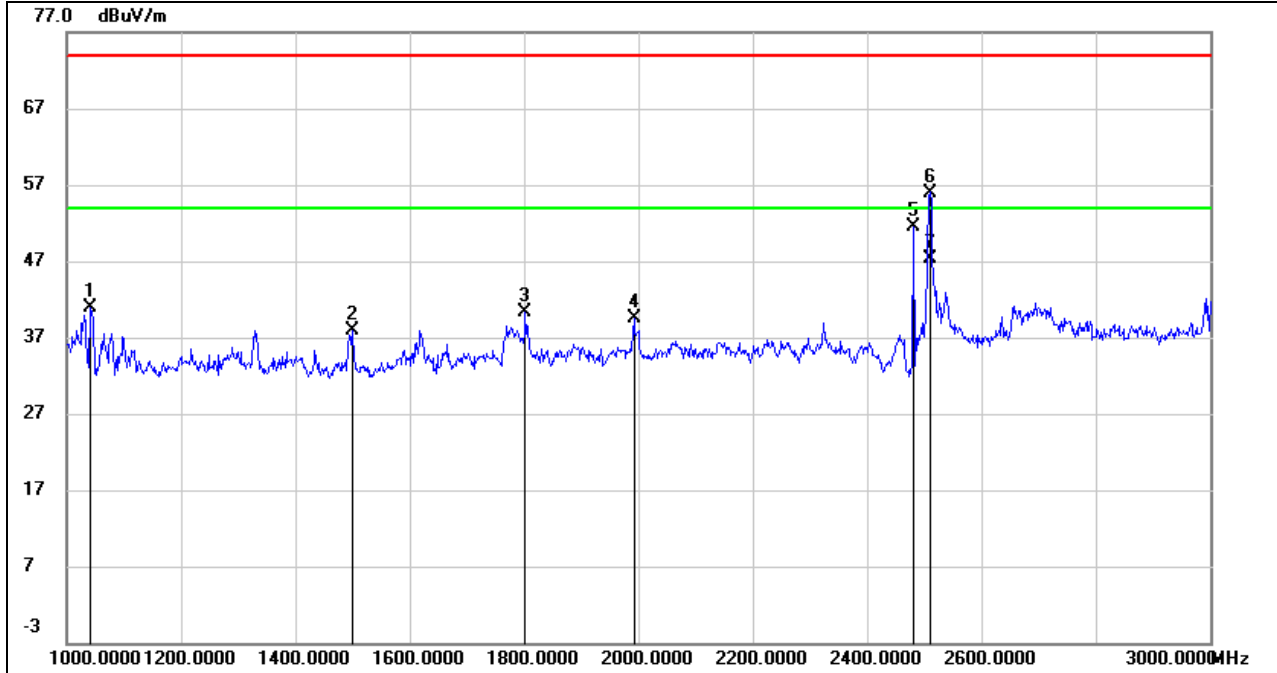

No.	Frequency (MHz)	Reading (dBuV)	Correct (dB/m)	Result (dBuV/m)	Limit (dBuV/m)	Margin (dB)	Remark
1	1040.000	54.70	-13.82	40.88	74.00	-33.12	peak
2	1500.000	50.34	-12.43	37.91	74.00	-36.09	peak
3	1802.000	50.49	-10.11	40.38	74.00	-33.62	peak
4	1992.000	49.52	-10.01	39.51	74.00	-34.49	peak
5	2480.000	58.86	-7.39	51.47	/	/	fundamental
6	2509.300	63.30	-7.30	56.00	74.00	-18.00	peak
7	2509.300	54.60	-7.30	47.30	54.00	-6.70	AVG

- Note: 1. Measurement = Reading Level + Correct Factor.
 2. If Peak Result complies with AV limit, AV Result is deemed to comply with AV limit.
 3. Peak: Peak detector.
 4. AVG: $VBW=1/Ton$ where: ton is transmit duration.
 5. For transmit duration, please refer to clause 7.1.
 6. Filter losses were only considered in the spurious frequency bands and the authorized band was not corrected for Band reject filter losses.
 7. Proper operation of the transmitter prior to adding the filter to the measurement chain.



HARMONICS AND SPURIOUS EMISSIONS (HIGH CHANNEL, VERTICAL)

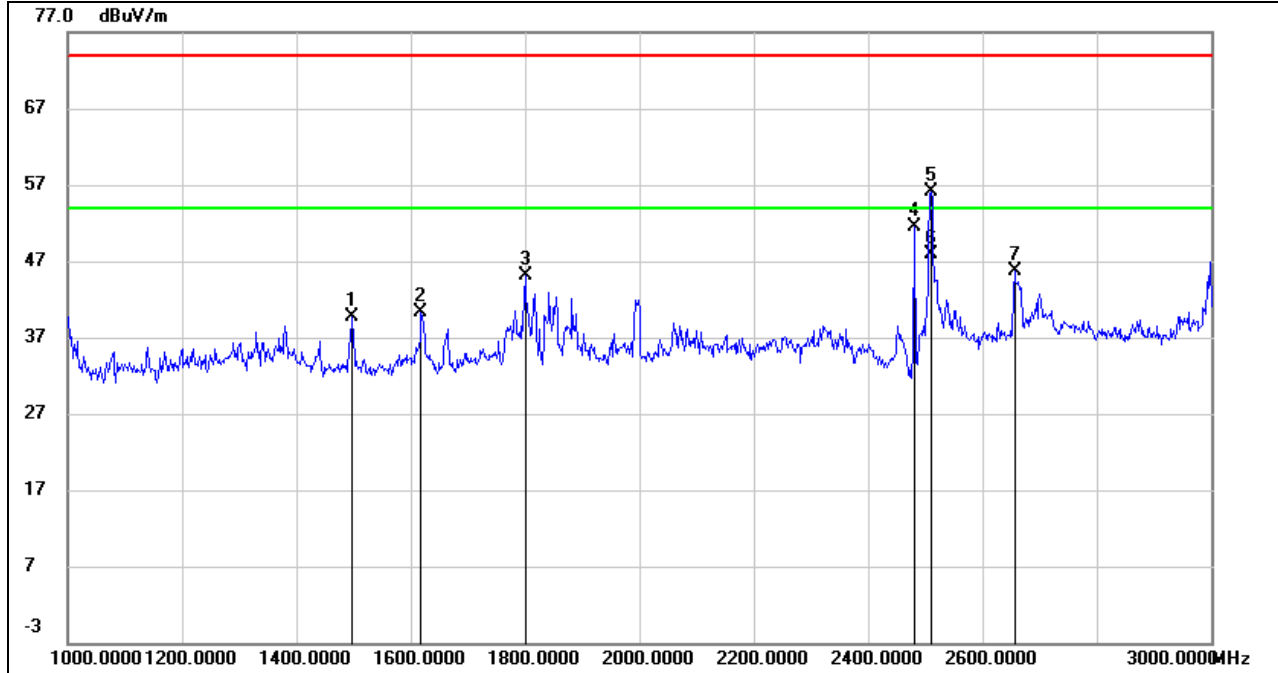

No.	Frequency (MHz)	Reading (dBuV)	Correct (dB/m)	Result (dBuV/m)	Limit (dBuV/m)	Margin (dB)	Remark
1	1496.000	52.17	-12.44	39.73	74.00	-34.27	peak
2	1618.000	51.85	-11.52	40.33	74.00	-33.67	peak
3	1800.000	55.14	-10.11	45.03	74.00	-28.97	peak
4	2480.000	58.80	-7.39	51.41	/	/	fundamental
5	2509.481	63.35	-7.30	56.05	74.00	-17.95	peak
6	2509.481	55.22	-7.30	47.92	54.00	-6.08	AVG
7	2656.000	53.09	-7.43	45.66	74.00	-28.34	peak

- Note: 1. Measurement = Reading Level + Correct Factor.
 2. If Peak Result complies with AV limit, AV Result is deemed to comply with AV limit.
 3. Peak: Peak detector.
 4. AVG: $VBW=1/Ton$ where: ton is transmit duration.
 5. For transmit duration, please refer to clause 7.1.
 6. Filter losses were only considered in the spurious frequency bands and the authorized band was not corrected for Band reject filter losses.
 7. Proper operation of the transmitter prior to adding the filter to the measurement chain.



8.3.SPURIOUS EMISSIONS (3~18GHz)

HARMONICS AND SPURIOUS EMISSIONS (LOW CHANNEL, HORIZONTAL)

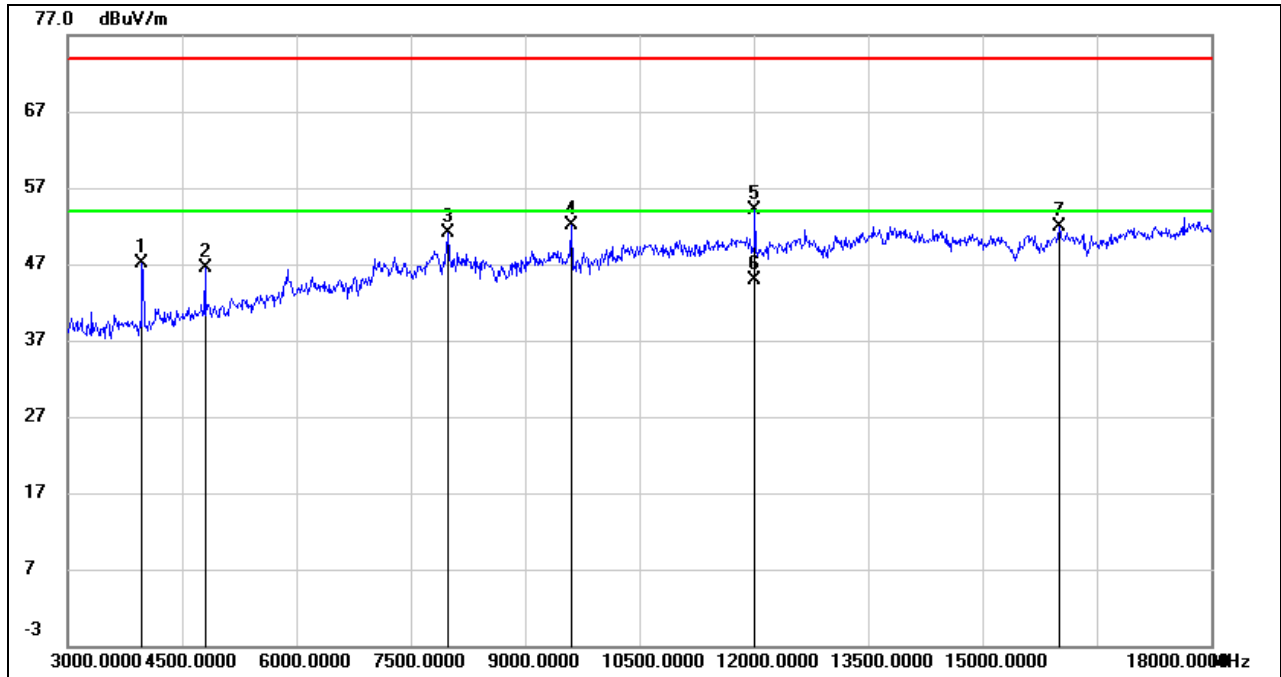

No.	Frequency (MHz)	Reading (dBuV)	Correct (dB/m)	Result (dBuV/m)	Limit (dBuV/m)	Margin (dB)	Remark
1	3975.000	50.00	-2.81	47.19	74.00	-26.81	peak
2	4800.000	46.67	-0.14	46.53	74.00	-27.47	peak
3	7995.000	42.59	8.45	51.04	74.00	-22.96	peak
4	9615.000	41.53	10.64	52.17	74.00	-21.83	peak
5	12009.342	39.52	14.59	54.11	74.00	-19.89	peak
6	12009.342	30.24	14.59	44.83	54.00	-9.17	AVG
7	16005.000	34.32	17.63	51.95	74.00	-22.05	peak

- Note: 1. Measurement = Reading Level + Correct Factor.
 2. If Peak Result complies with AV limit, AV Result is deemed to comply with AV limit.
 3. Peak: Peak detector.
 4. AVG: $VBW=1/T_{on}$ where: t_{on} is transmit duration.
 5. For transmit duration, please refer to clause 7.1.
 6. Filter losses were only considered in the spurious frequency bands and the authorized band was not corrected for High Pass Filter losses
 7. Proper operation of the transmitter prior to adding the filter to the measurement chain.



HARMONICS AND SPURIOUS EMISSIONS (LOW CHANNEL, VERTICAL)

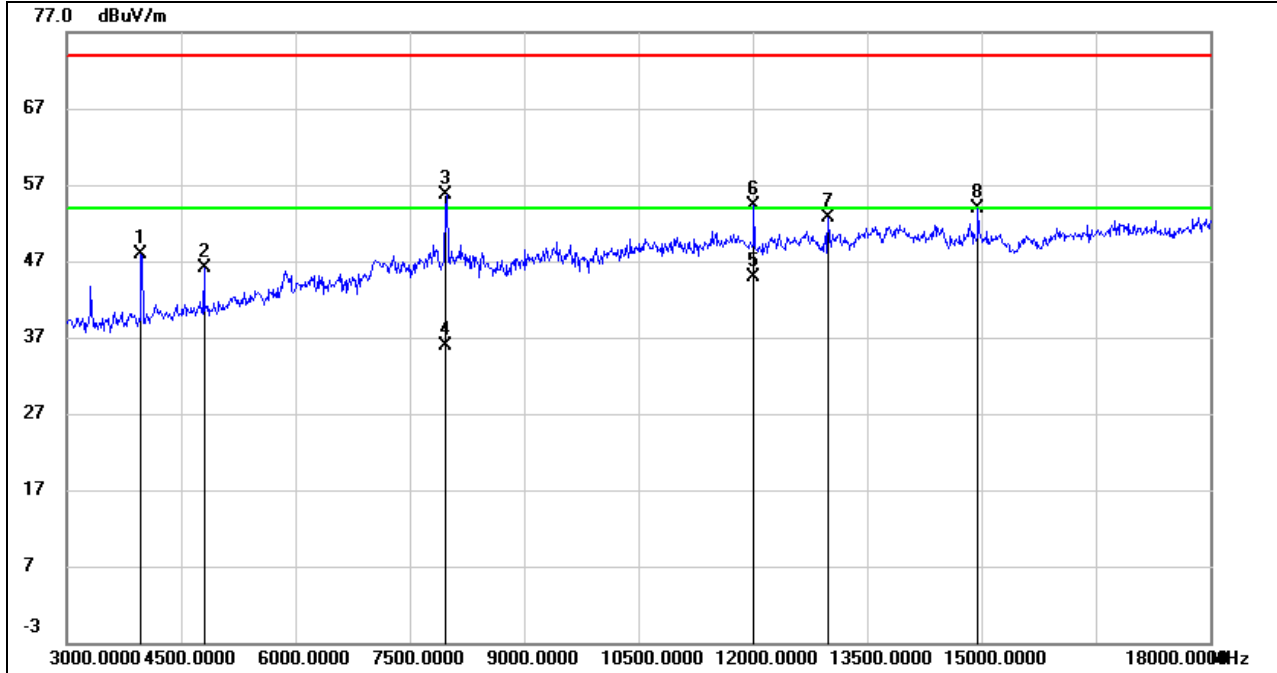

No.	Frequency (MHz)	Reading (dBuV)	Correct (dB/m)	Result (dBuV/m)	Limit (dBuV/m)	Margin (dB)	Remark
1	3975.000	50.70	-2.81	47.89	74.00	-26.11	peak
2	4800.000	46.20	-0.14	46.06	74.00	-27.94	peak
3	7962.871	47.07	8.55	55.62	74.00	-18.38	peak
4	7962.871	27.26	8.55	35.81	54.00	-18.19	AVG
5	12009.086	30.27	14.60	44.87	54.00	-9.13	AVG
6	12015.000	39.66	14.61	54.27	74.00	-19.73	peak
7	12990.000	37.69	14.98	52.67	74.00	-21.33	peak
8	14955.000	37.90	15.94	53.84	74.00	-20.16	peak

- Note: 1. Measurement = Reading Level + Correct Factor.
 2. If Peak Result complies with AV limit, AV Result is deemed to comply with AV limit.
 3. Peak: Peak detector.
 4. AVG: $VBW=1/Ton$ where: ton is transmit duration.
 5. For transmit duration, please refer to clause 7.1.
 6. Filter losses were only considered in the spurious frequency bands and the authorized band was not corrected for High Pass Filter losses
 7. Proper operation of the transmitter prior to adding the filter to the measurement chain.



HARMONICS AND SPURIOUS EMISSIONS (MID CHANNEL, HORIZONTAL)

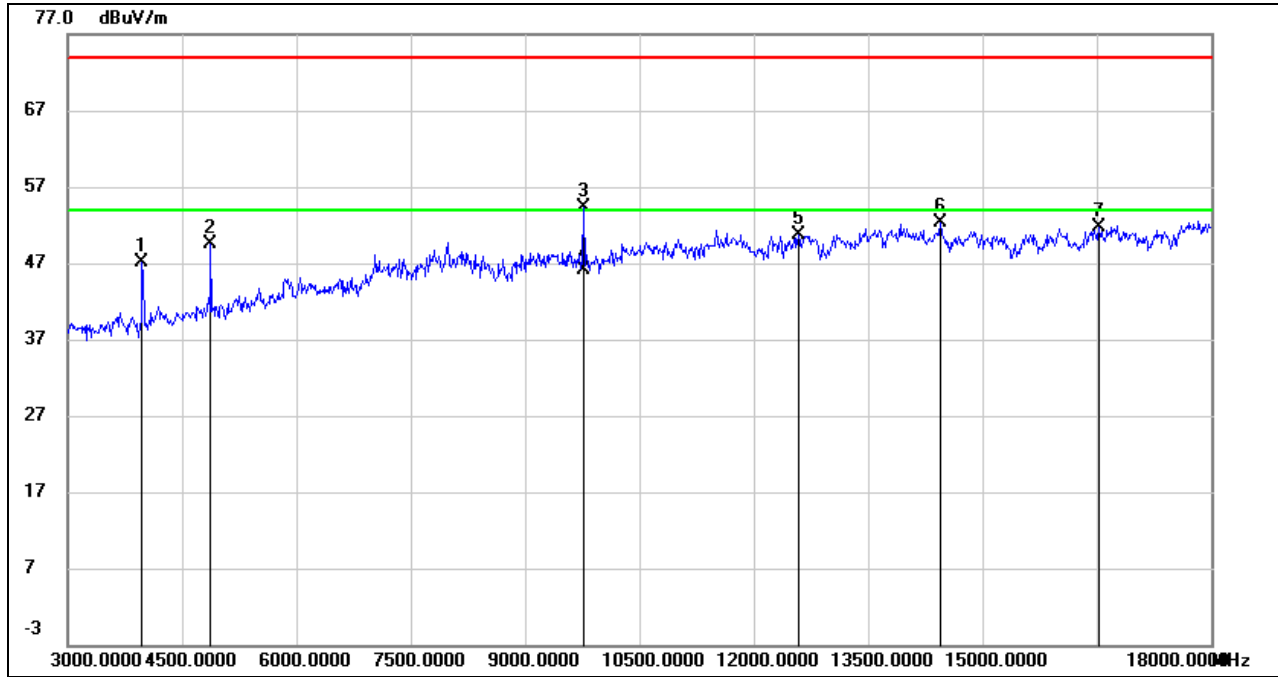

No.	Frequency (MHz)	Reading (dBuV)	Correct (dB/m)	Result (dBuV/m)	Limit (dBuV/m)	Margin (dB)	Remark
1	3975.000	49.97	-2.81	47.16	74.00	-26.84	peak
2	4875.000	49.38	0.10	49.48	74.00	-24.52	peak
3	9759.386	43.65	10.61	54.26	74.00	-19.74	peak
4	9759.386	35.56	10.61	46.17	54.00	-7.83	AVG
5	12585.000	36.22	14.57	50.79	74.00	-23.21	peak
6	14445.000	35.57	16.66	52.23	74.00	-21.77	peak
7	16530.000	32.22	19.46	51.68	74.00	-22.32	peak

- Note: 1. Measurement = Reading Level + Correct Factor.
 2. If Peak Result complies with AV limit, AV Result is deemed to comply with AV limit.
 3. Peak: Peak detector.
 4. AVG: VBW=1/Ton where: ton is transmit duration.
 5. For transmit duration, please refer to clause 7.1.
 6. Filter losses were only considered in the spurious frequency bands and the authorized band was not corrected for High Pass Filter losses
 7. Proper operation of the transmitter prior to adding the filter to the measurement chain.



HARMONICS AND SPURIOUS EMISSIONS (MID CHANNEL, VERTICAL)

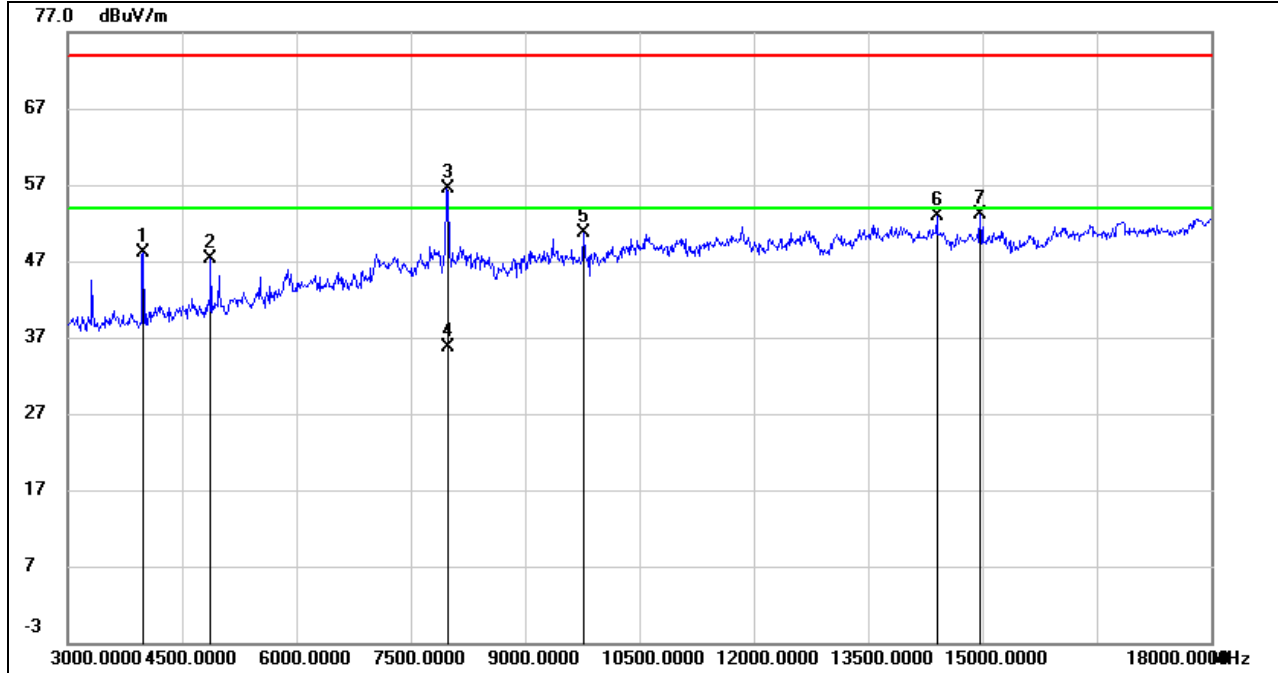

No.	Frequency (MHz)	Reading (dBuV)	Correct (dB/m)	Result (dBuV/m)	Limit (dBuV/m)	Margin (dB)	Remark
1	3990.000	50.81	-2.80	48.01	74.00	-25.99	peak
2	4875.000	47.15	0.10	47.25	74.00	-26.75	peak
3	8000.202	48.12	8.43	56.55	74.00	-17.45	peak
4	8000.202	27.35	8.43	35.78	54.00	-18.22	AVG
5	9765.000	40.17	10.60	50.77	74.00	-23.23	peak
6	14400.000	36.27	16.68	52.95	74.00	-21.05	peak
7	14970.000	37.16	15.92	53.08	74.00	-20.92	peak

- Note: 1. Peak Result = Reading Level + Correct Factor.
 2. If Peak Result complies with AV limit, AV Result is deemed to comply with AV limit.
 3. Peak: Peak detector.
 4. Filter losses were only considered in the spurious frequency bands and the authorized band was not corrected for High Pass Filter losses.
 5. Proper operation of the transmitter prior to adding the filter to the measurement chain.



HARMONICS AND SPURIOUS EMISSIONS (HIGH CHANNEL, HORIZONTAL)

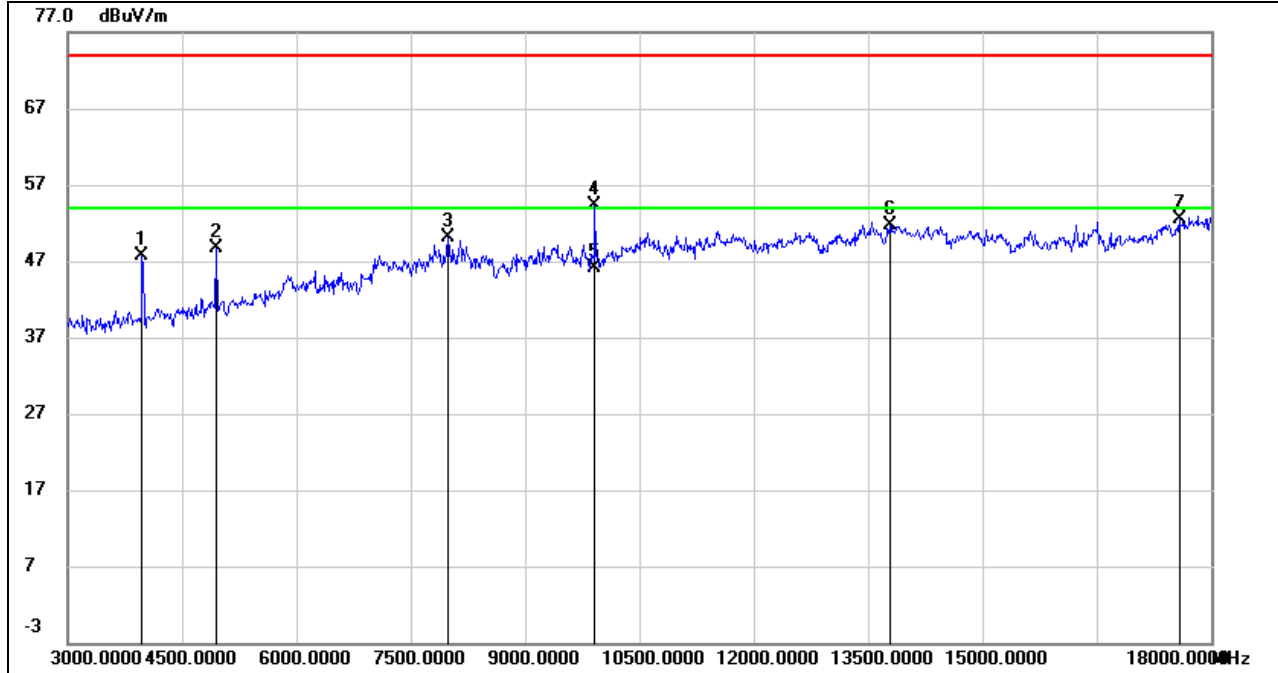

No.	Frequency (MHz)	Reading (dBuV)	Correct (dB/m)	Result (dBuV/m)	Limit (dBuV/m)	Margin (dB)	Remark
1	3975.000	50.57	-2.81	47.76	74.00	-26.24	peak
2	4950.000	48.36	0.40	48.76	74.00	-25.24	peak
3	7980.000	41.64	8.49	50.13	74.00	-23.87	peak
4	9919.495	43.30	10.94	54.24	74.00	-19.76	peak
5	9919.495	35.22	10.94	46.16	54.00	-7.84	AVG
6	13785.000	34.33	17.40	51.73	74.00	-22.27	peak
7	17580.000	30.64	21.87	52.51	74.00	-21.49	peak

- Note: 1. Measurement = Reading Level + Correct Factor.
 2. If Peak Result complies with AV limit, AV Result is deemed to comply with AV limit.
 3. Peak: Peak detector.
 4. AVG: $VBW=1/Ton$ where: ton is transmit duration.
 5. For transmit duration, please refer to clause 7.1.
 6. Filter losses were only considered in the spurious frequency bands and the authorized band was not corrected for High Pass Filter losses
 7. Proper operation of the transmitter prior to adding the filter to the measurement chain.



HARMONICS AND SPURIOUS EMISSIONS (HIGH CHANNEL, VERTICAL)

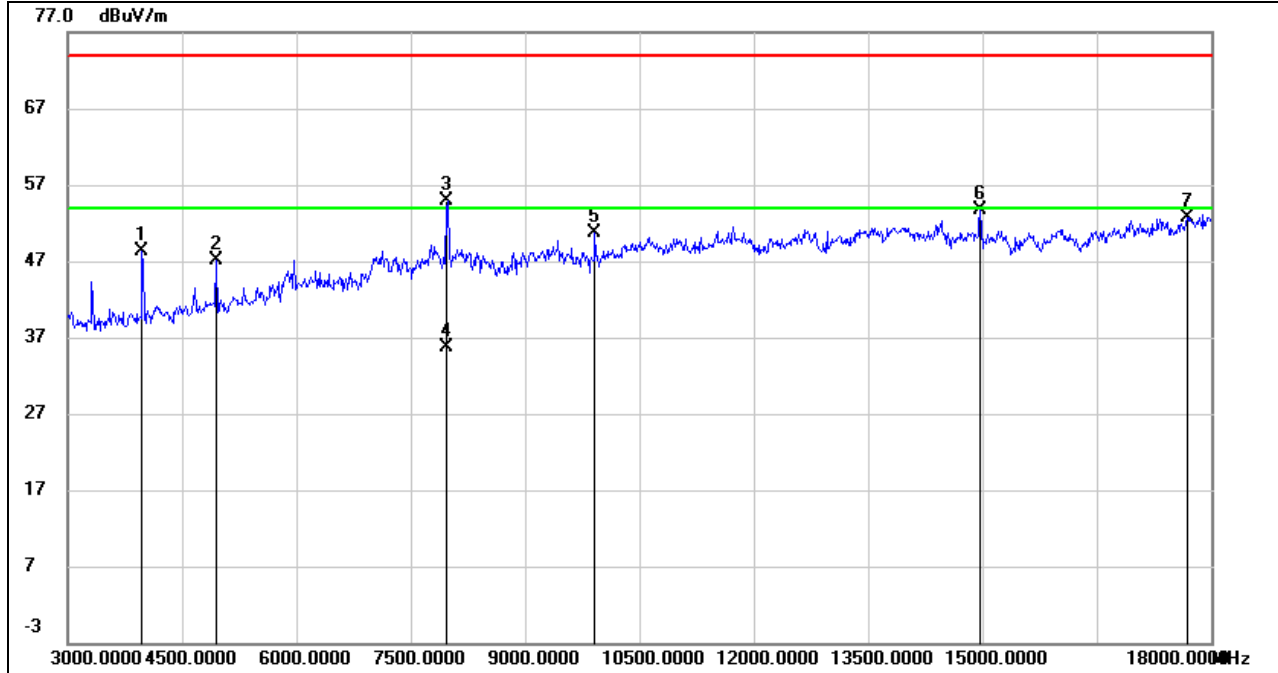

No.	Frequency (MHz)	Reading (dBuV)	Correct (dB/m)	Result (dBuV/m)	Limit (dBuV/m)	Margin (dB)	Remark
1	3975.000	51.08	-2.81	48.27	74.00	-25.73	peak
2	4950.000	46.73	0.40	47.13	74.00	-26.87	peak
3	7962.821	46.38	8.55	54.93	74.00	-19.07	peak
4	7962.821	27.08	8.55	35.63	54.00	-18.37	AVG
5	9915.000	39.84	10.95	50.79	74.00	-23.21	peak
6	14970.000	37.83	15.92	53.75	74.00	-20.25	peak
7	17685.000	30.26	22.43	52.69	74.00	-21.31	peak

- Note: 1. Measurement = Reading Level + Correct Factor.
 2. If Peak Result complies with AV limit, AV Result is deemed to comply with AV limit.
 3. Peak: Peak detector.
 4. AVG: VBW=1/Ton where: ton is transmit duration.
 5. For transmit duration, please refer to clause 7.1.
 6. Filter losses were only considered in the spurious frequency bands and the authorized band was not corrected for High Pass Filter losses
 7. Proper operation of the transmitter prior to adding the filter to the measurement chain.



8.4. SPURIOUS EMISSIONS 18G ~ 26GHz

SPURIOUS EMISSIONS (LOW CHANNEL, WORST-CASE CONFIGURATION, HORIZONTAL)

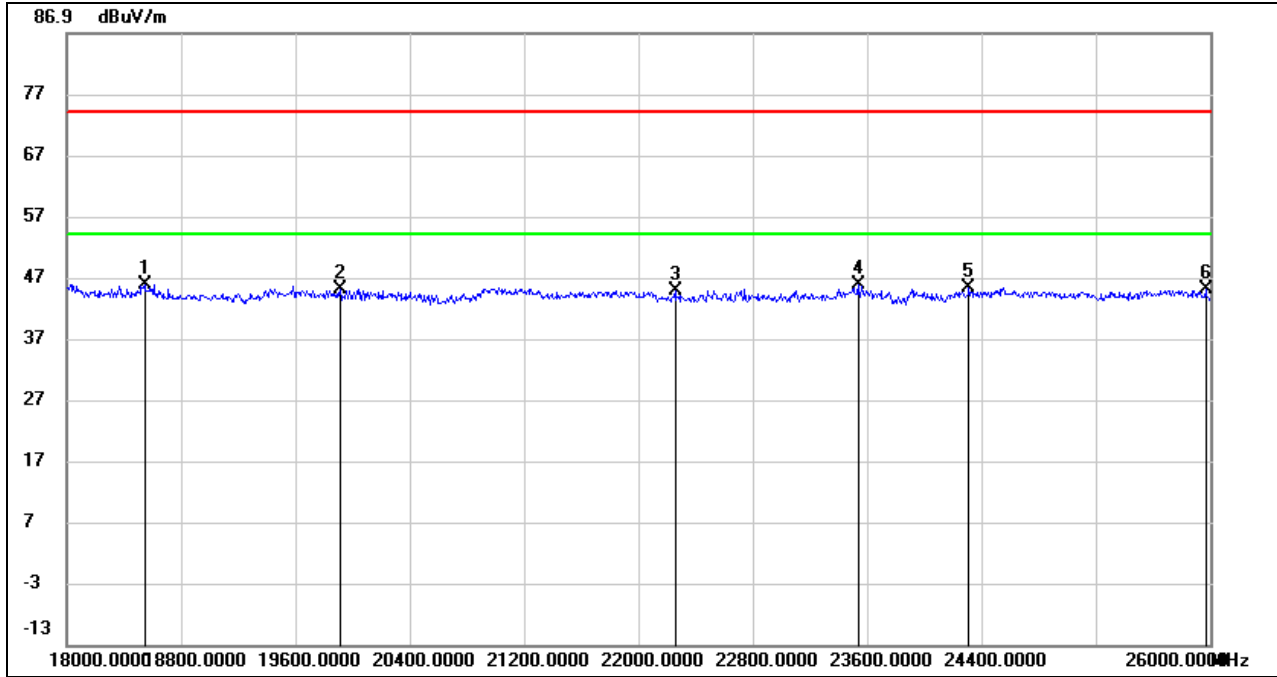

No.	Frequency (MHz)	Reading (dBuV)	Correct (dB/m)	Result (dBuV/m)	Limit (dBuV/m)	Margin (dB)	Remark
1	18544.000	50.26	-4.46	45.80	74.00	-28.20	peak
2	19912.000	49.41	-4.36	45.05	74.00	-28.95	peak
3	22256.000	50.95	-6.06	44.89	74.00	-29.11	peak
4	23536.000	50.46	-4.74	45.72	74.00	-28.28	peak
5	24312.000	48.60	-3.35	45.25	74.00	-28.75	peak
6	25968.000	47.41	-2.31	45.10	74.00	-28.90	peak

Note: 1. Peak Result = Reading Level + Correct Factor.

2. If Peak Result complies with AV limit, AV Result is deemed to comply with AV limit.

3. Peak: Peak detector.



SPURIOUS EMISSIONS (LOW CHANNEL, WORST-CASE CONFIGURATION, VERTICAL)

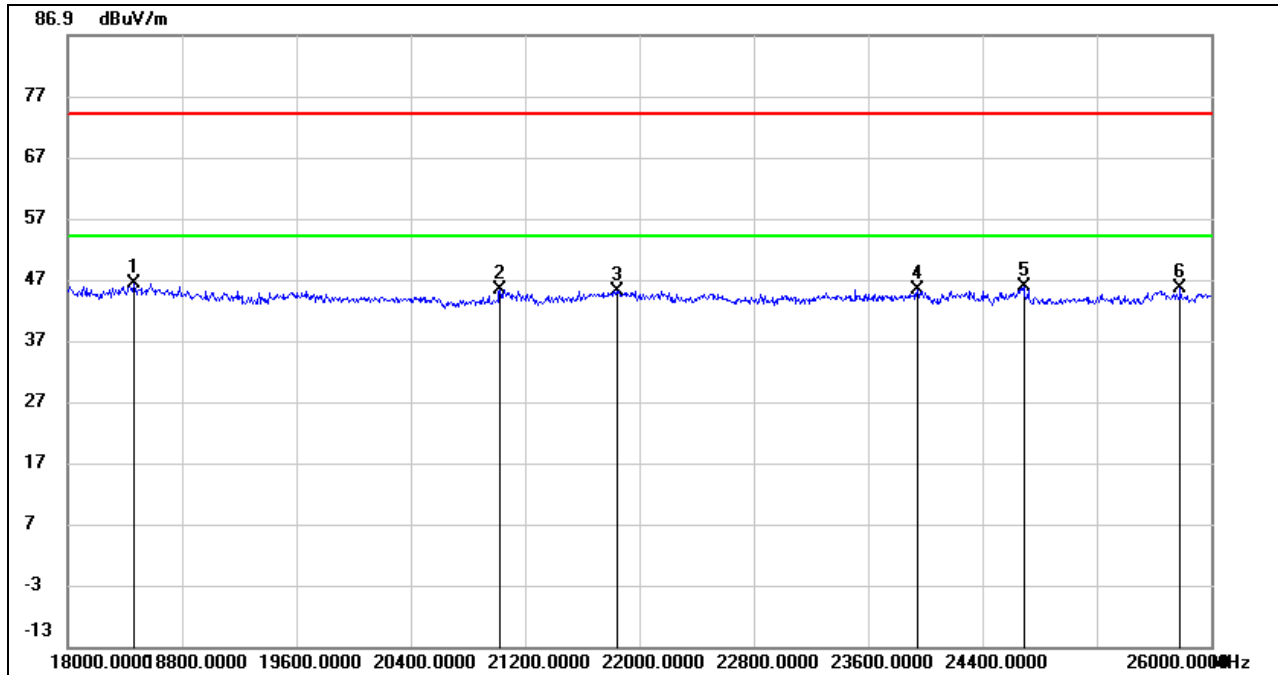

No.	Frequency (MHz)	Reading (dBuV)	Correct (dB/m)	Result (dBuV/m)	Limit (dBuV/m)	Margin (dB)	Remark
1	18464.000	50.70	-4.39	46.31	74.00	-27.69	peak
2	21024.000	50.64	-5.30	45.34	74.00	-28.66	peak
3	21840.000	51.08	-5.93	45.15	74.00	-28.85	peak
4	23944.000	49.45	-4.14	45.31	74.00	-28.69	peak
5	24688.000	47.89	-2.11	45.78	74.00	-28.22	peak
6	25784.000	47.08	-1.49	45.59	74.00	-28.41	peak

- Note: 1. Peak Result = Reading Level + Correct Factor.
 2. If Peak Result complies with AV limit, AV Result is deemed to comply with AV limit.
 3. Peak: Peak detector.

Note: All the test modes have been tested, only the worst data record in the report.



8.5. SPURIOUS EMISSIONS 30M ~ 1 GHz

SPURIOUS EMISSIONS (LOW CHANNEL, WORST-CASE CONFIGURATION, HORIZONTAL)

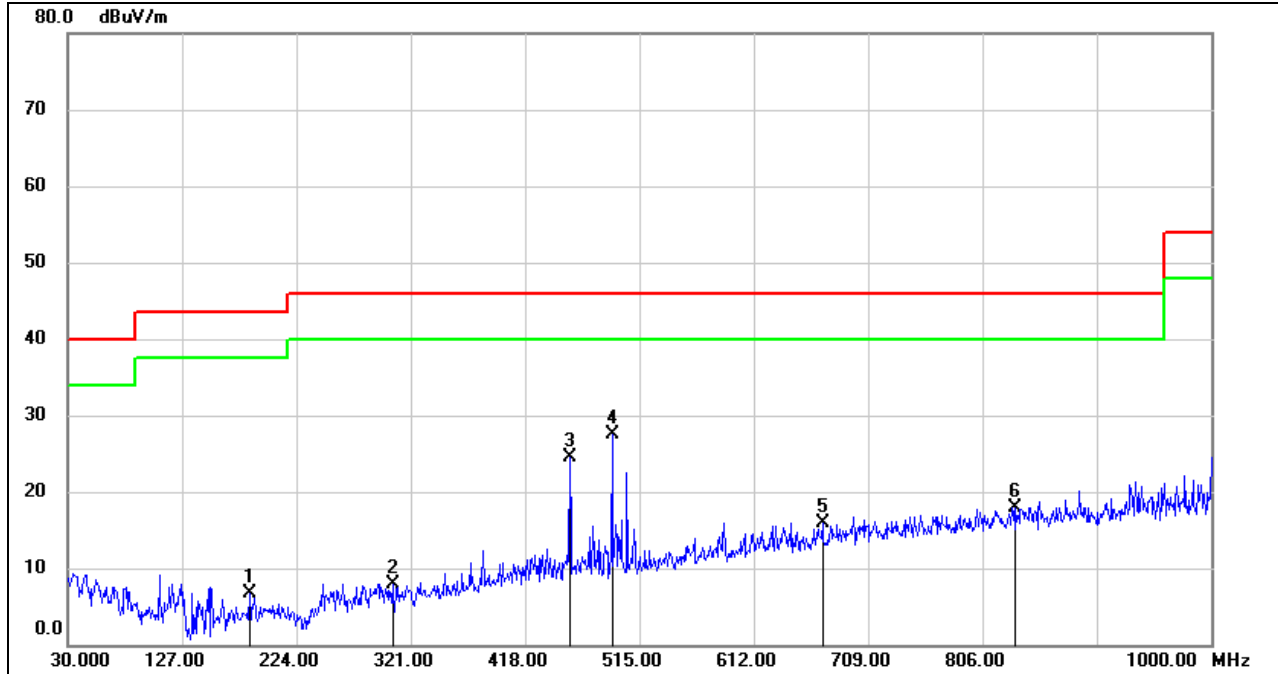

No.	Frequency (MHz)	Reading (dBuV)	Correct (dB/m)	Result (dBuV/m)	Limit (dBuV/m)	Margin (dB)	Remark
1	184.2300	23.55	-16.80	6.75	43.50	-36.75	QP
2	305.4800	22.00	-14.16	7.84	46.00	-38.16	QP
3	455.8300	36.32	-11.83	24.49	46.00	-21.51	QP
4	491.7200	38.47	-11.06	27.41	46.00	-18.59	QP
5	670.2000	23.42	-7.61	15.81	46.00	-30.19	QP
6	834.1300	22.94	-5.01	17.93	46.00	-28.07	QP

- Note: 1. Result Level = Read Level + Correct Factor.
 2. If Peak Result complies with QP limit, QP Result is deemed to comply with QP limit.
 3. Test setup: RBW: 120 kHz, VBW: 300 kHz, Sweep time: auto.



SPURIOUS EMISSIONS (LOW CHANNEL, WORST-CASE CONFIGURATION, VERTICAL)

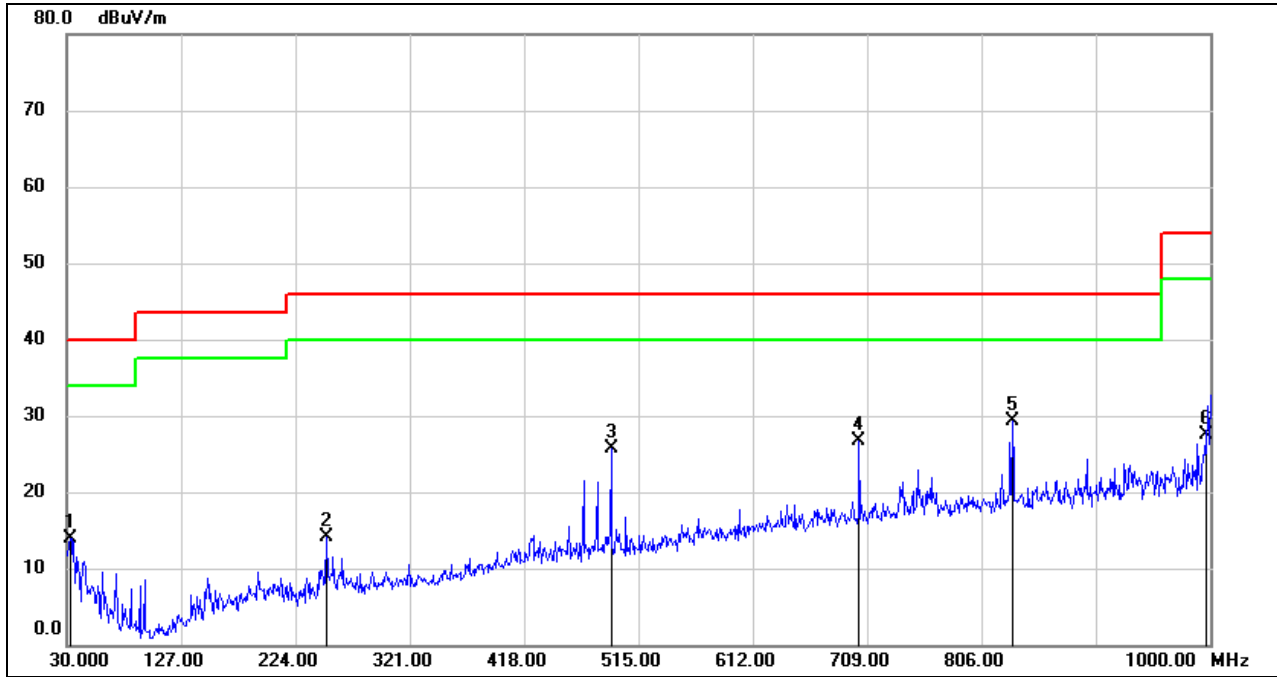

No.	Frequency (MHz)	Reading (dBuV)	Correct (dB/m)	Result (dBuV/m)	Limit (dBuV/m)	Margin (dB)	Remark
1	32.9100	31.26	-17.33	13.93	40.00	-26.07	QP
2	250.1900	30.49	-16.34	14.15	46.00	-31.85	QP
3	491.7200	36.70	-11.06	25.64	46.00	-20.36	QP
4	702.2100	33.66	-6.89	26.77	46.00	-19.23	QP
5	832.1900	34.35	-5.07	29.28	46.00	-16.72	QP
6	996.1200	30.51	-2.93	27.58	54.00	-26.42	QP

- Note: 1. Result Level = Read Level + Correct Factor.
 2. If Peak Result complies with QP limit, QP Result is deemed to comply with QP limit.
 3. Test setup: RBW: 120 kHz, VBW: 300 kHz, Sweep time: auto.

Note: All the test modes has been tested, only the worst data record in the report



8.6. SPURIOUS EMISSIONS BELOW 30M

SPURIOUS EMISSIONS (LOW CHANNEL, LOOP ANTENNA FACE ON TO THE EUT, WORST-CASE CONFIGURATION)

0.09kHz~ 150kHz

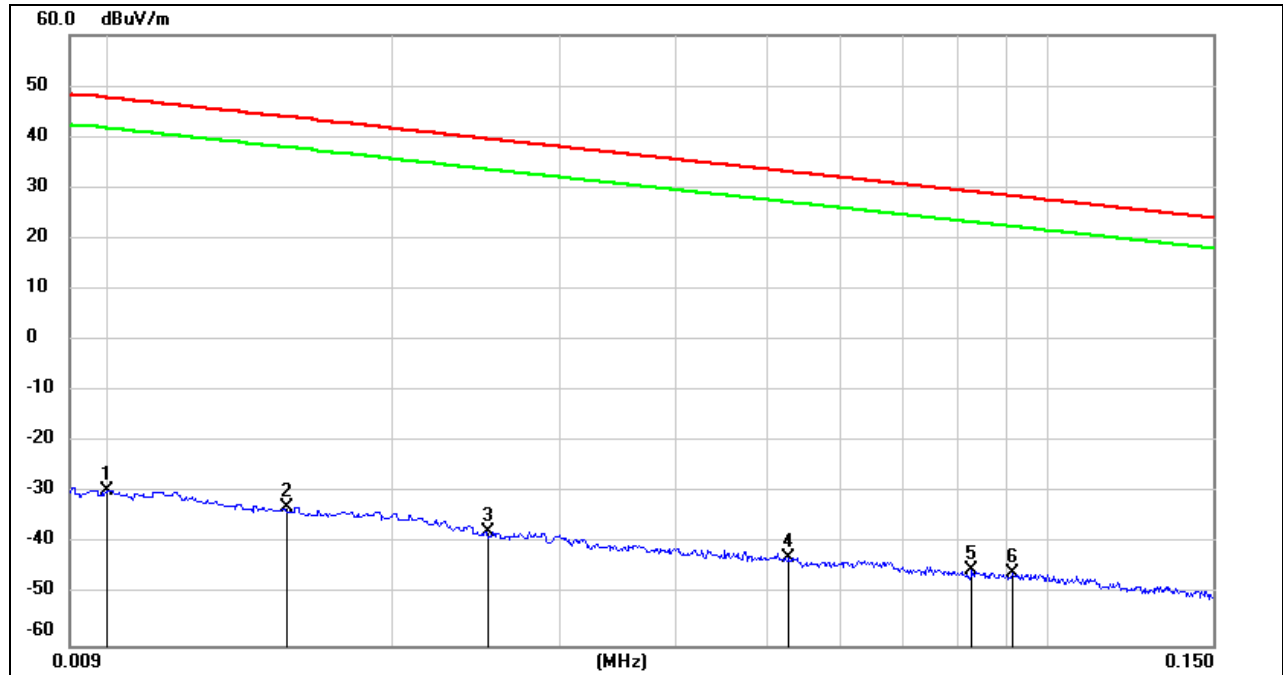

No.	Frequency (MHz)	Reading (dBuV)	Correct (dB/m)	Result (dBuV/m)	Limit (dBuV/m)	Margin (dB)	Remark
1	0.0100	71.72	-101.40	-29.68	47.60	-77.28	peak
2	0.0154	68.44	-101.37	-32.93	43.85	-76.78	peak
3	0.0252	63.82	-101.37	-37.55	39.57	-77.12	peak
4	0.0529	58.80	-101.49	-42.69	33.13	-75.82	peak
5	0.0830	56.38	-101.65	-45.27	29.22	-74.49	peak
6	0.0913	55.84	-101.73	-45.89	28.39	-74.28	peak

Note: 1. Measurement = Reading Level + Correct Factor.

2. If Peak Result complies with AV and QP limit, AV and QP Result are deemed to comply with AV limit.

3. All 3 polarizations(Horizontal, Face-on and Face-off) of the loop antenna had been tested, but only the worst data recorded in the report.



150kHz ~ 490kHz

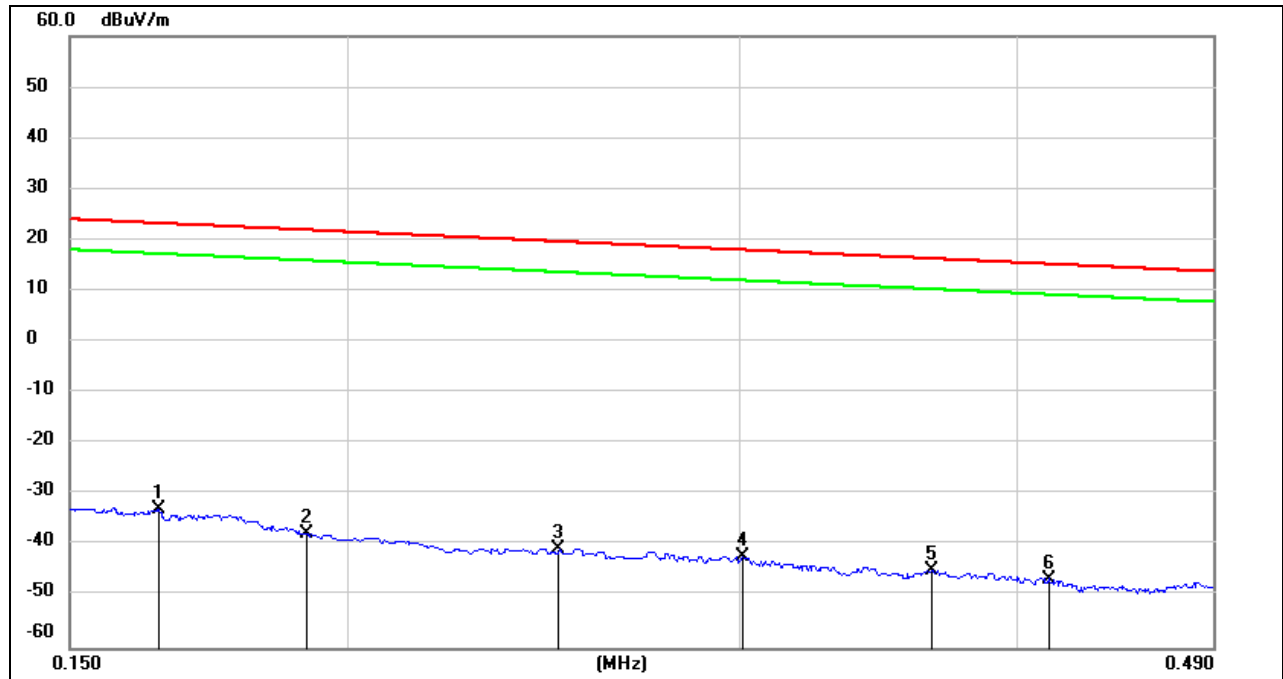

No.	Frequency (MHz)	Reading (dBuV)	Correct (dB/m)	Result (dBuV/m)	Limit (dBuV/m)	Margin (dB)	Remark
1	0.1645	68.75	-101.66	-32.91	23.28	-56.19	peak
2	0.1917	64.04	-101.70	-37.66	21.95	-59.61	peak
3	0.2489	61.19	-101.80	-40.61	19.68	-60.29	peak
4	0.3013	59.83	-101.85	-42.02	18.02	-60.04	peak
5	0.3662	57.08	-101.93	-44.85	16.33	-61.18	peak
6	0.4138	55.33	-101.98	-46.65	15.27	-61.92	peak

Note: 1. Measurement = Reading Level + Correct Factor.

2. If Peak Result complies with AV and QP limit, AV and QP Result are deemed to comply with AV limit.

3. All 3 polarizations(Horizontal, Face-on and Face-off) of the loop antenna had been tested, but only the worst data recorded in the report.



490kHz ~ 30MHz

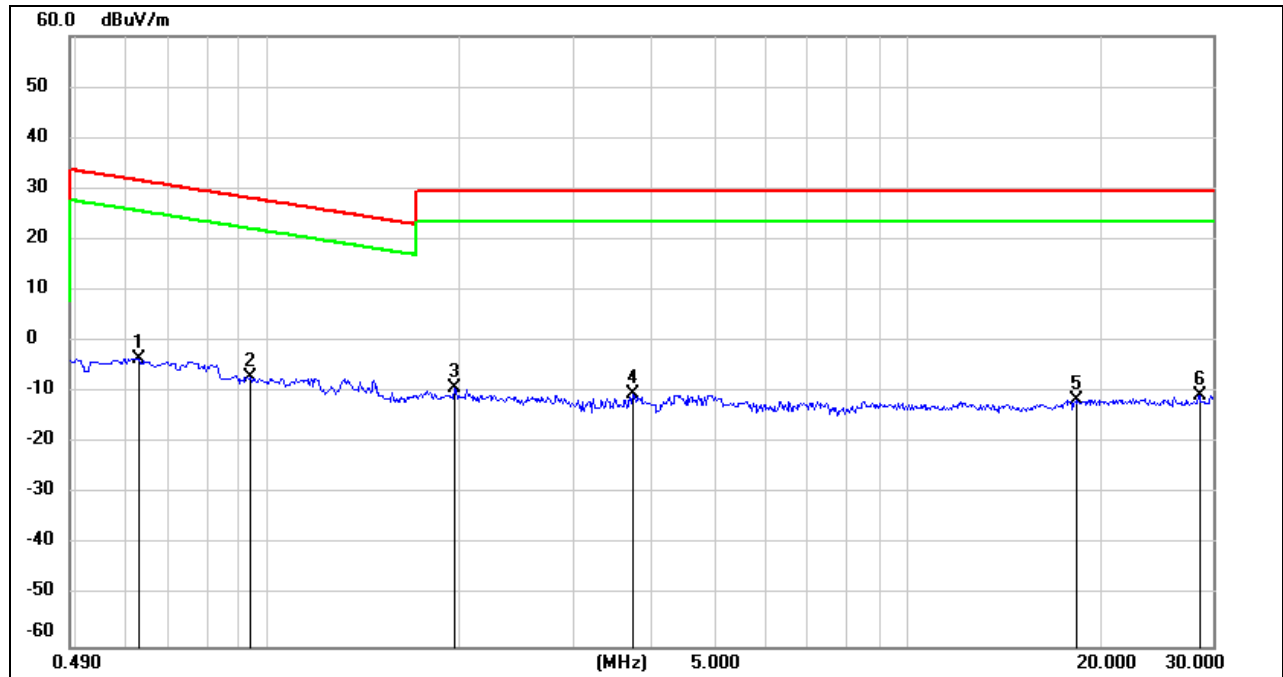

No.	Frequency (MHz)	Reading (dBuV)	Correct (dB/m)	Result (dBuV/m)	Limit (dBuV/m)	Margin (dB)	Remark
1	0.6298	58.67	-62.09	-3.42	31.62	-35.04	peak
2	0.9385	55.17	-62.23	-7.06	28.15	-35.21	peak
3	1.9521	52.61	-61.84	-9.23	29.54	-38.77	peak
4	3.7100	51.20	-61.41	-10.21	29.54	-39.75	peak
5	18.3430	49.36	-60.90	-11.54	29.54	-41.08	peak
6	28.6128	49.37	-60.10	-10.73	29.54	-40.27	peak

Note: 1. Measurement = Reading Level + Correct Factor.
 2. If Peak Result complies with AV and QP limit, AV and QP Result are deemed to comply with AV limit.
 3. All 3 polarizations(Horizontal, Face-on and Face-off) of the loop antenna had been tested, but only the worst data recorded in the report.

Note: All the test modes have been tested, only the worst data record in the report.



9. ANTENNA REQUIREMENTS

Applicable requirements

Please refer to FCC §15.203

An intentional radiator shall be designed to ensure that no antenna other than that furnished by the responsible party shall be used with the device. The use of a permanently attached antenna or of an antenna that uses a unique coupling to the intentional radiator shall be considered sufficient to comply with the provisions of this section. The manufacturer may design the unit so that a broken antenna can be replaced by the user, but the use of a standard antenna jack or electrical connector is prohibited.

Please refer to FCC §15.247(b)(4)

The conducted output power limit specified in paragraph (b) of this section is based on the use of antennas with directional gains that do not exceed 6 dBi. Except as shown in paragraph (c) of this section, if transmitting antennas of directional gain greater than 6 dBi are used, the conducted output power from the intentional radiator shall be reduced below the stated values in paragraphs (b)(1), (b)(2), and (b)(3) of this section, as appropriate, by the amount in dB that the directional gain of the antenna exceeds 6 dBi.

RESULTS

Complies



Appendix A): 6dB Bandwidth

Test Result

Mode	Channel	6dB Bandwidth [MHz]	Verdict
BLE	LCH	0.6848	PASS
BLE	MCH	0.6905	PASS
BLE	HCH	0.7079	PASS

Test Graphs

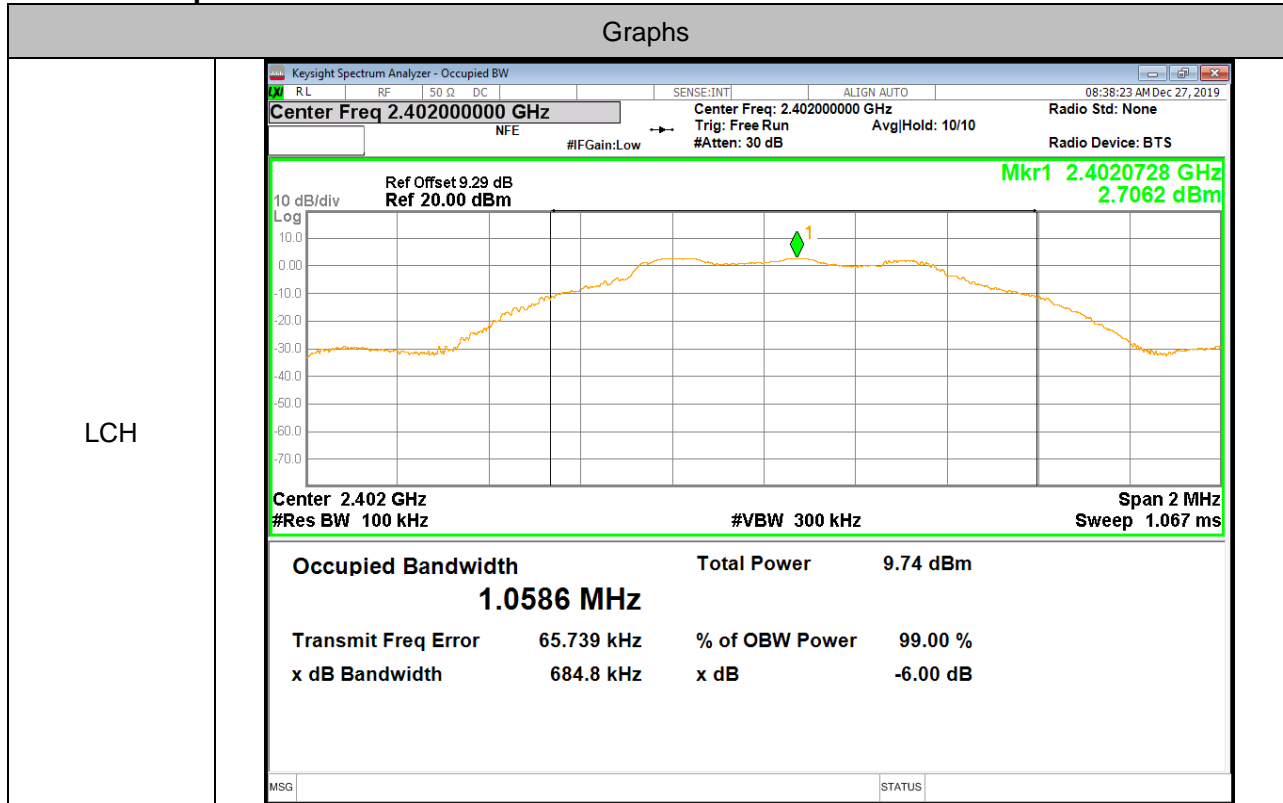

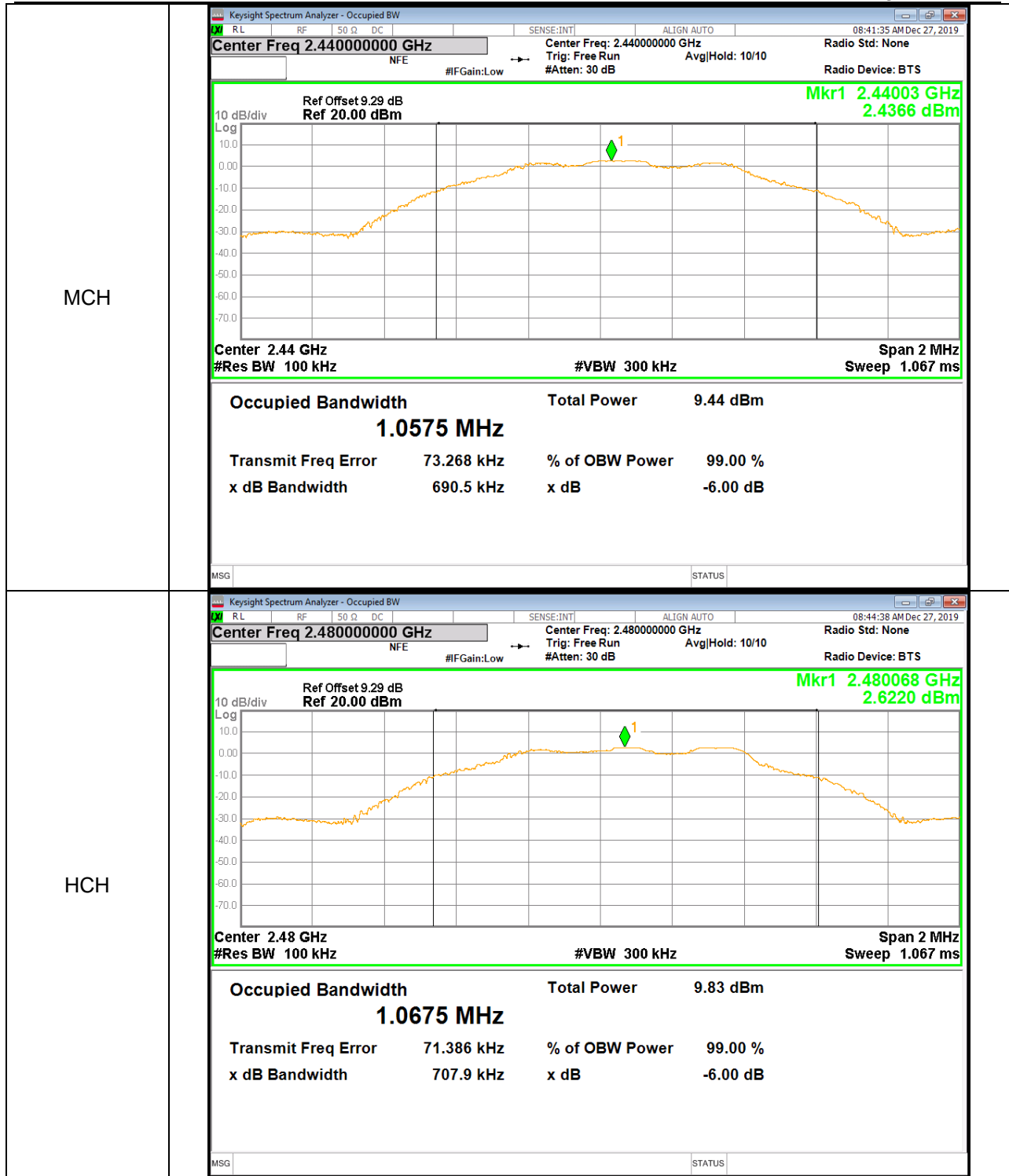



Appendix B): Occupied Bandwidth

Test Result

Mode	Channel	99% OBW[MHz]	Verdict
BLE	LCH	0.98982	PASS
BLE	MCH	1.0090	PASS
BLE	HCH	0.99414	PASS

Test Graphs

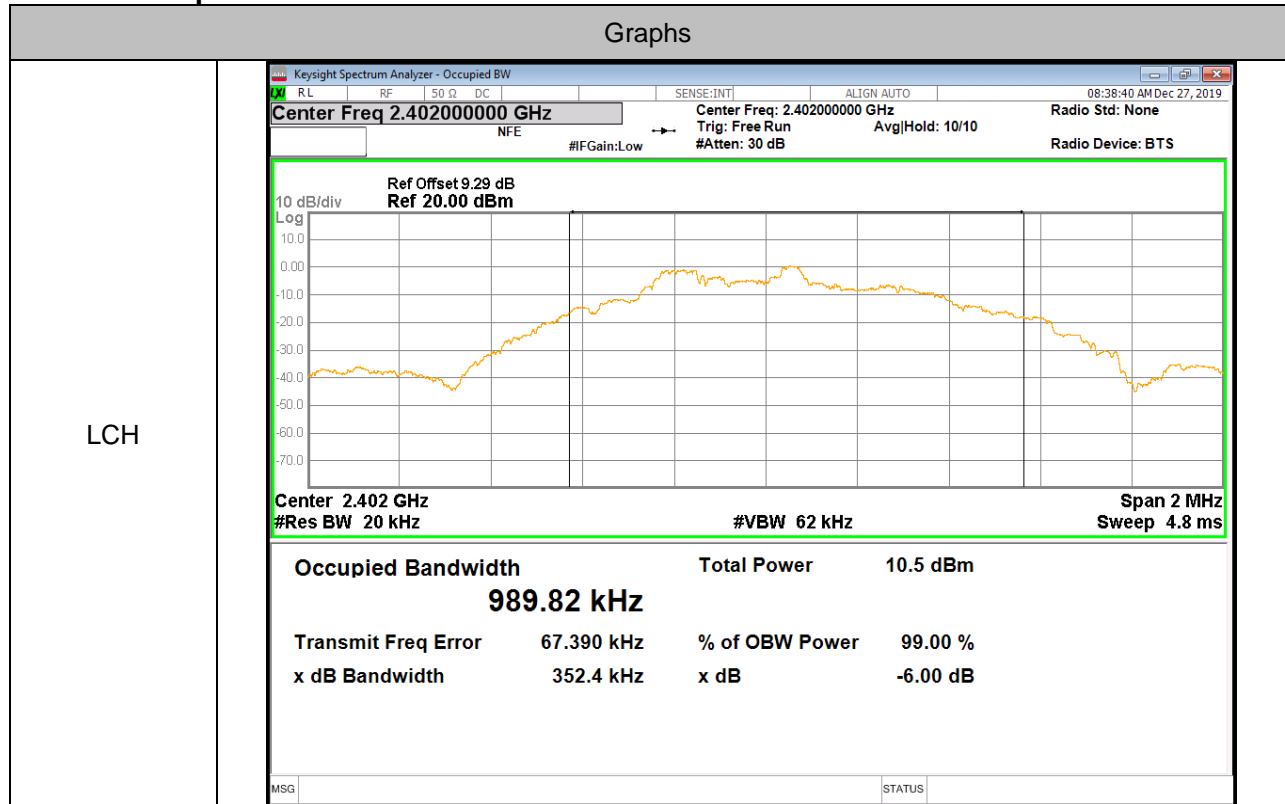

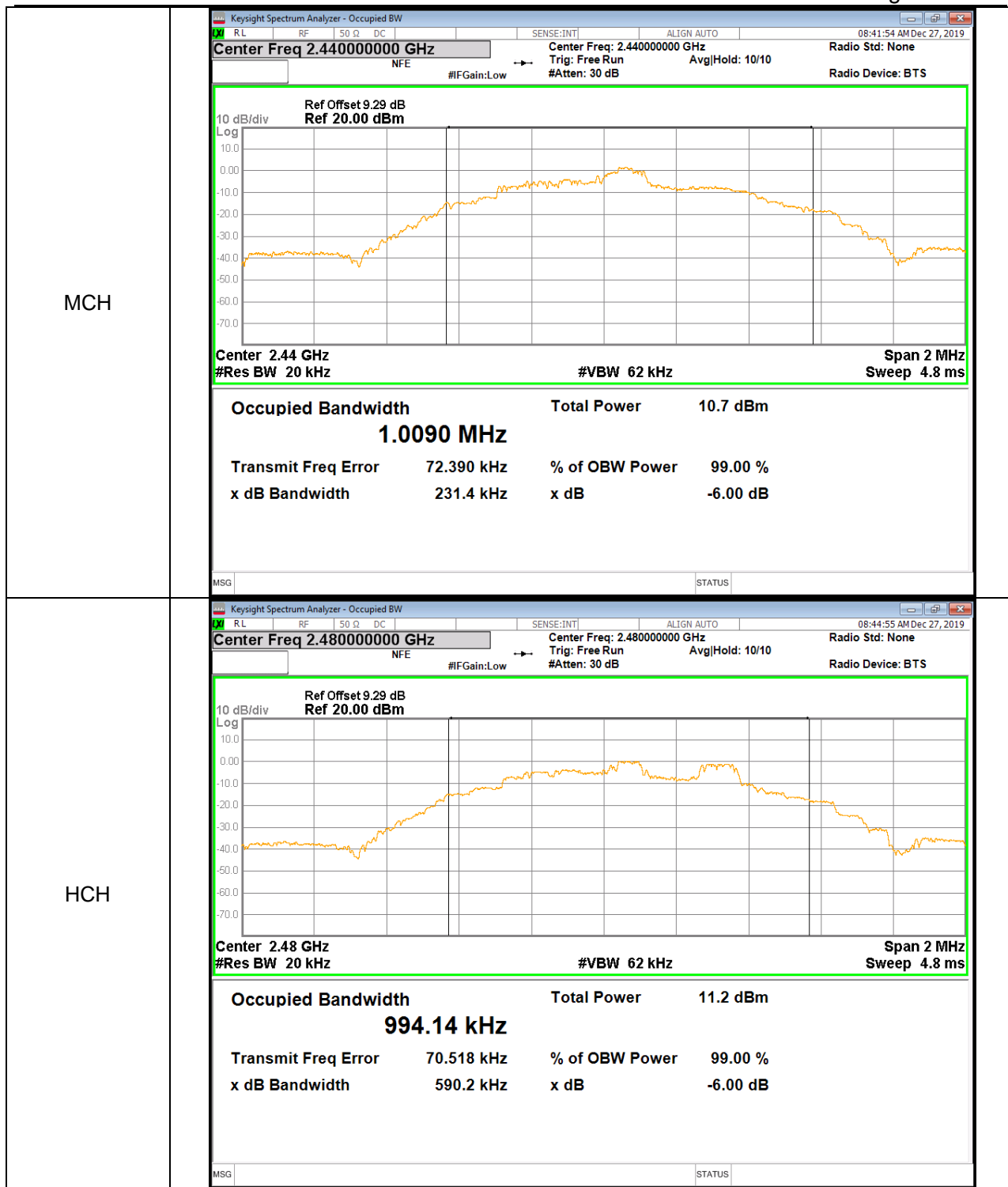



Appendix C): Band-edge for RF Conducted Emissions

Result Table

Mode	Channel	Carrier Power[dBm]	Max.Spurious Level [dBm]	Limit [dBm]	Verdict
BLE	LCH	2.712	-46.094	-17.29	PASS
BLE	HCH	2.610	-46.315	-17.39	PASS

Test Graphs

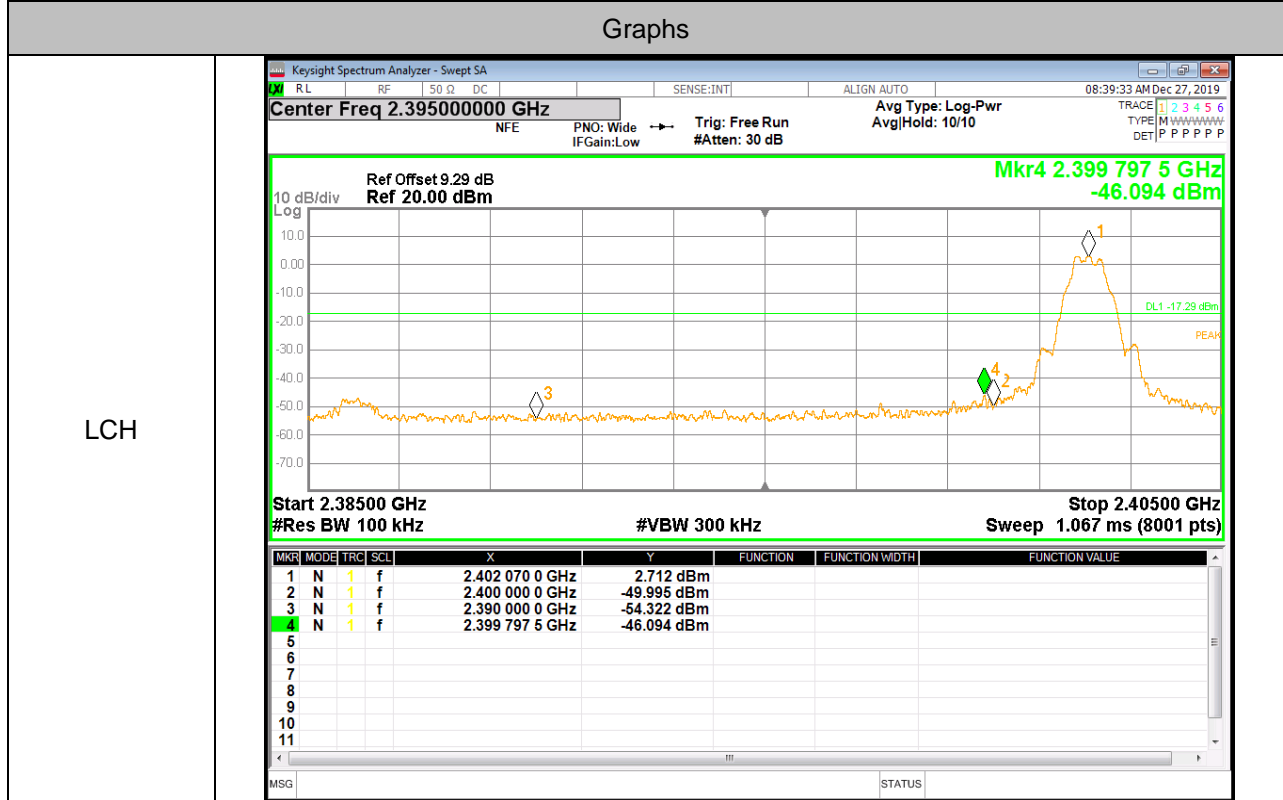

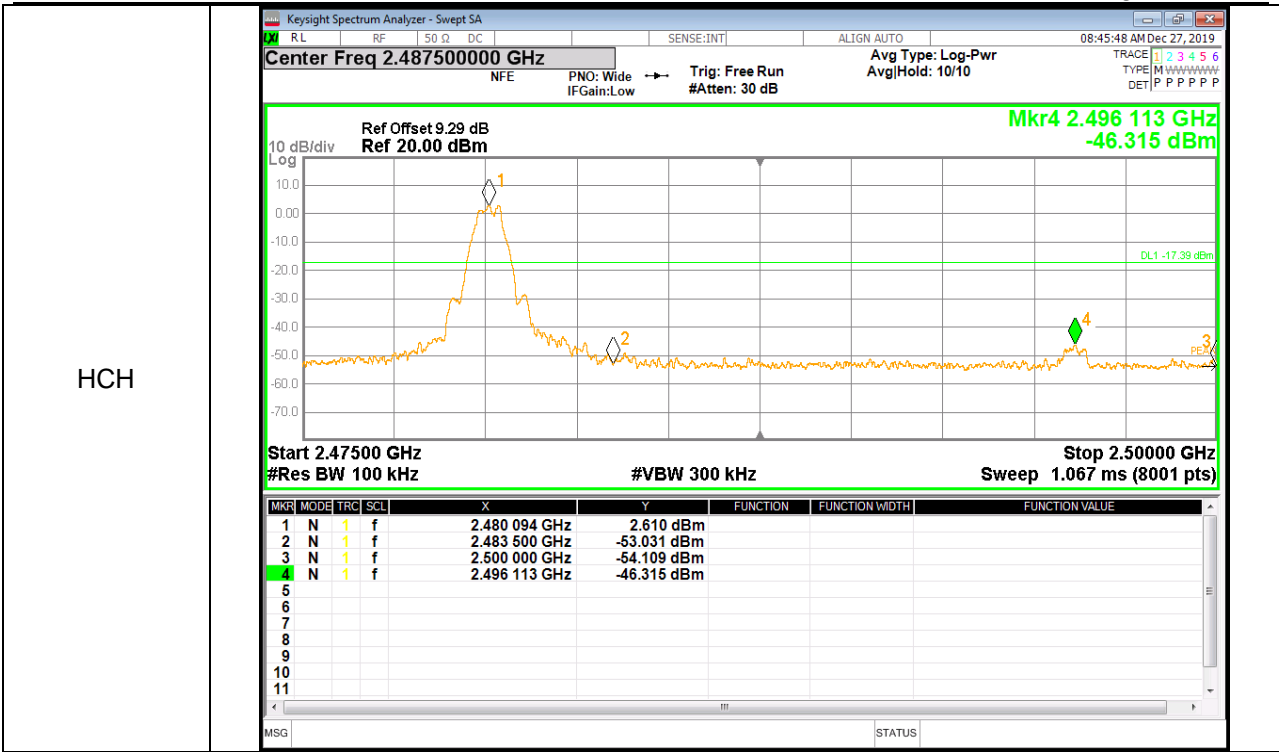



Appendix D): RF Conducted Spurious Emissions

Result Table

Mode	Channel	Pref [dBm]	Puw[dBm]	Verdict
BLE	LCH	2.686	<Limit	PASS
BLE	MCH	2.415	<Limit	PASS
BLE	HCH	2.599	<Limit	PASS

Test Graphs

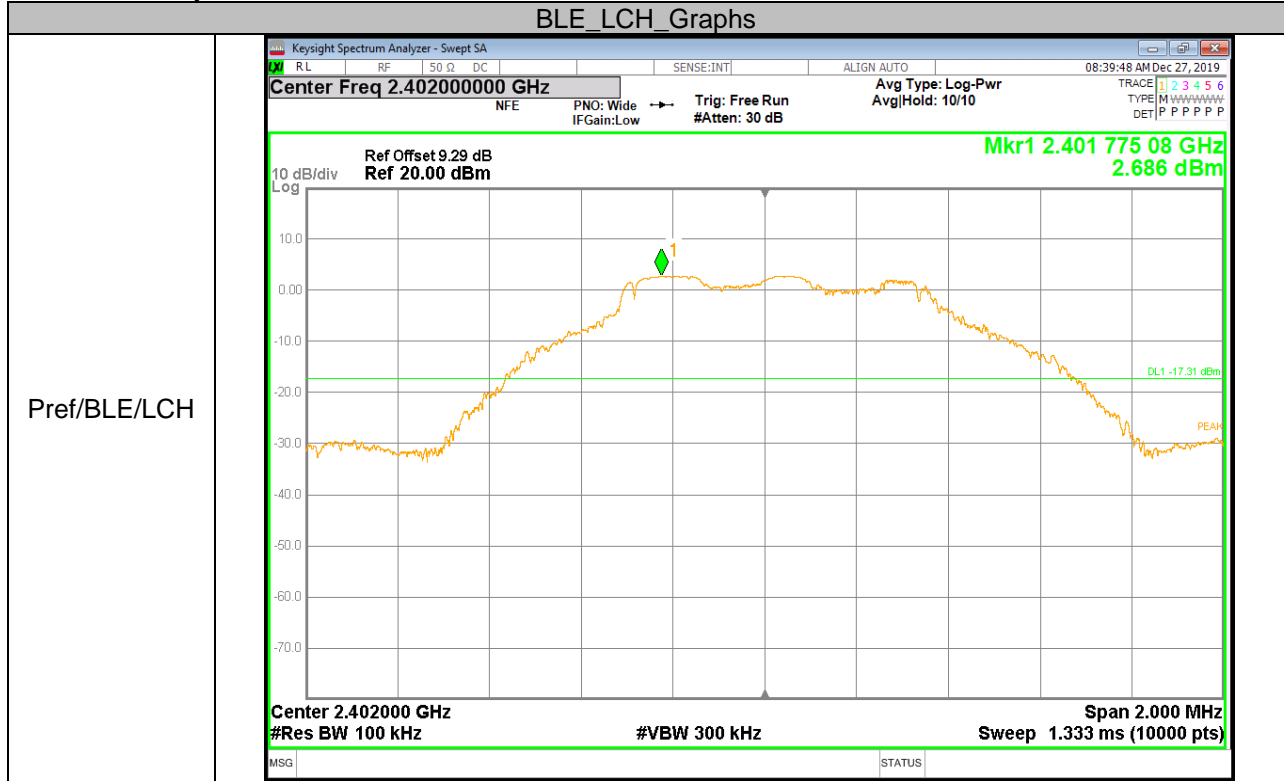



Puw/BLE/LCH

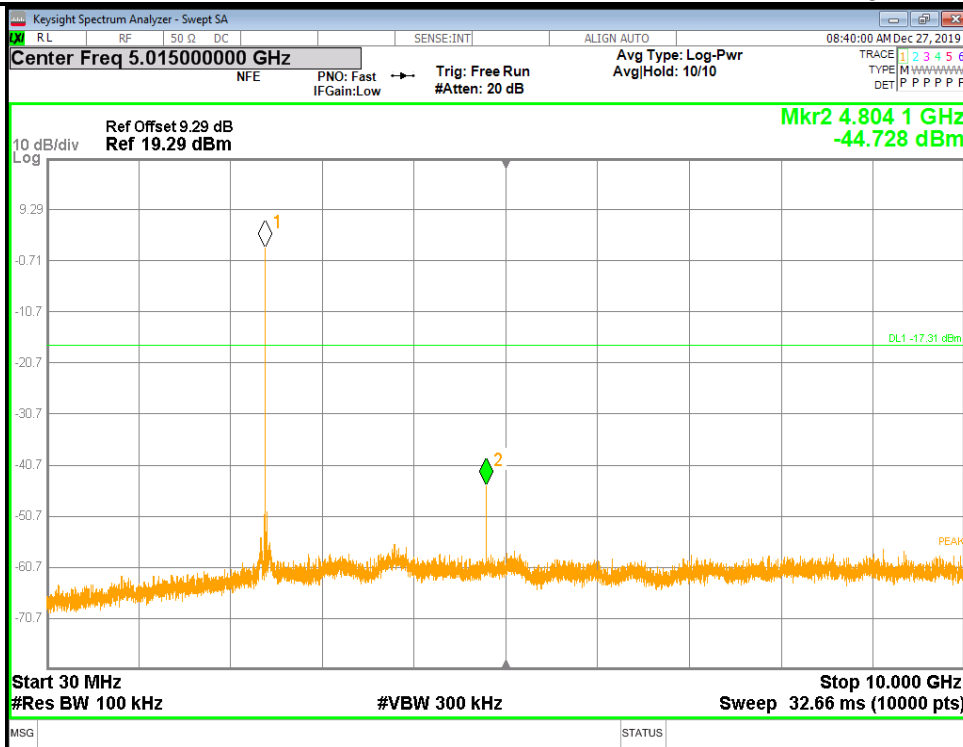

Note: The point 1 is 2.4G main carrier.

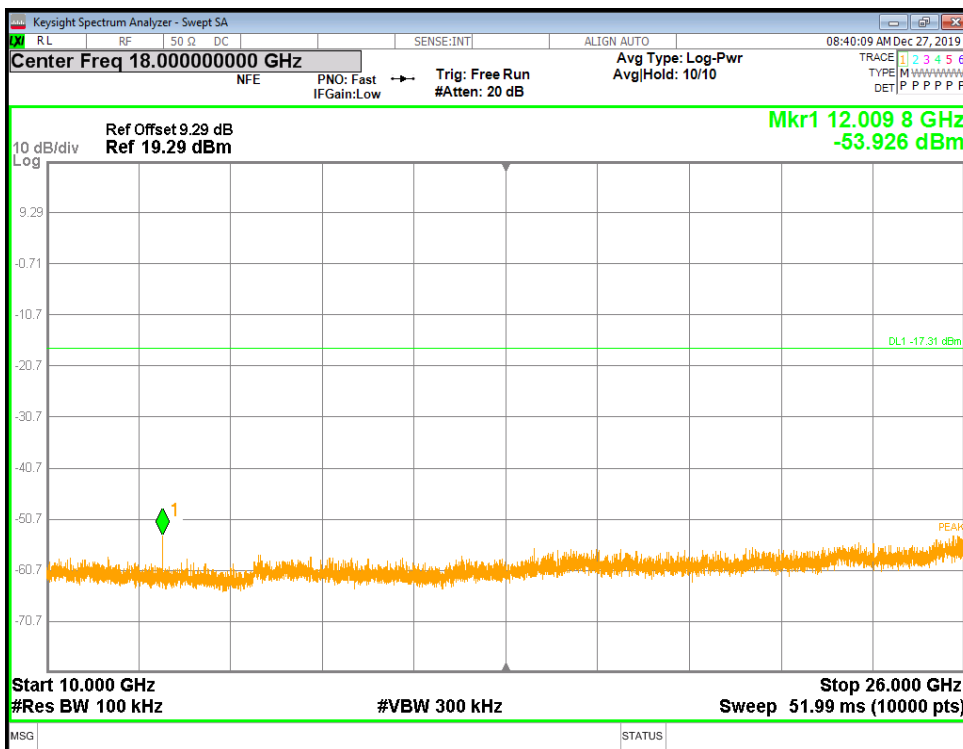



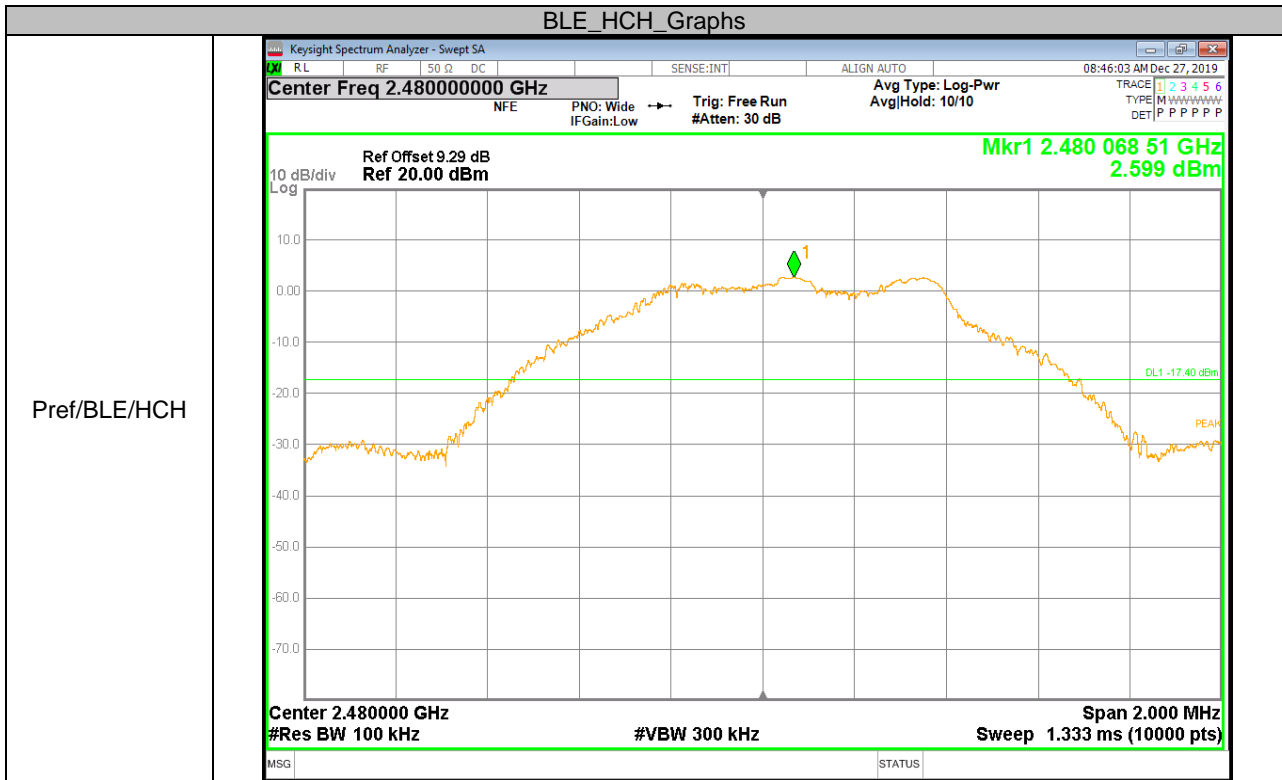
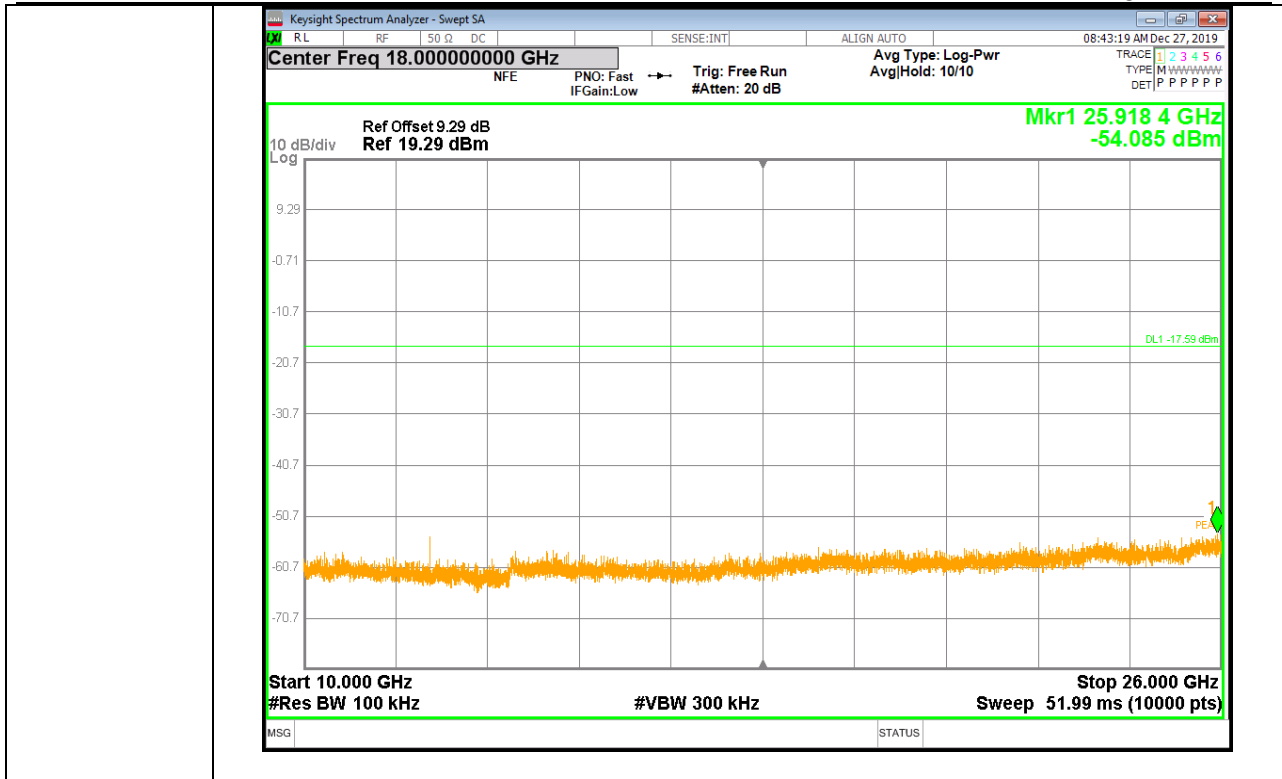

Pref/BLE/HCH

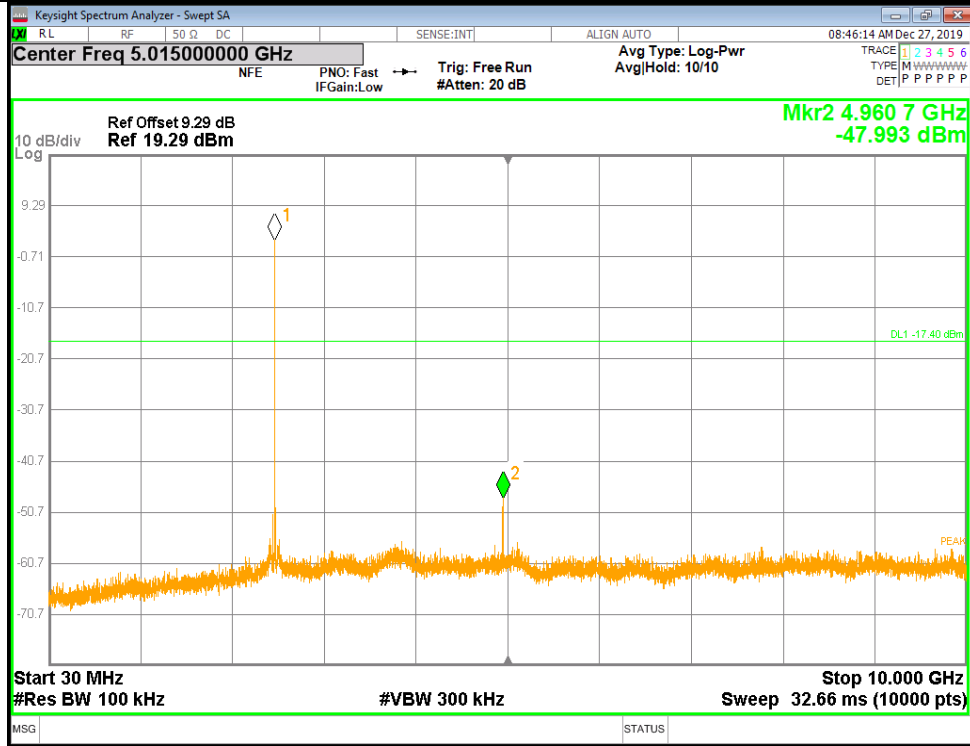

Note: The point 1 is 2.4G main carrier.

Puw/BLE/HCH

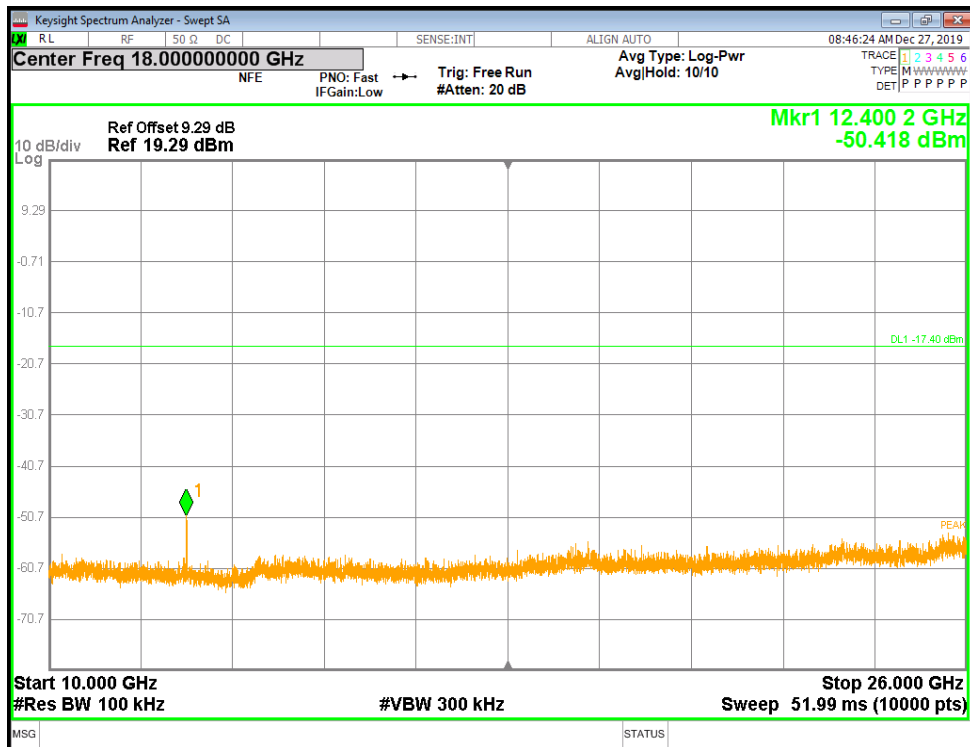



Appendix E): Maximum Power Spectral Density

Result Table

Mode	Channel	PSD [dBm]	Verdict
BLE	LCH	-10.486	PASS
BLE	MCH	-8.507	PASS
BLE	HCH	-10.938	PASS

Test Graphs

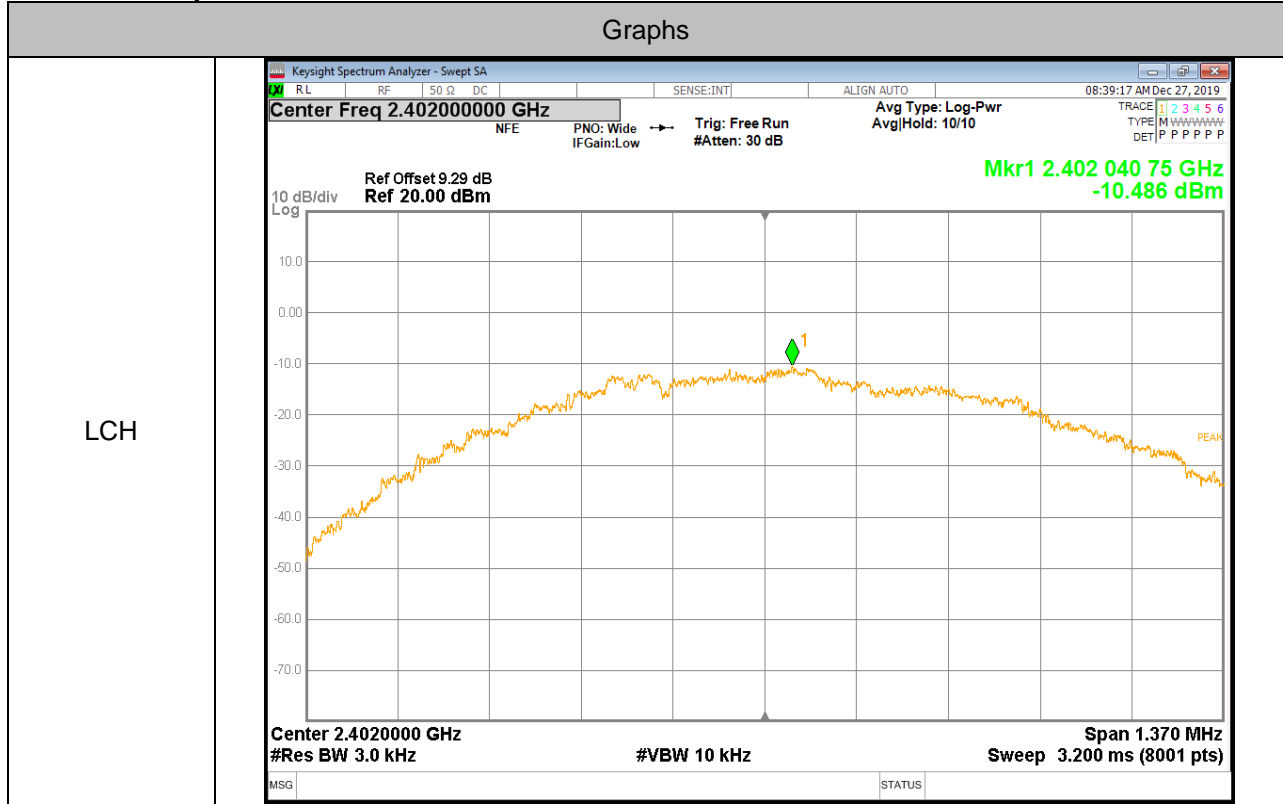

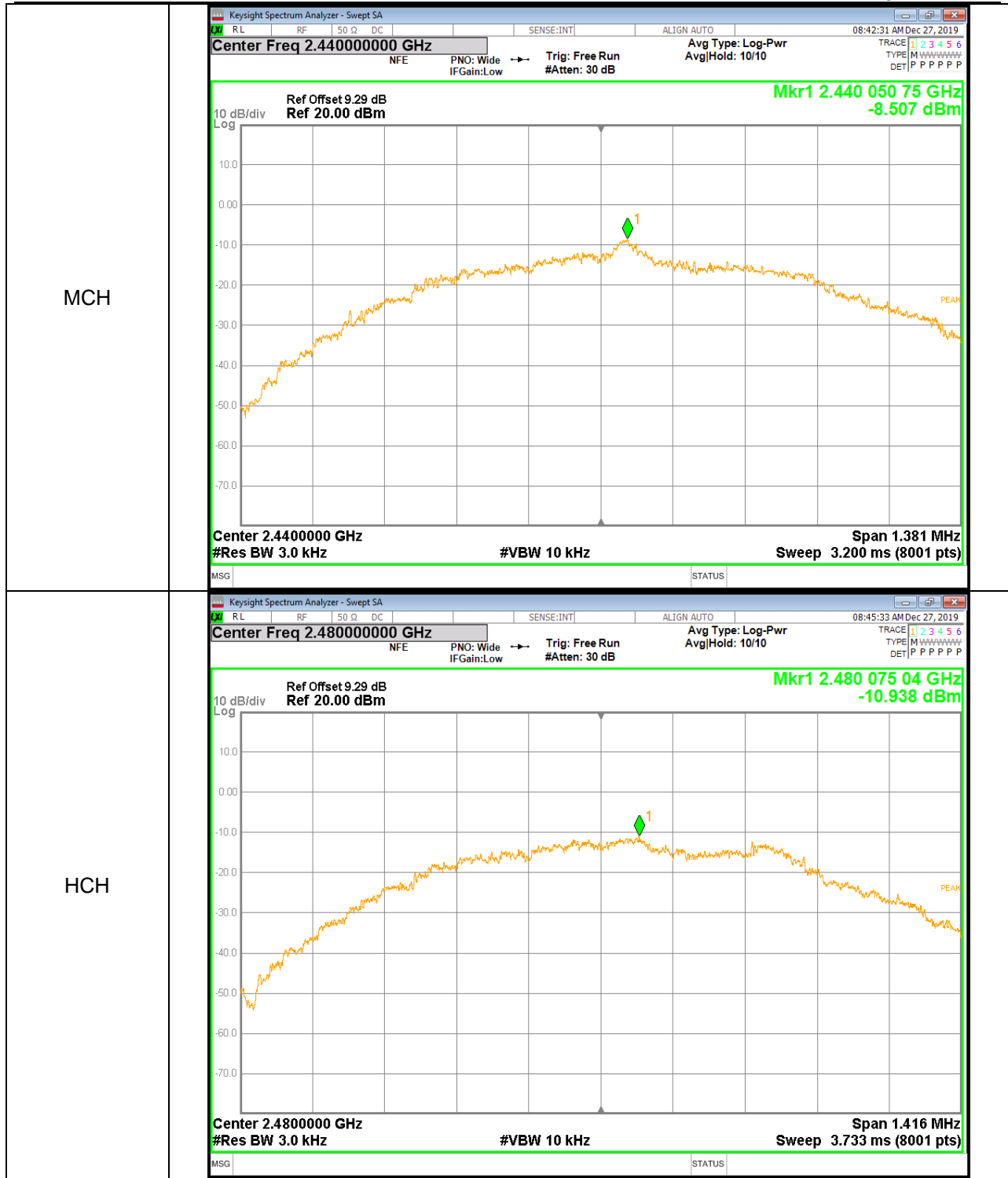

END OF REPORT