

# Certification of Compliance

## CFR 47 Part 15 Subpart C

Test Report File No. : 09-IST-0039      Date of Issue : January 21, 2009

Model(s) : BDT-7000N  
Buyer Model(s) : NG70121208  
Kind of Product : 7 Inch Navigation  
FCC ID : W2LBDT-7000N  
Applicant : BIGSON CO.,LTD  
Address : 138-3, Sosabon-dong, Sosa-gu Bucheon-si, Gyeonggi-do, Korea

Manufacturer : BIGSON CO.,LTD  
Address : 138-3, Sosabon-dong, Sosa-gu Bucheon-si, Gyeonggi-do, Korea

### Test Result

Positive

Negative

Reviewed By



S.J.CHO / EMC Group Manager

Approved By



B.S.KIM / Chief

### Comment (s)

- Investigations requested : Measurement to the relevant clauses of FCC rules and regulations Part 15 Subpart C.
  - The test report with appendix consists of 30 pages.
  - The test result only responds to the tested sample.
  - It is not allowed to copy this report even partly without the allowance of IST EMC Laboratory.
  - This equipment as for has been shown to be capable of continued compliance with the applicable technical standards as indicated in the measurement report and was tested in accordance with the measurement procedures specified in ANSI C63.4
- I assume full responsibility for accuracy and completeness of these data.



## TABLE OF CONTENTS

Table of contents	2
Information of test laboratory, Environmental conditions, Power used, Product information	3
Descriptions of Test	4
- Conducted Emission	4
-Conducted Emission Limits	5
- Radiated Emission	6
-Radiated Emission Limits	7
Measurement Uncertainty Calculations	8
Equipment Under Test	9
- Summary	10
- Radiated Emission	11
- Radiated Emission Result	12
- Field Strength	18
- Test Equipment & Limits	18
-Test result	20
- 20 dB Spectrum Bandwidth	21
- Test Equipment & Limits	21
- Test result	22
- Tuning Range of FM transmitter Measurement	23
- Test Equipment & Limits	23
- Test Result	24
- Test Photo of Test Setup	25
- The Photo of Equipment Under Test	30

Note:

## INFORMATIONS OF TEST LABORATORY

EMC LABORATORY of IST Co., Ltd. (FCC Filing Lab-400603.)

Singal-dong, Giheung-gu, Yongin-City

Kyonggi-Do, 400-19, Korea

TEL : +82 31 326 6700

FAX : +82 31 326 6797

## ENVIRONMENTAL CONDITIONS

Temperature                      1.3 °C    Humidity 44 %

Atmospheric pressure        1012 mbar

## POWER SUPPLY SYSTEM USED

Power supply system        DC 12V(CAR BATTERY)

(Refer to the product information)

## PRODUCT INFORMATION

Item	Specification
H/W Spec	CPU : Stm8815 500 MHz & 4 DSP Chip GPS Active Antenna built in ROM : 32 Mbyte NAND FLASH RMA : 128 Mbyte DDR SDRAM
S/W Spec	OS : Window CE 5.0 Core 1 inch TFT LCD
Power Input	DC 12 V (Car Battery)
Frequency	90 MHz ~ 91.9 MHz (20 CH.)
Operating Temperature	-20 °C ~ +70 °C
Operating Humidity	20 % ~ 95 %
Storage Temperature	-30 °C ~ +80 °C
Dimension	180*110*20(mm)
Weight	580 g

- Regards to the frequency band operation; the highest that was included the lowest, middle and highest frequency of channel were selected to perform the test, and then shown on this report.

- Please refer to user's manual.

## DESCRIPTION OF TEST

### Conducted Emissions:

The measurement were performed over the frequency range of 0.15 MHz to 30 MHz using a 50 Ω/50 uH LISN as the input transducer to a Spectrum Analyzer or a Field Intensity Meter. The measurements were made with the detector set for "Peak" amplitude within a bandwidth of 10KHz or for "quasi-peak" & "Average" within a bandwidth of 9 KHz.

#### -Procedure of Test

The line-conducted facility is located inside a shielded room No.1. A 1 m X 1.5 m wooden table 80 cm height is placed 40 cm away from the vertical wall and 1.5 m away from the other wall of the shielded room. The R/S ESCI and Hyup-Rip KNW-407 LISN are bonded to bottom of the shielded room. The EUT is located on the wooden table with distance more than 80 cm from the LISN and powered from the EMCO LISN .The peripheral equipment is powered from the other LISN. Power to the LISNs are filtered by a noise cut power line filters. All electrical cables are shielded by braided tinned steel tubing with inner φ 1.2 cm. If the EUT is a DC-powered device, power will be derived from the source power supply it normally will be powered from and this supply lines will be connected to the EMCO LISN. All interconnecting cables more than 1m were shortened by non-inductive bundling to a 1m length. Sufficient time for the EUT, support equipment, and test equipment was allowed in order for them to warm up to their normal operating conditions. The RF output of the LISN was connected to the R/S receiver to determine the frequency producing the maximum emission from the EUT. The frequency producing the maximum level was reexamined using Quasi-Peak mode by manual measurement, after scanned by automatic Peak mode for frequency range from 0.15 to 30 MHz. The bandwidth of the receiver was set to 10 kHz. The EUT, peripheral equipment, and interconnecting cables were arranged and manipulated to maximize each EME emission.

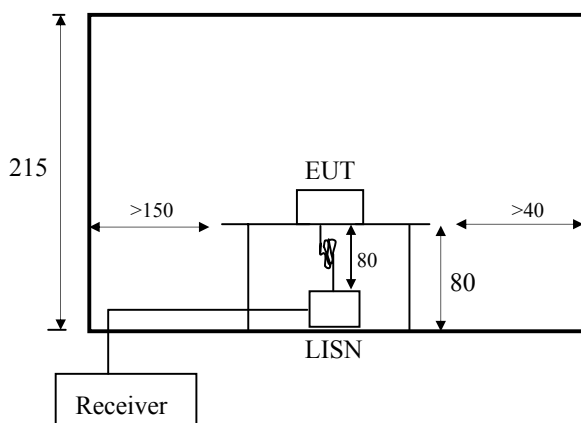

< Side View >

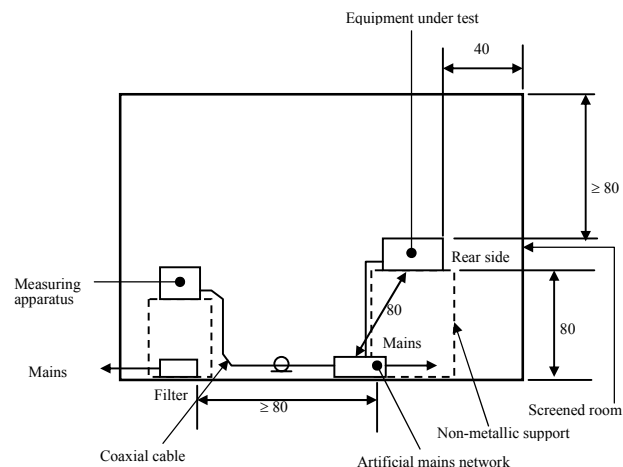

< Concept Drawing >

**Limits**

According to § 15.207(a) except as shown in paragraphs (b) and (c) of this section, for an intentional radiator that is designed to be connected to the public utility (AC) power line, the radio frequency voltage that is conducted back onto the AC power line on any frequency or frequencies within the band 150 kHz to 30 MHz shall not exceed the limits in the following table, as measured using a 50  $\mu$  H/50 ohms line impedance stabilization network(LISN). Compliance with the provisions of this paragraph shall be based on the measurement of the radio frequency voltage between each power line and ground at the power terminal. The lower limit applies at the boundary between the frequency ranges.

Frequency Range (MHz)	Limits	
	Quasi-peak	Average
0.15 to 0.50	66 to 56*	56 to 46*
0.50 to 5	56	46
5 to 30	60	50

\* Decreases with the logarithm of the frequency.

Test specification.

According to FCC CFR Title 47 Part 15 Subpart C Section 15.207 : 2005

## Radiated Emissions:

The measurement was performed over the frequency range of 30 MHz to 1 GHz using antenna as the input transducer to a Spectrum analyzer or a Field Intensity Meter. The measurement was made with the detector set for "quasi-peak" within a bandwidth of 120 KHz.

### -Procedure of Test

Preliminary measurements were made at 3 meter using bi-conical and log-periodic antennas, and spectrum analyzer to determine the frequency producing the max. emission in anechoic chamber. Appropriate precaution was taken to ensure that all emission from the EUT were maximized and investigated. The system configuration, mode of operation, turn-table azimuth and height with respect to the antenna were noted for each frequency found. The spectrum was scanned from 30 MHz to 1000 MHz using bi-log antenna. Above 1 GHz, linearly polarized double ridge horn antennas were used. Final measurements were made at open site with 3-meters test distance using S/B bi-log antenna or horn antenna. The OATS have been verified in regular for its normalized site attenuation. The test equipment was placed on a wooden table. Sufficient time for the EUT, peripheral equipment, and test equipment was allowed in order for them to warm up to their normal operating condition. Each frequency found during pre-scan measurements was re-examined by manual. The detector function was set to CISPR quasi-peak mode and the bandwidth of the receiver was set to 120 kHz or 1 MHz depending on the frequency of type of signal. The EUT, peripheral equipment and interconnecting cables were re-configured to the set-up producing the max. emission for the frequency and were placed on top of a 0.8-meter high nonmetallic 1 x 1.5 meter table. The EUT, peripheral equipment, and interconnecting cables were re-arranged and manipulated to maximize each emission. The turntable containing the system was rotated; the antenna height was varied 1 to 4 meters and stopped at the azimuth or height producing the maximum emission. Each emission was maximized by: varying the mode of operation to the EUT and/or peripheral equipment and changing the polarity of the antenna, whichever determined the worst-case emission.

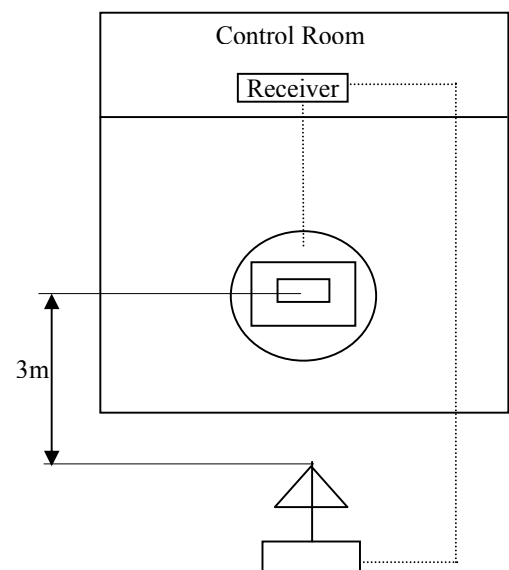
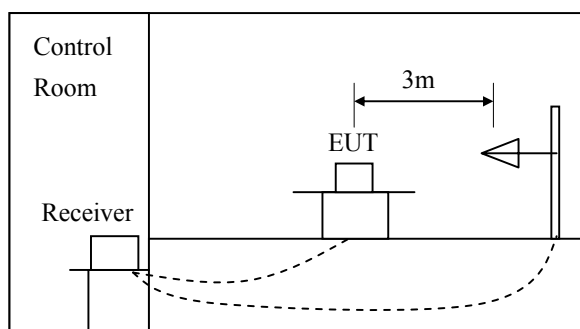

## Limits

Emissions radiated outside of the specified frequency bands, except for harmonics, Shall be attenuated by at least 20dB below the level of the fundamental or to the General radiated emission limits in paragraph 15.209, whichever is the lesser attenuation:

FCC Part 15 Subpart C Section 15.209 Limits		
Frequency (MHz)	μV/meter	dBμV/meter
30-88	100	40
88-216	150	43.5
216-960	200	46
Above 960	500	54

Remarks :

1. RF Voltage(dBuv)=20log RF Voltage(uV)
2. In the Above Table, the tighter limit applies at the band edges.
3. Distance refers to the distance in meters between the measuring Instrument antenna and the closed point of any part of the device or System.

Test specification.

According to FCC CFR Title 47 Part 15 Subpart C Section 15.209 : 2005

## Measurement Uncertainty Calculations

The measurement uncertainties stated were calculated in accordance with the requirements of NIST Technical Note 1297 and NIS 81 (1994).

Contribution (Conducted Emissions)	Probability Distribution	Uncertainty ( $\pm$ dB)
		0.15-30MHz
Receiver Specification	Rectangular	1.5
LISN Coupling Specification	Rectangular	1.5
Cable and Input Attenuator Calibration	Normal (k=2)	0.5
Mismatch to Reciver	U-Shaped	-0.8 / +0.7
System Repeatability	Normal (k=1)	0.2
Combined Standard Uncertainty	Normal (k=2)	-1.85 / +1.71
Expanded Uncertainty U	Normal (k=2)	-3.7 / +3.42

$$U_{c,minus} = -1.85, U_{c,plus} = 1.71$$

$$U = -3.70 / +3.42 \text{ (k=2, 95.45\% confidence level)}$$

Contribution (Radiated Emissions)	Probability Distribution	Uncertainties( $\pm$ dB)
		3 m
Antenna		
Factor	Normal (k=2)	0.9968
Frequency Interpolation	Rectangular	0.1039
Height Variation	Rectangular	-2.6 / +1.5
Directivity Difference	Rectangular	-1.0 / +0
Phase Center Location	Rectangular	1.0
Cable Loss	Normal (k=2)	0.5
Receiver		
Voltage Accuracy	Normal (k=2)	2.0
Pulse Response	Rectangular	1.5
Absolute Repetition Rate	Rectangular	1.5
Mismatch to Receiver		
$ \Gamma_{antenna}  = 0.33$	U-Shaped	-1.0 / +0.9
$ \Gamma_{receiver}  = 0.33$		
System Repeatability	Std Deviation	0.5
Combined Standard Uncertainty	Normal	-2.6048 / 2.2775
Expanded Uncertainty U	Normal (k=2)	-5.21 / +4.55

$$U_{c,minus} = -2.6048, U_{c,plus} = 2.2775$$

$$U = -5.21 / +4.55 \text{ (k=2, 95.45\% confidence level)}$$



## Equipment Under Test

**EUT Type :**

- Table-Top.  Floor-Standing.
- Table-Top and Floor-Standing(Combination).

**Operation – mode of the E.U.T. :**

The equipment under test was operated during the measurement under following conditions :

- Standby Mode
- Operational Condition : Continue Transmit, Serial Communication

**Configuration of the equipment under test :**

Following peripheral devices and interface cables were connected during the measurement :

Equipment	Type	Brand	Serial No.
CAR BATTERY	TN1200GSN	ATLASBX CO.,LTD	N/A
DVD Player	VP-NS92V	SONY	N/A

**Connecting Interface Cables :**

- Unshielded DC power cable(without ferrite core) : 1.5 m
- Unshielded Audio in cable(without ferrite core) : 0.2 m
- Unshielded Video in cable(without ferrite core) : 0.2 m
- Unshielded CAM cable(without ferrite core) : 0.2 m

### Test Set-Up Configuration

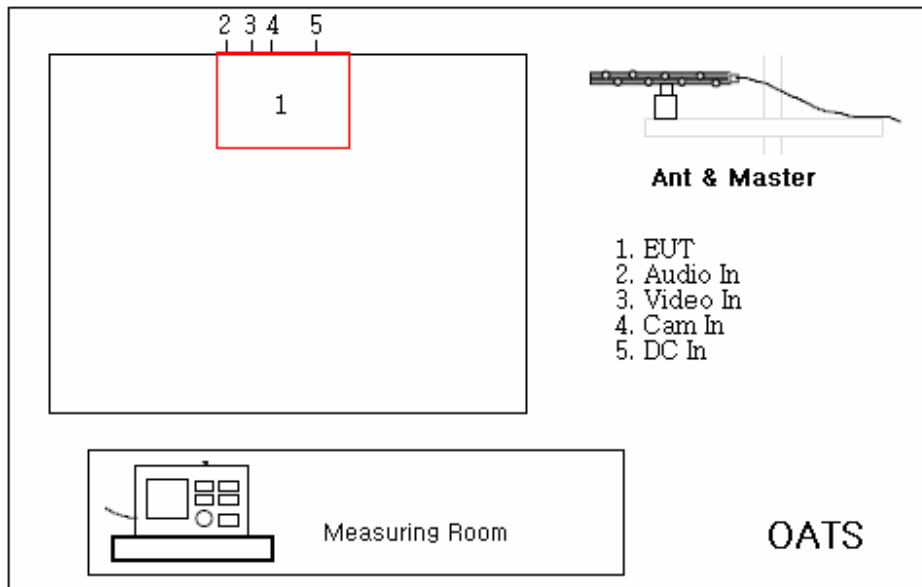

## SUMMARY

### Test Descriptions

- Conducted Emission	N/A*
-Conducted Emission result	
- Radiated Emission	PASS
- Radiated Emission Result	
- Field Strength	PASS
- Test result	
- 20 dB Spectrum bandwidth	PASS
- Test result	
- Tuning Range of FM transmitter Measurement	PASS
- Test Result	

\* It is not need test this requirement, because the EUT shall be operated by car battery

### Test Date

Begin of Testing : Jan. 02, 2009 - End of Testing : Jan. 16, 2009

Note :

- means the test is applicable,
- is not applicable.

Prepared By



---

J.Y. Choi / Senior Engineer

Radiated Emission

[Applicable]

◆ Test Equipment Used

Name	Type	Manufacturer	Calibration. Date	Serial Number
ESCS30	EMI Receiver	Rohde & Schwarz	Aug. 10, 2008	100373
SPECTRUM ANALYZER	R3273	ADVANTEST	Oct. 01, 2008	MY42000092
BICONILOG Antenna	VULB 9160	Schwarz beck	Aug. 28, 2008	3047
DVD Player	VP-NS92V	SONY	-	N/A

- Note : 1. The calibration interval of the above test instruments is 12 months and the calibrations are traceable to RRL, KRISS, KTL and HCT.
2. The calibration interval of horn ant. and loop ant. is 24 months
3. The DVD Player was set to maximum output power.

### Radiated Emission Result

[Applicable]

**POWER : DC 12 V (CAR BATTERY)**

**NOTE : NAVIGATION MODE**

Freq. (MHz)	Reading (dBuV/m)	Ant. Factor (dBuV/m)	Cable Loss (dB)	Ant. Height (cm)	Pol. (H/V)	Limits (dBuV/m)	Result (dB)	Margin (dB)
71.996	21.00	8.92	1.00	195	H	40.00	30.92	-9.08
108.005	25.10	10.06	1.32	198	H	43.50	36.48	-7.02
119.995	22.90	11.40	1.49	137	H	43.50	35.79	-7.71
203.978	17.00	9.19	2.28	167	H	43.50	28.47	-15.03
252.005	19.00	11.00	2.40	131	H	46.00	32.40	-13.60
48.000	17.00	12.09	0.76	114	V	40.00	29.85	-10.15
*59.984	22.90	11.20	0.89	121	V	40.00	34.99	-5.01
71.996	25.80	8.92	1.00	113	V	40.00	35.72	-4.28
75.402	17.90	8.46	1.00	197	V	40.00	27.36	-12.64
81.003	21.40	7.90	1.03	151	V	40.00	30.33	-9.67
95.996	19.10	8.88	1.24	114	V	43.50	29.22	-14.28
108.005	22.50	10.06	1.32	122	V	43.50	33.88	-9.62
119.995	25.30	11.40	1.49	110	V	43.50	38.19	-5.31
123.899	17.70	11.61	1.51	138	V	43.50	30.82	-12.68
623.975	15.80	19.29	3.89	153	V	46.00	38.98	-7.02

Note :

1. Remark "\*" means that the data is the worst emission level.
2. All reading levels are Quasi-peak value.
3. Measurement level = reading level + correct factor

**[Applicable]**

**POWER : DC 12 V (CAR BATTERY)**

**NOTE : Audio & Video In MODE**

Freq. (MHz)	Reading (dBuV/m)	Ant. Factor (dBuV/m)	Cable Loss (dB)	Ant. Height (cm)	Pol. (H/V)	Limits (dBuV/m)	Result (dB)	Margin (dB)
108.004	18.30	10.06	1.32	196	H	43.50	29.68	-13.82
203.978	13.00	9.19	2.28	250	H	43.50	24.47	-19.03
252.005	12.00	11.00	2.40	320	H	46.00	25.40	-20.60
72.297	22.60	8.88	1.00	115	V	40.00	32.48	-7.52
108.004	24.20	10.06	1.32	110	V	43.50	35.58	-7.92
*921.560	11.30	23.03	5.04	150	V	46.00	39.37	-6.63
979.156	13.90	23.58	5.21	180	V	54.00	42.69	-11.31

*Note :*

1. Remark "\*" means that the data is the worst emission level.
2. All reading levels are Quasi-peak value.
3. Measurement level = reading level + correct factor

**[Applicable]**

**POWER : DC 12 V (CAR BATTERY)**

**NOTE : USING CAM MODE**

Freq. (MHz)	Reading (dBuV/m)	Ant. Factor (dBuV/m)	Cable Loss (dB)	Ant. Height (cm)	Pol. (H/V)	Limits (dBuV/m)	Result (dB)	Margin (dB)
108.004	16.40	10.06	1.32	196	H	43.50	27.78	-15.72
203.978	11.70	9.19	2.28	250	H	43.50	23.17	-20.33
252.005	10.90	11.00	2.40	320	H	46.00	24.30	-21.70
72.297	20.40	8.88	1.00	115	V	40.00	30.28	-9.72
108.004	23.70	10.06	1.32	110	V	43.50	35.08	-8.42
*921.560	10.40	23.03	5.04	150	V	46.00	38.47	-7.53
979.156	12.70	23.58	5.21	180	V	54.00	41.49	-12.51

*Note :*

- 1. Remark "\*" means that the data is the worst emission level.*
- 2. All reading levels are Quasi-peak value.*
- 3. Measurement level = reading level + correct factor*

**[Applicable]**

**POWER : DC 12 V (CAR BATTERY)**

**NOTE : FMT CH1(90.0 MHz)**

Freq. (MHz)	Reading (dBuV/m)	Ant. Factor (dBuV/m)	Cable Loss (dB)	Ant. Height (cm)	Pol. (H/V)	Limits (dBuV/m)	Result (dB)	Margin (dB)
71.997	21.80	8.92	1.00	193	H	40.00	31.72	-8.28
108.002	25.80	10.06	1.32	198	H	43.50	37.18	-6.32
119.994	23.50	11.40	1.49	180	H	43.50	36.39	-7.11
204.001	21.40	9.19	2.28	114	H	43.50	32.87	-10.63
215.995	22.40	9.64	2.23	116	H	43.50	34.27	-9.23
*647.971	17.50	19.71	3.99	124	H	46.00	41.20	-4.80
671.973	16.00	19.90	4.13	110	H	46.00	40.03	-5.97
60.001	22.40	11.19	0.90	115	V	40.00	34.49	-5.51
71.997	24.50	8.92	1.00	112	V	40.00	34.42	-5.58
84.002	23.40	8.09	1.12	124	V	40.00	32.61	-7.39
89.929	25.40	8.46	1.29	111	V	43.50	35.15	-8.35
119.997	21.10	11.40	1.49	180	V	43.50	33.99	-9.51
599.972	13.70	18.87	3.79	112	V	46.00	36.36	-9.64
623.976	15.20	19.29	3.89	159	V	46.00	38.38	-7.62
671.970	15.60	19.90	4.13	158	V	46.00	39.63	-6.37
695.972	13.60	20.07	4.27	297	V	46.00	37.94	-8.06

*Note :*

- 1. Remark "\*" means that the data is the worst emission level.*
- 2. All reading levels are Quasi-peak value.*
- 3. Measurement level = reading level + correct factor*

**[Applicable]**

**POWER : DC 12 V (CAR BATTERY)**

**NOTE : FMT CH11 (91.0 MHz)**

Freq. (MHz)	Reading (dBuV/m)	Ant. Factor (dBuV/m)	Cable Loss (dB)	Ant. Height (cm)	Pol. (H/V)	Limits (dBuV/m)	Result (dB)	Margin (dB)
71.997	21.40	8.92	1.00	200	H	40.00	31.32	-8.68
*108.002	25.30	10.06	1.32	152	H	43.50	36.68	-6.82
119.994	22.40	11.40	1.49	172	H	43.50	35.29	-8.21
204.001	21.30	9.19	2.28	115	H	43.50	32.77	-10.73
215.995	22.10	9.64	2.23	110	H	43.50	33.97	-9.53
252.013	23.70	11.00	2.40	170	H	46.00	37.10	-8.90
60.001	20.70	11.19	0.90	120	V	40.00	32.79	-7.21
71.997	21.60	8.92	1.00	180	V	40.00	31.52	-8.48
84.002	20.90	8.09	1.12	110	V	40.00	30.11	-9.89
89.929	24.60	8.46	1.29	110	V	43.50	34.35	-9.15
119.997	19.30	11.40	1.49	140	V	43.50	32.19	-11.31
599.972	13.40	18.87	3.79	115	V	46.00	36.06	-9.94
623.976	14.50	19.29	3.89	116	V	46.00	37.68	-8.32
671.970	15.10	19.90	4.13	143	V	46.00	39.13	-6.87
695.972	13.00	20.07	4.27	250	V	46.00	37.34	-8.66

Note :

1. Remark "\*" means that the data is the worst emission level.
2. All reading levels are Quasi-peak value.
3. Measurement level = reading level + correct factor



**[Applicable]**

**POWER : DC 12 V (CAR BATTERY)**

**NOTE : FMT CH20 (91.9 MHz)**

Freq. (MHz)	Reading (dBuV/m)	Ant. Factor (dBuV/m)	Cable Loss (dB)	Ant. Height (cm)	Pol. (H/V)	Limits (dBuV/m)	Result (dB)	Margin (dB)
71.997	23.70	8.92	1.00	134	H	40.00	33.62	-6.38
108.002	24.40	10.06	1.32	199	H	43.50	35.78	-7.72
*119.994	24.80	11.40	1.49	148	H	43.50	37.69	-5.81
204.001	22.30	9.19	2.28	112	H	43.50	33.77	-9.73
215.995	21.70	9.64	2.23	130	H	43.50	33.57	-9.93
647.971	16.70	19.71	3.99	140	H	46.00	40.40	-5.60
671.973	15.50	19.90	4.13	135	H	46.00	39.53	-6.47
60.001	21.30	11.19	0.90	158	V	40.00	33.39	-6.61
71.997	24.20	8.92	1.00	133	V	40.00	34.12	-5.88
84.002	24.10	8.09	1.12	130	V	40.00	33.31	-6.69
89.929	23.50	8.46	1.29	153	V	43.50	33.25	-10.25
119.997	20.80	11.40	1.49	140	V	43.50	33.69	-9.81
599.972	14.20	18.87	3.79	115	V	46.00	36.86	-9.14
623.976	14.60	19.29	3.89	148	V	46.00	37.78	-8.22
671.970	15.40	19.90	4.13	155	V	46.00	39.43	-6.57
695.972	12.40	20.07	4.27	280	V	46.00	36.74	-9.26

*Note :*

- 1. Remark "\*" means that the data is the worst emission level.*
- 2. All reading levels are Quasi-peak value.*
- 3. Measurement level = reading level + correct factor*

## Field Strength

### ◆Test Equipment

The following test equipment are used during the test:

Item	Equipment	Manufacturer	Model no/Serial No.	Last Cal.
ESCS30	EMI Receiver	Rohde & Schwarz	100373	Aug. 10, 2008
BICONILOG Antenna	VULB 9160	Schwarz beck	3047	Aug. 28, 2008

*Note :* All equipment upon which need to calibrated are with calibration period of 1 year.

### ◆Limits

The Field strength of the intentional radiator shall not exceed the following :

1. According to CFR 47, Part 15 Subpart C § 15.239(b) The field strength of any emissions within the permitted 200 kHz band shall not exceed 250 micro-volts/meter at 3 meters. The emission limit in this paragraph is based on measurement instrumentation employing an average detector. The provisions in Section 15.35 for limiting peak emissions apply.
2. The field strength of fundamental emissions shall comply with the following table

Frequency Band(MHz)	Fundamental Emissions Limit (dBuV/m) at 3m
90 MHz ~ 91.9	68 (Peak)
90 MHz ~ 91.9	48(Average)

### ◆Test Setup

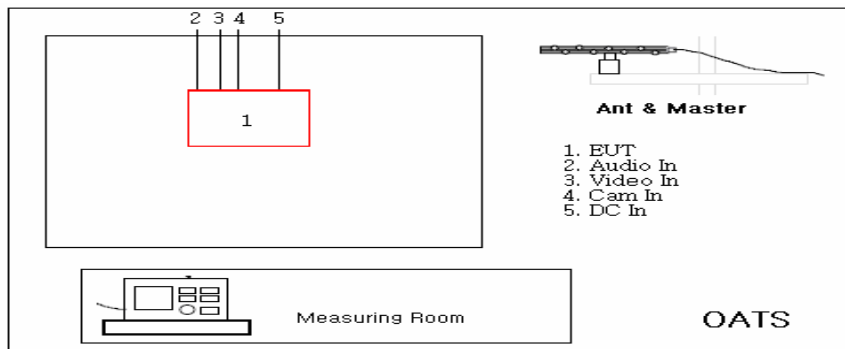

### ◆Test Procedure

1. Configure the EUT according to ANSI C63.4 The EUT was placed on the top of the turntable 0.8 meter above ground. The Phase center of the receiving antenna mounted on the top of a height-variable antenna mounted on the top of a height-variable antenna tower was placed 3 meters for away from the turntable.
2. Power on the EUT and all the supporting units. The Turntable was rotated by 360 degree to determine the position of the highest radiation.
3. The height of the broadband receiving antenna was varied between one meter and four meters above ground to find the maximum emissions field strength of both horizontal and vertical polarization.
4. For each suspected emission, the antenna tower was scan (from 1 M to 4 M) and then the turntable was rotated (from 0 degree to

360 degree) to find the maximum reading.

5. For Fundamental emissions, use the receiver to measure peak and average reading.

6. When the radiated emissions limits are expressed in terms of the average value of the emissions, and pulsed operation is employed, the measurement field strength shall be determined by averaging over one complete pulse train, including blanking intervals, as long as the pulse train does not exceed 0.1 seconds. As an alternative (provided the transmitter operates for longer than 0.1 seconds) or in case where the pulse train exceeds 0.1 seconds, the measured field strength shall be determined from the average absolute voltage during a 0.1 second interval during which the field strength is at its maximum value.

### Field Strength Test result

Product	BDT-7000N
Test Item	Field Strength
Test Mode	Continuously transmitting mode
Test Site	OATS

Freq. (MHz)	Reading (dBuV/m)	Ant. Factor (dBuV/m)	Cable Loss (dB)	Ant. Height (cm)	Pol. (H/V)	Limits (dBuV/m)	Result (dB)	Margin (dB)	Detect Mode
90.000	23.80	8.47	1.30	310	H	68.00	33.57	-34.43	Peak
90.000	23.10	8.47	1.30	310	H	48.00	32.87	-15.13	Average
90.000	27.20	8.47	1.30	115	V	68.00	36.97	-31.03	Peak
90.000	26.70	8.47	1.30	115	V	48.00	36.47	-11.53	Average
91.000	24.00	8.54	1.29	311	H	68.00	33.83	-34.17	Peak
91.000	23.40	8.54	1.29	311	H	48.00	33.23	-14.77	Average
91.000	27.60	8.54	1.29	120	V	68.00	37.43	-30.57	Peak
91.000	27.10	8.54	1.29	120	V	48.00	36.93	-11.07	Average
91.900	24.70	8.60	1.28	312	H	68.00	34.58	-33.42	Peak
91.900	24.20	8.60	1.28	312	H	48.00	34.08	-13.92	Average
91.900	28.10	8.60	1.28	100	V	68.00	37.98	-30.02	Peak
91.900	27.60	8.60	1.28	100	V	48.00	37.48	-10.52	Average

*Note : 1. Measurement level = reading level + correct factor*

## 20 dB Spectrum Bandwidth

### ◆TEST Equipment

The following test equipment was used during the test:

Item	Equipment	Manufacturer	Model no/Serial No.	Last Cal.
SPECTRUM ANALYZER	R3273	ADVANTEST	MY42000092	Oct. 01, 2008

Note : All equipment upon which need to calibrated are with calibration period of 1 year.

### ◆Limits

According to CFR 47, Part 15 Subpart C § 15.239(a) Emissions from the intentional radiator shall be confined within a band 200 kHz wide centered on the operation frequency. The 200 kHz band shall lie wholly within the frequency range of 88-108 MHz.

### ◆Test setup

RF Conducted Measurement:

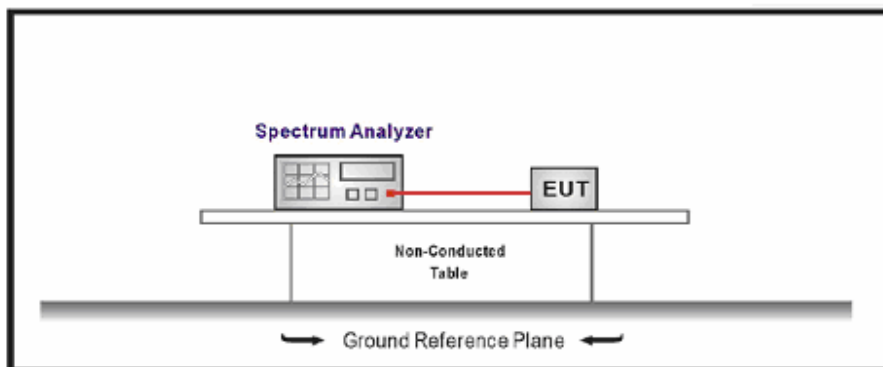

### ◆Test procedure

1. The transmitter output is connected to the Spectrum analyzer in peak hold mode.
2. For bandwidth test, start FM transmitting function with MP3 format music of audio file.
3. Measured the spectrum width with power higher than 20dB below carrier.

## 20 dB Spectrum Bandwidth Test result

Product	BDT-7000N
Test Item	20 dB Spectrum bandwidth
Test Mode	Continuously transmitting mode with playing music
Test Site	RF Test room

Frequency(MHz)	Measured Value(kHz)	Limit (kHz)	Margin (kHz)
90.0	169.8	200	-30.2
91.0	127.8		-72.2
91.9	130.2		-69.8

1. 90.0 MHz



2. 91.0 MHz

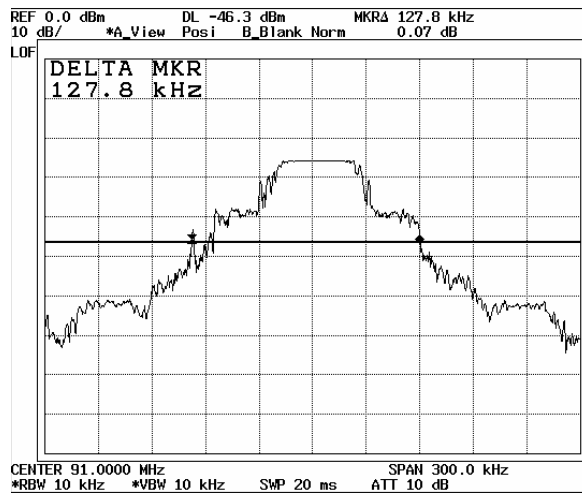

3. 91.9 MHz



## Tuning Range of FM Transmitter Measure

### ◆Test Equipment

The following test equipment are used during the test:

Item	Equipment	Manufacturer	Model no/Serial No.	Last Cal.
SPECTRUM ANALYZER	R3273	ADVANTEST	MY42000092	Oct. 01, 2008

*Note :* All equipment upon which need to calibrated are with calibration period of 1 year.

### ◆Limits

According to CFR 47, Part 15 Subpart C § 15.239(a) Emissions from the intentional radiator shall be confined within a band 200 kHz wide centered on the operation frequency. The 200 kHz band shall lie wholly within the frequency range of 88-108 MHz.

### ◆Test Setup

RF Conducted Measurement:

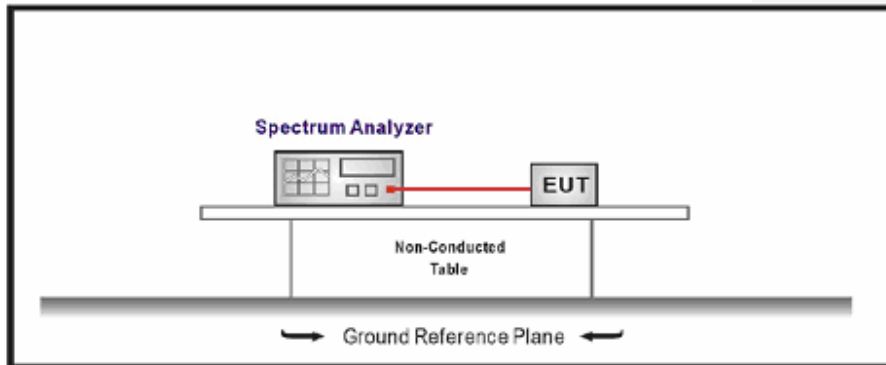

### ◆Test Procedure

The transmitter output is connected to the Spectrum analyzer.

The lowest and highest frequency was adjusted by manual using up/down button and the spectrum was in max hold mode for capturing the spectrum.

## Tuning Range of FM Transmitter Test result

<b>Product</b>	BDT-7000N
<b>Test Item</b>	Tuning range of FM transmitter
<b>Test Mode</b>	Continuously transmitting mode
<b>Test Site</b>	RF Test room

### 1. Low Frequency

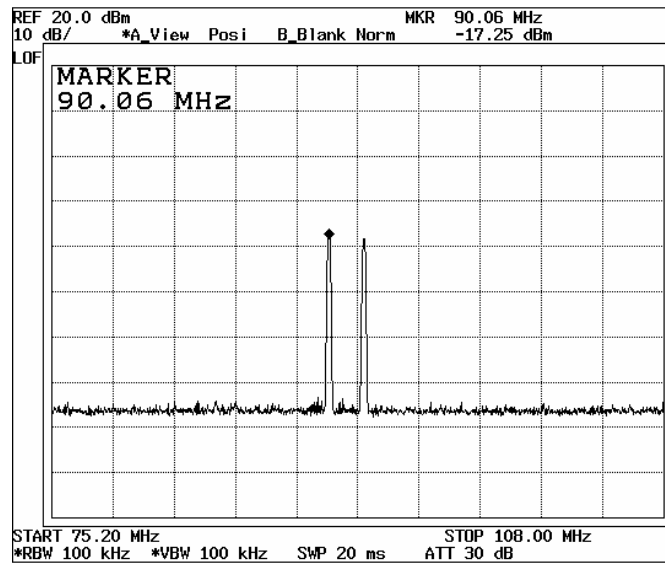

### 2. High Frequency

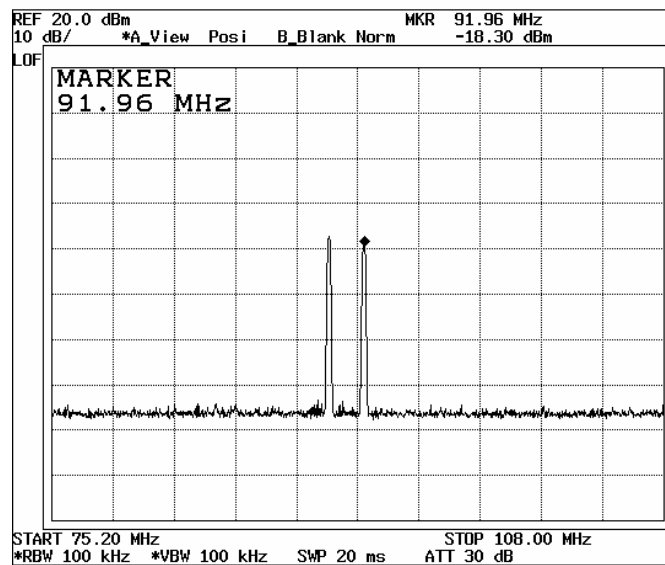



**Appendix A. The Photos of Test Setup**

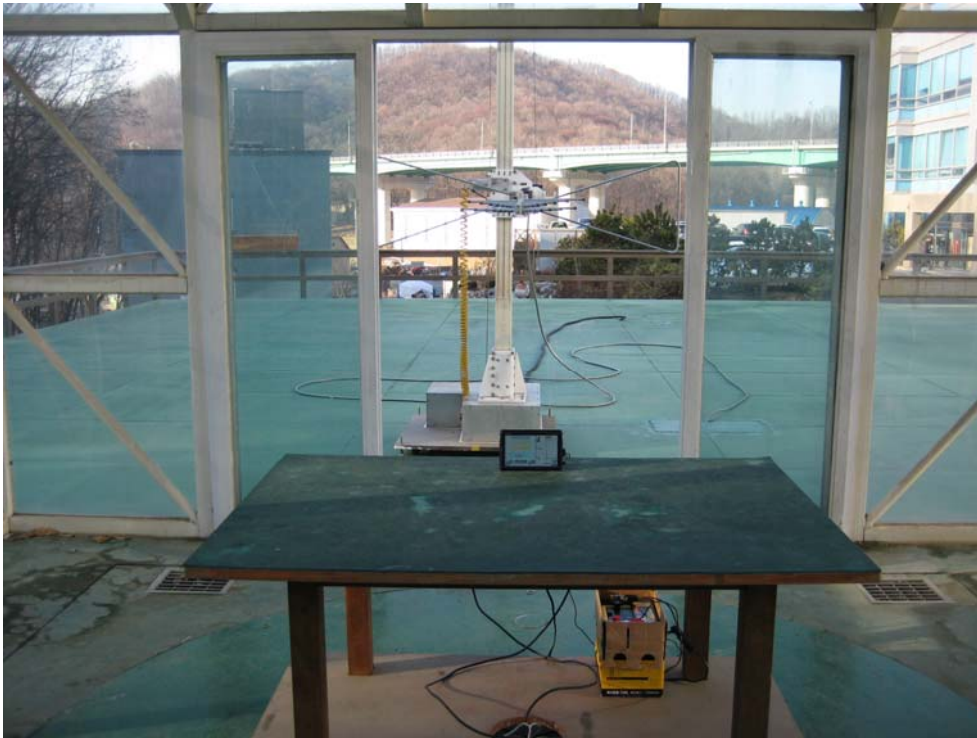

**Radiated Emissions Front view – Using Navigation Mode**

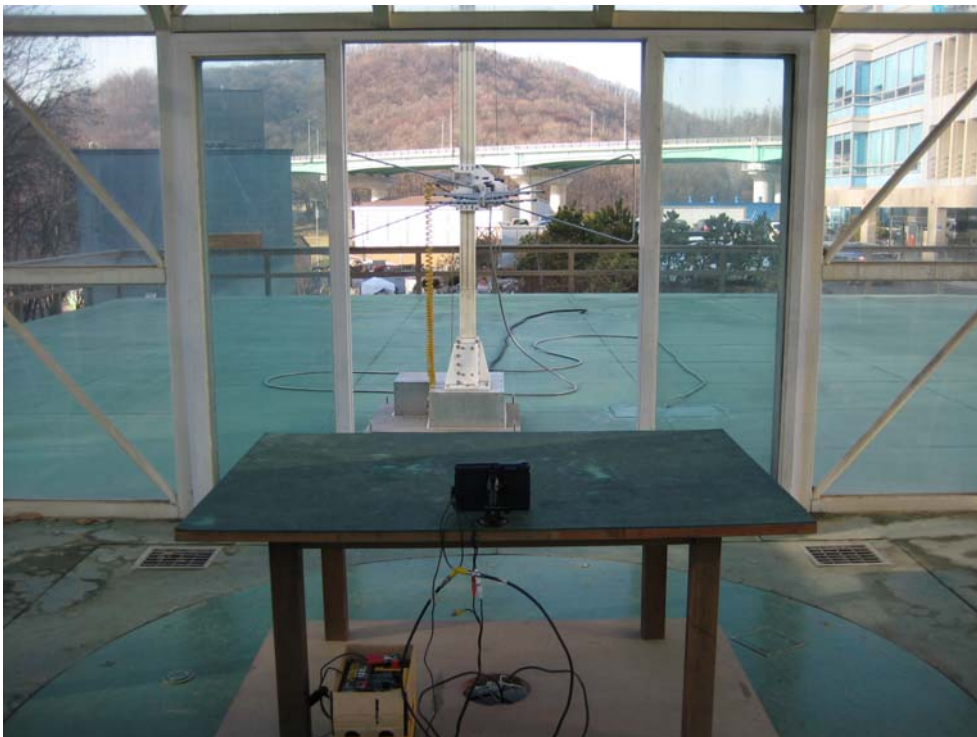

**Radiated Emissions rear view – Using Navigation Mode**

**Appendix A. The Photos of Test Setup**

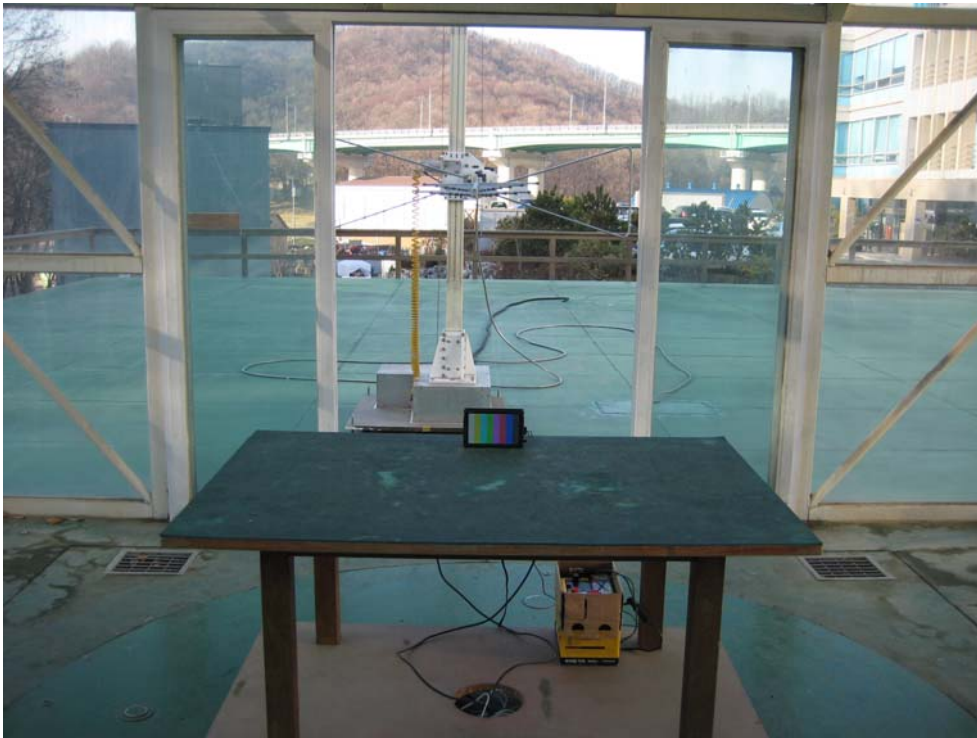

**Radiated Emissions Front view – Using Audio/Video Mode**

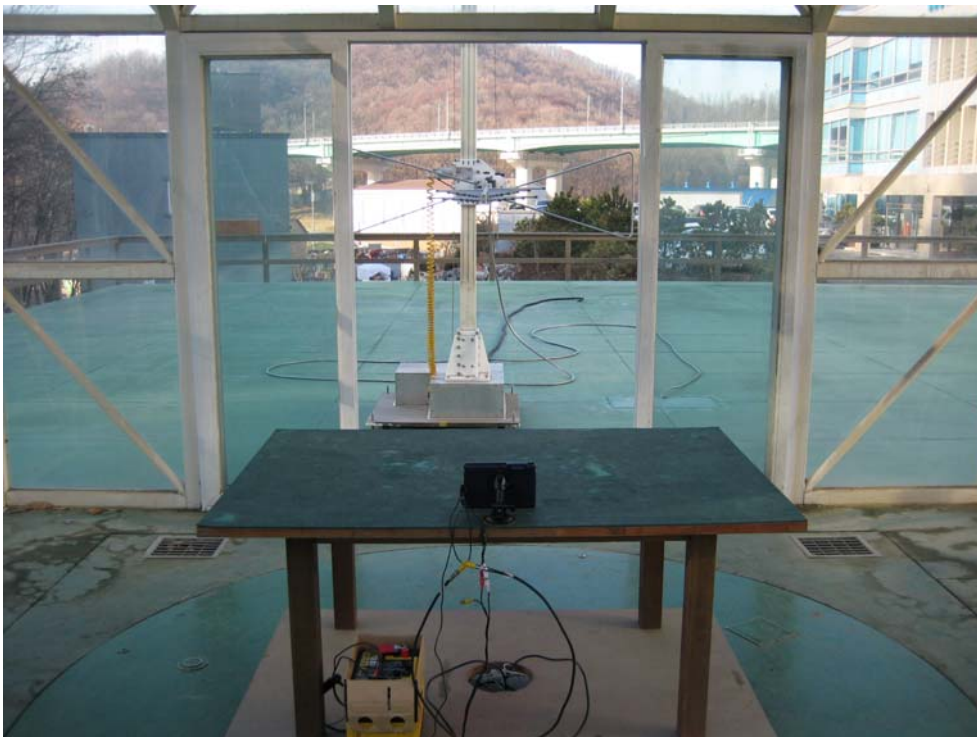

**Radiated Emissions rear view - Using Audio/Video Mode**



**Appendix A. The Photos of Test Setup**

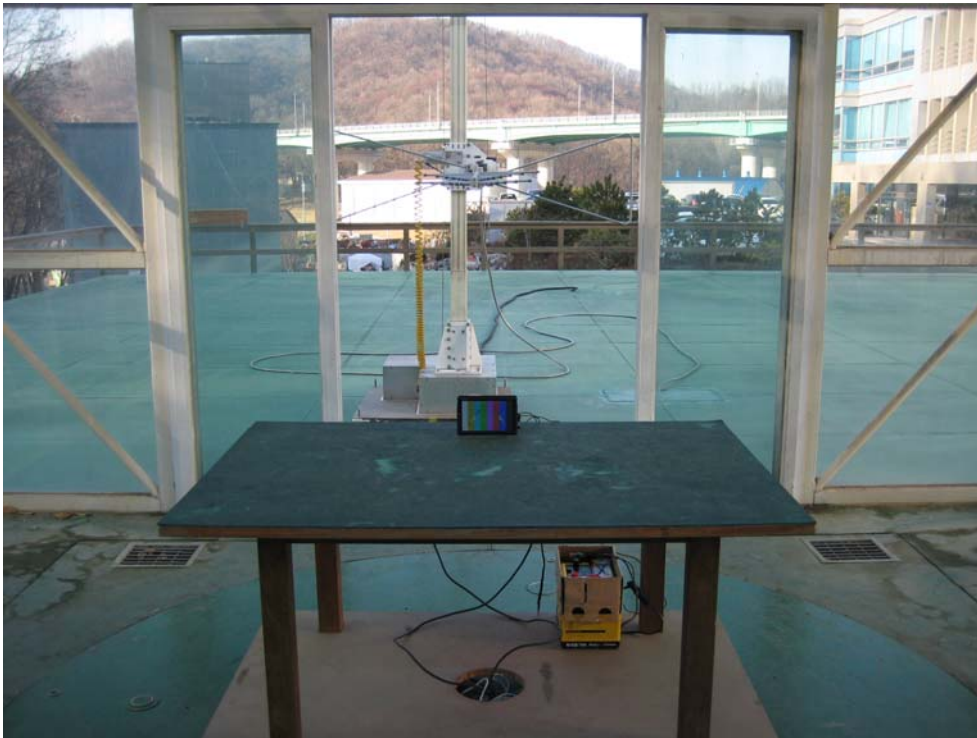

**Radiated Emissions Front view – Using Cam Mode**

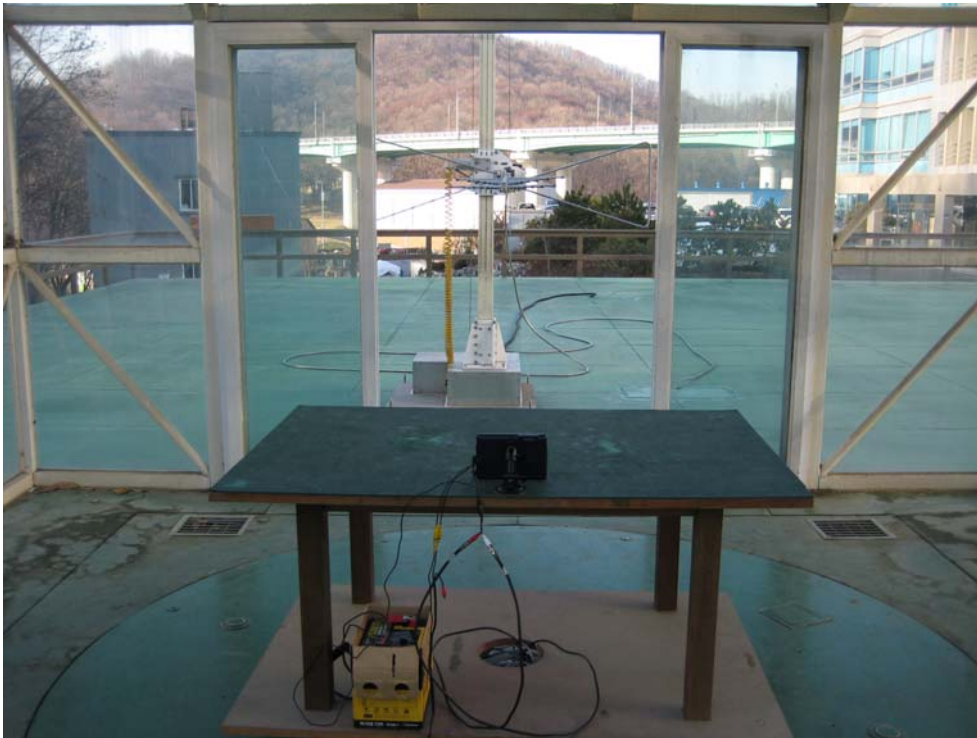

**Radiated Emissions rear view - Using Cam Mode**

**Appendix A. The Photos of Test Setup**



**Radiated Emissions Front view – Using FMT Mode**

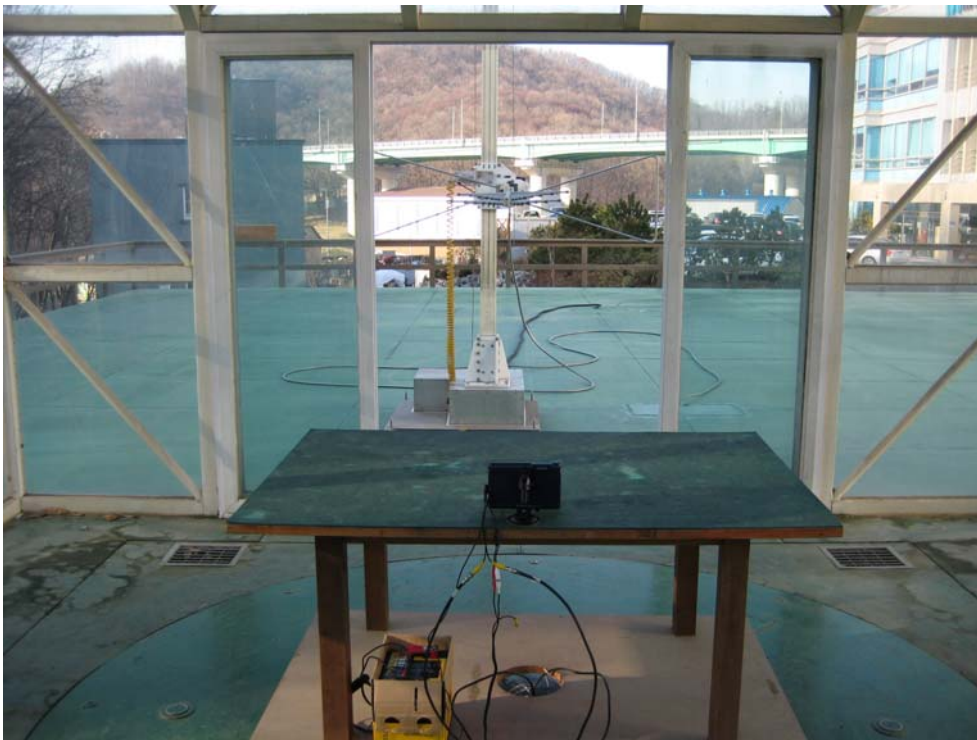

**Radiated Emissions rear view - Using FMT Mode**



**Appendix A. The Photos of Test Setup**

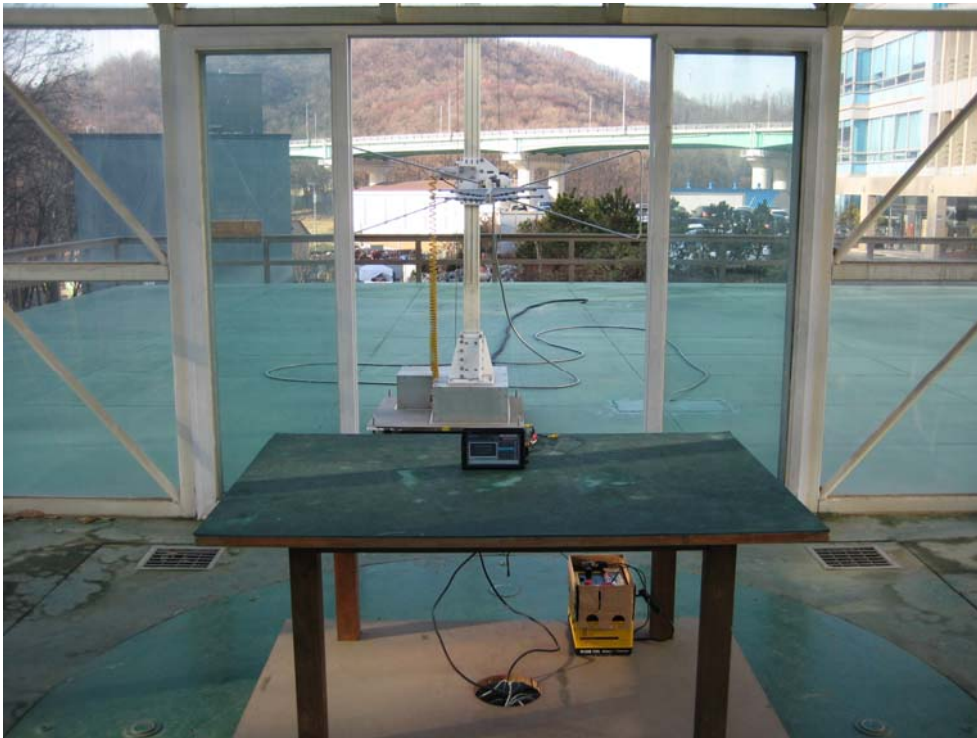

**Radiated Emissions Front view – Using FMT Mode**

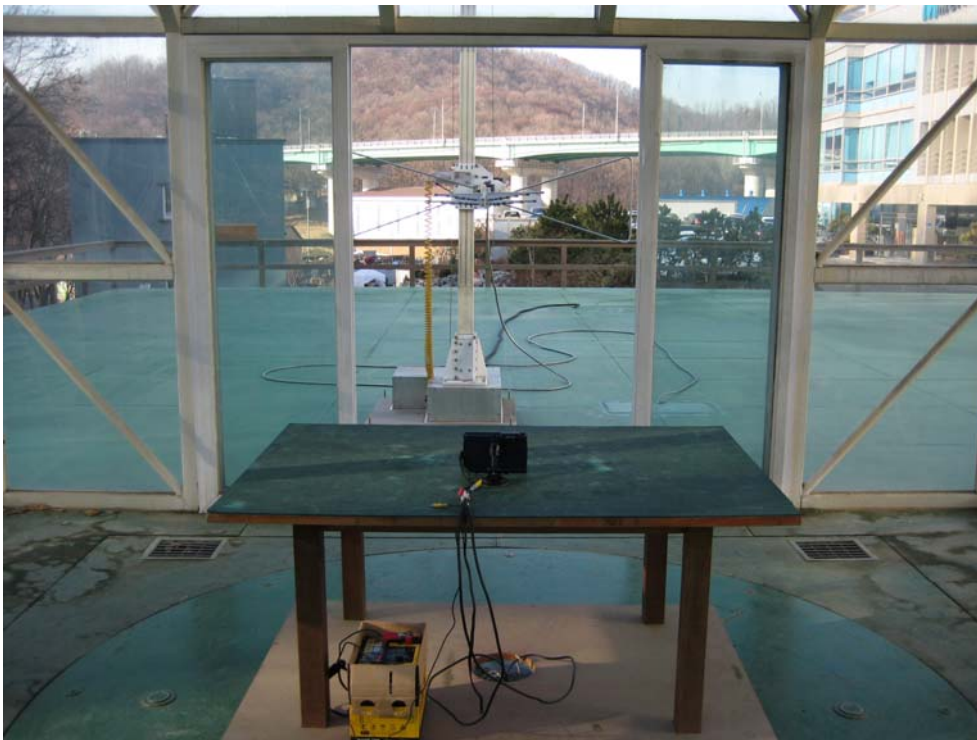

**Radiated Emissions rear view - Using FMT Mode**

Appendix B. The Photos of Equipment Under Test



Front view



Rear view