

# FCC Test Report

**Client Name** : Iton Technology Corp.

---

**Client Address** : 7 Floor East, Building C, Shenzhen  
International Innovation Center, No.1006  
Shennan Rd. Futian Dist, Shenzhen, China

---

**Product Name** : TGW206-16

---

**Report Date** : Feb. 08, 2023

---

**Shenzhen Anbotek Compliance Laboratory Limited**



# Contents

1. General Information .....	6
1.1. Client Information .....	6
1.2. Description of Device (EUT) .....	6
1.3. Auxiliary Equipment Used During Test .....	7
1.4. Description of Test Configuration .....	7
1.5. Description Of Test Setup .....	8
1.6. Test Equipment List .....	9
1.7. Measurement Uncertainty .....	10
1.8. Description of Test Facility .....	10
2. Summary of Test Results .....	11
3. Conducted Emission Test .....	12
3.1. Test Standard and Limit .....	12
3.2. Test Setup .....	12
3.3. Test Procedure .....	12
3.4. Test Data .....	12
4. Radiation Spurious Emission and Band Edge .....	15
4.1. Test Standard and Limit .....	15
4.2. Test Setup .....	15
4.3. Test Procedure .....	16
4.4. Test Data .....	17
5. Maximum Peak Output Power Test .....	25
5.1. Test Standard and Limit .....	25
5.2. Test Setup .....	25
5.3. Test Procedure .....	25
5.4. Test Data .....	25
6. 6DB Occupy Bandwidth Test .....	26
6.1. Test Standard and Limit .....	26
6.2. Test Setup .....	26
6.3. Test Procedure .....	26
6.4. Test Data .....	26
7. Power Spectral Density Test .....	27
7.1. Test Standard and Limit .....	27
7.2. Test Setup .....	27
7.3. Test Procedure .....	27
7.4. Test Data .....	27
8. 100kHz Bandwidth of Frequency Band Edge Requirement .....	28



8.1. Test Standard and Limit .....	28
8.2. Test Setup .....	28
8.3. Test Procedure .....	28
8.4. Test Data .....	28
9. Antenna Requirement .....	29
9.1. Test Standard and Requirement .....	29
9.2. Antenna Connected Construction .....	29
APPENDIX I -- TEST SETUP PHOTOGRAPH .....	30
APPENDIX II -- EXTERNAL PHOTOGRAPH .....	30
APPENDIX III -- INTERNAL PHOTOGRAPH .....	30





# TEST REPORT

Applicant : Iton Technology Corp.

Manufacturer : Iton Technology Corp.

Product Name : TGW206-16

Model No. : TGW206-16

Trade Mark : N.A

Rating(s) : Input: 3.3V==

**Test Standard(s) : FCC Part15 Subpart C, Section 15.247**

**Test Method(s) : ANSI C63.10: 2020, KDB558074 D01 DTS Meas Guidance v05r02**

The device described above is tested by Shenzhen Anbotek Compliance Laboratory Limited to determine the maximum emission levels emanating from the device and the severe levels of the device can endure and its performance criterion. The measurement results are contained in this test report and Shenzhen Anbotek Compliance Laboratory Limited is assumed full of responsibility for the accuracy and completeness of these measurements. Also, this report shows that the EUT (Equipment Under Test) is technically compliant with the FCC Part 15 Subpart C requirements.

This report applies to above tested sample only and shall not be reproduced in part without written approval of Shenzhen Anbotek Compliance Laboratory Limited.

Date of Receipt

Aug. 16, 2022

Date of Test

Aug. 16~29, 2022

Prepared By

*Tu Tu Hong*

(TuTu Hong)

Approved & Authorized Signer

*Kingkong Jin*

(Kingkong Jin)



**Revision History**

Report Version	Description	Issued Date
R00	Original Issue.	Feb. 08, 2023



## 1. General Information

### 1.1. Client Information

Applicant	:	Iton Technology Corp.
Address	:	7 Floor East, Building C, Shenzhen International Innovation Center, No.1006 Shennan Rd. Futian Dist, Shenzhen, China
Manufacturer	:	Iton Technology Corp.
Address	:	7th Floor, Building C, Shenzhen International Innovation Center (Futian Science and Technology Plaza), 1006 Shennan Road, Huafu Street, Futian District, Shenzhen City, Guangdong Province, China
Factory	:	Iton Technology Corp., Longgang Branch
Address	:	2~3 Floor, East Wing, Building A, Weixinda Technology Park, No.95 Ainan Road, Longgang District, Shenzhen City, Guangdong Province, China.

### 1.2. Description of Device (EUT)

Product Name	:	TGW206-16
Model No.	:	TGW206-16
Trade Mark	:	N.A
Test Power Supply	:	DC 3.3V for PC
Test Sample No.	:	1-2-1(Normal Sample), 1-2-2(Engineering Sample)
Adapter	:	N/A
<b>RF Specification</b>		
Operation Mode	:	<input checked="" type="checkbox"/> BT BLE
Support Rate	:	<input checked="" type="checkbox"/> 1Mbps <input type="checkbox"/> 2Mbps
Operation Frequency	:	2402~2480MHz
Number of Channel	:	40 Channels
Modulation Type	:	GFSK
Antenna Type	:	PCB antenna
Antenna Gain(Peak)	:	2.05 dBi (Provided by customer)
<b>Remark:</b> 1) For a more detailed features description, please refer to the manufacturer's specifications or the User's Manual.		





### 1.3. Auxiliary Equipment Used During Test

Description	Rating(s)
AppleMacBook	Model: A1708 Input: 20.3V/3A CMIIT ID:2016AJ5746
Adapter	Input: AC 100-240V, 1.5A, 50-60Hz Output: 20.3V/3A (USB PD) or 9V/3A(USB PD) or 5.2V/2.4A

### 1.4. Description of Test Configuration

Channel	Freq. (MHz)	Channel	Freq. (MHz)	Channel	Freq. (MHz)	Channel	Freq. (MHz)	Channel	Freq. (MHz)
<b>00</b>	<b>2402</b>	09	2420	18	2438	27	2456	36	2474
01	2404	10	2422	<b>19</b>	<b>2440</b>	28	2458	37	2476
02	2406	11	2424	20	2442	29	2460	38	2478
03	2408	12	2426	21	2444	30	2462	<b>39</b>	<b>2480</b>
04	2410	13	2428	22	2446	31	2464		
05	2412	14	2430	23	2448	32	2466		
06	2414	15	2432	24	2450	33	2468		
07	2416	16	2434	25	2452	34	2470		
08	2418	17	2436	26	2454	35	2472		

Note:

1. The engineering test program was provided and the EUT was programmed to be in continuously transmitting mode.
2. EUT was tested with channel 0, 19 and 39.



## 1.5. Description Of Test Setup

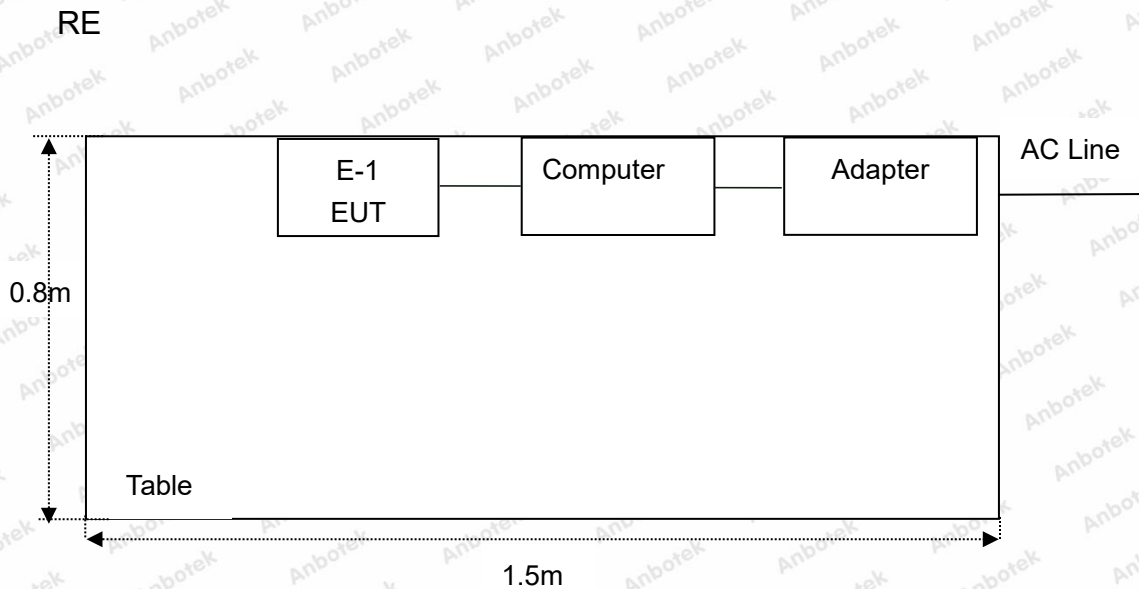
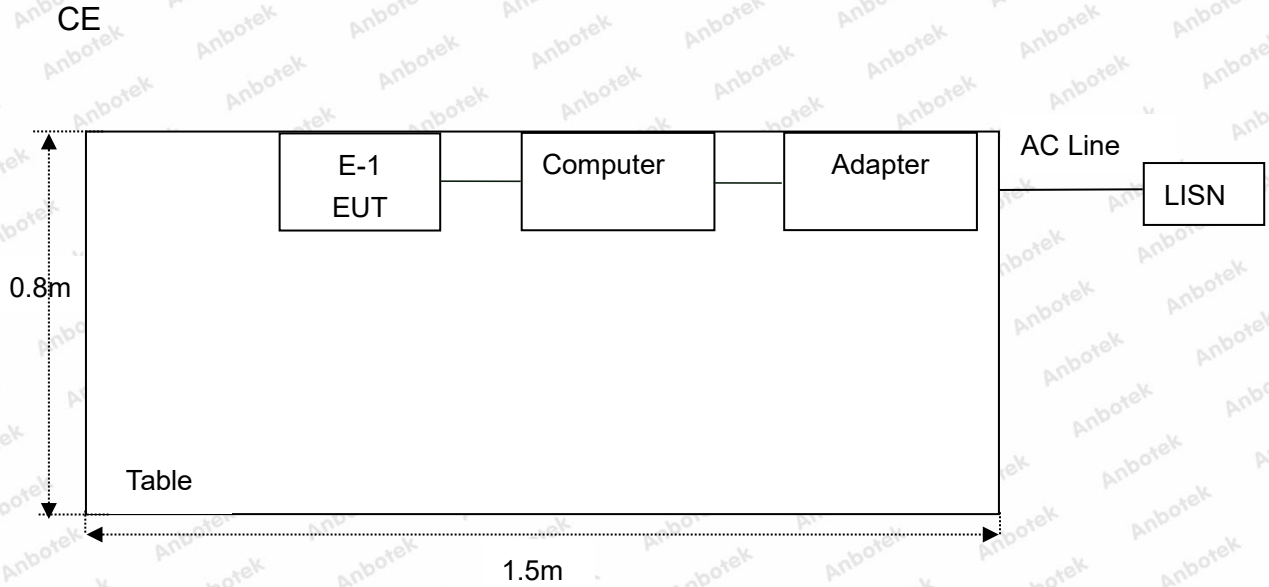



## 1.6. Test Equipment List

Item	Equipment	Manufacturer	Model No.	Serial No.	Last Cal.	Cal. Interval
1.	L.I.S.N. Artificial Mains Network	Rohde & Schwarz	ENV216	100055	Oct. 22, 2021	1 Year
2.	Three Phase V-type Artificial Power Network	CYBERTEK	EM5040DT	E215040DT001	Jul 05, 2022	1 Year
3.	EMI Test Receiver	Rohde & Schwarz	ESCI	100627	Oct. 22, 2021	1 Year
4.	EMI Test Receiver	Rohde & Schwarz	ESR26	101481	Oct. 22, 2021	1 Year
5.	RF Switching Unit	Compliance Direction	RSU-M2	38303	Oct. 22, 2021	1 Year
6.	MAX Spectrum Analysis	Agilent	N9020A	MY51170037	Oct. 22, 2021	1 Year
7.	Preamplifier	SKET Electronic	BK1G18G30D	KD17503	Oct. 22, 2021	1 Year
8.	Double Ridged Horn Antenna	Instruments corporation	GTH-0118	351600	Oct. 22, 2021	2 Year
9.	Bilog Broadband Antenna	Schwarzbeck	VULB9163	VULB 9163-289	Oct. 22, 2021	2 Year
10.	Loop Antenna	Schwarzbeck	FMZB1519B	00053	Oct. 22, 2021	2 Year
11.	Horn Antenna	A-INFO	LB-180400-KF	J211060628	Oct. 22, 2021	2 Year
12.	Pre-amplifier	SONOMA	310N	186860	Oct. 22, 2021	1 Year
13.	EMI Test Software EZ-EMC	SHURPLE	N/A	N/A	N/A	N/A
14.	RF Test Control System	YIHENG	YH3000	2017430	Oct. 22, 2021	1 Year
15.	Power Sensor	DAER	RPR3006W	15I00041SN045	Oct. 22, 2021	1 Year
16.	Power Sensor	DAER	RPR3006W	15I00041SN046	Oct. 22, 2021	1 Year
17.	MXA Spectrum Analysis	KEYSIGHT	N9020A	MY53280032	Oct. 22, 2021	1 Year
18.	MXG RF Vector Signal Generator	Agilent	N5182A	MY48180656	Oct. 22, 2021	1 Year
19.	Signal Generator	Agilent	E4421B	MY41000743	Oct. 22, 2021	1 Year
20.	DC Power Supply	IVYTECH	IV3605	1804D360510	Oct. 22, 2021	1 Year
21.	Constant Temperature Humidity Chamber	ZHONGJIAN	ZJ-KHWS80B	N/A	Oct. 22, 2021	1 Year



### 1.7. Measurement Uncertainty

Radiation Uncertainty	:	Ur = 3.9 dB (Horizontal)
	:	Ur = 3.8 dB (Vertical)
Conduction Uncertainty	:	Uc = 3.4 dB

### 1.8. Description of Test Facility

The test facility is recognized, certified, or accredited by the following organizations:

#### FCC-Registration No.: 184111

Shenzhen Anbotek Compliance Laboratory Limited, EMC Laboratory has been registered and fully described in a report filed with the (FCC) Federal Communications Commission. The acceptance letter from the FCC is maintained in our files. Registration No. 184111.

#### ISED-Registration No.: 8058A

Shenzhen Anbotek Compliance Laboratory Limited, EMC Laboratory has been registered and fully described in a report filed with the (ISED) Innovation, Science and Economic Development Canada. The acceptance letter from the ISED is maintained in our files. Registration 8058A.

#### Test Location

Shenzhen Anbotek Compliance Laboratory Limited.

1/F, Building D, Sogood Science and Technology Park, Sanwei community, Hangcheng Street, Bao'an District, Shenzhen, Guangdong, China.518102



## 2. Summary of Test Results

Standard Section	Test Item	Result
15.203/15.247(c)	Antenna Requirement	PASS
15.207	Conducted Emission	PASS
15.205/15.209	Spurious Emission	PASS
15.247(b)(3)	Conducted Peak Output Power	PASS
15.247(a)(2)	6dB Occupied Bandwidth	PASS
15.247(e)	Power Spectral Density	PASS
15.247(d)	Band Edge	PASS
<b>Remark:</b> "N/A" is an abbreviation for Not Applicable.		





## 3. Conducted Emission Test

### 3.1. Test Standard and Limit

Test Standard	FCC Part15 Section 15.207		
Test Limit	Frequency	Maximum RF Line Voltage (dBuV)	
		Quasi-peak Level	Average Level
	150kHz~500kHz	66 ~ 56 *	56 ~ 46 *
	500kHz~5MHz	56	46
5MHz~30MHz	60	50	

**Remark:**(1) \*Decreasing linearly with logarithm of the frequency.  
 (2) The lower limit shall apply at the transition frequency.

### 3.2. Test Setup

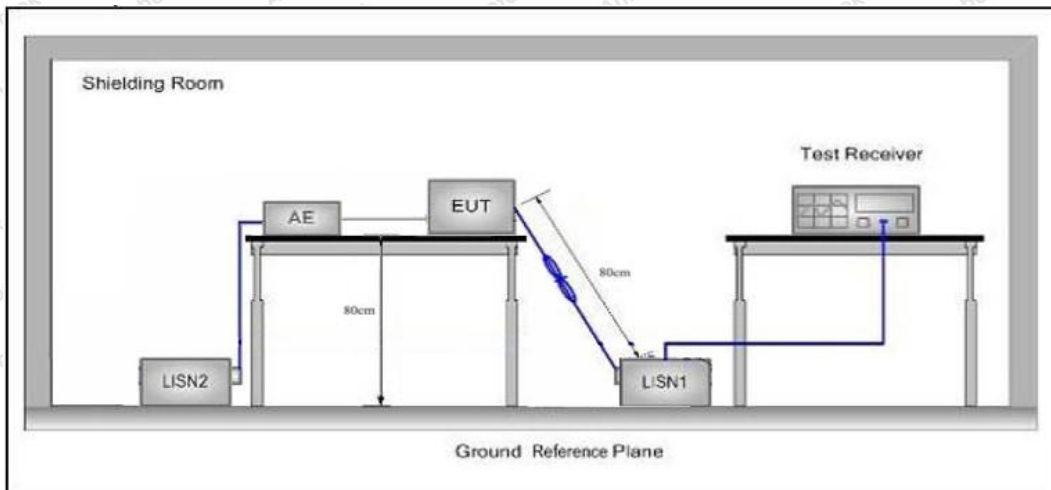

### 3.3. Test Procedure

The EUT system is connected to the power mains through a line impedance stabilization network (L.I.S.N.). This provides a 50ohm coupling impedance for the EUT system. Please refer the block diagram of the test setup and photographs. Both sides of AC line are checked to find out the maximum conducted emission. In order to find the maximum emission levels, the relative positions of equipment and all of the interface cables shall be changed according to FCC ANSI C63.10: 2020 on Conducted Emission Measurement.

The bandwidth of test receiver (ESCI) set at 9kHz.

The frequency range from 150kHz to 30MHz is checked.

### 3.4. Test Data

During the test, pre-scan all modes, only the worst case is recorded in the report.

AC conducted emission pre-test at both at AC 120V/60Hz and AC 240V/60Hz modes, recorded worst case AC 120V/60Hz.

Please to see the following pages.



### Conducted Emission Test Data

Test Site: 1# Shielded Room  
 Operating Condition: High CH (2480MHz)  
 Test Specification: DC 3.3V for PC  
 Comment: Live Line  
 Temp.(°C)/Hum.(%RH): 22.1°C/52%RH

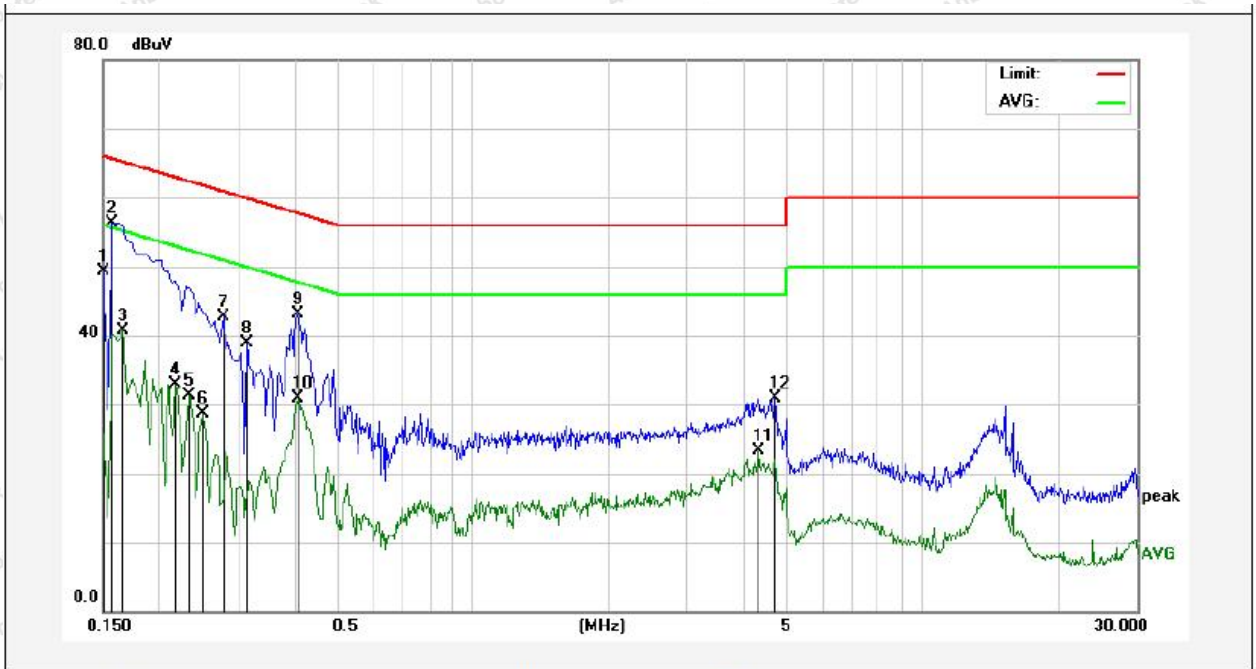

No.	Freq. (MHz)	Reading (dBuV)	Factor (dB)	Result (dBuV)	Limit (dBuV)	Over Limit (dB)	Detector	Remark
1	0.1500	39.66	9.69	49.35	65.99	-16.64	QP	
2	0.1580	46.60	9.70	56.30	65.56	-9.26	QP	
3	0.1660	31.06	9.70	40.76	55.15	-14.39	AVG	
4	0.2180	23.24	9.71	32.95	52.89	-19.94	AVG	
5	0.2340	21.54	9.71	31.25	52.30	-21.05	AVG	
6	0.2500	18.92	9.71	28.63	51.75	-23.12	AVG	
7	0.2779	33.02	9.72	42.74	60.88	-18.14	QP	
8	0.3140	29.16	9.73	38.89	59.86	-20.97	QP	
9	0.4100	33.33	9.71	43.04	57.65	-14.61	QP	
10	0.4100	21.25	9.71	30.96	47.65	-16.69	AVG	
11	4.3300	13.55	9.73	23.28	46.00	-22.72	AVG	
12	4.7180	21.24	9.74	30.98	56.00	-25.02	QP	





### Conducted Emission Test Data

Test Site: 1# Shielded Room  
 Operating Condition: High CH (2480MHz)  
 Test Specification: DC 3.3V for PC  
 Comment: Neutral Line  
 Temp.(°C)/Hum.(%RH): 22.1°C/52%RH

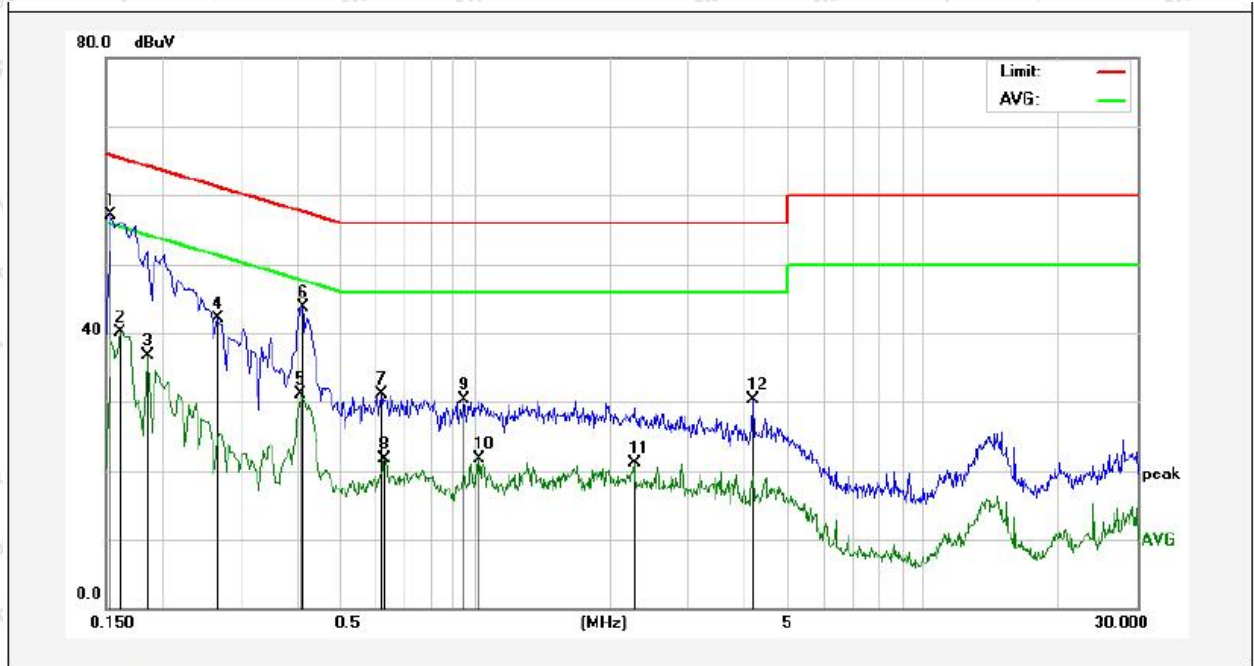

No.	Freq. (MHz)	Reading (dBuV)	Factor (dB)	Result (dBuV)	Limit (dBuV)	Over Limit (dB)	Detector	Remark
1	0.1539	47.46	9.70	57.16	65.78	-8.62	QP	
2	0.1620	30.47	9.70	40.17	55.36	-15.19	AVG	
3	0.1860	27.07	9.71	36.78	54.21	-17.43	AVG	
4	0.2660	32.42	9.72	42.14	61.24	-19.10	QP	
5	0.4100	21.37	9.71	31.08	47.65	-16.57	AVG	
6	0.4140	33.90	9.72	43.62	57.57	-13.95	QP	
7	0.6180	21.29	9.76	31.05	56.00	-24.95	QP	
8	0.6300	11.94	9.75	21.69	46.00	-24.31	AVG	
9	0.9460	20.58	9.74	30.32	56.00	-25.68	QP	
10	1.0260	11.87	9.74	21.61	46.00	-24.39	AVG	
11	2.2620	11.46	9.72	21.18	46.00	-24.82	AVG	
12	4.1700	20.61	9.73	30.34	56.00	-25.66	QP	





## 4. Radiation Spurious Emission and Band Edge

### 4.1. Test Standard and Limit

Test Standard	FCC Part15 C Section 15.209 and 15.205				
Test Limit	Frequency (MHz)	Field strength (microvolt/meter)	Limit (dBuV/m)	Remark	Measurement distance (m)
	0.009MHz~0.490MHz	2400/F(kHz)	-	-	300
	0.490MHz-1.705MHz	24000/F(kHz)	-	-	30
	1.705MHz-30MHz	30	-	-	30
	30MHz~88MHz	100	40.0	Quasi-peak	3
	88MHz~216MHz	150	43.5	Quasi-peak	3
	216MHz~960MHz	200	46.0	Quasi-peak	3
	960MHz~1000MHz	500	54.0	Quasi-peak	3
	Above 1000MHz	500	54.0	Average	3
-		74.0	Peak	3	

**Remark:**

(1)The lower limit shall apply at the transition frequency.

(2) 15.35(b), Unless otherwise specified, the limit on peak radio frequency emissions is 20dB above the maximum permitted average emission limit applicable to the equipment under test. This peak limit applies to the total peak emission level radiated by the device.

### 4.2. Test Setup

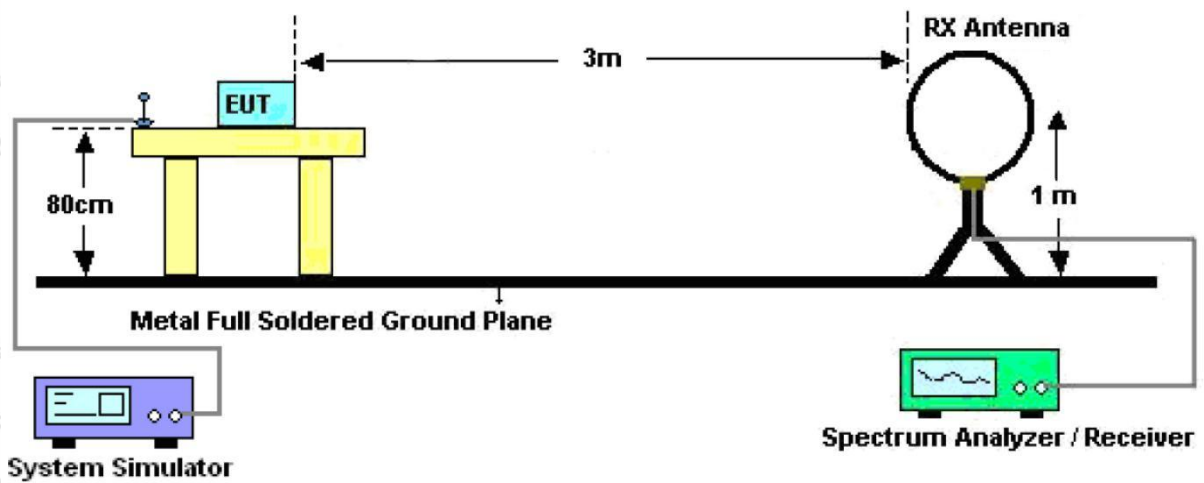

Figure 1. Below 30MHz



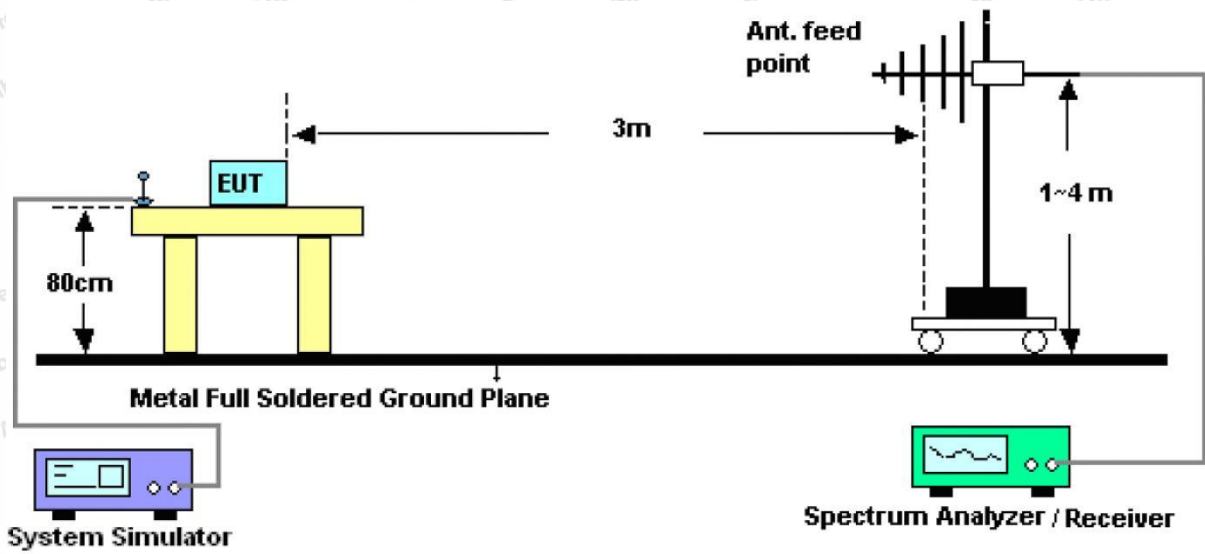

Figure 2. 30MHz to 1GHz

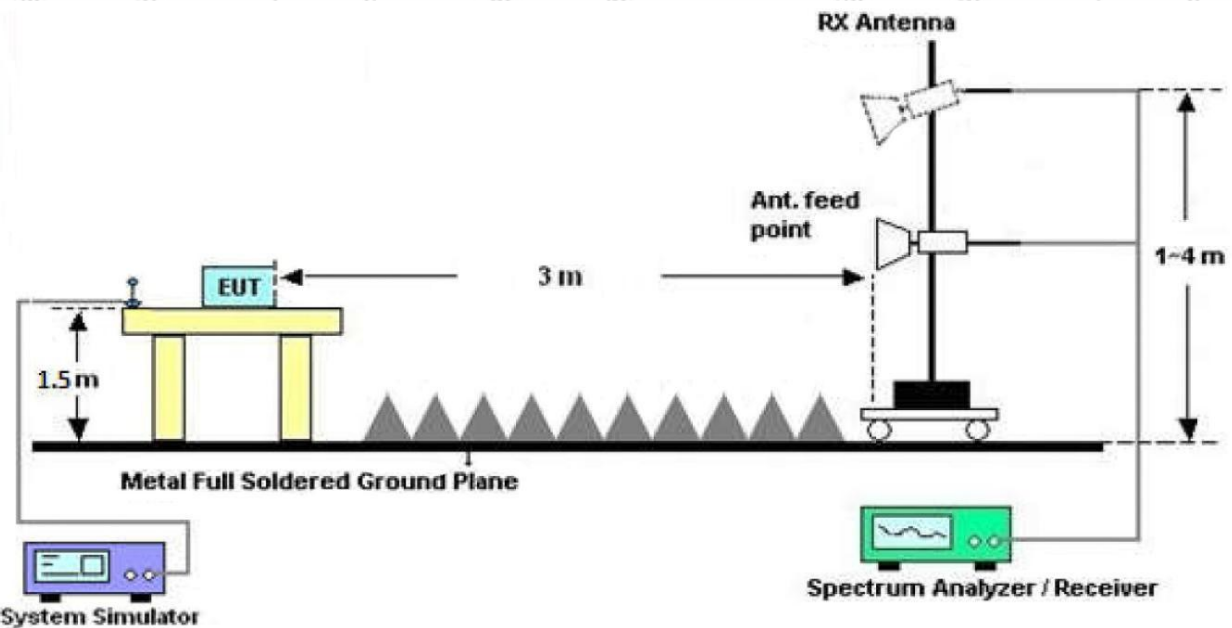

Figure 3. Above 1 GHz

### 4.3. Test Procedure

For below 1GHz: The EUT is placed on a turntable, which is 0.8m above the ground plane.

For above 1GHz: The EUT is placed on a turntable, which is 1.5m above the ground plane.

The turn table can rotate 360 degrees to determine the position of the maximum emission level. The EUT is set 3 meters away from the receiving antenna which is mounted on a antenna tower. The antenna can be moved up and down from 1 to 4 meters to find out the maximum emission level. Rotated the EUT through three orthogonal axes to determine the maximum emissions, both horizontal and vertical polarization of the antenna are set on test. The EUT is tested in 9\*6\*6 Chamber. The device is evaluated in xyz orientation.



For the radiated emission test above 1GHz:

Place the measurement antenna away from each area of the EUT determined to be a source of emissions at the specified measurement distance, while keeping the measurement antenna aimed at the source of emissions at each frequency of significant emissions, with polarization oriented for maximum response. The measurement antenna may have to be higher or lower than the EUT, depending on the radiation pattern of the emission and staying aimed at the emission source for receiving the maximum signal. The final measurement antenna elevation shall be that which maximizes the emissions. The measurement antenna elevation for maximum emissions shall be restricted to a range of heights of from 1 m to 4 m above the ground or reference ground plane.

For 9kHz to 150kHz, Set the spectrum analyzer as:

RBW = 200Hz, VBW = 1kHz, Detector= Quasi-Peak, Trace mode= Max hold, Sweep- auto couple.

For 150kHz to 30MHz, Set the spectrum analyzer as:

RBW = 9KHz, VBW = 30kHz, Detector= Quasi-Peak, Trace mode= Max hold, Sweep- auto couple.

For 30MHz to 1000MHz, Set the spectrum analyzer as:

RBW = 100kHz, VBW = 300kHz, Detector= Quasi-Peak, Trace mode= Max hold, Sweep- auto couple.

For above 1GHz, Set the spectrum analyzer as:

RBW = 1MHz, VBW = 1MHz, Detector= Peak, Trace mode= Max hold, Sweep- auto couple.

For average measurement:

–VBW=10Hz, When duty cycle is no less than 98 percent

–VBW  $\geq 1/T$ , when duty cycle is less than 98 percent where T is the minimum transmission duration over which the transmitter is on and is transmitting at its maximum power control level for the tested mode of operation, so refer to this clause 5.4 duty cycle.

#### 4.4. Test Data

##### PASS

During the test, Pre-scan all kind of the place mode (X-axis, Y-axis, Z-axis), and found the X-axis is the worst case.

The test results of 9kHz-30MHz was attenuated more than 20dB below the permissible limits, so the results don't record in the report.

During the test, pre-scan all modes, only the worst case is recorded in the report.





**Test Results (30~1000MHz)**

Test Mode: High CH (2480MHz)  
 Power Source: DC 3.3V for PC  
 Polarization: Horizontal  
 Temp.(°C)/Hum.(%RH): 24.2°C/50%RH

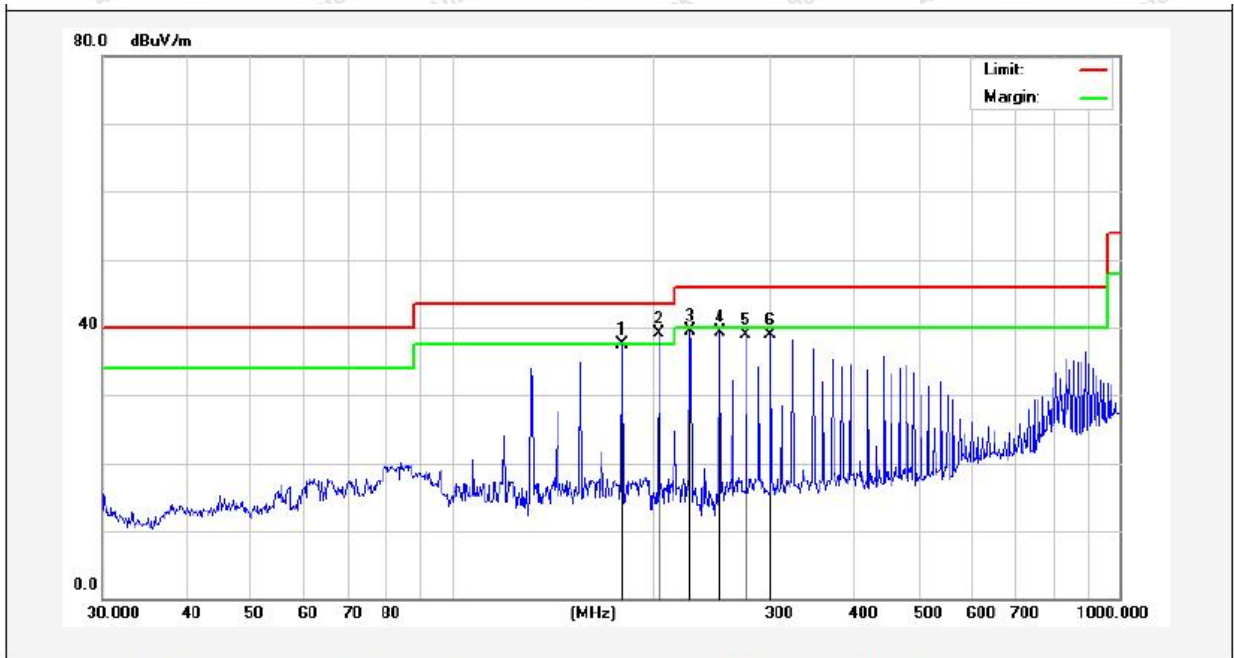

No.	Freq. (MHz)	Reading (dBuV)	Factor (dB/m)	Result (dBuV/m)	Limit (dBuV/m)	Over Limit (dB)	Detector	Height (cm)	degree (deg)	Remark
1	180.0165	60.70	-23.18	37.52	43.50	-5.98	QP			
2	204.2375	61.43	-22.26	39.17	43.50	-4.33	QP			
3	227.6904	61.33	-21.87	39.46	46.00	-6.54	QP			
4	252.0627	60.71	-21.31	39.40	46.00	-6.60	QP			
5	276.1235	58.05	-19.24	38.81	46.00	-7.19	QP			
6	300.3672	56.03	-17.15	38.88	46.00	-7.12	QP			



**Test Results (30~1000MHz)**

Test Mode: High CH (2480MHz)  
 Power Source: DC 3.3V for PC  
 Polarization: Vertical  
 Temp.(°C)/Hum.(%RH): 24.2°C/50%RH

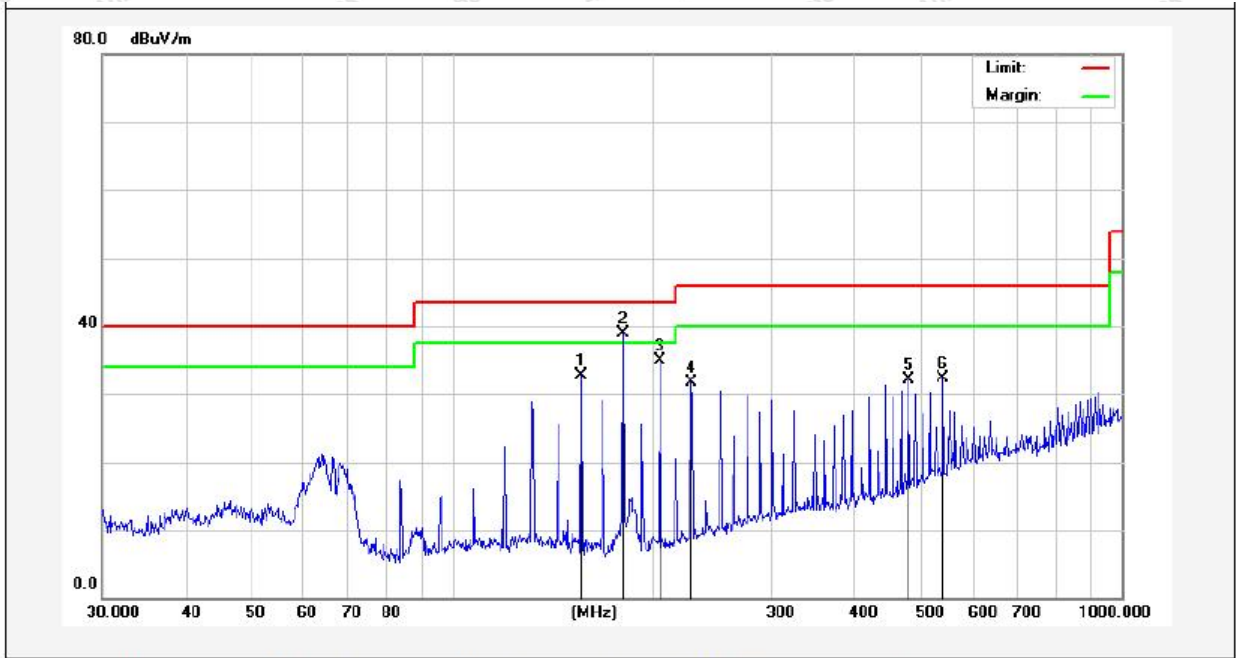

No.	Freq. (MHz)	Reading (dBuV)	Factor (dB/m)	Result (dBuV/m)	Limit (dBuV/m)	Over Limit (dB)	Detector	Height (cm)	degree (deg)	Remark
1	155.9101	54.56	-21.83	32.73	43.50	-10.77	QP			
2	180.0165	59.54	-20.60	38.94	43.50	-4.56	QP			
3	204.2377	54.43	-19.51	34.92	43.50	-8.58	QP			
4	227.6906	50.45	-18.70	31.75	46.00	-14.25	QP			
5	480.5276	44.92	-12.79	32.13	46.00	-13.87	QP			
6	541.3725	44.09	-11.85	32.24	46.00	-13.76	QP			



**Test Results (1GHz-25GHz)**

Test Mode: CH00				Test channel: Lowest		
Peak value:						
Frequency (MHz)	Reading (dBuV)	Factor (dB/m)	Result (dBuV/m)	Limit Line (dBuV/m)	Over Limit (dB)	polarization
4804.00	27.49	15.27	42.76	74.00	-31.24	Vertical
7206.00	27.72	18.09	45.81	74.00	-28.19	Vertical
9608.00	28.24	23.76	52.00	74.00	-22.00	Vertical
12010.00	*			74.00		Vertical
14412.00	*			74.00		Vertical
4804.00	27.24	15.27	42.51	74.00	-31.49	Horizontal
7206.00	27.89	18.09	45.98	74.00	-28.02	Horizontal
9608.00	27.70	23.76	51.46	74.00	-22.54	Horizontal
12010.00	*			74.00		Horizontal
14412.00	*			74.00		Horizontal
Average value:						
Frequency (MHz)	Reading (dBuV)	Factor (dB/m)	Result (dBuV/m)	Limit (dBuV/m)	Over Limit (dB)	polarization
4804.00	15.76	15.27	31.03	54.00	-22.97	Vertical
7206.00	16.77	18.09	34.86	54.00	-19.14	Vertical
9608.00	17.71	23.76	41.47	54.00	-12.53	Vertical
12010.00	*			54.00		Vertical
14412.00	*			54.00		Vertical
4804.00	15.57	15.27	30.84	54.00	-23.16	Horizontal
7206.00	16.92	18.09	35.01	54.00	-18.99	Horizontal
9608.00	17.21	23.76	40.97	54.00	-13.03	Horizontal
12010.00	*			54.00		Horizontal
14412.00	*			54.00		Horizontal





**Test Results (1GHz-25GHz)**

Test Mode: CH19				Test channel: Middle		
Peak value:						
Frequency (MHz)	Reading (dBuV)	Factor (dB/m)	Result (dBuV/m)	Limit Line (dBuV/m)	Over Limit (dB)	polarization
4880.00	27.04	15.42	42.46	74.00	-31.54	Vertical
7320.00	27.69	18.02	45.71	74.00	-28.29	Vertical
9760.00	27.74	23.80	51.54	74.00	-22.46	Vertical
12200.00	*			74.00		Vertical
14640.00	*			74.00		Vertical
4880.00	27.05	15.42	42.47	74.00	-31.53	Horizontal
7320.00	27.76	18.02	45.78	74.00	-28.22	Horizontal
9760.00	27.42	23.80	51.22	74.00	-22.78	Horizontal
12200.00	*			74.00		Horizontal
14640.00	*			74.00		Horizontal
Average value:						
Frequency (MHz)	Reading (dBuV)	Factor (dB/m)	Result (dBuV/m)	Limit (dBuV/m)	Over Limit (dB)	
4880.00	15.85	15.42	31.27	54.00	-22.73	polarization
7320.00	16.63	18.02	34.65	54.00	-19.35	Vertical
9760.00	17.56	23.80	41.36	54.00	-12.64	Vertical
12200.00	*			54.00		Vertical
14640.00	*			54.00		Vertical
4880.00	15.68	15.42	31.10	54.00	-22.90	Vertical
7320.00	17.27	18.02	35.29	54.00	-18.71	Horizontal
9760.00	17.51	23.80	41.31	54.00	-12.69	Horizontal
12200.00	*			54.00		Horizontal
14640.00	*			54.00		Horizontal



**Test Results (1GHz-25GHz)**

Test Mode: CH39				Test channel: Highest		
Peak value:						
Frequency (MHz)	Reading (dBuV)	Factor (dB/m)	Result (dBuV/m)	Limit Line (dBuV/m)	Over Limit (dB)	polarization
4960.00	27.17	15.58	42.75	74.00	-31.25	Vertical
7440.00	27.85	17.93	45.78	74.00	-28.22	Vertical
9920.00	28.44	23.83	52.27	74.00	-21.73	Vertical
12400.00	*			74.00		Vertical
14880.00	*			74.00		Vertical
4960.00	27.19	15.58	42.77	74.00	-31.23	Horizontal
7440.00	27.97	17.93	45.90	74.00	-28.10	Horizontal
9920.00	27.80	23.83	51.63	74.00	-22.37	Horizontal
12400.00	*			74.00		Horizontal
14880.00	*			74.00		Horizontal
Average value:						
Frequency (MHz)	Reading (dBuV)	Factor (dB/m)	Result (dBuV/m)	Limit (dBuV/m)	Over Limit (dB)	polarization
4960.00	16.97	15.58	32.55	54.00	-21.45	Vertical
7440.00	17.90	17.93	35.83	54.00	-18.17	Vertical
9920.00	18.21	23.83	42.04	54.00	-11.96	Vertical
12400.00	*			54.00		Vertical
14880.00	*			54.00		Vertical
4960.00	16.86	15.58	32.44	54.00	-21.56	Horizontal
7440.00	18.07	17.93	36.00	54.00	-18.00	Horizontal
9920.00	17.66	23.83	41.49	54.00	-12.51	Horizontal
12400.00	*			54.00		Horizontal
14880.00	*			54.00		Horizontal

Remark:

1.Result =Reading + Factor

2. "\*" means the test results were attenuated more than 20dB below the permissible limits, so the results don't record in the report.



**Radiated Band Edge:**

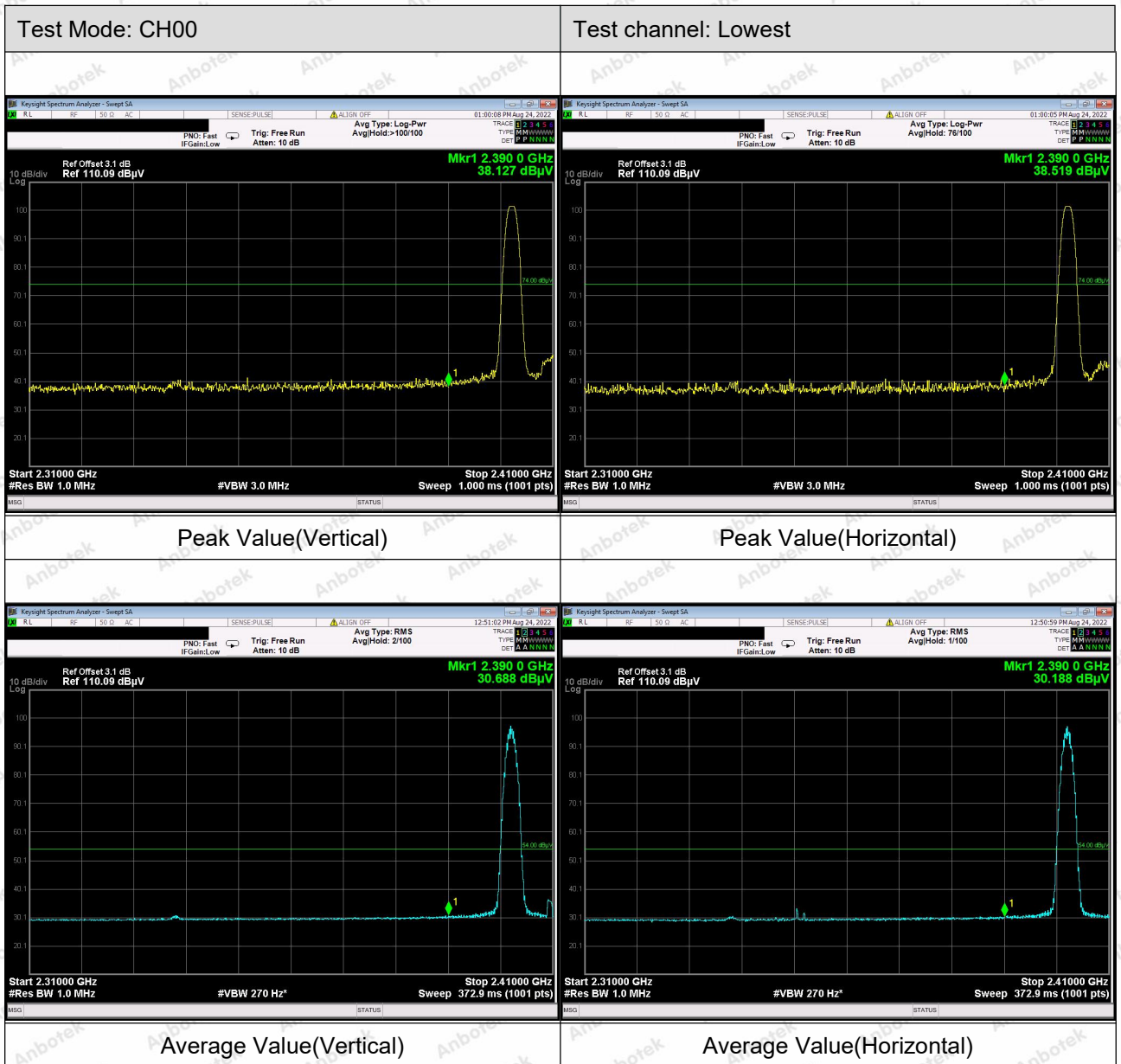



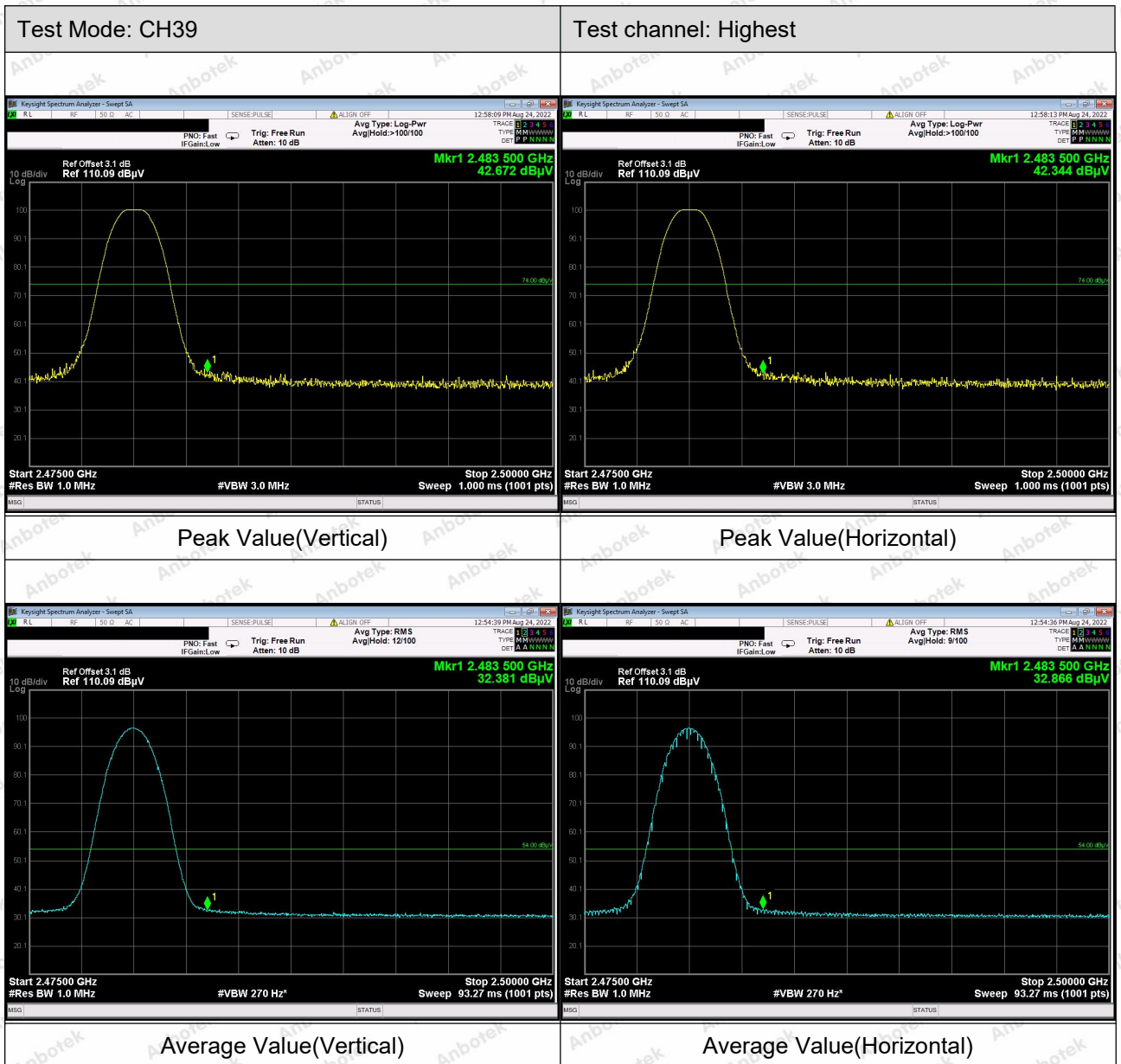

## 5. Maximum Peak Output Power Test

### 5.1. Test Standard and Limit

Test Standard	FCC Part15 C Section 15.247 (b)(3)
Test Limit	1W (30dBm)

### 5.2. Test Setup

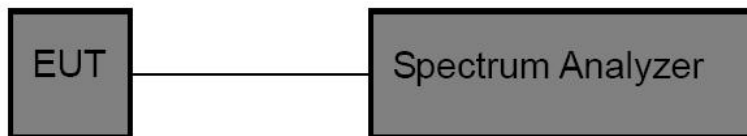

### 5.3. Test Procedure

This procedure shall be used when the measurement instrument has available a resolution bandwidth that is greater than the DTS bandwidth.

1. Set the RBW  $\geq$  DTS bandwidth.
2. Set the VBW  $\geq 3 \times$  RBW.
3. Set the span  $\geq 3 \times$  RBW.
4. Detector = peak.
5. Sweep time = auto couple.
6. Trace mode = max hold.
7. Allow trace to fully stabilize.
8. Use peak marker function to determine the peak amplitude level.

### 5.4. Test Data

Pass

Please refer to Appendix C of the Appendix Test Data.

#### Additional test for duty cycle.

Please refer to Appendix G of the Appendix Test Data.



## 6. 6DB Occupancy Bandwidth Test

### 6.1. Test Standard and Limit

Test Standard	FCC Part15 C Section 15.247 (a)(2)
Test Limit	≥500kHz

### 6.2. Test Setup



### 6.3. Test Procedure

1. Place the EUT on the table and set it in the transmitting mode.
2. Remove the antenna from the EUT and then connect a low loss RF cable from the antenna port to the spectrum analyzer.
3. Set the spectrum analyzer as:
  - RBW = 100kHz, VBW≥3\*RBW
  - Detector= Peak
  - Trace mode= Max hold.
  - Sweep- auto couple.
4. Mark the peak frequency and -6dB (upper and lower) frequency.
5. Repeat until all the rest channels are investigated.

### 6.4. Test Data

Pass

Please refer to Appendix A of the Appendix Test Data.





## 7. Power Spectral Density Test

### 7.1. Test Standard and Limit

Test Standard	FCC Part15 C Section 15.247 (e)
Test Limit	8dBm/3KHz

### 7.2. Test Setup

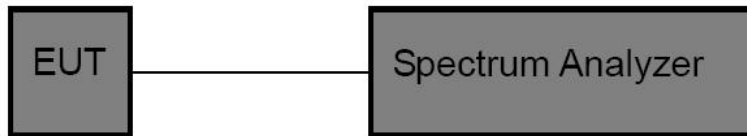

### 7.3. Test Procedure

1. Place the EUT on the table and set it in transmitting mode. Remove the antenna from the EUT and then connect a low loss RF cable from the antenna port to the spectrum analyzer.
2. Set the spectrum analyzer as RBW = 3kHz, VBW  $\geq 3 \times$  RBW, Span = 1.5x DTS BW
3. Record the max. reading.
4. Repeat the above procedure until the measurements for all frequencies are completed.

### 7.4. Test Data

Pass

Please refer to Appendix D of the Appendix Test Data.



## 8. 100kHz Bandwidth of Frequency Band Edge Requirement

### 8.1. Test Standard and Limit

Test Standard	FCC Part15 C Section 15.247 (d)
Test Limit	In any 100 kHz bandwidth outside the frequency bands in which the spread spectrum intentional radiator is operating, the radio frequency power that is produced by the intentional radiator shall be at least 20dB below that in the 100kHz bandwidth within the band that contains the highest level of the desired power, In addition, radiated emissions which fall in the restricted bands, as defined in §15.205(a), must also comply with the radiated emission limits specified in 15.209(a).

### 8.2. Test Setup

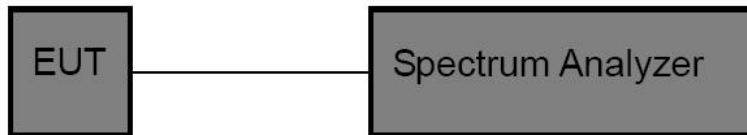

### 8.3. Test Procedure

Using the following spectrum analyzer setting:

1. Set the RBW = 100KHz.
2. Set the VBW = 300KHz.
3. Sweep time = auto couple.
4. Detector function = peak.
5. Trace mode = max hold.
6. Allow trace to fully stabilize.

### 8.4. Test Data

Pass

Please refer to Appendix E&F of the Appendix Test Data.



## 9. Antenna Requirement

### 9.1. Test Standard and Requirement

Test Standard	FCC Part15 Section 15.203 /247(c)
Requirement	<p>1) 15.203 requirement: An intentional radiator shall be designed to ensure that no antenna other than that furnished by the responsible party shall be used with the device. The use of a permanently attached antenna or of an antenna that uses a unique coupling to the intentional radiator, the manufacturer may design the unit so that a broken antenna can be replaced by the user, but the use of a standard antenna jack or electrical connector is prohibited.</p> <p>2) 15.247(c) (1)(i) requirement: Systems operating in the 2400-2483.5 MHz band that is used exclusively for fixed. Point-to-point operations may employ transmitting antennas with directional gain greater than 6dBi provided the maximum conducted output power of the intentional radiator is reduced by 1 dB for every 3 dB that the directional gain of the antenna exceeds 6 dBi.</p>

### 9.2. Antenna Connected Construction

The antenna is a PCB antenna which permanently attached, and the best case gain of the antenna is 2 dBi . It complies with the standard requirement.





## **APPENDIX I -- TEST SETUP PHOTOGRAPH**

Please refer to separated files Appendix I -- Test Setup Photograph

## **APPENDIX II -- EXTERNAL PHOTOGRAPH**

Please refer to separated files Appendix II -- External Photograph

## **APPENDIX III -- INTERNAL PHOTOGRAPH**

Please refer to separated files Appendix III -- Internal Photograph

----- End of Report -----

