



## TEST REPORT

Test report no.: 1-3977/22-03-21

### Testing laboratory

**CTC advanced GmbH**

Untertuerkheimer Strasse 6 – 10

66117 Saarbruecken / Germany

Phone: + 49 681 5 98 - 0

Fax: + 49 681 5 98 - 9075

Internet: <https://www.ctcadvanced.com>

e-mail: [mail@ctcadvanced.com](mailto:mail@ctcadvanced.com)

**Accredited Testing Laboratory:**

The testing laboratory (area of testing) is accredited according to DIN EN ISO/IEC 17025 (2018-03) by the Deutsche Akkreditierungsstelle GmbH (DAkkS)

The accreditation is valid for the scope of testing procedures as stated in the accreditation certificate starting with the registration number: D-PL-12076-01.

### Applicant

**SAGEMCOM BROADBAND SAS**

250, route de l' Empereur

92848 Rueil-Malmaison Cedex / FRANCE

Phone: -/-

Contact: Ludovic Bomba

e-mail: [ludovic.bomba@sagemcom.com](mailto:ludovic.bomba@sagemcom.com)

### Manufacturer

**SAGEMCOM BROADBAND SAS**

250, route de l' Empereur

92848 Rueil-Malmaison Cedex / FRANCE

### Test standard/s

FCC - Title 47 CFR Part 27      FCC - Title 47 of the Code of Federal Regulations; Chapter I; Part 27 - Miscellaneous wireless communications services

For further applied test standards please refer to section 3 of this test report.

### Test Item

**Kind of test item:**                      **Gateway**  
**Model name:**                            **F5688W**  
**FCC ID:**                                    **VW3F5688W**  
**Frequency:**                              Band 77 – 3450-3550 MHz & 3700-3980 MHz  
**Technology tested:**                    5G NR  
**Antenna:**                                 4 integrated antenna  
**Power supply:**                         120 V AC by power supply unit  
**Temperature range:**                    0°C to +50°C

This test report is electronically signed and valid without handwritten signature. For verification of the electronic signatures, the public keys can be requested at the testing laboratory.

### Test report authorized:

Michael Dorongovski  
Lab Manager  
Radio Communications

### Test performed:

Andreas Luckenbill  
Head of Department  
Radio Communications

## 1 Table of contents

<b>1</b>	<b>Table of contents .....</b>	<b>2</b>
<b>2</b>	<b>General information .....</b>	<b>4</b>
2.1	Notes and disclaimer .....	4
2.2	Application details .....	4
2.3	Test laboratories sub-contracted .....	4
<b>3</b>	<b>Test standard/s, references and accreditations .....</b>	<b>5</b>
<b>4</b>	<b>Reporting statements of conformity – decision rule .....</b>	<b>6</b>
<b>5</b>	<b>Test environment .....</b>	<b>7</b>
<b>6</b>	<b>Test item.....</b>	<b>7</b>
6.1	General description .....	7
6.2	Additional information .....	7
<b>7</b>	<b>Sequence of testing .....</b>	<b>8</b>
7.1	Sequence of testing radiated spurious 9 kHz to 30 MHz .....	8
7.2	Sequence of testing radiated spurious 30 MHz to 1 GHz .....	9
7.3	Sequence of testing radiated spurious 1 GHz to 18 GHz .....	10
7.4	Sequence of testing radiated spurious above 18 GHz .....	11
<b>8</b>	<b>Description of the test setup.....</b>	<b>12</b>
8.1	Shielded semi anechoic chamber .....	13
8.2	Shielded fully anechoic chamber.....	14
8.3	Radiated measurements > 18 GHz.....	15
8.4	Conducted measurements normal and extreme conditions.....	16
<b>9</b>	<b>Measurement uncertainty .....</b>	<b>17</b>
<b>10</b>	<b>Additional information and comments .....</b>	<b>18</b>
<b>11</b>	<b>RF measurements .....</b>	<b>19</b>
11.1	Description of test setup .....	19
<b>12</b>	<b>Summary of measurement results.....</b>	<b>19</b>
12.1	Part 27: 5G NR band 77 .....	19
<b>13</b>	<b>RF measurements .....</b>	<b>20</b>
13.1	Description of test setup .....	20
13.2	Results 5G NR band 77.....	20
13.2.1	RF output power / Peak to AVG ratio – 5G NR n77 – 3450 MHz to 3550 MHz.....	21
13.2.1.1	Results – conducted power.....	22
13.2.1.2	Results – EIRP .....	29
13.2.1.3	Results – Peak to AVG ratio .....	31
13.2.2	RF output power / Peak to AVG ratio – 5G NR n77 – 3700 MHz to 3980 MHz.....	33
13.2.2.1	Results – conducted power.....	34
13.2.2.2	Results – EIRP .....	41
13.2.2.3	Results – Peak to AVG ratio .....	43
13.2.3	Frequency stability – 5G NR n77 – 3450 MHz to 3550 MHz.....	45

13.2.4	Frequency stability – 5G NR n77 – 3700 MHz to 3980 MHz.....	47
13.2.5	Spurious emissions radiated – 5G NR n77 – 3450 MHz to 3550 MHz .....	49
13.2.6	Spurious emissions radiated – 5G NR n77 – 3700 MHz to 3980 MHz .....	61
13.2.7	Spurious emissions conducted – 5G NR n77 – 3450 MHz to 3550 MHz .....	73
13.2.8	Spurious emissions conducted – 5G NR n77 – 3700 MHz to 3980 MHz .....	84
13.2.9	Block edge compliance – 5G NR n77 – 3450 MHz to 3550 MHz .....	95
13.2.10	Block edge compliance – 5G NR n77 – 3700 MHz to 3980 MHz .....	96
13.2.11	Occupied bandwidth – 5G NR n77 – 3450 MHz to 3550 MHz.....	97
13.2.12	Occupied bandwidth – 5G NR n77 – 3700 MHz to 3980 MHz.....	107
<b>14</b>	<b>Glossary .....</b>	<b>117</b>
<b>15</b>	<b>Document history .....</b>	<b>118</b>
<b>16</b>	<b>Accreditation Certificate – D-PL-12076-01-05 .....</b>	<b>118</b>

## 2 General information

### 2.1 Notes and disclaimer

The test results of this test report relate exclusively to the test item specified in this test report. CTC advanced GmbH does not assume responsibility for any conclusions and generalizations drawn from the test results with regard to other specimens or samples of the type of the equipment represented by the test item.

The test report may only be reproduced or published in full. Reproduction or publication of extracts from the report requires the prior written approval of CTC advanced GmbH.

The testing service provided by CTC advanced GmbH has been rendered under the current "General Terms and Conditions for CTC advanced GmbH".

CTC advanced GmbH will not be liable for any loss or damage resulting from false, inaccurate, inappropriate or incomplete product information provided by the customer.

Under no circumstances does the CTC advanced GmbH test report include any endorsement or warranty regarding the functionality, quality or performance of any other product or service provided.

Under no circumstances does the CTC advanced GmbH test report include or imply any product or service warranties from CTC advanced GmbH, including, without limitation, any implied warranties of merchantability, fitness for purpose, or non-infringement, all of which are expressly disclaimed by CTC advanced GmbH.

All rights and remedies regarding vendor's products and services for which CTC advanced GmbH has prepared this test report shall be provided by the party offering such products or services and not by CTC advanced GmbH. In no case this test report can be considered as a Letter of Approval.

This test report is electronically signed and valid without handwritten signature. For verification of the electronic signatures, the public keys can be requested at the testing laboratory.

### 2.2 Application details

Date of receipt of order:	2022-12-07
Date of receipt of test item:	2022-09-27
Start of test:*	2022-10-04
End of test:*	2022-12-12
Person(s) present during the test:	-/-

\*Date of each measurement, if not shown in the plot, can be requested. Dates are stored in the measurement software.

### 2.3 Test laboratories sub-contracted

None

### 3 Test standard/s, references and accreditations

Test standard	Date	Description
FCC - Title 47 CFR Part 27		FCC - Title 47 of the Code of Federal Regulations; Chapter I; Part 27 - Miscellaneous wireless communications services

Guidance	Version	Description
ANSI C63.4-2014	-/-	American National Standard for Methods of Measurement of Radio-Noise Emissions from Low-Voltage Electrical and Electronic Equipment in the Range of 9 kHz to 40 GHz
ANSI C63.26-2015	-/-	American National Standard for Compliance Testing of Transmitters Used in Licensed Radio Services
KDB 662911 D01	v02r01	Emissions Testing of Transmitters with Multiple Outputs in the Same Band
Power Meas License Systems: KDB 971168 D01	v03r01	Measurement Guidance for Certification of Licensed Digital Transmitters

Accreditation	Description
D-PL-12076-01-05	Telecommunication FCC requirements <a href="https://www.dakks.de/as/ast/d/D-PL-12076-01-05e.pdf">https://www.dakks.de/as/ast/d/D-PL-12076-01-05e.pdf</a>



FCC designation number: DE0002

#### 4 Reporting statements of conformity – decision rule

Only the measured values related to their corresponding limits will be used to decide whether the equipment under test meets the requirements of the test standards listed in chapter 3.

The measurement uncertainty is mentioned in this test report, see chapter 9, but is not taken into account - neither to the limits nor to the measurement results. Measurement results with a smaller margin to the corresponding limits than the measurement uncertainty have a potential risk of more than 5% that the decision might be wrong."

measured value, measurement uncertainty, verdict



## 5 Test environment

Temperature	:	$T_{nom}$ +22 °C during room temperature tests $T_{max}$ +50 °C during high temperature tests $T_{min}$ -30 °C during low temperature tests
Relative humidity content	:	55 %
Barometric pressure	:	1021 hpa
Power supply	:	$V_{nom}$ 120 V AC by power supply unit. $V_{max}$ 136 V AC by external power supply. $V_{min}$ 104 V AC by external power supply.

## 6 Test item

### 6.1 General description

Kind of test item	:	Gateway
Model name	:	F5688W
S/N serial number	:	Radiated unit:    QS2212959002899 (IMEI: 359509840135591) – WAL SIN QS2212959002968 (IMEI: 359509840060641) – COLFLY QS2212959002883 (IMEI: 359509840060278) – HL Conducted units:    IMEI: 359509840061128
Hardware status	:	V1.2
Software status	:	SG520TMDAR02A02M4G_01.001.01.001_V01
Firmware status	:	SG520TMDAR02A02M4G_01.001.01.001_V01
Frequency band	:	Band 77 – 3450-3550 MHz & 3700-3980 MHz
Type of radio transmission	:	Modulated carrier
Use of frequency spectrum	:	
Type of modulation	:	BPSK, QPSK, 16-QAM, 64-QAM, 256-QAM
Antenna	:	4 integrated antenna
Power supply	:	120 V AC by power supply unit
Temperature range	:	0°C to +50°C

### 6.2 Additional information

The content of the following annexes is defined in the QA. It may be that not all of the listed annexes are necessary for this report, thus some values in between may be missing.

Test setup and EUT photos are included in test report:    1-3977/22-03-01\_AnnexA  
   1-3977/22-03-01\_AnnexB  
   1-3977/22-03-01\_AnnexC

## 7 Sequence of testing

### 7.1 Sequence of testing radiated spurious 9 kHz to 30 MHz

#### Setup

- The equipment is set up to simulate normal operation mode as described in the user manual or defined by the manufacturer.
- If the EUT is a tabletop system, it is placed on a table with 0.8 m height.
- If the EUT is a floor standing device, it is placed directly on the turn table.
- Auxiliary equipment and cables are positioned to simulate normal operation conditions as described in ANSI C 63.4.
- The AC power port of the EUT (if available) is connected to a power outlet below the turntable.
- Measurement distance is 3 m (see ANSI C 63.4) – see test details.
- EUT is set into operation.

#### Premeasurement\*

- The turntable rotates from 0° to 315° using 45° steps.
- The antenna height is 1 m.
- At each turntable position the analyzer sweeps with positive-peak detector to find the maximum of all emissions.

#### Final measurement

- Identified emissions during the pre-measurement are maximized by the software by rotating the turntable from 0° to 360°.
- Loop antenna is rotated about its vertical axis for maximum response at each azimuth about the EUT. (For certain applications, the loop antenna plane may also need to be positioned horizontally at the specified distance from the EUT)
- The final measurement is done in the position (turntable and elevation) causing the highest emissions with quasi-peak (as described in ANSI C 63.4).
- Final levels, frequency, measuring time, bandwidth, turntable position, correction factor, margin to the limit and limit will be recorded. A plot with the graph of the premeasurement and the limit is stored.

\*Note: The sequence will be repeated three times with different EUT orientations.



## 7.2 Sequence of testing radiated spurious 30 MHz to 1 GHz

### Setup

- The equipment is set up to simulate normal operation mode as described in the user manual or defined by the manufacturer.
- If the EUT is a tabletop system, a table with 0.8 m height is used, which is placed on the ground plane.
- If the EUT is a floor standing device, it is placed on the ground plane with insulation between both.
- Auxiliary equipment and cables are positioned to simulate normal operation conditions as described in ANSI C 63.4.
- The AC power port of the EUT (if available) is connected to a power outlet below the turntable.
- Measurement distance is 10 m or 3 m (see ANSI C 63.4) – see test details.
- EUT is set into operation.

### Premeasurement

- The turntable rotates from 0° to 315° using 45° steps.
- The antenna is polarized vertical and horizontal.
- The antenna height changes from 1 m to 3 m.
- At each turntable position, antenna polarization and height the analyzer sweeps three times in peak to find the maximum of all emissions.

### Final measurement

- The final measurement is performed for at least six highest peaks according to the requirements of the ANSI C63.4.
- Based on antenna and turntable positions at which the peak values are measured the software maximize the peaks by changing turntable position  $\pm 45^\circ$  and antenna height between 1 and 4 m.
- The final measurement is done with quasi-peak detector (as described in ANSI C 63.4).
- Final levels, frequency, measuring time, bandwidth, antenna height, antenna polarization, turntable angle, correction factor, margin to the limit and limit are recorded. A plot with the graph of the premeasurement with marked maximum final results and the limit is stored.

### 7.3 Sequence of testing radiated spurious 1 GHz to 18 GHz

#### Setup

- The equipment is set up to simulate normal operation mode as described in the user manual or defined by the manufacturer.
- If the EUT is a tabletop system, a 2-axis positioner with 1.5 m height is used.
- If the EUT is a floor standing device, it is placed directly on the turn table.
- Auxiliary equipment and cables are positioned to simulate normal operation conditions as described in ANSI C 63.4.
- The AC power port of the EUT (if available) is connected to a power outlet below the turntable.
- Measurement distance is 3 m (see ANSI C 63.4) – see test details.
- EUT is set into operation.

#### Premeasurement

- The turntable rotates from 0° to 315° using 45° steps.
- The antenna is polarized vertical and horizontal.
- The antenna height is 1.5 m.
- At each turntable position and antenna polarization the analyzer sweeps with positive peak detector to find the maximum of all emissions.

#### Final measurement

- The final measurement is performed for at least six highest peaks according to the requirements of the ANSI C63.4.
- Based on antenna and turntable positions at which the peak values are measured the software maximizes the peaks by rotating the turntable from 0° to 360°. This measurement is repeated for different EUT-table positions (0° to 150° in 30°-steps) and for both antenna polarizations.
- The final measurement is done in the position (turntable, EUT-table and antenna polarization) causing the highest emissions with Peak and RMS detector (as described in ANSI C 63.4).
- Final levels, frequency, measuring time, bandwidth, turntable position, EUT-table position, antenna polarization, correction factor, margin to the limit and limit are recorded. A plot with the graph of the premeasurement with marked maximum final results and the limit is stored.

## 7.4 Sequence of testing radiated spurious above 18 GHz

### Setup

- The equipment is set up to simulate normal operation mode as described in the user manual or defined by the manufacturer.
- Auxiliary equipment and cables are positioned to simulate normal operation conditions as described in ANSI C 63.4.
- The AC power port of the EUT (if available) is connected to a power outlet.
- The measurement distance is as appropriate (e.g. 0.5 m).
- The EUT is set into operation.

### Premeasurement

- The test antenna is handheld and moved carefully over the EUT to cover the EUT's whole sphere and different polarizations of the antenna.

### Final measurement

- The final measurement is performed at the position and antenna orientation causing the highest emissions with Peak and RMS detector (as described in ANSI C 63.4).
- Final levels, frequency, measuring time, bandwidth, correction factor, margin to the limit and limit are recorded. A plot with the graph of the premeasurement and the limit is stored.

## 8 Description of the test setup

Typically, the calibrations of the test apparatus are commissioned to and performed by an accredited calibration laboratory. The calibration intervals are determined in accordance with the DIN EN ISO/IEC 17025. In addition to the external calibrations, the laboratory executes comparison measurements with other calibrated test systems or effective verifications. Weekly chamber inspections and range calibrations are performed. Where possible, RF generating and signaling equipment as well as measuring receivers and analyzers are connected to an external high-precision 10 MHz reference (GPS-based or rubidium frequency standard).

In order to simplify the identification of the equipment used at some special tests, some items of test equipment and ancillaries can be provided with an identifier or number in the equipment list below (Lab/Item).

Each block diagram listed can contain several test setup configurations. All devices belonging to a test setup are identified with the same letter syntax. For example: Column Setup and all devices with an A.

### **Agenda:** Kind of Calibration

k	calibration / calibrated	EK	limited calibration
ne	not required (k, ev, izw, zw not required)	zw	cyclical maintenance (external cyclical maintenance)
ev	periodic self verification	izw	internal cyclical maintenance
Ve	long-term stability recognized	g	blocked for accredited testing
vlk!	Attention: extended calibration interval		
NK!	Attention: not calibrated	*)	next calibration ordered / currently in progress

## 8.1 Shielded semi anechoic chamber

The radiated measurements are performed in vertical and horizontal plane in the frequency range from 30 MHz to 1 GHz in semi-anechoic chambers. The EUT is positioned on a non-conductive support with a height of 0.80 m above a conductive ground plane that covers the whole chamber. The receiving antennas are conform to specifications ANSI C63. These antennas can be moved over the height range between 1.0 m and 4.0 m in order to search for maximum field strength emitted from EUT. The measurement distances between EUT and receiving antennas are indicated in the test setups for the various frequency ranges. For each measurement, the EUT is rotated in all three axes until the maximum field strength is received. The wanted and unwanted emissions are received by spectrum analyzers where the detector modes and resolution bandwidths over various frequency ranges are set according to requirement ANSI C63.

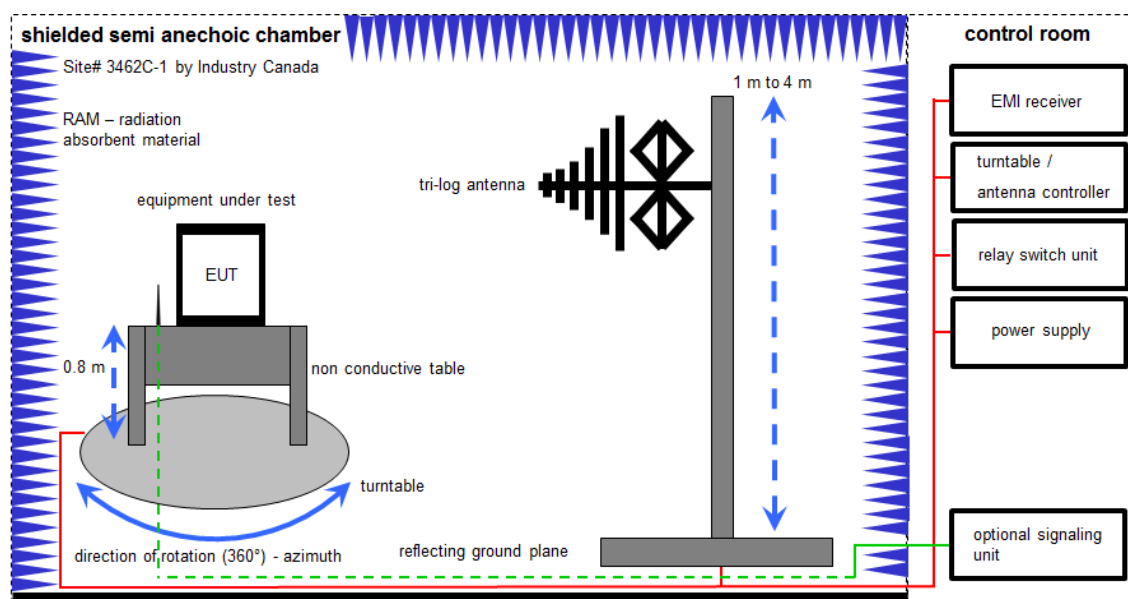

Measurement distance: tri-log antenna 10 meter; EMC32 software version: 10.59.00

$$FS = UR + CL + AF$$

(FS-field strength; UR-voltage at the receiver; CL-loss of the cable; AF-antenna factor)

Example calculation:

$$FS [dB\mu V/m] = 12.35 [dB\mu V/m] + 1.90 [dB] + 16.80 [dB/m] = 31.05 [dB\mu V/m] (35.69 \mu V/m)$$

### Equipment table:

No.	Lab / Item	Equipment	Type	Manufacturer	Serial No.	INV. No.	Kind of Calibration	Last Calibration	Next Calibration
1	A	Switch-Unit	3488A	HP	2719A14505	300000368	ev	-/-	-/-
2	A	Meßkabine 1	HF-Absorberhalle	MWB AG 300023	Batch no. 699714	300000551	ne	-/-	-/-
3	A	Antenna Tower	Model 2175	ETS-Lindgren	64762	300003745	izw	-/-	-/-
4	A	Positioning Controller	Model 2090	ETS-Lindgren	64672	300003746	izw	-/-	-/-
5	A	Turntable Interface-Box	Model 105637	ETS-Lindgren	44583	300003747	izw	-/-	-/-
6	A	TRILOG Broadband Test-Antenna 30 MHz - 3 GHz	VULB9163	Schwarzbeck Mess-Elektronik	295	300003787	vKI!	21.04.2021	20.04.2023
7	A	EMI Test Receiver	ESR3	Rohde & Schwarz	102587	300005771	k	20.05.2022	31.05.2023

## 8.2 Shielded fully anechoic chamber

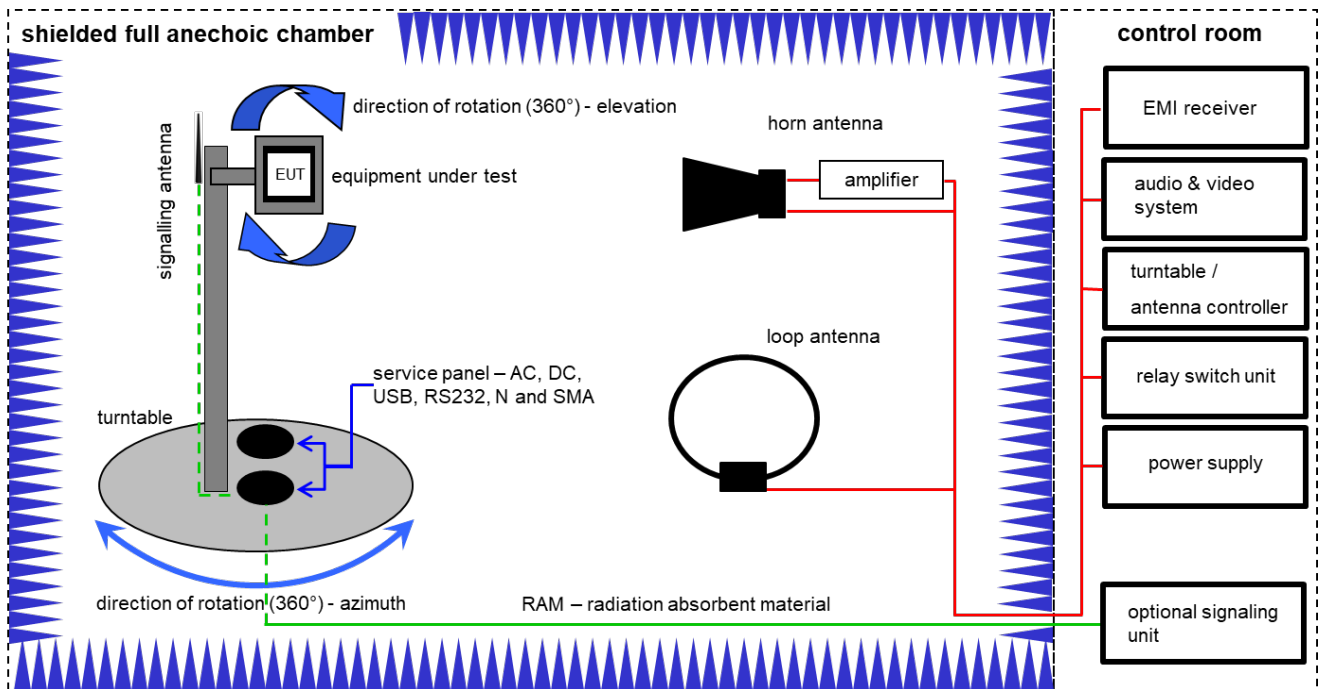

Measurement distance: horn antenna 3 meter; loop antenna 3 meter

$$OP = AV + D - G + CA$$

(OP-radiated output power; AV-analyzer value; D-free field attenuation of measurement distance; G-antenna gain+amplifier gain; CA-loss signal path)

Example calculation:

$$OP \text{ [dBm]} = -39.0 \text{ [dBm]} + 57.0 \text{ [dB]} - 12.0 \text{ [dBi]} + (-36.0) \text{ [dB]} = -30 \text{ [dBm]} (1 \mu\text{W})$$

**Equipment table:**

No.	Setup	Equipment	Type	Manufacturer	Serial No.	INV. No.	Kind of Calibration	Last Calibration	Next Calibration
1	B	Active Loop Antenna 9 kHz to 30 MHz	6502	EMCO	2210	300001015	vKI!	01.07.2021	31.07.2023
2	A, B	Anechoic chamber	FAC 3/5m	MWB / TDK	87400/02	300000996	ev	-/-	-/-
3	A	Double-Ridged Waveguide Horn Antenna 1-18.0GHz	3115	EMCO	8812-3089	300000307	vKI!	11.02.2022	29.02.2024
4	A, B	EMI Test Receiver 20Hz- 26,5GHz	ESU26	R&S	100037	300003555	k	09.12.2021	31.12.2022
5	A, B	Highpass Filter	WHK1.1/15G-10SS	Wainwright	3	300003255	ev	-/-	-/-
6	A, B	Highpass Filter	WHKX7.0/18G-8SS	Wainwright	19	300003790	ne	-/-	-/-
7	A	Broadband Amplifier 0.5-18 GHz	CBLU5184540	CERNEX	22049	300004481	ev	-/-	-/-
8	A, B	4U RF Switch Platform	L4491A	Agilent Technologies	MY50000037	300004509	ne	-/-	-/-
9	A, B	NEXIO EMV-Software	BAT EMC V3.21.0.27	EMCO		300004682	ne	-/-	-/-
10	A	RF-Amplifier	AMF-6F06001800-30-10P-R	NARDA-MITEQ Inc	2011572	300005241	ev	-/-	-/-

### 8.3 Radiated measurements > 18 GHz

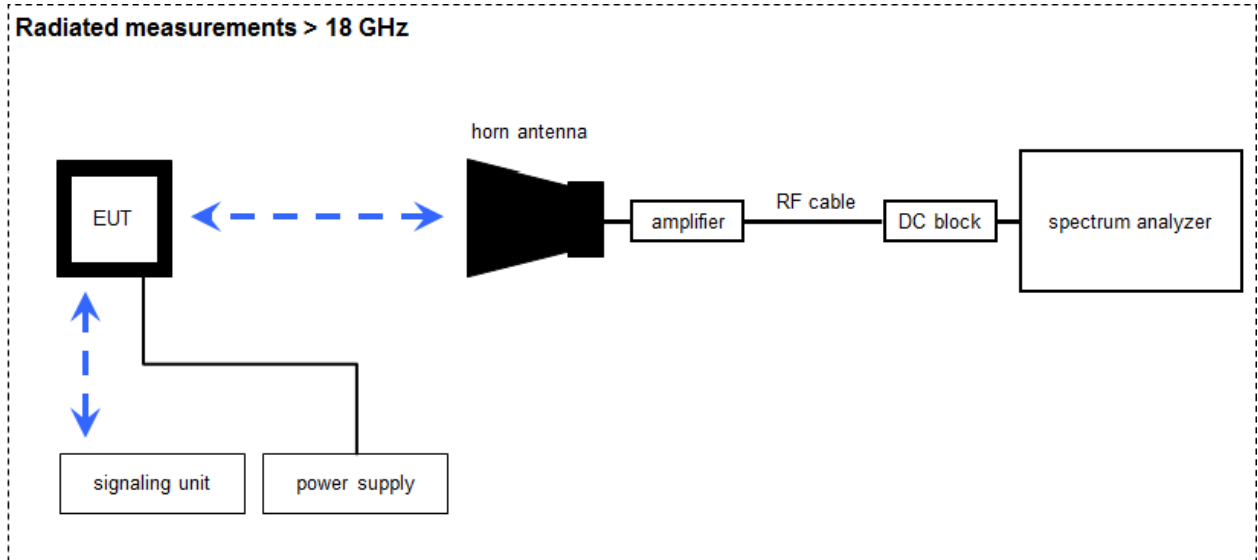

Measurement distance: horn antenna 50 cm

$$FS = UR + CA + AF$$

(FS-field strength; UR-voltage at the receiver; CA-loss signal path & distance correction; AF-antenna factor)

Example calculation:

$$FS [dB\mu V/m] = 40.0 [dB\mu V/m] + (-60.1) [dB] + 36.74 [dB/m] = 16.64 [dB\mu V/m] (6.79 \mu V/m)$$

#### Equipment table:

No.	Lab / Item	Equipment	Type	Manufacturer	Serial No.	INV. No.	Kind of Calibration	Last Calibration	Next Calibration
1	A	Microwave System Amplifier, 0.5-26.5 GHz	83017A	HP	00419	300002268	ev	-/-	-/-
2	A	Std. Gain Horn Antenna 18.0-26.5 GHz	638	Narda	01096	300000486	vKI!	17.01.2022	31.01.2024
3	A	Std. Gain Horn Antenna 26.5-40.0 GHz	V637	Narda	82-16	300000510	vKI!	17.01.2022	31.01.2024
4	A	Broadband Low Noise Amplifier 18-50 GHz	CBL18503070-XX	CERNEX	19338	300004273	ev	-/-	-/-
5	A	RF-Cable	ST18/SMAM/SMAM/48	Huber & Suhner	Batch no. 600918	400001182	ev	-/-	-/-
6	A	Signal Analyzer 40 GHz	FSV40	R&S	101042	300004517	k	25.01.2022	31.01.2023

## 8.4 Conducted measurements normal and extreme conditions

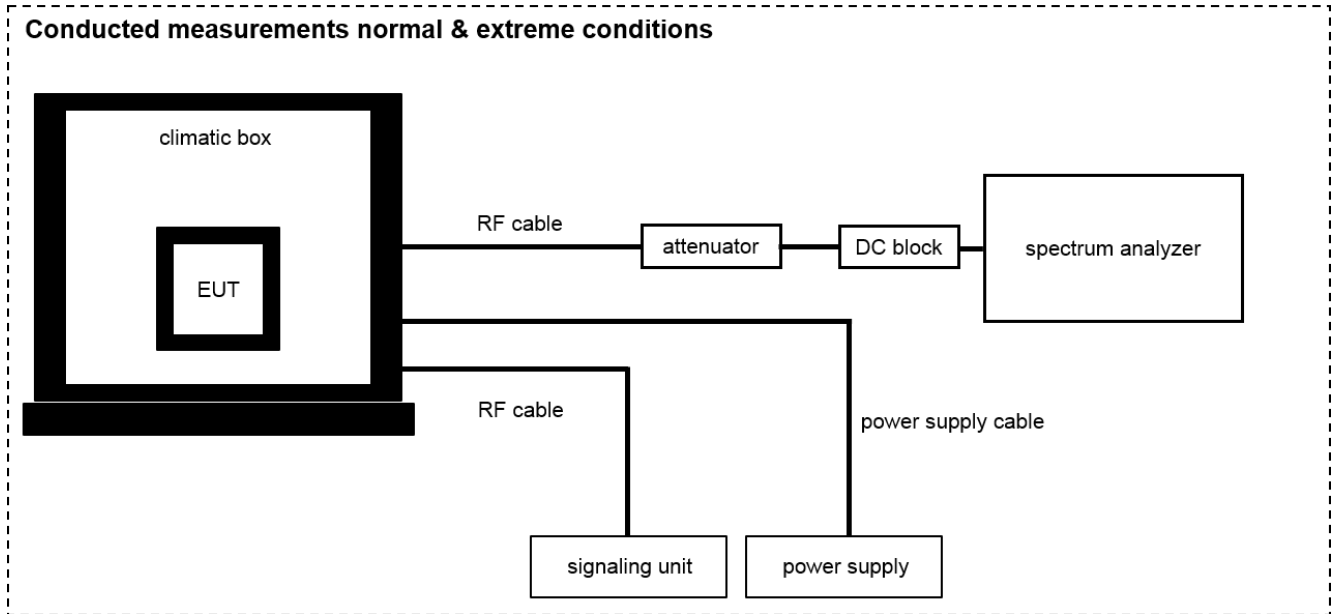

OP = AV + CA  
(OP-output power; AV-analyzer value; CA-loss signal path)

Example calculation:

OP [dBm] = 6.0 [dBm] + 11.7 [dB] = 17.7 [dBm] (58.88 mW)

**Equipment table:**

No.	Setup	Equipment	Type	Manufacturer	Serial No.	INV. No.	Kind of Calibration	Last Calibration	Next Calibration
1	A	Signal analyzer	FSV40	Rohde&Schwarz	101042	300004517	k	25.01.2022	31.01.2023
2	A	Teststand	Teststand Custom Sequence Editor	National Instruments GmbH		300004590	ne	-/-	-/-
3	A	RF-Cable	ST18/SMAm/SMAm /72	Huber & Suhner	Batch no. 699714	400001184	ev	-/-	-/-
4	A	DC-Blocker 0.1-40 GHz	8141A	Inmet		400001185	ev	-/-	-/-
5	A	RF-Cable	ST18/SMAm/SMAm /36	Huber & Suhner	Batch no. 601494	400001309	ev	-/-	-/-
6	A	Temperature Test Chamber	T-40/50	CTS GmbH	064023	300003540	ev	08.05.2022	07.05.2024



## 9 Measurement uncertainty

Measurement uncertainty		
Test case	Uncertainty	
Antenna gain	± 3 dB	
99 % bandwidth	± RBW	
-26 dB bandwidth	± RBW	
Frequency stability	10 <sup>-6</sup>	
Maximum output power conducted	± 1.56 dB	
Block edge compliance	± 1.56 dB	
Spurious emissions conducted	> 3.6 GHz	± 1.56 dB
	> 7 GHz	± 1.56 dB
	> 18 GHz	± 2.31 dB
	≥ 40 GHz	± 2.97 dB
Spurious emissions radiated below 30 MHz	± 3 dB	
Spurious emissions radiated 30 MHz to 1 GHz	± 3 dB	
Spurious emissions radiated 1 GHz to 12.75 GHz	± 3.7 dB	
Spurious emissions radiated above 12.75 GHz	± 4.5 dB	

## 10 Additional information and comments

Reference documents: Customer Questionnaire\_F5688W\_Sagemcom\_v3.docx  
F5866WTMO\_ANTENNA MAPPING\_v2.xlsx  
1-3977\_22-03-21\_Annex\_MR\_A1.pdf  
1-3977\_22-03-21\_Annex\_MR\_A2.pdf

Special test descriptions: Although the device has 4 integrated antennas, for 5G NR band 77 only 2 antennas are used for TX mode (LTE\_M and 5GNR\_P).  
Supported bandwidths for 5G NR band 77: 10 MHz, 20 MHz, 30 MHz, 40 MHz, 50 MHz, 60 MHz, 70 MHz, 80 MHz, 90 MHz and 100 MHz.  
CP-OFDM and DFT-s-OFDM were investigated and DFT-s-OFDM was found to be the worst case.  
For 5G NR tests the MT8000A from Anritsu was used.

Configuration descriptions: None

EUT selection:

- Only one device available
- Devices selected by the customer
- Devices selected by the laboratory (Randomly)

## 11 RF measurements

### 11.1 Description of test setup

For the spurious measurements we use the substitution method according TIA/EIA 603.

## 12 Summary of measurement results

<input checked="" type="checkbox"/>	No deviations from the technical specifications were ascertained
<input type="checkbox"/>	There were deviations from the technical specifications ascertained
<input type="checkbox"/>	This test report is only a partial test report. The content and verdict of the performed test cases are listed below.

TC identifier	Description	verdict	date	Remark
RF-Testing	FCC: CFR Part 2 & Part 27	See table!	2023-01-18	-/-

### 12.1 Part 27: 5G NR band 77

Test Case	temperature conditions	power source voltages	C	NC	NA	NP	Remark
RF Output Power	Nominal	Nominal	<input checked="" type="checkbox"/>	<input type="checkbox"/>	<input type="checkbox"/>	<input type="checkbox"/>	-/-
Frequency Stability	Extreme	Extreme	<input checked="" type="checkbox"/>	<input type="checkbox"/>	<input type="checkbox"/>	<input type="checkbox"/>	-/-
Spurious Emissions Radiated	Nominal	Nominal	<input checked="" type="checkbox"/>	<input type="checkbox"/>	<input type="checkbox"/>	<input type="checkbox"/>	-/-
Spurious Emissions Conducted	Nominal	Nominal	<input checked="" type="checkbox"/>	<input type="checkbox"/>	<input type="checkbox"/>	<input type="checkbox"/>	-/-
Block Edge Compliance	Nominal	Nominal	<input checked="" type="checkbox"/>	<input type="checkbox"/>	<input type="checkbox"/>	<input type="checkbox"/>	-/-
Occupied Bandwidth	Nominal	Nominal	<input checked="" type="checkbox"/>	<input type="checkbox"/>	<input type="checkbox"/>	<input type="checkbox"/>	-/-

#### Notes:

<b>C</b>	Compliant	<b>NC</b>	Not compliant	<b>NA</b>	Not applicable	<b>NP</b>	Not performed
----------	-----------	-----------	---------------	-----------	----------------	-----------	---------------

## 13 RF measurements

### 13.1 Description of test setup

For the spurious measurements we use the substitution method according TIA/EIA 603.

### 13.2 Results 5G NR band 77

The EUT was set to transmit the maximum power.

### 13.2.1 RF output power / Peak to AVG ratio – 5G NR n77 – 3450 MHz to 3550 MHz

**Description:**

This paragraph contains average power, peak output power and EIRP measurements for the mobile station. In all cases, the peak output power is within the required mask (this mask is specified in the JTC standards, TIA PN3389 Vol. 1 Chap 7, and is no FCC requirement).

**Measurement:**

The mobile was set up for the maximum output power with pseudo random data modulation.

To determine the Peak-To-Average Power Ratio (PAPR) the measurement was performed with the Power Complementary Cumulative Distribution Function (CCDF).

Measurement parameters	
Detector:	Sample
AQT:	See plot
Used equipment:	See chapter 8.2 setup A & 8.4 setup A
Measurement uncertainty:	See chapter 9
Measurement procedure:	FCC: § 2.1046

**Limits:**

FCC
§27.50
Mobile devices are limited to 1Watt (30 dBm) EIRP. Mobile devices operating in these bands must employ a means for limiting power to the minimum necessary for successful communications. Equipment employed must be authorized in accordance with the provisions of § 27.51. Power measurements for transmissions by stations authorized under this section may be made either in accordance with a Commission-approved average power technique or in compliance with paragraph (j)(5) of this section. In measuring transmissions in this band using an average power technique, the peak-to-average ratio (PAR) of the transmission may not exceed 13 dB
Power: 30 dBm EIRP PAPR: 13 dB

**13.2.1.1 Results – conducted power**

Output Power (conducted)							
ANT1 + ANT2 sum							ANT1
Bandwidth (MHz)	Channel No. / Frequency (MHz)	RB Allocation – RB Offset	Average Output Power (dBm)	Average Output Power (dBm)	Average Output Power (dBm)	Average Output Power (dBm)	Average Output Power (dBm)
			QPSK	16-QAM	64-QAM	256-QAM	PI/2BPSK
10	630333 / 3455.0	1 RB low	22.5	22.6	22.6	22.7	24.9
		1 RB low+1	23.7	23.3	23.1	23.2	25.3
		1 RB high-1	23.7	23.3	23.1	23.1	25.3
		1 RB high	22.6	22.7	22.6	22.6	21.7
		50% RB mid	23.8	23.5	23.4	23.4	25.4
		100% RB	22.3	22.3	22.3	22.4	24.9
	633332 / 3550.0	1 RB low	22.7	22.6	22.5	22.6	22.1
		1 RB low+1	23.6	23.2	22.9	23.1	25.5
		1 RB high-1	23.7	23.2	22.9	23.0	25.6
		1 RB high	22.6	22.5	22.5	22.5	22.0
		50% RB mid	23.8	23.4	23.4	23.4	25.6
		100% RB	22.3	22.3	22.3	22.4	25.1
	636333 / 3545.0	1 RB low	22.7	22.6	22.6	22.8	22.4
		1 RB low+1	23.7	23.3	23.0	23.2	25.8
		1 RB high-1	23.8	23.4	23.2	23.2	25.8
		1 RB high	22.7	22.7	22.6	22.8	22.4
		50% RB mid	23.9	23.5	23.4	23.5	25.8
		100% RB	22.5	22.4	22.4	22.4	25.3
20	630666 / 3460.0	1 RB low	22.5	23.1	22.8	22.9	24.9
		1 RB low+1	24.0	23.6	23.4	23.6	25.6
		1 RB high-1	24.3	23.7	23.5	23.6	25.4
		1 RB high	23.1	23.1	22.9	23.0	25.3
		50% RB mid	24.0	23.6	23.6	23.6	25.4
		100% RB	22.6	22.6	22.6	22.6	24.9
	633332 / 3550.0	1 RB low	23.0	23.0	22.9	23.0	22.2
		1 RB low+1	24.0	23.6	23.4	23.4	25.8

Output Power (conducted)								
ANT1 + ANT2 sum							ANT1	
Bandwidth (MHz)	Channel No. / Frequency (MHz)	RB Allocation – RB Offset	Average Output Power (dBm)	Average Output Power (dBm)	Average Output Power (dBm)	Average Output Power (dBm)	Average Output Power (dBm)	
			QPSK	16-QAM	64-QAM	256-QAM	PI/2BPSK	
30	635998 / 3540.0	1 RB high-1	24.0	23.6	23.3	23.5	25.7	
		1 RB high	22.9	22.8	23.0	22.8	25.7	
		50% RB mid	24.0	23.5	23.5	23.6	25.7	
		100% RB	22.5	22.5	22.5	22.6	25.3	
		1 RB low	22.9	22.8	22.8	23.1	22.5	
		1 RB low+1	23.9	23.5	23.3	23.5	25.8	
		1 RB high-1	24.0	23.6	23.4	23.6	25.8	
		1 RB high	23.1	23.1	22.9	22.9	25.8	
	631000 / 3465.0	633332 / 3550.0	50% RB mid	24.0	23.5	23.5	23.5	25.8
			100% RB	22.5	22.5	22.6	22.5	25.7
			1 RB low	22.8	23.2	23.0	23.1	24.9
			1 RB low+1	24.1	23.7	23.4	23.5	25.7
			1 RB high-1	24.4	23.9	23.6	23.9	25.3
			1 RB high	23.3	23.4	23.1	23.4	25.7
635666 / 3535.0		633332 / 3550.0	50% RB mid	24.2	23.8	23.7	23.8	25.5
			100% RB	22.7	22.7	22.8	22.8	25.1
			1 RB low	23.3	23.2	23.1	23.2	22.2
			1 RB low+1	24.3	23.7	23.6	23.6	25.8
			1 RB high-1	24.1	23.7	23.4	23.7	25.8
			1 RB high	23.1	23.1	23.0	23.1	25.8
635666 / 3535.0		635666 / 3535.0	50% RB mid	24.1	23.6	23.6	23.7	25.7
			100% RB	22.6	22.6	22.7	22.7	25.4
			1 RB low	23.2	23.3	23.0	23.2	22.6
			1 RB low+1	24.1	23.8	23.4	23.6	25.8
			1 RB high-1	24.3	23.8	23.4	23.7	25.8
			1 RB high	23.1	23.2	23.0	23.0	25.8
635666 / 3535.0	635666 / 3535.0	50% RB mid	24.1	23.7	23.6	23.6	25.8	
		100% RB	22.7	22.7	22.7	22.6	25.7	
		1 RB low	23.2	23.3	23.0	23.2	22.6	
		1 RB low+1	24.1	23.8	23.4	23.6	25.8	
		1 RB high-1	24.3	23.8	23.4	23.7	25.8	
		1 RB high	23.1	23.2	23.0	23.0	25.8	

Output Power (conducted)							
ANT1 + ANT2 sum							ANT1
Bandwidth (MHz)	Channel No. / Frequency (MHz)	RB Allocation – RB Offset	Average Output Power (dBm)	Average Output Power (dBm)	Average Output Power (dBm)	Average Output Power (dBm)	Average Output Power (dBm)
			QPSK	16-QAM	64-QAM	256-QAM	PI/2BPSK
40	631332 / 3470.0	1 RB low	22.8	23.2	22.9	23.1	25.1
		1 RB low+1	24.0	23.7	23.4	23.4	25.7
		1 RB high-1	24.2	23.8	23.5	23.9	25.8
		1 RB high	23.2	23.2	22.9	23.1	25.6
		50% RB mid	24.2	23.7	23.8	23.8	25.4
		100% RB	22.7	22.8	22.8	22.8	25.0
	633332 / 3550.0	1 RB low	23.3	23.1	23.0	23.2	22.3
		1 RB low+1	24.1	23.7	23.4	23.9	25.5
		1 RB high-1	24.1	23.8	23.5	23.7	25.8
		1 RB high	23.1	23.2	22.9	22.8	25.8
		50% RB mid	24.1	23.7	23.7	23.8	25.7
		100% RB	22.7	22.7	22.7	22.8	25.3
	635332 / 3530.0	1 RB low	23.1	23.1	22.9	23.1	22.5
		1 RB low+1	24.1	23.7	23.3	23.5	25.8
		1 RB high-1	24.1	23.7	23.4	23.9	25.8
		1 RB high	23.1	23.1	22.9	22.9	25.8
		50% RB mid	24.2	23.7	23.7	23.7	25.8
		100% RB	22.7	22.6	22.7	22.7	25.6
50	631666 / 3475.0	1 RB low	22.6	23.2	22.9	23.1	24.9
		1 RB low+1	24.0	23.6	23.3	23.4	25.4
		1 RB high-1	23.9	23.5	23.2	23.5	25.6
		1 RB high	23.0	22.8	22.6	23.0	25.5
		50% RB mid	24.1	23.6	23.7	23.6	25.4
		100% RB	22.6	22.6	22.6	22.7	25.0
	633332 / 3550.0	1 RB low	23.2	23.1	22.9	23.2	22.0
		1 RB low+1	24.1	23.8	23.5	23.7	25.4
		1 RB high-1	23.8	23.4	23.2	23.4	25.8
		1 RB high	22.8	22.9	22.6	22.8	25.8



Output Power (conducted)							
ANT1 + ANT2 sum							ANT1
Bandwidth (MHz)	Channel No. / Frequency (MHz)	RB Allocation – RB Offset	Average Output Power (dBm)	Average Output Power (dBm)	Average Output Power (dBm)	Average Output Power (dBm)	Average Output Power (dBm)
			QPSK	16-QAM	64-QAM	256-QAM	PI/2BPSK
		50% RB mid	23.9	23.5	23.5	23.5	25.6
		100% RB	22.6	22.6	22.5	22.6	25.1
	634998 / 3525.0	1 RB low	23.0	23.1	22.7	23.0	22.2
		1 RB low+1	23.9	23.5	23.3	23.5	25.8
		1 RB high-1	23.9	23.5	23.3	23.5	25.8
		1 RB high	22.9	23.0	22.7	22.9	25.8
		50% RB mid	23.9	23.4	23.5	23.4	25.8
		100% RB	22.4	22.5	22.5	22.5	25.4
60	632000 / 3480.0	1 RB low	22.6	23.1	22.8	22.9	25.2
		1 RB low+1	23.8	23.4	23.2	23.5	25.3
		1 RB high-1	23.9	23.4	23.1	23.5	25.6
		1 RB high	22.9	22.9	22.6	22.8	22.1
		50% RB mid	24.1	23.7	23.7	23.7	25.4
		100% RB	22.5	22.6	22.6	22.7	24.9
	633332 / 3550.0	1 RB low	23.2	23.1	22.8	23.1	21.8
		1 RB low+1	23.9	23.6	23.3	23.5	25.2
		1 RB high-1	23.8	23.5	23.0	23.2	25.8
		1 RB high	22.8	22.9	22.6	22.8	22.5
		50% RB mid	24.0	23.5	23.5	23.6	25.7
		100% RB	22.5	22.5	22.6	22.6	25.2
	634666 / 3520.0	1 RB low	22.9	22.9	22.7	23.0	22.2
		1 RB low+1	23.9	23.5	23.2	23.5	25.6
		1 RB high-1	23.9	23.4	23.2	23.2	25.7
		1 RB high	23.0	22.9	22.7	22.7	22.2
		50% RB mid	24.0	23.5	23.5	23.5	25.8
		100% RB	22.5	22.4	22.5	22.5	25.4
70	632333 / 3485.0	1 RB low	22.4	22.8	22.4	22.6	25.0
		1 RB low+1	23.7	23.2	23.1	23.3	25.3

Output Power (conducted)								
ANT1 + ANT2 sum							ANT1	
Bandwidth (MHz)	Channel No. / Frequency (MHz)	RB Allocation – RB Offset	Average Output Power (dBm)	Average Output Power (dBm)	Average Output Power (dBm)	Average Output Power (dBm)	Average Output Power (dBm)	
			QPSK	16-QAM	64-QAM	256-QAM	PI/2BPSK	
80		1 RB high-1	23.9	23.2	23.0	23.1	25.5	
		1 RB high	22.8	22.8	22.5	22.8	25.6	
		50% RB mid	23.9	23.5	23.5	23.5	25.3	
		100% RB	22.5	22.4	22.5	22.5	24.8	
	633332 / 3550.0	1 RB low	22.8	22.7	22.5	22.6	21.6	
		1 RB low+1	23.8	23.4	23.0	23.2	25.1	
		1 RB high-1	23.7	23.2	22.8	23.0	25.8	
		1 RB high	22.6	22.6	22.4	22.5	25.7	
		50% RB mid	23.8	23.4	23.5	23.5	25.6	
		100% RB	22.4	22.4	22.5	22.5	25.1	
		634333 / 3515.0	1 RB low	23.0	23.0	22.7	23.0	21.9
			1 RB low+1	24.1	23.5	23.2	23.5	25.4
	1 RB high-1		23.8	23.3	23.1	23.2	25.8	
	1 RB high		22.8	22.8	22.5	22.4	25.7	
	50% RB mid		23.9	23.4	23.5	23.4	25.6	
	100% RB		22.4	22.4	22.4	22.5	25.1	
	632666 / 3490.0	1 RB low	22.5	22.9	22.7	22.8	24.9	
		1 RB low+1	23.8	23.4	23.0	23.2	25.2	
		1 RB high-1	23.8	23.5	23.0	23.1	25.7	
		1 RB high	22.7	22.7	22.5	22.6	25.7	
		50% RB mid	23.9	23.5	23.5	23.5	25.4	
100% RB		22.5	22.5	22.4	22.5	25.0		
633332 / 3550.0		1 RB low	22.9	22.9	22.5	22.8	21.5	
		1 RB low+1	23.8	23.3	23.2	23.3	25.0	
		1 RB high-1	23.7	23.4	23.1	23.2	25.8	
		1 RB high	22.7	22.8	22.6	22.9	25.8	
		50% RB mid	23.8	23.5	23.4	23.5	25.4	
		100% RB	22.4	22.4	22.4	22.5	25.0	

Output Power (conducted)							
ANT1 + ANT2 sum							ANT1
Bandwidth (MHz)	Channel No. / Frequency (MHz)	RB Allocation – RB Offset	Average Output Power (dBm)	Average Output Power (dBm)	Average Output Power (dBm)	Average Output Power (dBm)	Average Output Power (dBm)
			QPSK	16-QAM	64-QAM	256-QAM	PI/2BPSK
	633998 / 3510.0	1 RB low	23.0	23.0	22.9	23.0	21.6
		1 RB low+1	24.1	23.8	23.2	23.3	25.2
		1 RB high-1	24.0	23.5	23.2	23.3	25.7
		1 RB high	22.9	23.0	22.7	23.1	25.6
		50% RB mid	23.9	23.5	23.4	23.5	25.8
		100% RB	22.4	22.5	22.5	22.5	25.2
90	633000 / 3495.0	1 RB low	22.5	22.7	22.5	22.6	24.9
		1 RB low+1	23.6	23.2	22.9	23.1	25.2
		1 RB high-1	23.6	23.2	22.9	23.2	25.8
		1 RB high	22.7	22.8	22.4	22.8	25.8
		50% RB mid	23.9	23.4	23.5	23.4	25.2
		100% RB	22.4	22.4	22.5	22.5	25.0
	633332 / 3550.0	1 RB low	22.7	22.7	22.4	22.6	21.7
		1 RB low+1	23.7	23.2	23.1	23.0	25.1
		1 RB high-1	23.7	23.3	23.1	23.1	25.7
		1 RB high	22.8	22.8	22.4	22.8	25.7
		50% RB mid	23.9	23.5	23.5	23.4	25.2
		100% RB	22.5	22.5	22.6	22.5	25.0
	633666 / 3505.0	1 RB low	22.8	22.8	22.6	22.8	21.7
		1 RB low+1	23.9	23.4	23.2	23.3	25.0
		1 RB high-1	23.9	23.5	23.1	23.4	25.7
		1 RB high	22.9	22.9	22.8	23.0	25.7
		50% RB mid	24.0	23.4	23.5	23.5	25.4
		100% RB	22.5	22.5	22.5	22.5	25.0
100	-/-	-/-	-/-	-/-	-/-	-/-	-/-
		-/-	-/-	-/-	-/-	-/-	-/-
		-/-	-/-	-/-	-/-	-/-	-/-
		-/-	-/-	-/-	-/-	-/-	-/-

Output Power (conducted)							
ANT1 + ANT2 sum							ANT1
Bandwidth (MHz)	Channel No. / Frequency (MHz)	RB Allocation – RB Offset	Average Output Power (dBm) QPSK	Average Output Power (dBm) 16-QAM	Average Output Power (dBm) 64-QAM	Average Output Power (dBm) 256-QAM	Average Output Power (dBm) PI/2BPSK
		-/-	-/-	-/-	-/-	-/-	-/-
		-/-	-/-	-/-	-/-	-/-	-/-
	633332 / 3550.0	1 RB low	22.5	22.8	22.6	22.6	24.6
		1 RB low+1	23.7	23.2	23.2	23.0	25.3
		1 RB high-1	23.8	23.4	23.1	23.2	25.3
		1 RB high	22.8	22.9	22.4	22.8	25.3
		50% RB mid	23.9	23.4	23.5	23.5	25.2
		100% RB	22.5	22.4	22.4	22.5	24.6
	-/-	-/-	-/-	-/-	-/-	-/-	-/-
		-/-	-/-	-/-	-/-	-/-	-/-
		-/-	-/-	-/-	-/-	-/-	-/-
		-/-	-/-	-/-	-/-	-/-	-/-
		-/-	-/-	-/-	-/-	-/-	-/-
		-/-	-/-	-/-	-/-	-/-	-/-

### 13.2.1.2 Results – EIRP

Radiated output power (EIRP)						
Bandwidth (MHz)	Channel No. / Frequency (MHz)	ANT1+ANT2				ANT1
		Average Output Power (dBm) QPSK	Average Output Power (dBm) 16-QAM	Average Output Power (dBm) 64-QAM	Average Output Power (dBm) 256-QAM	Average Output Power (dBm) PI/2BPSK
10	630333 / 3455.0	28.6	28.3	28.2	28.2	29.6
	633332 / 3550.0	28.6	28.2	28.2	28.2	29.8
	636333 / 3545.0	28.7	28.3	28.2	28.3	30.0
20	630666 / 3460.0	29.1	28.5	28.4	28.4	29.8
	633332 / 3550.0	28.8	28.4	28.3	28.4	30.0
	635998 / 3540.0	28.8	28.4	28.3	28.4	30.0
30	631000 / 3465.0	29.2	28.7	28.5	28.7	29.9
	633332 / 3550.0	29.1	28.5	28.4	28.5	30.0
	635666 / 3535.0	29.1	28.6	28.4	28.5	30.0
40	631332 / 3470.0	29.0	28.6	28.6	28.7	30.0
	633332 / 3550.0	28.9	28.6	28.5	28.7	30.0
	635332 / 3530.0	29.0	28.5	28.5	28.7	30.0
50	631666 / 3475.0	28.9	28.4	28.5	28.4	29.8
	633332 / 3550.0	28.9	28.6	28.3	28.5	30.0
	634998 / 3525.0	28.7	28.3	28.3	28.3	30.0
60	632000 / 3480.0	28.9	28.5	28.5	28.5	29.8
	633332 / 3550.0	28.8	28.4	28.3	28.4	30.0
	634666 / 3520.0	28.8	28.3	28.3	28.3	30.0
70	632333 / 3485.0	28.7	28.3	28.3	28.3	29.8
	633332 / 3550.0	28.6	28.2	28.3	28.3	30.0
	634333 / 3515.0	28.9	28.3	28.3	28.3	30.0
80	632666 / 3490.0	28.7	28.3	28.3	28.3	29.9
	633332 / 3550.0	28.6	28.3	28.2	28.3	30.0
	633998 / 3510.0	28.9	28.6	28.2	28.3	30.0
90	633000 / 3495.0	28.7	28.2	28.3	28.2	30.0
	633332 / 3550.0	28.7	28.3	28.3	28.2	29.9

Radiated output power (EIRP)						
ANT1+ANT2						ANT1
Bandwidth (MHz)	Channel No. / Frequency (MHz)	Average Output Power (dBm)	Average Output Power (dBm)	Average Output Power (dBm)	Average Output Power (dBm)	Average Output Power (dBm)
		QPSK	16-QAM	64-QAM	256-QAM	PI/2BPSK
	633666 / 3505.0	28.8	28.3	28.3	28.3	29.9
100	-/-	-/-	-/-	-/-	-/-	-/-
	633332 / 3550.0	28.7	28.2	28.3	28.3	29.5
	-/-	-/-	-/-	-/-	-/-	-/-

### 13.2.1.3 Results – Peak to AVG ratio

Peak to average ratio (conducted)							
ANT1							ANT1
Bandwidth (MHz)	Channel No. / Frequency (MHz)	RB Allocation – RB Offset	Peak to Average ratio (dB)	Peak to Average ratio (dB)	Peak to Average ratio (dB)	Peak to Average ratio (dB)	Peak to Average ratio (dB)
			QPSK	16-QAM	64-QAM	256-QAM	PI/2BPSK
10	630333 / 3455.0	100% RB	5.22	5.63	5.05	7.24	5.60
	633332 / 3550.0	100% RB	5.97	5.56	5.23	7.42	5.15
	636333 / 3545.0	100% RB	5.98	5.80	6.26	6.52	6.57
20	630666 / 3460.0	100% RB	5.08	5.59	7.39	4.36	4.30
	633332 / 3550.0	100% RB	5.49	7.97	7.11	4.84	5.81
	635998 / 3540.0	100% RB	7.16	5.34	4.43	4.85	5.72
30	631000 / 3465.0	100% RB	6.39	7.43	6.10	7.84	6.79
	633332 / 3550.0	100% RB	7.28	7.26	7.18	5.75	6.15
	635666 / 3535.0	100% RB	5.31	7.93	5.96	5.26	6.50
40	631332 / 3470.0	100% RB	4.35	4.39	6.99	6.44	4.51
	633332 / 3550.0	100% RB	6.14	6.12	7.09	5.94	5.23
	635332 / 3530.0	100% RB	7.35	4.09	7.14	4.66	4.52
50	631666 / 3475.0	100% RB	4.19	6.30	6.31	4.77	5.57
	633332 / 3550.0	100% RB	4.87	5.25	4.03	7.23	6.84
	634998 / 3525.0	100% RB	4.26	6.33	4.80	6.03	4.63
60	632000 / 3480.0	100% RB	5.08	4.81	6.50	5.28	6.69
	633332 / 3550.0	100% RB	6.64	4.70	5.53	6.56	6.90
	634666 / 3520.0	100% RB	7.74	7.70	4.03	5.86	4.76
70	632333 / 3485.0	100% RB	4.18	5.36	4.01	6.40	4.75
	633332 / 3550.0	100% RB	5.91	4.19	6.90	4.60	6.18
	634333 / 3515.0	100% RB	7.41	6.67	7.09	4.81	5.32
80	632666 / 3490.0	100% RB	7.75	4.86	4.66	4.54	6.16
	633332 / 3550.0	100% RB	5.26	4.27	6.40	4.14	5.86
	633998 / 3510.0	100% RB	4.41	4.02	5.52	4.48	5.86
90	633000 / 3495.0	100% RB	4.92	5.77	7.23	7.40	5.32
	633332 / 3550.0	100% RB	5.48	4.88	5.42	4.26	4.46

Peak to average ratio (conducted)							
ANT1							ANT1
Bandwidth (MHz)	Channel No. / Frequency (MHz)	RB Allocation – RB Offset	Peak to Average ratio (dB) QPSK	Peak to Average ratio (dB) 16-QAM	Peak to Average ratio (dB) 64-QAM	Peak to Average ratio (dB) 256-QAM	Peak to Average ratio (dB) PI/2BPSK
	633666 / 3505.0	100% RB	4.36	7.93	4.34	5.82	6.39
100	-/-	-/-	-/-	-/-	-/-	-/-	-/-
	633332 / 3550.0	100% RB	4.35	4.65	5.39	7.29	6.48
	-/-	-/-	-/-	-/-	-/-	-/-	-/-



### 13.2.2 RF output power / Peak to AVG ratio – 5G NR n77 – 3700 MHz to 3980 MHz

**Description:**

This paragraph contains average power, peak output power and EIRP measurements for the mobile station. In all cases, the peak output power is within the required mask (this mask is specified in the JTC standards, TIA PN3389 Vol. 1 Chap 7, and is no FCC requirement).

**Measurement:**

The mobile was set up for the maximum output power with pseudo random data modulation.

To determine the Peak-To-Average Power Ratio (PAPR) the measurement was performed with the Power Complementary Cumulative Distribution Function (CCDF).

Measurement parameters	
Detector:	Sample
AQT:	See plot
Used equipment:	See chapter 8.2 setup A & 8.4 setup A
Measurement uncertainty:	See chapter 9
Measurement procedure:	FCC: § 2.1046

**Limits:**

FCC
§27.50
Mobile and portable stations are limited to 1 Watt EIRP. Mobile and portable stations operating in these bands must employ a means for limiting power to the minimum necessary for successful communications. Equipment employed must be authorized in accordance with the provisions of § 27.51. Power measurements for transmissions by stations authorized under this section may be made either in accordance with a Commission-approved average power technique or in compliance with paragraph (k)(5) of this section. In measuring transmissions in this band using an average power technique, the peak-to-average ratio (PAR) of the transmission may not exceed 13 dB.
Power: 30 dBm EIRP PAPR: 13 dB

**13.2.2.1 Results – conducted power**

Output Power (conducted)							
ANT1 + ANT2 sum							ANT1
Bandwidth (MHz)	Channel No. / Frequency (MHz)	RB Allocation – RB Offset	Average Output Power (dBm)	Average Output Power (dBm)	Average Output Power (dBm)	Average Output Power (dBm)	Average Output Power (dBm)
			QPSK	16-QAM	64-QAM	256-QAM	PI/2BPSK
10	647000 / 3705.0	1 RB low	22.4	24.2	22.2	19.3	21.0
		1 RB low+1	24.4	24.1	22.2	19.4	24.5
		1 RB high-1	24.9	22.5	22.5	19.8	25.0
		1 RB high	22.7	24.1	22.6	19.7	21.5
		50% RB mid	24.6	23.0	22.6	19.6	24.9
		100% RB	23.1	22.7	22.5	19.5	24.3
	656000 / 3840.0	1 RB low	22.7	24.1	22.4	19.7	20.8
		1 RB low+1	24.6	24.2	22.3	19.7	24.3
		1 RB high-1	24.4	22.7	22.2	19.4	24.2
		1 RB high	22.6	24.2	22.3	19.7	20.7
		50% RB mid	24.4	23.1	22.5	19.4	24.3
		100% RB	23.0	22.5	22.5	19.5	23.9
	665000 / 3975.0	1 RB low	22.6	24.1	22.5	19.7	21.2
		1 RB low+1	24.5	24.5	22.3	19.6	24.6
		1 RB high-1	24.6	22.8	22.3	19.5	24.5
		1 RB high	22.5	24.3	22.3	19.5	21.0
		50% RB mid	24.5	23.3	22.5	19.5	24.5
		100% RB	23.1	22.8	22.5	19.5	24.1
20	647333 / 3710.0	1 RB low	23.3	24.2	22.4	19.7	21.0
		1 RB low+1	24.5	24.0	22.4	19.6	24.5
		1 RB high-1	25.0	22.5	22.8	20.0	24.4
		1 RB high	23.0	24.0	22.8	20.0	24.4
		50% RB mid	24.9	23.0	22.8	19.8	24.5
		100% RB	23.3	22.4	22.8	19.9	24.1
		1 RB low	22.8	23.9	22.7	19.8	21.5

Output Power (conducted)								
ANT1 + ANT2 sum							ANT1	
Bandwidth (MHz)	Channel No. / Frequency (MHz)	RB Allocation – RB Offset	Average Output Power (dBm)	Average Output Power (dBm)	Average Output Power (dBm)	Average Output Power (dBm)	Average Output Power (dBm)	
			QPSK	16-QAM	64-QAM	256-QAM	PI/2BPSK	
30	656000 / 3840.0	1 RB low+1	24.7	23.8	22.6	19.8	24.9	
		1 RB high-1	24.7	22.3	22.5	19.6	24.7	
		1 RB high	22.7	23.9	22.5	19.6	24.8	
		50% RB mid	24.7	22.9	22.7	19.7	24.9	
		100% RB	23.2	22.5	22.7	19.7	24.4	
	664666 / 3970.0	1 RB low	22.8	24.0	22.7	19.8	24.6	
		1 RB low+1	24.8	24.1	22.6	19.8	24.8	
		1 RB high-1	24.7	22.5	22.4	19.7	25.1	
		1 RB high	22.7	24.3	22.4	19.7	25.1	
		50% RB mid	24.6	23.1	22.7	19.7	25.8	
		100% RB	23.2	22.9	22.7	19.7	25.4	
	30	648000 / 3720.0	1 RB low	23.4	24.1	22.5	19.7	25.5
			1 RB low+1	24.7	23.8	22.4	19.7	25.6
			1 RB high-1	25.1	22.2	22.9	20.1	25.8
1 RB high			23.1	23.9	22.8	20.1	25.8	
50% RB mid			24.9	22.9	22.9	20.0	25.8	
100% RB			23.4	22.6	22.9	19.9	25.4	
656000 / 3840.0		1 RB low	22.8	23.9	22.7	19.8	21.9	
		1 RB low+1	24.8	23.8	22.5	19.8	25.3	
		1 RB high-1	24.8	22.2	22.4	19.6	25.3	
		1 RB high	22.6	23.8	22.4	19.7	25.4	
		50% RB mid	24.7	22.7	22.7	19.7	25.4	
		100% RB	23.2	22.5	22.7	19.7	24.8	
664000 / 3960.0		1 RB low	22.9	24.0	22.8	19.9	22.5	
		1 RB low+1	25.0	24.1	22.6	19.9	25.8	
	1 RB high-1	24.8	22.6	22.6	19.9	25.7		
	1 RB high	22.9	24.4	22.5	19.8	25.6		

Output Power (conducted)							
ANT1 + ANT2 sum							ANT1
Bandwidth (MHz)	Channel No. / Frequency (MHz)	RB Allocation – RB Offset	Average Output Power (dBm)	Average Output Power (dBm)	Average Output Power (dBm)	Average Output Power (dBm)	Average Output Power (dBm)
			QPSK	16-QAM	64-QAM	256-QAM	PI/2BPSK
		50% RB mid	24.8	23.2	22.8	19.8	25.7
		100% RB	23.3	22.7	22.8	19.8	25.2
40	648000 / 3720.0	1 RB low	23.5	24.1	22.7	19.9	25.5
		1 RB low+1	24.8	23.9	22.6	19.9	25.8
		1 RB high-1	25.2	22.2	23.1	20.3	25.8
		1 RB high	23.2	23.9	23.1	20.3	25.8
		50% RB mid	25.0	22.8	23.1	20.0	25.8
		100% RB	23.6	22.4	23.1	20.1	25.5
	656000 / 3840.0	1 RB low	23.0	23.9	22.8	20.0	22.0
		1 RB low+1	24.9	23.7	22.7	20.0	25.5
		1 RB high-1	24.7	22.2	22.4	19.6	25.4
		1 RB high	22.7	23.8	22.4	19.7	25.3
		50% RB mid	24.7	22.7	22.7	19.7	25.3
		100% RB	23.2	22.6	22.7	19.7	24.8
	664000 / 3960.0	1 RB low	22.9	24.0	22.7	19.9	22.3
		1 RB low+1	24.8	24.1	22.5	19.9	25.8
		1 RB high-1	24.7	22.5	22.5	19.9	25.6
		1 RB high	22.7	24.2	22.5	19.8	25.7
		50% RB mid	24.8	23.1	22.8	19.8	25.8
		100% RB	23.3	22.8	22.8	19.7	25.2
50	648333 / 3725.0	1 RB low	23.3	24.0	22.2	19.6	22.4
		1 RB low+1	24.5	23.8	22.2	19.5	25.8
		1 RB high-1	25.0	22.2	22.7	19.9	24.9
		1 RB high	22.9	23.9	22.7	19.9	24.9
		50% RB mid	24.8	22.9	22.8	19.7	25.2
		100% RB	23.2	22.3	22.7	19.8	24.7
		1 RB low	22.7	23.6	22.5	19.8	21.6

Output Power (conducted)								
ANT1 + ANT2 sum							ANT1	
Bandwidth (MHz)	Channel No. / Frequency (MHz)	RB Allocation – RB Offset	Average Output Power (dBm)	Average Output Power (dBm)	Average Output Power (dBm)	Average Output Power (dBm)	Average Output Power (dBm)	
			QPSK	16-QAM	64-QAM	256-QAM	PI/2BPSK	
60	656000 / 3840.0	1 RB low+1	24.7	23.8	22.3	19.6	25.1	
		1 RB high-1	24.6	22.4	22.2	19.5	25.0	
		1 RB high	22.5	23.8	22.3	19.5	25.1	
		50% RB mid	24.5	22.8	22.5	19.6	25.4	
		100% RB	23.0	22.6	22.5	19.5	24.7	
	663666 / 3955.0	1 RB low	22.8	23.9	22.4	19.6	21.6	
		1 RB low+1	24.7	24.1	22.3	19.6	25.1	
		1 RB high-1	24.7	22.6	22.4	19.6	25.7	
		1 RB high	22.6	24.3	22.5	19.6	25.8	
		50% RB mid	24.7	23.1	22.7	19.7	25.2	
	60	648666 / 3730.0	1 RB low	23.3	24.1	22.3	19.5	25.1
			1 RB low+1	24.5	23.8	22.3	19.5	25.4
			1 RB high-1	24.9	22.2	22.6	19.8	25.3
			1 RB high	22.8	23.9	22.6	19.9	21.7
50% RB mid			24.8	22.8	22.8	19.9	25.7	
100% RB			23.3	22.5	22.8	19.8	25.2	
656000 / 3840.0		1 RB low	22.6	23.8	22.5	19.6	21.5	
		1 RB low+1	24.6	24.0	22.4	19.6	25.0	
		1 RB high-1	24.4	22.3	22.3	19.4	25.1	
		1 RB high	22.4	23.7	22.3	19.4	21.4	
		50% RB mid	24.5	22.7	22.5	19.5	25.1	
		100% RB	23.0	23.0	22.5	19.6	24.7	
663333 / 3950.0		1 RB low	22.4	22.4	22.2	19.4	21.7	
		1 RB low+1	24.4	24.4	22.1	19.4	25.2	
	1 RB high-1	24.3	24.3	22.1	19.3	25.1		
	1 RB high	22.2	22.2	22.0	19.3	21.6		

Output Power (conducted)							
ANT1 + ANT2 sum							ANT1
Bandwidth (MHz)	Channel No. / Frequency (MHz)	RB Allocation – RB Offset	Average Output Power (dBm)	Average Output Power (dBm)	Average Output Power (dBm)	Average Output Power (dBm)	Average Output Power (dBm)
			QPSK	16-QAM	64-QAM	256-QAM	PI/2BPSK
		50% RB mid	24.3	24.3	22.3	19.4	25.4
		100% RB	22.8	22.8	22.3	19.4	24.8
70	649000 / 3735.0	1 RB low	23.1	23.1	22.2	19.5	25.0
		1 RB low+1	24.4	24.4	22.1	19.4	25.4
		1 RB high-1	24.6	24.6	22.3	19.6	24.8
		1 RB high	22.5	22.5	22.2	19.5	24.8
		50% RB mid	24.7	24.7	22.7	19.9	25.6
		100% RB	23.1	23.1	22.6	19.7	25.0
	656000 / 3840.0	1 RB low	22.6	22.6	22.4	19.7	21.5
		1 RB low+1	24.5	24.5	22.2	19.6	25.0
		1 RB high-1	24.3	24.3	22.0	19.1	24.9
		1 RB high	22.2	22.2	21.9	19.1	24.8
		50% RB mid	24.4	24.4	22.4	19.4	25.0
		100% RB	22.8	22.8	22.4	19.3	24.6
	663000 / 3945.0	1 RB low	22.4	22.4	22.2	19.4	21.8
		1 RB low+1	24.4	24.4	22.1	19.3	25.1
		1 RB high-1	24.2	24.2	22.0	19.1	25.0
		1 RB high	22.1	22.1	21.9	19.1	25.0
		50% RB mid	24.2	24.2	22.3	19.2	25.3
		100% RB	22.7	22.7	22.2	19.2	24.7
80	649333 / 3740.0	1 RB low	23.3	23.3	22.2	19.4	24.9
		1 RB low+1	24.4	24.4	22.1	19.4	25.4
		1 RB high-1	24.6	24.6	22.3	19.5	24.8
		1 RB high	22.5	22.5	22.3	19.5	24.8
		50% RB mid	24.8	24.8	22.8	19.9	25.6
		100% RB	23.2	23.2	22.6	19.7	24.9
		1 RB low	22.6	22.6	22.5	19.6	21.5

Output Power (conducted)								
ANT1 + ANT2 sum							ANT1	
Bandwidth (MHz)	Channel No. / Frequency (MHz)	RB Allocation – RB Offset	Average Output Power (dBm)	Average Output Power (dBm)	Average Output Power (dBm)	Average Output Power (dBm)	Average Output Power (dBm)	
			QPSK	16-QAM	64-QAM	256-QAM	PI/2BPSK	
90	656000 / 3840.0	1 RB low+1	24.5	24.5	22.2	19.5	24.8	
		1 RB high-1	24.2	24.2	22.0	19.1	24.6	
		1 RB high	22.1	22.1	22.1	19.2	24.7	
		50% RB mid	24.4	24.4	22.4	19.4	25.1	
		100% RB	22.9	22.9	22.3	19.4	24.5	
	662666 / 3940.0	1 RB low	22.3	22.3	22.1	19.2	21.4	
		1 RB low+1	24.3	24.3	21.9	19.1	24.8	
		1 RB high-1	24.3	24.3	22.0	19.2	25.1	
		1 RB high	22.2	22.2	22.0	19.3	25.0	
		50% RB mid	24.3	24.3	22.2	19.2	25.3	
		100% RB	22.7	22.7	22.2	19.2	24.6	
	90	649666 / 3745.0	1 RB low	23.1	23.1	22.3	19.5	25.0
			1 RB low+1	24.4	24.4	22.1	19.4	25.2
			1 RB high-1	24.5	24.5	22.3	19.5	24.7
1 RB high			22.5	22.5	22.3	19.5	24.8	
50% RB mid			24.7	24.7	22.7	19.8	25.7	
100% RB			23.1	23.1	22.7	19.6	24.8	
656000 / 3840.0		1 RB low	22.7	22.7	22.5	19.7	21.4	
		1 RB low+1	24.6	24.6	22.4	19.6	24.9	
		1 RB high-1	24.2	24.2	22.0	19.1	24.7	
		1 RB high	22.2	22.2	22.0	19.1	24.7	
		50% RB mid	24.4	24.4	22.4	19.4	25.0	
		100% RB	22.9	22.9	22.4	19.4	24.5	
662333 / 3935.0		1 RB low	22.2	22.2	22.1	19.3	21.2	
		1 RB low+1	24.1	24.1	21.8	19.1	24.6	
	1 RB high-1	24.4	24.4	22.1	19.4	25.2		
	1 RB high	22.3	22.3	22.1	19.3	25.2		

Output Power (conducted)							
ANT1 + ANT2 sum							ANT1
Bandwidth (MHz)	Channel No. / Frequency (MHz)	RB Allocation – RB Offset	Average Output Power (dBm)	Average Output Power (dBm)	Average Output Power (dBm)	Average Output Power (dBm)	Average Output Power (dBm)
			QPSK	16-QAM	64-QAM	256-QAM	PI/2BPSK
		50% RB mid	24.3	24.3	22.3	19.3	25.0
		100% RB	22.8	22.8	22.3	19.3	24.7
100	650000 / 3750.0	1 RB low	23.1	23.1	22.3	19.5	24.9
		1 RB low+1	24.3	24.3	22.2	19.4	25.2
		1 RB high-1	24.5	24.5	22.4	19.5	24.8
		1 RB high	22.4	22.4	22.4	19.6	24.8
		50% RB mid	24.8	24.8	22.8	19.8	25.4
		100% RB	23.1	23.1	22.6	19.8	24.8
	656000 / 3840.0	1 RB low	22.7	22.7	22.7	19.8	21.5
		1 RB low+1	24.5	24.5	22.4	19.6	24.8
		1 RB high-1	24.2	24.2	21.9	19.1	24.6
		1 RB high	22.1	22.1	21.9	19.1	24.6
		50% RB mid	24.4	24.4	22.4	19.3	25.0
		100% RB	22.8	22.8	22.4	19.4	24.5
	662000 / 3930.0	1 RB low	22.4	22.4	22.2	19.4	21.3
		1 RB low+1	24.2	24.2	22.0	19.2	24.7
		1 RB high-1	24.4	24.4	22.1	19.3	25.1
		1 RB high	22.2	22.2	22.1	19.3	25.1
		50% RB mid	24.2	24.2	22.3	19.3	25.2
		100% RB	22.7	22.7	22.3	19.2	24.6



### 13.2.2.2 Results – EIRP

Radiated output power (EIRP)						
Bandwidth (MHz)	Channel No. / Frequency (MHz)	ANT1+ANT2				ANT1
		Average Output Power (dBm) QPSK	Average Output Power (dBm) 16-QAM	Average Output Power (dBm) 64-QAM	Average Output Power (dBm) 256-QAM	Average Output Power (dBm) PI/2BPSK
10	647000 / 3705.0	29.7	29.0	27.4	24.6	29.2
	656000 / 3840.0	29.4	29.0	27.3	24.5	28.5
	665000 / 3975.0	29.4	29.3	27.3	24.5	28.8
20	647333 / 3710.0	29.8	29.0	27.6	24.8	28.7
	656000 / 3840.0	29.5	28.7	27.5	24.6	29.1
	664666 / 3970.0	29.6	29.1	27.5	24.6	30.0
30	648000 / 3720.0	29.9	28.9	27.7	24.9	30.0
	656000 / 3840.0	29.6	28.7	27.5	24.6	29.6
	664000 / 3960.0	29.8	29.2	27.6	24.7	30.0
40	648000 / 3720.0	30.0	28.9	27.9	25.1	30.0
	656000 / 3840.0	29.7	28.7	27.6	24.8	29.7
	664000 / 3960.0	29.6	29.0	27.6	24.7	30.0
50	648333 / 3725.0	29.8	28.8	27.6	24.7	30.0
	656000 / 3840.0	29.5	28.6	27.3	24.6	29.6
	663666 / 3955.0	29.5	29.1	27.5	24.5	30.0
60	648666 / 3730.0	29.7	28.9	27.6	24.7	29.9
	656000 / 3840.0	29.4	28.8	27.3	24.4	29.3
	663333 / 3950.0	29.2	29.2	27.1	24.2	29.6
70	649000 / 3735.0	29.5	29.5	27.5	24.7	29.8
	656000 / 3840.0	29.3	29.3	27.2	24.5	29.2
	663000 / 3945.0	29.2	29.2	27.1	24.2	29.5
80	649333 / 3740.0	29.6	29.6	27.6	24.7	29.8
	656000 / 3840.0	29.3	29.3	27.3	24.4	29.3
	662666 / 3940.0	29.1	29.1	27.0	24.1	29.5
90	649666 / 3745.0	29.5	29.5	27.5	24.6	29.9
	656000 / 3840.0	29.4	29.4	27.3	24.5	29.2

Radiated output power (EIRP)						
ANT1+ANT2						ANT1
Bandwidth (MHz)	Channel No. / Frequency (MHz)	Average Output Power (dBm)	Average Output Power (dBm)	Average Output Power (dBm)	Average Output Power (dBm)	Average Output Power (dBm)
		QPSK	16-QAM	64-QAM	256-QAM	PI/2BPSK
	662333 / 3935.0	29.2	29.2	27.1	24.2	29.4
100	650000 / 3750.0	29.6	29.6	27.6	24.6	29.6
	656000 / 3840.0	29.3	29.3	27.5	24.6	29.2
	662000 / 3930.0	29.2	29.2	27.1	24.2	29.4

### 13.2.2.3 Results – Peak to AVG ratio

Peak to average ratio (conducted)							
ANT1							ANT1
Bandwidth (MHz)	Channel No. / Frequency (MHz)	RB Allocation – RB Offset	Peak to Average ratio (dB)	Peak to Average ratio (dB)	Peak to Average ratio (dB)	Peak to Average ratio (dB)	Peak to Average ratio (dB)
			QPSK	16-QAM	64-QAM	256-QAM	PI/2BPSK
10	647000 / 3705.0	100% RB	5.70	5.22	7.71	5.36	6.36
	656000 / 3840.0	100% RB	6.17	6.59	7.32	6.67	5.21
	665000 / 3975.0	100% RB	5.91	5.40	7.62	6.49	5.59
20	647333 / 3710.0	100% RB	5.97	4.75	7.48	5.00	6.20
	656000 / 3840.0	100% RB	6.51	7.39	6.93	4.78	4.01
	664666 / 3970.0	100% RB	6.93	6.72	5.97	5.16	4.62
30	648000 / 3720.0	100% RB	4.32	6.57	5.05	7.41	4.77
	656000 / 3840.0	100% RB	4.99	6.68	6.18	4.14	6.78
	664000 / 3960.0	100% RB	4.79	5.39	7.41	7.95	6.89
40	648000 / 3720.0	100% RB	5.12	7.12	4.93	4.11	4.39
	656000 / 3840.0	100% RB	4.64	7.03	5.86	5.00	5.32
	664000 / 3960.0	100% RB	7.45	5.16	4.03	5.55	4.47
50	648333 / 3725.0	100% RB	4.25	7.02	6.90	5.89	4.07
	656000 / 3840.0	100% RB	7.12	5.41	4.67	7.38	5.32
	663666 / 3955.0	100% RB	4.46	4.29	5.50	4.50	6.55
60	648666 / 3730.0	100% RB	7.85	4.15	7.84	4.68	4.52
	656000 / 3840.0	100% RB	6.47	4.07	4.89	5.81	4.98
	663333 / 3950.0	100% RB	7.63	7.63	7.48	6.51	5.96
70	649000 / 3735.0	100% RB	5.91	6.52	7.95	5.11	4.67
	656000 / 3840.0	100% RB	7.48	7.21	5.92	7.31	4.34
	663000 / 3945.0	100% RB	7.54	5.22	5.01	5.08	5.19
80	649333 / 3740.0	100% RB	4.93	5.44	4.83	5.29	6.61
	656000 / 3840.0	100% RB	7.63	6.78	6.72	7.21	4.58
	662666 / 3940.0	100% RB	6.06	4.14	7.92	6.73	6.32
90	649666 / 3745.0	100% RB	5.81	7.19	7.59	7.98	6.68
	656000 / 3840.0	100% RB	5.43	6.25	7.16	6.21	5.88

Peak to average ratio (conducted)							
ANT1							ANT1
Bandwidth (MHz)	Channel No. / Frequency (MHz)	RB Allocation – RB Offset	Peak to Average ratio (dB) QPSK	Peak to Average ratio (dB) 16-QAM	Peak to Average ratio (dB) 64-QAM	Peak to Average ratio (dB) 256-QAM	Peak to Average ratio (dB) PI/2BPSK
	662333 / 3935.0	100% RB	7.93	4.43	5.45	5.23	4.53
100	650000 / 3750.0	100% RB	6.45	4.08	5.21	5.36	6.96
	656000 / 3840.0	100% RB	5.81	4.04	7.51	7.65	5.69
	662000 / 3930.0	100% RB	7.84	4.64	6.96	6.94	4.59

### 13.2.3 Frequency stability – 5G NR n77 – 3450 MHz to 3550 MHz

#### Description:

1. Measure the carrier frequency at room temperature.
2. Subject the mobile station to overnight soak at -30 C.
3. With the mobile station, powered with  $V_{nom}$ , connected to the CMW500 and in a simulated call on channel 18900 (center channel), measure the carrier frequency. These measurements should be made within two minutes of powering up the mobile station, to prevent significant self warming.
4. Repeat the above measurements at 10°C increments from -30°C to +50°C. Allow at least 1.5 hours at each temperature, unpowered, before making measurements.
5. Re-measure carrier frequency at room temperature with  $V_{nom}$ . Vary supply voltage from  $V_{min}$  to  $V_{max}$ , in 0.1 Volt steps re-measuring carrier frequency at each voltage. Pause at  $V_{nom}$  for 1.5 hours unpowered, to allow any self heating to stabilize, before continuing.
6. At all temperature levels hold the temperature to +/- 0.5°C during the measurement procedure.

#### Measurement:

Measurement parameters	
Detector:	Measured with CMW500
Sweep time:	
Video bandwidth:	
Resolution bandwidth:	
Span:	
Trace-Mode:	
Used equipment:	See chapter 8.4 setup A
Measurement uncertainty:	See chapter 9
Measurement procedure:	FCC: § 2.1055

#### Limits:

FCC
§27.54
The frequency stability shall be sufficient to ensure that the fundamental emissions stay within the authorized bands of operation.

**Results:****AFC FREQ ERROR versus VOLTAGE**

Voltage (V)	Frequency Low channel (MHz) (3455 MHz)	Frequency High channel (MHz) (3545 MHz)	Frequency Error (Hz)	Frequency Error (ppm)
V <sub>low</sub>	3455.010		13	0.004
		3544.980	7	0.002
V <sub>nom</sub>	3455.010		22	0.006
		3544.980	13	0.004
V <sub>high</sub>	3455.010		18	0.005
		3544.980	11	0.003

**AFC FREQ ERROR versus TEMPERATURE**

Temperature (°C)	Frequency Low channel (MHz) (3455 MHz)	Frequency High channel (MHz) (3545 MHz)	Frequency Error (Hz)	Frequency Error (ppm)
50	3455.010		15	0.004
		3544.980	15	0.004
40	3455.010		12	0.003
		3544.980	15	0.004
30	3455.010		17	0.005
		3544.980	14	0.004
20	3455.010		22	0.006
		3544.980	13	0.004
10	3455.010		11	0.003
		3544.980	9	0.003
0	3455.010		13	0.004
		3544.980	18	0.005
-10	3455.010		18	0.005
		3544.980	15	0.004
-20	3455.010		19	0.005
		3544.980	13	0.004
-30	3455.010		13	0.004
		3544.980	11	0.003

### 13.2.4 Frequency stability – 5G NR n77 – 3700 MHz to 3980 MHz

**Description:**

1. Measure the carrier frequency at room temperature.
2. Subject the mobile station to overnight soak at -30 C.
3. With the mobile station, powered with  $V_{nom}$ , connected to the CMW500 and in a simulated call on channel 18900 (center channel), measure the carrier frequency. These measurements should be made within two minutes of powering up the mobile station, to prevent significant self warming.
4. Repeat the above measurements at 10°C increments from -30°C to +50°C. Allow at least 1.5 hours at each temperature, unpowered, before making measurements.
5. Re-measure carrier frequency at room temperature with  $V_{nom}$ . Vary supply voltage from  $V_{min}$  to  $V_{max}$ , in 0.1 Volt steps re-measuring carrier frequency at each voltage. Pause at  $V_{nom}$  for 1.5 hours unpowered, to allow any self heating to stabilize, before continuing.
6. At all temperature levels hold the temperature to +/- 0.5°C during the measurement procedure.

**Measurement:**

Measurement parameters	
Detector:	Measured with MT8000
Sweep time:	
Video bandwidth:	
Resolution bandwidth:	
Span:	
Trace-Mode:	
Used equipment:	See chapter 8.4 setup A
Measurement uncertainty:	See chapter 9
Measurement procedure:	FCC: § 2.1055

**Limits:**

FCC
§27.54
The frequency stability shall be sufficient to ensure that the fundamental emissions stay within the authorized bands of operation.

**Results:****AFC FREQ ERROR versus VOLTAGE**

Voltage (V)	Frequency Low channel (MHz) (3705 MHz)	Frequency High channel (MHz) (3975 MHz)	Frequency Error (Hz)	Frequency Error (ppm)
V <sub>low</sub>	3705.000		11	0.003
		3975.000	7	0.002
V <sub>nom</sub>	3705.000		16	0.004
		3975.000	11	0.003
V <sub>high</sub>	3705.000		10	0.003
		3975.000	13	0.003

**AFC FREQ ERROR versus TEMPERATURE**

Temperature (°C)	Frequency Low channel (MHz) (3705 MHz)	Frequency High channel (MHz) (3975 MHz)	Frequency Error (Hz)	Frequency Error (ppm)
50	3705.000		11	0.003
		3975.000	13	0.003
40	3705.000		17	0.005
		3975.000	13	0.003
30	3705.000		18	0.005
		3975.000	8	0.002
20	3705.000		17	0.005
		3975.000	17	0.004
10	3705.000		12	0.003
		3975.000	12	0.003
0	3705.000		10	0.003
		3975.000	7	0.002
-10	3705.000		10	0.003
		3975.000	9	0.002
-20	3705.000		19	0.005
		3975.000	7	0.002
-30	3705.000		12	0.003
		3975.000	17	0.004



### 13.2.5 Spurious emissions radiated – 5G NR n77 – 3450 MHz to 3550 MHz

#### Description:

The following steps outline the procedure used to measure the radiated emissions from the mobile station. The site is constructed in accordance with ANSI C63.4:2014 requirements and is recognized by the FCC to be in compliance for a 3 and a 10 meter site. The spectrum was scanned from 30 MHz to the 10th harmonic of the highest frequency generated within the equipment. The resolution bandwidth is set as outlined in Part 27.53. The spectrum was scanned with the mobile station transmitting at carrier frequencies that pertain to low, middle and highest channels of the 5G NR band 77.

#### Measurement:

Measurement parameters	
Detector:	Peak
Sweep time:	2 sec.
Resolution bandwidth:	1 MHz
Video bandwidth:	3 MHz
Span:	100 MHz Steps
Trace mode:	Max Hold
Used equipment:	See chapter 8.1 setup A & 8.2 setup A and B & setup 8.3 A
Measurement uncertainty:	See chapter 9
Measurement procedure	FCC: § 2.1053

#### Limits:

FCC
§ 27.53
For mobile operations in the 3450 MHz to 3550 MHz band, the radiated power of any emission outside the licensee`s authorized bandwidth shall not exceed -13dBm/MHz

**Results:** antenna 1+2

<b>BPSK modulation</b>	<b>Lowest channel</b>		<b>Middle channel</b>		<b>Highest channel</b>	
Bandwidth (MHz)	Spurious emissions (MHz)	Level (dBm)	Spurious emissions (MHz)	Level (dBm)	Spurious emissions (MHz)	Level (dBm)
20 MHz	-/-	-/-	-/-	-/-	-/-	-/-
	-/-	-/-	-/-	-/-	-/-	-/-

<b>QPSK modulation</b>	<b>Lowest channel</b>		<b>Middle channel</b>		<b>Highest channel</b>	
Bandwidth (MHz)	Spurious emissions (MHz)	Level (dBm)	Spurious emissions (MHz)	Level (dBm)	Spurious emissions (MHz)	Level (dBm)
20 MHz	-/-	-/-	-/-	-/-	-/-	-/-
	-/-	-/-	-/-	-/-	-/-	-/-

<b>16-QAM modulation</b>	<b>Lowest channel</b>		<b>Middle channel</b>		<b>Highest channel</b>	
Bandwidth (MHz)	Spurious emissions (MHz)	Level (dBm)	Spurious emissions (MHz)	Level (dBm)	Spurious emissions (MHz)	Level (dBm)
20 MHz	-/-	-/-	-/-	-/-	-/-	-/-
	-/-	-/-	-/-	-/-	-/-	-/-

<b>64-QAM modulation</b>	<b>Lowest channel</b>		<b>Middle channel</b>		<b>Highest channel</b>	
Bandwidth (MHz)	Spurious emissions (MHz)	Level (dBm)	Spurious emissions (MHz)	Level (dBm)	Spurious emissions (MHz)	Level (dBm)
20 MHz	-/-	-/-	-/-	-/-	-/-	-/-
	-/-	-/-	-/-	-/-	-/-	-/-

<b>256-QAM modulation</b>	<b>Lowest channel</b>		<b>Middle channel</b>		<b>Highest channel</b>	
Bandwidth (MHz)	Spurious emissions (MHz)	Level (dBm)	Spurious emissions (MHz)	Level (dBm)	Spurious emissions (MHz)	Level (dBm)
20 MHz	-/-	-/-	-/-	-/-	-/-	-/-
	-/-	-/-	-/-	-/-	-/-	-/-

**Plots:** antenna 1, BPSK modulation

**Plot 1:** BPSK - mid channel (9 kHz - 30 MHz)

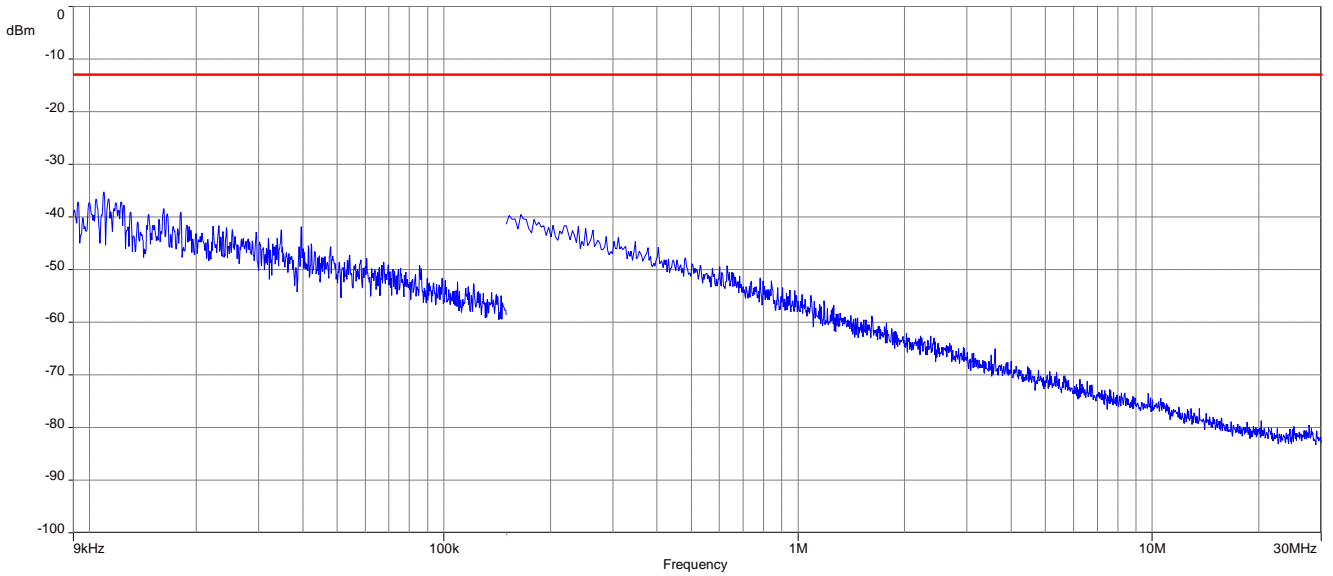

**Plot 2:** BPSK - mid channel (30 MHz – 1 GHz)

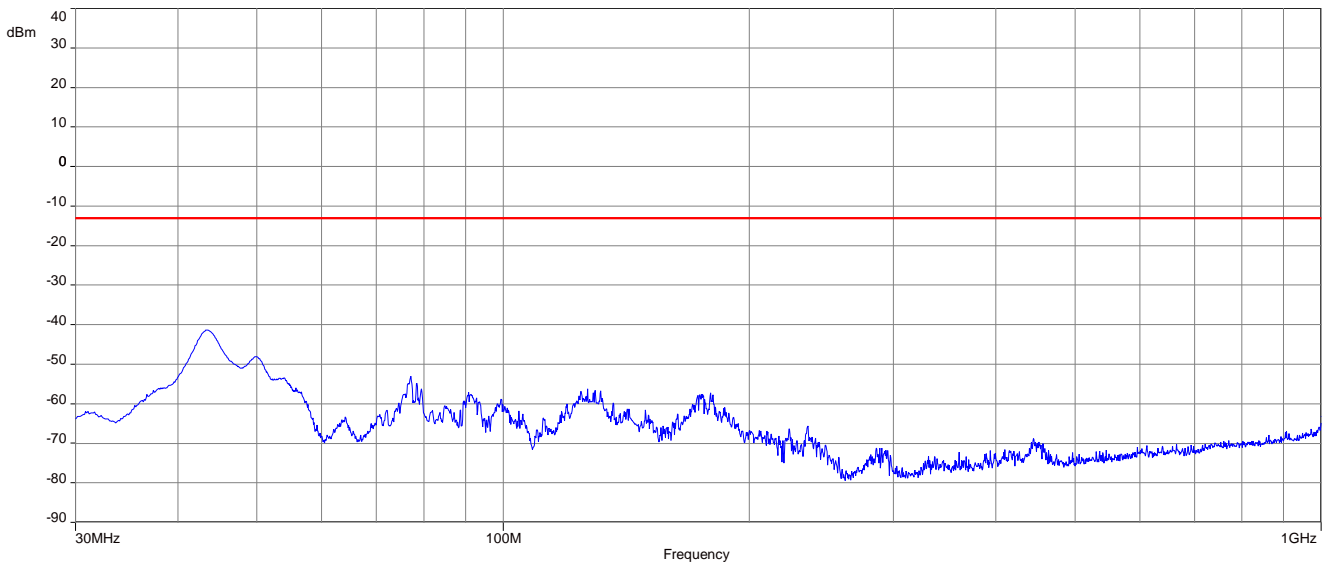

**Plot 3:** BPSK - mid channel (1 GHz – 18 GHz)

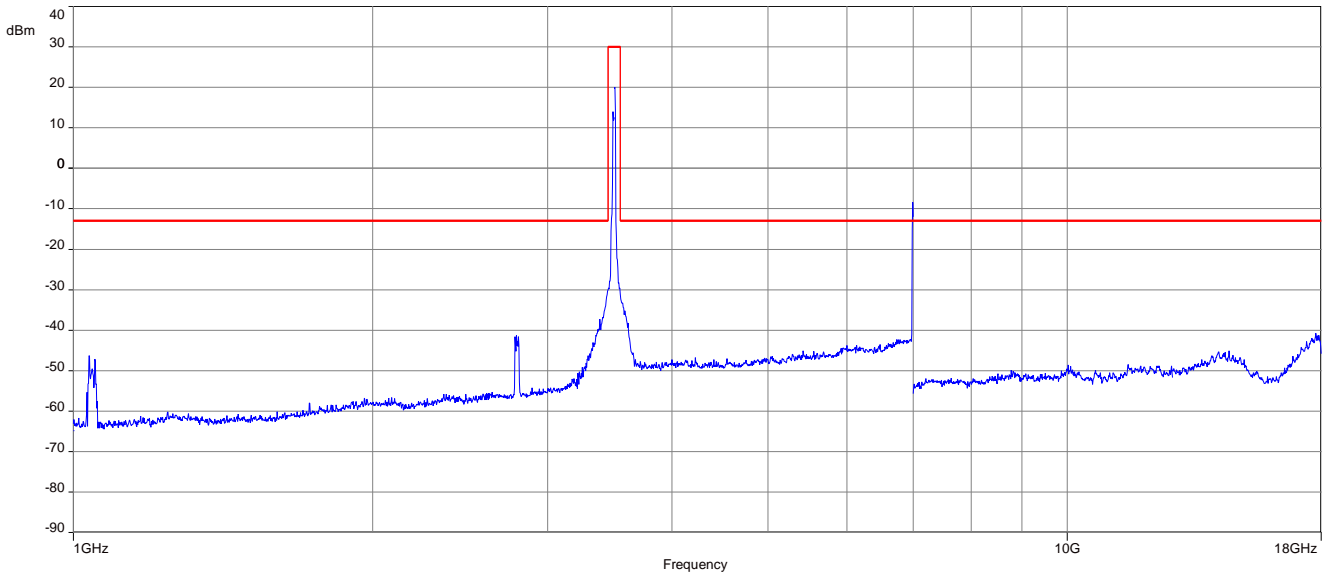

**Plot 4:** BPSK - mid channel (18 GHz – 40 GHz)

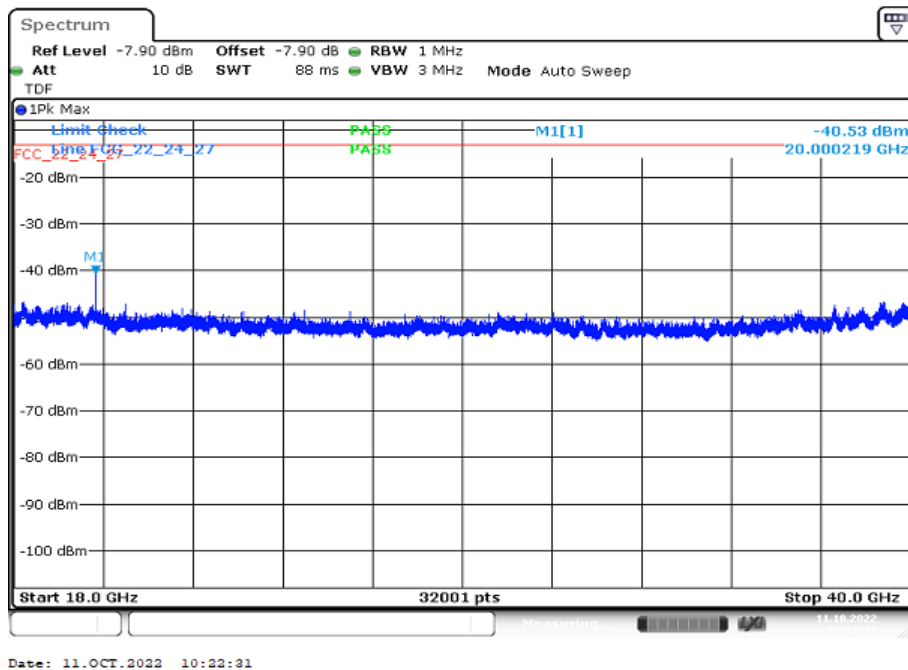

**Plots:** antenna 1+2, QPSK modulation

**Plot 5:** QPSK - mid channel (9 kHz - 30 MHz)

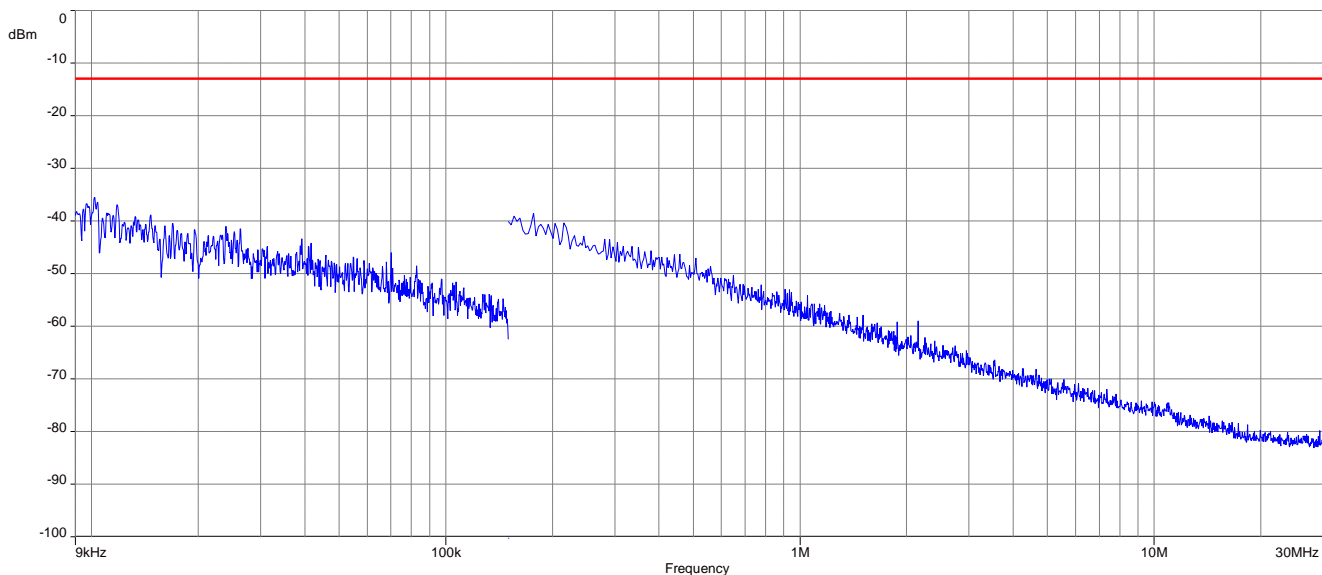

**Plot 6:** QPSK - mid channel (30 MHz – 1 GHz)

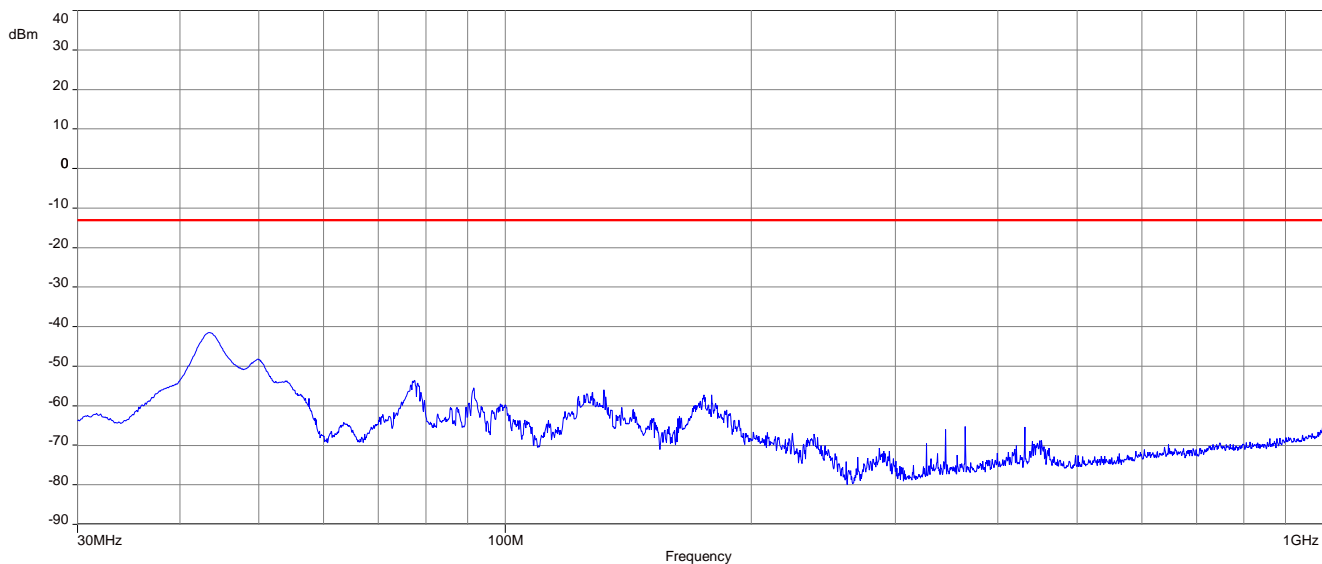

**Plot 7:** QPSK - mid channel (1 GHz – 18 GHz)

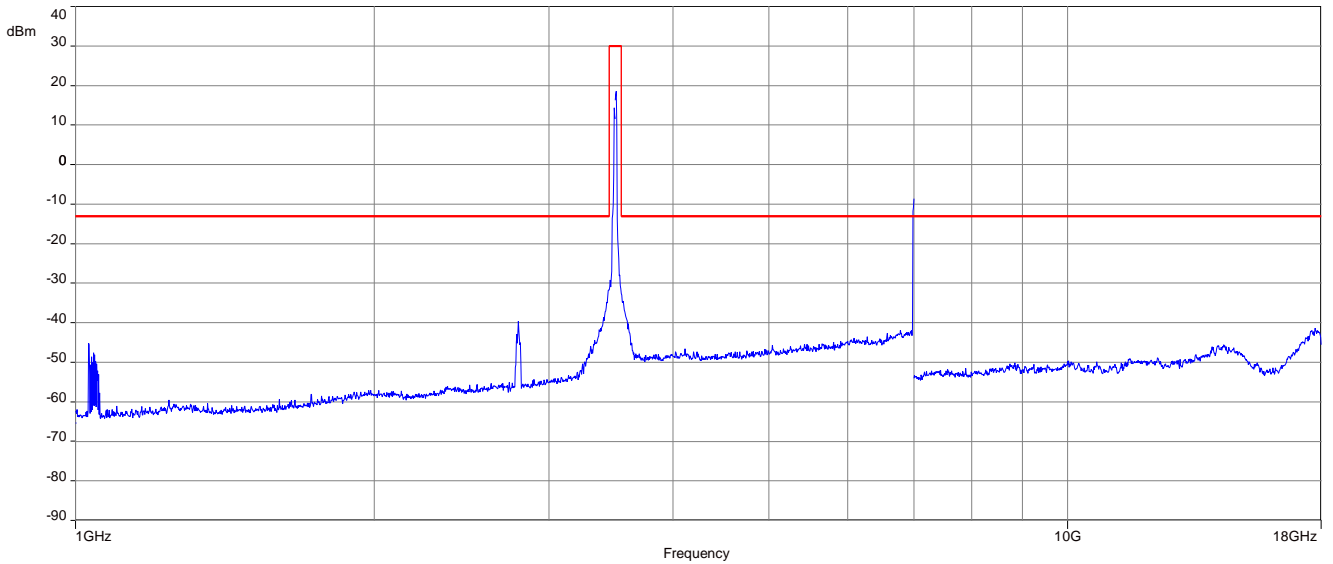

**Plot 8:** QPSK - mid channel (18 GHz – 40 GHz)

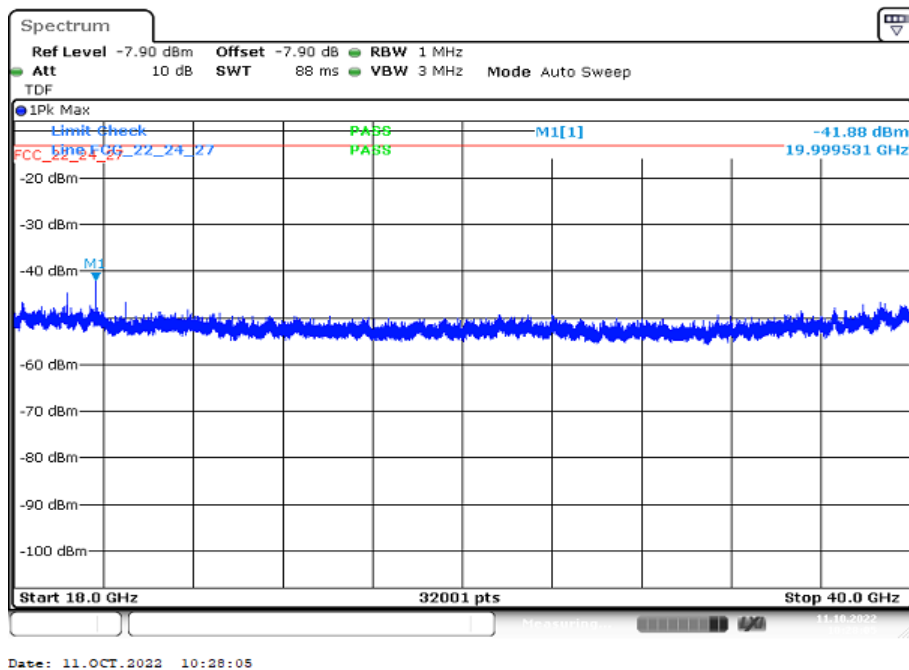

**Plots:** antenna 1+2, 16-QAM modulation

**Plot 9:** 16-QAM - mid channel (9 kHz - 30 MHz)

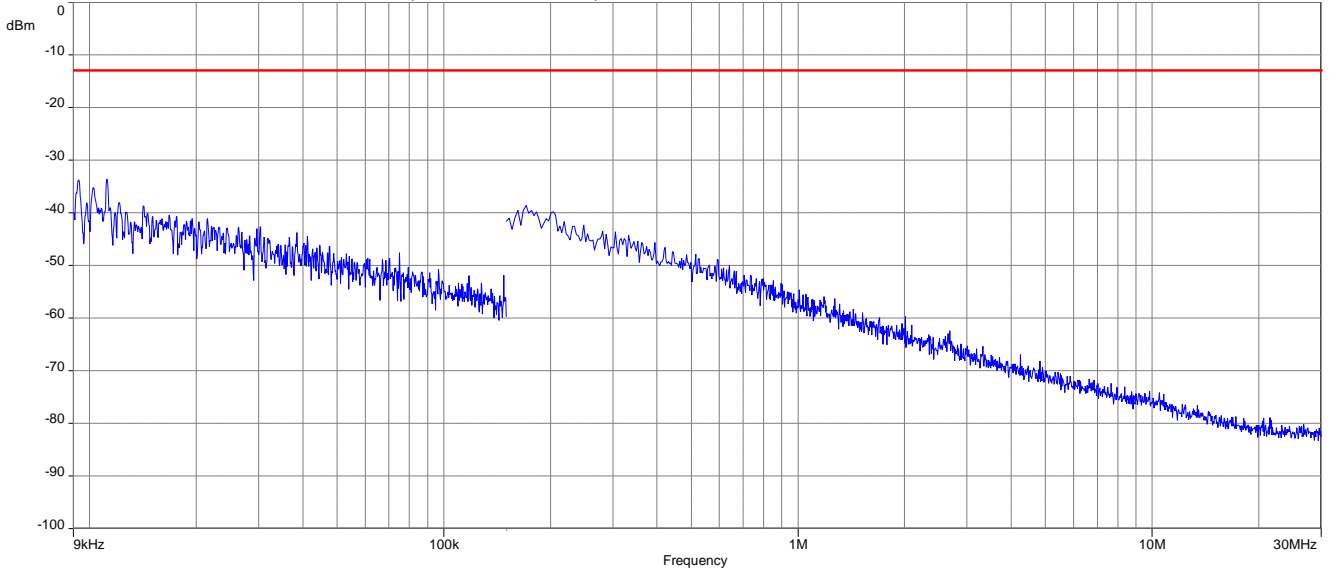

**Plot 10:** 16-QAM - mid channel (30 MHz – 1 GHz)

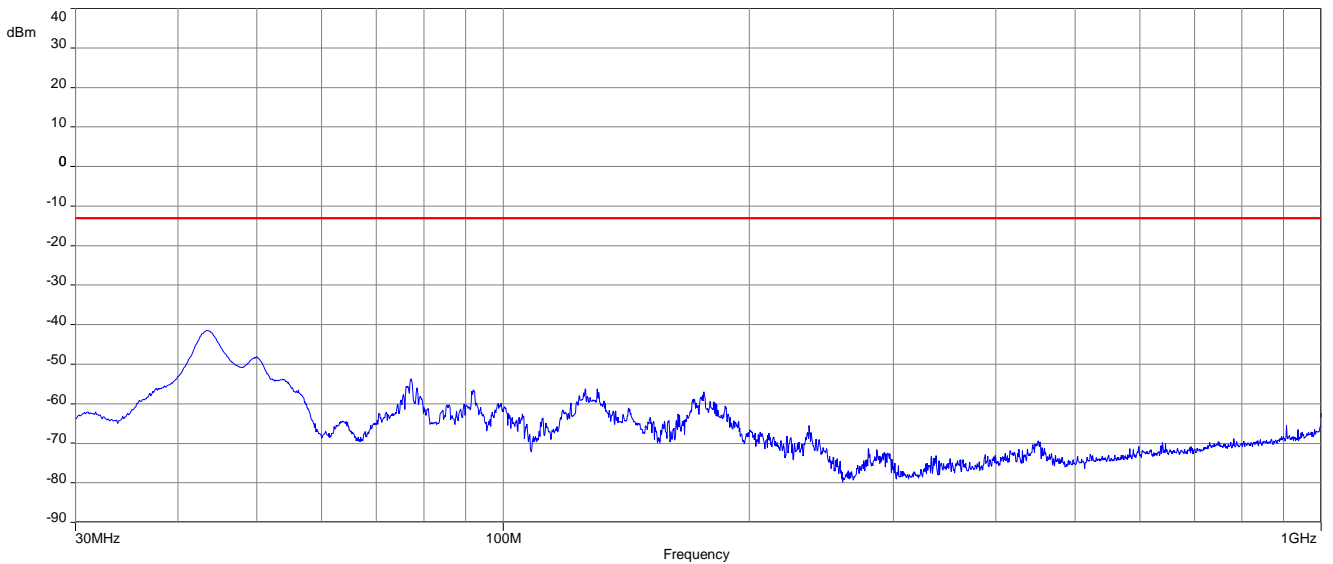

**Plot 11:** 16-QAM - mid channel (1 GHz – 18 GHz)

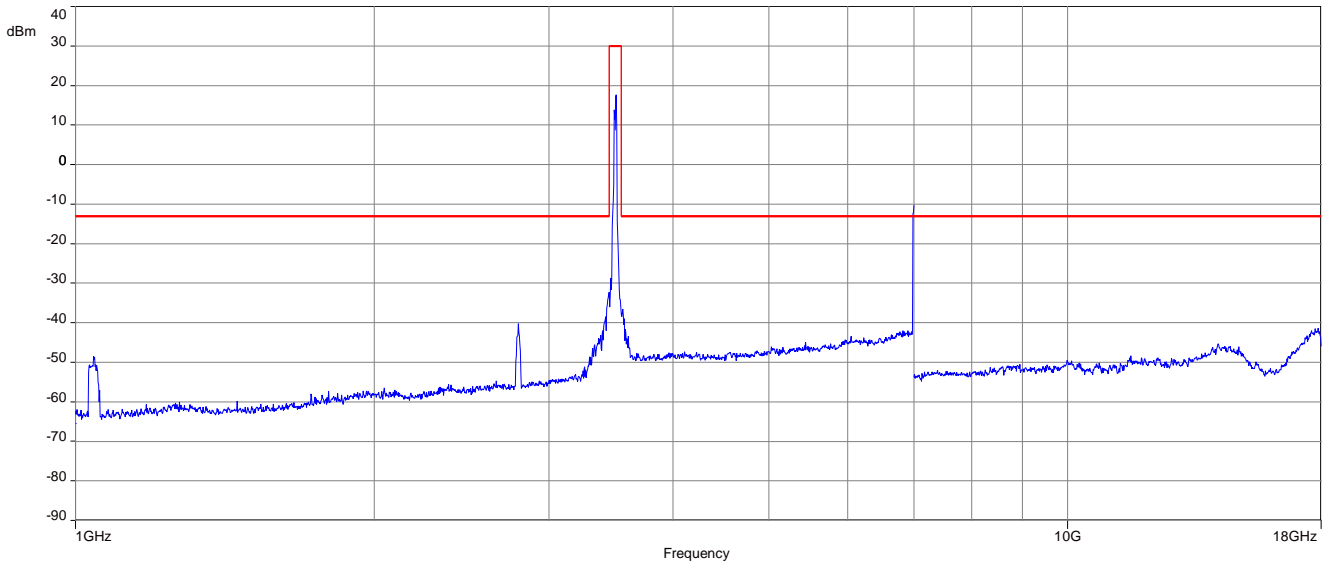

**Plot 12:** 16-QAM - mid channel (18 GHz – 40 GHz)

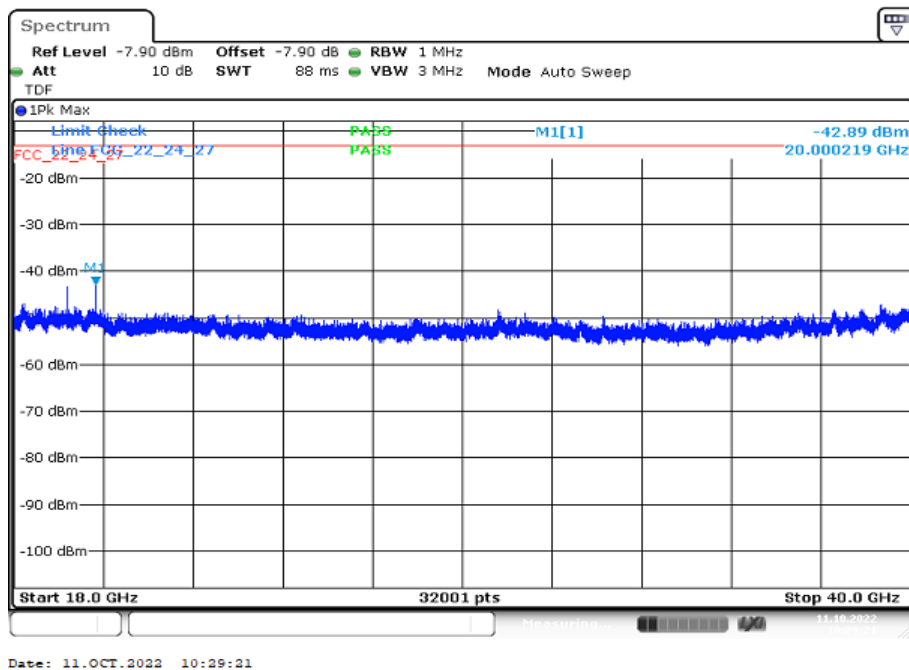



**Plots:** antenna 1+2, 64-QAM modulation

**Plot 13:** 64-QAM - mid channel (9 kHz - 30 MHz)

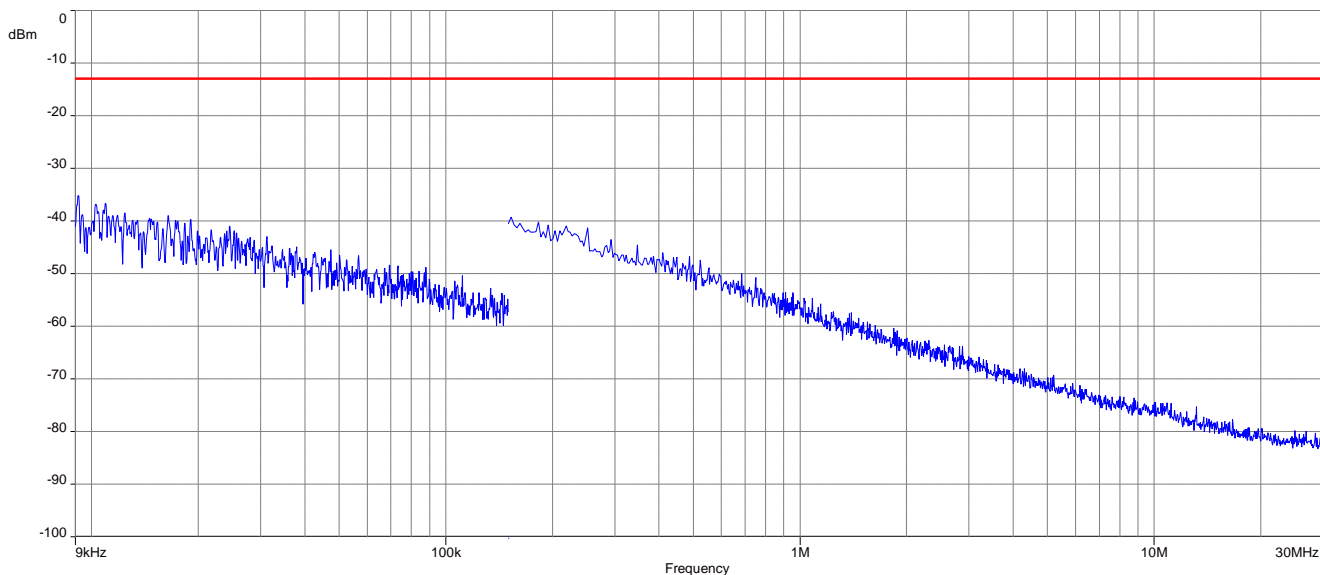

**Plot 14:** 64-QAM - mid channel (30 MHz – 1 GHz)

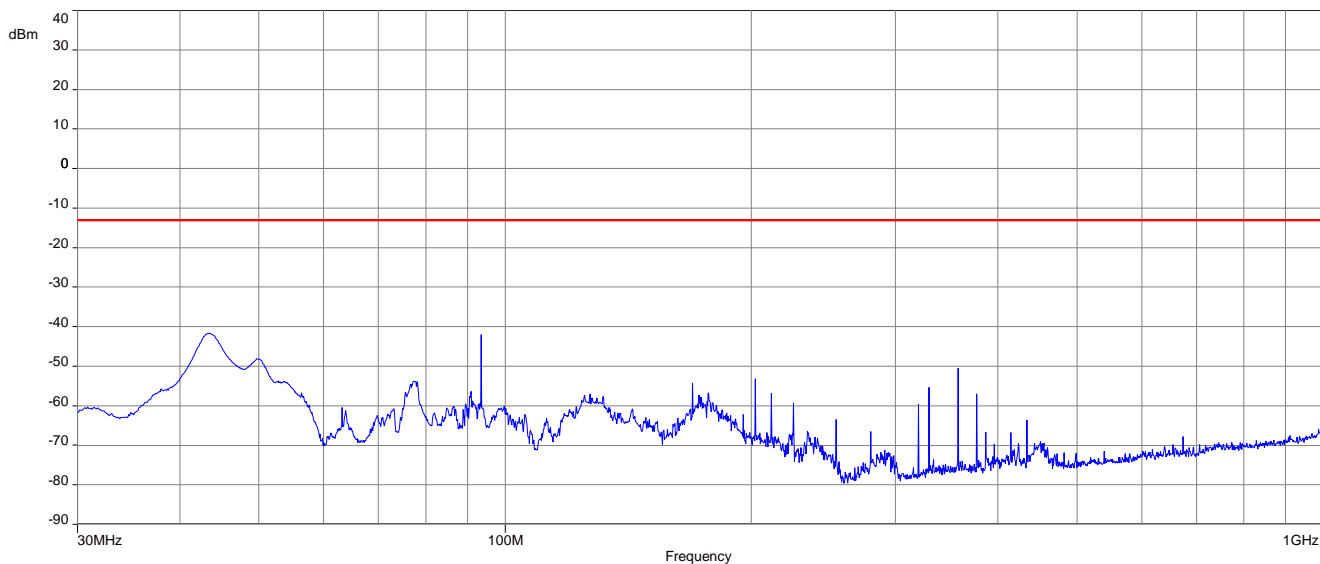

**Plot 15:** 64-QAM - mid channel (1 GHz – 18 GHz)

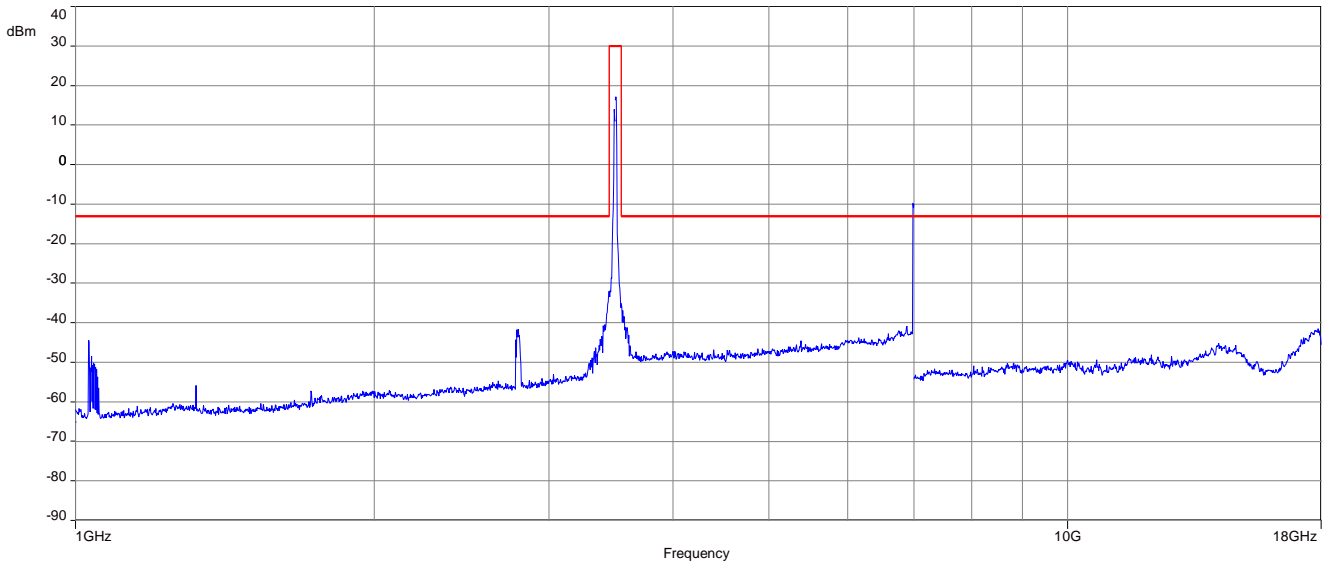

**Plot 16:** 64-QAM - mid channel (18 GHz – 40 GHz)

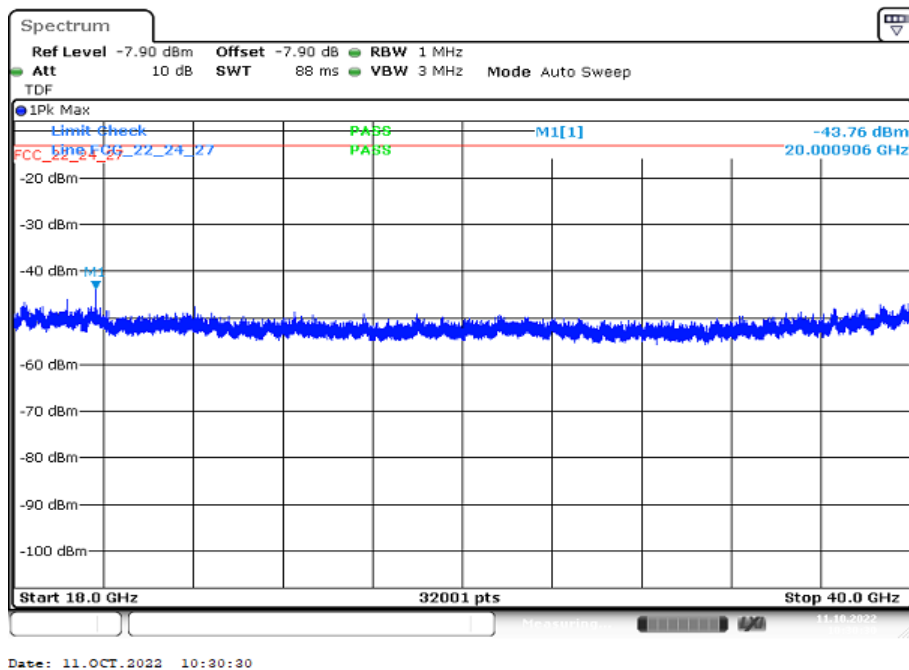

**Plots:** antenna 1+2, 256-QAM modulation

**Plot 17:** 256-QAM - mid channel (9 kHz - 30 MHz)

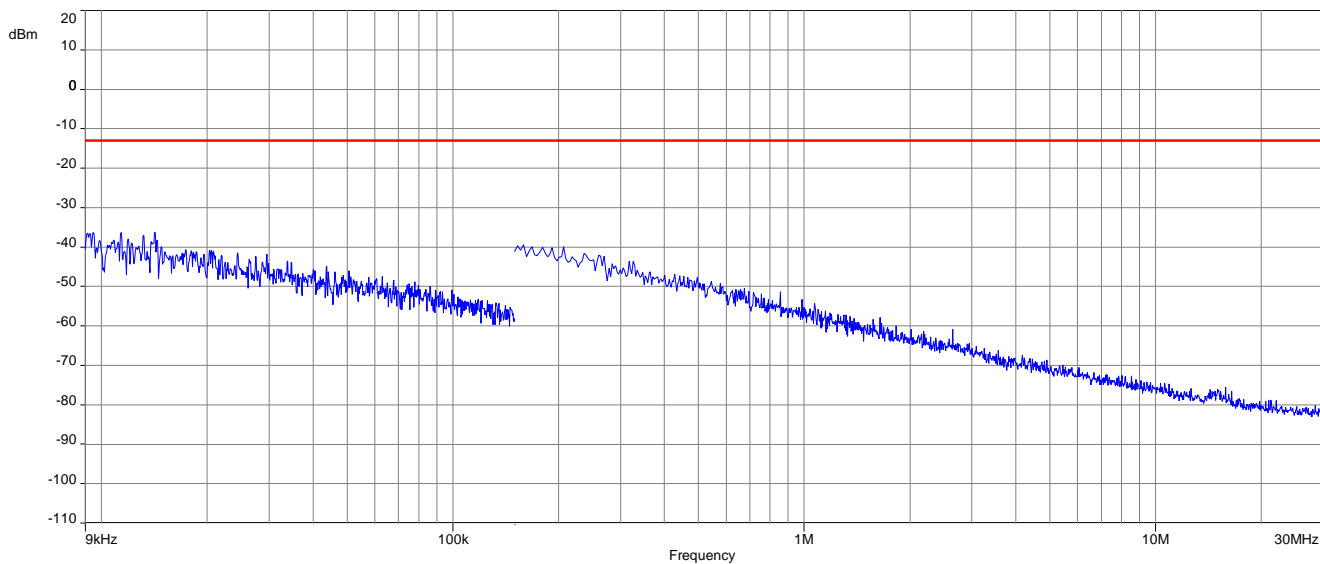

**Plot 18:** 256-QAM - mid channel (30 MHz – 1 GHz)

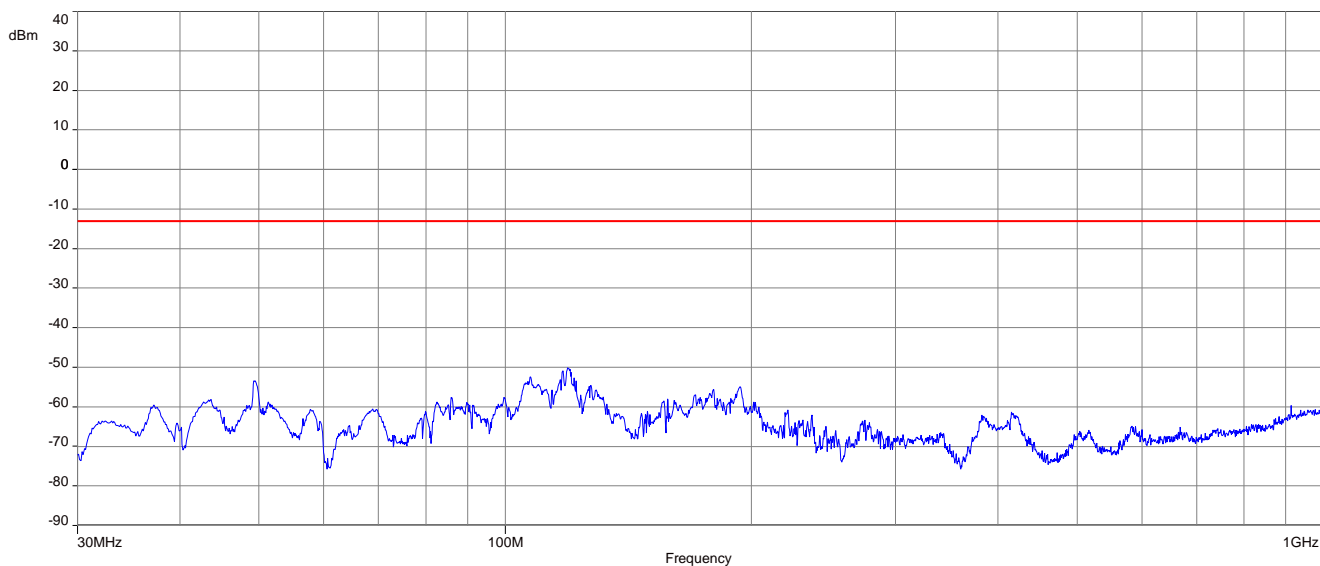

**Plot 19:** 256-QAM - mid channel (1 GHz – 18 GHz)

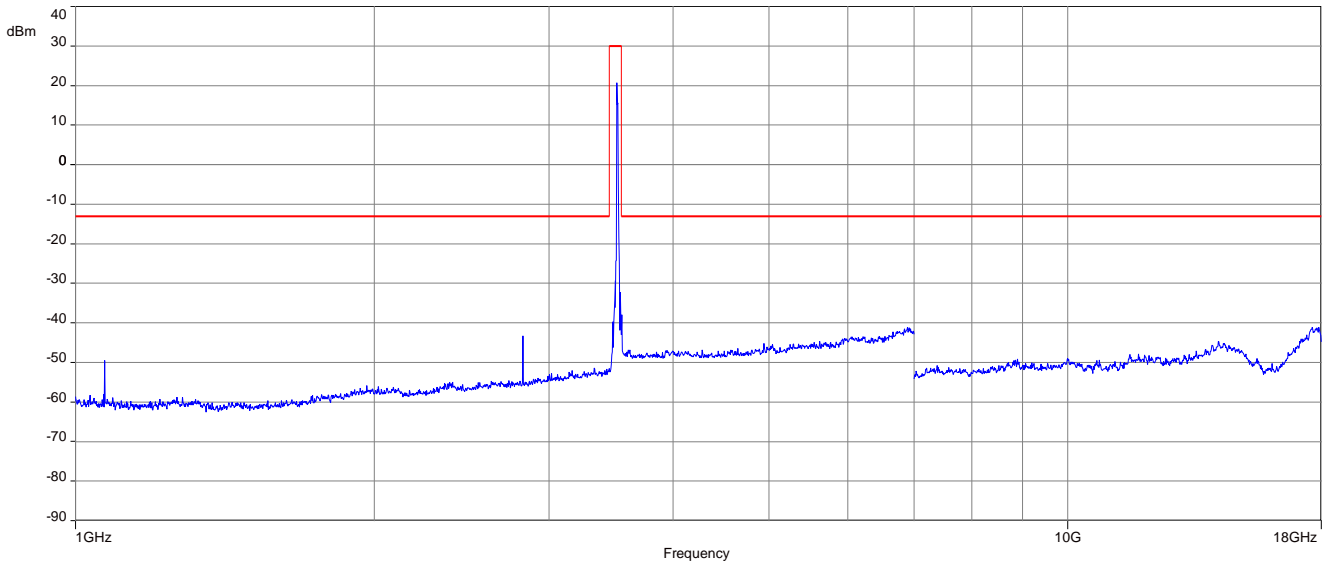

**Plot 20:** 256-QAM - mid channel (18 GHz – 40 GHz)

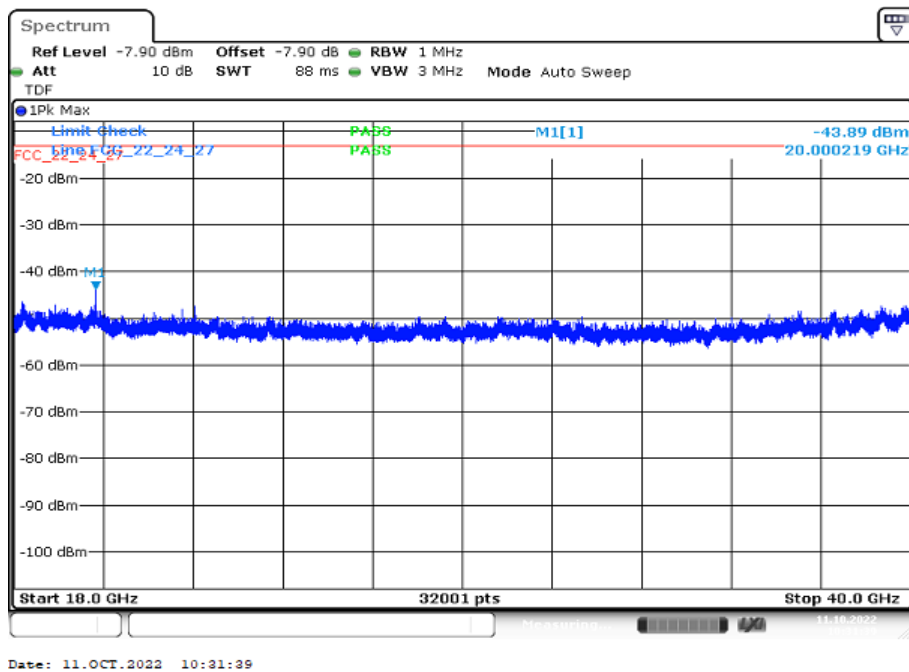

### 13.2.6 Spurious emissions radiated – 5G NR n77 – 3700 MHz to 3980 MHz

**Description:**

The following steps outline the procedure used to measure the radiated emissions from the mobile station. The site is constructed in accordance with ANSI C63.4:2014 requirements and is recognized by the FCC to be in compliance for a 3 and a 10 meter site. The spectrum was scanned from 30 MHz to the 10th harmonic of the highest frequency generated within the equipment. The resolution bandwidth is set as outlined in Part 27.53. The spectrum was scanned with the mobile station transmitting at carrier frequencies that pertain to low, middle and highest channels of the 5G NR band 77.

**Measurement:**

Measurement parameters	
Detector:	Peak
Sweep time:	2 sec.
Resolution bandwidth:	1 MHz
Video bandwidth:	3 MHz
Span:	100 MHz Steps
Trace mode:	Max Hold
Used equipment:	See chapter 8.1 setup A & 8.2 setup A and B & setup 8.3 A
Measurement uncertainty:	See chapter 9
Measurement procedure	FCC: § 2.1053

**Limits:**

FCC
§ 27.53
For mobile operations in the 3700 MHz to 3980 MHz band, the radiated power of any emission outside the licensee`s authorized bandwidth shall not exceed -13dBm/MHz

**Results:** antenna 1

<b>BPSK modulation</b>	<b>Lowest channel</b>		<b>Middle channel</b>		<b>Highest channel</b>	
Bandwidth (MHz)	Spurious emissions (MHz)	Level (dBm)	Spurious emissions (MHz)	Level (dBm)	Spurious emissions (MHz)	Level (dBm)
20 MHz	-/-	-/-	-/-	-/-	-/-	-/-
	-/-	-/-	-/-	-/-	-/-	-/-

<b>QPSK modulation</b>	<b>Lowest channel</b>		<b>Middle channel</b>		<b>Highest channel</b>	
Bandwidth (MHz)	Spurious emissions (MHz)	Level (dBm)	Spurious emissions (MHz)	Level (dBm)	Spurious emissions (MHz)	Level (dBm)
20 MHz	-/-	-/-	-/-	-/-	-/-	-/-
	-/-	-/-	-/-	-/-	-/-	-/-

<b>16-QAM modulation</b>	<b>Lowest channel</b>		<b>Middle channel</b>		<b>Highest channel</b>	
Bandwidth (MHz)	Spurious emissions (MHz)	Level (dBm)	Spurious emissions (MHz)	Level (dBm)	Spurious emissions (MHz)	Level (dBm)
20 MHz	-/-	-/-	-/-	-/-	-/-	-/-
	-/-	-/-	-/-	-/-	-/-	-/-

<b>64-QAM modulation</b>	<b>Lowest channel</b>		<b>Middle channel</b>		<b>Highest channel</b>	
Bandwidth (MHz)	Spurious emissions (MHz)	Level (dBm)	Spurious emissions (MHz)	Level (dBm)	Spurious emissions (MHz)	Level (dBm)
20 MHz	-/-	-/-	-/-	-/-	-/-	-/-
	-/-	-/-	-/-	-/-	-/-	-/-

<b>256-QAM modulation</b>	<b>Lowest channel</b>		<b>Middle channel</b>		<b>Highest channel</b>	
Bandwidth (MHz)	Spurious emissions (MHz)	Level (dBm)	Spurious emissions (MHz)	Level (dBm)	Spurious emissions (MHz)	Level (dBm)
20 MHz	-/-	-/-	-/-	-/-	-/-	-/-
	-/-	-/-	-/-	-/-	-/-	-/-

**Plots:** antenna 1, BPSK modulation

**Plot 1:** BPSK - lowest channel (9 kHz - 30 MHz)

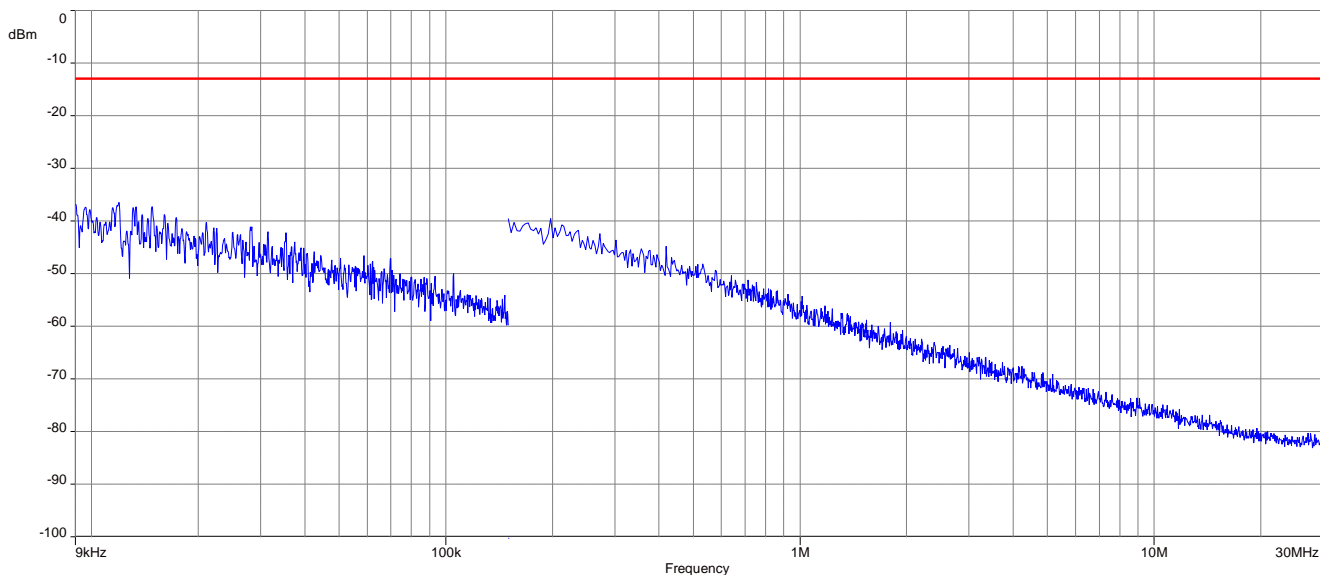

**Plot 2:** BPSK - lowest channel (30 MHz – 1 GHz)

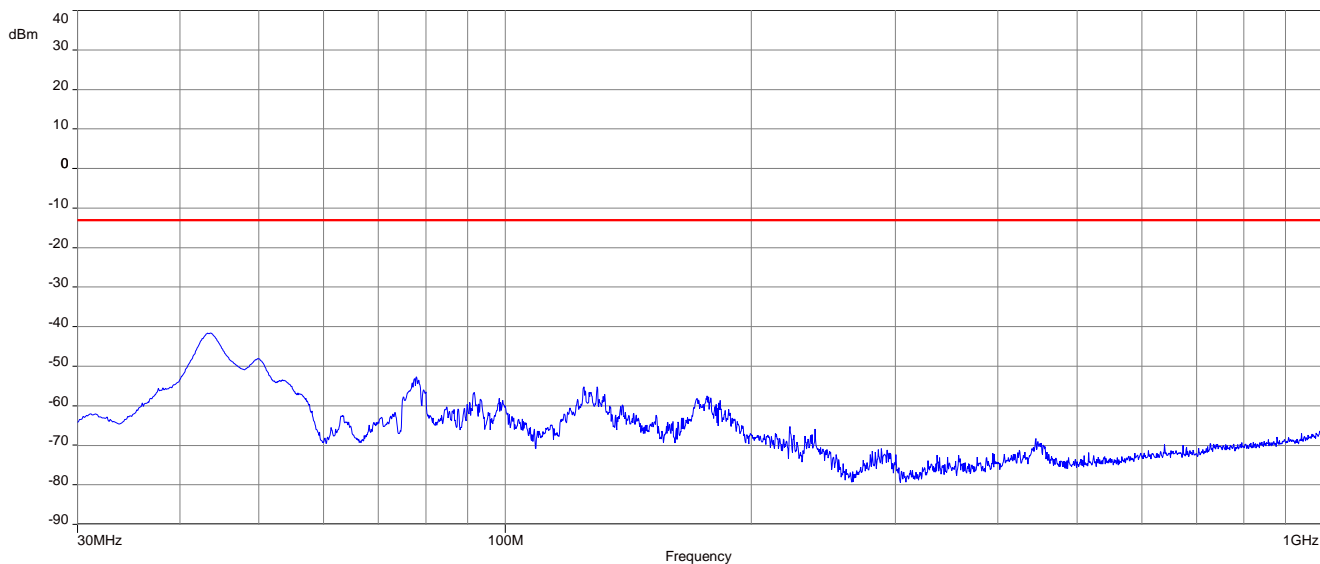

**Plot 3:** BPSK - lowest channel (1 GHz – 18 GHz)

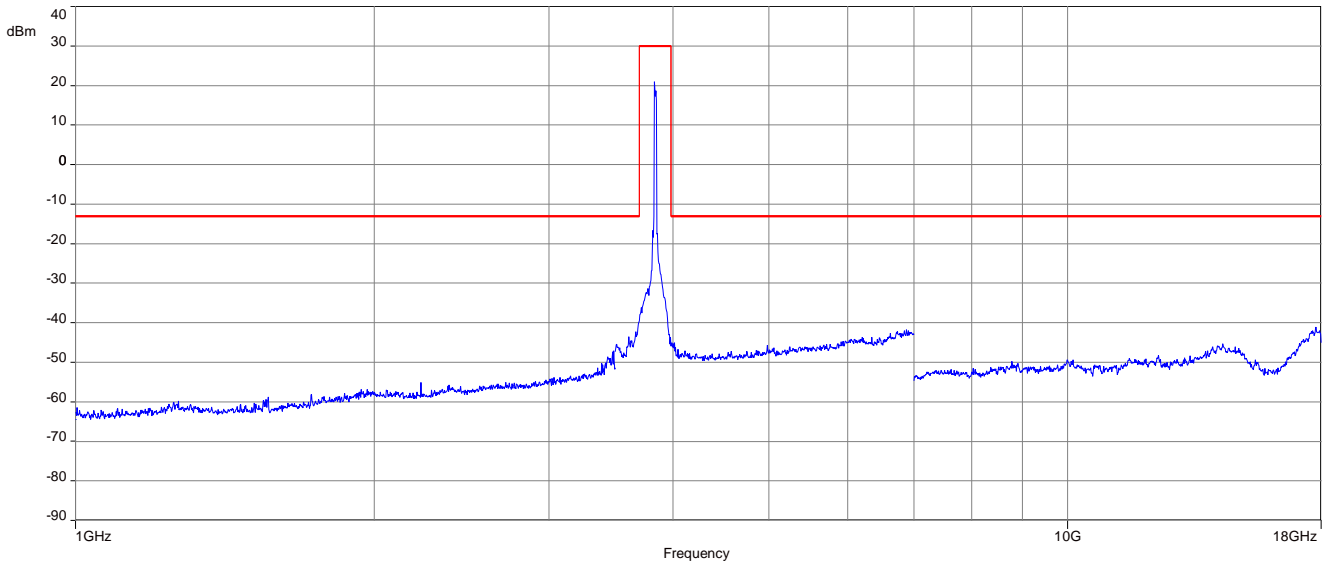

**Plot 4:** BPSK - lowest channel (18 GHz – 40 GHz)

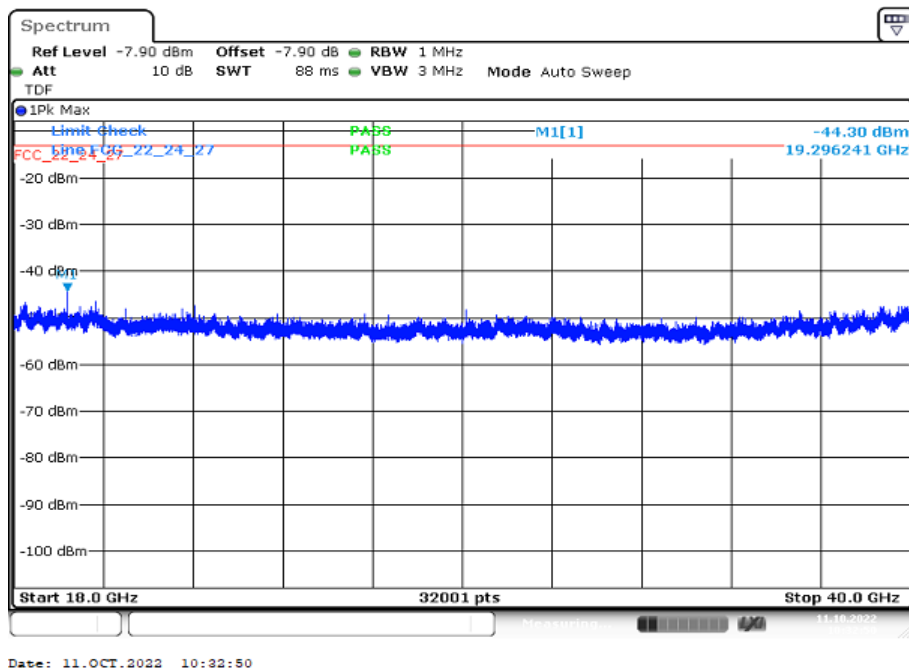



**Plots:** antenna 1+2, QPSK modulation

**Plot 1:** QPSK - lowest channel (9 kHz - 30 MHz)

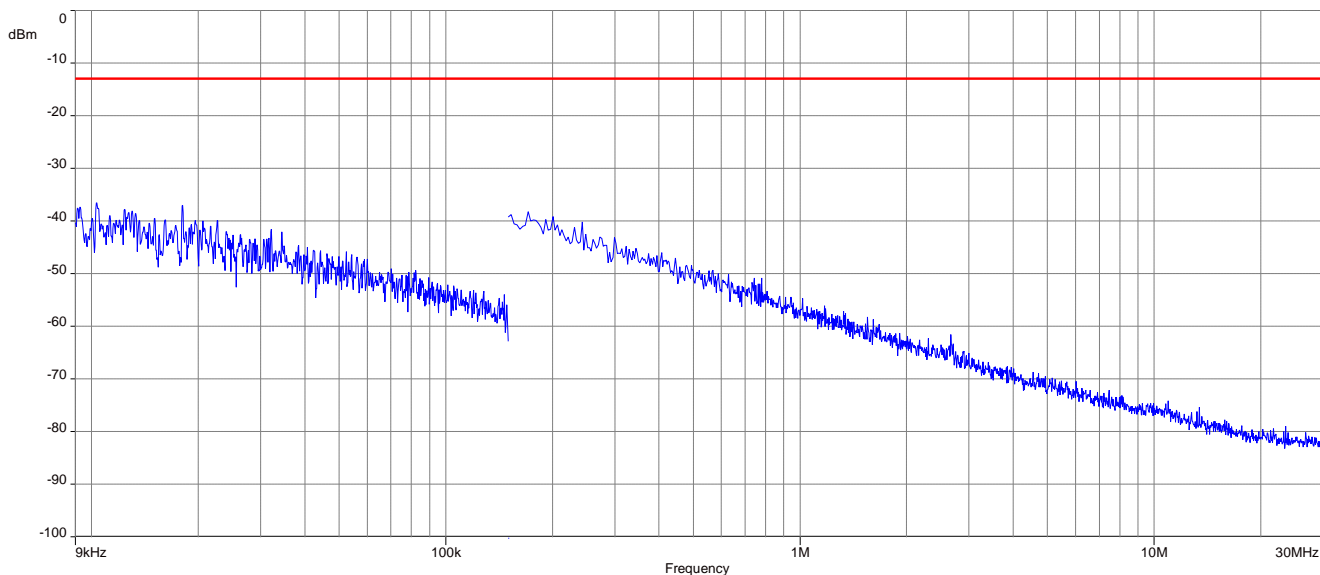

**Plot 2:** QPSK - lowest channel (30 MHz – 1 GHz)

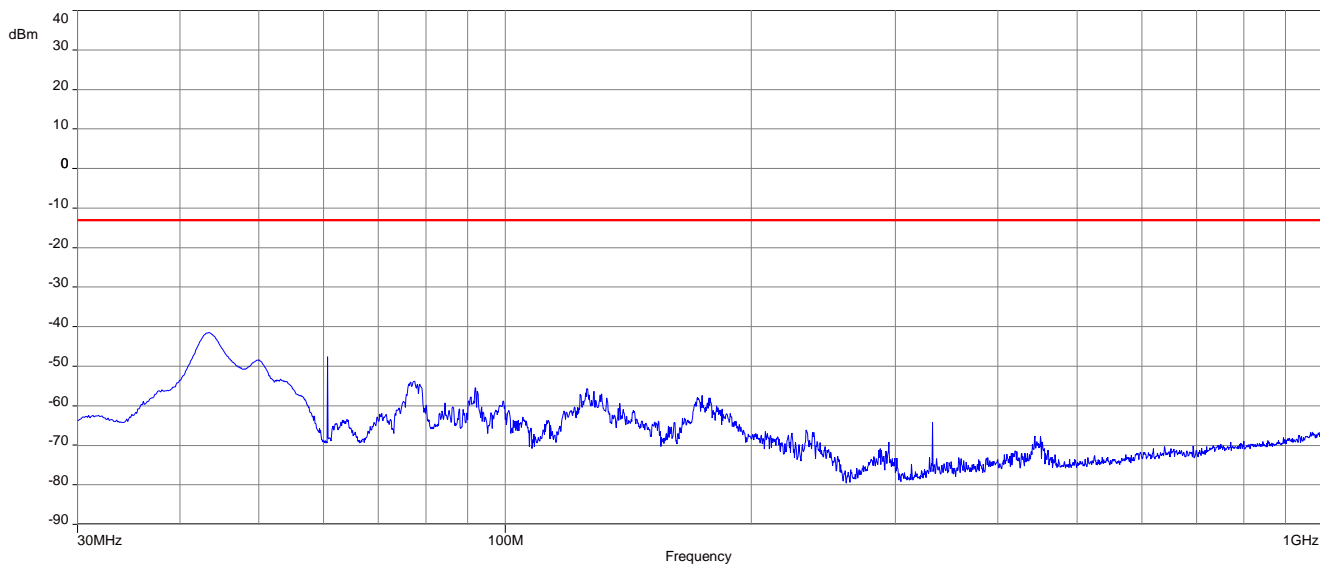

**Plot 3:** QPSK - lowest channel (1 GHz – 18 GHz)

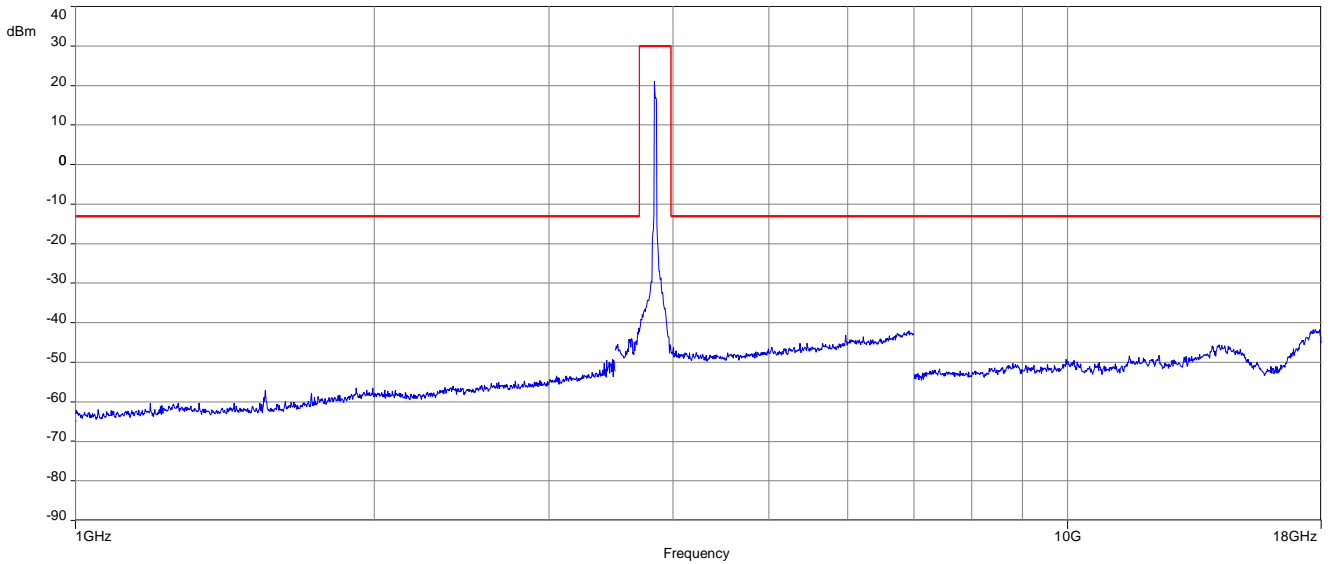

**Plot 4:** QPSK - lowest channel (18 GHz – 40 GHz)

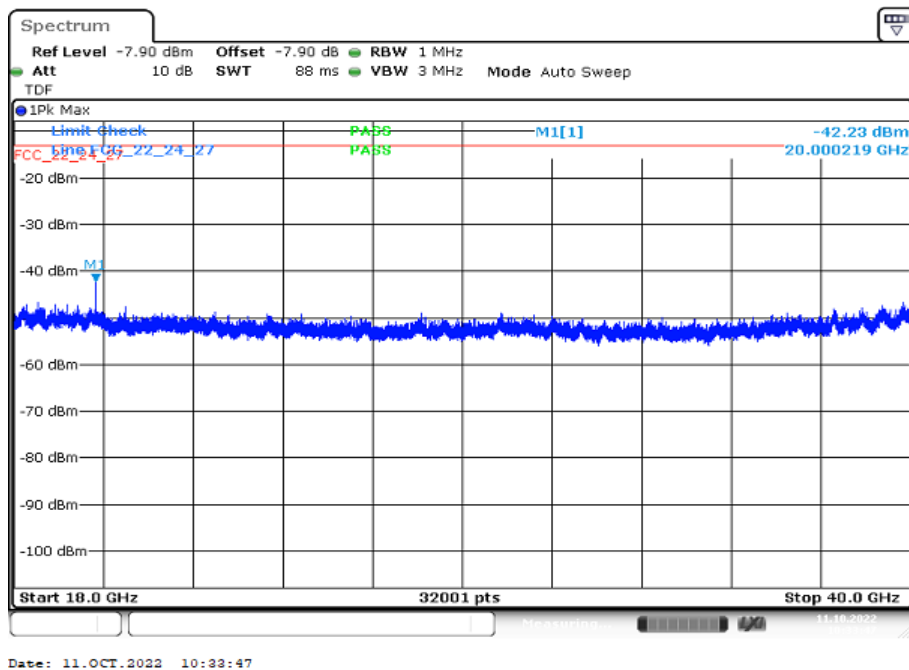

**Plots:** antenna 1+2, 16-QAM modulation

**Plot 1:** 16-QAM - lowest channel (9 kHz - 30 MHz)

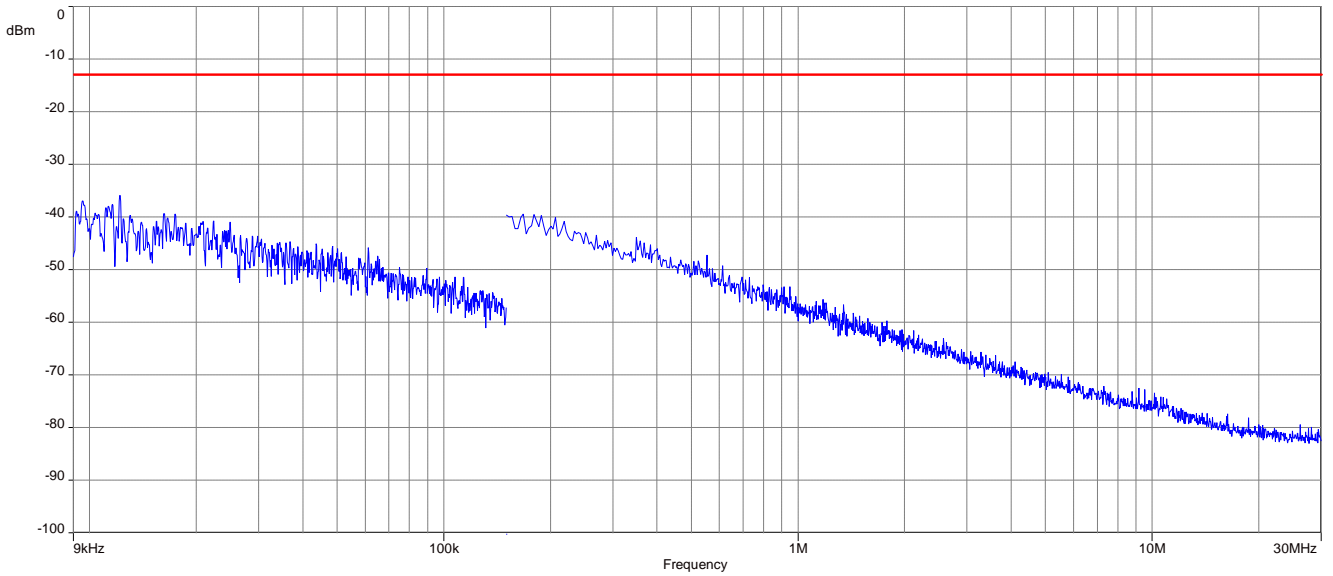

**Plot 2:** 16-QAM - lowest channel (30 MHz – 1 GHz)

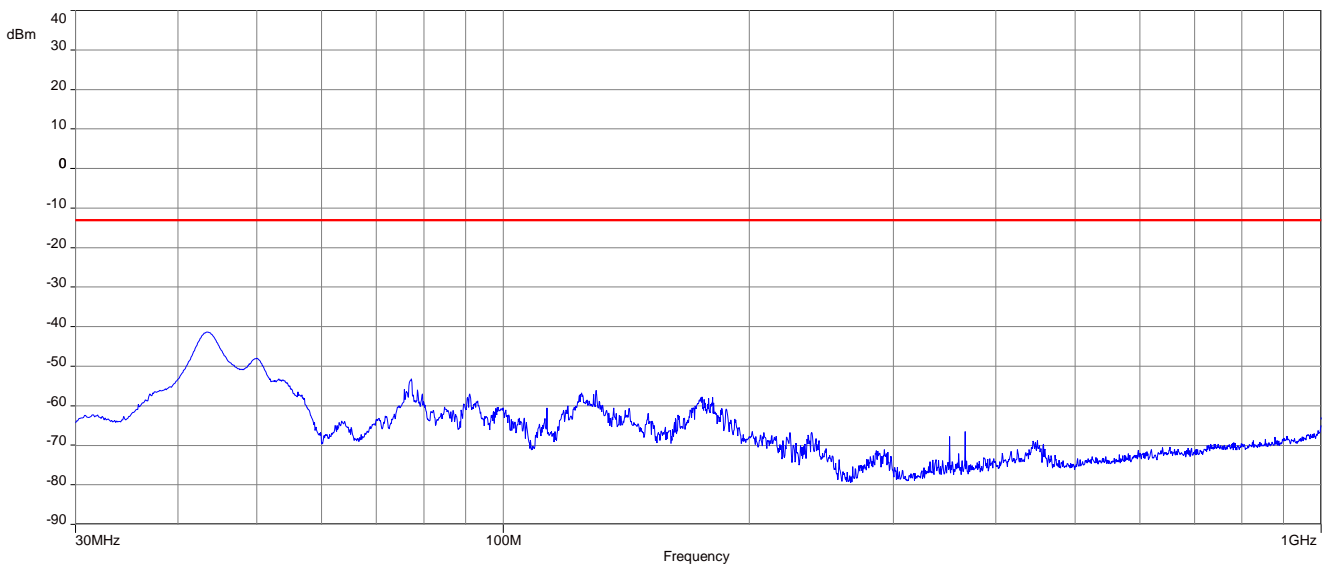

**Plot 3:** 16-QAM - lowest channel (1 GHz – 18 GHz)

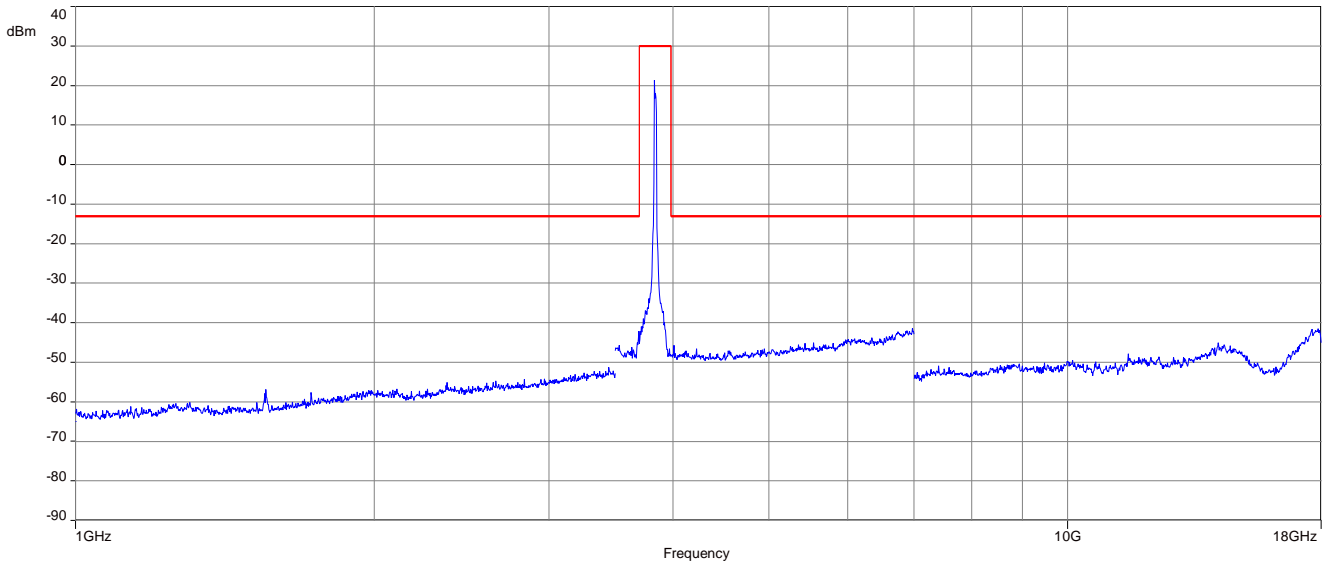

**Plot 4:** 16-QAM - lowest channel (18 GHz – 40 GHz)

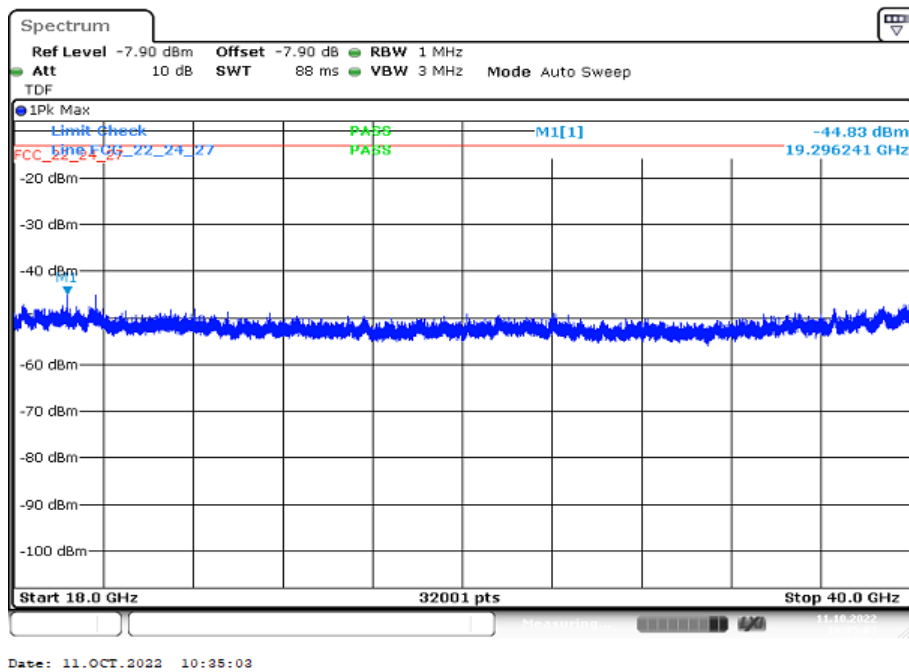

**Plots:** antenna 1+2, 64-QAM modulation

**Plot 1:** 64-QAM - lowest channel (9 kHz - 30 MHz)

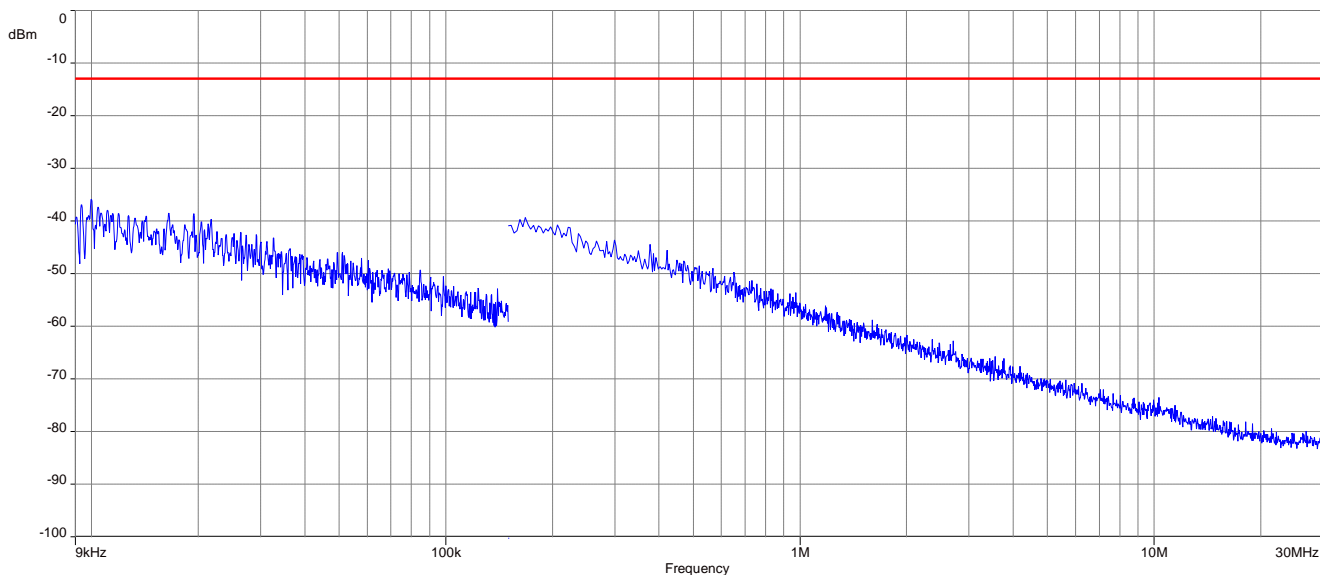

**Plot 2:** 64-QAM - lowest channel (30 MHz – 1 GHz)

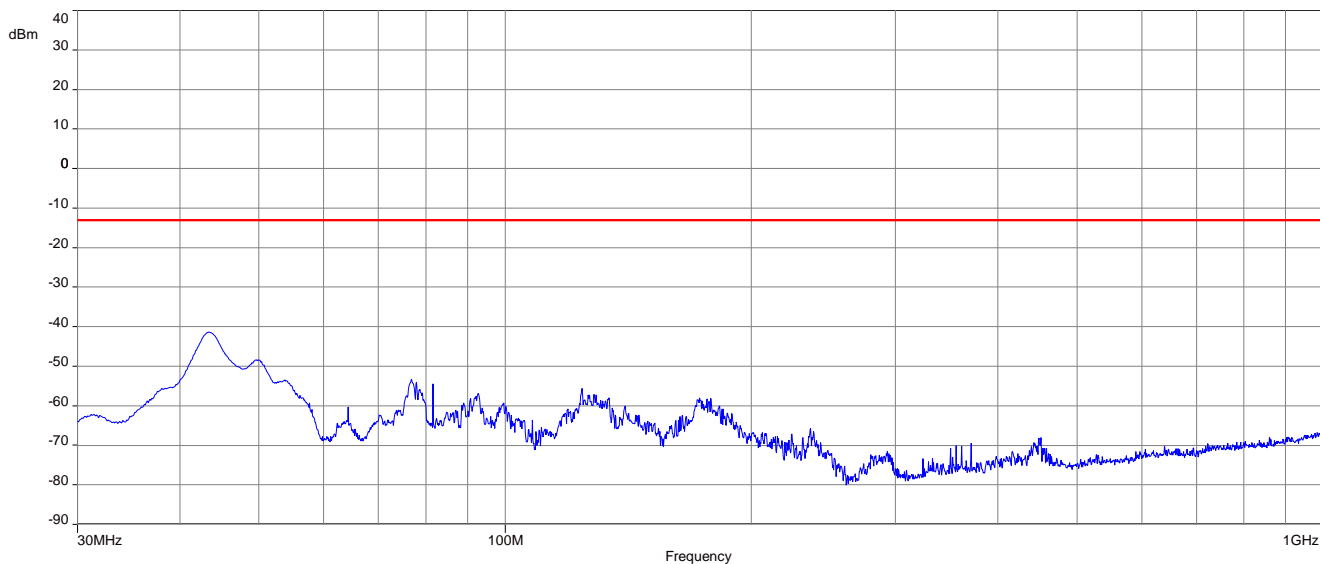

**Plot 3:** 64-QAM - lowest channel (1 GHz – 18 GHz)

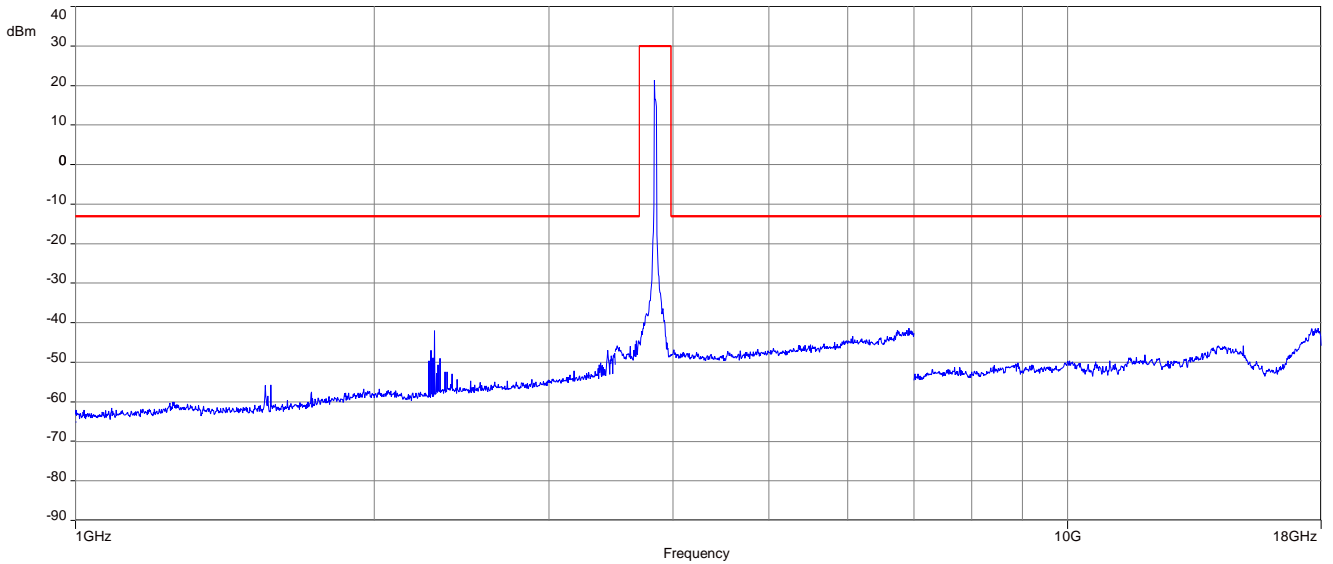

**Plot 4:** 64-QAM - lowest channel (18 GHz – 40 GHz)

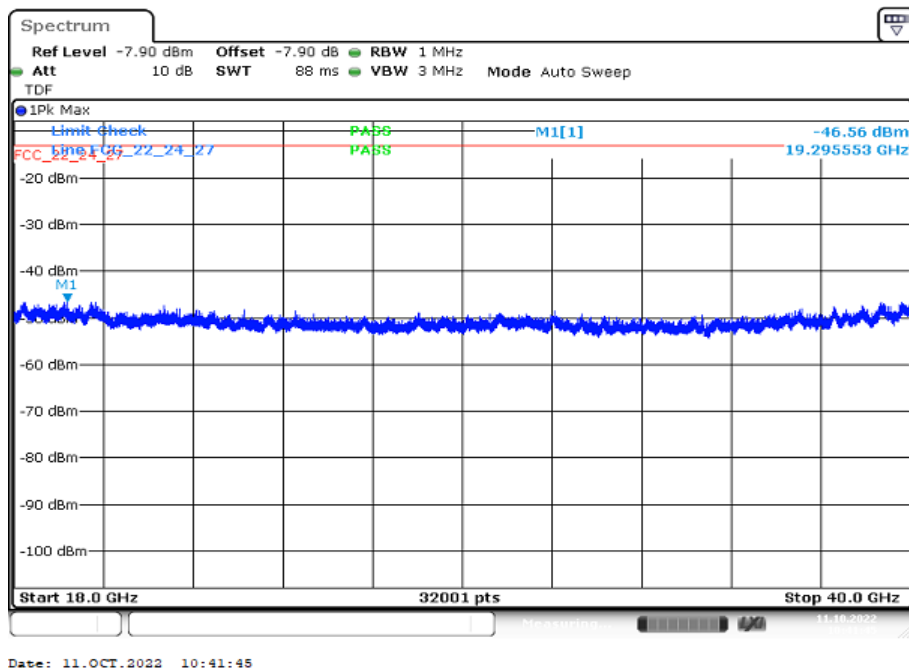

**Plots:** antenna 1+2, 256-QAM modulation

**Plot 1:** 256-QAM - lowest channel (9 kHz - 30 MHz)

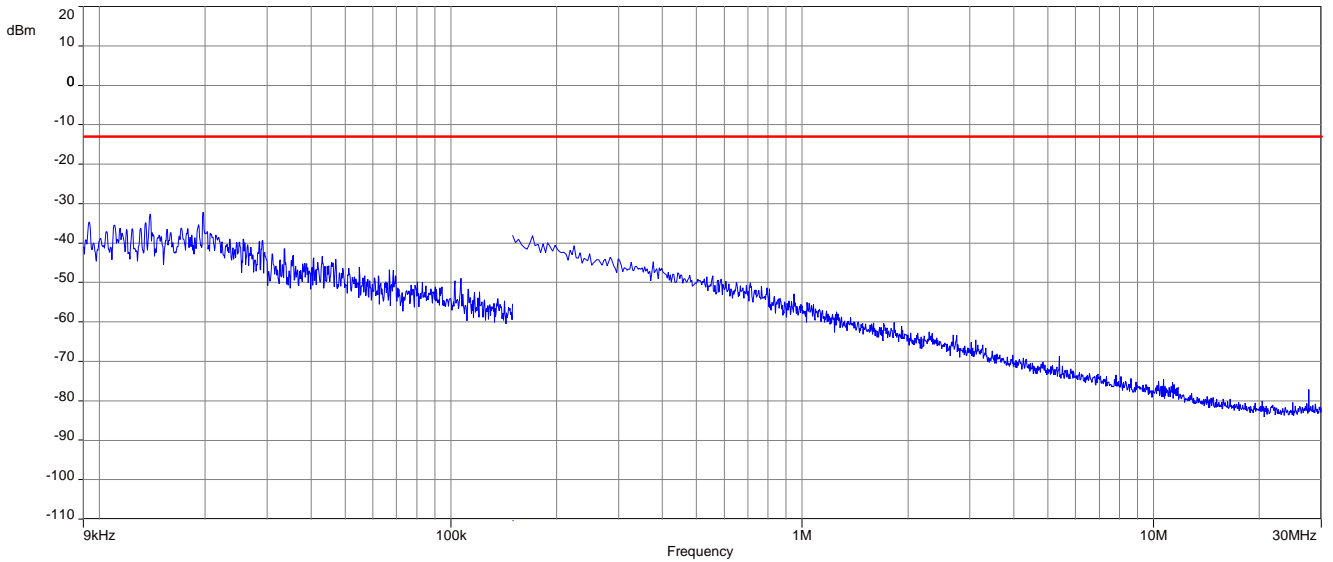

**Plot 2:** 256-QAM - lowest channel (30 MHz – 1 GHz)

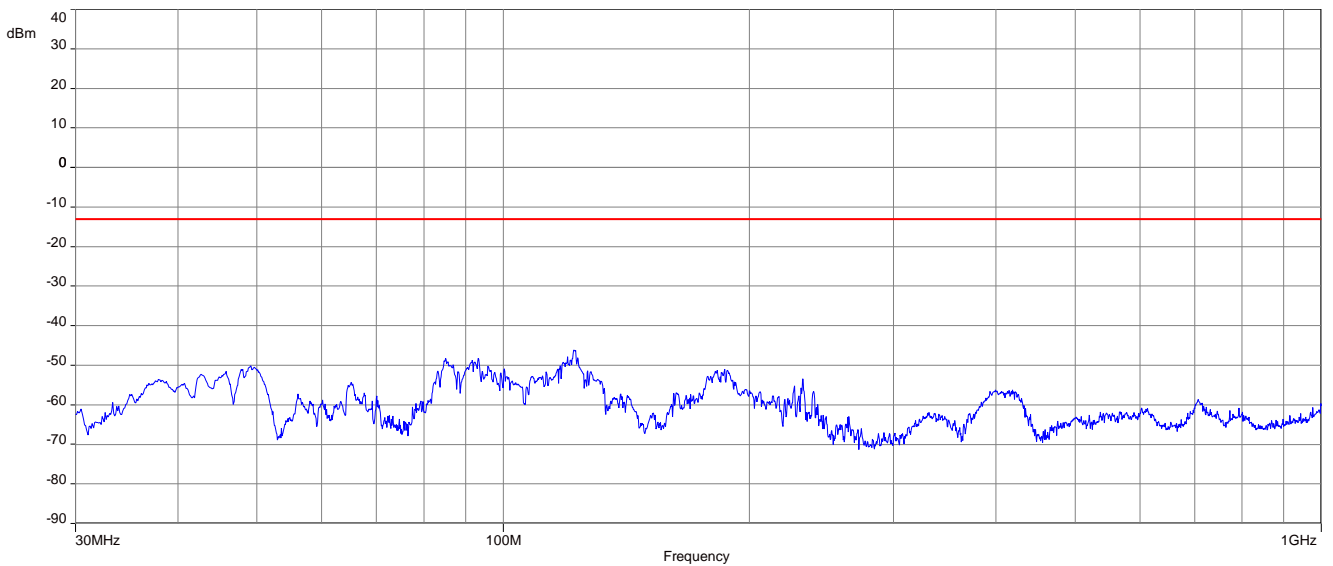

**Plot 3:** 256-QAM - lowest channel (1 GHz – 18 GHz)

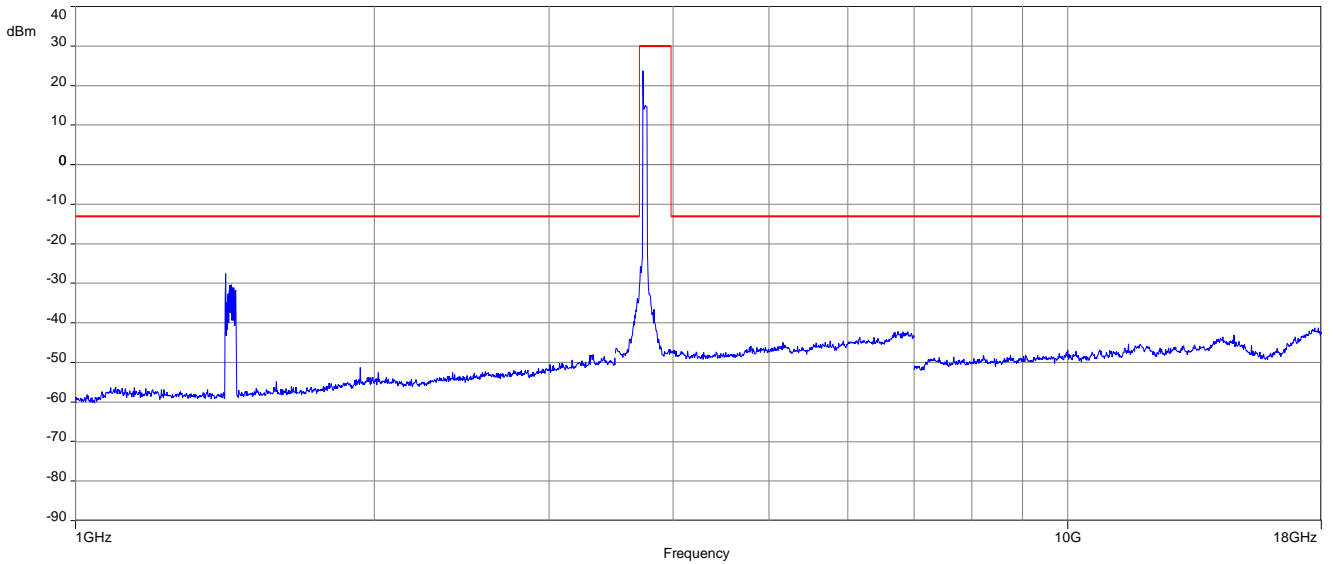

**Plot 4:** 256-QAM - lowest channel (18 GHz – 40 GHz)

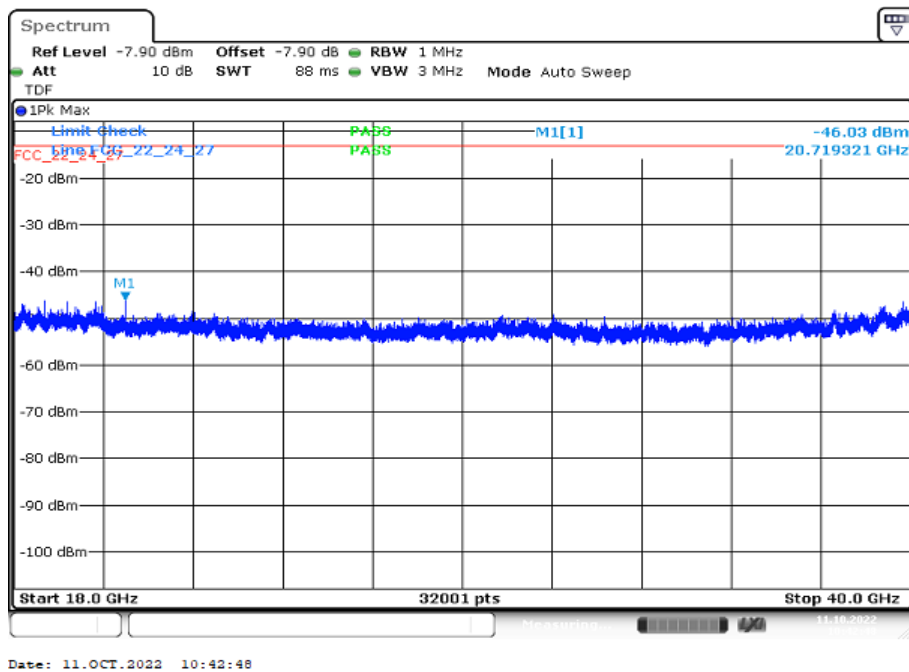



### 13.2.7 Spurious emissions conducted – 5G NR n77 – 3450 MHz to 3550 MHz

#### Description:

The following steps outline the procedure used to measure the conducted emissions from the mobile station.

1. The RF output of the transmitter was connected to a spectrum analyzer through a calibrated coaxial cable.
2. Determine frequency range for measurements: From § 2.1057 the spectrum should be investigated from the lowest radio frequency generated in the equipment up to at least the 10th harmonic of the carrier frequency.
3. Determine mobile station transmits frequencies: below outlines the band edge frequencies pertinent to conducted emissions testing.

#### Measurement:

Measurement parameters	
Detector:	Peak
Sweep time:	Auto
Resolution bandwidth:	1 MHz
Video bandwidth:	3 MHz
Span:	30 MHz – 40 GHz
Trace-Mode:	Max Hold
Used equipment:	See chapter 8.4 setup A
Measurement uncertainty:	see chapter 9
Measurement procedure	FCC: § 2.1051

#### Limits:

FCC
§ Part 27.53
<ul style="list-style-type: none"> <li>• (n) 3.45 GHz Service. The following emission limits apply to stations transmitting in the 3450 MHz to 3550 MHz band.</li> <li>• (2) for mobile operations in the 3450 MHz to 3550 MHz band, the conducted power of any emission outside the licensee`s authorized bandwidth shall not exceed -13dBm/MHz</li> </ul>

**Results:** antenna 1

BPSK modulation	Lowest channel		Middle channel		Highest channel	
	Spurious emissions (MHz)	Level (dBm)	Spurious emissions (MHz)	Level (dBm)	Spurious emissions (MHz)	Level (dBm)
10 MHz	-/-	-/-	-/-	-/-	-/-	-/-
	-/-	-/-	-/-	-/-	-/-	-/-
20 MHz	-/-	-/-	-/-	-/-	-/-	-/-
	-/-	-/-	-/-	-/-	-/-	-/-
30 MHz	-/-	-/-	-/-	-/-	-/-	-/-
	-/-	-/-	-/-	-/-	-/-	-/-
40 MHz	-/-	-/-	-/-	-/-	-/-	-/-
	-/-	-/-	-/-	-/-	-/-	-/-
50 MHz	-/-	-/-	-/-	-/-	-/-	-/-
	-/-	-/-	-/-	-/-	-/-	-/-
60 MHz	-/-	-/-	-/-	-/-	-/-	-/-
	-/-	-/-	-/-	-/-	-/-	-/-
70 MHz	-/-	-/-	-/-	-/-	-/-	-/-
	-/-	-/-	-/-	-/-	-/-	-/-
80 MHz	-/-	-/-	-/-	-/-	-/-	-/-
	-/-	-/-	-/-	-/-	-/-	-/-
90 MHz	-/-	-/-	-/-	-/-	-/-	-/-
	-/-	-/-	-/-	-/-	-/-	-/-
100 MHz	-/-	-/-	-/-	-/-	-/-	-/-
	-/-	-/-	-/-	-/-	-/-	-/-

QPSK modulation	Lowest channel		Middle channel		Highest channel	
Bandwidth (MHz)	Spurious emissions (MHz)	Level (dBm)	Spurious emissions (MHz)	Level (dBm)	Spurious emissions (MHz)	Level (dBm)
10 MHz	-/-	-/-	-/-	-/-	-/-	-/-
	-/-	-/-	-/-	-/-	-/-	-/-
20 MHz	-/-	-/-	-/-	-/-	-/-	-/-
	-/-	-/-	-/-	-/-	-/-	-/-
30 MHz	-/-	-/-	-/-	-/-	-/-	-/-
	-/-	-/-	-/-	-/-	-/-	-/-
40 MHz	-/-	-/-	-/-	-/-	-/-	-/-
	-/-	-/-	-/-	-/-	-/-	-/-
50 MHz	-/-	-/-	-/-	-/-	-/-	-/-
	-/-	-/-	-/-	-/-	-/-	-/-
60 MHz	-/-	-/-	-/-	-/-	-/-	-/-
	-/-	-/-	-/-	-/-	-/-	-/-
70 MHz	-/-	-/-	-/-	-/-	-/-	-/-
	-/-	-/-	-/-	-/-	-/-	-/-
80 MHz	-/-	-/-	-/-	-/-	-/-	-/-
	-/-	-/-	-/-	-/-	-/-	-/-
90 MHz	-/-	-/-	-/-	-/-	-/-	-/-
	-/-	-/-	-/-	-/-	-/-	-/-
100 MHz	-/-	-/-	-/-	-/-	-/-	-/-
	-/-	-/-	-/-	-/-	-/-	-/-

16-QAM modulation	Lowest channel		Middle channel		Highest channel	
	Spurious emissions (MHz)	Level (dBm)	Spurious emissions (MHz)	Level (dBm)	Spurious emissions (MHz)	Level (dBm)
10 MHz	-/-	-/-	-/-	-/-	-/-	-/-
	-/-	-/-	-/-	-/-	-/-	-/-
20 MHz	-/-	-/-	-/-	-/-	-/-	-/-
	-/-	-/-	-/-	-/-	-/-	-/-
30 MHz	-/-	-/-	-/-	-/-	-/-	-/-
	-/-	-/-	-/-	-/-	-/-	-/-
40 MHz	-/-	-/-	-/-	-/-	-/-	-/-
	-/-	-/-	-/-	-/-	-/-	-/-
50 MHz	-/-	-/-	-/-	-/-	-/-	-/-
	-/-	-/-	-/-	-/-	-/-	-/-
60 MHz	-/-	-/-	-/-	-/-	-/-	-/-
	-/-	-/-	-/-	-/-	-/-	-/-
70 MHz	-/-	-/-	-/-	-/-	-/-	-/-
	-/-	-/-	-/-	-/-	-/-	-/-
80 MHz	-/-	-/-	-/-	-/-	-/-	-/-
	-/-	-/-	-/-	-/-	-/-	-/-
90 MHz	-/-	-/-	-/-	-/-	-/-	-/-
	-/-	-/-	-/-	-/-	-/-	-/-
100 MHz	-/-	-/-	-/-	-/-	-/-	-/-
	-/-	-/-	-/-	-/-	-/-	-/-

64-QAM modulation	Lowest channel		Middle channel		Highest channel	
	Spurious emissions (MHz)	Level (dBm)	Spurious emissions (MHz)	Level (dBm)	Spurious emissions (MHz)	Level (dBm)
10 MHz	-/-	-/-	-/-	-/-	-/-	-/-
	-/-	-/-	-/-	-/-	-/-	-/-
20 MHz	-/-	-/-	-/-	-/-	-/-	-/-
	-/-	-/-	-/-	-/-	-/-	-/-
30 MHz	-/-	-/-	-/-	-/-	-/-	-/-
	-/-	-/-	-/-	-/-	-/-	-/-
40 MHz	-/-	-/-	-/-	-/-	-/-	-/-
	-/-	-/-	-/-	-/-	-/-	-/-
50 MHz	-/-	-/-	-/-	-/-	-/-	-/-
	-/-	-/-	-/-	-/-	-/-	-/-
60 MHz	-/-	-/-	-/-	-/-	-/-	-/-
	-/-	-/-	-/-	-/-	-/-	-/-
70 MHz	-/-	-/-	-/-	-/-	-/-	-/-
	-/-	-/-	-/-	-/-	-/-	-/-
80 MHz	-/-	-/-	-/-	-/-	-/-	-/-
	-/-	-/-	-/-	-/-	-/-	-/-
90 MHz	-/-	-/-	-/-	-/-	-/-	-/-
	-/-	-/-	-/-	-/-	-/-	-/-
100 MHz	-/-	-/-	-/-	-/-	-/-	-/-
	-/-	-/-	-/-	-/-	-/-	-/-

256-QAM modulation	Lowest channel		Middle channel		Highest channel	
	Spurious emissions (MHz)	Level (dBm)	Spurious emissions (MHz)	Level (dBm)	Spurious emissions (MHz)	Level (dBm)
10 MHz	-/-	-/-	-/-	-/-	-/-	-/-
	-/-	-/-	-/-	-/-	-/-	-/-
20 MHz	-/-	-/-	-/-	-/-	-/-	-/-
	-/-	-/-	-/-	-/-	-/-	-/-
30 MHz	-/-	-/-	-/-	-/-	-/-	-/-
	-/-	-/-	-/-	-/-	-/-	-/-
40 MHz	-/-	-/-	-/-	-/-	-/-	-/-
	-/-	-/-	-/-	-/-	-/-	-/-
50 MHz	-/-	-/-	-/-	-/-	-/-	-/-
	-/-	-/-	-/-	-/-	-/-	-/-
60 MHz	-/-	-/-	-/-	-/-	-/-	-/-
	-/-	-/-	-/-	-/-	-/-	-/-
70 MHz	-/-	-/-	-/-	-/-	-/-	-/-
	-/-	-/-	-/-	-/-	-/-	-/-
80 MHz	-/-	-/-	-/-	-/-	-/-	-/-
	-/-	-/-	-/-	-/-	-/-	-/-
90 MHz	-/-	-/-	-/-	-/-	-/-	-/-
	-/-	-/-	-/-	-/-	-/-	-/-
100 MHz	-/-	-/-	-/-	-/-	-/-	-/-
	-/-	-/-	-/-	-/-	-/-	-/-

**Results:** antenna 2

BPSK modulation	Lowest channel		Middle channel		Highest channel	
	Spurious emissions (MHz)	Level (dBm)	Spurious emissions (MHz)	Level (dBm)	Spurious emissions (MHz)	Level (dBm)
10 MHz	-/-	-/-	-/-	-/-	-/-	-/-
	-/-	-/-	-/-	-/-	-/-	-/-
20 MHz	-/-	-/-	-/-	-/-	-/-	-/-
	-/-	-/-	-/-	-/-	-/-	-/-
30 MHz	-/-	-/-	-/-	-/-	-/-	-/-
	-/-	-/-	-/-	-/-	-/-	-/-
40 MHz	-/-	-/-	-/-	-/-	-/-	-/-
	-/-	-/-	-/-	-/-	-/-	-/-
50 MHz	-/-	-/-	-/-	-/-	-/-	-/-
	-/-	-/-	-/-	-/-	-/-	-/-
60 MHz	-/-	-/-	-/-	-/-	-/-	-/-
	-/-	-/-	-/-	-/-	-/-	-/-
70 MHz	-/-	-/-	-/-	-/-	-/-	-/-
	-/-	-/-	-/-	-/-	-/-	-/-
80 MHz	-/-	-/-	-/-	-/-	-/-	-/-
	-/-	-/-	-/-	-/-	-/-	-/-
90 MHz	-/-	-/-	-/-	-/-	-/-	-/-
	-/-	-/-	-/-	-/-	-/-	-/-
100 MHz	-/-	-/-	-/-	-/-	-/-	-/-
	-/-	-/-	-/-	-/-	-/-	-/-

QPSK modulation	Lowest channel		Middle channel		Highest channel	
Bandwidth (MHz)	Spurious emissions (MHz)	Level (dBm)	Spurious emissions (MHz)	Level (dBm)	Spurious emissions (MHz)	Level (dBm)
10 MHz	-/-	-/-	-/-	-/-	-/-	-/-
	-/-	-/-	-/-	-/-	-/-	-/-
20 MHz	-/-	-/-	-/-	-/-	-/-	-/-
	-/-	-/-	-/-	-/-	-/-	-/-
30 MHz	-/-	-/-	-/-	-/-	-/-	-/-
	-/-	-/-	-/-	-/-	-/-	-/-
40 MHz	-/-	-/-	-/-	-/-	-/-	-/-
	-/-	-/-	-/-	-/-	-/-	-/-
50 MHz	-/-	-/-	-/-	-/-	-/-	-/-
	-/-	-/-	-/-	-/-	-/-	-/-
60 MHz	-/-	-/-	-/-	-/-	-/-	-/-
	-/-	-/-	-/-	-/-	-/-	-/-
70 MHz	-/-	-/-	-/-	-/-	-/-	-/-
	-/-	-/-	-/-	-/-	-/-	-/-
80 MHz	-/-	-/-	-/-	-/-	-/-	-/-
	-/-	-/-	-/-	-/-	-/-	-/-
90 MHz	-/-	-/-	-/-	-/-	-/-	-/-
	-/-	-/-	-/-	-/-	-/-	-/-
100 MHz	-/-	-/-	-/-	-/-	-/-	-/-
	-/-	-/-	-/-	-/-	-/-	-/-



16-QAM modulation	Lowest channel		Middle channel		Highest channel	
	Spurious emissions (MHz)	Level (dBm)	Spurious emissions (MHz)	Level (dBm)	Spurious emissions (MHz)	Level (dBm)
10 MHz	-/-	-/-	-/-	-/-	-/-	-/-
	-/-	-/-	-/-	-/-	-/-	-/-
20 MHz	-/-	-/-	-/-	-/-	-/-	-/-
	-/-	-/-	-/-	-/-	-/-	-/-
30 MHz	-/-	-/-	-/-	-/-	-/-	-/-
	-/-	-/-	-/-	-/-	-/-	-/-
40 MHz	-/-	-/-	-/-	-/-	-/-	-/-
	-/-	-/-	-/-	-/-	-/-	-/-
50 MHz	-/-	-/-	-/-	-/-	-/-	-/-
	-/-	-/-	-/-	-/-	-/-	-/-
60 MHz	-/-	-/-	-/-	-/-	-/-	-/-
	-/-	-/-	-/-	-/-	-/-	-/-
70 MHz	-/-	-/-	-/-	-/-	-/-	-/-
	-/-	-/-	-/-	-/-	-/-	-/-
80 MHz	-/-	-/-	-/-	-/-	-/-	-/-
	-/-	-/-	-/-	-/-	-/-	-/-
90 MHz	-/-	-/-	-/-	-/-	-/-	-/-
	-/-	-/-	-/-	-/-	-/-	-/-
100 MHz	-/-	-/-	-/-	-/-	-/-	-/-
	-/-	-/-	-/-	-/-	-/-	-/-

64-QAM modulation	Lowest channel		Middle channel		Highest channel	
	Spurious emissions (MHz)	Level (dBm)	Spurious emissions (MHz)	Level (dBm)	Spurious emissions (MHz)	Level (dBm)
10 MHz	-/-	-/-	-/-	-/-	-/-	-/-
	-/-	-/-	-/-	-/-	-/-	-/-
20 MHz	-/-	-/-	-/-	-/-	-/-	-/-
	-/-	-/-	-/-	-/-	-/-	-/-
30 MHz	-/-	-/-	-/-	-/-	-/-	-/-
	-/-	-/-	-/-	-/-	-/-	-/-
40 MHz	-/-	-/-	-/-	-/-	-/-	-/-
	-/-	-/-	-/-	-/-	-/-	-/-
50 MHz	-/-	-/-	-/-	-/-	-/-	-/-
	-/-	-/-	-/-	-/-	-/-	-/-
60 MHz	-/-	-/-	-/-	-/-	-/-	-/-
	-/-	-/-	-/-	-/-	-/-	-/-
70 MHz	-/-	-/-	-/-	-/-	-/-	-/-
	-/-	-/-	-/-	-/-	-/-	-/-
80 MHz	-/-	-/-	-/-	-/-	-/-	-/-
	-/-	-/-	-/-	-/-	-/-	-/-
90 MHz	-/-	-/-	-/-	-/-	-/-	-/-
	-/-	-/-	-/-	-/-	-/-	-/-
100 MHz	-/-	-/-	-/-	-/-	-/-	-/-
	-/-	-/-	-/-	-/-	-/-	-/-

256-QAM modulation	Lowest channel		Middle channel		Highest channel	
	Spurious emissions (MHz)	Level (dBm)	Spurious emissions (MHz)	Level (dBm)	Spurious emissions (MHz)	Level (dBm)
10 MHz	-/-	-/-	-/-	-/-	-/-	-/-
	-/-	-/-	-/-	-/-	-/-	-/-
20 MHz	-/-	-/-	-/-	-/-	-/-	-/-
	-/-	-/-	-/-	-/-	-/-	-/-
30 MHz	-/-	-/-	-/-	-/-	-/-	-/-
	-/-	-/-	-/-	-/-	-/-	-/-
40 MHz	-/-	-/-	-/-	-/-	-/-	-/-
	-/-	-/-	-/-	-/-	-/-	-/-
50 MHz	-/-	-/-	-/-	-/-	-/-	-/-
	-/-	-/-	-/-	-/-	-/-	-/-
60 MHz	-/-	-/-	-/-	-/-	-/-	-/-
	-/-	-/-	-/-	-/-	-/-	-/-
70 MHz	-/-	-/-	-/-	-/-	-/-	-/-
	-/-	-/-	-/-	-/-	-/-	-/-
80 MHz	-/-	-/-	-/-	-/-	-/-	-/-
	-/-	-/-	-/-	-/-	-/-	-/-
90 MHz	-/-	-/-	-/-	-/-	-/-	-/-
	-/-	-/-	-/-	-/-	-/-	-/-
100 MHz	-/-	-/-	-/-	-/-	-/-	-/-
	-/-	-/-	-/-	-/-	-/-	-/-

### 13.2.8 Spurious emissions conducted – 5G NR n77 – 3700 MHz to 3980 MHz

#### Description:

The following steps outline the procedure used to measure the conducted emissions from the mobile station.

1. The RF output of the transmitter was connected to a spectrum analyzer through a calibrated coaxial cable.
2. Determine frequency range for measurements: From § 2.1057 the spectrum should be investigated from the lowest radio frequency generated in the equipment up to at least the 10th harmonic of the carrier frequency.
3. Determine mobile station transmits frequencies: below outlines the band edge frequencies pertinent to conducted emissions testing.

#### Measurement:

Measurement parameters	
Detector:	Peak
Sweep time:	Auto
Resolution bandwidth:	1 MHz
Video bandwidth:	3 MHz
Span:	30 MHz – 40 GHz
Trace-Mode:	Max Hold
Used equipment:	See chapter 8.4 setup A
Measurement uncertainty:	see chapter 9
Measurement procedure	FCC: § 2.1051

#### Limits:

FCC
§ Part 27.53
<ul style="list-style-type: none"> <li>• (1) 3.7 GHz Service. The following emission limits apply to stations transmitting in the 3700 MHz to 3980 MHz band.</li> <li>• (2) for mobile operations in the 3700 MHz to 3980 MHz band, the conducted power of any emission outside the licensee`s authorized bandwidth shall not exceed -13dBm/MHz</li> </ul>

**Results:** antenna 1

BPSK modulation	Lowest channel		Middle channel		Highest channel	
	Spurious emissions (MHz)	Level (dBm)	Spurious emissions (MHz)	Level (dBm)	Spurious emissions (MHz)	Level (dBm)
10 MHz	-/-	-/-	-/-	-/-	-/-	-/-
	-/-	-/-	-/-	-/-	-/-	-/-
20 MHz	-/-	-/-	-/-	-/-	-/-	-/-
	-/-	-/-	-/-	-/-	-/-	-/-
30 MHz	-/-	-/-	-/-	-/-	-/-	-/-
	-/-	-/-	-/-	-/-	-/-	-/-
40 MHz	-/-	-/-	-/-	-/-	-/-	-/-
	-/-	-/-	-/-	-/-	-/-	-/-
50 MHz	-/-	-/-	-/-	-/-	-/-	-/-
	-/-	-/-	-/-	-/-	-/-	-/-
60 MHz	-/-	-/-	-/-	-/-	-/-	-/-
	-/-	-/-	-/-	-/-	-/-	-/-
70 MHz	-/-	-/-	-/-	-/-	-/-	-/-
	-/-	-/-	-/-	-/-	-/-	-/-
80 MHz	-/-	-/-	-/-	-/-	-/-	-/-
	-/-	-/-	-/-	-/-	-/-	-/-
90 MHz	-/-	-/-	-/-	-/-	-/-	-/-
	-/-	-/-	-/-	-/-	-/-	-/-
100 MHz	-/-	-/-	-/-	-/-	-/-	-/-
	-/-	-/-	-/-	-/-	-/-	-/-

QPSK modulation	Lowest channel		Middle channel		Highest channel	
Bandwidth (MHz)	Spurious emissions (MHz)	Level (dBm)	Spurious emissions (MHz)	Level (dBm)	Spurious emissions (MHz)	Level (dBm)
10 MHz	-/-	-/-	-/-	-/-	-/-	-/-
	-/-	-/-	-/-	-/-	-/-	-/-
20 MHz	-/-	-/-	-/-	-/-	-/-	-/-
	-/-	-/-	-/-	-/-	-/-	-/-
30 MHz	-/-	-/-	-/-	-/-	-/-	-/-
	-/-	-/-	-/-	-/-	-/-	-/-
40 MHz	-/-	-/-	-/-	-/-	-/-	-/-
	-/-	-/-	-/-	-/-	-/-	-/-
50 MHz	-/-	-/-	-/-	-/-	-/-	-/-
	-/-	-/-	-/-	-/-	-/-	-/-
60 MHz	-/-	-/-	-/-	-/-	-/-	-/-
	-/-	-/-	-/-	-/-	-/-	-/-
70 MHz	-/-	-/-	-/-	-/-	-/-	-/-
	-/-	-/-	-/-	-/-	-/-	-/-
80 MHz	-/-	-/-	-/-	-/-	-/-	-/-
	-/-	-/-	-/-	-/-	-/-	-/-
90 MHz	-/-	-/-	-/-	-/-	-/-	-/-
	-/-	-/-	-/-	-/-	-/-	-/-
100 MHz	-/-	-/-	-/-	-/-	-/-	-/-
	-/-	-/-	-/-	-/-	-/-	-/-

16-QAM modulation	Lowest channel		Middle channel		Highest channel	
	Spurious emissions (MHz)	Level (dBm)	Spurious emissions (MHz)	Level (dBm)	Spurious emissions (MHz)	Level (dBm)
10 MHz	-/-	-/-	-/-	-/-	-/-	-/-
	-/-	-/-	-/-	-/-	-/-	-/-
20 MHz	-/-	-/-	-/-	-/-	-/-	-/-
	-/-	-/-	-/-	-/-	-/-	-/-
30 MHz	-/-	-/-	-/-	-/-	-/-	-/-
	-/-	-/-	-/-	-/-	-/-	-/-
40 MHz	-/-	-/-	-/-	-/-	-/-	-/-
	-/-	-/-	-/-	-/-	-/-	-/-
50 MHz	-/-	-/-	-/-	-/-	-/-	-/-
	-/-	-/-	-/-	-/-	-/-	-/-
60 MHz	-/-	-/-	-/-	-/-	-/-	-/-
	-/-	-/-	-/-	-/-	-/-	-/-
70 MHz	-/-	-/-	-/-	-/-	-/-	-/-
	-/-	-/-	-/-	-/-	-/-	-/-
80 MHz	-/-	-/-	-/-	-/-	-/-	-/-
	-/-	-/-	-/-	-/-	-/-	-/-
90 MHz	-/-	-/-	-/-	-/-	-/-	-/-
	-/-	-/-	-/-	-/-	-/-	-/-
100 MHz	-/-	-/-	-/-	-/-	-/-	-/-
	-/-	-/-	-/-	-/-	-/-	-/-

64-QAM modulation	Lowest channel		Middle channel		Highest channel	
	Spurious emissions (MHz)	Level (dBm)	Spurious emissions (MHz)	Level (dBm)	Spurious emissions (MHz)	Level (dBm)
10 MHz	-/-	-/-	-/-	-/-	-/-	-/-
	-/-	-/-	-/-	-/-	-/-	-/-
20 MHz	-/-	-/-	-/-	-/-	-/-	-/-
	-/-	-/-	-/-	-/-	-/-	-/-
30 MHz	-/-	-/-	-/-	-/-	-/-	-/-
	-/-	-/-	-/-	-/-	-/-	-/-
40 MHz	-/-	-/-	-/-	-/-	-/-	-/-
	-/-	-/-	-/-	-/-	-/-	-/-
50 MHz	-/-	-/-	-/-	-/-	-/-	-/-
	-/-	-/-	-/-	-/-	-/-	-/-
60 MHz	-/-	-/-	-/-	-/-	-/-	-/-
	-/-	-/-	-/-	-/-	-/-	-/-
70 MHz	-/-	-/-	-/-	-/-	-/-	-/-
	-/-	-/-	-/-	-/-	-/-	-/-
80 MHz	-/-	-/-	-/-	-/-	-/-	-/-
	-/-	-/-	-/-	-/-	-/-	-/-
90 MHz	-/-	-/-	-/-	-/-	-/-	-/-
	-/-	-/-	-/-	-/-	-/-	-/-
100 MHz	-/-	-/-	-/-	-/-	-/-	-/-
	-/-	-/-	-/-	-/-	-/-	-/-



256-QAM modulation	Lowest channel		Middle channel		Highest channel	
	Spurious emissions (MHz)	Level (dBm)	Spurious emissions (MHz)	Level (dBm)	Spurious emissions (MHz)	Level (dBm)
10 MHz	-/-	-/-	-/-	-/-	-/-	-/-
	-/-	-/-	-/-	-/-	-/-	-/-
20 MHz	-/-	-/-	-/-	-/-	-/-	-/-
	-/-	-/-	-/-	-/-	-/-	-/-
30 MHz	-/-	-/-	-/-	-/-	-/-	-/-
	-/-	-/-	-/-	-/-	-/-	-/-
40 MHz	-/-	-/-	-/-	-/-	-/-	-/-
	-/-	-/-	-/-	-/-	-/-	-/-
50 MHz	-/-	-/-	-/-	-/-	-/-	-/-
	-/-	-/-	-/-	-/-	-/-	-/-
60 MHz	-/-	-/-	-/-	-/-	-/-	-/-
	-/-	-/-	-/-	-/-	-/-	-/-
70 MHz	-/-	-/-	-/-	-/-	-/-	-/-
	-/-	-/-	-/-	-/-	-/-	-/-
80 MHz	-/-	-/-	-/-	-/-	-/-	-/-
	-/-	-/-	-/-	-/-	-/-	-/-
90 MHz	-/-	-/-	-/-	-/-	-/-	-/-
	-/-	-/-	-/-	-/-	-/-	-/-
100 MHz	-/-	-/-	-/-	-/-	-/-	-/-
	-/-	-/-	-/-	-/-	-/-	-/-

**Results:** antenna 2

BPSK modulation	Lowest channel		Middle channel		Highest channel	
	Spurious emissions (MHz)	Level (dBm)	Spurious emissions (MHz)	Level (dBm)	Spurious emissions (MHz)	Level (dBm)
10 MHz	-/-	-/-	-/-	-/-	-/-	-/-
	-/-	-/-	-/-	-/-	-/-	-/-
20 MHz	-/-	-/-	-/-	-/-	-/-	-/-
	-/-	-/-	-/-	-/-	-/-	-/-
30 MHz	-/-	-/-	-/-	-/-	-/-	-/-
	-/-	-/-	-/-	-/-	-/-	-/-
40 MHz	-/-	-/-	-/-	-/-	-/-	-/-
	-/-	-/-	-/-	-/-	-/-	-/-
50 MHz	-/-	-/-	-/-	-/-	-/-	-/-
	-/-	-/-	-/-	-/-	-/-	-/-
60 MHz	-/-	-/-	-/-	-/-	-/-	-/-
	-/-	-/-	-/-	-/-	-/-	-/-
70 MHz	-/-	-/-	-/-	-/-	-/-	-/-
	-/-	-/-	-/-	-/-	-/-	-/-
80 MHz	-/-	-/-	-/-	-/-	-/-	-/-
	-/-	-/-	-/-	-/-	-/-	-/-
90 MHz	-/-	-/-	-/-	-/-	-/-	-/-
	-/-	-/-	-/-	-/-	-/-	-/-
100 MHz	-/-	-/-	-/-	-/-	-/-	-/-
	-/-	-/-	-/-	-/-	-/-	-/-

QPSK modulation	Lowest channel		Middle channel		Highest channel	
Bandwidth (MHz)	Spurious emissions (MHz)	Level (dBm)	Spurious emissions (MHz)	Level (dBm)	Spurious emissions (MHz)	Level (dBm)
10 MHz	-/-	-/-	-/-	-/-	-/-	-/-
	-/-	-/-	-/-	-/-	-/-	-/-
20 MHz	-/-	-/-	-/-	-/-	-/-	-/-
	-/-	-/-	-/-	-/-	-/-	-/-
30 MHz	-/-	-/-	-/-	-/-	-/-	-/-
	-/-	-/-	-/-	-/-	-/-	-/-
40 MHz	-/-	-/-	-/-	-/-	-/-	-/-
	-/-	-/-	-/-	-/-	-/-	-/-
50 MHz	-/-	-/-	-/-	-/-	-/-	-/-
	-/-	-/-	-/-	-/-	-/-	-/-
60 MHz	-/-	-/-	-/-	-/-	-/-	-/-
	-/-	-/-	-/-	-/-	-/-	-/-
70 MHz	-/-	-/-	-/-	-/-	-/-	-/-
	-/-	-/-	-/-	-/-	-/-	-/-
80 MHz	-/-	-/-	-/-	-/-	-/-	-/-
	-/-	-/-	-/-	-/-	-/-	-/-
90 MHz	-/-	-/-	-/-	-/-	-/-	-/-
	-/-	-/-	-/-	-/-	-/-	-/-
100 MHz	-/-	-/-	-/-	-/-	-/-	-/-
	-/-	-/-	-/-	-/-	-/-	-/-

16-QAM modulation	Lowest channel		Middle channel		Highest channel	
	Spurious emissions (MHz)	Level (dBm)	Spurious emissions (MHz)	Level (dBm)	Spurious emissions (MHz)	Level (dBm)
10 MHz	-/-	-/-	-/-	-/-	-/-	-/-
	-/-	-/-	-/-	-/-	-/-	-/-
20 MHz	-/-	-/-	-/-	-/-	-/-	-/-
	-/-	-/-	-/-	-/-	-/-	-/-
30 MHz	-/-	-/-	-/-	-/-	-/-	-/-
	-/-	-/-	-/-	-/-	-/-	-/-
40 MHz	-/-	-/-	-/-	-/-	-/-	-/-
	-/-	-/-	-/-	-/-	-/-	-/-
50 MHz	-/-	-/-	-/-	-/-	-/-	-/-
	-/-	-/-	-/-	-/-	-/-	-/-
60 MHz	-/-	-/-	-/-	-/-	-/-	-/-
	-/-	-/-	-/-	-/-	-/-	-/-
70 MHz	-/-	-/-	-/-	-/-	-/-	-/-
	-/-	-/-	-/-	-/-	-/-	-/-
80 MHz	-/-	-/-	-/-	-/-	-/-	-/-
	-/-	-/-	-/-	-/-	-/-	-/-
90 MHz	-/-	-/-	-/-	-/-	-/-	-/-
	-/-	-/-	-/-	-/-	-/-	-/-
100 MHz	-/-	-/-	-/-	-/-	-/-	-/-
	-/-	-/-	-/-	-/-	-/-	-/-

64-QAM modulation	Lowest channel		Middle channel		Highest channel	
	Spurious emissions (MHz)	Level (dBm)	Spurious emissions (MHz)	Level (dBm)	Spurious emissions (MHz)	Level (dBm)
10 MHz	-/-	-/-	-/-	-/-	-/-	-/-
	-/-	-/-	-/-	-/-	-/-	-/-
20 MHz	-/-	-/-	-/-	-/-	-/-	-/-
	-/-	-/-	-/-	-/-	-/-	-/-
30 MHz	-/-	-/-	-/-	-/-	-/-	-/-
	-/-	-/-	-/-	-/-	-/-	-/-
40 MHz	-/-	-/-	-/-	-/-	-/-	-/-
	-/-	-/-	-/-	-/-	-/-	-/-
50 MHz	-/-	-/-	-/-	-/-	-/-	-/-
	-/-	-/-	-/-	-/-	-/-	-/-
60 MHz	-/-	-/-	-/-	-/-	-/-	-/-
	-/-	-/-	-/-	-/-	-/-	-/-
70 MHz	-/-	-/-	-/-	-/-	-/-	-/-
	-/-	-/-	-/-	-/-	-/-	-/-
80 MHz	-/-	-/-	-/-	-/-	-/-	-/-
	-/-	-/-	-/-	-/-	-/-	-/-
90 MHz	-/-	-/-	-/-	-/-	-/-	-/-
	-/-	-/-	-/-	-/-	-/-	-/-
100 MHz	-/-	-/-	-/-	-/-	-/-	-/-
	-/-	-/-	-/-	-/-	-/-	-/-

256-QAM modulation	Lowest channel		Middle channel		Highest channel	
	Spurious emissions (MHz)	Level (dBm)	Spurious emissions (MHz)	Level (dBm)	Spurious emissions (MHz)	Level (dBm)
10 MHz	-/-	-/-	-/-	-/-	-/-	-/-
	-/-	-/-	-/-	-/-	-/-	-/-
20 MHz	-/-	-/-	-/-	-/-	-/-	-/-
	-/-	-/-	-/-	-/-	-/-	-/-
30 MHz	-/-	-/-	-/-	-/-	-/-	-/-
	-/-	-/-	-/-	-/-	-/-	-/-
40 MHz	-/-	-/-	-/-	-/-	-/-	-/-
	-/-	-/-	-/-	-/-	-/-	-/-
50 MHz	-/-	-/-	-/-	-/-	-/-	-/-
	-/-	-/-	-/-	-/-	-/-	-/-
60 MHz	-/-	-/-	-/-	-/-	-/-	-/-
	-/-	-/-	-/-	-/-	-/-	-/-
70 MHz	-/-	-/-	-/-	-/-	-/-	-/-
	-/-	-/-	-/-	-/-	-/-	-/-
80 MHz	-/-	-/-	-/-	-/-	-/-	-/-
	-/-	-/-	-/-	-/-	-/-	-/-
90 MHz	-/-	-/-	-/-	-/-	-/-	-/-
	-/-	-/-	-/-	-/-	-/-	-/-
100 MHz	-/-	-/-	-/-	-/-	-/-	-/-
	-/-	-/-	-/-	-/-	-/-	-/-

### 13.2.9 Block edge compliance – 5G NR n77 – 3450 MHz to 3550 MHz

#### Description:

The spectrum at the band edges must comply with the spurious emissions limits.

#### Measurement:

Measurement parameters	
Detector:	RMS
Sweep time:	30 sec.
Video bandwidth:	See plots
Resolution bandwidth:	See plots
Span:	1 MHz steps
Trace-Mode:	Max Hold
Used equipment:	See chapter 8.4 setup A
Measurement uncertainty:	See chapter 9
Measurement procedure	FCC: § 2.1051

#### Limits:

FCC
§ 27.53
<p>The following emission limits apply to stations transmitting in the 3450 MHz to 3550 MHz frequency band: For mobile operations in the 3450 MHz to 3550 MHz frequency band, the conducted power of any emission outside the licensee's authorized bandwidth shall not exceed -13 dBm/MHz. compliance with this paragraph (n)(2) is based on the use of measurement instrumentation employing a resolution bandwidth of 1 MHz or greater. However, in the 1 MHz bands immediately outside an adjacent to the licensee's frequency block, a resolution bandwidth of at least one percent of the emission bandwidth of the fundamental emission of the transmitter, may be employed, but limited to a maximum of 200 kHz. In the band between 1 and 5 MHz removed from the licensee's frequency block, the minimum resolution bandwidth for the measurement shall be 500 kHz. The emission bandwidth is defined as the width of the signal between two points, one below the carrier center frequency and one above the carrier center frequency, outside of which all emissions are attenuated at least 26 dB below the transmitter power.</p>

**Results: PASS** (See log files)

### 13.2.10 Block edge compliance – 5G NR n77 – 3700 MHz to 3980 MHz

#### Description:

The spectrum at the band edges must comply with the spurious emissions limits.

#### Measurement:

Measurement parameters	
Detector:	RMS
Sweep time:	30 sec.
Video bandwidth:	See plots
Resolution bandwidth:	See plots
Span:	1 MHz steps
Trace-Mode:	Max Hold
Used equipment:	See chapter 8.4 setup A
Measurement uncertainty:	See chapter 9
Measurement procedure	FCC: § 2.1051

#### Limits:

FCC
§ 27.53
<p>The following emission limits apply to stations transmitting in the 3700 MHz to 3980 MHz frequency band: For mobile operations in the 3700 MHz to 3980 MHz frequency band, the conducted power of any emission outside the licensee's authorized bandwidth shall not exceed -13 dBm/MHz. compliance with this paragraph (n)(2) is based on the use of measurement instrumentation employing a resolution bandwidth of 1 MHz or greater. However, in the 1 MHz bands immediately outside an adjacent to the licensee's frequency block, a resolution bandwidth of at least one percent of the emission bandwidth of the fundamental emission of the transmitter, may be employed, but limited to a maximum of 350 kHz. In the band between 1 and 5 MHz removed from the licensee's frequency block, the minimum resolution bandwidth for the measurement shall be 500 kHz. The emission bandwidth is defined as the width of the signal between two points, one below the carrier center frequency and one above the carrier center frequency, outside of which all emissions are attenuated at least 26 dB below the transmitter power.</p>

**Results: PASS** (See log files)



### 13.2.11 Occupied bandwidth – 5G NR n77 – 3450 MHz to 3550 MHz

#### Description:

Measurement of the occupied bandwidth of the transmitted signal. The transmitter output was connected to a calibrated coaxial cable and a coupler to a spectrum analyzer.

#### Measurement:

Similar to conducted emissions, occupied bandwidth measurements are only provided for selected frequencies in order to reduce the amount of submitted data. Data were taken at the extreme and mid frequencies of the 5G NR band 77 frequency band. The table below lists the measured 99% power and -26dBc occupied bandwidths.

Measurement parameters	
Detector:	Peak
Sweep time:	180s
Resolution bandwidth:	30 kHz
Video bandwidth:	100 kHz
Span:	2 x nominal bandwidth
Trace-Mode:	Max Hold
Used equipment:	See chapter 8.4 setup A
Measurement uncertainty:	See chapter 9
Measurement procedure	FCC: § 2.1049

#### Limits:

FCC
§ 2.1049
Reporting only

**Results:** antenna 1

Occupied Bandwidth			
BPSK modulation	Channel	99% OBW (MHz)	-26 dBc BW (MHz)
Bandwidth			
10	low	8.616	9.800
	mid	8.691	10.100
	high	8.666	10.175
20	low	18.032	19.700
	mid	17.982	19.850
	high	18.082	19.850
30	low	26.823	28.950
	mid	26.973	28.875
	high	26.973	29.025
40	low	35.964	38.500
	mid	35.964	38.600
	high	35.964	38.600
50	low	45.954	48.750
	mid	45.954	48.500
	high	45.954	48.750
60	low	57.842	61.050
	mid	57.842	61.050
	high	57.842	60.900
70	low	64.336	67.200
	mid	64.336	67.375
	high	64.510	67.200
80	low	77.323	82.000
	mid	77.323	82.000
	high	77.323	82.000
90	low	86.988	91.800
	mid	86.763	91.575
	high	86.988	91.575
100	low	-/-	-/-
	mid	96.903	101.500
	high	-/-	-/-

Occupied Bandwidth			
QPSK modulation	Channel	99% OBW (MHz)	-26 dBc BW (MHz)
Bandwidth			
10	low	8.641	10.275
	mid	8.641	10.000
	high	8.666	10.200
20	low	18.132	20.100
	mid	18.132	20.000
	high	18.182	20.150
30	low	26.823	28.875
	mid	26.823	28.800
	high	26.823	28.800
40	low	35.864	38.700
	mid	35.964	38.700
	high	35.864	38.700
50	low	45.829	48.750
	mid	45.829	48.750
	high	45.829	48.625
60	low	57.692	60.600
	mid	57.842	60.900
	high	57.992	60.750
70	low	64.336	67.375
	mid	64.336	67.375
	high	64.510	67.200
80	low	77.522	82.200
	mid	77.522	82.400
	high	77.522	82.400
90	low	86.988	92.025
	mid	87.213	91.800
	high	86.988	92.025
100	low	-/-	-/-
	mid	96.653	101.500
	high	-/-	-/-

Occupied Bandwidth			
16-QAM modulation	Channel	99% OBW (MHz)	-26 dBc BW (MHz)
Bandwidth			
10	low	8.691	10.075
	mid	8.691	10.250
	high	8.691	10.000
20	low	18.082	19.650
	mid	18.032	20.050
	high	18.082	20.000
30	low	26.973	29.025
	mid	26.973	28.875
	high	26.973	28.950
40	low	36.064	38.700
	mid	36.064	38.600
	high	36.064	38.800
50	low	45.829	48.875
	mid	45.829	48.625
	high	45.829	48.875
60	low	57.842	60.900
	mid	57.842	60.750
	high	57.992	60.750
70	low	64.336	67.200
	mid	64.336	67.200
	high	64.336	67.200
80	low	77.323	82.400
	mid	77.323	82.200
	high	77.522	82.200
90	low	86.763	92.025
	mid	86.988	91.800
	high	86.988	92.025
100	low	-/-	-/-
	mid	96.653	101.500
	high	-/-	-/-

Occupied Bandwidth			
64-QAM modulation	Channel	99% OBW (MHz)	-26 dBc BW (MHz)
Bandwidth			
10	low	8.666	10.025
	mid	8.666	10.050
	high	8.641	9.925
20	low	18.032	19.800
	mid	18.132	19.950
	high	18.082	19.700
30	low	26.898	28.950
	mid	26.898	28.950
	high	26.898	28.950
40	low	35.964	38.700
	mid	35.964	38.600
	high	35.964	38.800
50	low	45.954	48.500
	mid	46.079	48.625
	high	45.954	48.875
60	low	57.992	61.050
	mid	57.992	60.900
	high	57.992	60.900
70	low	64.336	67.200
	mid	64.510	67.200
	high	64.510	67.200
80	low	77.522	82.200
	mid	77.522	82.400
	high	77.522	82.400
90	low	86.763	92.025
	mid	86.988	92.025
	high	86.988	92.025
100	low	-/-	-/-
	mid	96.653	101.500
	high	-/-	-/-

Occupied Bandwidth			
256-QAM modulation	Channel	99% OBW (MHz)	-26 dBc BW (MHz)
Bandwidth			
10	low	8.641	10.200
	mid	8.641	10.000
	high	8.616	10.200
20	low	17.982	19.700
	mid	18.032	20.050
	high	17.982	19.900
30	low	26.973	28.875
	mid	26.973	29.025
	high	26.973	28.950
40	low	35.964	38.800
	mid	35.964	38.700
	high	35.964	38.700
50	low	45.829	48.375
	mid	45.704	48.500
	high	45.829	48.500
60	low	57.842	60.900
	mid	57.842	60.900
	high	57.842	61.050
70	low	64.161	67.200
	mid	64.161	67.025
	high	64.161	67.200
80	low	77.522	82.000
	mid	77.522	82.200
	high	77.522	82.000
90	low	86.763	91.575
	mid	86.988	91.800
	high	86.538	91.575
100	low	-/-	-/-
	mid	96.404	101.750
	high	-/-	-/-

**Results:** antenna 2

Occupied Bandwidth			
QPSK modulation	Channel	99% OBW (MHz)	-26 dBc BW (MHz)
Bandwidth			
10	low	8.666	10.400
	mid	8.691	10.275
	high	8.666	10.250
20	low	18.382	20.400
	mid	18.382	20.300
	high	18.382	20.250
30	low	27.872	29.775
	mid	27.872	30.000
	high	27.872	30.225
40	low	37.962	40.800
	mid	37.962	40.800
	high	37.962	40.900
50	low	47.453	50.250
	mid	47.453	50.375
	high	47.577	50.750
60	low	57.842	60.900
	mid	57.692	60.900
	high	57.842	61.050
70	low	67.483	70.525
	mid	67.483	70.875
	high	67.657	70.700
80	low	77.922	82.400
	mid	77.922	82.600
	high	77.922	82.800
90	low	87.662	92.700
	mid	87.887	92.700
	high	87.662	92.700
100	low	-/-	-/-
	mid	97.902	102.500
	high	-/-	-/-

Occupied Bandwidth			
16-QAM modulation	Channel	99% OBW (MHz)	-26 dBc BW (MHz)
Bandwidth			
10	low	8.666	10.050
	mid	8.691	10.150
	high	8.666	9.800
20	low	18.332	20.300
	mid	18.382	20.350
	high	18.332	20.300
30	low	27.947	30.075
	mid	27.947	30.000
	high	27.947	30.000
40	low	37.962	41.100
	mid	37.962	40.900
	high	38.062	40.800
50	low	47.577	50.250
	mid	47.577	50.375
	high	47.577	50.250
60	low	57.692	60.750
	mid	57.842	60.750
	high	57.842	60.900
70	low	67.308	70.700
	mid	67.483	70.350
	high	67.483	70.350
80	low	77.722	82.400
	mid	77.722	82.600
	high	77.922	82.800
90	low	87.662	92.700
	mid	87.887	92.700
	high	87.887	92.700
100	low	-/-	-/-
	mid	97.652	102.750
	high	-/-	-/-



Occupied Bandwidth			
64-QAM modulation	Channel	99% OBW (MHz)	-26 dBc BW (MHz)
Bandwidth			
10	low	8.641	9.825
	mid	8.641	9.825
	high	8.641	9.825
20	low	18.332	20.150
	mid	18.332	20.250
	high	18.332	20.200
30	low	27.947	30.225
	mid	28.022	29.850
	high	27.947	30.150
40	low	37.962	40.600
	mid	37.962	40.900
	high	38.062	40.900
50	low	47.577	50.500
	mid	47.577	50.375
	high	47.702	50.625
60	low	57.842	60.900
	mid	57.842	60.900
	high	57.992	60.900
70	low	67.483	70.525
	mid	67.657	70.525
	high	67.657	70.350
80	low	77.922	82.600
	mid	77.922	82.800
	high	77.922	82.600
90	low	87.662	92.700
	mid	87.887	92.700
	high	87.887	92.700
100	low	-/-	-/-
	mid	97.652	102.750
	high	-/-	-/-

Occupied Bandwidth			
256-QAM modulation	Channel	99% OBW (MHz)	-26 dBc BW (MHz)
Bandwidth			
10	low	8.616	10.025
	mid	8.641	10.100
	high	8.616	10.075
20	low	18.282	20.000
	mid	18.282	20.200
	high	18.332	20.200
30	low	27.872	30.075
	mid	27.872	29.550
	high	27.872	30.000
40	low	37.962	40.800
	mid	37.962	40.700
	high	37.962	40.600
50	low	47.702	50.375
	mid	47.702	50.375
	high	47.702	50.625
60	low	57.842	60.900
	mid	57.692	60.750
	high	57.842	60.750
70	low	67.483	70.875
	mid	67.483	70.700
	high	67.483	70.525
80	low	77.522	82.600
	mid	77.722	82.400
	high	77.922	82.400
90	low	87.887	92.475
	mid	87.887	92.700
	high	87.887	92.700
100	low	-/-	-/-
	mid	97.652	102.750
	high	-/-	-/-

**13.2.12 Occupied bandwidth – 5G NR n77 – 3700 MHz to 3980 MHz**

**Description:**

Measurement of the occupied bandwidth of the transmitted signal. The transmitter output was connected to a calibrated coaxial cable and a coupler to a spectrum analyzer.

**Measurement:**

Similar to conducted emissions, occupied bandwidth measurements are only provided for selected frequencies in order to reduce the amount of submitted data. Data were taken at the extreme and mid frequencies of the 5G NR band 77 frequency band. The table below lists the measured 99% power and -26dBc occupied bandwidths.

Measurement parameters	
Detector:	Peak
Sweep time:	180s
Resolution bandwidth:	30 kHz
Video bandwidth:	100 kHz
Span:	2 x nominal bandwidth
Trace-Mode:	Max Hold
Used equipment:	See chapter 8.4 setup A
Measurement uncertainty:	See chapter 9
Measurement procedure	FCC: § 2.1049

**Limits:**

FCC
§ 2.1049
Reporting only

**Results:** antenna 1

Occupied Bandwidth			
BPSK modulation	Channel	99% OBW (MHz)	-26 dBc BW (MHz)
Bandwidth			
10	low	8.666	9.900
	mid	8.666	10.075
	high	8.716	10.175
20	low	17.982	19.650
	mid	17.982	19.900
	high	18.032	20.050
30	low	26.973	28.800
	mid	26.973	28.875
	high	26.973	29.025
40	low	36.064	38.700
	mid	35.964	38.600
	high	36.064	38.700
50	low	45.954	48.750
	mid	45.954	48.875
	high	45.954	48.625
60	low	57.842	60.750
	mid	57.842	61.200
	high	57.842	61.050
70	low	64.336	67.375
	mid	64.336	67.375
	high	64.510	67.025
80	low	77.522	82.000
	mid	77.323	82.000
	high	77.522	82.000
90	low	86.988	91.800
	mid	86.988	91.575
	high	86.988	91.575
100	low	96.653	101.750
	mid	96.653	101.500
	high	96.903	101.500

Occupied Bandwidth			
QPSK modulation	Channel	99% OBW (MHz)	-26 dBc BW (MHz)
Bandwidth			
10	low	8.666	10.150
	mid	8.641	9.950
	high	8.666	10.075
20	low	18.132	20.250
	mid	18.132	20.000
	high	18.182	20.250
30	low	26.823	28.800
	mid	26.898	28.875
	high	26.898	28.800
40	low	35.864	38.700
	mid	35.964	38.700
	high	35.964	38.800
50	low	45.829	49.000
	mid	45.829	48.500
	high	45.954	48.625
60	low	57.842	60.750
	mid	57.842	60.750
	high	57.842	60.900
70	low	64.336	67.900
	mid	64.510	67.200
	high	64.510	67.375
80	low	77.522	82.200
	mid	77.522	82.200
	high	77.722	82.600
90	low	87.213	91.800
	mid	86.988	92.025
	high	87.213	92.025
100	low	96.653	101.750
	mid	96.903	101.750
	high	96.653	101.750

Occupied Bandwidth			
16-QAM modulation	Channel	99% OBW (MHz)	-26 dBc BW (MHz)
Bandwidth			
10	low	8.691	9.850
	mid	8.691	10.225
	high	8.666	10.075
20	low	18.032	19.800
	mid	18.032	20.100
	high	18.032	20.150
30	low	26.973	29.100
	mid	26.973	29.025
	high	26.973	29.175
40	low	36.064	38.700
	mid	36.064	38.900
	high	36.164	38.800
50	low	45.954	48.625
	mid	45.829	48.625
	high	45.829	48.875
60	low	57.992	61.050
	mid	57.992	60.900
	high	57.992	60.750
70	low	64.510	67.200
	mid	64.510	67.375
	high	64.510	67.375
80	low	77.323	82.200
	mid	77.323	82.200
	high	77.323	82.400
90	low	86.988	92.025
	mid	86.988	92.025
	high	87.213	91.800
100	low	96.653	101.500
	mid	96.653	101.500
	high	96.653	101.500

Occupied Bandwidth			
64-QAM modulation	Channel	99% OBW (MHz)	-26 dBc BW (MHz)
Bandwidth			
10	low	8.641	10.050
	mid	8.666	10.100
	high	8.641	10.125
20	low	18.082	19.950
	mid	18.082	19.950
	high	18.032	19.750
30	low	26.973	29.025
	mid	26.898	28.875
	high	26.898	28.875
40	low	36.064	38.700
	mid	36.064	38.700
	high	36.064	38.600
50	low	46.079	48.500
	mid	46.079	48.750
	high	46.079	48.750
60	low	57.992	61.050
	mid	57.842	61.050
	high	57.992	61.050
70	low	64.510	67.550
	mid	64.510	67.375
	high	64.336	67.200
80	low	77.522	82.400
	mid	77.522	82.000
	high	77.522	82.200
90	low	86.988	91.800
	mid	86.763	92.025
	high	86.988	92.025
100	low	96.653	101.750
	mid	96.404	101.750
	high	96.653	101.750

Occupied Bandwidth			
256-QAM modulation	Channel	99% OBW (MHz)	-26 dBc BW (MHz)
Bandwidth			
10	low	8.641	10.175
	mid	8.641	10.000
	high	8.641	10.200
20	low	17.982	19.850
	mid	17.982	20.100
	high	17.982	19.700
30	low	26.898	28.950
	mid	26.973	28.875
	high	26.973	28.950
40	low	36.064	38.700
	mid	35.964	38.800
	high	35.964	38.600
50	low	45.829	48.625
	mid	45.829	48.625
	high	45.954	48.375
60	low	57.842	60.600
	mid	57.842	60.900
	high	57.842	60.750
70	low	64.336	67.200
	mid	64.161	67.200
	high	64.336	67.200
80	low	77.722	82.400
	mid	77.522	82.200
	high	77.522	82.200
90	low	86.763	91.575
	mid	86.763	91.575
	high	86.988	91.800
100	low	96.653	101.750
	mid	96.404	101.750
	high	96.653	101.750



**Results:** antenna 2

Occupied Bandwidth			
QPSK modulation	Channel	99% OBW (MHz)	-26 dBc BW (MHz)
Bandwidth			
10	low	8.691	10.325
	mid	8.666	10.225
	high	8.666	10.225
20	low	18.382	20.300
	mid	18.432	20.600
	high	18.382	20.200
30	low	27.872	30.075
	mid	27.947	30.150
	high	27.872	30.000
40	low	38.062	40.800
	mid	37.962	40.800
	high	38.062	40.900
50	low	47.577	50.250
	mid	47.577	50.500
	high	47.577	50.500
60	low	57.842	61.050
	mid	57.842	61.050
	high	57.842	60.900
70	low	67.483	70.700
	mid	67.483	70.700
	high	67.657	70.525
80	low	77.922	82.600
	mid	77.922	82.400
	high	77.922	82.600
90	low	87.662	92.925
	mid	87.662	92.700
	high	87.662	92.700
100	low	97.652	103.000
	mid	97.652	102.500
	high	97.652	102.750

Occupied Bandwidth			
16QAM modulation	Channel	99% OBW (kHz)	-26 dBc BW (kHz)
Bandwidth			
10	low	8.666	9.950
	mid	8.691	10.300
	high	8.666	10.025
20	low	18.382	20.300
	mid	18.382	20.300
	high	18.432	20.400
30	low	27.872	30.075
	mid	27.947	30.150
	high	27.947	30.075
40	low	38.162	40.900
	mid	38.062	40.900
	high	38.062	40.800
50	low	47.577	50.375
	mid	47.702	50.625
	high	47.453	50.250
60	low	57.842	60.900
	mid	57.692	60.900
	high	57.842	60.600
70	low	67.483	70.700
	mid	67.483	70.700
	high	67.483	70.700
80	low	77.722	82.400
	mid	77.722	82.600
	high	77.722	82.600
90	low	87.662	92.475
	mid	87.887	92.700
	high	87.887	92.700
100	low	97.652	102.750
	mid	97.652	102.500
	high	97.403	102.500

Occupied Bandwidth			
64-QAM modulation	Channel	99% OBW (kHz)	-26 dBc BW (kHz)
Bandwidth			
10	low	8.641	9.800
	mid	8.641	9.875
	high	8.641	9.875
20	low	18.332	20.150
	mid	18.332	20.050
	high	18.282	20.250
30	low	28.022	30.075
	mid	28.022	29.925
	high	28.022	30.150
40	low	37.962	40.700
	mid	37.962	40.400
	high	37.962	40.700
50	low	47.577	50.500
	mid	47.577	50.500
	high	47.702	50.500
60	low	57.992	60.900
	mid	57.842	60.900
	high	57.842	60.900
70	low	67.657	71.050
	mid	67.657	70.700
	high	67.657	70.700
80	low	77.922	82.600
	mid	77.722	82.600
	high	77.722	82.800
90	low	87.887	92.475
	mid	87.887	92.700
	high	87.662	92.700
100	low	97.652	102.750
	mid	97.652	102.750
	high	97.652	102.750

Occupied Bandwidth			
256-QAM modulation	Channel	99% OBW (kHz)	-26 dBc BW (kHz)
Bandwidth			
10	low	8.616	10.025
	mid	8.616	10.075
	high	8.616	10.025
20	low	18.282	20.150
	mid	18.332	20.300
	high	18.282	20.150
30	low	27.872	30.075
	mid	27.872	29.850
	high	27.872	29.850
40	low	38.062	40.800
	mid	37.962	40.700
	high	37.962	40.700
50	low	47.577	50.375
	mid	47.702	50.375
	high	47.577	50.500
60	low	57.992	61.050
	mid	57.842	60.900
	high	57.842	60.750
70	low	67.483	70.525
	mid	67.483	70.700
	high	67.483	70.875
80	low	77.922	82.600
	mid	77.722	82.400
	high	77.722	82.400
90	low	87.887	92.700
	mid	87.662	92.700
	high	87.662	92.700
100	low	97.652	102.750
	mid	97.652	102.500
	high	97.652	102.750

## 14 Glossary

<b>EUT</b>	Equipment under test
<b>DUT</b>	Device under test
<b>UUT</b>	Unit under test
<b>GUE</b>	GNSS User Equipment
<b>ETSI</b>	European Telecommunications Standards Institute
<b>EN</b>	European Standard
<b>FCC</b>	Federal Communications Commission
<b>FCC ID</b>	Company Identifier at FCC
<b>IC</b>	Industry Canada
<b>PMN</b>	Product marketing name
<b>HMN</b>	Host marketing name
<b>HVIN</b>	Hardware version identification number
<b>FVIN</b>	Firmware version identification number
<b>EMC</b>	Electromagnetic Compatibility
<b>HW</b>	Hardware
<b>SW</b>	Software
<b>Inv. No.</b>	Inventory number
<b>S/N or SN</b>	Serial number
<b>C</b>	Compliant
<b>NC</b>	Not compliant
<b>NA</b>	Not applicable
<b>NP</b>	Not performed
<b>PP</b>	Positive peak
<b>QP</b>	Quasi peak
<b>AVG</b>	Average
<b>OC</b>	Operating channel
<b>OCW</b>	Operating channel bandwidth
<b>OBW</b>	Occupied bandwidth
<b>OOB</b>	Out of band
<b>DFS</b>	Dynamic frequency selection
<b>CAC</b>	Channel availability check
<b>OP</b>	Occupancy period
<b>NOP</b>	Non occupancy period
<b>DC</b>	Duty cycle
<b>PER</b>	Packet error rate
<b>CW</b>	Clean wave
<b>MC</b>	Modulated carrier
<b>WLAN</b>	Wireless local area network
<b>RLAN</b>	Radio local area network
<b>DSSS</b>	Dynamic sequence spread spectrum
<b>OFDM</b>	Orthogonal frequency division multiplexing
<b>FHSS</b>	Frequency hopping spread spectrum
<b>GNSS</b>	Global Navigation Satellite System
<b>C/N<sub>0</sub></b>	Carrier to noise-density ratio, expressed in dB-Hz

## 15 Document history

Version	Applied changes	Date of release
-/-	Initial release	2023-01-18

## 16 Accreditation Certificate – D-PL-12076-01-05

first page

last page



Deutsche Akkreditierungsstelle GmbH

Entrusted according to Section 8 subsection 1 AkkStelleG in connection with Section 1 subsection 1 AkkStelleGBV  
Signatory to the Multilateral Agreements of EA, ILAC and IAF for Mutual Recognition

### Accreditation



The Deutsche Akkreditierungsstelle GmbH attests that the testing laboratory

**CTC advanced GmbH**  
Untertürkheimer Straße 6-10, 66117 Saarbrücken

is competent under the terms of DIN EN ISO/IEC 17025:2018 to carry out tests in the following fields:

**Telecommunication (FCC Requirements)**

The accreditation certificate shall only apply in connection with the notice of accreditation of 09.06.2020 with the accreditation number D-PL-12076-01. It comprises the cover sheet, the reverse side of the cover sheet and the following annex with a total of 05 pages.

Registration number of the certificate: **D-PL-12076-01-05**

Frankfurt am Main, 09.06.2020

by order of Dipl.-Ing. (FH) Ralf Eigner  
Head of Division

The certificate together with its annex reflects the status at the time of the date of issue. The current status of the scope of accreditation can be found in the database of accredited bodies of Deutsche Akkreditierungsstelle GmbH.  
<https://www.dakks.de/en/concern/accredited-bodies-dakks>  
for notes see below.

Deutsche Akkreditierungsstelle GmbH

Office Berlin  
Spittelmarkt 10  
10117 Berlin

Office Frankfurt am Main  
Europa-Allee 52  
60327 Frankfurt am Main

Office Braunschweig  
Bundesallee 100  
38116 Braunschweig

The publication of extracts of the accreditation certificate is subject to the prior written approval by Deutsche Akkreditierungsstelle GmbH (DAkkS). Exempted is the unchanged form of separate disseminations of the cover sheet by the conformity assessment body mentioned overleaf.

No impression shall be made that the accreditation also extends to fields beyond the scope of accreditation attested by DAkkS.

The accreditation was granted pursuant to the Act on the Accreditation Body (AkkStelleG) of 31 July 2009 (Federal Law Gazette I p. 2625) and the Regulation (EC) No 765/2008 of the European Parliament and of the Council of 9 July 2008 setting out the requirements for accreditation and market surveillance relating to the marketing of products (Official Journal of the European Union L 218 of 9 July 2008, p. 30). DAkkS is a signatory to the Multilateral Agreements for Mutual Recognition of the European co-operation for Accreditation (EA), International Accreditation Forum (IAF) and International Laboratory Accreditation Cooperation (ILAC). The signatories to these agreements recognise each other's accreditations.

The up-to-date state of membership can be retrieved from the following websites:  
EA: [www.european-accreditation.org](http://www.european-accreditation.org)  
ILAC: [www.ilac.org](http://www.ilac.org)  
IAF: [www.iaf.nu](http://www.iaf.nu)

**Note: The current certificate annex is published on the websites (link see below).**

<https://www.dakks.de/files/data/as/pdf/D-PL-12076-01-05e.pdf>

or

[https://ctcadvanced.com/app/uploads/2020/06/D-PL-12076-01-05\\_TCB\\_USA.pdf](https://ctcadvanced.com/app/uploads/2020/06/D-PL-12076-01-05_TCB_USA.pdf)

##### END OF TEST REPORT #####