



SAR TEST REPORT

No. 2013EEB00584-SAR

For

Shenzhen Sang Fei Consumer Communications Co., Ltd.

WCDMA digital mobile phone

Model Name: Philips W8555

Marketing Name: Philips W8555

FCC ID: VQRCTW8555

With

Hardware Version: W8555_V01

Software Version: Philips_W8555_V01

Issued Date: 2013-12-27



Note:

The test results in this test report relate only to the devices specified in this report. This report shall not be reproduced except in full without the written approval of TMC Beijing.

Test Laboratory:

TMC Beijing, Telecommunication Metrology Center of MIIT

No. 52, Huayuan Bei Road, Haidian District, Beijing, P. R. China 100191.

Tel:+86(0)10-62304633-2079, Fax:+86(0)10-62304633 Email:welcome@emcite.com. www.emcite.com

©Copyright. All rights reserved by TMC Beijing.



Revision Version

Report Number	Revision	Date	Memo
2013EEB00584-SAR	00	2013-12-02	Initial creation of test report
2013EEB00584-SAR	01	2013-12-27	/

TABLE OF CONTENT

1 TEST LABORATORY	5
1.1 TESTING LOCATION	5
1.2 TESTING ENVIRONMENT.....	5
1.3 PROJECT DATA	5
1.4 SIGNATURE.....	5
2 STATEMENT OF COMPLIANCE	6
3 CLIENT INFORMATION.....	8
3.1 APPLICANT INFORMATION	8
3.2 MANUFACTURER INFORMATION	8
4 EQUIPMENT UNDER TEST (EUT) AND ANCILLARY EQUIPMENT (AE)	9
4.1 ABOUT EUT	9
4.2 INTERNAL IDENTIFICATION OF EUT USED DURING THE TEST	9
4.3 INTERNAL IDENTIFICATION OF AE USED DURING THE TEST.....	9
5 TEST METHODOLOGY	10
5.1 APPLICABLE LIMIT REGULATIONS	10
5.2 APPLICABLE MEASUREMENT STANDARDS.....	10
6 SAR MEASUREMENTS SYSTEM CONFIGURATION	11
6.1 SAR MEASUREMENT SET-UP	11
6.2 DASY5 E-FIELD PROBE SYSTEM	12
6.3 OTHER TEST EQUIPMENT	13
6.4 SCANNING PROCEDURE.....	15
6.5 DATA STORAGE AND EVALUATION.....	17
7 TISSUE-EQUIVALENT LIQUID	20
7.1 TISSUE-EQUIVALENT LIQUID INGREDIENTS	20
7.2 TISSUE-EQUIVALENT LIQUID PROPERTIES	22
8 SYSTEM CHECK	23
8.1 DESCRIPTION OF SYSTEM CHECK.....	23
8.2 SYSTEM CHECK RESULTS	26
9 OPERATIONAL CONDITIONS DURING TEST	27
9.1 GENERAL DESCRIPTION OF TEST PROCEDURES	27
9.2 TEST POSITIONS	27
9.3 MEASUREMENT VARIABILITY.....	29
9.4 TEST CONFIGURATION.....	30
10 TEST RESULTS.....	36
10.1 CONDUCTED POWER RESULTS	36

10.2 STANDALONE SAR TEST EXCLUSION CONSIDERATIONS	41
10.3 SAR TEST RESULTS	42
10.4 SIMULTANEOUS TRANSMISSION CONDITIONS.....	50
11 MEASUREMENT UNCERTAINTY	53
12 MAIN TEST INSTRUMENTS	55
ANNEX A: TEST LAYOUT.....	56
ANNEX B: SYSTEM CHECK RESULTS	60
ANNEX C: GRAPH RESULTS.....	66
ANNEX D: PROBE CALIBRATION CERTIFICATE.....	141
ANNEX E: D835V2 DIPOLE CALIBRATION CERTIFICATE	152
ANNEX F: D1900V2 DIPOLE CALIBRATION CERTIFICATE.....	160
ANNEX G: D2450V2 DIPOLE CALIBRATION CERTIFICATE	168
ANNEX H: DAE4 CALIBRATION CERTIFICATE.....	176
ANNEX I: THE EUT APPEARANCES AND TEST CONFIGURATION	181

1 Test Laboratory

1.1 Testing Location

Company Name: TA Technology (Shanghai) Co., Ltd
Address: No.145, Jintang Rd, Tangzhen Industry Park, Pudong Shanghai,
P.R.China,
Postal Code: 201201
Telephone: +86-21-50791141/2/3
Fax: +86-21-50791141/2/3 Ext.8000

1.2 Testing Environment

Temperature: 18°C~25 °C,
Relative humidity: 30%~ 70%
Ground system resistance: < 0.5 Ω
Ambient noise & Reflection: < 0.012 W/kg

1.3 Project Data

Project Leader: Zhang Bojun
Test Engineer: Zhu Zhiqiang
Testing Start Date: December 4, 2013
Testing End Date: December 23, 2013

1.4 Signature



Zhu Zhiqiang
(Prepared this test report)

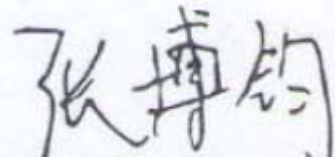

Zhang Bojun
(Reviewed this test report)

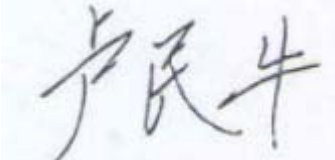

Lu Minniu
Director of the laboratory
(Approved this test report)

2 Statement of Compliance

All the data and Instruments are from TA Technology (Shanghai) Co., Ltd.

The maximum results of Specific Absorption Rate (SAR) found during testing for Shenzhen Sang Fei Consumer Communications Co., Ltd. WCDMA digital mobile phone Philips W8555 are as follows:

Table 1: Max. Reported SAR (1g)

Head SAR Configuration

Mode	Test Position	Channel /Frequency(MHz)	Limit SAR _{1g} 1.6 W/kg	
			Measured SAR _{1g} (W/kg)	Reported SAR _{1g} (W/kg)
GSM 850	Right, cheek	190/836.6	0.170	0.225
GSM 1900	Left, cheek	661/1880	0.258	0.373
UMTS Band II	Left, cheek	9400/1880	0.509	0.680
UMTS Band V	Right, cheek	4183/836.6	0.192	0.263
WiFi(802.11b)	Right, cheek	11/2462	0.196	0.204

Body Worn Configuration

Mode	Test Position	Channel /Frequency(MHz)	Limit SAR _{1g} 1.6 W/kg	
			Measured SAR _{1g} (W/kg)	Reported SAR _{1g} (W/kg)
4Txslots EGPRS 850	Back side	251/848.8	0.940	1.097
4Txslots GPRS 1900	Front side	661/1880	0.686	0.884
UMTS Band II	Front side	9262/1852.4	0.682	0.970
UMTS Band V	Back side	4183/836.6	0.267	0.365
WiFi(802.11b)	Back side	11/2462	0.092	0.096

Hotspot SAR Configuration

Mode	Test Position	Channel /Frequency(MHz)	Limit SAR _{1g} 1.6 W/kg	
			Measured SAR _{1g} (W/kg)	Reported SAR _{1g} (W/kg)
4Txslots EGPRS 850	Back side	251/848.8	0.940	1.097
4Txslots GPRS 1900	Front side	661/1880	0.686	0.884
UMTS Band II	Bottom edge	9538/1907.6	0.702	1.024
UMTS Band V	Back side	4183/836.6	0.267	0.365
WiFi(802.11b)	Back side	11/2462	0.092	0.096

All the tests are carried out with a micro SD card installed in the mobile phone and a fully charged battery.

The SAR values found for the Mobile Phone are below the maximum recommended levels of 1.6 W/Kg as averaged over any 1g tissue according to the ANSI C95.1-1992.

For body worn operation, this device has been tested and meets FCC RF exposure guidelines when used with any accessory that contains no metal and which provides a minimum separation distance of 10 mm between this device and the body of the user. Use of other accessories may not ensure compliance with FCC RF exposure guidelines.

It is determined by user manual for the distance between the EUT and the phantom bottom. The distance is 10mm and just applied to the condition of body worn accessory.

The measurement together with the test system set-up is described in annex C of this test report. A detailed description of the equipment under test can be found in this test report.

The maximum reported SAR value is obtained at the case of **(Table 1)**, and the values are: **1.097W/kg (1g)**.

Table 2: The sum of reported SAR values

	Position	GSM/WCDMA	WiFi	Sum
Maximum reported value for Head	Left hand, Touch cheek	0.680	0.136	0.816
Maximum reported SAR value for Body	Toward Ground	1.097	0.096	1.193

	Position	GSM/WCDMA	BT	Sum
Maximum reported value for Head	Left hand, Touch cheek	0.680	0.33	1.010
Maximum reported SAR value for Body	Toward Ground	1.097	0.16	1.257

According to the above table, the maximum sum of reported SAR values for GSM/WCDMA and WIFI is **1.193W/kg (1g)**, GSM/WCDMA and BT is **1.257W/kg (1g)**. The detail for simultaneous transmission consideration is described in chapter 10.4.

3 Client Information

3.1 Applicant Information

Company Name: Shenzhen Sang Fei Consumer Communications Co., Ltd.
Address /Post: 11 Science and Technology Road, Shenzhen Hi-tech Industrial Park
Nanshan District, Shenzhen, PRC
Country: China
Telephone: 13810011657
Fax 010-68300397

3.2 Manufacturer Information

Company Name: Shenzhen Sang Fei Consumer Communications Co., Ltd.
Address /Post: 11 Science and Technology Road, Shenzhen Hi-tech Industrial Park
Nanshan District, Shenzhen, PRC
Country: China
Telephone: 13810011657
Fax 010-68300397

4 Equipment Under Test (EUT) and Ancillary Equipment (AE)

4.1 About EUT

Description:	WCDMA digital mobile phone
Model name:	Philips W8555
Marketing name:	Philips W8555
Operating mode(s):	GSM 850/ GSM 1900/ WCDMA 850/ WCDMA 1900, BT, Wi-Fi
Tested Tx Frequency:	824.2 – 848.8 MHz (GSM 850)
	1850.2 – 1909.8 MHz (GSM 1900)
	826.4-846.6MHz(WCDMA 850)
	1852.4-1908MHz(WCDMA 1900)
	2412 – 2462 MHz (Wi-Fi)
Test Modulation	(GSM)GMSK; (WCDMA)QPSK
GPRS Multislot Class:	12
GPRS capability Class:	B
EGPRS Multislot Class:	12
Power class:	GSM850: tested with power level 5
	GSM1900: tested with power level 0
	WCDMA: class 3, tested with power control all up bits
Test device Production information:	Production unit
Device type:	Portable device
Antenna type:	Integrated antenna
Accessories/Body-worn configurations:	/
Hotspot mode:	support
Form factor	75mm*150mm

4.2 Internal Identification of EUT used during the test

EUT ID*	SN or IMEI	HW Version	SW Version
EUT1	862813025015192	W8555_V01	Philips_W8555_V01

*EUT ID: is used to identify the test sample in the lab internally.

4.3 Internal Identification of AE used during the test

AE ID*	Description	Model	SN	Capacity	Nominal Voltage	Manufacturer
AE1	Battery	AB3300 BWMC	/	3300mAh	3.8	Harbin Coslight Power Co Ltd

*AE ID: is used to identify the test sample in the lab internally.

5 TEST METHODOLOGY

5.1 Applicable Limit Regulations

ANSI C95.1, 1992: Safety Levels with Respect to Human Exposure to Radio Frequency Electromagnetic Fields, 3 kHz to 300 GHz.(IEEE Std C95.1-1991)

It specifies the maximum exposure limit of **1.6 W/kg** as averaged over any 1 gram of tissue for portable devices being used within 20 cm of the user in the uncontrolled environment.

5.2 Applicable Measurement Standards

IEEE Std 1528™-2003: IEEE Recommended Practice for Determining the Peak Spatial-Average Specific Absorption Rate (SAR) in the Human Head from Wireless Communications Devices: Measurement Techniques.

KDB 447498 D01 Mobile Portable RF Exposure v05r01: Mobile and Portable Device RF Exposure Procedures and Equipment Authorization Policies

KDB 648474 D04 Handset SAR v01r01: SAR Evaluation Considerations for Wireless Handsets.

KDB 865664 D01 SAR measurement 100 MHz to 6 GHz v01r01: SAR Measurement Requirements for 100 MHz to 6 GHz

KDB 865664 D02 RF Exposure Reporting v01r01: RF Exposure Compliance Reporting and Documentation Considerations

6 SAR Measurements System Configuration

6.1 SAR Measurement Set-up

The DASY5 system for performing compliance tests consists of the following items:

- A standard high precision 6-axis robot (Stäubli RX family) with controller and software. An arm extension for accommodating the data acquisition electronics (DAE).
- A dosimetric probe, i.e. an isotropic E-field probe optimized and calibrated for usage in tissue simulating liquid. The probe is equipped with an optical surface detector system.
- A data acquisition electronic (DAE) which performs the signal amplification, signal multiplexing, AD-conversion, offset measurements, mechanical surface detection, collision detection, etc. The unit is battery powered with standard or rechargeable batteries. The signal is optically transmitted to the EOC.
- A unit to operate the optical surface detector which is connected to the EOC.
- The Electro-Optical Coupler (EOC) performs the conversion from the optical into a digital electric signal of the DAE. The EOC is connected to the DASY5 measurement server.
- The DASY5 measurement server, which performs all real-time data evaluation for field measurements and surface detection, controls robot movements and handles safety operation. A computer operating Windows 2003
- DASY5 software and SEMCAD data evaluation software.
- Remote control with teach panel and additional circuitry for robot safety such as warning lamps, etc.
- The generic twin phantom enabling the testing of left-hand and right-hand usage.
- The device holder for handheld mobile phones.
- Tissue simulating liquid mixed according to the given recipes.
- System validation dipoles allowing to validate the proper functioning of the system.

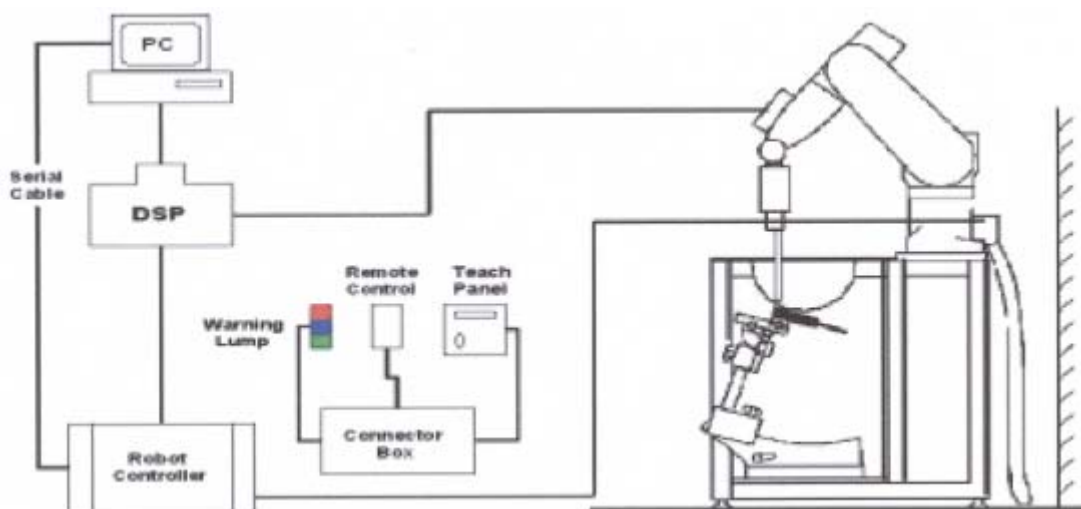

Figure 1 SAR Lab Test Measurement Set-up

6.2DASY5 E-field Probe System

The SAR measurements were conducted with the dosimetric probe EX3DV4 (manufactured by SPEAG), designed in the classical triangular configuration and optimized for dosimetric evaluation.

6.2.1EX3DV4 Probe Specification

Construction	Symmetrical design with triangular core Built-in shielding against static charges PEEK enclosure material (resistant to organic solvents, e.g., DGBE)
Calibration	ISO/IEC 17025 calibration service available
Frequency	10 MHz to > 6 GHz Linearity: ± 0.2 dB (30 MHz to 6 GHz)
Directivity	± 0.3 dB in HSL (rotation around probe axis) ± 0.5 dB in tissue material (rotation normal to probe axis)
Dynamic Range	10 μ W/g to > 100 mW/g Linearity: ± 0.2 dB (noise: typically < 1 μ W/g)
Dimensions	Overall length: 330 mm (Tip: 20 mm) Tip diameter: 2.5 mm (Body: 12 mm) Typical distance from probe tip to dipole centers: 1 mm
Application	High precision dosimetric measurements in any exposure scenario (e.g., very strong gradient fields). Only probe which enables compliance testing for frequencies up to 6 GHz with precision of better 30%.



Figure 2.EX3DV4 E-field Probe



Figure 3. EX3DV4 E-field probe

6.2.1E-field Probe Calibration

Each probe is calibrated according to a dosimetric assessment procedure with accuracy better than $\pm 10\%$. The spherical isotropy was evaluated and found to be better than $\pm 0.25\text{dB}$. The sensitivity parameters (NormX, NormY, NormZ), the diode compression parameter (DCP) and the conversion factor (ConvF) of the probe are tested.

The free space E-field from amplified probe outputs is determined in a test chamber. This is performed in a TEM cell for frequencies below 1 GHz, and in a wave guide above 1 GHz for free space. For the free space calibration, the probe is placed in the volumetric center of the cavity and at the proper orientation with the field. The probe is then rotated 360 degrees.

E-field temperature correlation calibration is performed in a flat phantom filled with the appropriate simulated brain tissue. The measured free space E-field in the medium correlates to temperature rise in a dielectric medium. For temperature correlation calibration a RF transparent thermistor-based temperature probe is used in conjunction with the E-field probe.

$$\text{SAR} = C \frac{\Delta T}{\Delta t}$$

Where: Δt = Exposure time (30 seconds),
 C = Heat capacity of tissue (brain or muscle),
 ΔT = Temperature increase due to RF exposure.
 Or

$$\text{SAR} = \frac{|E|^2 \sigma}{\rho}$$

Where:
 σ = Simulated tissue conductivity,
 ρ = Tissue density (kg/m³).

6.3Other Test Equipment

6.3.1Device Holder for Transmitters

The DASY device holder is designed to cope with the different positions given in the standard.

It has two scales for device rotation (with respect to the body axis) and device inclination (with respect to the line between the ear reference points). The rotation centers for both scales is the ear reference point (ERP). Thus the device needs no repositioning when changing the angles. The amount of dielectric material has been reduced in the closest vicinity of the device, since measurements have suggested that the inference of the clamp on the test results could thus be lowered.



Figure 4 Device Holder

6.3.2 Phantom

The Generic Twin Phantom is constructed of a fiberglass shell integrated in a wooden Figure. The shape of the shell is based on data from an anatomical study designed to determine the maximum exposure in at least 90% of all users. It enables the dosimetric evaluation of left and right hand phone usage as well as body mounted usage at the flat phantom region. A cover prevents the evaporation of the liquid. Reference markings on the Phantom allow the complete setup of all predefined phantom positions and measurement grids by manually teaching three points in the robot.

Shell Thickness	2±0.1 mm
Filling Volume	Approx. 20 liters
Dimensions	810 x 1000 x 500 mm (H x L x W) Available Special



Figure 5 Generic Twin Phantom

6.4 Scanning Procedure

The DASY5 installation includes predefined files with recommended procedures for measurements and validation. They are read-only document files and destined as fully defined but unmeasured masks. All test positions (head or body-worn) are tested with the same configuration of test steps differing only in the grid definition for the different test positions.

- The “reference” and “drift” measurements are located at the beginning and end of the batch process. They measure the field drift at one single point in the liquid over the complete procedure. The indicated drift is mainly the variation of the DUT’s output power and should vary max. $\pm 5\%$.
- The “surface check” measurement tests the optical surface detection system of the DASY5 system by repeatedly detecting the surface with the optical and mechanical surface detector and comparing the results. The output gives the detecting heights of both systems, the difference between the two systems and the standard deviation of the detection repeatability. Air bubbles or refraction in the liquid due to separation of the sugar-water mixture gives poor repeatability (above $\pm 0.1\text{mm}$). To prevent wrong results tests are only executed when the liquid is free of air bubbles. The difference between the optical surface detection and the actual surface depends on the probe and is specified with each probe. (It does not depend on the surface reflectivity or the probe angle to the surface within $\pm 30^\circ$.)
- Area Scan
The Area Scan is used as a fast scan in two dimensions to find the area of high field values before running a detailed measurement around the hot spot. Before starting the area scan a grid spacing is set according to FCC KDB Publication 865664. During scan the distance of the probe to the phantom remains unchanged.
After finishing area scan, the field maxima within a range of 2 dB will be ascertained.
- Zoom Scan
After the maximum interpolated values were calculated between the points in the cube, the SAR was averaged over the spatial volume (1g or 10g) using a 3D-Spline interpolation algorithm. The 3D-spline is composed of three one-dimensional splines with the “Not a knot” condition (in x, y, and z directions). The volume was then integrated with the trapezoidal algorithm.
- Spatial Peak Detection
The procedure for spatial peak SAR evaluation has been implemented and can determine values of masses of 1g and 10g, as well as for user-specific masses. The DASY5 system allows evaluations that combine measured data and robot positions, such as:
 - maximum search
 - extrapolation
 - boundary correction
 - peak search for averaged SAR

During a maximum search, global and local maxima searches are automatically performed in 2-D after each Area Scan measurement with at least 6 measurement points. It is based on the evaluation of the local SAR gradient calculated by the Quadratic Shepard's method. The algorithm will find the global maximum and all local maxima within -2 dB of the global maxima for all SAR distributions.

Extrapolation routines are used to obtain SAR values between the lowest measurement points and the inner phantom surface. The extrapolation distance is determined by the surface detection distance and the probe sensor offset. Several measurements at different distances are necessary for the extrapolation. Extrapolation routines require at least 10 measurement points in 3-D space. They are used in the Zoom Scan to obtain SAR values between the lowest measurement points and the inner phantom surface. The routine uses the modified Quadratic Shepard's method for extrapolation.

- A Z-axis scan measures the total SAR value at the x-and y-position of the maximum SAR value found during the cube scan. The probe is moved away in z-direction from the bottom of the SAM phantom in 5mm steps.

Table 3: Area and Zoom Scan Resolutions per FCC KDB Publication 865664 D01

Frequency	Maximum Area Scan Resolution (mm) ($\Delta x_{area}, \Delta y_{area}$)	Maximum Zoom Scan Resolution (mm) ($\Delta x_{zoom}, \Delta y_{zoom}$)	Maximum Zoom Scan Spatial Resolution (mm) $\Delta z_{zoom}(n)$	Minimum Zoom Scan Volume (mm) (x,y,z)
≤ 2 GHz	≤ 15	≤ 8	≤ 5	≥ 30
2-3 GHz	≤ 12	≤ 5	≤ 5	≥ 30
3-4 GHz	≤ 12	≤ 5	≤ 4	≥ 28
4-5 GHz	≤ 10	≤ 4	≤ 3	≥ 25
5-6 GHz	≤ 10	≤ 4	≤ 2	≥ 22

6.5 Data Storage and Evaluation

6.5.1 Data Storage

The DASY5 software stores the acquired data from the data acquisition electronics as raw data (in microvolt readings from the probe sensors), together with all necessary software parameters for the data evaluation (probe calibration data, liquid parameters and device frequency and modulation data) in measurement files with the extension “.DAE4”. The software evaluates the desired unit and format for output each time the data is visualized or exported. This allows verification of the complete software setup even after the measurement and allows correction of incorrect parameter settings. For example, if a measurement has been performed with a wrong crest factor parameter in the device setup, the parameter can be corrected afterwards and the data can be re-evaluated.

The measured data can be visualized or exported in different units or formats, depending on the selected probe type ([V/m], [A/m], [°C], [mW/g], [mW/cm²], [dBrel], etc.). Some of these units are not available in certain situations or show meaningless results, e.g., a SAR output in a lossless media will always be zero. Raw data can also be exported to perform the evaluation with other software packages.

6.5.2 Data Evaluation by SEMCAD

The SEMCAD software automatically executes the following procedures to calculate the field units from the microvolt readings at the probe connector. The parameters used in the evaluation are stored in the configuration modules of the software:

Probe parameters:	- Sensitivity	Norm _i , a _{i0} , a _{i1} , a _{i2}
	- Conversion factor	ConvF _i
	- Diode compression point	Dcp _i
Device parameters:	- Frequency	f
	- Crest factor	cf
Media parameters:	- Conductivity	
	- Density	

These parameters must be set correctly in the software. They can be found in the component documents or they can be imported into the software from the configuration files issued for the DASY5 components. In the direct measuring mode of the multimeter option, the parameters of the actual system setup are used. In the scan visualization and export modes, the parameters stored in the corresponding document files are used.

The first step of the evaluation is a linearization of the filtered input signal to account for the compression characteristics of the detector diode. The compensation depends on the input signal,

the diode type and the DC-transmission factor from the diode to the evaluation electronics.
If the exciting field is pulsed, the crest factor of the signal must be known to correctly compensate for peak power. The formula for each channel can be given as:

$$V_i = U_i + U_i^2 \cdot c f / d c p_i$$

With V_i = compensated signal of channel i (i = x, y, z)

U_i = input signal of channel i (i = x, y, z)

cf = crest factor of exciting field (DASY parameter)

dcp_i = diode compression point (DASY parameter)

From the compensated input signals the primary field data for each channel can be evaluated:

E-field probes: $E_i = (V_i / Norm_i \cdot ConvF)^{1/2}$

H-field probes: $H_i = (V_i)^{1/2} \cdot (a_{i0} + a_{i1} f + a_{i2} f^2) / f$

With V_i = compensated signal of channel i (i = x, y, z)

$Norm_i$ = sensor sensitivity of channel i (i = x, y, z)
[mV/(V/m)²] for E-field Probes

$ConvF$ = sensitivity enhancement in solution

a_{ij} = sensor sensitivity factors for H-field probes

f = carrier frequency [GHz]

E_i = electric field strength of channel i in V/m

H_i = magnetic field strength of channel i in A/m

The RSS value of the field components gives the total field strength (Hermitian magnitude):

$$E_{tot} = (E_x^2 + E_y^2 + E_z^2)^{1/2}$$

The primary field data are used to calculate the derived field units.

$$SAR = (E_{tot})^2 \cdot \sigma / (\rho \cdot 1000)$$

with **SAR** = local specific absorption rate in mW/g

E_{tot} = total field strength in V/m

σ = conductivity in [mho/m] or [Siemens/m]

ρ = equivalent tissue density in g/cm³

Note that the density is normally set to 1 (or 1.06), to account for actual brain density rather than the density of the simulation liquid. The power flow density is calculated assuming the excitation field to be a free space field.

$$P_{pwe} = E_{tot}^2 / 3770 \quad \text{or} \quad P_{pwe} = H_{tot}^2 \cdot 37.7$$

with P_{pwe} = equivalent power density of a plane wave in mW/cm²

E_{tot} = total electric field strength in V/m

H_{tot} = total magnetic field strength in A/m

7 Tissue-equivalent Liquid

7.1 Tissue-equivalent Liquid Ingredients

The liquid is consisted of water, salt, Glycol, Sugar, Preventol and Cellulose. The liquid has previously been proven to be suited for worst-case. The table 4 and table 5 show the detail solution. It's satisfying the latest tissue dielectric parameters requirements proposed by the KDB 865664 D01.

Table 4: Composition of the Head Tissue Equivalent Matter

MIXTURE%	FREQUENCY(Brain) 835MHz
Water	41.45
Sugar	56
Salt	1.45
Preventol	0.1
Cellulose	1.0
Dielectric Parameters Target Value	f=835MHz $\epsilon=41.5$ $\sigma=0.9$

MIXTURE%	FREQUENCY(Brain) 1900MHz
Water	55.242
Glycol monobutyl	44.452
Salt	0.306
Dielectric Parameters Target Value	f=1900MHz $\epsilon=40.0$ $\sigma=1.40$

MIXTURE%	FREQUENCY(Brain) 2450MHz
Water	62.7
Glycol	36.8
Salt	0.5
Dielectric Parameters Target Value	f=2450MHz $\epsilon=39.20$ $\sigma=1.80$

Table 5: Composition of the Body Tissue Equivalent Matter

MIXTURE%	FREQUENCY(Body) 835MHz
Water	52.5
Sugar	45
Salt	1.4
Preventol	0.1
Cellulose	1.0
Dielectric Parameters Target Value	f=835MHz $\epsilon=55.2$ $\sigma=0.97$

MIXTURE%	FREQUENCY (Body) 1900MHz
Water	69.91
Glycol monobutyl	29.96
Salt	0.13
Dielectric Parameters Target Value	f=1900MHz $\epsilon=53.3$ $\sigma=1.52$

MIXTURE%	FREQUENCY(Body) 2450MHz
Water	73.2
Glycol	26.7
Salt	0.1
Dielectric Parameters Target Value	f=2450MHz $\epsilon=52.70$ $\sigma=1.95$

7.2 Tissue-equivalent Liquid Properties

Table 6: Dielectric Performance of Tissue Simulating Liquid

Frequency	Test Date	Temp °C	Measured Dielectric Parameters		Target Dielectric Parameters		Limit (Within ±5%)	
			ϵ_r	σ (s/m)	ϵ_r	σ (s/m)	Dev ϵ_r (%)	Dev σ (%)
835MHz (head)	2013-12-4	21.5	41.8	0.90	41.50	0.90	0.72	0.00
1900MHz (head)	2013-12-10	21.5	39.6	1.34	40.00	1.40	-1.00	-4.29
2450MHz (head)	2013-12-9	21.5	38.8	1.79	39.20	1.80	-1.02	-0.56
835MHz (body)	2013-12-19	21.5	54.5	0.97	55.20	0.97	-1.27	0.00
1900MHz (body)	2013-12-23	21.5	52.9	1.53	53.30	1.52	-0.75	0.66
2450MHz (body)	2013-12-9	21.5	52.0	1.97	52.70	1.95	-1.33	1.03

8 System Check

8.1 Description of System Check

The manufacturer calibrates the probes annually. Dielectric parameters of the tissue simulates were measured every day using the dielectric probe kit and the network analyzer. A system check measurement was made following the determination of the dielectric parameters of the simulates, using the dipole validation kit. A power level of 250 mW was supplied to the dipole antenna, which was placed under the flat section of the twin SAM phantom. The system check results (dielectric parameters and SAR values) are given in the table 7 and table 8.

System check results have to be equal or near the values determined during dipole calibration with the relevant liquids and test system ($\pm 10\%$).

System check is performed regularly on all frequency bands where tests are performed with the DASY5 system.

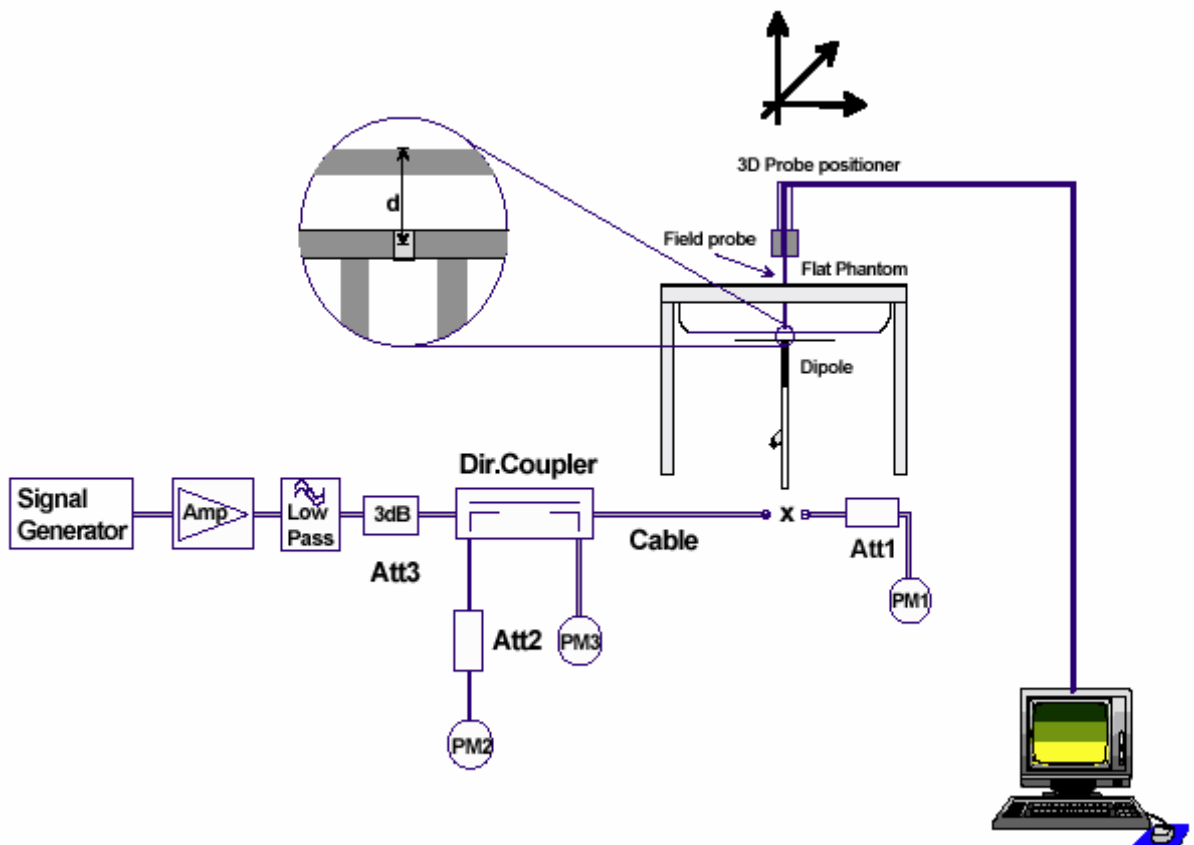

Figure 6 System Check Set-up

Justification for Extended SAR Dipole Calibrations

Usage of SAR dipoles calibrated less than 3 years ago but more than 1 year ago were confirmed in maintaining return loss (< - 20 dB, within 20% of prior calibration) and impedance (within 5 ohm from prior calibration) requirements per extended calibrations in KDB 865664 D01:

Dipole D835V2 SN: 4d020				
Head Liquid				
Date of Measurement	Return Loss(dB)	Δ %	Impedance (Ω)	$\Delta\Omega$
8/26/2011	-27.7	/	52.9	/
8/25/2012	-29.1	5.0%	55.0	2.1 Ω
8/24/2013	-26.6	4.1%	55.3	2.4 Ω
Body Liquid				
Date of Measurement	Return Loss(dB)	Δ %	Impedance (Ω)	$\Delta\Omega$
8/26/2011	-25.1	/	48.7	/
8/25/2012	-24.3	3.2 %	50.6	1.9 Ω
8/24/2013	-24.7	1.6%	51.1	2.4 Ω

Dipole D1900V2 SN: 5d060				
Head Liquid				
Date of Measurement	Return Loss(dB)	Δ %	Impedance (Ω)	$\Delta\Omega$
8/31/2011	-22.3	/	52.6	/
8/30/2012	-21.7	2.7%	51.4	1.2 Ω
8/29/2013	-21.4	4.2%	50.5	2.1 Ω
Body Liquid				
Date of Measurement	Return Loss(dB)	Δ %	Impedance (Ω)	$\Delta\Omega$
8/31/2011	-21.3	/	47.3	/
8/30/2012	-20.9	1.9%	45.9	1.4 Ω
8/29/2013	-20.4	4.4%	44.8	2.5 Ω

Dipole D2450V2 SN: 786				
Head Liquid				
Date of Measurement	Return Loss(dB)	Δ %	Impedance (Ω)	$\Delta\Omega$
8/29/2011	-25.5	/	55.0	/
8/28/2012	-26.8	5.1%	56.5	1.5 Ω
8/27/2013	-26.4	3.5%	56.9	1.9 Ω
Body Liquid				
Date of Measurement	Return Loss(dB)	Δ %	Impedance (Ω)	$\Delta\Omega$
8/29/2011	-29.0	/	50.4	/
8/28/2012	-29.9	3.1%	52.1	1.7 Ω
8/27/2013	-28.2	2.8%	52.7	2.3 Ω

8.2 System Check Results

Table 7: System Check in Head Tissue Simulating Liquid

Frequency	Test Date	Dielectric Parameters		Temp	250mW Measured SAR _{1g}	1W Normalized SAR _{1g}	1W Target SAR _{1g}	Limit (±10% Deviation)
		ϵ_r	σ (s/m)	(°C)	(W/kg)			
835MHz	2013-12-4	41.8	0.90	21.5	2.44	9.76	9.34	4.50
1900MHz	2013-12-10	39.6	1.34	21.5	9.48	37.92	40.30	-5.90
2450MHz	2013-12-9	38.8	1.79	21.5	13.7	54.8	53.80	1.86

Note: 1. The graph results see ANNEX B.
2. Target Values used derive from the calibration certificate

Table 8: System Check in Body Tissue Simulating Liquid

Frequency	Test Date	Dielectric Parameters		Temp	250mW Measured SAR _{1g}	1W Normalized SAR _{1g}	1W Target SAR _{1g}	Limit (±10% Deviation)
		ϵ_r	σ (s/m)	(°C)	(W/kg)			
835MHz	2013-12-19	54.5	0.97	21.5	2.41	9.64	9.46	1.90
1900MHz	2013-12-23	52.9	1.53	21.5	9.93	39.72	41.70	-4.75
2450MHz	2013-12-9	52.0	1.97	21.5	12.5	50	51.70	-3.29

Note: 1. The graph results see ANNEX B.
2. Target Values used derive from the calibration certificate

9 Operational Conditions during Test

9.1 General Description of Test Procedures

A communication link is set up with a System Simulator (SS) by air link, and a call is established. The EUT is commanded to operate at maximum transmitting power.

Connection to the EUT is established via air interface with E5515C, and the EUT is set to maximum output power by E5515C. The EUT battery must be fully charged and checked periodically during the test to ascertain uniform power output. The antenna connected to the output of the base station simulator shall be placed at least 50 cm away from the EUT. The signal transmitted by the simulator to the antenna feeding point shall be lower than the output power level of the EUT by at least 30 dB.

9.2 Test Positions

9.2.1 Against Phantom Head

Measurements were made in “cheek” and “tilt” positions on both the left hand and right hand sides of the phantom.

The positions used in the measurements were according to IEEE 1528 - 2003 "IEEE Recommended Practice for Determining the Peak Spatial-Average Specific Absorption Rate(SAR) in the Human Head from Wireless Communications Devices: Measurement Techniques".

9.2.2 Body Worn Configuration

Body-worn operating configurations should be tested with the belt-clips and holsters attached to the device and positioned against a flat phantom in normal use configurations. Devices with a headset output should be tested with a headset connected to the device, and the distance between the device and the phantom was kept 10mm for body worn.

Based upon KDB941225 D06 with a form factor > 9 cm x 5 cm, when the antenna-to-edge distance is greater than 2.5cm, such position does not need to be tested. The distance between the device and the phantom was kept 10mm of wireless routers.

Body-worn operating configurations are tested with the belt-clips and holsters attached to the device and positioned against a flat phantom in a normal use configuration. Per FCC KDB Publication 648474 D04, Body-worn accessory exposure is typically related to voice mode operations when handsets are carried in body-worn accessories. The body-worn accessory procedures in FCC KDB Publication 447498 D01 should be used to test for body-worn accessory SAR compliance, without a headset connected to it. This enables the test results for such configuration to be compatible with that required for hotspot mode when the body-worn accessory test separation distance is greater than or equal to that required for hotspot mode, when applicable. When the reported SAR for a body-worn accessory, measured without a headset connected to the handset, is > 1.2 W/kg, the highest reported SAR configuration for that wireless mode and frequency band should be repeated

for that body-worn accessory with a headset attached to the handset.

Accessories for Body-worn operation configurations are divided into two categories: those that do not contain metallic components and those that do contain metallic components. When multiple accessories that do not contain metallic components are supplied with the device, the device is tested with only the accessory that dictates the closest spacing to the body. Then multiple accessories that contain metallic components are tested with the device with each accessory. If multiple accessories share an identical metallic component (i.e. the same metallic belt-clip used with different holsters with no other metallic components) only the accessory that dictates the closest spacing to the body is tested.

Body-worn accessories may not always be supplied or available as options for some devices intended to be authorized for body-worn use. In this case, a test configuration with a separation distance between the back of the device and the flat phantom is used. Test position spacing was documented. Transmitters that are designed to operate in front of a person's face, as in push-to-talk configurations, are tested for SAR compliance with the front of the device positioned to face the flat phantom in head fluid. For devices that are carried next to the body such as a shoulder, waist or chest-worn transmitters, SAR compliance is tested with the accessories, including headsets and microphones, attached to the device and positioned against a flat phantom in a normal use configuration.

9.3 Measurement Variability

Per FCC KDB Publication 865664 D01, SAR measurement variability was assessed for each frequency band, which was determined by the SAR probe calibration point and tissue-equivalent medium used for the device measurements. When both head and body tissue-equivalent media were required for SAR measurements in a frequency band, the variability measurement procedures were applied to the tissue medium with the highest measured SAR, using the highest measured SAR configuration for that tissue-equivalent medium. These additional measurements were repeated after the completion of all measurements requiring the same head or body tissue-equivalent medium in a frequency band. The test device was returned to ambient conditions (normal room temperature) with the battery fully charged before it was re-mounted on the device holder for the repeated measurement(s) to minimize any unexpected variations in the repeated results.

SAR Measurement Variability was assessed using the following procedures for each frequency band:

- 1) When the original highest measured SAR is ≥ 0.80 W/kg, the measurement was repeated once.
- 2) A second repeated measurement was performed only if the ratio of largest to smallest SAR for the original and first repeated measurements was > 1.20 or when the original or repeated measurement was ≥ 1.45 W/kg (~ 10% from the 1-g SAR limit).
- 3) A third repeated measurement was performed only if the original, first or second repeated measurement was ≥ 1.5 W/kg and the ratio of largest to smallest SAR for the original, first and second repeated measurements is > 1.20 .
- 4) Repeated measurements are not required when the original highest measured SAR is < 0.80 W/kg

The same procedures should be adapted for measurements according to extremity and occupational exposure limits by applying a factor of 2.5 for extremity exposure and a factor of 5 for occupational exposure to the corresponding SAR thresholds.

9.4 Test Configuration

9.4.1 GSM Test Configuration

SAR tests for GSM 850 and GSM 1900, a communication link is set up with a System Simulator (SS) by air link. Using E5515C the power level is set to “5” for GSM 850, set to “0” for GSM 1900. Since the GPRS class is 12 for this EUT, it has at most 4 timeslots in uplink and at most 4 timeslots in downlink, the maximum total timeslots is 5, the EGPRS class is 12 for this EUT, it has at most 4 timeslots in uplink and at most 4 timeslots in downlink, the maximum total timeslots is 5.

According to specification 3GPP TS 51.010, the maximum power of the GSM can do the power reduction for the multi-slot. The allowed power reduction in the multi-slot configuration is as following:

Output power of reductions:

Table 9: The allowed power reduction in the multi-slot configuration

Number of timeslots in uplink assignment	Permissible nominal reduction of maximum output power,(dB)
1	0
2	0 to 3,0
3	1,8 to 4,8
4	3,0 to 6,0

9.4.2 UMTS Test Configuration

9.4.2.1 Output power Verification

Maximum output power is verified on the High, Middle and Low channel according to the procedures described in section 5.2 of 3GPP TS 34. 121, using the appropriate RMC or AMR with TPC(transmit power control) set to all up bits for WCDMA/HSDPA or applying the required inner loop power control procedures to the maximum output power while HSUPA is active. Results for all applicable physical channel configuration (DPCCH, DPDCH_n and spreading codes, HSDPA, HSPA) should be tabulated in the SAR report. All configuration that are not supported by the DUT or can not be measured due to technical or equipment limitations should be clearly identified

9.4.2.2 Head SAR Measurements

SAR for head exposure configurations in voice mode is measured using a 12.2kbps RMC with TPC bits configured to all up bits. SAR in AMR configurations is not required when the maximum average output of each RF channel for 12.2kbps AMR is less than 1/4 dB higher than that measured in 12.2 kbps RMC. Otherwise, SAR is measured on the maximum output channel in 12.2kbps AMR with a 3.4 kbps SRB(Signaling radio bearer) using the exposure configuration that results in the highest SAR in 12.2kbps RMC for that RF channel.

9.4.2.3 Body SAR Measurements

SAR for body exposure configurations in voice and data modes is measured using 12.2kbps RMC with TPC bits configured to all up bits. SAR for other spreading codes and multiple DPDCH_n, when supported by the DUT, are not required when the maximum average output of each RF channel, for each spreading code and DPDCH_n configuration, are less than 1/4 dB higher than those measured in 12.2kbps RMC. Otherwise, SAR is measured on the maximum output channel with an applicable RMC configuration for the corresponding spreading code or DPDCH_n using the exposure configuration that results in the highest SAR with 12.2 kbps RMC. When more than 2 DPDCH_n are supported by the DUT, it may be necessary to configure additional DPDCH_n for a DUT using FTM (Factory Test Mode) or other chipset based test approaches with parameters similar to those used in 384 kbps and 768 kbps RMC.

9.4.3 HSDPA Test Configuration

SAR for body exposure configurations is measured according to the ‘Body SAR Measurements’ procedures of that section. In addition, body SAR is also measured for HSDPA when the maximum average output of each RF channel with HSDPA active is at least ¼ dB higher than that measured without HSDPA using 12.2 kbps RMC or the maximum SAR for 12.2 kbps RMC is above 75% of the SAR limit. Body SAR for HSDPA is measured using an FRC with H-Set 1 in Sub-test 1 and a 12.2 kbps RMC configured in Test Loop Mode 1, using the highest body SAR configuration in 12.2 kbps RMC without HSDPA.

HSDPA should be configured according to the UE category of a test device. The number of HSDSCH/

HS-PDSCHs, HARQ processes, minimum inter-TTI interval, transport block sizes and RV coding sequence are defined by the H-set. To maintain a consistent test configuration and stable transmission conditions, QPSK is used in the H-set for SAR testing. HS-DPCCH should be configured with a CQI feedback cycle of 4 ms with a CQI repetition factor of 2 to maintain a constant rate of active CQI slots. DPCCH and DPDCH gain factors (β_c , β_d), and HS-DPCCH power offset parameters (Δ_{ACK} , Δ_{NACK} , Δ_{CQI}) should be set according to values indicated in the Table below. The CQI value is determined by the UE category, transport block size, number of HS-PDSCHs and modulation used in the H-set.

Table 10: Subtests for UMTS Release 5 HSDPA

Sub-set	β_c	β_d	β_d (SF)	β_c/β_d	β_{hs} (note 1, note 2)	CM(dB) (note 3)	MPR(dB)
1	2/15	15/15	64	2/15	4/15	0.0	0.0
2	12/15 (note 4)	15/15 (note 4)	64	12/15 (note 4)	24/15	1.0	0.0
3	15/15	8/15	64	15/8	30/15	1.5	0.5
4	15/15	4/15	64	15/4	30/15	1.5	0.5

Note1: Δ_{ACK} , Δ_{NACK} and $\Delta_{CQI} = 8 \Leftrightarrow A_{hs} = \beta_{hs}/\beta_c = 30/15 \Leftrightarrow \beta_{hs} = 30/15 * \beta_c$
 Note2: For the HS-DPCCH power mask requirement test in clause 5.2C, 5.7A, and the Error Vector Magnitude (EVM) with HS-DPCCH test in clause 5.13.1.A, and HSDPA EVM with phase discontinuity in clause 5.13.1AA, Δ_{ACK} and $\Delta_{NACK} = 8$ ($A_{hs} = 30/15$) with $\beta_{hs} = 30/15 * \beta_c$, and $\Delta_{CQI} =$

7 ($A_{hs}=24/15$) with $\beta_{hs}=24/15*\beta_c$.

Note3: CM=1 for $\beta_c/\beta_d = 12/15$, $\beta_{hs}/\beta_c=24/15$. For all other combinations of DPDCH, DPCCH and HS-DPCCH the MPR is based on the relative CM difference. This is applicable for only UEs that support HSDPA in release 6 and later releases.

Note 4: For subtest 2 the β_c/β_d ratio of 12/15 for the TFC during the measurement period(TF1,TF0) is achieved by setting the signaled gain factors for the reference TFC (TFC1,TF1) to $\beta_c=11/15$ and $\beta_d=15/15$.

Table 11: Settings of required H-Set 1 QPSK in HSDPA mode

Parameter	Unit	Value
Nominal Avg. Inf. Bit Rate	kbps	534
Inter-TTI Distance	TTI's	3
Number of HARQ Processes	Processes	2
Information Bit Payload (N_{INF})	Bits	3202
Number Code Blocks	Blocks	1
Binary Channel Bits Per TTI	Bits	4800
Total Available SML's in UE	SML's	19200
Number of SML's per HARQ Proc.	SML's	9600
Coding Rate	/	0.67
Number of Physical Channel Codes	Codes	5
Modulation	/	QPSK

Table 12: HSDPA UE category

HS-DSCH Category	Maximum HS-DSCH Codes Received	Minimum Inter-TTI Interval	Maximum Transport Bits/HS-DSCH	Total Channel
1	5	3	7298	19200
2	5	3	7298	28800
3	5	2	7298	28800
4	5	2	7298	38400
5	5	1	7298	57600
6	5	1	7298	67200
7	10	1	14411	115200
8	10	1	14411	134400
9	15	1	25251	172800
10	15	1	27952	172800
11	5	2	3630	14400
12	5	1	3630	28800
13	15	1	34800	259200
14	15	1	42196	259200
15	15	1	23370	345600
16	15	1	27952	345600

9.4.4HSUPA Test Configuration

Body SAR is also measured for HSPA when the maximum average output of each RF channel with HSPA active is at least ¼ dB higher than that measured without HSPA using 12.2 kbps RMC or the maximum SAR for 12.2 kbps RMC is above 75% of the SAR limit. Body SAR for HSPA is measured with E-DCH Sub-test 5, using H-Set 1 and QPSK for FRC and a 12.2 kbps RMC configured in Test Loop Mode 1 with power control algorithm 2, according to the highest body SAR configuration in 12.2 kbps RMC without HSPA.⁴⁰

Due to inner loop power control requirements in HSPA, a commercial communication test set should be used for the output power and SAR tests. The 12.2 kbps RMC, FRC H-set 1 and E- DCH configurations for HSPA should be configured according to the β values indicated below as well as other applicable procedures described in the 'WCDMA Handset' and 'Release 5 HSDPA Data Devices' sections of 3 G device.

Table 13: Sub-Test 5 Setup for Release 6 HSUPA

Sub-set	β_c	β_d	β_d (SF)	β_c/β_d	$\beta_{hs}^{(1)}$	β_{ec}	β_{ed}	β_{ed} (SF)	β_{ed} (codes)	CM ⁽²⁾ (dB)	MPR (dB)	AG ⁽⁴⁾ Index	E-TFCI
1	11/15 ⁽³⁾	15/15 ⁽³⁾	64	11/15 ⁽³⁾	22/15	209/225	1039/225	4	1	1.0	0.0	20	75
2	6/15	15/15	64	6/15	12/15	12/15	94/75	4	1	3.0	2.0	12	67
3	15/15	9/15	64	15/9	30/15	30/15	β_{ed1} 47/15 β_{ed2} 47/15	4	2	2.0	1.0	15	92
4	2/15	15/15	64	2/15	4/15	2/15	56/75	4	1	3.0	2.0	17	71
5	15/15 ⁽⁴⁾	15/15 ⁽⁴⁾	64	15/15 ⁽⁴⁾	30/15	24/15	134/15	4	1	1.0	0.0	21	81

Note 1: Δ_{ACK} , Δ_{NACK} and $\Delta_{CQI} = 8 \Leftrightarrow A_{hs} = \beta_{hs}/\beta_c = 30/15 \Leftrightarrow \beta_{hs} = 30/15 * \beta_c$.

Note 2: CM = 1 for $\beta_c/\beta_d = 12/15$, $\beta_{hs}/\beta_c = 24/15$. For all other combinations of DPDCH, DPCCH, HS- DPCCH, E-DPDCH and E-

DPCCH the MPR is based on the relative CM difference.

Note 3: For subtest 1 the β_c/β_d ratio of 11/15 for the TFC during the measurement period (TF1, TF0) is achieved by setting the

signaled gain factors for the reference TFC (TF1, TF1) to $\beta_c = 10/15$ and $\beta_d = 15/15$.

Note 4: For subtest 5 the β_c/β_d ratio of 15/15 for the TFC during the measurement period (TF1, TF0) is achieved by setting the

signaled gain factors for the reference TFC (TF1, TF1) to $\beta_c = 14/15$ and $\beta_d = 15/15$.

Note 5: Testing UE using E-DPDCH Physical Layer category 1 Sub-test 3 is not required according to TS 25.306 Figure 5.1g.

Note 6: β_{ed} can not be set directly; it is set by Absolute Grant Value.

Table 14: HSUPA UE category

UE E-DCH Category	Maximum E-DCH Codes Transmitted	Number of HARQ Processes	E-DCH TTI (ms)	Minimum Spreading Factor	Maximum E-DCH Transport Block Bits	Max Rate (Mbps)
1	1	4	10	4	7110	0.7296
2	2	8	2	4	2798	1.4592
	2	4	10	4	14484	
3	2	4	10	4	14484	1.4592
4	2	8	2	2	5772	2.9185
	2	4	10	2	20000	2.00
5	2	4	10	2	20000	2.00
6 (No DPDCH)	4	8	2	2 SF2 & 2 SF4	11484	5.76
	4	4	10		20000	2.00
7 (No DPDCH)	4	8	2	2 SF2 & 2 SF4	22996	?
	4	4	10		20000	?

NOTE: When 4 codes are transmitted in parallel, two codes shall be transmitted with SF2 and two with SF4.
UE Categories 1 to 6 supports QPSK only. UE Category 7 supports QPSK and 16QAM. (TS25.306-7.3.0)

9.4.5WIFI Test Configuration

For WLAN SAR testing, WLAN engineering testing software installed on the DUT can provide continuous transmitting RF signal. The TX power is set to 19 for 802.11 b/g/n mode. This RF signal utilized in SAR measurement has almost 100% duty cycle and its crest factor is 1.

For the 802.11b/g/n SAR tests, a communication link is set up with the test mode software for WIFI mode test. During the test, at the each test frequency channel, the EUT is operated at the RF continuous emission mode. Each channel should be tested at the lowest data rate. Testing at higher data rates is not required when the maximum average output power is less than 0.25dB higher than those measured at the lowest data rate.

802.11b/g/n operating modes are tested independently according to the service requirements in each frequency band. 802.11b/g/n modes are tested on the maximum average output channel;

SAR is not required for 802.11g/n channels when the maximum average output power is less than 0.25dB higher than that measured on the corresponding 802.11b channels.

10 Test Results

10.1 Conducted Power Results

Table 15: Conducted Power Measurement Results

GSM 850		Burst Conducted Power(dBm)				Average power(dBm)		
		Channel 128	Channel 190	Channel 251		Channel 128	Channel 190	Channel 251
GSM		32.73	32.79	32.82	-9.03dB	23.7	23.76	23.79
GPRS (GMSK)	1Txslot	32.72	32.77	32.8	-9.03dB	23.69	23.74	23.77
	2Txslots	31.8	31.85	31.88	-6.02dB	25.78	25.83	25.86
	3Txslots	30.03	30.09	30.13	-4.26dB	25.77	25.83	25.87
	4Txslots	29.25	29.32	29.35	-3.01dB	26.24	26.31	26.34
EGPRS (GMSK)	1Txslot	32.72	32.77	32.8	-9.03dB	23.69	23.74	23.77
	2Txslots	31.8	31.85	31.89	-6.02dB	25.78	25.83	25.87
	3Txslots	30.03	30.09	30.13	-4.26dB	25.77	25.83	25.87
	4Txslots	29.25	29.33	29.34	-3.01dB	26.24	26.32	26.33
EGPRS (8PSK)	1Txslot	26.84	26.9	26.92	-9.03dB	17.81	17.87	17.89
	2Txslots	25.59	25.66	25.77	-6.02dB	19.57	19.64	19.75
	3Txslots	23.43	23.49	23.56	-4.26dB	19.17	19.23	19.3
	4Txslots	22.29	22.31	22.44	-3.01dB	19.28	19.3	19.43
GSM 1900		Burst Conducted Power(dBm)				Average power(dBm)		
		Channel 512	Channel 661	Channel 810		Channel 512	Channel 661	Channel 810
GSM		29.86	29.90	29.83	-9.03dB	20.83	20.87	20.8
GPRS (GMSK)	1Txslot	29.83	29.87	29.79	-9.03dB	20.8	20.84	20.76
	2Txslots	28.86	28.91	28.83	-6.02dB	22.84	22.89	22.81
	3Txslots	27.13	27.15	27.08	-4.26dB	22.87	22.89	22.82
	4Txslots	26.37	26.4	26.29	-3.01dB	23.36	23.39	23.28
EGPRS (GMSK)	1Txslot	29.84	29.87	29.79	-9.03dB	20.81	20.84	20.76
	2Txslots	28.86	28.91	28.84	-6.02dB	22.84	22.89	22.82
	3Txslots	27.14	27.15	27.09	-4.26dB	22.88	22.89	22.83
	4Txslots	26.37	26.4	26.29	-3.01dB	23.36	23.39	23.28
EGPRS (8PSK)	1Txslot	25.38	26.02	26.23	-9.03dB	16.35	16.99	17.2
	2Txslots	24.29	24.77	25.14	-6.02dB	18.27	18.75	19.12
	3Txslots	22.34	22.52	23.05	-4.26dB	18.08	18.26	18.79
	4Txslots	21.05	21.44	21.98	-3.01dB	18.04	18.43	18.97

Note:

1) Division Factors

To average the power, the division factor is as follows:

1Txslot = 1 transmit time slot out of 8 time slots

=> conducted power divided by (8/1) => -9.03 dB

2Txslots = 2 transmit time slots out of 8 time slots

=> conducted power divided by (8/2) => -6.02 dB

3Txslots = 3 transmit time slots out of 8 time slots

=> conducted power divided by (8/3) => -4.26 dB

4Txslots = 4 transmit time slots out of 8 time slots

=> conducted power divided by (8/4) => -3.01 dB

2) Average power numbers

The maximum power numbers are marks in bold.

UMTS Band II		Conducted Power (dBm)		
		Channel 9262	Channel 9400	Channel 9538
RMC	12.2kbps RMC	22.97	23.24	22.86
	64kbps RMC	22.97	23.15	22.85
	144kbps RMC	22.96	23.13	22.83
	384kbps RMC	23	23.18	22.91
HSDPA	Sub - Test 1	22.03	22.19	21.9
	Sub - Test 2	21.98	22.17	21.85
	Sub - Test 3	21.51	21.73	21.38
	Sub - Test 4	21.52	21.67	21.45
HSUPA	Sub - Test 1	20.01	20.16	19.95
	Sub - Test 2	20	20.2	19.94
	Sub - Test 3	21.04	21.2	20.89
	Sub - Test 4	19.51	19.61	19.4
	Sub - Test 5	20.02	20.2	19.94
UMTS Band V		Conducted Power (dBm)		
		Channel 4132	Channel 4182	Channel 4233
RMC	12.2kbps RMC	22.92	23.14	22.86
	64kbps RMC	22.89	23.11	22.87
	144kbps RMC	22.88	23.14	22.81
	384kbps RMC	22.87	23.1	22.8
HSDPA	Sub - Test 1	22.09	22.23	21.95
	Sub - Test 2	22.04	22.21	21.91
	Sub - Test 3	21.55	21.73	21.45
	Sub - Test 4	21.55	21.72	21.41
HSUPA	Sub - Test 1	20.55	20.3	20
	Sub - Test 2	19.99	20.3	19.93
	Sub - Test 3	21.06	21.23	20.92
	Sub - Test 4	19.61	19.78	19.47
	Sub - Test 5	20.04	20.25	19.93

The average output power of BT antenna is as following:

Channel	Ch 0 2402 MHz	Ch 39 2441 MHz	Ch 78 2480 MHz
GFSK(dBm)	8.55	8.38	8.79
$\pi/4$ DQPSK(dBm)	7.99	7.73	8.05
8DPSK(dBm)	7.99	7.74	8.06
Low Energy - GFSK(dBm)	1.95	1.57	1.72

The output power of WIFI antenna is as following:

Mode	Data Rate (Mbps)	Test Result (dBm)		
		2412MHz (Ch1)	2437MHz (Ch6)	2462 MHz (Ch11)
802.11b	1	14.52	15.46	16.49
	2	14.49	15.43	16.70
	5.5	14.75	15.53	16.83
	11	14.67	15.48	16.77
802.11g	6	11.66	12.70	13.98
	9	11.65	12.71	13.98
	12	11.63	12.72	13.98
	18	11.58	12.75	14.22
	24	11.38	12.66	14.10
	36	11.56	12.60	14.08
	48	11.60	12.66	14.12
54	11.57	12.42	14.10	

802.11n mode

Mode	Data Rate (MCS Index)	Test Result (dBm)		
		2412MHz (Ch1)	2437MHz (Ch6)	2462 MHz (Ch11)
802.11n (20MHz BW)	MCS0	11.88	12.85	13.77
	MCS1	11.85	12.85	13.72
	MCS2	11.83	12.87	13.74
	MCS3	11.78	12.84	13.72
	MCS4	10.93	11.94	12.83
	MCS5	10.93	11.98	12.83
	MCS6	10.93	11.97	12.85
	MCS7	10.90	11.95	12.89

Mode	Data Rate (MCS Index)	Test Result (dBm)		
		2422MHz (Ch3)	2437MHz (Ch6)	2452 MHz (Ch9)
802.11n (40MHz BW)	MCS0	10.17	10.30	10.50
	MCS1	10.12	10.28	10.43
	MCS2	10.15	10.28	10.41
	MCS3	10.12	10.23	10.39
	MCS4	10.13	10.26	10.40
	MCS5	10.10	10.22	10.39
	MCS6	10.13	10.24	10.33
	MCS7	10.08	10.20	10.35

10.2 Standalone SAR Test Exclusion Considerations

Per FCC KDB 447498 D01, the SAR exclusion threshold for distances <50mm is defined by the following equation:

$$\frac{(\text{max. power of channel, including tune-up tolerance, mW})}{(\text{min. test separation distance, mm})} * \sqrt{\text{Frequency (GHz)}} \leq 3.0$$

Based on the above equation, Bluetooth SAR was not required;

$$\text{Head Evaluation} = [10^{(9/10)}/5] * (2.480^{1/2}) = 2.50 < 3.0$$

$$\text{Body Evaluation} = [10^{(9/10)}/10] * (2.480^{1/2}) = 1.25 < 3.0$$

For conditions where the estimated SAR is overly conservative for certain conditions, the test lab may choose to perform standalone SAR measurements and use the measured SAR to determine simultaneous transmission SAR test exclusion.

Based on the above equation, WIFI SAR was required;

$$\text{Head Evaluation} = [10^{(17/10)}/5] * (2.462^{1/2}) = 15.73 > 3.0$$

$$\text{Body Evaluation} = [10^{(17/10)}/10] * (2.462^{1/2}) = 7.86 > 3.0$$

10.3 SAR Test Results

10.3.1 GSM 850 (GSM/GPRS/EGPRS)

Table 16: SAR Values [GSM 850 (GSM/GPRS/EGPRS)]

Test Position	Channel/ Frequency (MHz)	Time slot	Duty Cycle	Maximum Allowed Power (dBm)	Conducted Power (dBm)	Drift ± 0.21 dB	Limit SAR _{1g} 1.6 W/kg			
						Drift (dB)	Measured SAR _{1g} (W/kg)	Scaling Factor	Reported SAR _{1g} (W/kg)	Graph Results
Test Position of Head										
Left/Cheek	190/836.6	GSM	1:8.3	34	32.79	-0.109	0.135	1.32	0.178	Figure13
Left/Tilt	190/836.6	GSM	1:8.3	34	32.79	-0.027	0.087	1.32	0.115	Figure14
Right/Cheek	190/836.6	GSM	1:8.3	34	32.79	-0.023	0.170	1.32	0.225	Figure15
Right/Tilt	190/836.6	GSM	1:8.3	34	32.79	0.023	0.088	1.32	0.117	Figure16
Worst Case Position of Head with SIM 2										
Right/Cheek	190/836.6	GSM	1:8.3	34	32.79	0.090	0.159	1.32	0.210	Figure17
Test position of Body (Distance 10mm) (Body Worn)										
Back Side	251/848.8	4Txslots	1:2.1	30	29.32	0.020	0.887	1.17	1.037	Figure18
	190/836.6	4Txslots	1:2.1	30	29.32	0.050	0.716	1.17	0.837	Figure19
	128/824.2	4Txslots	1:2.1	30	29.32	-0.030	0.530	1.17	0.620	Figure20
Front Side	190/836.6	4Txslots	1:2.1	30	29.32	-0.020	0.461	1.17	0.539	Figure21
Test position of Body (Distance 10mm) (Hotspot)										
Back Side	251/848.8	4Txslots	1:2.1	30	29.32	0.020	0.887	1.17	1.037	Figure18
	190/836.6	4Txslots	1:2.1	30	29.32	0.050	0.716	1.17	0.837	Figure19
	128/824.2	4Txslots	1:2.1	30	29.32	-0.030	0.530	1.17	0.620	Figure20
Front Side	190/836.6	4Txslots	1:2.1	30	29.32	-0.020	0.461	1.17	0.539	Figure21
Left Edge	190/836.6	4Txslots	1:2.1	30	29.32	0.001	0.120	1.17	0.140	Figure22
Right Edge	190/836.6	4Txslots	1:2.1	30	29.32	0.020	0.275	1.17	0.322	Figure23
Top Edge	N/A	N/A	N/A	N/A	N/A	N/A	N/A	N/A	N/A	N/A
Bottom Edge	190/836.6	4Txslots	1:2.1	30	29.32	-0.100	0.137	1.17	0.160	Figure24
Worst Case Position of Body with EGPRS(Distance 10mm)										
Back Side	251/848.8	4Txslots	1:2.1	30	29.33	0.020	0.940	1.17	1.097	Figure25
Worst Case Position of Body with SIM 2 (Distance 10mm)										
Back Side	251/848.8	4Txslots	1:2.1	30	29.32	-0.030	0.863	1.17	1.009	Figure26
Worst Case Position of Body (1st Repeated SAR, Distance 10mm)										
Back Side	251/848.8	4Txslots	1:2.1	30	29.33	-0.030	0.846	1.17	0.987	Figure27

Note: 1. The value with blue color is the maximum SAR Value of each test band.
2. Per FCC KDB Publication 447498 D01, if the reported (scaled) SAR measured at the middle channel or highest output power channel for each test configuration is ≤ 0.8 W/kg then testing at the other channels is not required for such test

configuration(s).

3. WWAN antenna is located at bottom edge; antenna-to-top edge distance is more than 2.5 cm (see ANNEX I). Based upon KDB941225 D06, when the antenna-to-edge distance is greater than 2.5cm, such position does not need to be tested.
4. When multiple slots are used, SAR should be tested to account for the maximum source-based time-averaged output power.
5. Per FCC KDB Publication 648474 D04, SAR was evaluated without a headset connected to the device. Since the reported SAR was ≤ 1.2 W/kg, no additional SAR evaluations using a headset cable were required.

Table 17: SAR Measurement Variability Results [GSM 850(GPRS/EGPRS)]

Test Position	Channel/ Frequency (MHz)	Measured SAR (1g)	1 st Repeated SAR (1g)	Ratio	2 nd Repeated SAR (1g)	3 rd Repeated SAR (1g)
Back Side	251/848.8	0.887	0.846	1.05	N/A	N/A

Note: 1) When the original highest measured SAR is ≥ 0.80 W/kg, the measurement was repeated once.

2) A second repeated measurement was performed only if the ratio of largest to smallest SAR for the original and first repeated measurements was > 1.20 or when the original or repeated measurement was ≥ 1.45 W/kg (~ 10% from the 1-g SAR limit).

3) A third repeated measurement was performed only if the original, first or second repeated measurement was ≥ 1.5 W/kg and the ratio of largest to smallest SAR for the original, first and second repeated measurements is > 1.20 .

4) Repeated measurements are not required when the original highest measured SAR is < 0.80 W/kg

10.3.2 GSM 1900 (GSM/GPRS/EGPRS)

Table 18: SAR Values [GSM 1900(GSM/GPRS/EGPRS)]

Test Position	Channel/ Frequency (MHz)	Time slot	Duty Cycle	Maximum Allowed Power (dBm)	Conducted Power (dBm)	Drift ± 0.21dB	Limit SAR _{1g} 1.6 W/kg			
						Drift (dB)	Measured SAR _{1g} (W/kg)	Scaling Factor	Reported SAR _{1g} (W/kg)	Graph Results
Test Position of Head										
Left/Cheek	661/1880	GSM	1:8.3	31.5	29.9	0.032	0.235	1.45	0.340	Figure28
Left/Tilt	661/1880	GSM	1:8.3	31.5	29.9	-0.150	0.124	1.45	0.179	Figure29
Right/Cheek	661/1880	GSM	1:8.3	31.5	29.9	0.120	0.182	1.45	0.263	Figure30
Right/Tilt	661/1880	GSM	1:8.3	31.5	29.9	0.030	0.130	1.45	0.188	Figure31
Worst Case Position of Head with SIM 2										
Left/Cheek	661/1880	GSM	1:8.3	31.5	29.9	0.043	0.258	1.45	0.373	Figure32
Test position of Body (Distance 10mm) (Body Worn)										
Back Side	661/1880	4Txslots	1:2.1	27.5	26.4	-0.060	0.499	1.29	0.643	Figure33
Front Side	810/1909.8	4Txslots	1:2.1	27.5	26.4	-0.070	0.641	1.29	0.826	Figure34
	661/1880	4Txslots	1:2.1	27.5	26.4	-0.040	0.686	1.29	0.884	Figure35
	512/1850.2	4Txslots	1:2.1	27.5	26.4	-0.010	0.539	1.29	0.694	Figure36
Test position of Body (Distance 10mm) (Hotspot)										
Back Side	661/1880	4Txslots	1:2.1	27.5	26.4	-0.060	0.499	1.29	0.643	Figure33
Front Side	810/1909.8	4Txslots	1:2.1	27.5	26.4	-0.070	0.641	1.29	0.826	Figure34
	661/1880	4Txslots	1:2.1	27.5	26.4	-0.040	0.686	1.29	0.884	Figure35
	512/1850.2	4Txslots	1:2.1	27.5	26.4	-0.010	0.539	1.29	0.694	Figure36
Left Edge	661/1880	4Txslots	1:2.1	27.5	26.4	-0.021	0.294	1.29	0.379	Figure37
Right Edge	661/1880	4Txslots	1:2.1	27.5	26.4	-0.024	0.078	1.29	0.100	Figure38
Top Edge	N/A	N/A	N/A	N/A	N/A	N/A	N/A	N/A	N/A	N/A
Bottom Edge	661/1880	4Txslots	1:2.1	27.5	26.4	0.060	0.466	1.29	0.600	Figure39
Worst Case Position of Body with EGPRS (Distance 10mm)										
Front Side	661/1880	4Txslots	1:2.1	27.5	26.4	0.010	0.679	1.29	0.875	Figure40
Worst Case Position of Body with SIM 2 (Distance 10mm)										
Front Side	661/1880	4Txslots	1:2.1	27.5	26.4	-0.020	0.684	1.29	0.881	Figure41

Note: 1. The value with blue color is the maximum SAR Value of each test band.

2. Per FCC KDB Publication 447498 D01, if the reported (scaled) SAR measured at the middle channel or highest output power channel for each test configuration is ≤ 0.8 W/kg then testing at the other channels is not required for such test configuration(s).

3. WWAN antenna is located at bottom edge; antenna-to-top edge distance is more than 2.5 cm (see ANNEX I). Based upon KDB941225 D06, when the antenna-to-edge distance is greater than 2.5cm, such position does not need to be tested.



4. When multiple slots are used, SAR should be tested to account for the maximum source-based time-averaged output power.
5. Per FCC KDB Publication 648474 D04, SAR was evaluated without a headset connected to the device. Since the reported SAR was ≤ 1.2 W/kg, no additional SAR evaluations using a headset cable were required.

10.3.3UMTS Band II (WCDMA/HSDPA/HSUPA)

Table 19: SAR Values [UMTS Band II (WCDMA/HSDPA/HSUPA)]

Test Position	Channel/ Frequency (MHz)	Channel Type	Duty Cycle	Maximum Allowed Power (dBm)	Conducted Power (dBm)	Drift ± 0.21dB	Limit SAR _{1g} 1.6 W/kg			
						Drift (dB)	Measured SAR _{1g} (W/kg)	Scaling Factor	Reported SAR _{1g} (W/kg)	Graph Results
Test Position of Head										
Left/Cheek	9400/1880	RMC 12.2k	1:1	24.5	23.24	0.052	0.509	1.34	0.680	Figure42
Left/Tilt	9400/1880	RMC 12.2k	1:1	24.5	23.24	0.020	0.246	1.34	0.329	Figure43
Right/Cheek	9400/1880	RMC 12.2k	1:1	24.5	23.24	-0.052	0.337	1.34	0.450	Figure44
Right/Tilt	9400/1880	RMC 12.2k	1:1	24.5	23.24	0.025	0.237	1.34	0.317	Figure45
Worst Case Position of Head with SIM 2										
Left/Cheek	9400/1880	RMC 12.2k	1:1	24.5	23.24	-0.130	0.446	1.34	0.596	Figure46
Test position of Body (Distance 10mm) (Body Worn)										
Back Side	9538/1907.6	RMC 12.2k	1:1	24.5	23.24	-0.050	0.673	1.34	0.900	Figure47
	9400/1880	RMC 12.2k	1:1	24.5	23.24	-0.070	0.644	1.34	0.861	Figure48
	9262/1852.4	RMC 12.2k	1:1	24.5	23.24	-0.080	0.616	1.34	0.823	Figure49
Front Side	9538/1907.6	RMC 12.2k	1:1	24.5	22.86	-0.080	0.663	1.46	0.967	Figure50
	9400/1880	RMC 12.2k	1:1	24.5	23.24	0.040	0.700	1.34	0.936	Figure51
	9262/1852.4	RMC 12.2k	1:1	24.5	22.97	0.050	0.682	1.42	0.970	Figure52
Test position of Body (Distance 10mm) (Hotspot)										
Back Side	9538/1907.6	RMC 12.2k	1:1	24.5	23.24	-0.050	0.673	1.34	0.900	Figure47
	9400/1880	RMC 12.2k	1:1	24.5	23.24	-0.070	0.644	1.34	0.861	Figure48
	9262/1852.4	RMC 12.2k	1:1	24.5	23.24	-0.080	0.616	1.34	0.823	Figure49
Front Side	9538/1907.6	RMC 12.2k	1:1	24.5	22.86	-0.080	0.663	1.46	0.967	Figure50
	9400/1880	RMC 12.2k	1:1	24.5	23.24	0.040	0.700	1.34	0.936	Figure51
	9262/1852.4	RMC 12.2k	1:1	24.5	22.97	0.050	0.682	1.42	0.970	Figure52
Left Edge	9400/1880	RMC 12.2k	1:1	24.5	23.24	-0.160	0.372	1.34	0.497	Figure53
Right Edge	9400/1880	RMC 12.2k	1:1	24.5	23.24	-0.110	0.123	1.34	0.164	Figure54
Top Edge	N/A	N/A	N/A	N/A	N/A	N/A	N/A	N/A	N/A	N/A
Bottom Edge	9538/1907.6	RMC 12.2k	1:1	24.5	22.86	-0.060	0.684	1.46	0.998	Figure55
	9400/1880	RMC 12.2k	1:1	24.5	23.24	-0.050	0.697	1.34	0.932	Figure56
	9262/1852.4	RMC 12.2k	1:1	24.5	22.97	-0.040	0.663	1.42	0.943	Figure57
Worst Case Position of Body with SIM 2 (Distance 10mm)										
Bottom Edge	9538/1907.6	RMC 12.2k	1:1	24.5	22.86	-0.040	0.702	1.46	1.024	Figure58

Note: 1. The value with blue color is the maximum SAR Value of each test band.

2. Per FCC KDB Publication 447498 D01, if the reported (scaled) SAR measured at the middle channel or highest output power channel for each test configuration is ≤ 0.8 W/kg then testing at the other channels is not required for such test configuration(s).

3. WWAN antenna is located at bottom edge; antenna-to-top edge distance is more than 2.5 cm (see ANNEX I). Based upon

KDB941225 D06, when the antenna-to-edge distance is greater than 2.5cm, such position does not need to be tested.

4. WCDMA mode were tested under RMC 12.2kbps without HSPA (HSDPA/HSUPA) inactive per KDB Publication 941225 D01. HSPA (HSDPA/HSUPA) SAR for body was not required since the average output power of the HSPA (HSDPA/HSUPA) subtests was not more than 0.25 dB higher than the RMC level and the maximum SAR for 12.2kbps RMC was less than 75% SAR limit.
5. Per FCC KDB Publication 648474 D04, SAR was evaluated without a headset connected to the device. Since the reported SAR was ≤ 1.2 W/kg, no additional SAR evaluations using a headset cable were required.

10.3.4UMTS Band V (WCDMA/HSDPA/HSUPA)

Table 20: SAR Values [UMTS Band V (WCDMA/HSDPA/HSUPA)]

Test Position	Channel/Frequency (MHz)	Channel Type	Duty Cycle	Maximum Allowed Power (dBm)	Conducted Power (dBm)	Drift ± 0.21 dB	Limit SAR _{1g} 1.6 W/kg			
						Drift (dB)	Measured SAR _{1g} (W/kg)	Scaling Factor	Reported SAR _{1g} (W/kg)	Graph Results
Test Position of Head										
Left/Cheek	4183/836.6	RMC 12.2k	1:1	24.5	23.14	0.120	0.108	1.37	0.148	Figure59
Left/Tilt	4183/836.6	RMC 12.2k	1:1	24.5	23.14	-0.054	0.072	1.37	0.099	Figure60
Right/Cheek	4183/836.6	RMC 12.2k	1:1	24.5	23.14	0.030	0.184	1.37	0.252	Figure61
Right/Tilt	4183/836.6	RMC 12.2k	1:1	24.5	23.14	-0.040	0.102	1.37	0.140	Figure62
Worst Case Position of Head with SIM 2										
Right/Cheek	4183/836.6	RMC 12.2k	1:1	24.5	23.14	-0.120	0.192	1.37	0.263	Figure63
Test position of Body (Distance 10mm) (Body Worn)										
Back Side	4183/836.6	RMC 12.2k	1:1	24.5	23.14	0.060	0.267	1.37	0.365	Figure64
Front Side	4183/836.6	RMC 12.2k	1:1	24.5	23.14	-0.002	0.194	1.37	0.265	Figure65
Test position of Body (Distance 10mm) (Hotspot)										
Back Side	4183/836.6	RMC 12.2k	1:1	24.5	23.14	0.060	0.267	1.37	0.365	Figure64
Front Side	4183/836.6	RMC 12.2k	1:1	24.5	23.14	-0.002	0.194	1.37	0.265	Figure65
Left Edge	4183/836.6	RMC 12.2k	1:1	24.5	23.14	-0.050	0.058	1.37	0.079	Figure66
Right Edge	4183/836.6	RMC 12.2k	1:1	24.5	23.14	0.030	0.118	1.37	0.161	Figure67
Top Edge	N/A	N/A	N/A	N/A	N/A	N/A	N/A	N/A	N/A	N/A
Bottom Edge	4183/836.6	RMC 12.2k	1:1	24.5	23.14	0.140	0.070	1.37	0.095	Figure68
Worst Case Position of Body with SIM 2 (Distance 10mm)										
Back Side	4183/836.6	RMC 12.2k	1:1	24.5	23.14	0.030	0.240	1.37	0.328	Figure69

Note: 1. The value with blue color is the maximum SAR Value of each test band.

- Per FCC KDB Publication 447498 D01, if the reported (scaled) SAR measured at the middle channel or highest output power channel for each test configuration is ≤ 0.8 W/kg then testing at the other channels is not required for such test configuration(s).
- WWAN antenna is located at bottom edge; antenna-to-top edge distance is more than 2.5 cm (see ANNEX I). Based upon KDB941225 D06, when the antenna-to-edge distance is greater than 2.5cm, such position does not need to be tested.
- WCDMA mode were tested under RMC 12.2kbps without HSPA (HSDPA/HSUPA) inactive per KDB Publication 941225 D01. HSPA (HSDPA/HSUPA) SAR for body was not required since the average output power of the HSPA (HSDPA/HSUPA) subtests was not more than 0.25 dB higher than the RMC level and the maximum SAR for 12.2kbps RMC was less than 75% SAR limit.
- Per FCC KDB Publication 648474 D04, SAR was evaluated without a headset connected to the device. Since the reported SAR was ≤ 1.2 W/kg, no additional SAR evaluations using a headset cable were required.

10.3.5WIFI (802.11b, WIFI)

Table 21: SAR Values (802.11b)

Test Position	Channel/Frequency (MHz)	Mode	Duty Cycle	Maximum Allowed Power (dBm)	Conducted Power (dBm)	Drift ± 0.21dB	Limit of SAR 1.6 W/kg			
						Drift (dB)	Measured SAR _{1g} (W/kg)	Scaling Factor	Reported SAR _{1g} (W/kg)	Graph Results
Test Position of Head										
Left/Cheek	11/2462	DSSS	1:1	17	16.83	0.010	0.131	1.04	0.136	Figure70
Left/Tilt	11/2462	DSSS	1:1	17	16.83	0.070	0.085	1.04	0.088	Figure71
Right/Cheek	11/2462	DSSS	1:1	17	16.83	-0.160	0.196	1.04	0.204	Figure72
Right/Tilt	11/2462	DSSS	1:1	17	16.83	-0.100	0.106	1.04	0.110	Figure73
Test position of Body (Distance 10mm) (Body Worn)										
Back Side	11/2462	DSSS	1:1	17	16.83	0.050	0.092	1.04	0.096	Figure74
Front Side	11/2462	DSSS	1:1	17	16.83	0.010	0.049	1.04	0.051	Figure75
Test position of Body (Distance 10mm) (Hotspot)										
Back Side	11/2462	DSSS	1:1	17	16.83	0.050	0.092	1.04	0.096	Figure74
Front Side	11/2462	DSSS	1:1	17	16.83	0.010	0.049	1.04	0.051	Figure75
Left Edge	11/2462	DSSS	1:1	17	16.83	-0.110	0.048	1.04	0.050	Figure76
Right Edge	N/A	N/A	N/A	N/A	N/A	N/A	N/A	N/A	N/A	N/A
Top Edge	11/2462	DSSS	1:1	17	16.83	0.060	0.024	1.04	0.025	Figure77
Bottom Edge	N/A	N/A	N/A	N/A	N/A	N/A	N/A	N/A	N/A	N/A

Note: 1. The value with blue color is the maximum SAR Value of each test band.

2. Per FCC KDB Publication 447498 D01, if the reported (scaled) SAR measured at the middle channel or highest output power channel for each test configuration is ≤ 0.8 W/kg then testing at the other channels is not required for such test configuration(s).
3. WLAN antenna is located at top edge, near to left edge ; antenna-to- Bottom/Right edge distance is more than 2.5 cm (see ANNEX I). Based upon KDB941225 D06, when the antenna-to-edge distance is greater than 2.5cm, such position does not need to be tested.
4. KDB 248227-SAR is not required for 802.11g/n channels when the maximum average output power is less than ¼ dB higher than measured on the corresponding 802.11b channels.
5. Per FCC KDB Publication 648474 D04, SAR was evaluated without a headset connected to the device. Since the reported SAR was ≤ 1.2 W/kg, no additional SAR evaluations using a headset cable were required.

10.4 Simultaneous Transmission Conditions

Air-Interface	Band (MHz)	Type	Simultaneous Transmissions	Voice Over Digital Transport (Data)
GSM/UMTS	850	VO	Yes BT, WIFI	NA
	1900	VO		
	850	DT	Yes BT, WIFI	NA
	1900	DT		
WIFI	2450	DT	Yes GSM, GPRS, EGPRS, WCDMA, HSDPA, HSUPA	NA
Bluetooth (BT)	2450	DT	Yes GSM, GPRS, EGPRS, WCDMA, HSDPA, HSUPA	NA
Note: VO Voice Service only DT Digital Transport				

The location of the antennas inside EUT is shown in ANNEX I.

When standalone SAR is not required to be measured per FCC KDB 447498 D01, the following equation must be used to estimate the standalone 1g SAR for simultaneous transmission assessment involving that transmitter.

$$\text{Estimated SAR} = \frac{(\text{max. power of channel, including tune-up tolerance, mW})}{(\text{min. test separation distance, mm})} *$$

$$\frac{\sqrt{f \text{ (GHz)}}}{7.5}$$

$$\text{So, Head Estimated SAR}_{\text{Max.BT}} = [10^{(9/10)}/5] * (2.480^{1/2}/7.5) = 0.33 \text{ W/kg}$$

$$\text{Body worn Estimated SAR}_{\text{Max.BT}} = [10^{(9/10)}/10] * (2.480^{1/2}/7.5) = 0.16 \text{ W/kg}$$

Per FCC KDB 447498 D01, simultaneous transmission SAR test exclusion may be applied when the sum of the 1-g SAR for all the simultaneous transmitting antennas in a specific a physical test configuration is ≤ 1.6 W/kg. When the sum is greater than the SAR limit, SAR test exclusion is determined by the SAR to peak location separation ratio.

$$\text{Ratio} = \frac{(\text{SAR}_1 + \text{SAR}_2)^{1.5}}{(\text{peak location separation, mm})} < 0.04$$

GSM/UMTS & BT Mode

Reported SAR _{1g} (W/kg)	GSM 850	GSM 1900	UMTS Band II	UMTS Band V	BT	MAX. Σ SAR _{1g}
Left hand, Touch cheek	0.178	0.373	0.680	0.148	0.33	1.010
Left hand, Tilt 15 Degree	0.115	0.179	0.329	0.099	0.33	0.659
Right hand, Touch cheek	0.225	0.263	0.450	0.263	0.33	0.780
Right hand, Tilt 15 Degree	0.117	0.188	0.317	0.140	0.33	0.647
Body, Back Side	1.097	0.643	0.900	0.365	0.16	1.257
Body, Front Side	0.539	0.884	0.970	0.265	0.16	1.130
Body, Left Edge	0.140	0.379	0.497	0.079	0.16	0.657
Body, Right Edge	0.322	0.100	0.164	0.161	0.16	0.482
Body, Top Edge	NA	NA	NA	NA	0.16	NA
Body, Bottom Edge	0.160	0.600	1.024	0.095	0.16	1.184

Note: 1. The value with blue color is the maximum Σ SAR_{1g} Value.
2. MAX. Σ SAR_{1g} = Reported SAR_{Max.BT} + Reported SAR_{Max.GSM/UMTS}

MAX. Σ SAR_{1g} = 1.257 W/kg < 1.6 W/kg, So the Simultaneous SAR are not required for WIFI, BT and GSM/UMTS antenna.

GSM/UMTS & WIFI Mode

Test Position	Reported SAR _{1g} (W/kg)	GSM 850	GSM 1900	UMTS Band II	UMTS Band V	WIFI	MAX. Σ SAR _{1g}
	Left hand, Touch cheek		0.178	0.373	0.680	0.148	0.136
Left hand, Tilt 15 Degree		0.115	0.179	0.329	0.099	0.088	0.417
Right hand, Touch cheek		0.225	0.263	0.450	0.263	0.204	0.654
Right hand, Tilt 15 Degree		0.117	0.188	0.317	0.140	0.110	0.427
Body, Back Side		1.097	0.643	0.900	0.365	0.096	1.193
Body, Front Side		0.539	0.884	0.970	0.265	0.051	1.021
Body, Left Edge		0.140	0.379	0.497	0.079	0.050	0.547
Body, Right Edge		0.322	0.100	0.164	0.161	NA	NA
Body, Top Edge		NA	NA	NA	NA	0.025	NA
Body, Bottom Edge		0.160	0.600	1.024	0.095	NA	NA

Note: 1. The value with blue color is the maximum ΣSAR_{1g} Value.
2. MAX. ΣSAR_{1g} = Reported SAR_{Max.WIFI} + Reported SAR_{Max.GSM/UMTS}

MAX. ΣSAR_{1g} = 1.193 W/kg < 1.6 W/kg, So the Simultaneous SAR are not required for WIFI and GSM/UMTS antenna.

BT and WiFi can not transmit simultaneously.

11 Measurement Uncertainty

No.	source	Type	Uncertainty Value (%)	Probability Distribution	k	c_i	Standard uncertainty u_i (%)	Degree of freedom V_{eff} or v_i
1	System repetivity	A	0.5	N	1	1	0.5	9
Measurement system								
2	-probe calibration	B	6.0	N	1	1	6.0	∞
3	-axial isotropy of the probe	B	4.7	R	$\sqrt{3}$	$\sqrt{0.5}$	1.9	∞
4	- Hemispherical isotropy of the probe	B	9.4	R	$\sqrt{3}$	$\sqrt{0.5}$	3.9	∞
5	-boundary effect	B	1.9	R	$\sqrt{3}$	1	1.1	∞
6	-probe linearity	B	4.7	R	$\sqrt{3}$	1	2.7	∞
7	- System detection limits	B	1.0	R	$\sqrt{3}$	1	0.6	∞
8	-readout Electronics	B	1.0	N	1	1	1.0	∞
9	-response time	B	0.8	R	$\sqrt{3}$	1	0.5	∞
10	-integration time	B	4.3	R	$\sqrt{3}$	1	2.5	∞
11	-RF Ambient noise	B	3.0	R	$\sqrt{3}$	1	1.7	∞
12	-RF Ambient Conditions	B	3.0	R	$\sqrt{3}$	1	1.7	∞
13	-Probe Positioner Mechanical Tolerance	B	0.4	R	$\sqrt{3}$	1	0.2	∞
14	-Probe Positioning with respect to Phantom Shell	B	2.9	R	$\sqrt{3}$	1	1.7	∞
15	-Extrapolation, interpolation and Integration Algorithms for Max. SAR Evaluation	B	3.9	R	$\sqrt{3}$	1	2.3	∞
Test sample Related								
16	-Test Sample Positioning	A	2.9	N	1	1	2.9	71
17	-Device Holder Uncertainty	A	4.1	N	1	1	4.1	5
18	- Power drift	B	5.0	R	$\sqrt{3}$	1	2.9	∞
Physical parameter								
19	-phantom Uncertainty	B	4.0	R	$\sqrt{3}$	1	2.3	∞

20	Algorithm for correcting SAR for deviations in permittivity and conductivity	B	1.9	N	1	0.84	0.9	∞
21	-Liquid conductivity (measurement uncertainty)	B	2.5	N	1	0.71	1.8	9
22	-Liquid permittivity (measurement uncertainty)	B	2.5	N	1	0.26	0.7	9
23	-Liquid conductivity -temperature uncertainty	B	1.7	R	$\sqrt{3}$	0.71	0.7	∞
24	-Liquid permittivity -temperature uncertainty	B	0.3	R	$\sqrt{3}$	0.26	0.05	∞
Combined standard uncertainty		$u_c = \sqrt{\sum_{i=1}^{24} c_i^2 u_i^2}$					11.34	
Expanded uncertainty (confidence interval of 95 %)		$u_e = 2u_c$		N	k=2	22.68		

12 Main Test Instruments

Table 22: List of Main Instruments

No.	Name	Type	Serial Number	Calibration Date	Valid Period
01	Network analyzer	Agilent 8753E	US37390326	September 10, 2013	One year
02	Dielectric Probe Kit	Agilent 85070E	US44020115	No Calibration Requested	
03	Power meter	Agilent E4417A	GB41291714	March 10, 2013	One year
04	Power sensor	Agilent N8481H	MY50350004	September 23, 2013	One year
05	Power sensor	E9327A	US40441622	January 2, 2013	One year
06	Signal Generator	HP 8341B	2730A00804	September 9, 2013	One year
07	Dual directional coupler	778D-012	50519	March 25, 2013	One year
08	Dual directional coupler	777D	50146	March 25, 2013	One year
09	Amplifier	IXA-020	0401	No Calibration Requested	
10	BTS	E5515C	MY48360988	November 26, 2013	One year
11	E-field Probe	EX3DV4	3753	January 17, 2013	One year
12	DAE	DAE4	1317	January 25, 2013	One year
13	Validation Kit 835MHz	D835V2	4d020	August 26, 2011	Three years
14	Validation Kit 1900MHz	D1900V2	5d060	August 31, 2011	Three years
15	Validation Kit 2450MHz	D2450V2	786	August 29, 2011	Three years
16	Temperature Probe	JM222	AA1009129	March 14, 2013	One year
17	Hygrothermograph	WS-1	64591	September 26, 2013	One year

*****END OF REPORT *****

ANNEX A: Test Layout



Picture 1: Specific Absorption Rate Test Layout



Picture 2: Liquid depth in the flat Phantom (835MHz, 15.4cm depth)

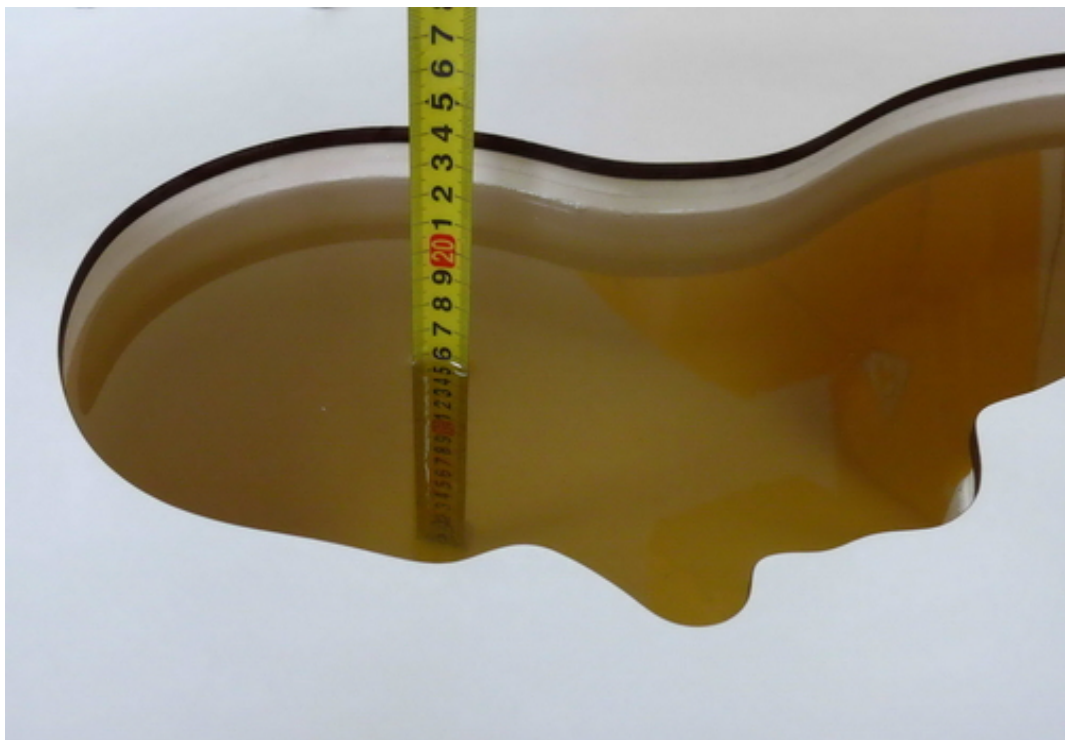

Picture 3: Liquid depth in the head Phantom (835MHz, 15.3cm depth)

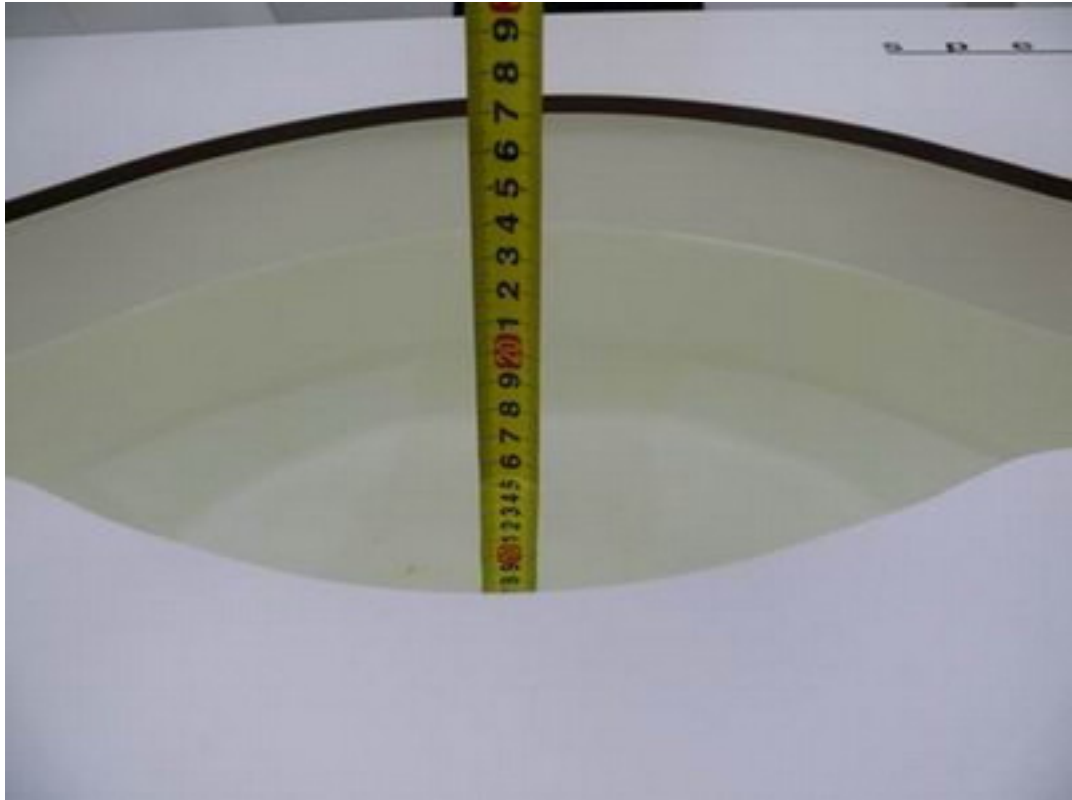

Picture 4: Liquid depth in the flat Phantom (1900 MHz, 15.2cm depth)



Picture 5: liquid depth in the head Phantom (1900 MHz, 15.3cm depth)

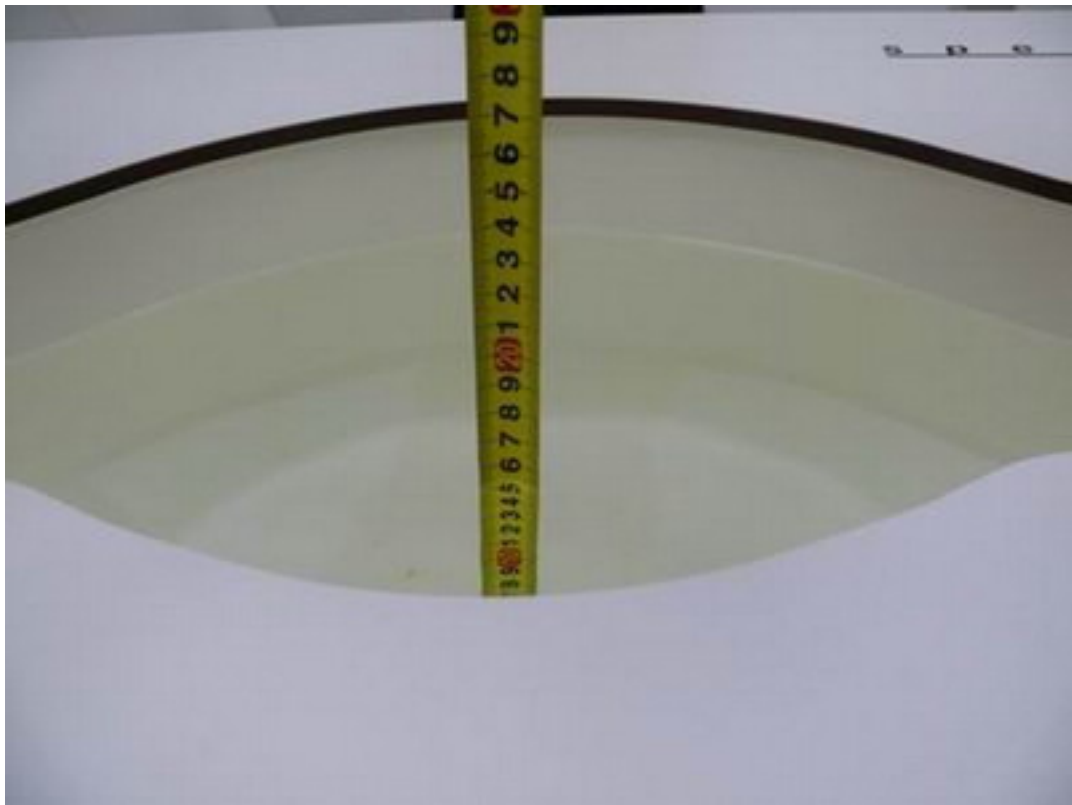

Picture 6: Liquid depth in the flat Phantom (2450 MHz, 15.3cm depth)



Picture 7: Liquid depth in the head Phantom (2450 MHz, 15.4cm depth)

ANNEX B: System Check Results

System Performance Check at 835 MHz Head TSL

DUT: Dipole 835 MHz; Type: D835V2; Serial: D835V2 - SN: 4d020

Date/Time: 2013-12-04 18:05:38

Communication System: CW; Frequency: 835 MHz; Duty Cycle: 1:1

Medium parameters used: $f = 835 \text{ MHz}$; $\sigma = 0.90 \text{ mho/m}$; $\epsilon_r = 41.8$; $\rho = 1000 \text{ kg/m}^3$

Ambient Temperature: $22.3 \text{ }^\circ\text{C}$ Liquid Temperature: $21.5 \text{ }^\circ\text{C}$

Phantom section: Flat Section

DASY5 Configuration:

Sensor-Surface: 4mm (Mechanical Surface Detection)

Probe: EX3DV4 - SN3753; ConvF(8.95, 8.95, 8.95); Calibrated: 2013-01-17

Electronics: DAE4 Sn1317; Calibrated: 2013-01-25

Phantom: SAM1; Type: SAM; Serial: TP-1534

Measurement SW: DASY5, V5.2 Build 162; SEMCAD X Version 14.0 Build 59

d=15mm, Pin=250mW/Area Scan (41x121x1): Measurement grid: $dx=15\text{mm}$, $dy=15\text{mm}$

Maximum value of SAR (interpolated) = 2.64 mW/g

d=15mm, Pin=250mW/Zoom Scan (7x7x7)/Cube 0: Measurement grid: $dx=5\text{mm}$, $dy=5\text{mm}$, $dz=5\text{mm}$

Reference Value = 54.4 V/m ; Power Drift = -0.076 dB

Peak SAR (extrapolated) = 3.67 W/kg

SAR(1 g) = 2.44 mW/g ; SAR(10 g) = 1.6 mW/g

Maximum value of SAR (measured) = 2.64 mW/g

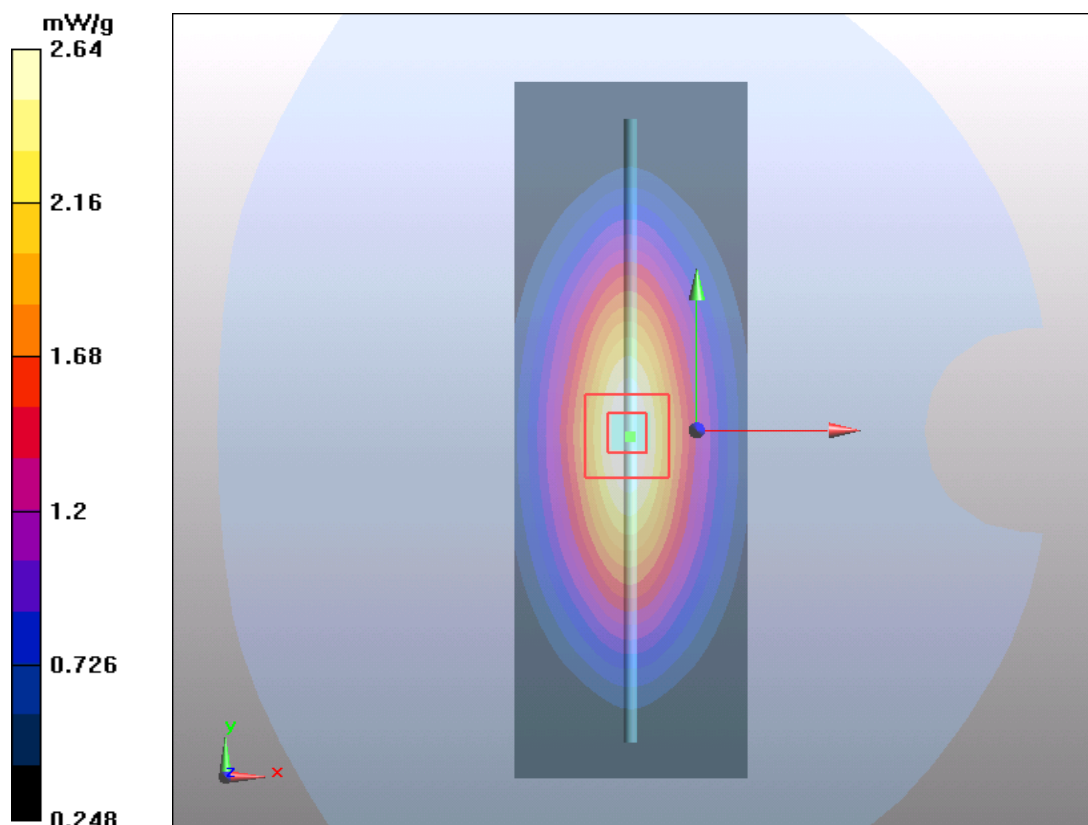

Figure 7 System Performance Check 835MHz 250mW

System Performance Check at 835 MHz Body TSL

DUT: Dipole 835 MHz; Type: D835V2; Serial: D835V2 - SN: 4d020

Date/Time: 2013-12-19 14:47:37

Communication System: CW; Frequency: 835 MHz; Duty Cycle: 1:1

Medium parameters used: $f = 835 \text{ MHz}$; $\sigma = 0.97 \text{ mho/m}$; $\epsilon_r = 54.5$; $\rho = 1000 \text{ kg/m}^3$

Ambient Temperature: $22.3 \text{ }^\circ\text{C}$ Liquid Temperature: $21.5 \text{ }^\circ\text{C}$

Phantom section: Flat Section

DASY5 Configuration:

Sensor-Surface: 4mm (Mechanical Surface Detection)

Probe: EX3DV4 - SN3753; ConvF(9.05, 9.05, 9.05); Calibrated: 2013-01-17

Electronics: DAE4 Sn1317; Calibrated: 2013-01-25

Phantom: SAM1; Type: SAM; Serial: TP-1534

Measurement SW: DASY5, V5.2 Build 162; SEMCAD X Version 14.0 Build 59

d=15mm, Pin=250mW/Area Scan (41x121x1): Measurement grid: $dx=15\text{mm}$, $dy=15\text{mm}$

Maximum value of SAR (interpolated) = 2.58 mW/g

d=15mm, Pin=250mW/Zoom Scan (7x7x7)/Cube 0: Measurement grid: $dx=5\text{mm}$, $dy=5\text{mm}$, $dz=5\text{mm}$

Reference Value = 51.9 V/m ; Power Drift = -0.058 dB

Peak SAR (extrapolated) = 3.5 W/kg

SAR(1 g) = 2.41 mW/g ; SAR(10 g) = 1.6 mW/g

Maximum value of SAR (measured) = 2.6 mW/g

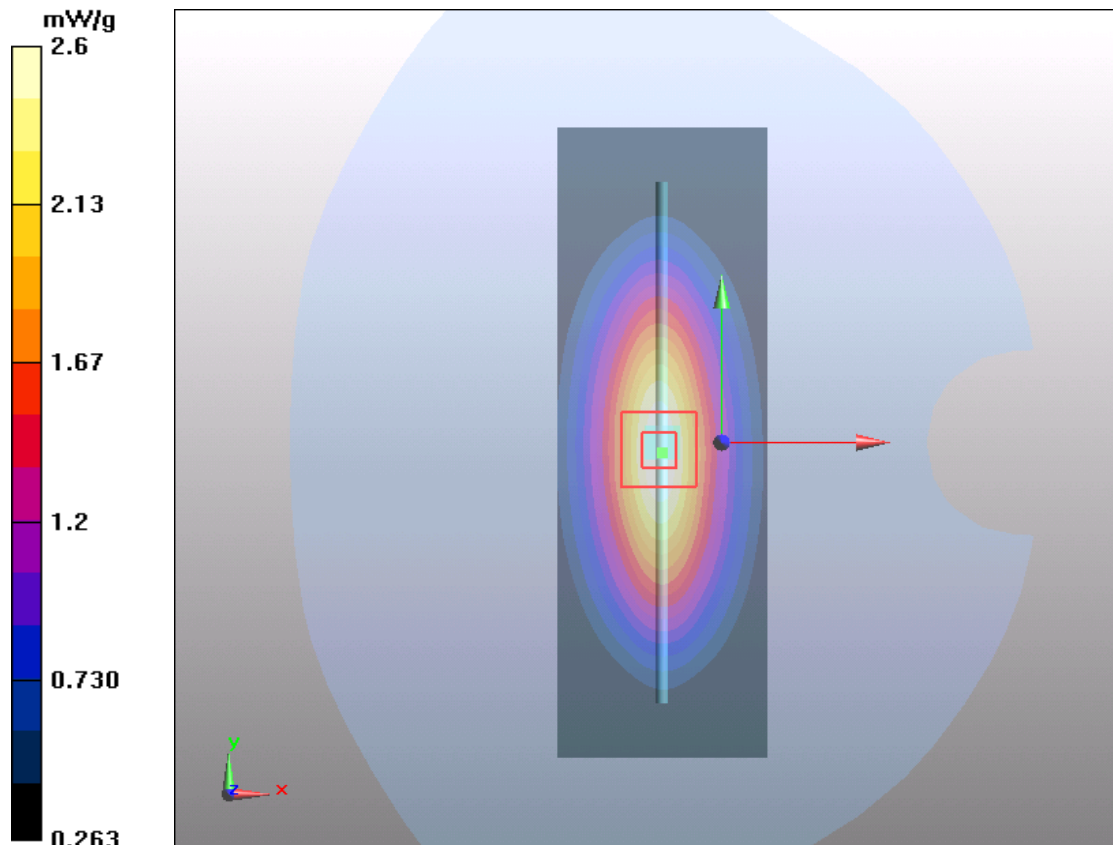

Figure 8 System Performance Check 835MHz 250mW

System Performance Check at 1900 MHz Head TSL

DUT: Dipole 1900 MHz; Type: D1900V2; Serial: D1900V2 - SN: 5d060

Date/Time: 2013-12-10 12:58:55

Communication System: CW; Frequency: 1900 MHz; Duty Cycle: 1:1

Medium parameters used: $f = 1900$ MHz; $\sigma = 1.34$ mho/m; $\epsilon_r = 39.6$; $\rho = 1000$ kg/m³

Ambient Temperature: 22.3 °C Liquid Temperature: 21.5 °C

Phantom section: Flat Section

DASY5 Configuration:

Sensor-Surface: 4mm (Mechanical Surface Detection)

Probe: EX3DV4 - SN3753; ConvF(7.63, 7.63, 7.63); Calibrated: 2013-01-17

Electronics: DAE4 Sn1317; Calibrated: 2013-01-25

Phantom: SAM2; Type: SAM; Serial: TP-1524

Measurement SW: DASY5, V5.2 Build 162; SEMCAD X Version 14.0 Build 59

d=10mm, Pin=250mW/Area Scan (41x71x1): Measurement grid: dx=15mm, dy=15mm

Maximum value of SAR (interpolated) = 11.3 mW/g

d=10mm, Pin=250mW/Zoom Scan (7x7x7)/Cube 0: Measurement grid: dx=5mm, dy=5mm,

dz=5mm

Reference Value = 85.5 V/m; Power Drift = 0.028 dB

Peak SAR (extrapolated) = 17.8 W/kg

SAR(1 g) = 9.48 mW/g; SAR(10 g) = 4.9 mW/g

Maximum value of SAR (measured) = 10.7 mW/g

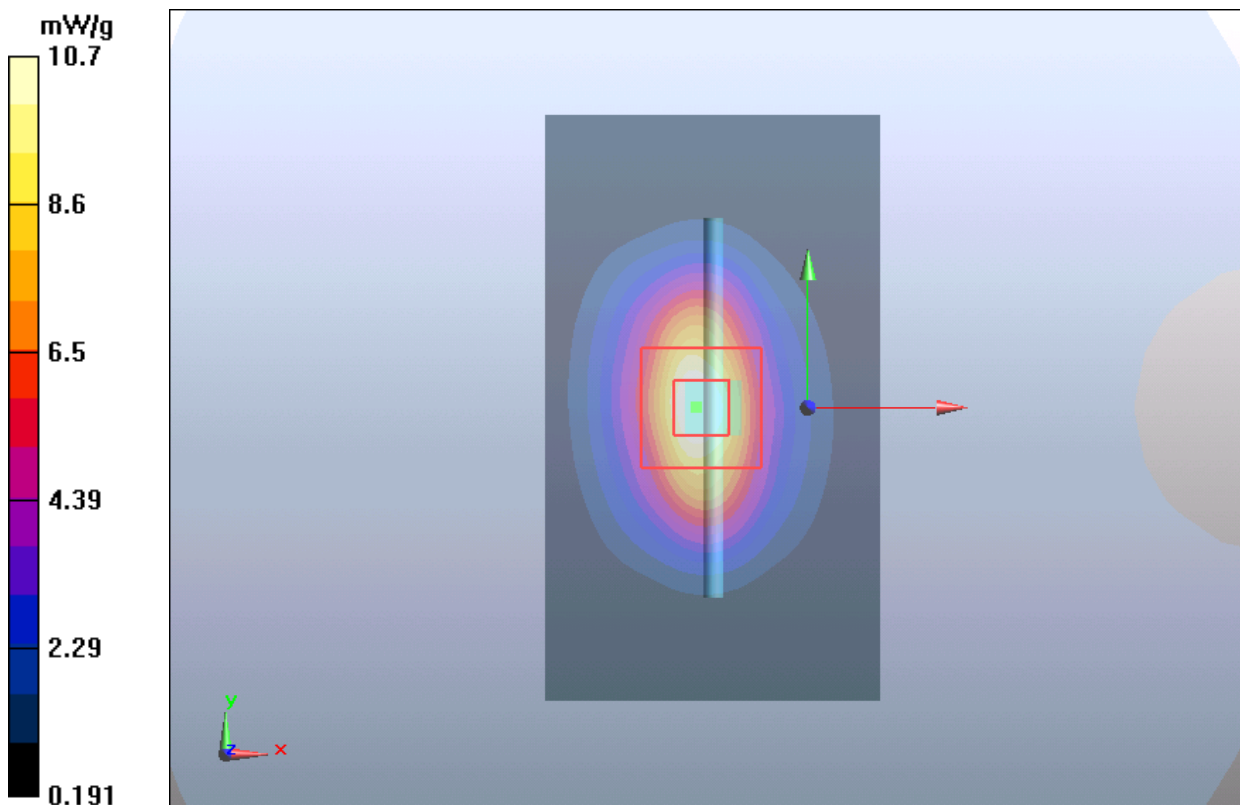

Figure 9 System Performance Check 1900MHz 250mW

System Performance Check at 1900 MHz Body TSL

DUT: Dipole 1900 MHz; Type: D1900V2; Serial: D1900V2 - SN: 5d060

Date/Time: 2013-12-23 8:21:25

Communication System: CW; Frequency: 1900 MHz; Duty Cycle: 1:1

Medium parameters used: $f = 1900$ MHz; $\sigma = 1.53$ mho/m; $\epsilon_r = 52.9$; $\rho = 1000$ kg/m³

Ambient Temperature: 22.3 °C Liquid Temperature: 21.5 °C

Phantom section: Flat Section

DASY5 Configuration:

Sensor-Surface: 4mm (Mechanical Surface Detection)

Probe: EX3DV4 - SN3753; ConvF(7.33, 7.33, 7.33); Calibrated: 2013-01-17

Electronics: DAE4 Sn1317; Calibrated: 2013-01-25

Phantom: SAM2; Type: SAM; Serial: TP-1524

Measurement SW: DASY5, V5.2 Build 162; SEMCAD X Version 14.0 Build 59

d=10mm, Pin=250mW/Area Scan (41x71x1): Measurement grid: dx=15mm, dy=15mm

Maximum value of SAR (interpolated) = 12.2 mW/g

d=10mm, Pin=250mW/Zoom Scan (7x7x7)/Cube 0: Measurement grid: dx=5mm, dy=5mm, dz=5mm

Reference Value = 82.3 V/m; Power Drift = 0.068 dB

Peak SAR (extrapolated) = 17.8 W/kg

SAR(1 g) = 9.93 mW/g; SAR(10 g) = 5.25 mW/g

Maximum value of SAR (measured) = 11.3 mW/g

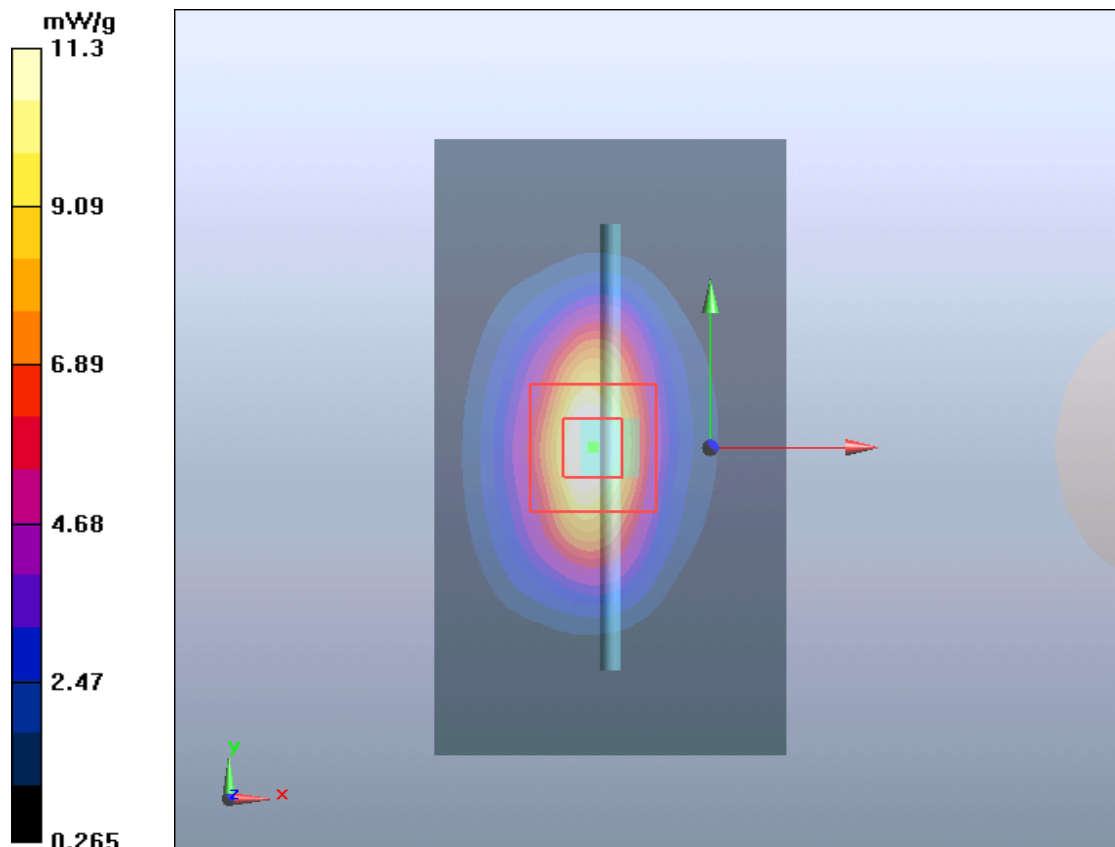

Figure 10 System Performance Check 1900MHz 250Mw

System Performance Check at 2450 MHz Head TSL

DUT: Dipole 2450 MHz; Type: D2450V2; Serial: D2450V2 - SN: 786

Date/Time: 2013-12-09 10:42:12

Communication System: CW; Frequency: 2450 MHz; Duty Cycle: 1:1

Medium parameters used: $f = 2450$ MHz; $\sigma = 1.79$ mho/m; $\epsilon_r = 38.81$; $\rho = 1000$ kg/m³

Ambient Temperature: 22.3 °C Liquid Temperature: 21.5 °C

Phantom section: Flat Section

DASY5 Configuration:

Sensor-Surface: 4mm (Mechanical Surface Detection)

Probe: EX3DV4 - SN3753; ConvF(6.86, 6.86, 6.86); Calibrated: 2013-01-17

Electronics: DAE4 Sn1317; Calibrated: 2013-01-25

Phantom: SAM2; Type: SAM; Serial: TP-1524

Measurement SW: DASY5, V5.2 Build 162; SEMCAD X Version 14.0 Build 59

d=10mm, Pin=250mW/Area Scan (41x71x1): Measurement grid: dx=12mm, dy=12mm

Maximum value of SAR (interpolated) = 18.2 mW/g

d=10mm, Pin=250mW/Zoom Scan (7x7x7)/Cube 0: Measurement grid: dx=5mm, dy=5mm,

dz=5mm

Reference Value = 88.8 V/m; Power Drift = 0.075 dB

Peak SAR (extrapolated) = 30 W/kg

SAR(1 g) = 13.7 mW/g; SAR(10 g) = 6.22 mW/g

Maximum value of SAR (measured) = 15.9 mW/g

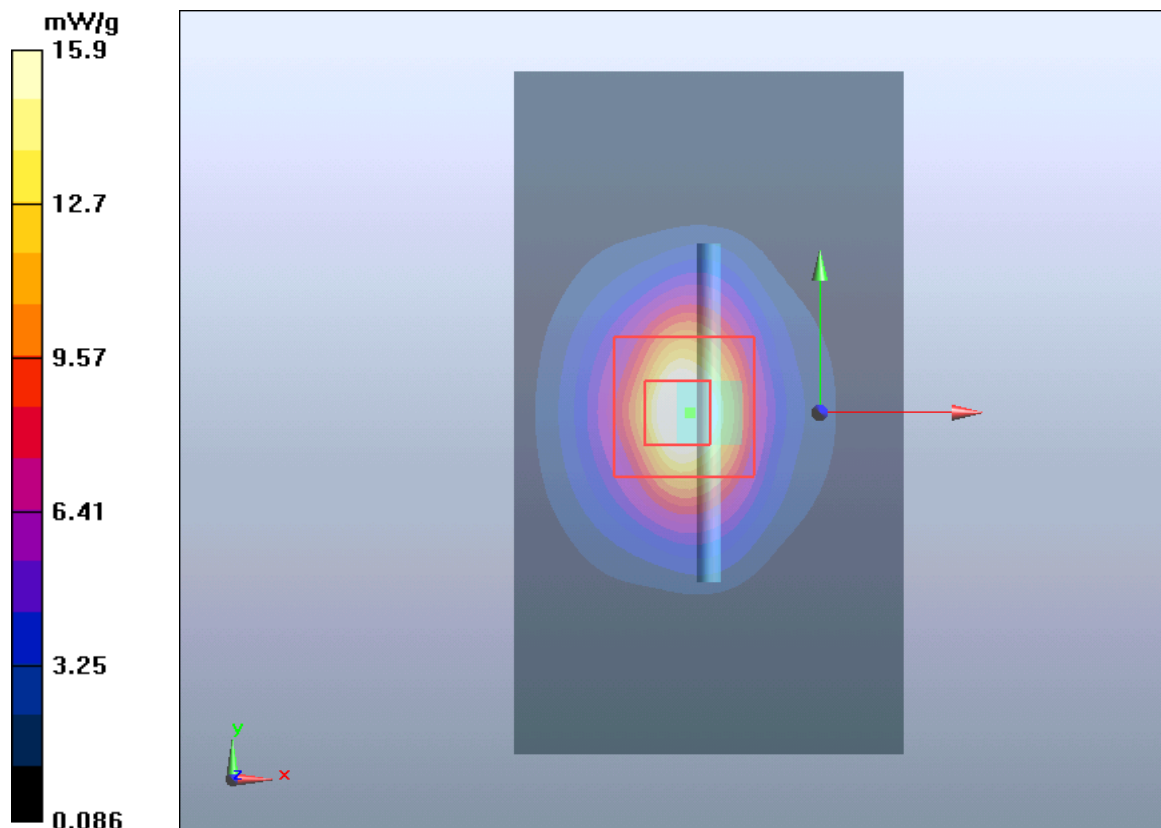

Figure 11 System Performance Check 2450MHz 250mW

System Performance Check at 2450 MHz Body TSL

DUT: Dipole 2450 MHz; Type: D2450V2; Serial: D2450V2 - SN: 786

Date/Time: 2013-12-09 14:15:59

Communication System: CW; Frequency: 2450 MHz; Duty Cycle: 1:1

Medium parameters used: $f = 2450$ MHz; $\sigma = 1.97$ mho/m; $\epsilon_r = 52.0$; $\rho = 1000$ kg/m³

Ambient Temperature: 22.3 °C Liquid Temperature: 21.5 °C

Phantom section: Flat Section

DASY5 Configuration:

Sensor-Surface: 4mm (Mechanical Surface Detection)

Probe: EX3DV4 - SN3753; ConvF(6.90, 6.90, 6.90); Calibrated: 2013-01-17

Electronics: DAE4 Sn1317; Calibrated: 2013-01-25

Phantom: SAM2; Type: SAM; Serial: TP-1524

Measurement SW: DASY5, V5.2 Build 162; SEMCAD X Version 14.0 Build 59

d=10mm, Pin=250mW/Area Scan (41x71x1): Measurement grid: dx=12mm, dy=12mm

Maximum value of SAR (interpolated) = 16 mW/g

d=10mm, Pin=250mW/Zoom Scan (7x7x7)/Cube 0: Measurement grid: dx=5mm, dy=5mm, dz=5mm

Reference Value = 81.2 V/m; Power Drift = 0.003 dB

Peak SAR (extrapolated) = 25.4 W/kg

SAR(1 g) = 12.5 mW/g; SAR(10 g) = 6.20 mW/g

Maximum value of SAR (measured) = 14.4 mW/g

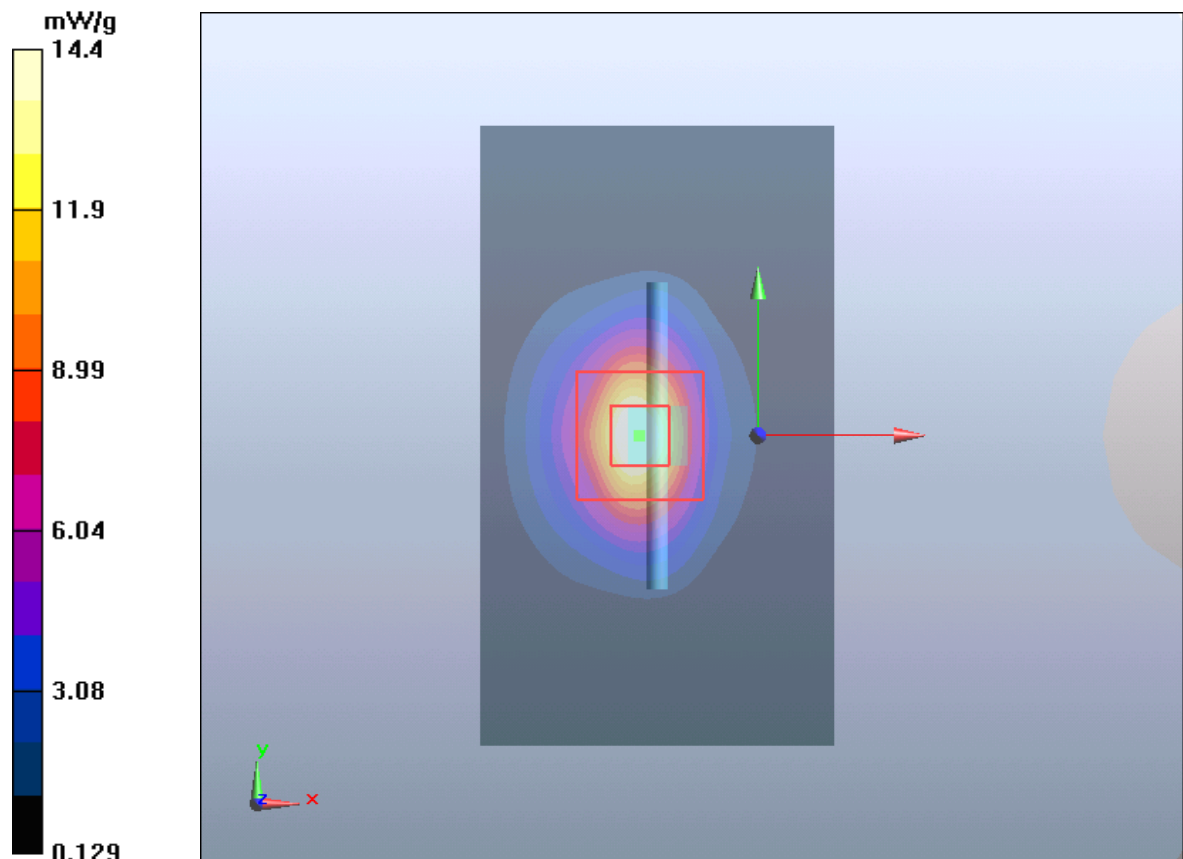

Figure 12 System Performance Check 2450MHz 250mW

ANNEX C: Graph Results

GSM 850 Left Cheek Middle

Date/Time: 2013-12-04 20:26:01

Communication System: GSM; Frequency: 836.6 MHz; Duty Cycle: 1:8.30042

Medium parameters used: $f = 837$ MHz; $\sigma = 0.932$ S/m; $\epsilon_r = 41.357$; $\rho = 1000$ kg/m³

Ambient Temperature: 22.3 °C Liquid Temperature: 21.5 °C

Phantom section: Left Section

DASY5 Configuration:

Sensor-Surface: 4mm (Mechanical Surface Detection)

Probe: EX3DV4 - SN3753; ConvF(8.95, 8.95, 8.95); Calibrated: 2013-01-17

Electronics: DAE4 Sn1317; Calibrated: 2013-01-25

Phantom: SAM 1; Type: QD000P40CD; Serial: TP:1666

Measurement SW: DASY52, Version 52.8 (5); SEMCAD X Version 14.6.8 (7028)

Left Cheek Middle /Area Scan (71x111x1): Interpolated grid: dx=15 mm, dy=15 mm

Maximum value of SAR (interpolated) = 0.142 W/kg

Left Cheek Middle /Zoom Scan (5x5x7)/Cube 0: Measurement grid: dx=8mm, dy=8mm, dz=5mm

Reference Value = 4.057 V/m; Power Drift = -0.109 dB

Peak SAR (extrapolated) = 0.160 W/kg

SAR(1 g) = 0.135 W/kg; SAR(10 g) = 0.104 W/kg

Maximum value of SAR (measured) = 0.143 W/kg

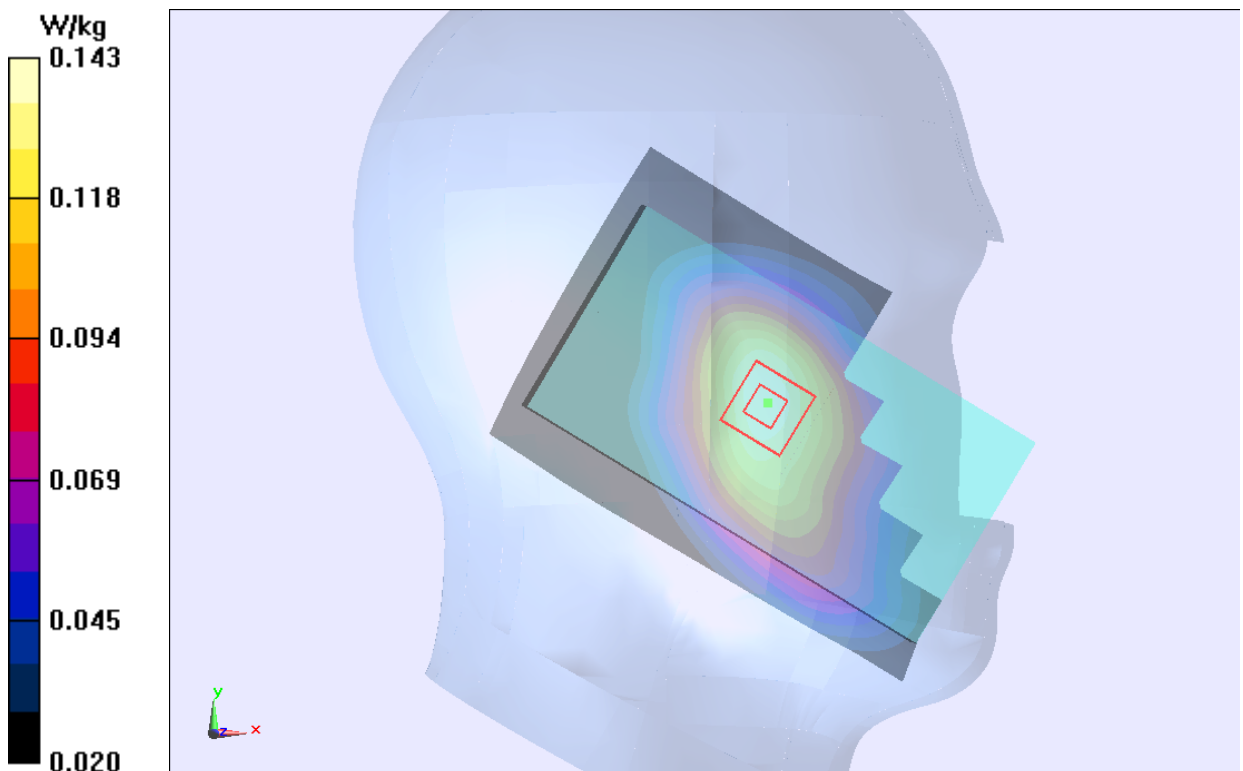

Figure 13 Left Hand Touch Cheek GSM 850 Channel 190

GSM 850 Left Tilt Middle

Date/Time: 2013-12-04 20:43:48

Communication System: GSM; Frequency: 836.6 MHz; Duty Cycle: 1:8.30042

Medium parameters used: $f = 837$ MHz; $\sigma = 0.932$ S/m; $\epsilon_r = 41.357$; $\rho = 1000$ kg/m³

Ambient Temperature: 22.3 °C Liquid Temperature: 21.5 °C

Phantom section: Left Section

DASY5 Configuration:

Sensor-Surface: 4mm (Mechanical Surface Detection)

Probe: EX3DV4 - SN3753; ConvF(8.95, 8.95, 8.95); Calibrated: 2013-01-17

Electronics: DAE4 Sn1317; Calibrated: 2013-01-25

Phantom: SAM 1; Type: QD000P40CD; Serial: TP:1666

Measurement SW: DASY52, Version 52.8 (5); SEMCAD X Version 14.6.8 (7028)

Left Tilt Middle /Area Scan (71x111x1): Interpolated grid: dx=15 mm, dy=15 mm

Maximum value of SAR (interpolated) = 0.0916 W/kg

Left Tilt Middle /Zoom Scan (5x5x7)/Cube 0: Measurement grid: dx=8mm, dy=8mm, dz=5mm

Reference Value = 5.922 V/m; Power Drift = -0.027 dB

Peak SAR (extrapolated) = 0.0990 W/kg

SAR(1 g) = 0.087 W/kg; SAR(10 g) = 0.069 W/kg

Maximum value of SAR (measured) = 0.0905 W/kg

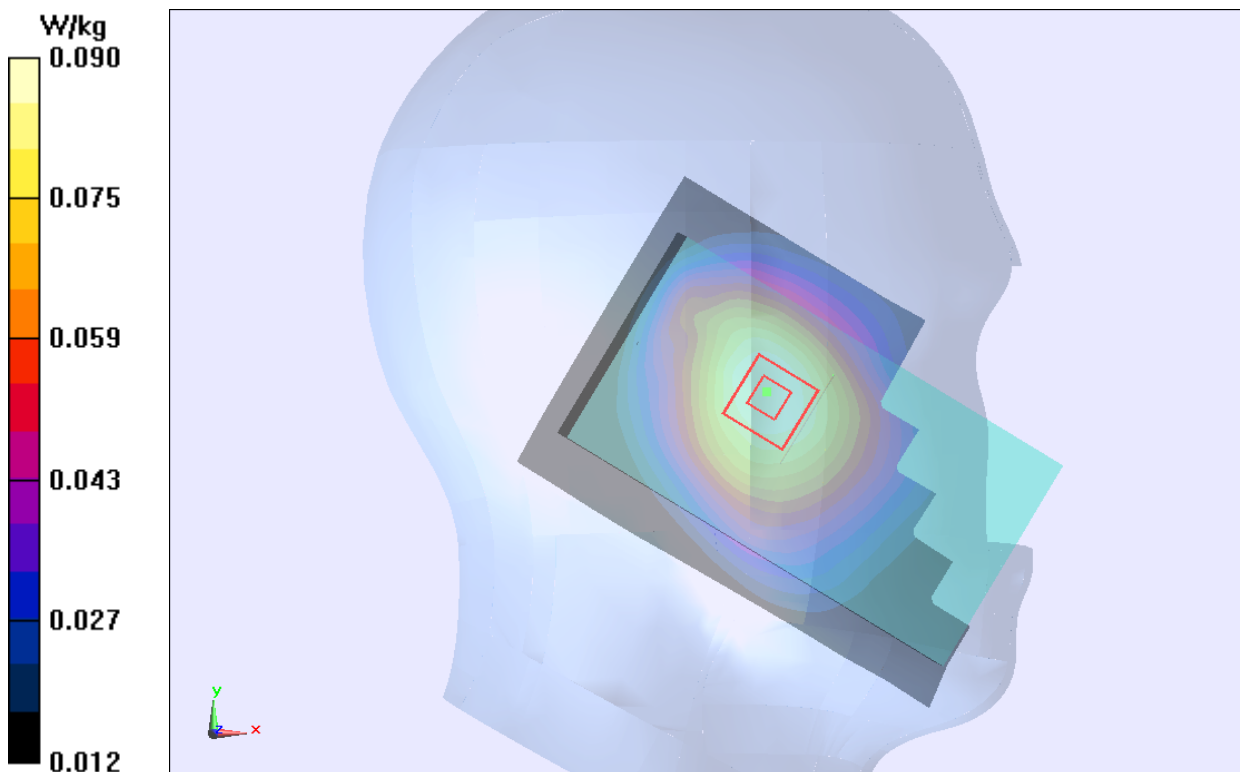

Figure 14 Left Hand Tilt 15° GSM 850 Channel 190

GSM 850 Right Cheek Middle

Date/Time: 2013-12-04 19:41:19

Communication System: GSM; Frequency: 836.6 MHz; Duty Cycle: 1:8.30042

Medium parameters used: $f = 837$ MHz; $\sigma = 0.932$ S/m; $\epsilon_r = 41.357$; $\rho = 1000$ kg/m³

Ambient Temperature: 22.3 °C Liquid Temperature: 21.5°C

Phantom section: Right Section

DASY5 Configuration:

Sensor-Surface: 4mm (Mechanical Surface Detection)

Probe: EX3DV4 - SN3753; ConvF(8.95, 8.95, 8.95); Calibrated: 2013-01-17

Electronics: DAE4 Sn1317; Calibrated: 2013-01-25

Phantom: SAM 1; Type: QD000P40CD; Serial: TP:1666

Measurement SW: DASY52, Version 52.8 (5); SEMCAD X Version 14.6.8 (7028)

Right Cheek Middle /Area Scan (71x111x1): Interpolated grid: dx=15 mm, dy=15 mm

Maximum value of SAR (interpolated) = 0.185 W/kg

Right Cheek Middle /Zoom Scan (5x5x7)/Cube 0: Measurement grid: dx=8mm, dy=8mm, dz=5mm

Reference Value = 4.004 V/m; Power Drift = -0.023 dB

Peak SAR (extrapolated) = 0.206 W/kg

SAR(1 g) = 0.170 W/kg; SAR(10 g) = 0.131 W/kg

Maximum value of SAR (measured) = 0.179 W/kg

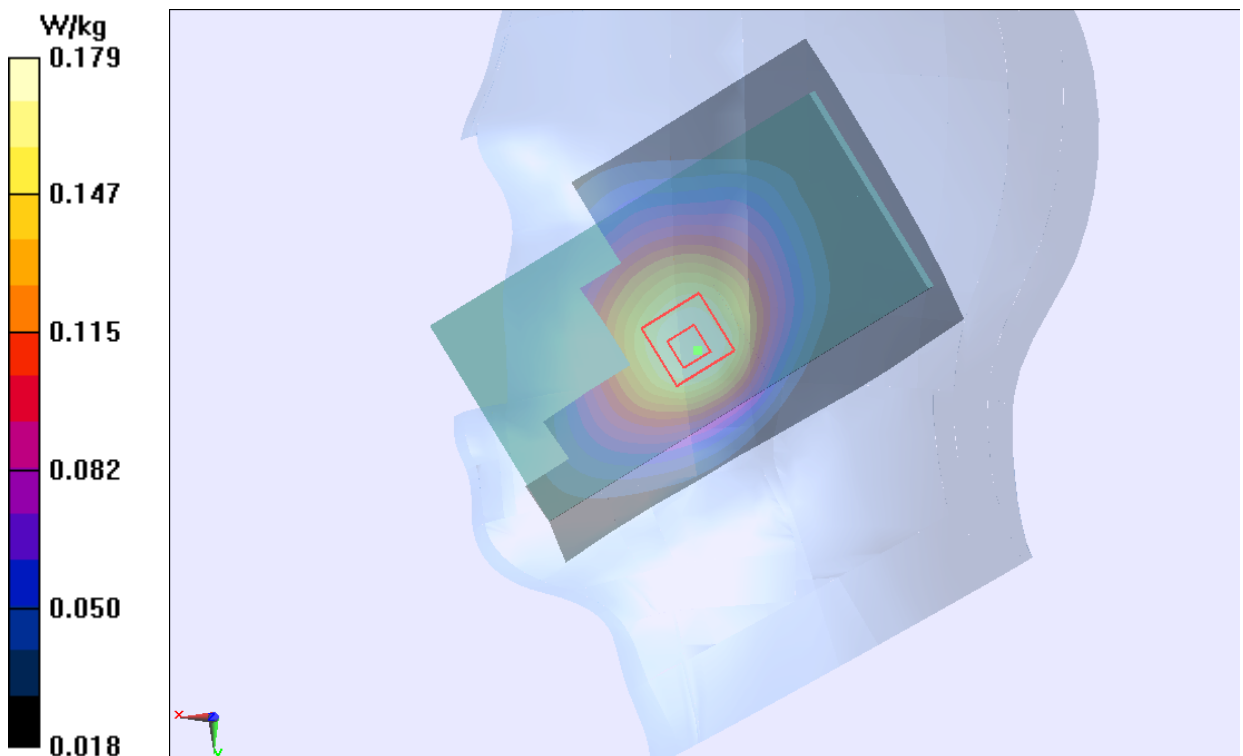

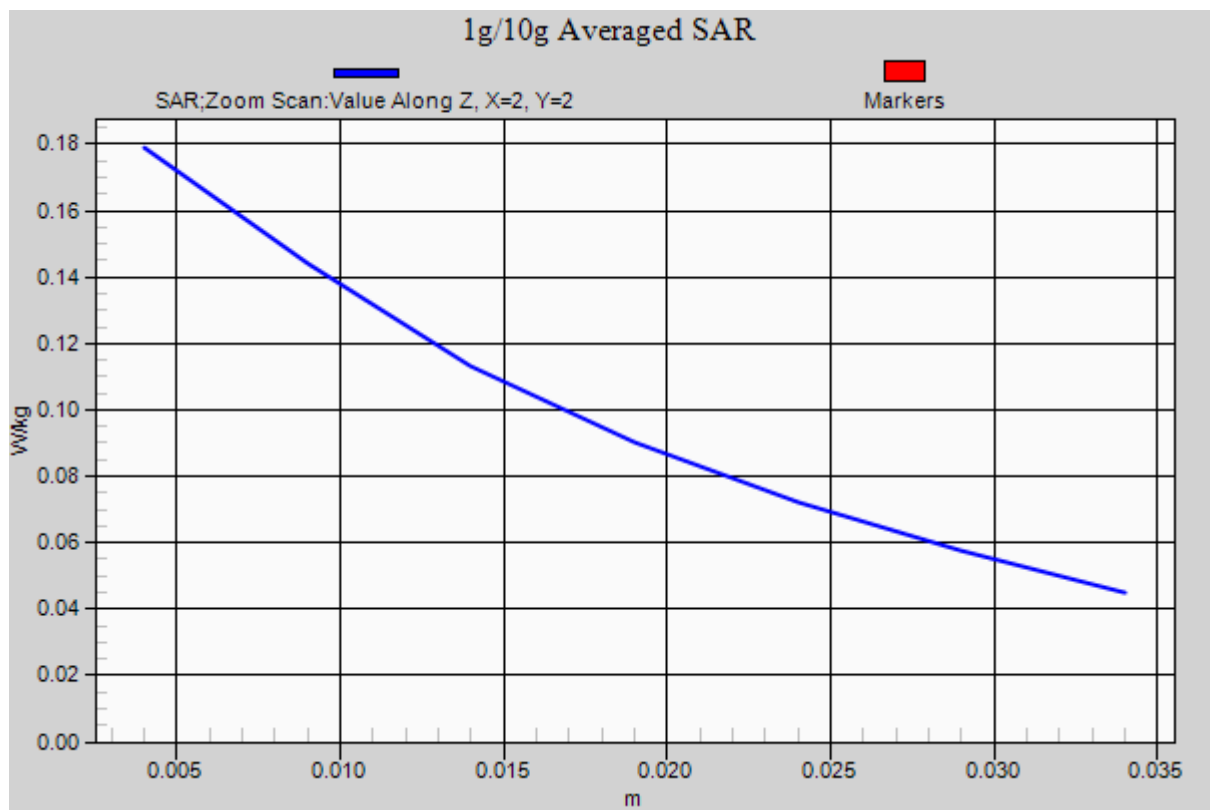

Figure 15 Right Hand Touch Cheek GSM 850 Channel 190

GSM 850 Right Tilt Middle

Date/Time: 2013-12-04 19:59:45

Communication System: GSM; Frequency: 836.6 MHz; Duty Cycle: 1:8.30042

Medium parameters used: $f = 837$ MHz; $\sigma = 0.932$ S/m; $\epsilon_r = 41.357$; $\rho = 1000$ kg/m³

Ambient Temperature: 22.3 °C Liquid Temperature: 21.5 °C

Phantom section: Right Section

DASY5 Configuration:

Sensor-Surface: 4mm (Mechanical Surface Detection)

Probe: EX3DV4 - SN3753; ConvF(8.95, 8.95, 8.95); Calibrated: 2013-01-17

Electronics: DAE4 Sn1317; Calibrated: 2013-01-25

Phantom: SAM 1; Type: QD000P40CD; Serial: TP:1666

Measurement SW: DASY52, Version 52.8 (5); SEMCAD X Version 14.6.8 (7028)

Right Tilt Middle /Area Scan (71x111x1): Interpolated grid: dx=15 mm, dy=15 mm

Maximum value of SAR (interpolated) = 0.0920 W/kg

Right Tilt Middle /Zoom Scan (5x5x7)/Cube 0: Measurement grid: dx=8mm, dy=8mm, dz=5mm

Reference Value = 6.082 V/m; Power Drift = 0.023 dB

Peak SAR (extrapolated) = 0.100 W/kg

SAR(1 g) = 0.088 W/kg; SAR(10 g) = 0.070 W/kg

Maximum value of SAR (measured) = 0.0927 W/kg

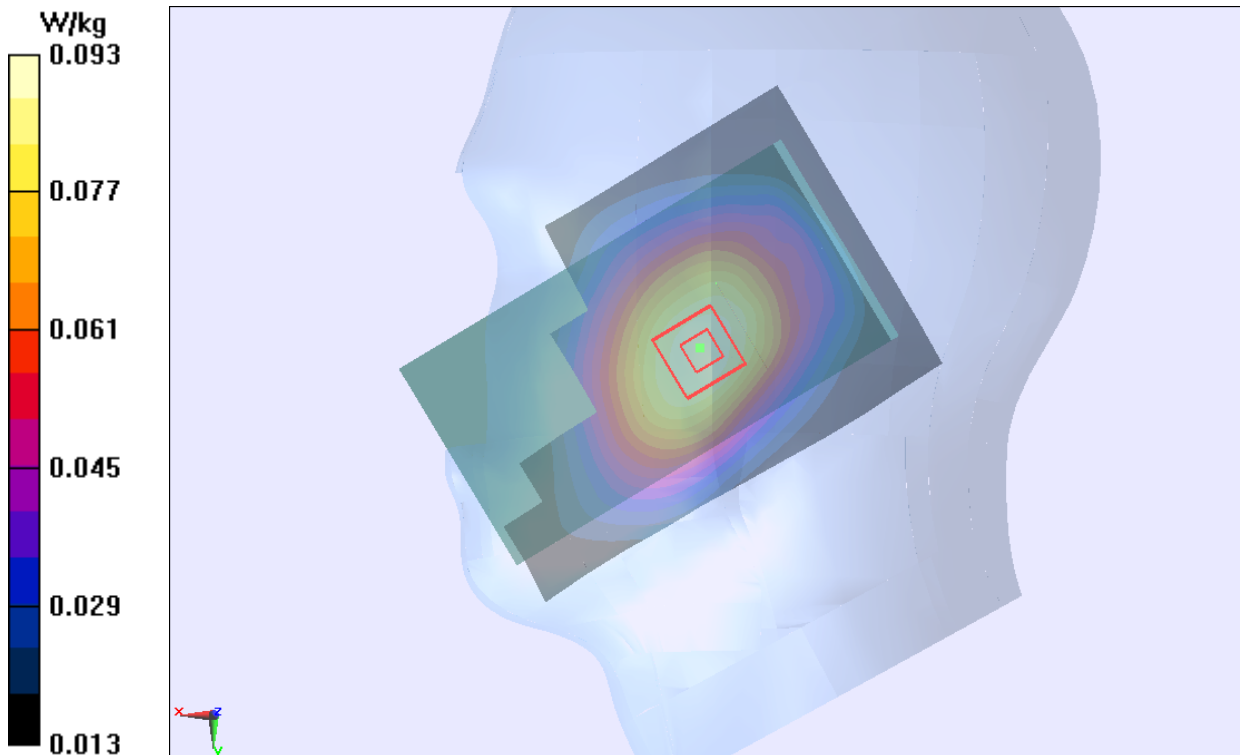

Figure 16 Right Hand Tilt 15° GSM 850 Channel 190

GSM 850 Right Cheek Middle (SIM 2)

Date/Time: 2013-12-04 21:06:16

Communication System: GSM; Frequency: 836.6 MHz; Duty Cycle: 1:8.30042

Medium parameters used: $f = 837$ MHz; $\sigma = 0.932$ S/m; $\epsilon_r = 41.357$; $\rho = 1000$ kg/m³

Ambient Temperature: 22.3 °C Liquid Temperature: 21.5°C

Phantom section: Right Section

DASY5 Configuration:

Sensor-Surface: 4mm (Mechanical Surface Detection)

Probe: EX3DV4 - SN3753; ConvF(8.95, 8.95, 8.95); Calibrated: 2013-01-17

Electronics: DAE4 Sn1317; Calibrated: 2013-01-25

Phantom: SAM 1; Type: QD000P40CD; Serial: TP:1666

Measurement SW: DASY52, Version 52.8 (5); SEMCAD X Version 14.6.8 (7028)

Right Cheek Middle /Area Scan (71x111x1): Interpolated grid: dx=15 mm, dy=15 mm

Maximum value of SAR (interpolated) = 0.168 W/kg

Right Cheek Middle /Zoom Scan (5x5x7)/Cube 0: Measurement grid: dx=8mm, dy=8mm, dz=5mm

Reference Value = 4.138 V/m; Power Drift = 0.090 dB

Peak SAR (extrapolated) = 0.190 W/kg

SAR(1 g) = 0.159 W/kg; SAR(10 g) = 0.123 W/kg

Maximum value of SAR (measured) = 0.168 W/kg

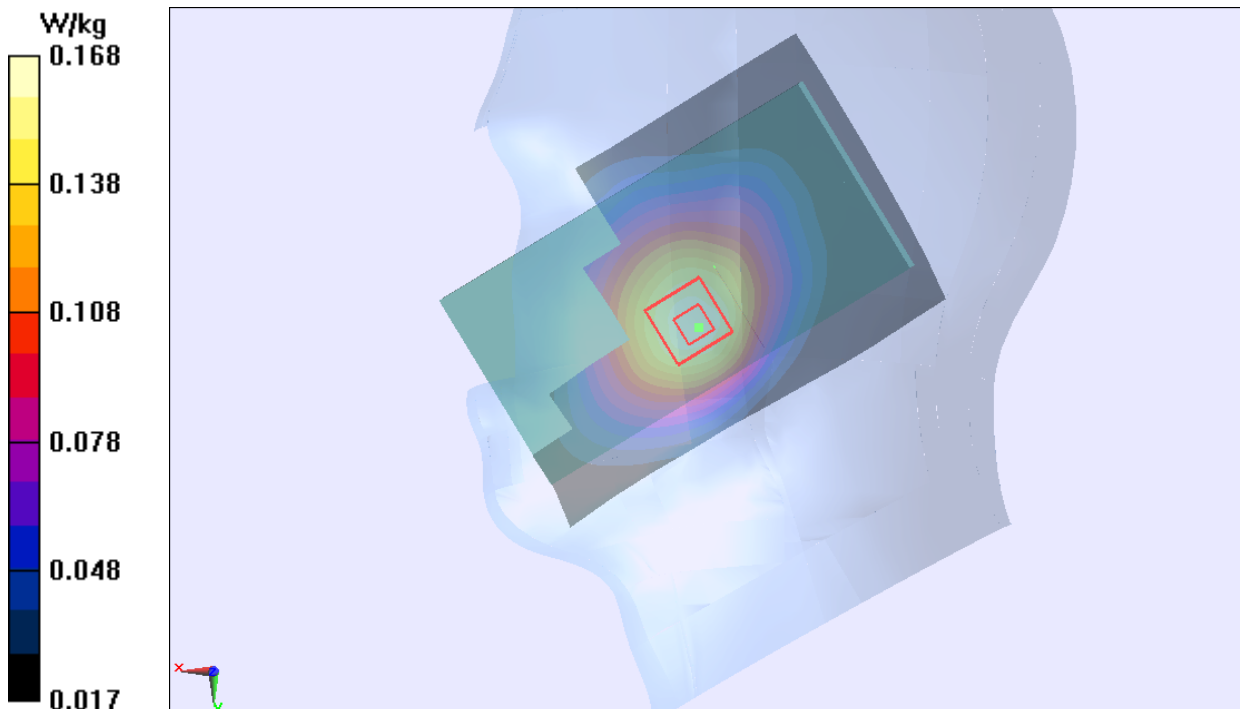

Figure 17 Right Hand Touch Cheek GSM 850 Channel 190

GSM 850 GPRS (4Txslots) Back Side High

Date/Time: 2013-12-19 18:54:49

Communication System: GPRS(4UP); Frequency: 848.8 MHz; Duty Cycle: 1:2.07491

Medium parameters used: $f = 849$ MHz; $\sigma = 0.984$ S/m; $\epsilon_r = 54.446$; $\rho = 1000$ kg/m³

Ambient Temperature: 22.3 °C Liquid Temperature: 21.5 °C

Phantom section: Flat Section

DASY5 Configuration:

Sensor-Surface: 4mm (Mechanical Surface Detection)

Probe: EX3DV4 - SN3753; ConvF(9.05, 9.05, 9.05); Calibrated: 2013-01-17

Electronics: DAE4 Sn1317; Calibrated: 2013-01-25

Phantom: SAM 1; Type: QD000P40CD; Serial: TP:1666

Measurement SW: DASY52, Version 52.8 (5); SEMCAD X Version 14.6.8 (7028)

Back Side High /Area Scan (61x111x1): Interpolated grid: dx=15 mm, dy=15 mm

Maximum value of SAR (interpolated) = 0.955 W/kg

Back Side High /Zoom Scan (5x5x7)/Cube 0: Measurement grid: dx=8mm, dy=8mm, dz=5mm

Reference Value = 29.493 V/m; Power Drift = 0.02 dB

Peak SAR (extrapolated) = 1.12 W/kg

SAR(1 g) = 0.887 W/kg; SAR(10 g) = 0.658 W/kg

Maximum value of SAR (measured) = 0.937 W/kg

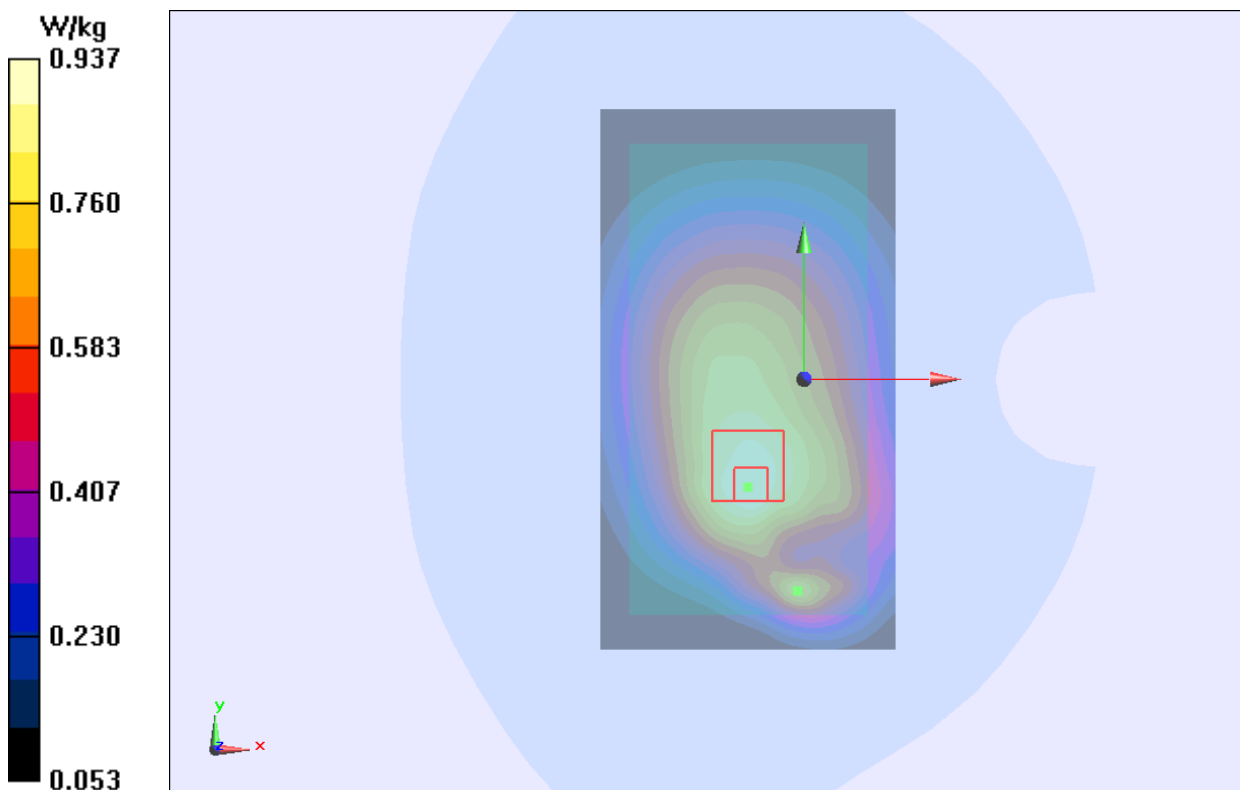

Figure 18 Body, Back Side, GSM 850 GPRS (4Txslots) Channel 251

GSM 850 GPRS (4Txslots) Back Side Middle

Date/Time: 2013-12-19 18:33:20

Communication System: GPRS(4UP); Frequency: 836.6 MHz; Duty Cycle: 1:2.07491

Medium parameters used: $f = 837$ MHz; $\sigma = 0.971$ S/m; $\epsilon_r = 54.509$; $\rho = 1000$ kg/m³

Ambient Temperature: 22.3 °C Liquid Temperature: 21.5°C

Phantom section: Flat Section

DASY5 Configuration:

Sensor-Surface: 4mm (Mechanical Surface Detection)

Probe: EX3DV4 - SN3753; ConvF(9.05, 9.05, 9.05); Calibrated: 2013-01-17

Electronics: DAE4 Sn1317; Calibrated: 2013-01-25

Phantom: SAM 1; Type: QD000P40CD; Serial: TP:1666

Measurement SW: DASY52, Version 52.8 (5); SEMCAD X Version 14.6.8 (7028)

Back Side Middle /Area Scan (61x111x1): Interpolated grid: dx=15 mm, dy=15 mm

Maximum value of SAR (interpolated) = 0.765 W/kg

Back Side Middle /Zoom Scan (5x5x7)/Cube 0: Measurement grid: dx=8mm, dy=8mm, dz=5mm

Reference Value = 26.823 V/m; Power Drift = 0.05 dB

Peak SAR (extrapolated) = 0.889 W/kg

SAR(1 g) = 0.716 W/kg; SAR(10 g) = 0.534 W/kg

Maximum value of SAR (measured) = 0.755 W/kg

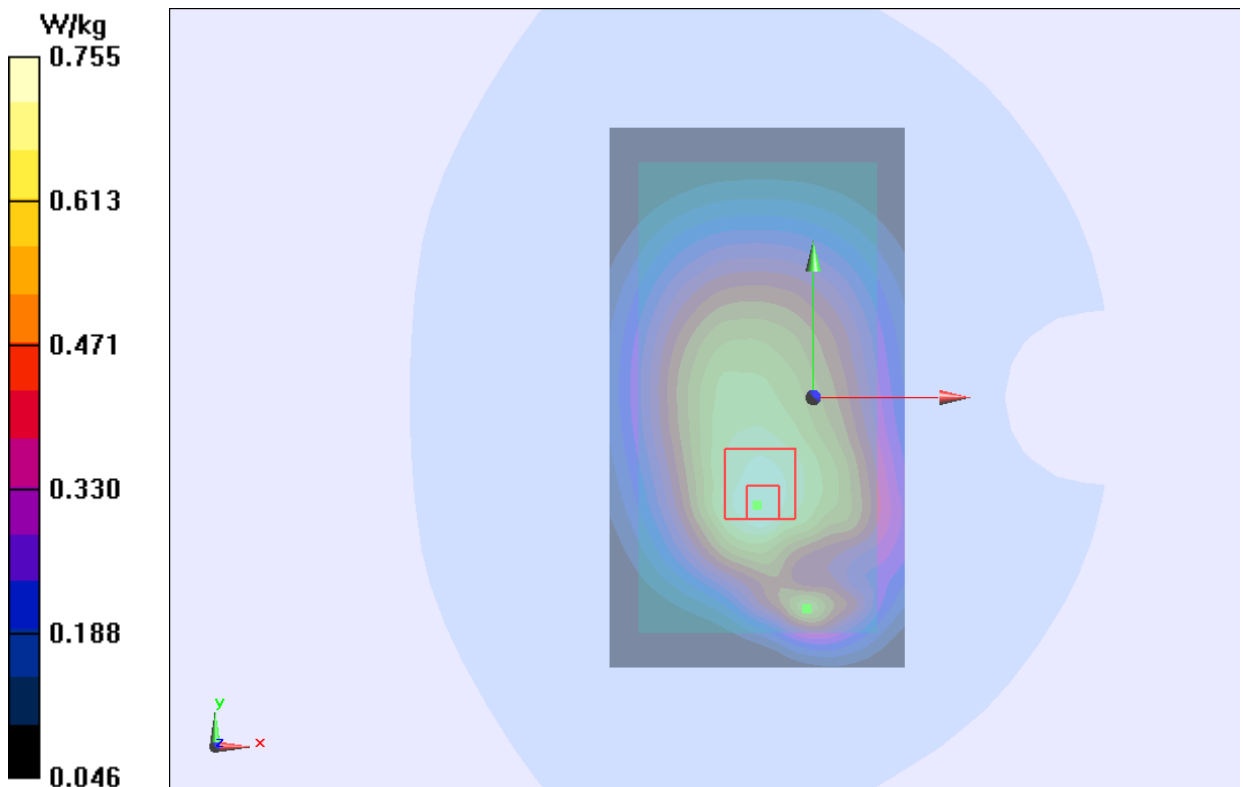

Figure 19 Body, Back Side, GSM 850 GPRS (4Txslots) Channel 190

GSM 850 GPRS (4Txslots) Back Side Low

Date/Time: 2013-12-19 19:12:23

Communication System: GPRS(4UP); Frequency: 824.2 MHz; Duty Cycle: 1:2.07491

Medium parameters used (interpolated): $f = 824.2$ MHz; $\sigma = 0.958$ S/m; $\epsilon_r = 54.668$; $\rho = 1000$ kg/m³

Ambient Temperature: 22.3 °C Liquid Temperature: 21.5°C

Phantom section: Flat Section

DASY5 Configuration:

Sensor-Surface: 4mm (Mechanical Surface Detection)

Probe: EX3DV4 - SN3753; ConvF(9.05, 9.05, 9.05); Calibrated: 2013-01-17

Electronics: DAE4 Sn1317; Calibrated: 2013-01-25

Phantom: SAM 1; Type: QD000P40CD; Serial: TP:1666

Measurement SW: DASY52, Version 52.8 (5); SEMCAD X Version 14.6.8 (7028)

Back Side Low /Area Scan (61x111x1): Interpolated grid: dx=15 mm, dy=15 mm

Maximum value of SAR (interpolated) = 0.570 W/kg

Back Side Low /Zoom Scan (5x5x7)/Cube 0: Measurement grid: dx=8mm, dy=8mm, dz=5mm

Reference Value = 23.516 V/m; Power Drift = -0.03 dB

Peak SAR (extrapolated) = 0.650 W/kg

SAR(1 g) = 0.530 W/kg; SAR(10 g) = 0.400 W/kg

Maximum value of SAR (measured) = 0.562 W/kg

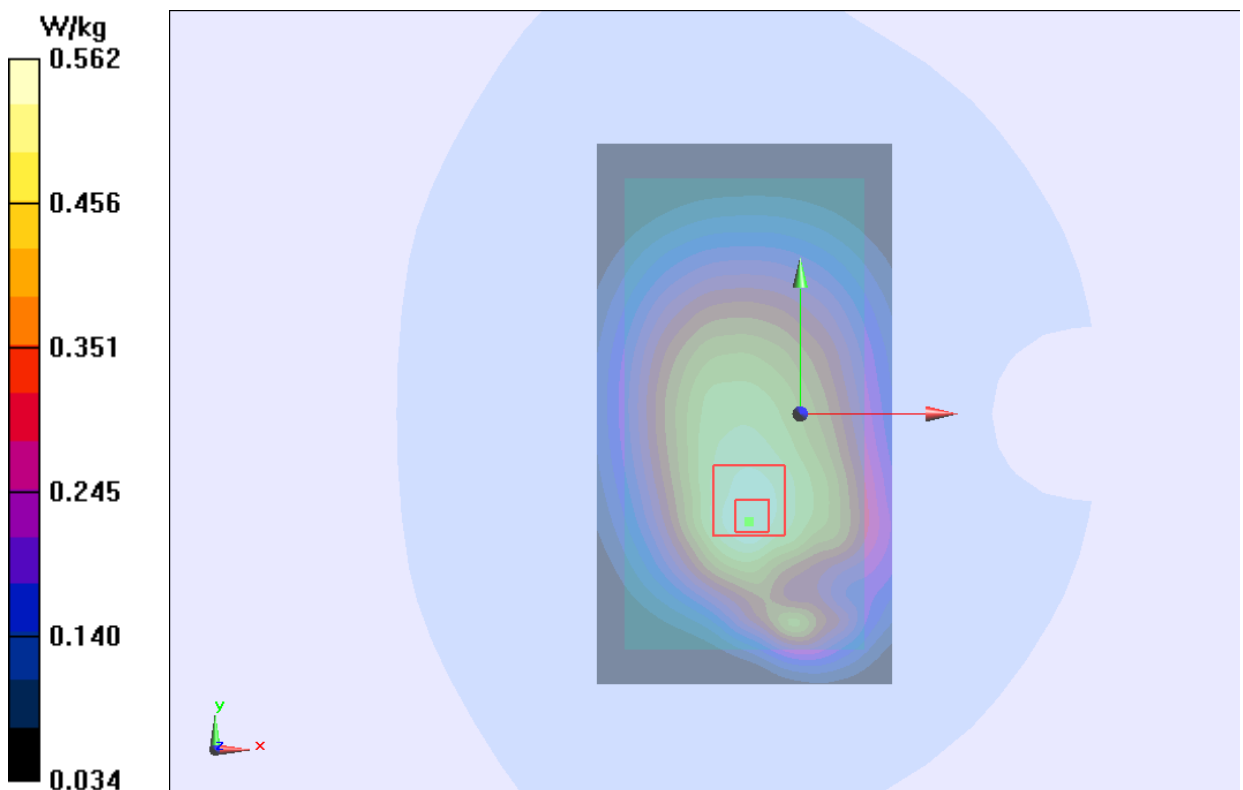

Figure 20 Body, Back Side, GSM 850 GPRS (4Txslots) Channel 128

GSM 850 GPRS (4Txslots) Front Side Middle

Date/Time: 2013-12-19 19:31:14

Communication System: GPRS(4UP); Frequency: 836.6 MHz; Duty Cycle: 1:2.07491

Medium parameters used: $f = 837$ MHz; $\sigma = 0.971$ S/m; $\epsilon_r = 54.509$; $\rho = 1000$ kg/m³

Ambient Temperature: 22.3 °C Liquid Temperature: 21.5 °C

Phantom section: Flat Section

DASY5 Configuration:

Sensor-Surface: 4mm (Mechanical Surface Detection)

Probe: EX3DV4 - SN3753; ConvF(9.05, 9.05, 9.05); Calibrated: 2013-01-17

Electronics: DAE4 Sn1317; Calibrated: 2013-01-25

Phantom: SAM 1; Type: QD000P40CD; Serial: TP:1666

Measurement SW: DASY52, Version 52.8 (5); SEMCAD X Version 14.6.8 (7028)

Front Side Middle /Area Scan (61x111x1): Interpolated grid: dx=15 mm, dy=15 mm

Maximum value of SAR (interpolated) = 0.492 W/kg

Front Side Middle /Zoom Scan (5x5x7)/Cube 0: Measurement grid: dx=8mm, dy=8mm, dz=5mm

Reference Value = 19.184 V/m; Power Drift = -0.02 dB

Peak SAR (extrapolated) = 0.689 W/kg

SAR(1 g) = 0.461 W/kg; SAR(10 g) = 0.328 W/kg

Maximum value of SAR (measured) = 0.488 W/kg

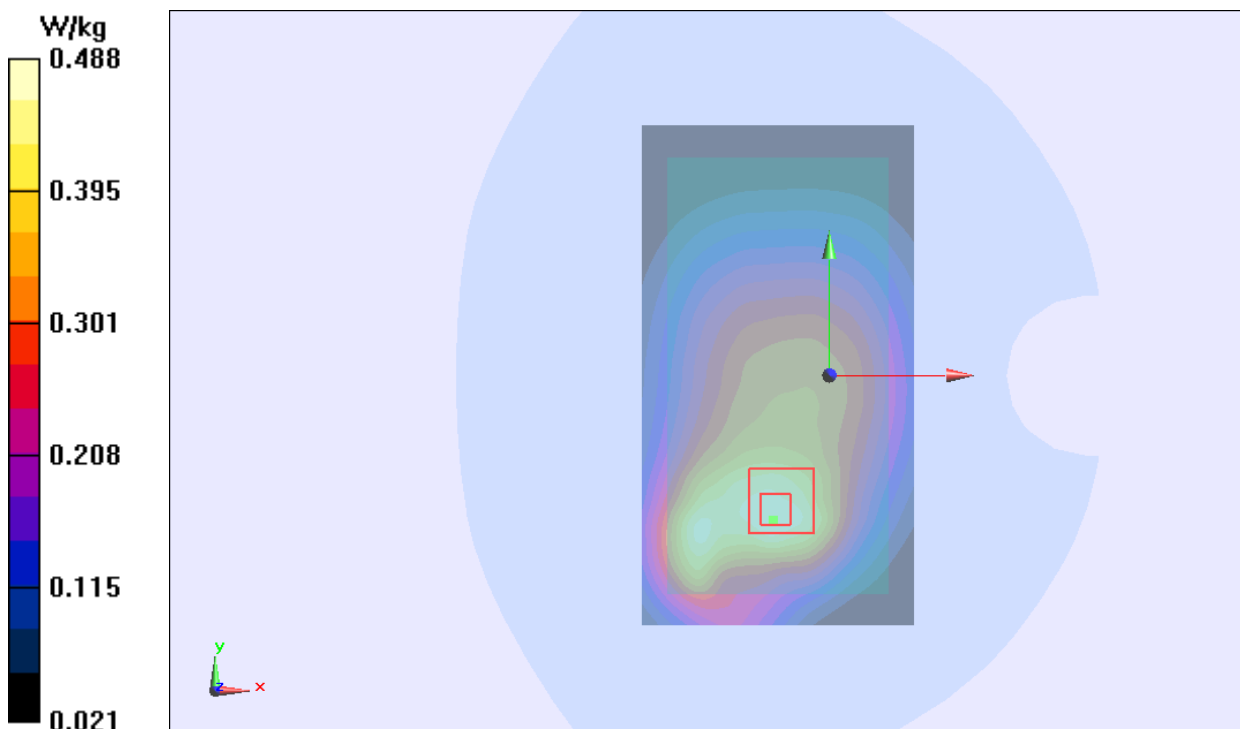

Figure 21 Body, Front Side, GSM 850 GPRS (4Txslots)Channel 190

GSM 850 GPRS (4Txslots) Left Edge Middle

Date/Time: 2013-12-19 20:11:33

Communication System: GPRS(4UP); Frequency: 836.6 MHz; Duty Cycle: 1:2.07491

Medium parameters used: $f = 837$ MHz; $\sigma = 0.971$ S/m; $\epsilon_r = 54.509$; $\rho = 1000$ kg/m³

Ambient Temperature: 22.3 °C Liquid Temperature: 21.5°C

Phantom section: Flat Section

DASY5 Configuration:

Sensor-Surface: 4mm (Mechanical Surface Detection)

Probe: EX3DV4 - SN3753; ConvF(9.05, 9.05, 9.05); Calibrated: 2013-01-17

Electronics: DAE4 Sn1317; Calibrated: 2013-01-25

Phantom: SAM 1; Type: QD000P40CD; Serial: TP:1666

Measurement SW: DASY52, Version 52.8 (5); SEMCAD X Version 14.6.8 (7028)

Left Edge Middle /Area Scan (31x111x1): Interpolated grid: dx=10 mm, dy=10 mm

Maximum value of SAR (interpolated) = 0.126 W/kg

Left Edge Middle /Zoom Scan (5x5x7)/Cube 0: Measurement grid: dx=8mm, dy=8mm, dz=5mm

Reference Value = 11.550 V/m; Power Drift = -0.001 dB

Peak SAR (extrapolated) = 0.157 W/kg

SAR(1 g) = 0.120 W/kg; SAR(10 g) = 0.083 W/kg

Maximum value of SAR (measured) = 0.128 W/kg

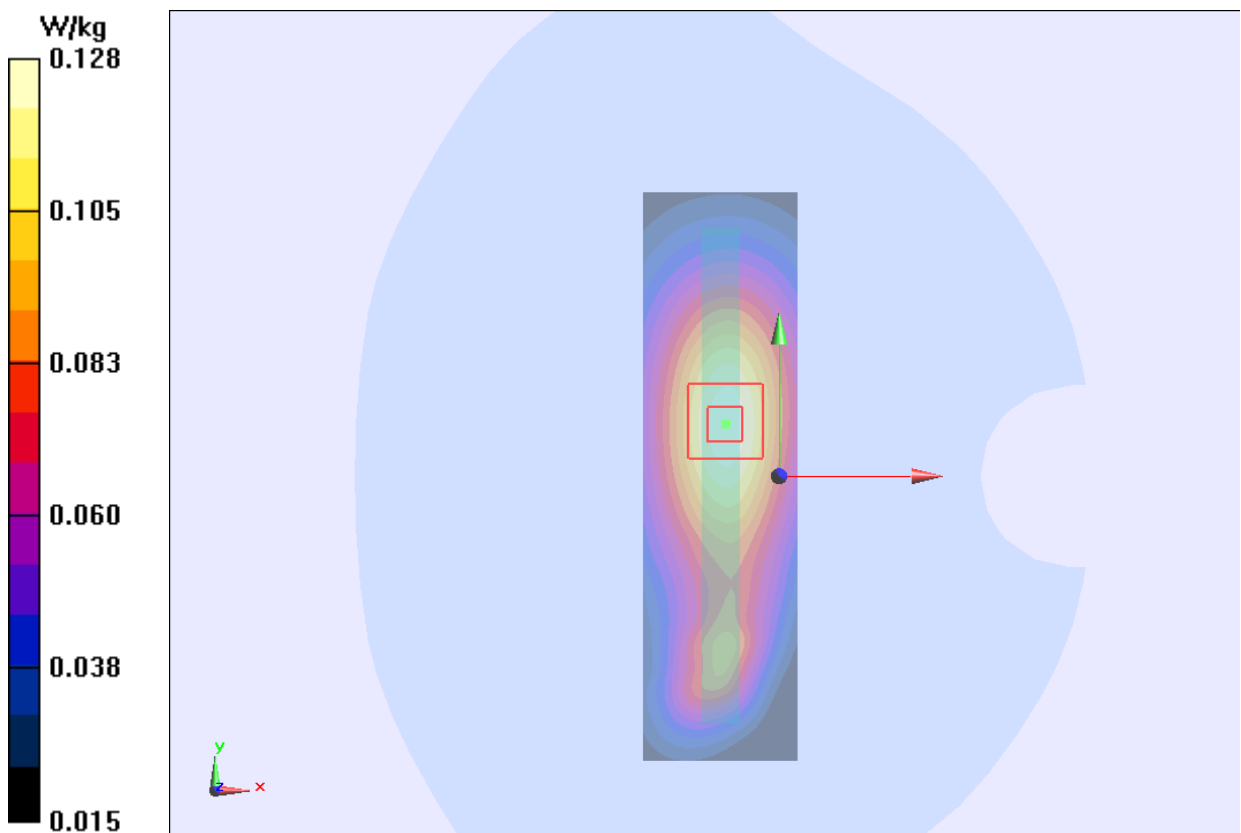

Figure 22 Body, Left Edge, GSM 850 GPRS (4Txslots)Channel 190

GSM 850 GPRS (4Txslots) Right Edge Middle

Date/Time: 2013-12-19 20:27:11

Communication System: GPRS(4UP); Frequency: 836.6 MHz; Duty Cycle: 1:2.07491

Medium parameters used: $f = 837$ MHz; $\sigma = 0.971$ S/m; $\epsilon_r = 54.509$; $\rho = 1000$ kg/m³

Ambient Temperature: 22.3 °C Liquid Temperature: 21.5°C

Phantom section: Flat Section

DASY5 Configuration:

Sensor-Surface: 4mm (Mechanical Surface Detection)

Probe: EX3DV4 - SN3753; ConvF(9.05, 9.05, 9.05); Calibrated: 2013-01-17

Electronics: DAE4 Sn1317; Calibrated: 2013-01-25

Phantom: SAM 1; Type: QD000P40CD; Serial: TP:1666

Measurement SW: DASY52, Version 52.8 (5); SEMCAD X Version 14.6.8 (7028)

Right Edge Middle /Area Scan (31x111x1): Interpolated grid: dx=10 mm, dy=10 mm

Maximum value of SAR (interpolated) = 0.294 W/kg

Right Edge Middle /Zoom Scan (5x5x7)/Cube 0: Measurement grid: dx=8mm, dy=8mm, dz=5mm

Reference Value = 18.106 V/m; Power Drift = 0.02 dB

Peak SAR (extrapolated) = 0.360 W/kg

SAR(1 g) = 0.275 W/kg; SAR(10 g) = 0.193 W/kg

Maximum value of SAR (measured) = 0.294 W/kg

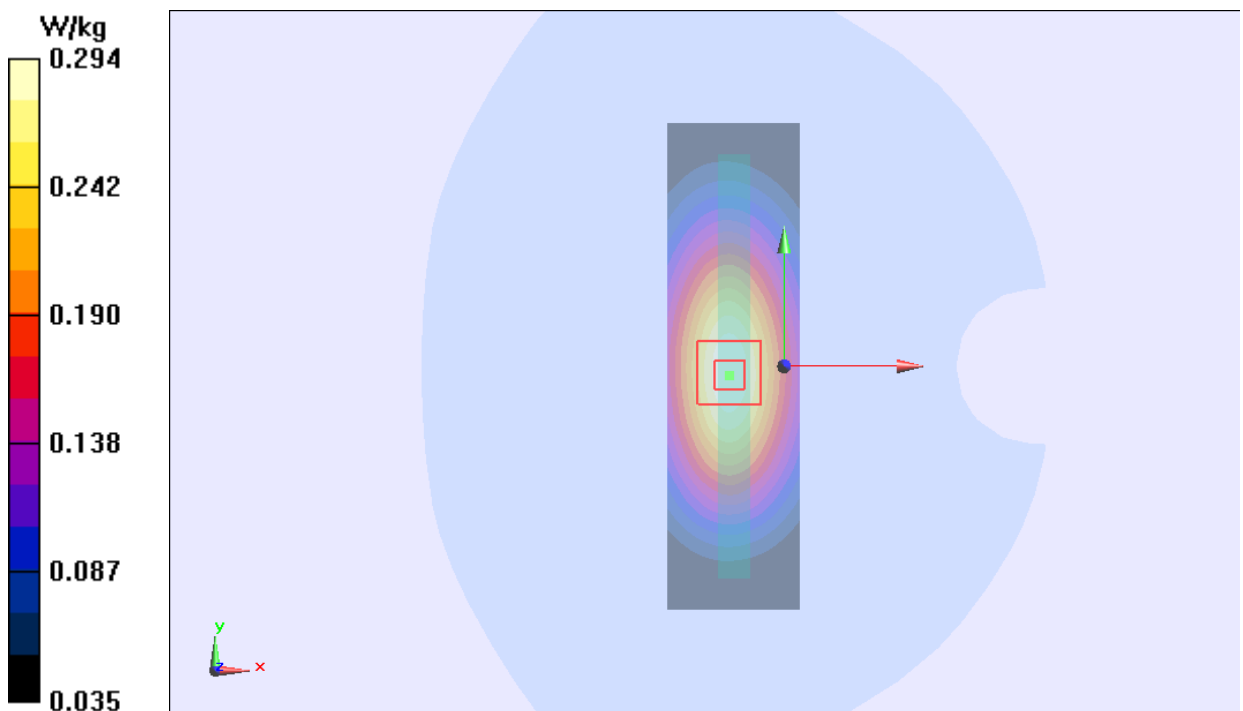

Figure 23 Body, Right Edge, GSM 850 GPRS (4Txslots)Channel 190

GSM 850 GPRS (4Txslots) Bottom Edge Middle

Date/Time: 2013-12-19 20:50:59

Communication System: GPRS(4UP); Frequency: 836.6 MHz; Duty Cycle: 1:2.07491

Medium parameters used: $f = 837$ MHz; $\sigma = 0.971$ S/m; $\epsilon_r = 54.509$; $\rho = 1000$ kg/m³

Ambient Temperature: 22.3 °C Liquid Temperature: 21.5°C

Phantom section: Flat Section

DASY5 Configuration:

Sensor-Surface: 4mm (Mechanical Surface Detection)

Probe: EX3DV4 - SN3753; ConvF(9.05, 9.05, 9.05); Calibrated: 2013-01-17

Electronics: DAE4 Sn1317; Calibrated: 2013-01-25

Phantom: SAM 1; Type: QD000P40CD; Serial: TP:1666

Measurement SW: DASY52, Version 52.8 (5); SEMCAD X Version 14.6.8 (7028)

Bottom Edge Middle /Area Scan (31x71x1): Interpolated grid: dx=10 mm, dy=10 mm

Maximum value of SAR (interpolated) = 0.152 W/kg

Bottom Edge Middle /Zoom Scan (5x5x7)/Cube 0: Measurement grid: dx=8mm, dy=8mm, dz=5mm

Reference Value = 12.553 V/m; Power Drift = -0.10 dB

Peak SAR (extrapolated) = 0.241 W/kg

SAR(1 g) = 0.137 W/kg; SAR(10 g) = 0.089 W/kg

Maximum value of SAR (measured) = 0.147 W/kg

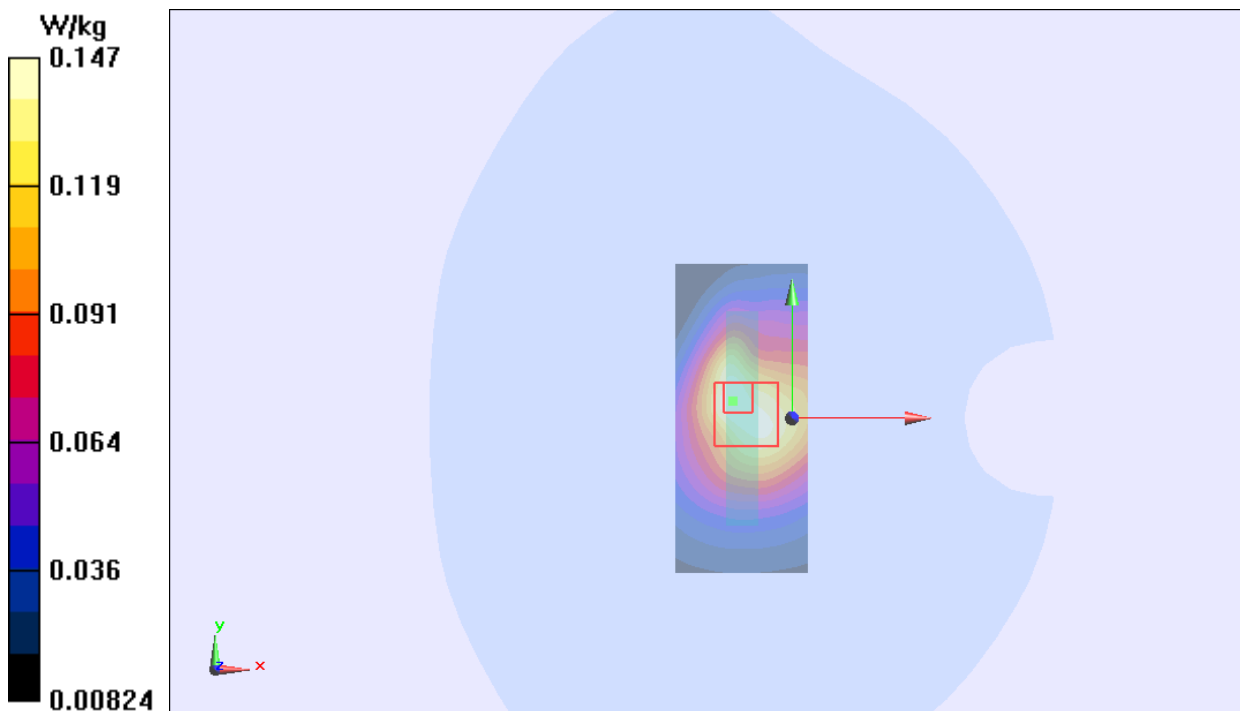

Figure 24 Body, Bottom Edge, GSM 850 GPRS (4Txslots)annel 190

GSM 850 EGPRS (4Txslots) Back Side High

Date/Time: 2013-12-19 22:40:24

Communication System: GPRS(4UP); Frequency: 848.8 MHz; Duty Cycle: 1:2.07491

Medium parameters used: $f = 849$ MHz; $\sigma = 0.984$ S/m; $\epsilon_r = 54.446$; $\rho = 1000$ kg/m³

Ambient Temperature: 22.3 °C Liquid Temperature: 21.5°C

Phantom section: Flat Section

DASY5 Configuration:

Sensor-Surface: 4mm (Mechanical Surface Detection)

Probe: EX3DV4 - SN3753; ConvF(9.05, 9.05, 9.05); Calibrated: 2013-01-17

Electronics: DAE4 Sn1317; Calibrated: 2013-01-25

Phantom: SAM 1; Type: QD000P40CD; Serial: TP:1666

Measurement SW: DASY52, Version 52.8 (5); SEMCAD X Version 14.6.8 (7028)

Back Side High /Area Scan (61x111x1): Interpolated grid: dx=15 mm, dy=15 mm

Maximum value of SAR (interpolated) = 0.974 W/kg

Back Side High /Zoom Scan (5x5x7)/Cube 0: Measurement grid: dx=8mm, dy=8mm, dz=5mm

Reference Value = 30.542 V/m; Power Drift = 0.02 dB

Peak SAR (extrapolated) = 1.18 W/kg

SAR(1 g) = 0.940 W/kg; SAR(10 g) = 0.695 W/kg

Maximum value of SAR (measured) = 0.989 W/kg

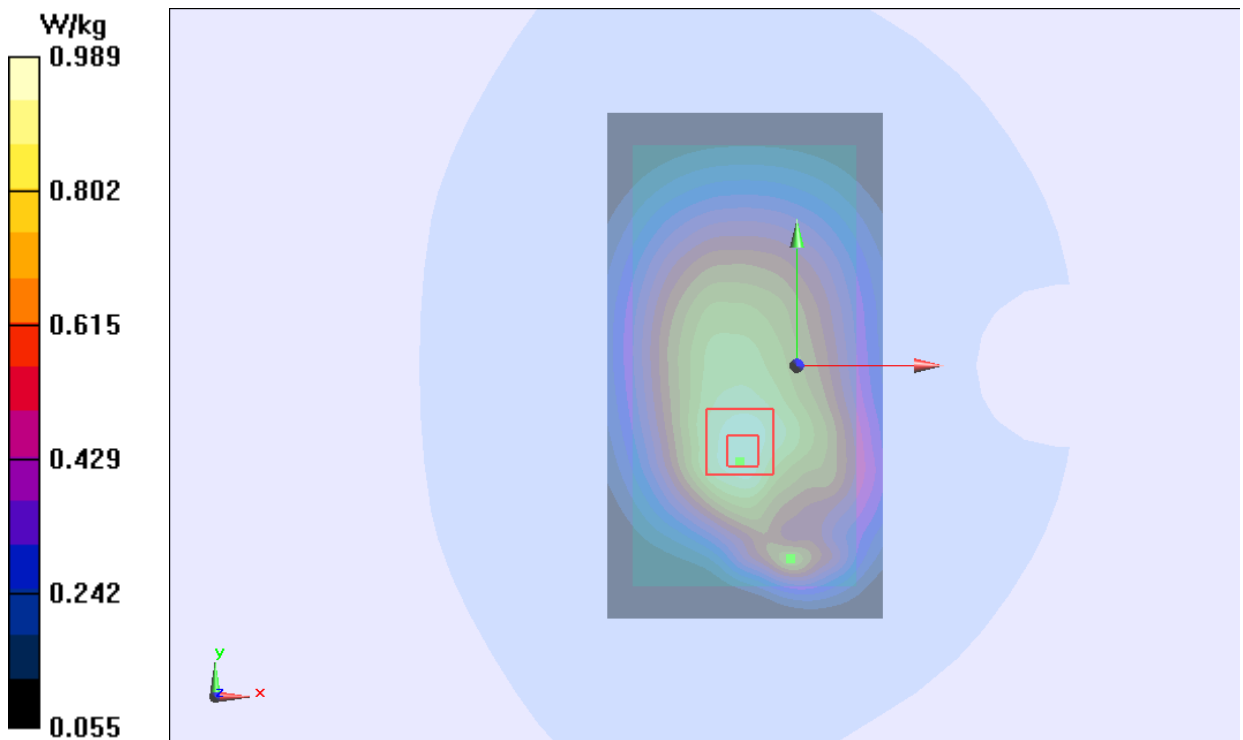

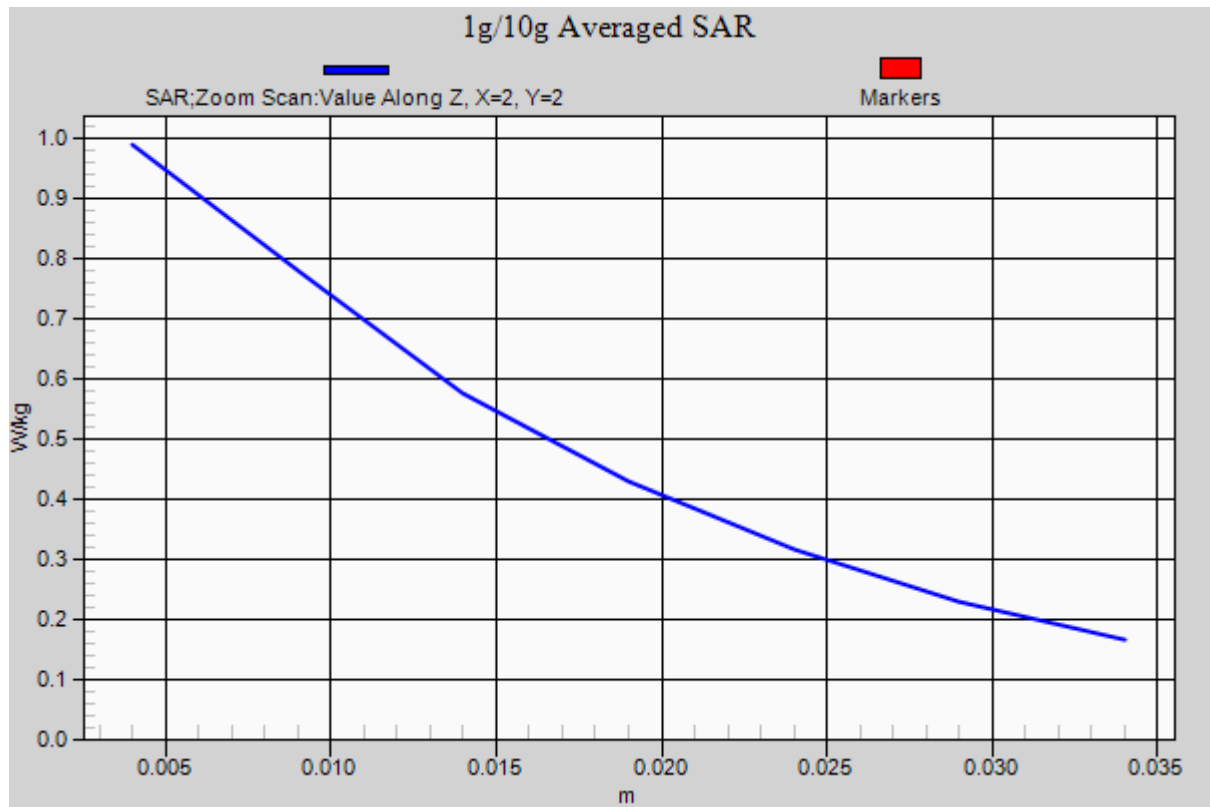

Figure 25 Body, Back Side, GSM 850 EGPRS (4Txslots) Channel 251

GSM 850 GPRS (4Txslots) Back Side High (SIM2)

Date/Time: 2013-12-19 21:43:09

Communication System: GPRS(4UP); Frequency: 848.8 MHz; Duty Cycle: 1:2.07491

Medium parameters used: $f = 849$ MHz; $\sigma = 0.984$ S/m; $\epsilon_r = 54.446$; $\rho = 1000$ kg/m³

Ambient Temperature: 22.3 °C Liquid Temperature: 21.5°C

Phantom section: Flat Section

DASY5 Configuration:

Sensor-Surface: 4mm (Mechanical Surface Detection)

Probe: EX3DV4 - SN3753; ConvF(9.05, 9.05, 9.05); Calibrated: 2013-01-17

Electronics: DAE4 Sn1317; Calibrated: 2013-01-25

Phantom: SAM 1; Type: QD000P40CD; Serial: TP:1666

Measurement SW: DASY52, Version 52.8 (5); SEMCAD X Version 14.6.8 (7028)

Back Side High /Area Scan (61x111x1): Interpolated grid: dx=15 mm, dy=15 mm

Maximum value of SAR (interpolated) = 0.902 W/kg

Back Side High /Zoom Scan (5x5x7)/Cube 0: Measurement grid: dx=8mm, dy=8mm, dz=5mm

Reference Value = 29.831 V/m; Power Drift = -0.03 dB

Peak SAR (extrapolated) = 1.08 W/kg

SAR(1 g) = 0.863 W/kg; SAR(10 g) = 0.640 W/kg

Maximum value of SAR (measured) = 0.913 W/kg

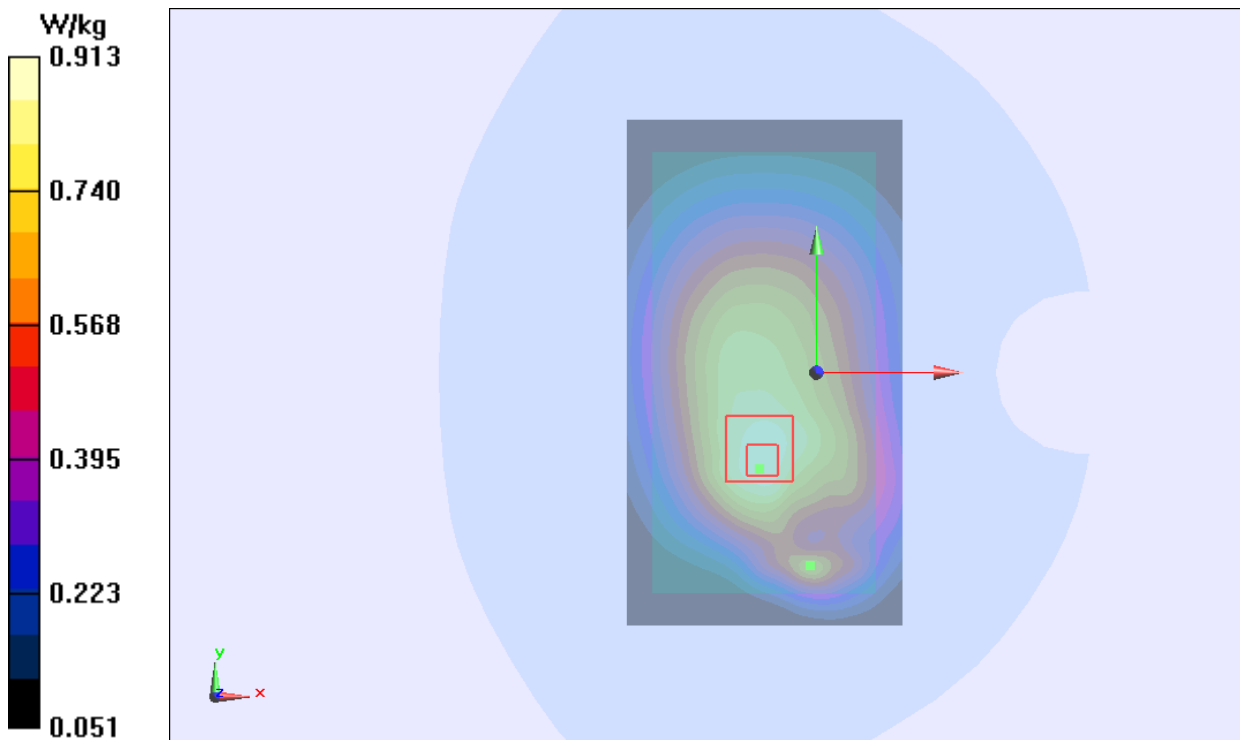

Figure 26 Body, Back Side, GSM 850 GPRS (4Txslots) Channel 251

GSM 850 GPRS (4Txslots) Back Side High (1st repeated SAR)

Date/Time: 2013-12-19 21:24:35
 Communication System: GPRS(4UP); Frequency: 848.8 MHz; Duty Cycle: 1:2.07491
 Medium parameters used: $f = 849$ MHz; $\sigma = 0.984$ S/m; $\epsilon_r = 54.446$; $\rho = 1000$ kg/m³
 Ambient Temperature: 22.3 °C Liquid Temperature: 21.5°C
 Phantom section: Flat Section
 DASY5 Configuration:
 Sensor-Surface: 4mm (Mechanical Surface Detection)
 Probe: EX3DV4 - SN3753; ConvF(9.05, 9.05, 9.05); Calibrated: 2013-01-17
 Electronics: DAE4 Sn1317; Calibrated: 2013-01-25
 Phantom: SAM 1; Type: QD000P40CD; Serial: TP:1666
 Measurement SW: DASY52, Version 52.8 (5); SEMCAD X Version 14.6.8 (7028)

Back Side High /Area Scan (61x111x1): Interpolated grid: dx=15 mm, dy=15 mm
 Maximum value of SAR (interpolated) = 0.894 W/kg

Back Side High /Zoom Scan (5x5x7)/Cube 0: Measurement grid: dx=8mm, dy=8mm, dz=5mm
 Reference Value = 29.484 V/m; Power Drift = -0.03 dB

Peak SAR (extrapolated) = 1.06 W/kg
SAR(1 g) = 0.846 W/kg; SAR(10 g) = 0.630 W/kg
 Maximum value of SAR (measured) = 0.894 W/kg

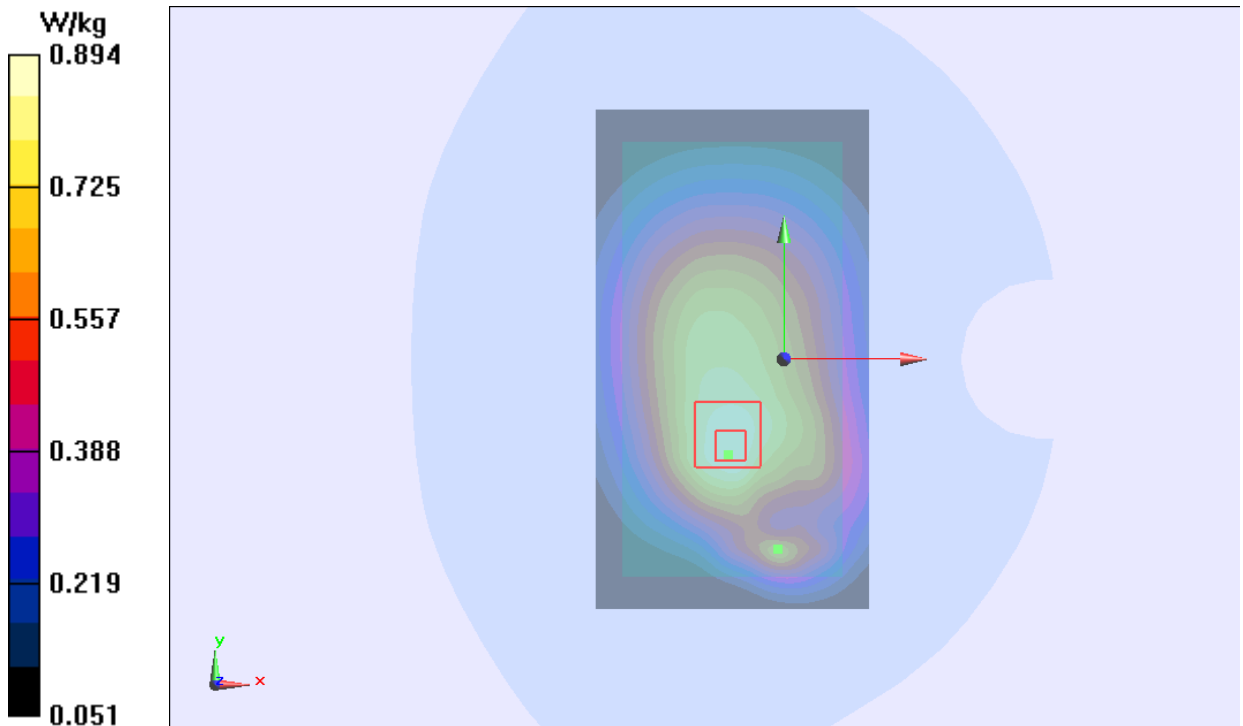

Figure 27 Body, Back Side, GSM 850 GPRS (4Txslots) Channel 251

GSM 1900 Left Cheek Middle

Date/Time: 2013-12-10 15:33:14

Communication System: GSM; Frequency: 1880 MHz; Duty Cycle: 1:8.30042

Medium parameters used: $f = 1880$ MHz; $\sigma = 1.408$ S/m; $\epsilon_r = 39.625$; $\rho = 1000$ kg/m³

Ambient Temperature: 22.3 °C Liquid Temperature: 21.5°C

Phantom section: Left Section

DASY5 Configuration:

Sensor-Surface: 4mm (Mechanical Surface Detection)

Probe: EX3DV4 - SN3753; ConvF(7.63, 7.63, 7.63); Calibrated: 2013-01-17

Electronics: DAE4 Sn1317; Calibrated: 2013-01-25

Phantom: SAM 2; Type: QD000P40CD; Serial: TP1667

Measurement SW: DASY52, Version 52.8 (5); SEMCAD X Version 14.6.8 (7028)

Left Cheek Middle /Area Scan (71x111x1): Interpolated grid: dx=15 mm, dy=15 mm

Maximum value of SAR (interpolated) = 0.260 W/kg

Left Cheek Middle /Zoom Scan (5x5x7)/Cube 0: Measurement grid: dx=8mm, dy=8mm, dz=5mm

Reference Value = 5.325 V/m; Power Drift = 0.032 dB

Peak SAR (extrapolated) = 0.350 W/kg

SAR(1 g) = 0.235 W/kg; SAR(10 g) = 0.142 W/kg

Maximum value of SAR (measured) = 0.257 W/kg

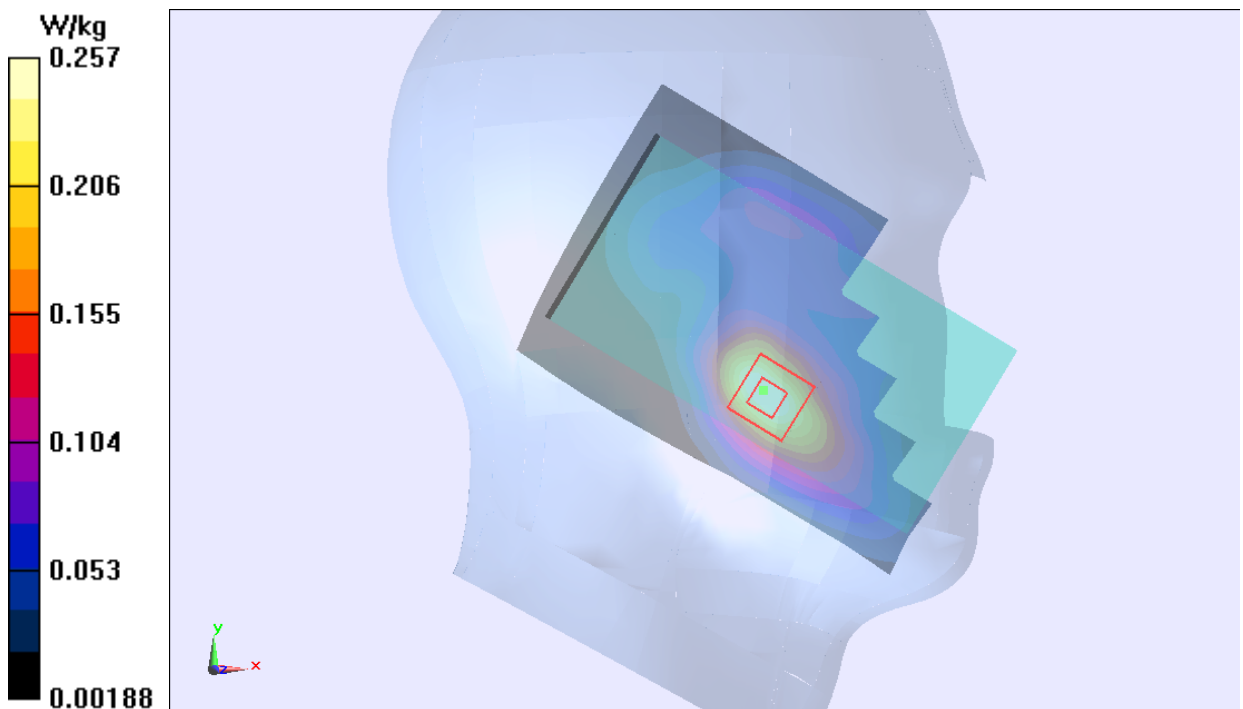

Figure 28 Left Hand Touch Cheek GSM 1900 Channel 661

GSM 1900 Left Tilt Middle

Date/Time: 2013-12-10 23:02:33

Communication System: GSM; Frequency: 1880 MHz; Duty Cycle: 1:8.30042

Medium parameters used: $f = 1880$ MHz; $\sigma = 1.408$ S/m; $\epsilon_r = 39.625$; $\rho = 1000$ kg/m³

Ambient Temperature: 22.3 °C Liquid Temperature: 21.5°C

Phantom section: Left Section

DASY5 Configuration:

Sensor-Surface: 4mm (Mechanical Surface Detection)

Probe: EX3DV4 - SN3753; ConvF(7.63, 7.63, 7.63); Calibrated: 2013-01-17

Electronics: DAE4 Sn1317; Calibrated: 2013-01-25

Phantom: SAM 2; Type: QD000P40CD; Serial: TP1667

Measurement SW: DASY52, Version 52.8 (5); SEMCAD X Version 14.6.8 (7028)

Left Tilt Middle /Area Scan (71x111x1): Interpolated grid: dx=15 mm, dy=15 mm

Maximum value of SAR (interpolated) = 0.147 W/kg

Left Tilt Middle /Zoom Scan (5x5x7)/Cube 0: Measurement grid: dx=8mm, dy=8mm, dz=5mm

Reference Value = 10.095 V/m; Power Drift = -0.15 dB

Peak SAR (extrapolated) = 0.182 W/kg

SAR(1 g) = 0.124 W/kg; SAR(10 g) = 0.072 W/kg

Maximum value of SAR (measured) = 0.137 W/kg

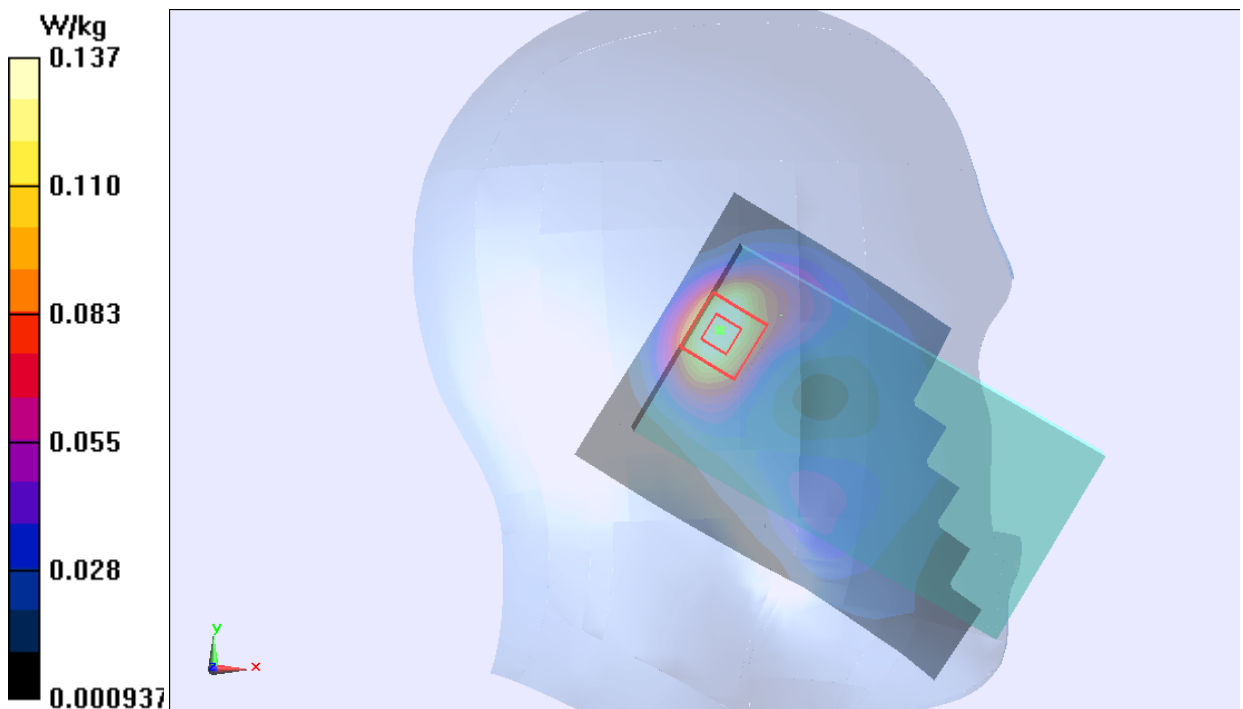

Figure 29 Left Hand Tilt 15° GSM 1900 Channel 661

GSM 1900 Right Cheek Middle

Date/Time: 2013-12-10 14:37:17

Communication System: GSM; Frequency: 1880 MHz; Duty Cycle: 1:8.30042

Medium parameters used: $f = 1880$ MHz; $\sigma = 1.408$ S/m; $\epsilon_r = 39.625$; $\rho = 1000$ kg/m³

Ambient Temperature: 22.3 °C Liquid Temperature: 21.5°C

Phantom section: Right Section

DASY5 Configuration:

Sensor-Surface: 4mm (Mechanical Surface Detection)

Probe: EX3DV4 - SN3753; ConvF(7.63, 7.63, 7.63); Calibrated: 2013-01-17

Electronics: DAE4 Sn1317; Calibrated: 2013-01-25

Phantom: SAM 2; Type: QD000P40CD; Serial: TP1667

Measurement SW: DASY52, Version 52.8 (5); SEMCAD X Version 14.6.8 (7028)

Right Cheek Middle /Area Scan (71x111x1): Interpolated grid: dx=15 mm, dy=15 mm

Maximum value of SAR (interpolated) = 0.208 W/kg

Right Cheek Middle /Zoom Scan (5x5x7)/Cube 0: Measurement grid: dx=8mm, dy=8mm, dz=5mm

Reference Value = 4.042 V/m; Power Drift = 0.12 dB

Peak SAR (extrapolated) = 0.269 W/kg

SAR(1 g) = 0.182 W/kg; SAR(10 g) = 0.108 W/kg

Maximum value of SAR (measured) = 0.202 W/kg

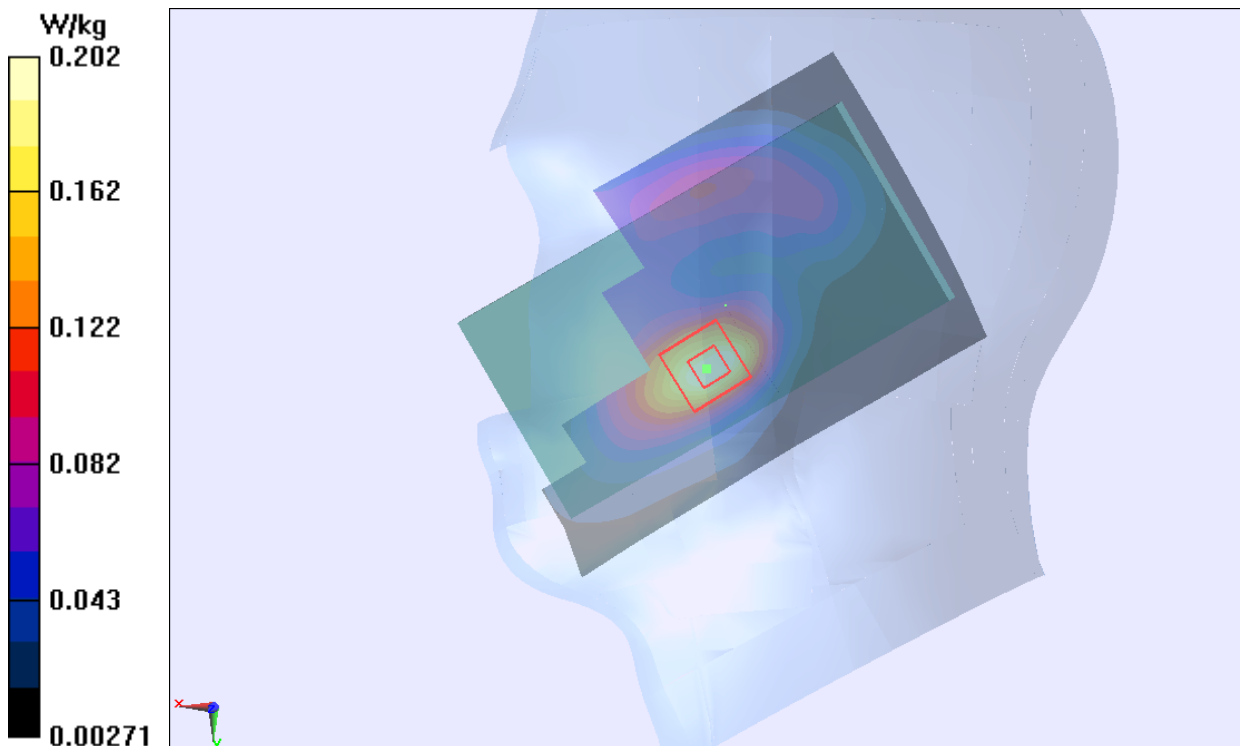

Figure 30 Right Hand Touch Cheek GSM 1900 Channel 661

GSM 1900 Right Tilt Middle

Date/Time: 2013-12-10 15:07:46

Communication System: GSM; Frequency: 1880 MHz; Duty Cycle: 1:8.30042

Medium parameters used: $f = 1880$ MHz; $\sigma = 1.408$ S/m; $\epsilon_r = 39.625$; $\rho = 1000$ kg/m³

Ambient Temperature: 22.3 °C Liquid Temperature: 21.5°C

Phantom section: Right Section

DASY5 Configuration:

Sensor-Surface: 4mm (Mechanical Surface Detection)

Probe: EX3DV4 - SN3753; ConvF(7.63, 7.63, 7.63); Calibrated: 2013-01-17

Electronics: DAE4 Sn1317; Calibrated: 2013-01-25

Phantom: SAM 2; Type: QD000P40CD; Serial: TP1667

Measurement SW: DASY52, Version 52.8 (5); SEMCAD X Version 14.6.8 (7028)

Right Tilt Middle /Area Scan (71x111x1): Interpolated grid: dx=15 mm, dy=15 mm

Maximum value of SAR (interpolated) = 0.145 W/kg

Right Tilt Middle /Zoom Scan (5x5x7)/Cube 0: Measurement grid: dx=8mm, dy=8mm, dz=5mm

Reference Value = 7.176 V/m; Power Drift = 0.030 dB

Peak SAR (extrapolated) = 0.192 W/kg

SAR(1 g) = 0.130 W/kg; SAR(10 g) = 0.075 W/kg

Maximum value of SAR (measured) = 0.144 W/kg

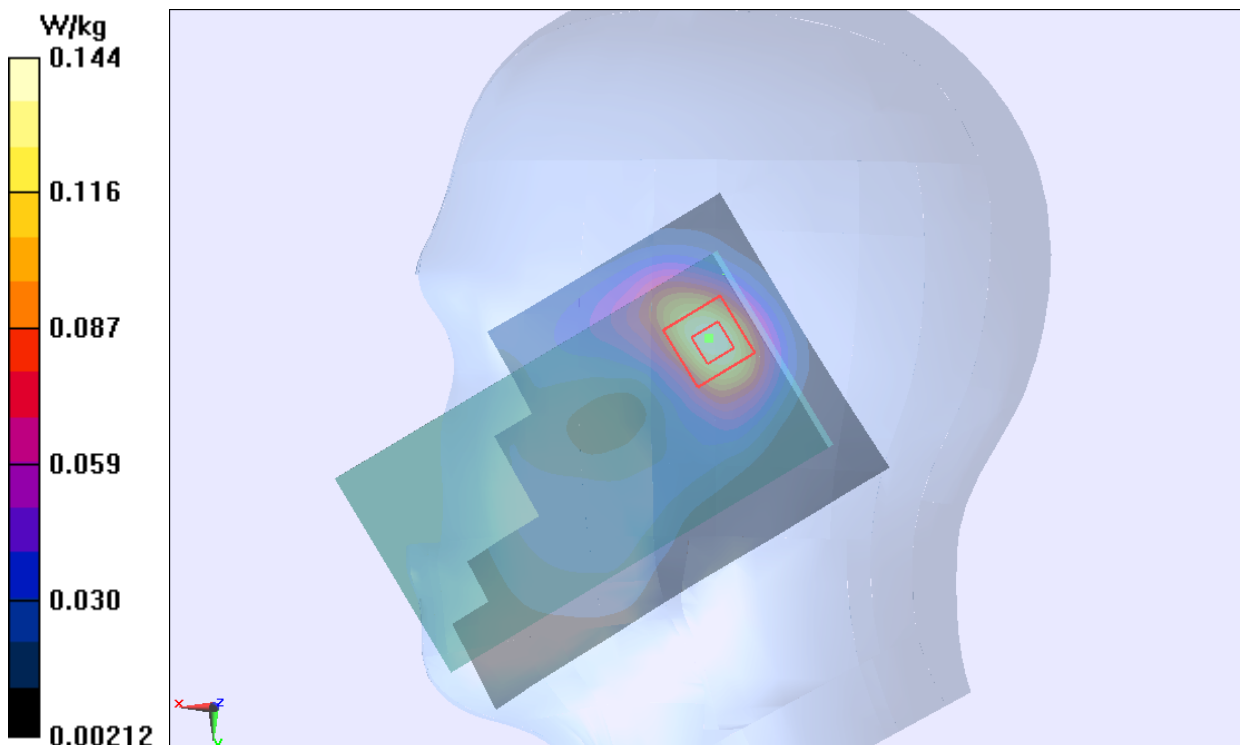

Figure 31 Right Hand Tilt 15° GSM 1900 Channel 661

GSM 1900 Left Cheek Middle(SIM 2)

Date/Time: 2013-12-10 22:43:49

Communication System: GSM; Frequency: 1880 MHz;Duty Cycle: 1:8.30042

Medium parameters used: $f = 1880$ MHz; $\sigma = 1.408$ S/m; $\epsilon_r = 39.625$; $\rho = 1000$ kg/m³

Ambient Temperature:22.3 °C Liquid Temperature: 21.5°C

Phantom section: Left Section

DASY5 Configuration:

Sensor-Surface: 4mm (Mechanical Surface Detection)

Probe: EX3DV4 - SN3753; ConvF(7.63, 7.63, 7.63); Calibrated: 2013-01-17

Electronics: DAE4 Sn1317; Calibrated: 2013-01-25

Phantom: SAM 2; Type: QD000P40CD; Serial: TP1667

Measurement SW: DASY52, Version 52.8 (5); SEMCAD X Version 14.6.8 (7028)

Left Cheek Middle /Area Scan (71x111x1): Interpolated grid: dx=15 mm, dy=15 mm

Maximum value of SAR (interpolated) = 0.287 W/kg

Left Cheek Middle /Zoom Scan (5x5x7)/Cube 0: Measurement grid: dx=8mm, dy=8mm, dz=5mm

Reference Value = 6.150 V/m; Power Drift = 0.043 dB

Peak SAR (extrapolated) = 0.379 W/kg

SAR(1 g) = 0.258 W/kg; SAR(10 g) = 0.157 W/kg

Maximum value of SAR (measured) = 0.280 W/kg

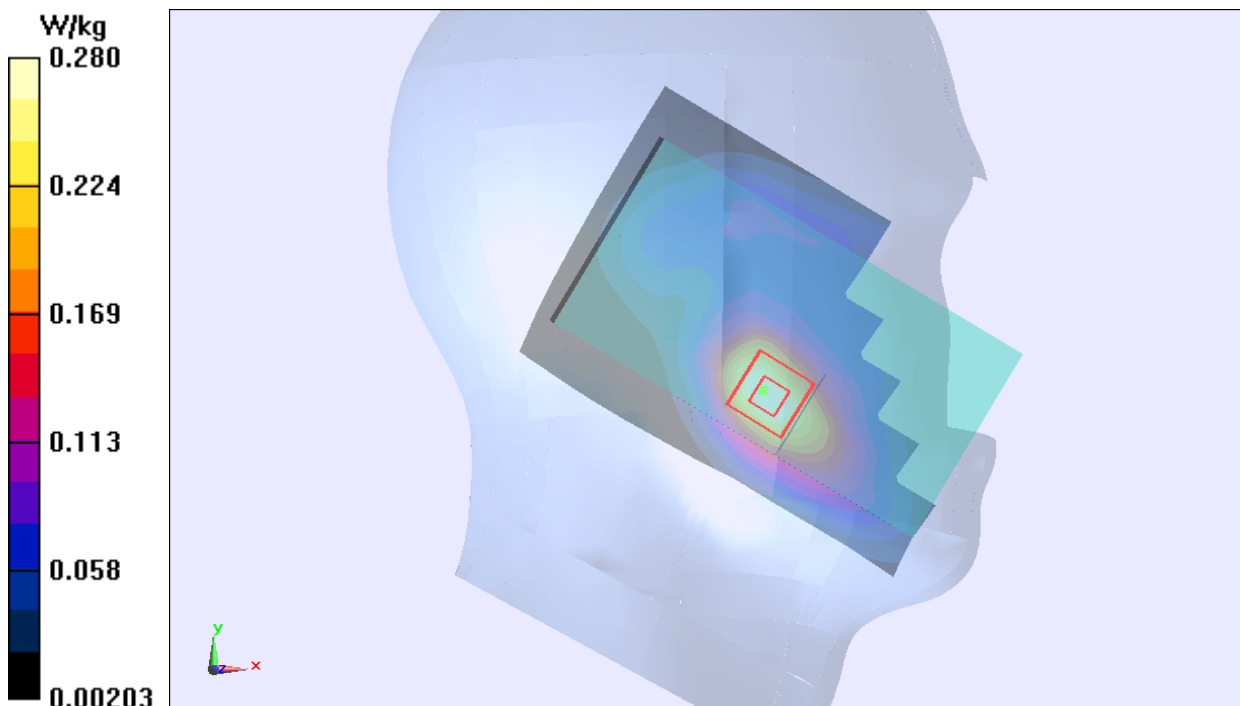

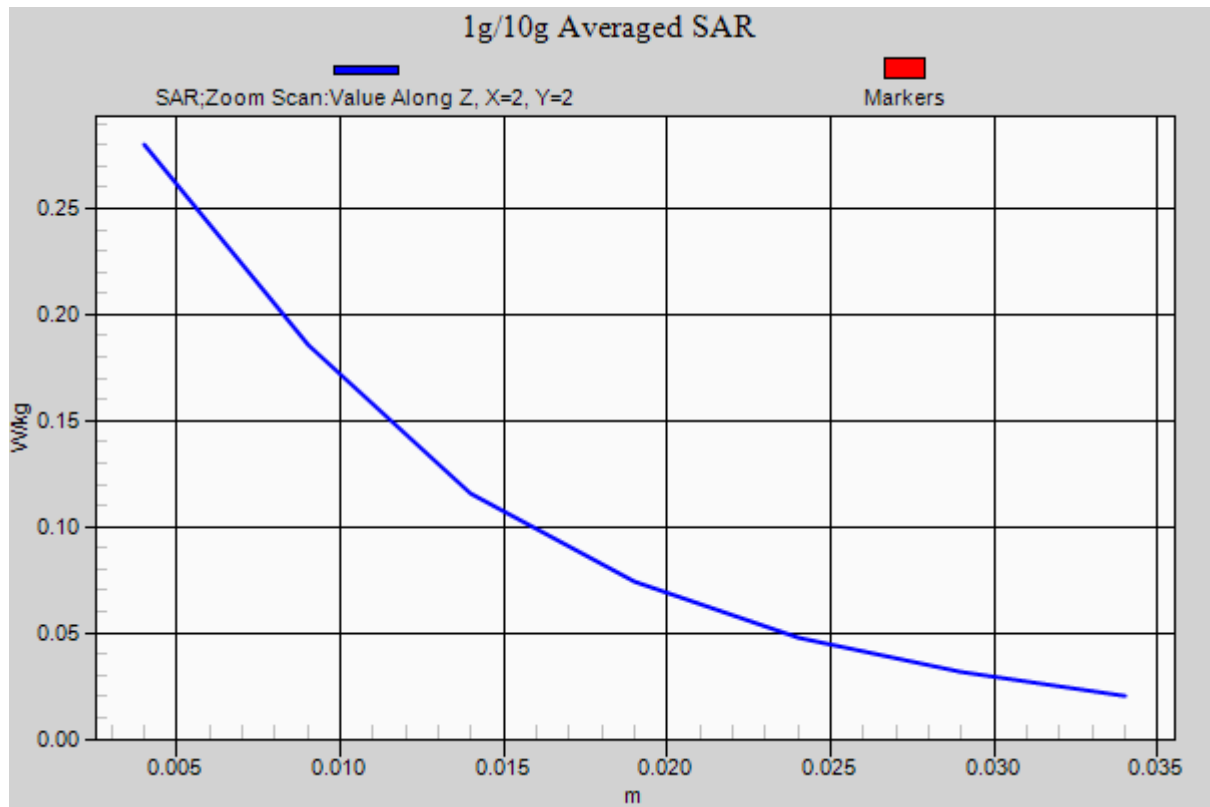

Figure 32 Left Hand Touch Cheek GSM 1900 Channel 661

GSM 1900 GPRS (4Txslots) Back Side Middle

Date/Time: 2013-12-23 10:13:50

Communication System: GPRS(4UP); Frequency: 1880 MHz; Duty Cycle: 1:2.07491

Medium parameters used: $f = 1880$ MHz; $\sigma = 1.508$ S/m; $\epsilon_r = 52.874$; $\rho = 1000$ kg/m³

Ambient Temperature: 22.3 °C Liquid Temperature: 21.5 °C

Phantom section: Flat Section

DASY5 Configuration:

Sensor-Surface: 4mm (Mechanical Surface Detection)

Probe: EX3DV4 - SN3753; ConvF(7.33, 7.33, 7.33); Calibrated: 2013-01-17

Electronics: DAE4 Sn1317; Calibrated: 2013-01-25

Phantom: SAM 2; Type: QD000P40CD; Serial: TP1667

Measurement SW: DASY52, Version 52.8 (5); SEMCAD X Version 14.6.8 (7028)

Back Side Middle /Area Scan (61x111x1): Interpolated grid: dx=15 mm, dy=15 mm

Maximum value of SAR (interpolated) = 0.536 W/kg

Back Side Middle /Zoom Scan (5x5x7)/Cube 0: Measurement grid: dx=8mm, dy=8mm, dz=5mm

Reference Value = 13.294 V/m; Power Drift = -0.06 dB

Peak SAR (extrapolated) = 0.935 W/kg

SAR(1 g) = 0.499 W/kg; SAR(10 g) = 0.280 W/kg

Maximum value of SAR (measured) = 0.542 W/kg

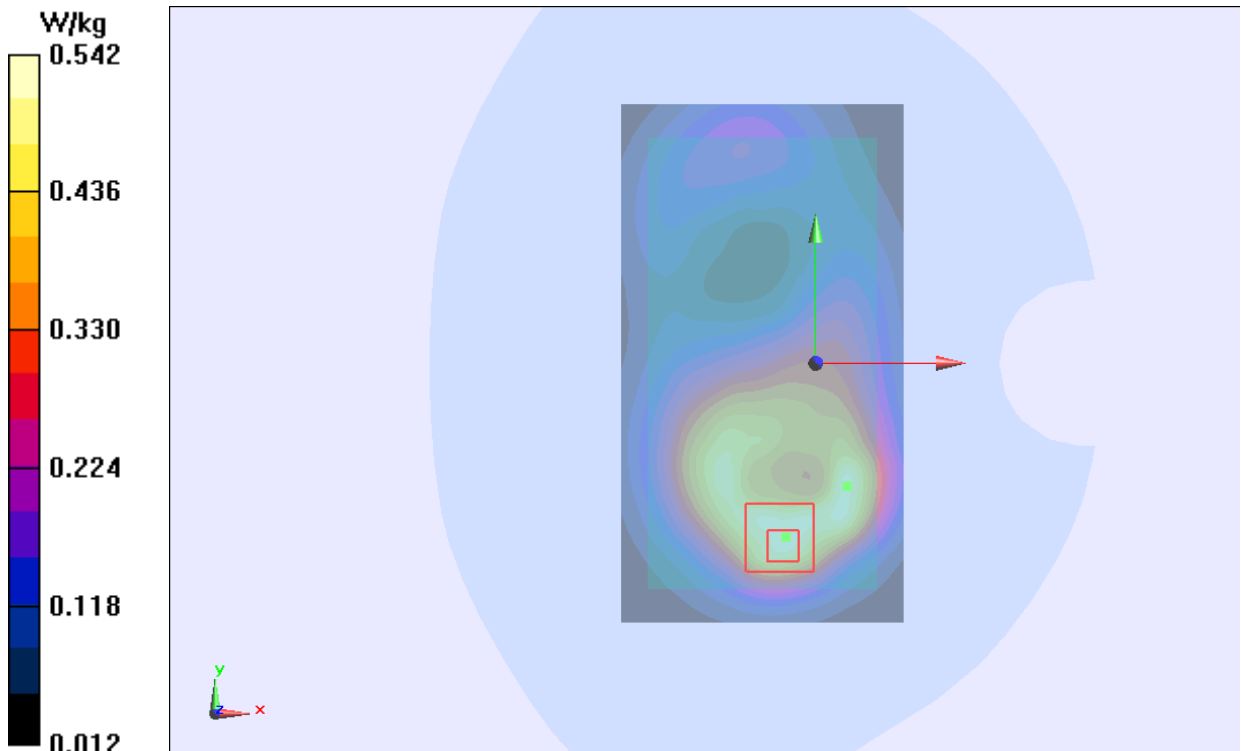

Figure 33 Body, Back Side, GSM 1900 GPRS (4Txslots) Channel 661

GSM 1900 GPRS (4Txslots) Front Side High

Date/Time: 2013-12-23 14:08:59

Communication System: GPRS(4UP); Frequency: 1909.8 MHz; Duty Cycle: 1:2.07491

Medium parameters used: $f = 1910$ MHz; $\sigma = 1.537$ S/m; $\epsilon_r = 52.848$; $\rho = 1000$ kg/m³

Ambient Temperature: 22.3 °C Liquid Temperature: 21.5 °C

Phantom section: Flat Section

DASY5 Configuration:

Sensor-Surface: 4mm (Mechanical Surface Detection)

Probe: EX3DV4 - SN3753; ConvF(7.33, 7.33, 7.33); Calibrated: 2013-01-17

Electronics: DAE4 Sn1317; Calibrated: 2013-01-25

Phantom: SAM 2; Type: QD000P40CD; Serial: TP1667

Measurement SW: DASY52, Version 52.8 (5); SEMCAD X Version 14.6.8 (7028)

Front Side High /Area Scan (61x111x1): Interpolated grid: dx=15 mm, dy=15 mm

Maximum value of SAR (interpolated) = 0.724 W/kg

Front Side High /Zoom Scan (5x5x7)/Cube 0: Measurement grid: dx=8mm, dy=8mm, dz=5mm

Reference Value = 10.517 V/m; Power Drift = -0.07 dB

Peak SAR (extrapolated) = 1.34 W/kg

SAR(1 g) = 0.641 W/kg; SAR(10 g) = 0.335 W/kg

Maximum value of SAR (measured) = 0.695 W/kg

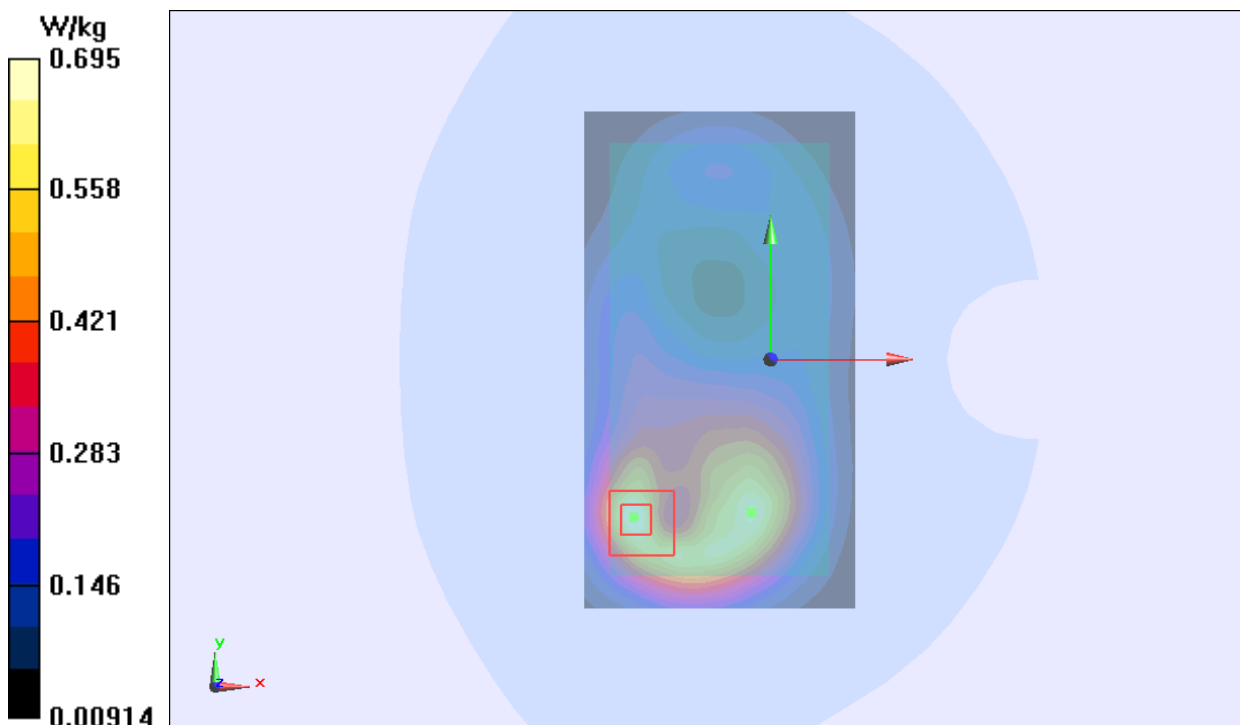

Figure 34 Body, Front Side, GSM 1900 GPRS (4Txslots) Channel 810

GSM 1900 GPRS (4Txslots) Front Side Middle

Date/Time: 2013-12-23 13:26:39

Communication System: GPRS(4UP); Frequency: 1880 MHz; Duty Cycle: 1:2.07491

Medium parameters used: $f = 1880$ MHz; $\sigma = 1.508$ S/m; $\epsilon_r = 52.874$; $\rho = 1000$ kg/m³

Ambient Temperature: 22.3 °C Liquid Temperature: 21.5°C

Phantom section: Flat Section

DASY5 Configuration:

Sensor-Surface: 4mm (Mechanical Surface Detection)

Probe: EX3DV4 - SN3753; ConvF(7.33, 7.33, 7.33); Calibrated: 2013-01-17

Electronics: DAE4 Sn1317; Calibrated: 2013-01-25

Phantom: SAM 2; Type: QD000P40CD; Serial: TP1667

Measurement SW: DASY52, Version 52.8 (5); SEMCAD X Version 14.6.8 (7028)

Front Side Middle /Area Scan (61x111x1): Interpolated grid: dx=15 mm, dy=15 mm

Maximum value of SAR (interpolated) = 0.716 W/kg

Front Side Middle /Zoom Scan (5x5x7)/Cube 0: Measurement grid: dx=8mm, dy=8mm, dz=5mm

Reference Value = 12.602 V/m; Power Drift = -0.04 dB

Peak SAR (extrapolated) = 1.43 W/kg

SAR(1 g) = 0.686 W/kg; SAR(10 g) = 0.360 W/kg

Maximum value of SAR (measured) = 0.764 W/kg

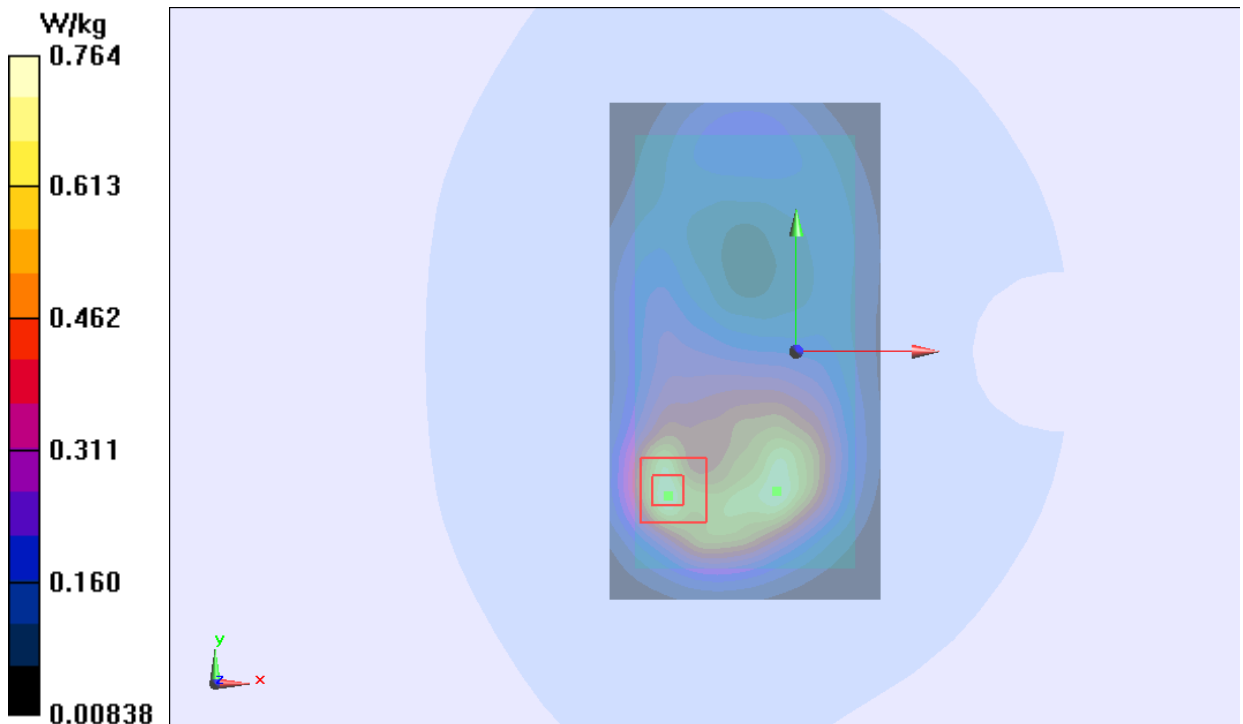

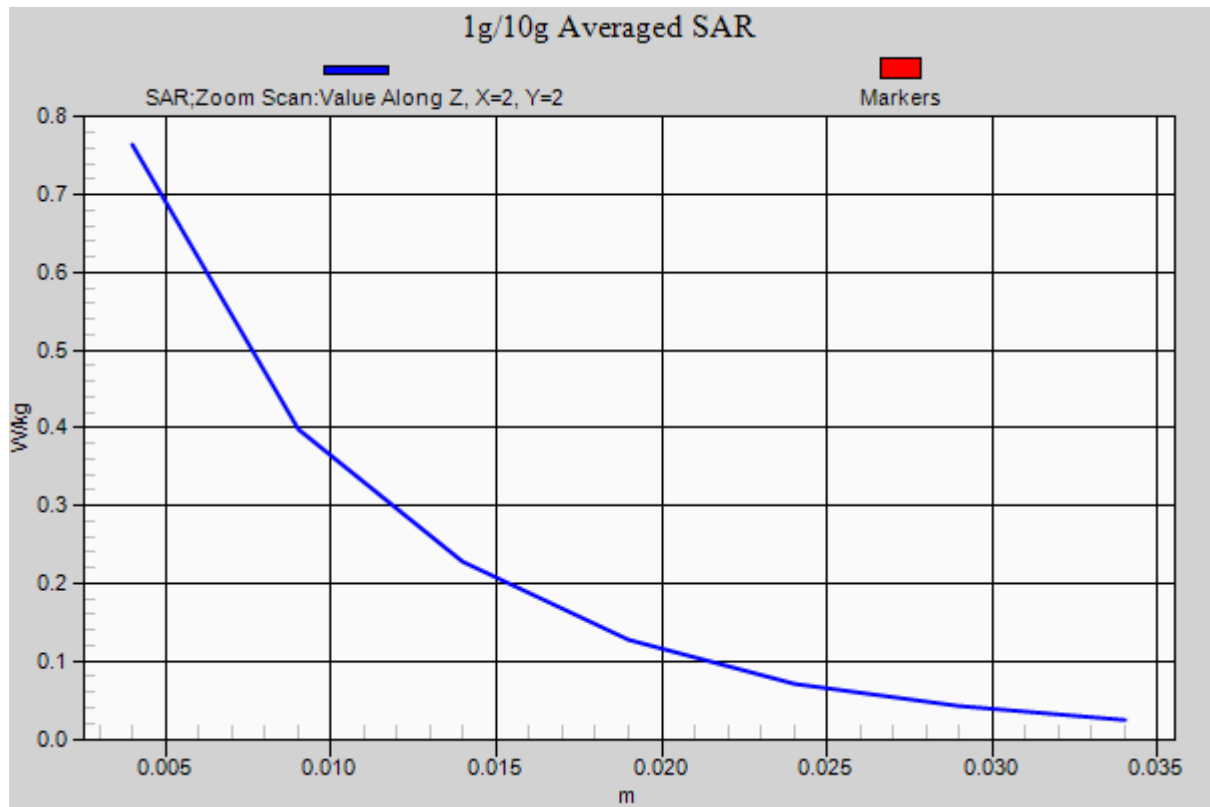

Figure 35 Body, Front Side, GSM 1900 GPRS (4Txslots) Channel 661

GSM 1900 GPRS (4Txslots) Front Side Low

Date/Time: 2013-12-23 14:33:50

Communication System: GPRS(4UP); Frequency: 1850.2 MHz; Duty Cycle: 1:2.07491

Medium parameters used (interpolated): $f = 1850.2$ MHz; $\sigma = 1.472$ S/m; $\epsilon_r = 52.944$; $\rho = 1000$ kg/m³

Ambient Temperature: 22.3 °C Liquid Temperature: 21.5°C

Phantom section: Flat Section

DASY5 Configuration:

Sensor-Surface: 4mm (Mechanical Surface Detection)

Probe: EX3DV4 - SN3753; ConvF(7.33, 7.33, 7.33); Calibrated: 2013-01-17

Electronics: DAE4 Sn1317; Calibrated: 2013-01-25

Phantom: SAM 2; Type: QD000P40CD; Serial: TP1667

Measurement SW: DASY52, Version 52.8 (5); SEMCAD X Version 14.6.8 (7028)

Front Side Low /Area Scan (61x111x1): Interpolated grid: dx=15 mm, dy=15 mm

Maximum value of SAR (interpolated) = 0.609 W/kg

Front Side Low /Zoom Scan (5x5x7)/Cube 0: Measurement grid: dx=8mm, dy=8mm, dz=5mm

Reference Value = 9.177 V/m; Power Drift = -0.01 dB

Peak SAR (extrapolated) = 1.08 W/kg

SAR(1 g) = 0.539 W/kg; SAR(10 g) = 0.293 W/kg

Maximum value of SAR (measured) = 0.597 W/kg

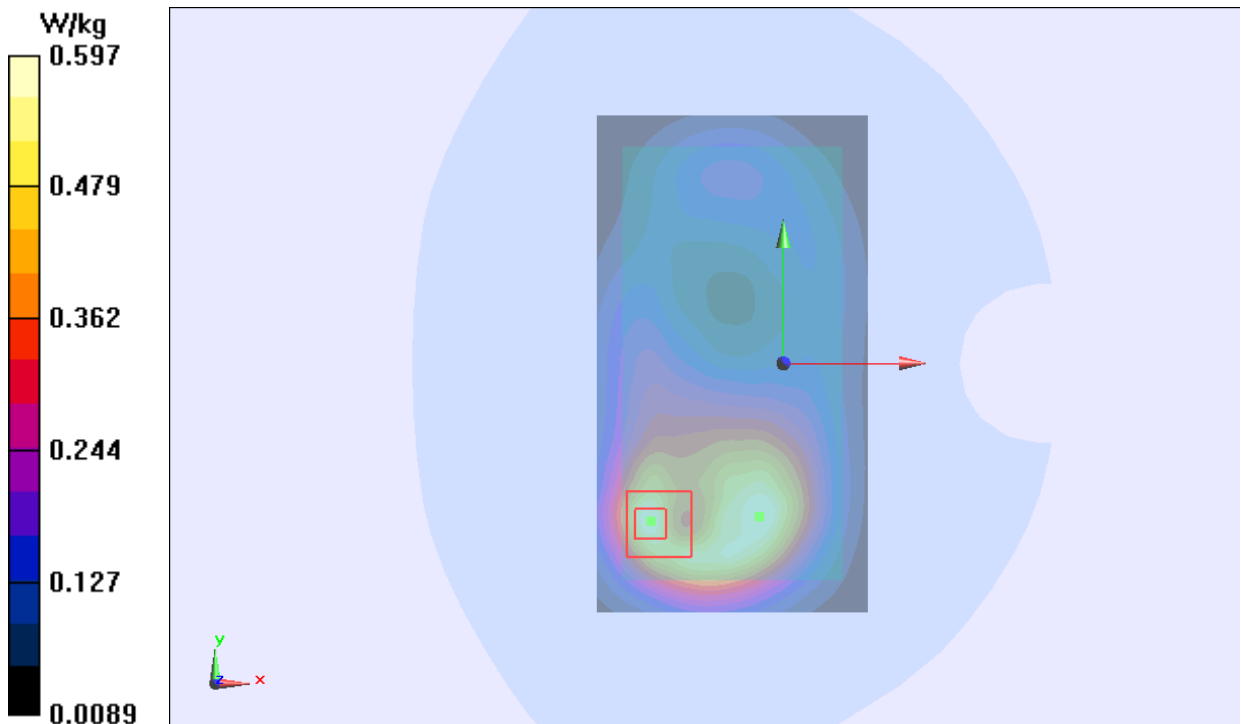

Figure 36 Body, Front Side, GSM 1900 GPRS (4Txslots) Channel 512

GSM 1900 GPRS (4Txslots) Left Edge Middle

Date/Time: 2013-12-23 11:08:16

Communication System: GPRS(4UP); Frequency: 1880 MHz; Duty Cycle: 1:2.07491

Medium parameters used: $f = 1880$ MHz; $\sigma = 1.508$ S/m; $\epsilon_r = 52.874$; $\rho = 1000$ kg/m³

Ambient Temperature: 22.3 °C Liquid Temperature: 21.5°C

Phantom section: Flat Section

DASY5 Configuration:

Sensor-Surface: 4mm (Mechanical Surface Detection)

Probe: EX3DV4 - SN3753; ConvF(7.33, 7.33, 7.33); Calibrated: 2013-01-17

Electronics: DAE4 Sn1317; Calibrated: 2013-01-25

Phantom: SAM 2; Type: QD000P40CD; Serial: TP1667

Measurement SW: DASY52, Version 52.8 (5); SEMCAD X Version 14.6.8 (7028)

Left Edge Middle /Area Scan (31x111x1): Interpolated grid: dx=10 mm, dy=10 mm

Maximum value of SAR (interpolated) = 0.348 W/kg

Left Edge Middle /Zoom Scan (5x5x7)/Cube 0: Measurement grid: dx=8mm, dy=8mm, dz=5mm

Reference Value = 10.901 V/m; Power Drift = -0.021 dB

Peak SAR (extrapolated) = 0.538 W/kg

SAR(1 g) = 0.294 W/kg; SAR(10 g) = 0.166 W/kg

Maximum value of SAR (measured) = 0.318 W/kg

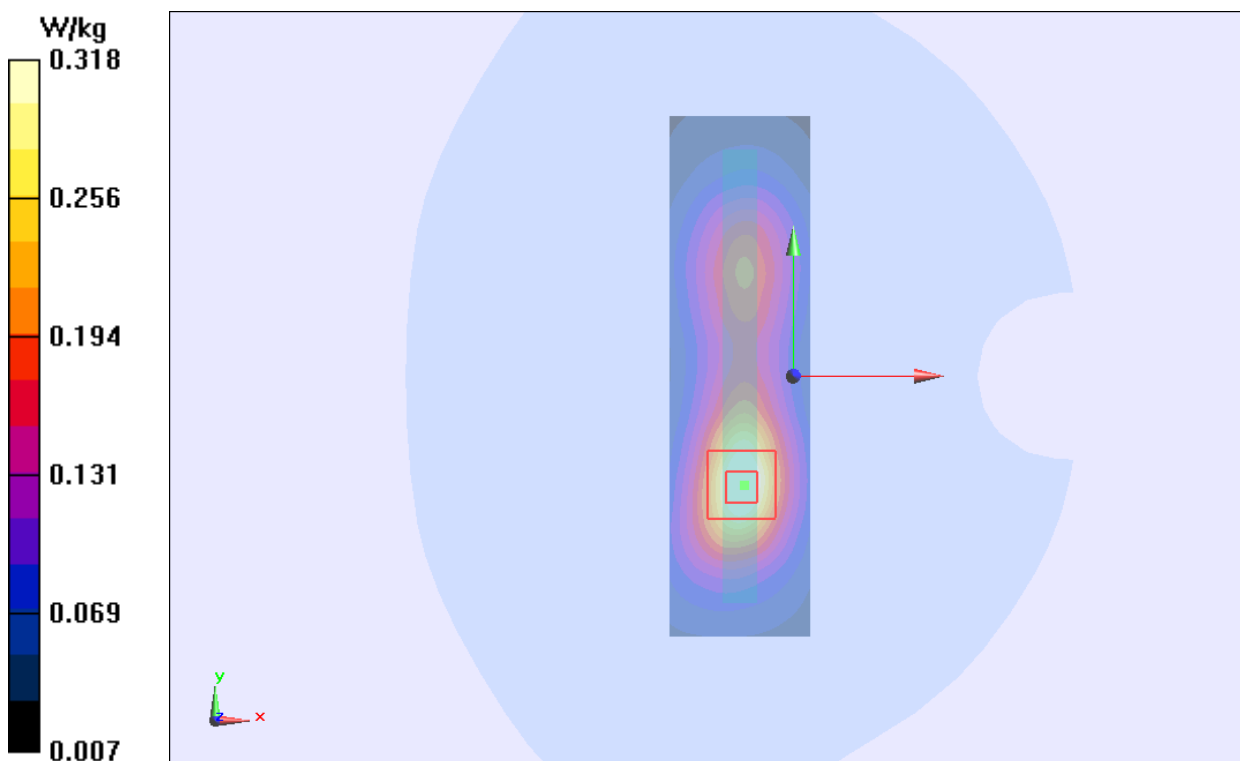

Figure 37 Body, Left Edge, GSM 1900 GPRS (4Txslots) Channel 661

GSM 1900 GPRS (4Txslots) Right Edge Middle

Date/Time: 2013-12-23 11:48:14

Communication System: GPRS(4UP); Frequency: 1880 MHz; Duty Cycle: 1:2.07491

Medium parameters used: $f = 1880$ MHz; $\sigma = 1.508$ S/m; $\epsilon_r = 52.874$; $\rho = 1000$ kg/m³

Ambient Temperature: 22.3 °C Liquid Temperature: 21.5 °C

Phantom section: Flat Section

DASY5 Configuration:

Sensor-Surface: 4mm (Mechanical Surface Detection)

Probe: EX3DV4 - SN3753; ConvF(7.33, 7.33, 7.33); Calibrated: 2013-01-17

Electronics: DAE4 Sn1317; Calibrated: 2013-01-25

Phantom: SAM 2; Type: QD000P40CD; Serial: TP1667

Measurement SW: DASY52, Version 52.8 (5); SEMCAD X Version 14.6.8 (7028)

Right Edge Middle /Area Scan (31x111x1): Interpolated grid: dx=15 mm, dy=15 mm

Maximum value of SAR (interpolated) = 0.0874 W/kg

Right Edge Middle /Zoom Scan (5x5x7)/Cube 0: Measurement grid: dx=8mm, dy=8mm, dz=5mm

Reference Value = 6.623 V/m; Power Drift = -0.024 dB

Peak SAR (extrapolated) = 0.150 W/kg

SAR(1 g) = 0.078 W/kg; SAR(10 g) = 0.047 W/kg

Maximum value of SAR (measured) = 0.0824 W/kg

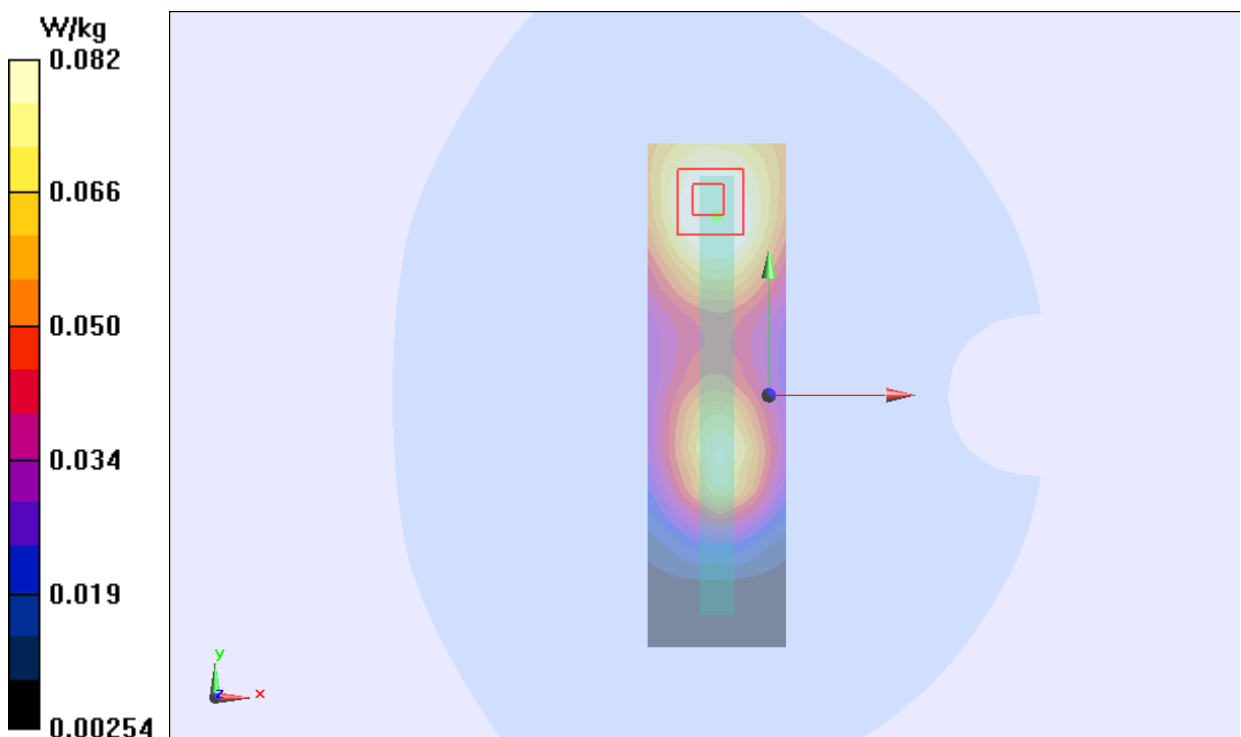

Figure 38 Body, Right Edge, GSM 1900 GPRS (4Txslots) Channel 661

GSM 1900 GPRS (4Txslots) Bottom Edge Middle

Date/Time: 2013-12-23 10:53:00

Communication System: GPRS(4UP); Frequency: 1880 MHz; Duty Cycle: 1:2.07491

Medium parameters used: $f = 1880$ MHz; $\sigma = 1.508$ S/m; $\epsilon_r = 52.874$; $\rho = 1000$ kg/m³

Ambient Temperature: 22.3 °C Liquid Temperature: 21.5 °C

Phantom section: Flat Section

DASY5 Configuration:

Sensor-Surface: 4mm (Mechanical Surface Detection)

Probe: EX3DV4 - SN3753; ConvF(7.33, 7.33, 7.33); Calibrated: 2013-01-17

Electronics: DAE4 Sn1317; Calibrated: 2013-01-25

Phantom: SAM 2; Type: QD000P40CD; Serial: TP1667

Measurement SW: DASY52, Version 52.8 (5); SEMCAD X Version 14.6.8 (7028)

Bottom Edge Middle /Area Scan (31x71x1): Interpolated grid: dx=15 mm, dy=15 mm

Maximum value of SAR (interpolated) = 0.519 W/kg

Bottom Edge Middle /Zoom Scan (5x5x7)/Cube 0: Measurement grid: dx=8mm, dy=8mm, dz=5mm

Reference Value = 18.223 V/m; Power Drift = 0.06 dB

Peak SAR (extrapolated) = 0.877 W/kg

SAR(1 g) = 0.466 W/kg; SAR(10 g) = 0.256 W/kg

Maximum value of SAR (measured) = 0.508 W/kg

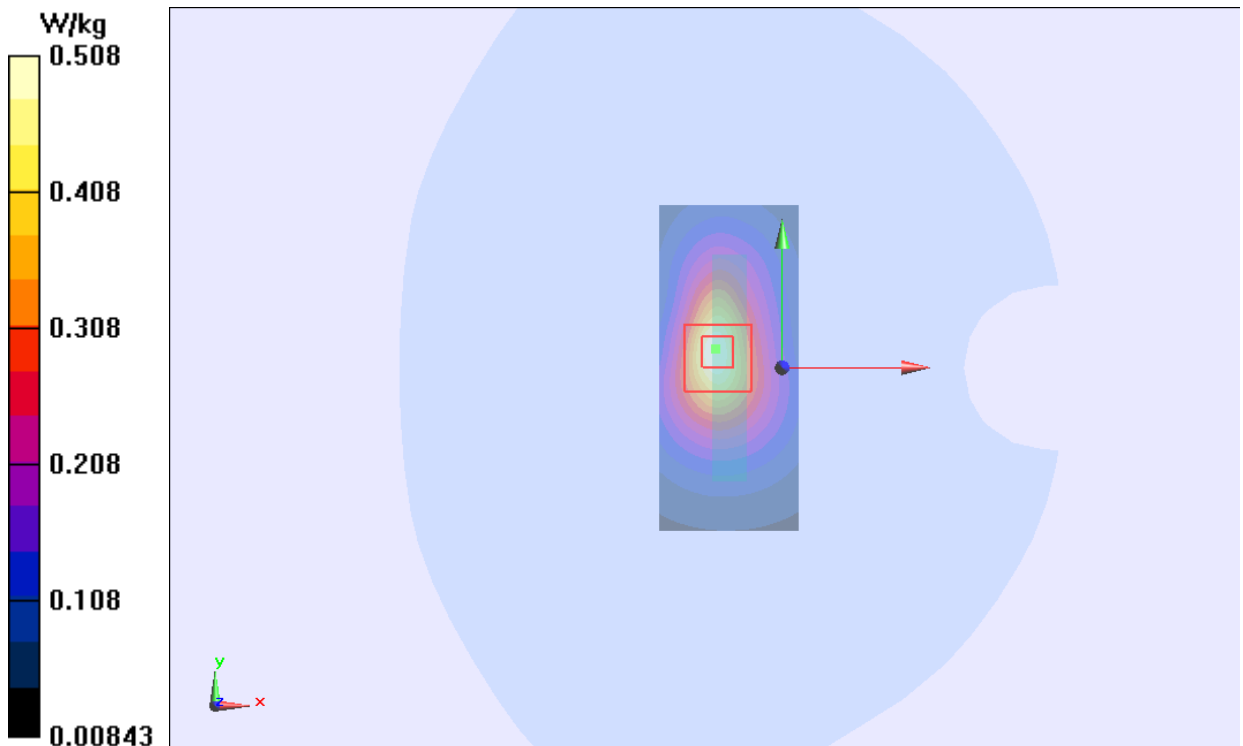

Figure 39 Body, Bottom Edge, GSM 1900 GPRS (4Txslots) Channel 661

GSM 1900 EGPRS (4Txslots) Front Side Middle

Date/Time: 2013-12-23 12:23:02

Communication System: GPRS(4UP); Frequency: 1880 MHz; Duty Cycle: 1:2.07491

Medium parameters used: $f = 1880$ MHz; $\sigma = 1.508$ S/m; $\epsilon_r = 52.874$; $\rho = 1000$ kg/m³

Ambient Temperature: 22.3 °C Liquid Temperature: 21.5 °C

Phantom section: Flat Section

DASY5 Configuration:

Sensor-Surface: 4mm (Mechanical Surface Detection)

Probe: EX3DV4 - SN3753; ConvF(7.33, 7.33, 7.33); Calibrated: 2013-01-17

Electronics: DAE4 Sn1317; Calibrated: 2013-01-25

Phantom: SAM 2; Type: QD000P40CD; Serial: TP1667

Measurement SW: DASY52, Version 52.8 (5); SEMCAD X Version 14.6.8 (7028)

Front Side Middle /Area Scan (61x111x1): Interpolated grid: dx=15 mm, dy=15 mm

Maximum value of SAR (interpolated) = 0.709 W/kg

Front Side Middle e/Zoom Scan (5x5x7)/Cube 0: Measurement grid: dx=8mm, dy=8mm, dz=5mm

Reference Value = 12.569 V/m; Power Drift = 0.01 dB

Peak SAR (extrapolated) = 1.41 W/kg

SAR(1 g) = 0.679 W/kg; SAR(10 g) = 0.356 W/kg

Maximum value of SAR (measured) = 0.755 W/kg

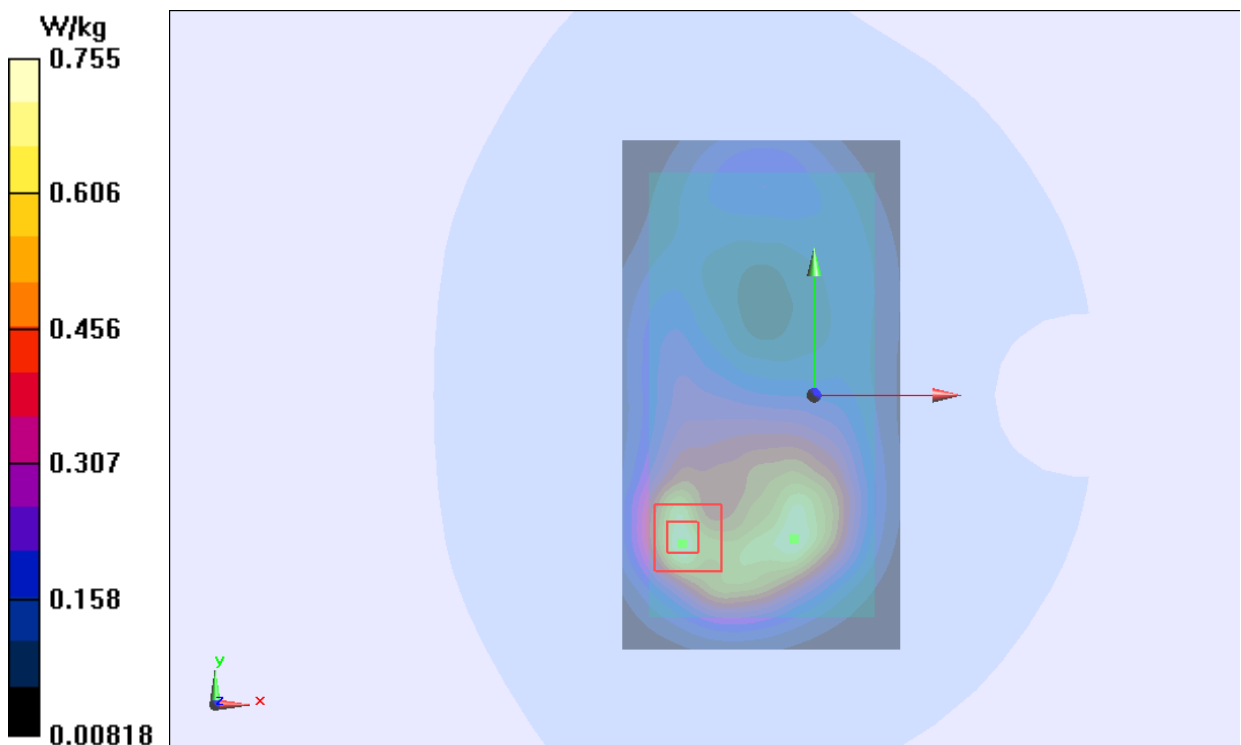

Figure 40 Body, Front Side, GSM 1900 EGPRS (4Txslots) Channel 661

GSM 1900 GPRS (4Txslots) Front Side Middle (SIM 2)

Date/Time: 2013-12-23 13:07:34

Communication System: GPRS(4UP); Frequency: 1880 MHz; Duty Cycle: 1:2.07491

Medium parameters used: $f = 1880$ MHz; $\sigma = 1.508$ S/m; $\epsilon_r = 52.874$; $\rho = 1000$ kg/m³

Ambient Temperature: 22.3 °C Liquid Temperature: 21.5 °C

Phantom section: Flat Section

DASY5 Configuration:

Sensor-Surface: 4mm (Mechanical Surface Detection)

Probe: EX3DV4 - SN3753; ConvF(7.33, 7.33, 7.33); Calibrated: 2013-01-17

Electronics: DAE4 Sn1317; Calibrated: 2013-01-25

Phantom: SAM 2; Type: QD000P40CD; Serial: TP1667

Measurement SW: DASY52, Version 52.8 (5); SEMCAD X Version 14.6.8 (7028)

Front Side Middle /Area Scan (61x111x1): Interpolated grid: dx=15 mm, dy=15 mm

Maximum value of SAR (interpolated) = 0.714 W/kg

Front Side Middle /Zoom Scan (5x5x7)/Cube 0: Measurement grid: dx=8mm, dy=8mm, dz=5mm

Reference Value = 12.620 V/m; Power Drift = -0.02 dB

Peak SAR (extrapolated) = 1.43 W/kg

SAR(1 g) = 0.684 W/kg; SAR(10 g) = 0.359 W/kg

Maximum value of SAR (measured) = 0.761 W/kg

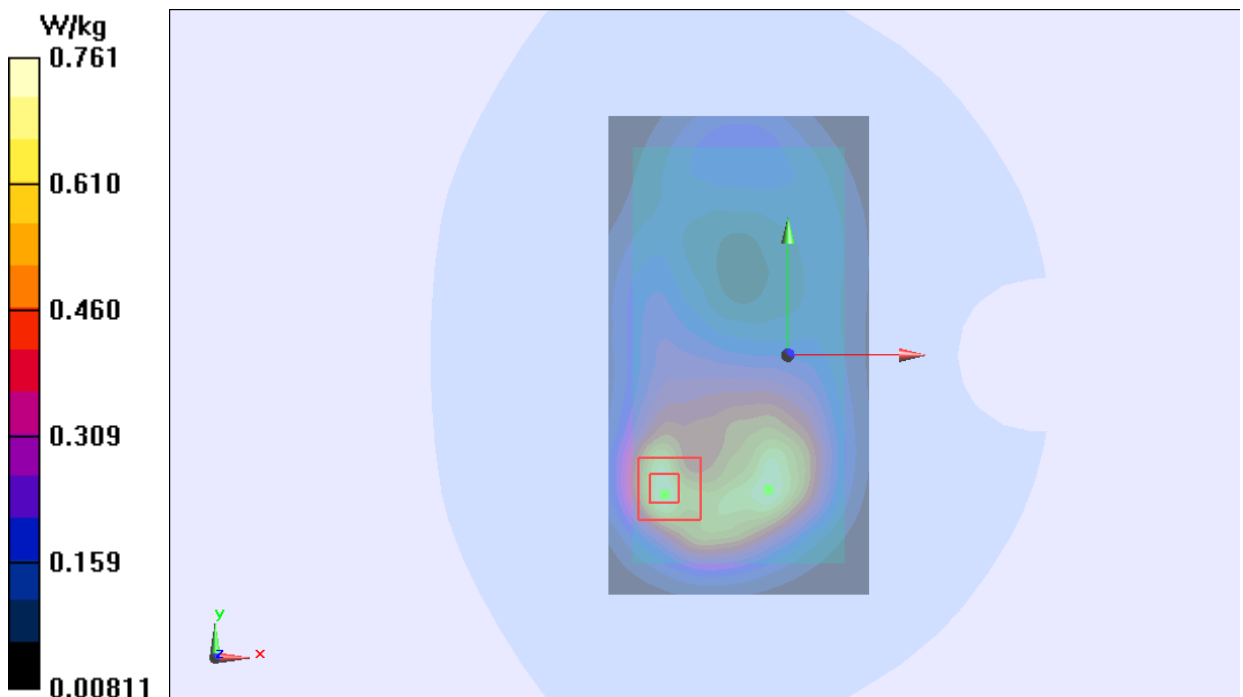

Figure 41 Body, Front Side, GSM 1900 GPRS (4Txslots) Channel 661

UMTS Band II Left Cheek Middle

Date/Time: 2013-12-10 20:39:42

Communication System: WCDMA; Frequency: 1880 MHz; Duty Cycle: 1:1

Medium parameters used: $f = 1880$ MHz; $\sigma = 1.408$ S/m; $\epsilon_r = 39.625$; $\rho = 1000$ kg/m³

Ambient Temperature: 22.3 °C Liquid Temperature: 21.5°C

Phantom section: Left Section

DASY5 Configuration:

Sensor-Surface: 4mm (Mechanical Surface Detection)

Probe: EX3DV4 - SN3753; ConvF(7.63, 7.63, 7.63); Calibrated: 2013-01-17

Electronics: DAE4 Sn1317; Calibrated: 2013-01-25

Phantom: SAM 2; Type: QD000P40CD; Serial: TP1667

Measurement SW: DASY52, Version 52.8 (5); SEMCAD X Version 14.6.8 (7028)

Left Cheek Middle /Area Scan (71x111x1): Interpolated grid: dx=15 mm, dy=15 mm

Maximum value of SAR (interpolated) = 0.576 W/kg

Left Cheek Middle /Zoom Scan (5x5x7)/Cube 0: Measurement grid: dx=8mm, dy=8mm, dz=5mm

Reference Value = 7.063 V/m; Power Drift = 0.052 dB

Peak SAR (extrapolated) = 0.745 W/kg

SAR(1 g) = 0.509 W/kg; SAR(10 g) = 0.310 W/kg

Maximum value of SAR (measured) = 0.567 W/kg

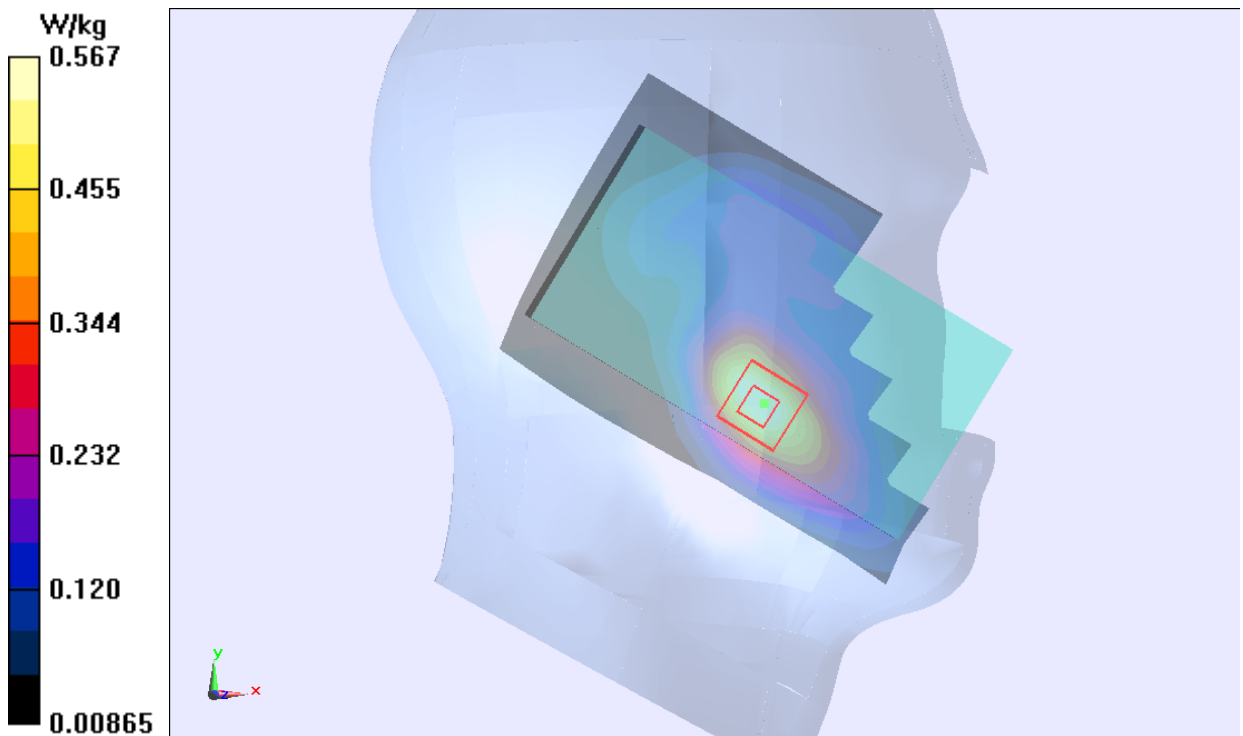

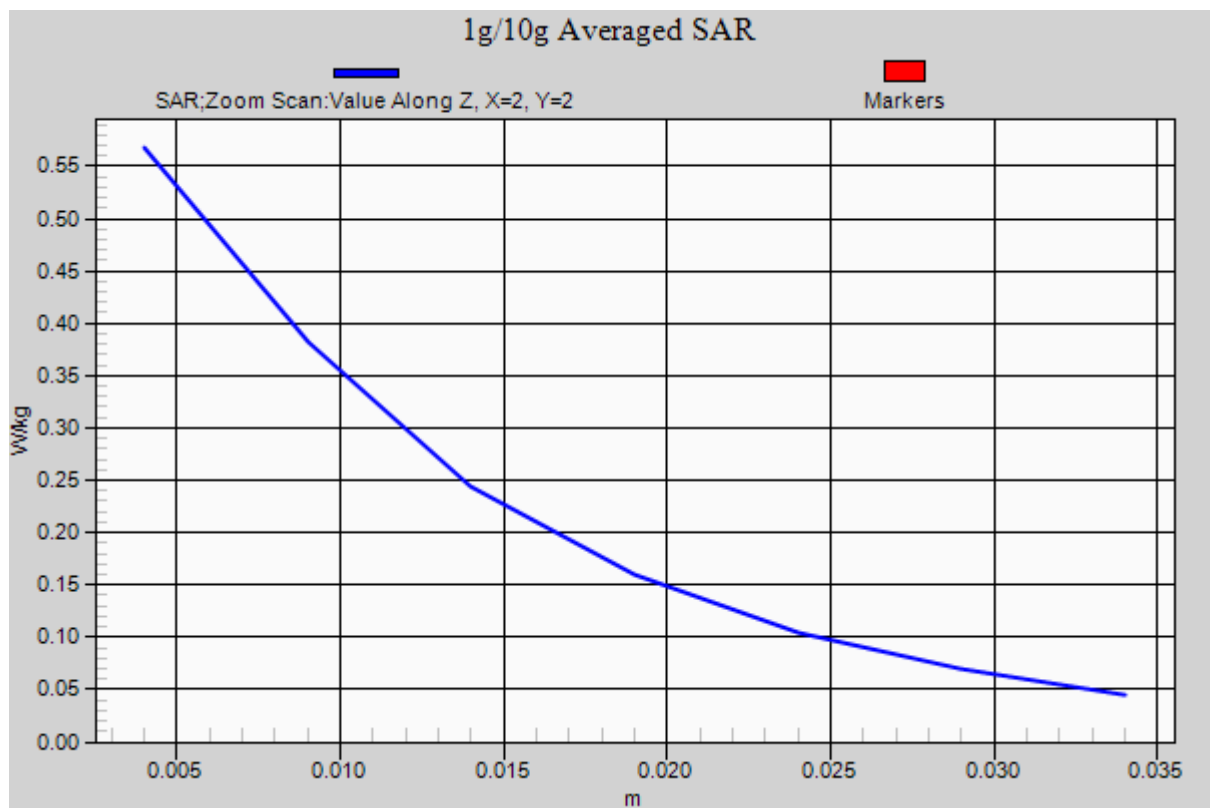

Figure 42 Left Hand Touch Cheek UMTS Band II Channel 9400