

SAR TEST REPORT

Project No. : JB-Z0108
 Client : Murata Manufacturing Co., Ltd.
 Address : 10-1 Higashikotari 1-chome, Nagaokakyo-shi, Kyoto 617-8555 Japan
 Type of Equipment : Communication Module
 Model No. : Type1DR (* installed in Digital Camera 1DR003)
 FCC-ID : VPYLB1DR
 Regulation Applied : FCC 47 CFR 2.1093 (Class II Permissive Change)

SAR Limits :

Exposure Characteristics	Spatial Peak SAR (Head and Trunk) averaged over any 1 g of tissue	Spatial Peak SAR (Extremities: Hands/Wrists/Feet/Ankles) averaged over any 10 g of tissue
General Public Exposure	1.6 W/kg	4.0 W/kg

The Highest Reported SAR:

RF Exposure Conditions	Equipment Class		Note(s)
	DTS	DTS	
	Wi-Fi 2.4 GHz	Bluetooth Low Energy	
Head-Worn	0.743 W/kg	N/A	
Body-Worn	0.716 W/kg	N/A	
Extremity (Hand)	0.625 W/kg	N/A	

Test Result : **Complied**

Sample Receipt : December 8, 2015
 Testing : December 10, 2015 - December 14, 2015
 Reported : December 21, 2015

Reported by :

Approved Signatory :

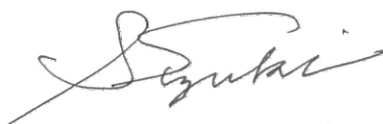

Shinichi Suzuki
 Technical Manager
 EMC/ RF Test Laboratory Main Lab.
 Design Technology Division
 Sony EMCS Corporation

Teruki Kurihara
 Technical Manager
 EMC/ RF Test Laboratory Main Lab.
 Design Technology Division
 Sony EMCS Corporation

Notice

- * These test results relate only to the items (combination equipment, test configuration, operation condition etc.) tested.
- * This report shall not be reproduced except in full, without written approval of the laboratory.
- * This report must not be used by the client to claim product endorsement by A2LA or any agency of the U.S. Government.
- * All test results are traceable to the national and / or international standards.
- * The testing in which "Non-accreditation" is displayed is outside the accreditation scopes in Sony EMCS EMC/ RF Test Laboratory.



REVISION HISTORY

Project No.	Revision	Page	Description	Issued date
JB-Z0108	Original	-	-	December 21, 2015

TABLE OF CONTENTS

1. General Information.....	4
1.1. Description of Device Under Test (DUT).....	4
1.2. Antenna Placement.....	4
1.3. Simultaneous Transmission Conditions.....	4
1.4. Nominal and Maximum Possible Power (Maximum Tune-up Tolerance Limit).....	5
1.5. RF Exposure Conditions.....	5
1.6. RF Exposure Limits.....	6
1.7. SAR Test Exclusion.....	7
1.8. Test Specification, Methods and Procedures.....	8
1.9. Test Facilities and Accreditation.....	9
2. Test Set-up.....	10
2.1. Test Equipment and Measurement Software Lists.....	10
2.2. Measurement System Description.....	12
2.3. Measurement System Main Components.....	13
2.4. Tissue Simulating Liquids.....	16
2.5. SAR Measurement.....	17
2.6. Measurement Uncertainty.....	18
2.7. Dielectric Parameter Measurement of Tissue Simulating Liquids.....	21
2.8. System Check Measurement.....	23
3. Conducted Power Measurements.....	25
3.1. Conducted Power Measurement Results.....	25
3.2. Comparison of Conducted Power with Original Radio Test Report.....	26
4. SAR Measurements.....	27
4.1. SAR Measurement Results.....	29
4.2. SAR Measurement Variability.....	30
Appendix A. Plots of SAR Measurement.....	31
Appendix B. Plots of System Check.....	35
Appendix C. Calibration Certificate.....	39
Appendix D. Photographs.....	60

1. General Information

1.1. Description of Device Under Test (DUT)

DUT and Host Platform Descriptions

	DUT	Host Platform *The DUT is installed in this host.
Type of Equipment	Communication Module	Digital Camera
Model No.	Type1DR	1DR003
FCC-ID	VPYLB1DR	
Test Sample Condition	<input checked="" type="checkbox"/> Prototype <input type="checkbox"/> Pre-production <input type="checkbox"/> Mass-production	<input checked="" type="checkbox"/> Prototype <input type="checkbox"/> Pre-production <input type="checkbox"/> Mass-production
	* Not for sale: The sample is equivalent to mass-production items. * No modification by the test lab.	
Serial No.	61	61
Rating	DC 3.2 V (VBAT) DC 1.8 V (VDDXO) DC 1.8 or 3.3 V (VIO) * Supplied from the host.	Li-ion Battery DC 3.6 V/ 1240 mAh <input type="checkbox"/> Not user accessible.
Head/Body-Worn Accessories (supplied with the device)	n/a	n/a
Device Dimension (W x H x D)	7.7 mm x 7.9 mm x 1.1 mm	See Appendix D
Device Category	Portable	
Exposure Category	General population/ Uncontrolled environment	

Wireless Technologies

Wireless Technologies	Frequency Bands	Operating Mode
Wi-Fi	2.4 GHz	802.11b 802.11g 802.11n (HT20)
Bluetooth	2.4 GHz	Version 4.1 (BLE)
Note(s): * The DUT installed in this host does not support the Wi-Fi 5 GHz and Bluetooth Classic (BDR/EDR) operations.		

Radio Specification

Type of Equipment	Portable Transceiver
Antenna Type	Monopole antenna
Antenna Gain	- 2.11 dBi
Note(s): * The antenna is of same type and lower gain from original approval: monopole antenna and + 0.91 dBi.	

1.2. Antenna Placement

Antenna	Minimum Distance from Edges or Sides of Host Platform (mm)					
	Front	Back	Left	Right	Top	Bottom
Wi-Fi/Bluetooth	60.70	4.70	2.85	21.05	28.10	6.40

* Please refer to Appendix D for more details.

1.3. Simultaneous Transmission Conditions

Wi-Fi 2.4 GHz cannot transmit simultaneously with Bluetooth.

1.4. Nominal and Maximum Possible Power (Maximum Tune-up Tolerance Limit)

Wireless Technologies	Mode	Frequency Band (MHz)		Channel	Data Rate /MCS	Full Power (Burst Averaged)			
		Lower	Higher			Nominal (dBm)	Tolerance (dB)	Max. Tune-up Limit (dBm)	
Wi-Fi	802.11b	2412	2462	All	All	17.0	+2.0	-2.0	19.0
	802.11g	2412	2462	1	All	13.5	+2.0	-2.0	15.5
				2 to 10	6 to 48 Mbps	17.0	+2.0	-2.0	19.0
					54 Mbps	16.0	+2.0	-2.0	18.0
				11	All	13.5	+2.0	-2.0	15.5
	802.11n (HT20)	2412	2462	1	All	13.5	+2.0	-2.0	15.5
				2 to 10	MCS 0 to 2	17.0	+2.0	-2.0	19.0
					MCS 3 to 6	16.0	+2.0	-2.0	18.0
					MCS 7	15.0	+2.0	-2.0	17.0
	11	All	13.5	+2.0	-2.0	15.5			
Bluetooth	BLE	2402	2480	All	-	7.0	-2.8	+2.5	9.5

1.5. RF Exposure Conditions

Wireless Technologies	RF Exposure Conditions	User-to-Host Distance (mm)	Test Position	Host-to-Ant. Distance (mm)	SAR Required	Note(s)
Wi-Fi /Bluetooth	Head-Worn	5	Front	60.70	Yes	1
			Back	4.70	Yes	1
			Left	2.85	Yes	1
			Right	21.05	Yes	1
			Top	28.10	Yes	1
			Bottom	6.40	Yes	1
	Body-Worn	5	Front	60.70	Yes	1
			Back	4.70	Yes	1
			Left	2.85	Yes	1
			Right	21.05	Yes	1
			Top	28.10	Yes	1
			Bottom	6.40	Yes	1
	Extremity (Hand)	0	Front	60.70	Yes	
			Back	4.70	Yes	
			Left-Tilt	≈ 2.85	Yes	2
			Right-Tilt	≈ 21.05	Yes	2
			Top	28.10	Yes	
			Bottom	6.40	Yes	

Note(s):

1. According to the intended use as specified by the host platform manufacturer in the user manual, SAR for the head-worn and body-worn exposure conditions were evaluated with the minimum separation distance from user to the host of 5 mm.
2. Due to the shape of the protruding portion of the left and right surfaces of the host platform, SAR for the extremity exposure condition was evaluated with the back corner of the left or right surface positioned in direct contact against the flat phantom, the "Left-Tilt" or "Right-Tilt" test positions, instead of the "Left" or "Right" test position respectively. Please refer to Appendix D for more details.

1.6. RF Exposure Limits

Human Exposure	General Population/ Uncontrolled Exposure	Occupational/ Controlled Exposure
Spatial Peak SAR (Head and Trunk) averaged over any 1 g of tissue	1.6 W/kg*	8 W/kg
Spatial Average SAR (Whole Body) averaged over the whole body	0.08 W/kg	0.4 W/kg
Spatial Peak SAR (Extremities: Hands/Wrists/Feet/Ankles) averaged over any 10 g of tissue	4 W/kg*	20 W/kg

* The limit(s) applied in this report.

1.7. SAR Test Exclusion

SAR test exclusion is applied according to KDB 447498 D01.

The 1-g SAR test exclusion thresholds for 100 MHz to 6 GHz at test separation distances ≤ 50 mm are determined by:

$$\left[\frac{(\text{max. power of channel, including tune-up tolerance, mW})}{(\text{min. test separation distance, mm})} \right] \cdot \sqrt{f(\text{GHz})} \leq 3.0 \text{ for 1-g SAR and } \leq 7.5 \text{ for 10-g extremity SAR, where:}$$

- * f(GHz) is the RF channel transmit frequency in GHz
- * Power and distance are rounded to the nearest mW and mm before calculation
- * The result is rounded to one decimal place for comparison
- * When the minimum test separation distance is < 5 mm, a distance of 5 mm is applied to determine SAR test exclusion

Head/Body-Worn SAR (1-g SAR) Test Exclusion as per KDB 447498 D01

Freq. Band	Freq. (MHz)	Test Position	User-to-Host Distance (mm)	Host-to-Ant Distance (mm)	User-to-Ant Distance (mm)	Min. Test Sep. Distance (mm)	Max. Possible Power			Exclusion Threshold	SAR Required (> 3.0)
							(dBm)	(mW)	rounded (mW)		
Wi-Fi 2.4GHz	2450	Front	5	60.70	65.70	66	19.0	79.4	79	1.9	No
	2450	Back	5	4.70	9.70	10	19.0	79.4	79	12.4	Yes
	2450	Left	5	2.85	7.85	8	19.0	79.4	79	15.5	Yes
	2450	Right	5	21.05	26.05	26	19.0	79.4	79	4.8	Yes
	2450	Top	5	28.10	33.10	33	19.0	79.4	79	3.7	Yes
	2450	Bottom	5	6.40	11.40	11	19.0	79.4	79	11.2	Yes
Bluetooth	2450	Front	5	60.7	65.70	66	9.5	8.9	9	0.2	No
	2450	Back	5	4.7	9.70	10	9.5	8.9	9	1.4	No
	2450	Left	5	2.85	7.85	8	9.5	8.9	9	1.8	No
	2450	Right	5	21.05	26.05	26	9.5	8.9	9	0.5	No
	2450	Top	5	28.10	33.10	33	9.5	8.9	9	0.4	No
	2450	Bottom	5	6.40	11.40	11	9.5	8.9	9	1.3	No

Extremity SAR (10-g SAR) Test Exclusion as per KDB 447498 D01

Freq. Band	Freq. (MHz)	Test Position	User-to-Host Distance (mm)	Host-to-Ant Distance (mm)	User-to-Ant Distance (mm)	Min. Test Sep. Distance (mm)	Max. Possible Power			Exclusion Threshold	SAR Required (> 7.5)
							(dBm)	(mW)	rounded (mW)		
Wi-Fi 2.4GHz	2450	Front	0	60.70	60.70	61	19.0	79.4	79	2.0	No
	2450	Back	0	4.70	4.70	5	19.0	79.4	79	24.7	Yes
	2450	Left-Tilt	0	2.85	2.85	5	19.0	79.4	79	24.7	Yes
	2450	Right-Tilt	0	21.05	21.05	21	19.0	79.4	79	5.9	No
	2450	Top	0	28.10	28.10	28	19.0	79.4	79	4.4	No
	2450	Bottom	0	6.40	6.40	6	19.0	79.4	79	20.6	Yes
Bluetooth	2450	Front	0	60.7	60.70	61	9.5	8.9	9	0.2	No
	2450	Back	0	4.7	4.70	5	9.5	8.9	9	2.8	No
	2450	Left-Tilt	0	2.85	2.85	5	9.5	8.9	9	2.8	No
	2450	Right-Tilt	0	21.05	21.05	21	9.5	8.9	9	0.7	No
	2450	Top	0	28.10	28.10	28	9.5	8.9	9	0.5	No
	2450	Bottom	0	6.40	6.40	6	9.5	8.9	9	2.3	No

1.8. Test Specification, Methods and Procedures

Test Specification

FCC 47 CFR 2.1093 Radiofrequency radiation exposure evaluation: portable devices

Test Methods

- IEEE Std 1528-2013 IEEE Recommended Practice for Determining the Peak Spatial-Average Specific Absorption Rate (SAR) in the Human Head from Wireless Communications Devices: Measurement Techniques
- KDB 248227 D01 v02r02 SAR Guidance for IEEE 802.11 (Wi-Fi) Transmitters
- KDB 447498 D01 v06 Mobile and Portable Devices RF Exposure Procedures and Equipment Authorization Policies
- KDB 447498 D02 v02r01 SAR Measurement Procedures for USB Dongle Transmitters
- KDB 615223 D01 v01r01 802.16e/WiMax SAR Measurement Guidance
- KDB 616217 D04 v01r02 SAR Evaluation Considerations for Laptop, Notebook, Netbook and Tablet Computers
- KDB 643646 D01 v01r03 SAR Test Reduction Considerations for Occupational PTT Radios
- KDB 648474 D03 v01r03 Evaluation and Approval Considerations for Handsets with Specific Wireless Charging Battery Covers
- KDB 648474 D04 v01r03 SAR Evaluation Considerations for Wireless Handsets
- KDB 865664 D01 v01r04 SAR Measurement Requirements for 100 MHz to 6 GHz
- KDB 941225 D01 v03r01 3G SAR Measurement Procedures
- KDB 941225 D05 v02r04 SAR Evaluation Considerations for LTE Devices
- KDB 941225 D06 v02r01 SAR Evaluation Procedures for Portable Devices with Wireless Router Capabilities
- KDB 941225 D07 v01r02 SAR Evaluation Procedures for UMPC Mini-Tablet Devices

Test Procedures

The SAR tests were performed according to the procedures of Sony EMCS EMC/RF Test Laboratory, the Document No. NV3-2 and NV3-16, available upon request.

- No deviation from the procedures
- Deviation from the procedures
- _____

References

- [1] ICNIRP. Guidelines for limiting exposure to time-varying electric, magnetic, and electromagnetic fields (up to 300 GHz). Health Physics 74(4): 494-522, 1998.
- [2] American National Standards Institute (ANSI), "Safety Levels with Respect to Human Exposure to Radio Frequency Electromagnetic Fields, 3 kHz to 300 GHz," ANSI/IEEE C95.1-1992.
- [3] Health Canada, "Limits of Human Exposure to Radiofrequency Electromagnetic Energy in the Frequency Range from 3 kHz to 300 GHz," Safety Code 6 (2009).
- [4] European Council Recommendation 1999/519/EC of 12 July 1999 on the limitation of exposure of the general public to electromagnetic fields (0 Hz to 300 GHz) (Official Journal L 199 of 30 July 1999).
- [5] R&TTECA Technical Guidance Note nr. 20 (TGN 20), SAR Testing and Assessment Guidance, Version 1.0, December 2014.
- [6] Australian Communications and Media Authority (ACMA), Radiocommunications (Electromagnetic Radiation - Human Exposure) Standard 2014.
- [7] Schmid & Partner Engineering AG (SPEAG), DASY52 System Handbook, April 2014.
- [8] Schmid & Partner Engineering AG (SPEAG), Safety Data Sheet, Doc No 772-SLAAx0yy-J, June 14, 2013.
- [9] Schmid & Partner Engineering AG (SPEAG), Safety Data Sheet, Doc No 772-SLAAx1yy-I, October 18, 2013.
- [10] Schmid & Partner Engineering AG (SPEAG), Safety Data Sheet, Doc No 772-SLAAx6yy-H, September 26, 2013.
- [11] Schmid & Partner Engineering AG (SPEAG), Material Safety Data Sheet, Doc No 772-SLAAH502A-D, August 9, 2013.
- [12] Schmid & Partner Engineering AG (SPEAG), Material Safety Data Sheet, Doc No 772-SLAAx4yy-J, August 9, 2013.

1.9. Test Facilities and Accreditation

Test Facilities

Test Facility Name : Sony EMCS EMC/ RF Test Laboratory Main Lab.
Address : Kisarazu Site 8-4 Shiomi Kisarazu-shi, Chiba, 292-0834 Japan
Shielded Room Used : 4th Site Shielded Room 2 4th Site Shielded Room 3

A2LA Accreditation

Certificate No. : 3203.01
Expiration : October 31, 2017

2. Test Set-up

2.1. Test Equipment and Measurement Software Lists

Table 2-1 Test Equipment List

Used	Control No.	Equipment Description	Model No.	Serial No.	Manufacturer	Cal. Int.	Last Cal.	Note(s)
<input checked="" type="checkbox"/>	W128	Robot	TX60 L	F14/5VR2B1/A/01	Staubli	N/A	N/A *1	
<input type="checkbox"/>	W124	Robot	RX60B L	F04/5Z71A1/A/03	Staubli	N/A	N/A *1	
<input type="checkbox"/>	WA02	E-Field Probe	EX3DV4	3921	SPEAG	1Y	15.05.29	
<input checked="" type="checkbox"/>	WA18	E-Field Probe	EX3DV4	7301	SPEAG	1Y	15.06.19	
<input checked="" type="checkbox"/>	W095	Data Acquisition Electronics	DAE4	482	SPEAG	1Y	15.08.25	
<input type="checkbox"/>	W096	Data Acquisition Electronics	DAE4	610	SPEAG	1Y	15.01.14	
<input type="checkbox"/>	W141	Data Acquisition Electronics	DAE4	516	SPEAG	1Y	15.04.24	
<input type="checkbox"/>	W097	Data Acquisition Electronics	DAE4	328	SPEAG	1Y	15.05.22	
<input type="checkbox"/>	W081	Twin SAM Phantom	Twin SAM	TP-1441	SPEAG	N/A	N/A *1	
<input type="checkbox"/>	W082	Twin SAM Phantom	Twin SAM	TP-1325	SPEAG	N/A	N/A *1	
<input checked="" type="checkbox"/>	W126	Twin SAM Phantom	Twin SAM	TP-1851	SPEAG	N/A	N/A *1	
<input checked="" type="checkbox"/>	W127	Twin SAM Phantom	Twin SAM	TP-1852	SPEAG	N/A	N/A *1	
<input checked="" type="checkbox"/>	W119	ELI Phantom	ELI V5.0	1259	SPEAG	N/A	N/A *1	
<input checked="" type="checkbox"/>	WA26	System Validation Dipole	D2450V2	936	SPEAG	1Y	15.06.19	
<input type="checkbox"/>	WA28	System Validation Dipole	D5GHzV2	1183	SPEAG	1Y	15.06.22	
<input checked="" type="checkbox"/>	W121	Vector Reflectometer	DAKS_VNA R140	0111013	Copper Mountain Technologies	1Y	15.07.09	
<input checked="" type="checkbox"/>	WA29	Dielectric Probe	DAKS-3.5	1034	SPEAG	1Y	15.07.09	
<input checked="" type="checkbox"/>	M516	Signal Generator	SMR40	100548	Rohde&Schwarz	1Y	15.08.10	
<input checked="" type="checkbox"/>	W122	Power Amp	CGA020M60 2-2633R	B40550	R&K	N/A	N/A *1	
<input checked="" type="checkbox"/>	W104	Power Sensor	U2021XA	MY54040006	Agilent	1Y	15.12.14	
<input checked="" type="checkbox"/>	W105	Power Sensor	U2021XA	MY54080005	Agilent	1Y	15.12.14	
<input checked="" type="checkbox"/>	W120	Directional Coupler	4226-20	—	narda	N/A	N/A *1	
<input checked="" type="checkbox"/>	W117	Attenuator	8493B 3 dB	MY39260857	Agilent	N/A	N/A *1	
<input checked="" type="checkbox"/>	W118	Attenuator	AT-110 10 dB	932968	Hirose	1Y	15.09.24	
<input checked="" type="checkbox"/>	WC17	RF Cable	SUCOFLEX 104	253269/4	HUBER+SUHNER	N/A	N/A *1	
<input checked="" type="checkbox"/>	WC18	RF Cable	SUCOFLEX 104PE	MY1592/4	HUBER+SUHNER	N/A	N/A *1	
<input checked="" type="checkbox"/>	WC19	RF Cable	SUCOFLEX 104	211789/4	HUBER+SUHNER	N/A	N/A *1	
<input checked="" type="checkbox"/>	WC20	RF Cable	SUCOFLEX 104	194851/4	HUBER+SUHNER	N/A	N/A *1	
<input checked="" type="checkbox"/>	WC21	RF Cable	SUCOFLEX 104	503095/6	HUBER+SUHNER	N/A	N/A *1	
<input checked="" type="checkbox"/>	WC22	RF Cable	SUCOFLEX 104	503094/6	HUBER+SUHNER	N/A	N/A *1	
<input type="checkbox"/>	M746	Thermometer	CTH-201	001	SANSYO	1Y	15.08.03	
<input checked="" type="checkbox"/>	M748	Thermometer	CTH-201	003	SANSYO	1Y	15.08.03	
<input type="checkbox"/>	W112	Water Thermometer	735-1	02736130	testo	1Y	15.07.08	
<input type="checkbox"/>	W113	Water Thermometer	735-1	02788580	testo	1Y	15.07.08	
<input checked="" type="checkbox"/>	W114	Water Thermometer	735-1	02788582	testo	1Y	15.08.10	
<input type="checkbox"/>	W115	Water Thermometer	735-1	02788585	testo	1Y	15.08.10	

Note(s):

*1 In-house verification is conducted periodically.

Table 2-2 Measurement Software List

Used	Control No.	Software Description	Model No.	Ver.	Manufacturer
<input type="checkbox"/>	SW-401	SAR measurement software	DASY52	52.8.8.1222	SPEAG
<input type="checkbox"/>	SW-402	SAR post-processing software	SEMCAD X	14.6.10 (7331)	SPEAG
<input checked="" type="checkbox"/>	SW-403	Dielectric measurement software	DAK	1.12.332.11	SPEAG
<input checked="" type="checkbox"/>	SW-404	SAR measurement software	DASY52	52.8.8.1222	SPEAG
<input checked="" type="checkbox"/>	SW-405	SAR post-processing software	SEMCAD X	14.6.10 (7331)	SPEAG
<input type="checkbox"/>	SW-406	SAR measurement spreadsheet	-	1.00	Main Lab.
<input checked="" type="checkbox"/>	SW-314	Power measurement software	N1918A	R03.09.00	Agilent

2.2. Measurement System Description

The DASY5 system for performing compliance tests consists of the following items:

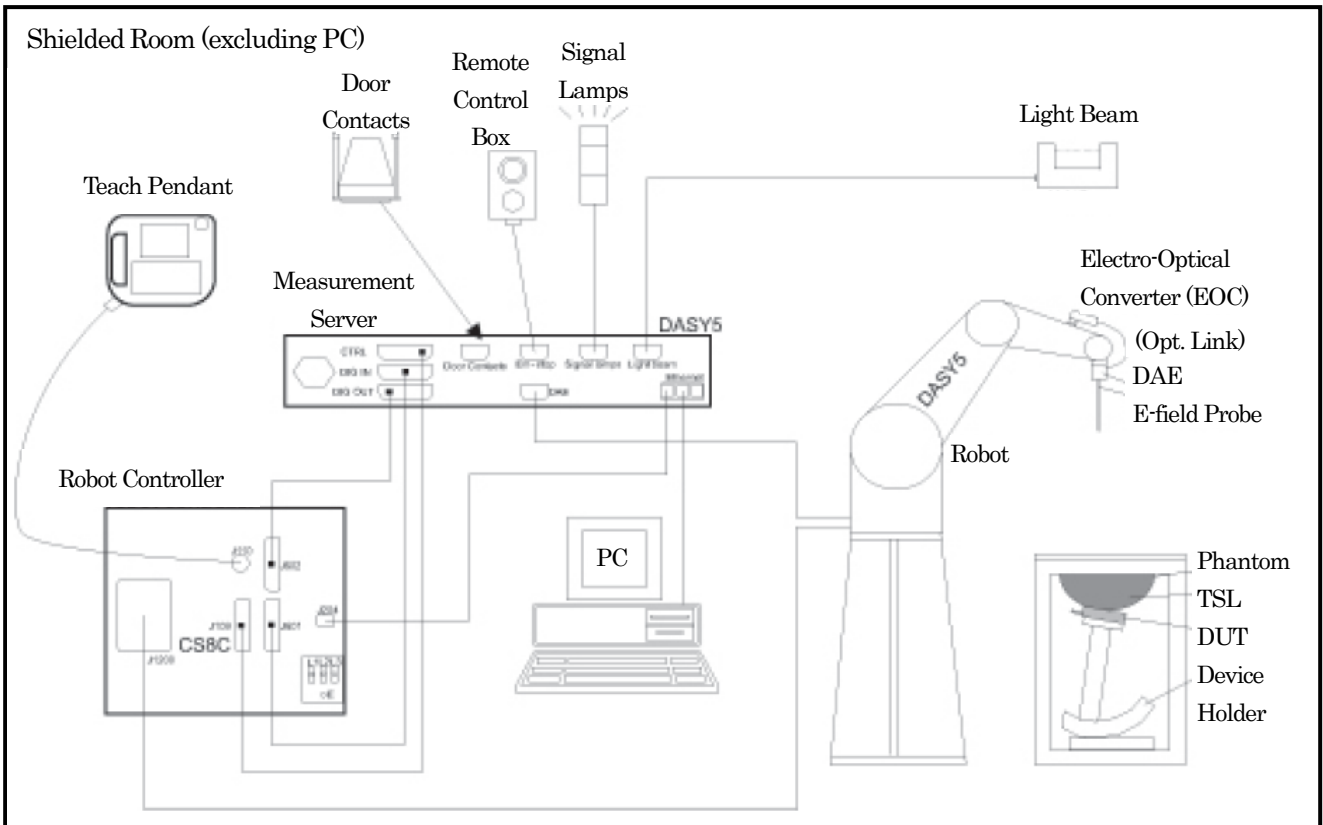

Figure 2-1 Measurement System Description

- A standard high precision 6-axis robot (Staubli TX/RX family) with controller, teach pendant and software. An arm extension for accommodating the data acquisition electronics (DAE).
- An isotropic field probe optimized and calibrated for the targeted measurement.
- A data acquisition electronics (DAE) which performs the signal amplification, signal multiplexing, AD-conversion, offset measurements, mechanical surface detection, collision detection, etc. The unit is battery powered with standard or rechargeable batteries. The signal is optically transmitted to the EOC.
- The Electro-optical converter (EOC) performs the conversion from optical to electrical signals for the digital communication to the DAE. The EOC signal is transmitted to the measurement server.
- The function of the measurement server is to perform the time critical tasks such as signal filtering, control of the robot operation and fast movement interrupts.
- The Light Beam used is for probe alignment. This improves the (absolute) accuracy of the probe positioning.
- A computer running Win7 professional operating system and the DASY5 software.
- Remote control and teach pendant as well as additional circuitry for robot safety such as warning lamps, etc.
- The phantoms (the Twin SAM and/or ELI phantoms) enabling the testing of handheld (left-hand and right-hand) and/or body-mounted usage.
- The device holders for handheld mobile phones and/or larger devices (e.g., laptops, cameras, etc.).
- Tissue simulating liquid (TSL) mixed according to the given recipes.
- System Validation Dipole Kits allowing to validate the proper functioning of the system.

2.3. Measurement System Main Components

Robot (Positioner)

	Shielded Room 2	Shielded Room 3
Manufacturer	Staubli SA	
Model No.	TX60L	RX60BL
Number of Axis	6	
Reach at Wrist	920 mm	865 mm
Repeatability	+/- 0.03 mm	+/- 0.033 mm
Nominal Load Capacity	2 kg	1.5 kg
Maximum Load Capacity	5 kg	2.5 kg
Control Unit	CS8c	CS7m
Weight	52.2 kg	45 kg

E-Field Probe

Manufacturer	Schmid & Partner Engineering AG (SPEAG)
Model No.	EX3DV4
Construction	Symmetrical design with triangular core Built-in shielding against static charges PEEK enclosure material (resistant to organic solvents, e.g., DGBE)
Frequency	10 MHz to > 6 GHz Linearity: ± 0.2 dB (30 MHz to 6 GHz)
Directivity	± 0.3 dB in TSL (rotation around probe axis) ± 0.5 dB in TSL (rotation normal to probe axis)
Dynamic Range	10 μ W/g to > 100 mW/g Linearity: ± 0.2 dB (noise: typically < 1 μ W/g)
Dimensions	Overall length: 337 mm (Tip length: 20 mm) Tip diameter: 2.5 mm (Body diameter: 12 mm) Typical distance from probe tip to dipole centers: 1 mm

Data Acquisition Electronics (DAE)

Manufacturer	Schmid & Partner Engineering AG (SPEAG)
Model No.	DAE4
Construction	Signal amplifier, multiplexer, A/D converter, and control logic Serial optical link for communication with DASY4/5 embedded system (fully remote controlled) Two-step probe touch detector for mechanical surface detection and emergency robot stop
Measurement Range	-100 to +300 mV (16 bit resolution and two range settings: 4 mV, 400 mV)
Input Offset Voltage	< 5 μ V (with auto zero)
Input Resistance	200 M Ω
Input Bias Current	< 50 fA
Battery Power	> 10 hours of operation (with two 9.6 V NiMH accus)
Dimensions (L x W x H)	60 x 60 x 68 mm

DASY5 Measurement Server

Manufacturer	Schmid & Partner Engineering AG (SPEAG)
Model No.	DASY5 Measurement Server
CPU	Intel ULV Celeron 400 MHz
Chip-Disk	128 MB
RAM	128 MB
Construction	16 Bit A/D converter for surface detection system Vacuum Fluorescent Display
I/O Interface	Robot Interface / Serial link to DAE (with watchdog supervision) / Door contact port / Emergency stop port (to connect the remote control) / Signal lamps port / Light beam port / Three Ethernet connection ports (for PC, Control Unit, and future applications) / Two USB 2.0 ports (for installation and advanced troubleshooting by SPEAG) / Two serial links (for future applications) / Expansion port (for future applications)
Dimensions (L x W x H)	440 x 241 x 89 mm

Phantoms (Twin SAM Phantom)

Manufacturer	Schmid & Partner Engineering AG (SPEAG)
Model No.	Twin SAM
Description	The shell corresponds to the specifications of the Specific Anthropomorphic Mannequin (SAM) phantom defined in IEEE 1528 and IEC 62209-1. It enables the dosimetric evaluation of left and right hand phone usage as well as body mounted usage at the flat phantom region. A cover prevents evaporation of the liquid. Reference markings on the phantom allow the complete setup of all predefined phantom positions and measurement grids by teaching three points with the robot. Twin SAM V5.0 has the same shell geometry and is manufactured from the same material as Twin SAM V4.0, but has reinforced top structure.
Material	Vynylester, glass fiber reinforced (VE-GF)
Liquid Compatibility	Compatible with all SPEAG tissue simulating liquids (incl. DGBE type)
Shell Thickness	2 ± 0.2 mm (6 ± 0.2 mm at ear point)
Dimensions	Length: 1000 mm Width: 500 mm Height: adjustable feet
Filling Volume	Approx. 25 liters
Wooden Support	SPEAG standard phantom table

Phantoms (ELI Phantom)

Manufacturer	Schmid & Partner Engineering AG (SPEAG)
Model No.	ELI V5.0
Description	Phantom for compliance testing of handheld and body-mounted wireless devices in the frequency range of 30 MHz to 6 GHz. ELI is fully compatible with the IEC 62209-2 standard and all known tissue simulating liquids. ELI has been optimized regarding its performance and can be integrated into our standard phantom tables. A cover prevents evaporation of the liquid. Reference markings on the phantom allow installation of the complete setup, including all predefined phantom positions and measurement grids, by teaching three points. The phantom is compatible with all SPEAG dosimetric probes and dipoles. ELI V5.0 has the same shell geometry and is manufactured from the same material as ELI4, but has reinforced top structure.
Material	Vynylester, glass fiber reinforced (VE-GF)
Liquid Compatibility	Compatible with all SPEAG tissue simulating liquids (incl. DGBE type)
Shell Thickness	2.0 ± 0.2 mm (bottom plate)
Dimensions	Major axis: 600 mm Minor axis: 400 mm
Filling Volume	Approx. 30 liters
Wooden Support	SPEAG standard phantom table

Device Holder (Mounting Device for Hand-Held Transmitters)

Manufacturer	Schmid & Partner Engineering AG (SPEAG)
Model No.	MD4HHTV5
Description	In combination with the Twin SAM or ELI Phantoms, the Mounting Device for Hand-Held Transmitters enables rotation of the mounted transmitter device to specified spherical coordinates. At the heads, the rotation axis is at the ear opening. Transmitter devices can be easily and accurately positioned according to IEC 62209-1, IEEE 1528, FCC, or other specifications. The device holder can be locked for positioning at different phantom sections (left head, right head, flat).
Material	Polyoxymethylene (POM)

Device Holder (Mounting Device Adaptor for Ultra Wide Transmitters)

Manufacturer	Schmid & Partner Engineering AG (SPEAG)
Model No.	MDA4WTV5
Description	An upgrade kit to Mounting Device to enable easy mounting of wider devices like big smart-phones, e-books, small tablets, etc. It holds devices with width up to 140mm.
Material	Polyoxymethylene (POM)

Device Holder (Mounting Device Adaptor for Laptops)

Manufacturer	Schmid & Partner Engineering AG (SPEAG)
Model No.	MDA4LAP
Description	A simple but effective and easy-to-use extension for the Mounting Device; facilitates testing of larger devices according to IEC 62209-2 (e.g., laptops, cameras, etc.); lightweight and fits easily on the upper part of the Mounting Device in place of the phone positioner. The extension is fully compatible with the Twin SAM, ELI Phantoms.
Material	Polyoxymethylene (POM), PET-G, Foam

System Validation Dipole Kits

Manufacturer	Schmid & Partner Engineering AG (SPEAG)		
Model No.	D-Series		
Construction	Symmetrical dipole with 1/4 balun Enables measurement of feedpoint impedance with NWA Matched for use near flat phantoms filled with tissue simulating solutions		
Frequency	750, 835, 900, 1450, 1750, 1900, 1950, 2450, 2600, 5100 to 5800 MHz		
Return Loss	> 20 dB at specified validation position		
Power Capability	> 100 W (f < 1 GHz); > 40 W (f > 1 GHz)		
Accessories	Distance holder, tripod adaptor, tripod		
Dimensions	Product	Dipole length	Overall height
	D2450V2	52.0 mm	290.0 mm
	D5GHzV2	20.6 mm	300.0 mm

2.4. Tissue Simulating Liquids

Recipes for tissue simulating liquids manufactured by SPEAG

Ingredients (% by weight)	Frequency (MHz)					
	2450		1900 to 3800		3500 to 5800	
Used	<input type="checkbox"/>	<input type="checkbox"/>	<input checked="" type="checkbox"/>	<input checked="" type="checkbox"/>	<input type="checkbox"/>	<input type="checkbox"/>
Tissue Simulating Liquids	HSL 2450 V2	MSL 2450 V2	HBBL 1900-3800 V3	MABL 1900-3800 V3	HBBL 3500-5800 V5	MABL 3500-5800 V5
Tissue Type	Head	Body	Head	Body	Head	Body
H ₂ O	52 – 75 %		50 – 73 %		50 – 65 %	60 – 80 %
Non-ionic detergents	–		25 – 50 %		–	–
NaCl	< 1.0 %		0 – 2 %		0 – 1.5 %	0 – 1.5 %
Preventol-D7	–		0.05 – 0.1 %		–	–
C ₈ H ₁₈ O ₃	25 – 48 %		–		–	–
Mineral Oil	–		–		10 – 30 %	–
Emulsifiers	–		–		8 – 25 %	20 – 40 %

For the SAR measurement, the phantom must be filled with tissue simulating liquid to a depth of at least 15 cm.

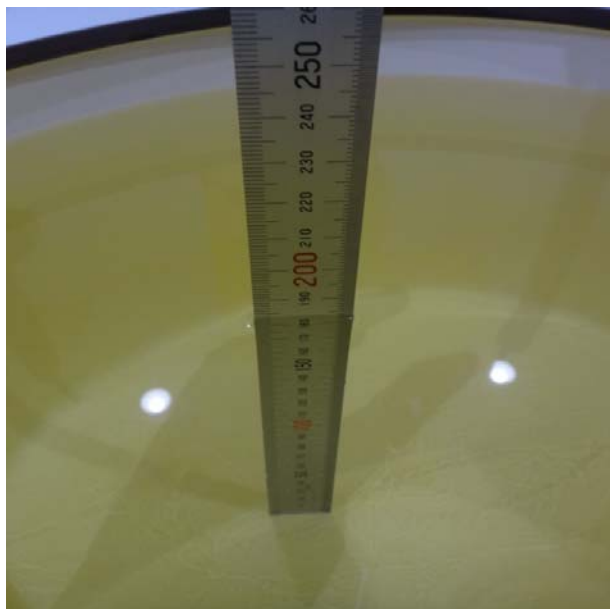

HBBL 1900-3800 V3

Figure 2-2

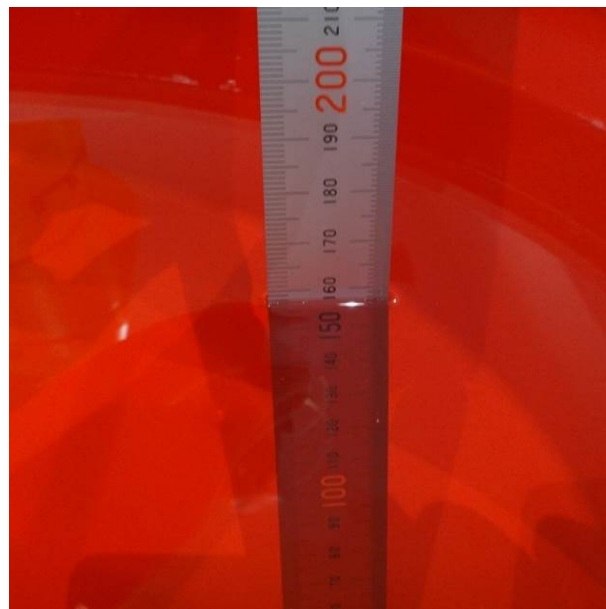

MABL 1900-3800 V3

Photos: Liquid Depth (at the center of the flat phantom)

2.5. SAR Measurement

Step 1: Power Reference Measurement

Before an area scan and after the zoom scan, single point SAR measurements are performed at defined locations to estimate the SAR measurement drift due to device output power variations.

Step 2: Area Scan

An area scan is performed according to the requirements in Table 2-3.

Step 3: Zoom Scan

A zoom scan is performed according to the requirements in Table 2-3.

Step 4: Power Drift Measurement

Before an area scan and after the zoom scan, single point SAR measurements are performed at defined locations to estimate the SAR measurement drift due to device output power variations.

Table 2-3 Area Scan and Zoom Scan Parameters

		DUT Transmit Frequency being Tested	
		≤ 3 GHz	> 3 GHz
Maximum distance from closest measurement point (geometric center of probe sensors) to phantom surface		5 ± 1 mm	$\frac{1}{2} \delta \ln(2) \pm 0.5$ mm
Maximum probe angle from probe axis to phantom surface normal at the measurement location		$30^\circ \pm 1^\circ$	$20^\circ \pm 1^\circ$
Maximum area scan spatial resolution: $\Delta x_{Area}, \Delta y_{Area}$		≤ 2 GHz: ≤ 15 mm 2 – 3 GHz: ≤ 12 mm	3 – 4 GHz: ≤ 12 mm 4 – 6 GHz: ≤ 10 mm
		When the x or y dimension of the test device, in the measurement plane orientation, is smaller than the above, the measurement resolution must be \leq the corresponding x or y dimension of the test device with at least one measurement point on the test device.	
Maximum zoom scan spatial resolution: $\Delta x_{Zoom}, \Delta y_{Zoom}$		≤ 2 GHz: ≤ 8 mm 2 – 3 GHz: ≤ 5 mm	3 – 4 GHz: ≤ 5 mm 4 – 6 GHz: ≤ 4 mm
Maximum zoom scan spatial resolution, normal to phantom surface	uniform grid: $\Delta z_{Zoom}(n)$	≤ 5 mm	3 – 4 GHz: ≤ 4 mm 4 – 5 GHz: ≤ 3 mm 5 – 6 GHz: ≤ 2 mm
	graded grid	$\Delta z_{Zoom}(1)$: between 1st two points closest to phantom surface	≤ 4 mm
		$\Delta z_{Zoom}(n>1)$: between subsequent points	$\leq 1.5 \cdot \Delta z_{Zoom}(n-1)$
Minimum zoom scan volume	x, y, z	≥ 30 mm	3 – 4 GHz: ≥ 28 mm 4 – 5 GHz: ≥ 25 mm 5 – 6 GHz: ≥ 22 mm

Note: δ is the penetration depth of a plane-wave at normal incidence to the tissue medium.

2.6. Measurement Uncertainty

☒ Table 2-4 DASY5 Uncertainty Budget for SAR Tests

According to IEEE Std 1528-2013 (0.3GHz to 3GHz range)								
Input quantity	Uncertainty of Xi			Ci		Ciu(Xi)		Vi Veff
	Xi	Prob. Dist.	Div.	1g [-]	10g [-]	1g	10g	
Measurement System								
Probe Calibration (k=1)	±6.0%	N	1.00	1.00	1.00	±6.0%	±6.0%	∞
Axial Isotropy	±4.7%	R	1.73	0.70	0.70	±1.9%	±1.9%	∞
Hemispherical Isotropy	±9.7%	R	1.73	0.70	0.70	±3.9%	±3.9%	∞
Boundary Effects	±1.0%	R	1.73	1.00	1.00	±0.6%	±0.6%	∞
Linearity	±4.7%	R	1.73	1.00	1.00	±2.7%	±2.7%	∞
System Detection Limits	±0.3%	R	1.73	1.00	1.00	±0.1%	±0.1%	∞
Modulation Response	±2.4%	R	1.73	1.00	1.00	±1.4%	±1.4%	∞
Readout Electronics	±0.3%	N	1.00	1.00	1.00	±0.3%	±0.3%	∞
Response Time	±0.8%	R	1.73	1.00	1.00	±0.5%	±0.5%	∞
Integration Time	±2.6%	R	1.73	1.00	1.00	±1.5%	±1.5%	∞
RF Ambient Noise	±0.2%	R	1.73	1.00	1.00	±0.1%	±0.1%	∞
RF Ambient Reflections	±2.7%	R	1.73	1.00	1.00	±1.6%	±1.6%	∞
Probe Positioner	±0.4%	R	1.73	1.00	1.00	±0.2%	±0.2%	∞
Probe Positioning	±2.9%	R	1.73	1.00	1.00	±1.7%	±1.7%	∞
Max. SAR Eval.	±2.0%	R	1.73	1.00	1.00	±1.2%	±1.2%	∞
Test Sample Related								
Device Positioning	±1.8%	N	1.00	1.00	1.00	±1.8%	±1.8%	14
Device Holder	±3.6%	N	1.00	1.00	1.00	±3.6%	±3.6%	5
Power Drift	±5.0%	R	1.73	1.00	1.00	±2.9%	±2.9%	∞
Power Scaling	±0.0%	R	1.73	1.00	1.00	±0.0%	±0.0%	∞
Phantom and Setup								
Phantom Uncertainty	±7.2%	R	1.73	1.00	1.00	±4.2%	±4.2%	∞
SAR Correction	±1.9%	R	1.73	1.00	0.84	±1.1%	±0.9%	∞
Liquid Conductivity (mea.)	±2.5%	R	1.73	0.78	0.71	±1.1%	±1.0%	∞
Liquid Permittivity (mea.)	±2.5%	R	1.73	0.23	0.26	±0.3%	±0.4%	∞
Temp. Unc. - Conductivity	±3.4%	R	1.73	0.78	0.71	±1.5%	±1.4%	∞
Temp. Unc. - Permittivity	±0.4%	R	1.73	0.23	0.26	±0.1%	±0.1%	∞
Combined Standard Uncertainty						±11.0%	±10.9%	422
Expanded Uncertainty (95% conf. interval)			k=2			±22.0%	±21.9%	

Table 2-5 DASY5 Uncertainty Budget for SAR Tests

According to IEEE Std 1528-2013 (3GHz to 6GHz range)								
Input quantity	Uncertainty of Xi			Ci		Ciu(Xi)		Vi Veff
	Xi	Prob. Dist.	Div.	1g [-]	10g [-]	1g	10g	
Measurement System								
Probe Calibration (k=1)	±6.55%	N	1.00	1.00	1.00	±6.6%	±6.6%	∞
Axial Isotropy	±4.7%	R	1.73	0.70	0.70	±1.9%	±1.9%	∞
Hemispherical Isotropy	±9.7%	R	1.73	0.70	0.70	±3.9%	±3.9%	∞
Boundary Effects	±2.0%	R	1.73	1.00	1.00	±1.2%	±1.2%	∞
Linearity	±4.7%	R	1.73	1.00	1.00	±2.7%	±2.7%	∞
System Detection Limits	±0.3%	R	1.73	1.00	1.00	±0.1%	±0.1%	∞
Modulation Response	±2.4%	R	1.73	1.00	1.00	±1.4%	±1.4%	∞
Readout Electronics	±0.3%	N	1.00	1.00	1.00	±0.3%	±0.3%	∞
Response Time	±0.8%	R	1.73	1.00	1.00	±0.5%	±0.5%	∞
Integration Time	±2.6%	R	1.73	1.00	1.00	±1.5%	±1.5%	∞
RF Ambient Noise	±0.2%	R	1.73	1.00	1.00	±0.1%	±0.1%	∞
RF Ambient Reflections	±2.7%	R	1.73	1.00	1.00	±1.6%	±1.6%	∞
Probe Positioner	±0.8%	R	1.73	1.00	1.00	±0.5%	±0.5%	∞
Probe Positioning	±6.7%	R	1.73	1.00	1.00	±3.9%	±3.9%	∞
Max. SAR Eval.	±4.0%	R	1.73	1.00	1.00	±2.3%	±2.3%	∞
Test Sample Related								
Device Positioning	±1.8%	N	1.00	1.00	1.00	±1.8%	±1.8%	14
Device Holder	±3.6%	N	1.00	1.00	1.00	±3.6%	±3.6%	5
Power Drift	±5.0%	R	1.73	1.00	1.00	±2.9%	±2.9%	∞
Power Scaling	±0.0%	R	1.73	1.00	1.00	±0.0%	±0.0%	∞
Phantom and Setup								
Phantom Uncertainty	±7.6%	R	1.73	1.00	1.00	±4.4%	±4.4%	∞
SAR Correction	±1.9%	R	1.73	1.00	0.84	±1.1%	±0.9%	∞
Liquid Conductivity (mea.)	±2.5%	R	1.73	0.78	0.71	±1.1%	±1.0%	∞
Liquid Permittivity (mea.)	±2.5%	R	1.73	0.23	0.26	±0.3%	±0.4%	∞
Temp. Unc. - Conductivity	±3.4%	R	1.73	0.78	0.71	±1.5%	±1.4%	∞
Temp. Unc. - Permittivity	±0.4%	R	1.73	0.23	0.26	±0.1%	±0.1%	∞
Combined Standard Uncertainty						±12.1%	±12.1%	626
Expanded Uncertainty (95% conf. interval)			k=2			±24.2%	±24.1%	

☒ Table 2-6 DASYS5 Uncertainty Budget for SAR System Check

According to IEEE Std 1528-2013 (0.3GHz to 6GHz range)								
Input quantity	Uncertainty of Xi			Ci		Ciu(Xi)		Vi Veff
	Xi	Prob. Dist.	Div.	1g [-]	10g [-]	1g	10g	
Measurement System								
Probe Calibration (k=1)	±6.55%	N	1.00	1.00	1.00	±6.6%	±6.6%	∞
Axial Isotropy	±4.7%	R	1.73	0.70	0.70	±1.9%	±1.9%	∞
Hemispherical Isotropy	±9.7%	R	1.73	0.70	0.70	±3.9%	±3.9%	∞
Boundary Effects	±2.0%	R	1.73	1.00	1.00	±1.2%	±1.2%	∞
Linearity	±4.7%	R	1.73	1.00	1.00	±2.7%	±2.7%	∞
System Detection Limits	±0.3%	R	1.73	1.00	1.00	±0.1%	±0.1%	∞
Modulation Response	±0.0%	R	1.73	1.00	1.00	±0.0%	±0.0%	∞
Readout Electronics	±0.3%	N	1.00	1.00	1.00	±0.3%	±0.3%	∞
Response Time	±0.0%	R	1.73	1.00	1.00	±0.0%	±0.0%	∞
Integration Time	±0.0%	R	1.73	1.00	1.00	±0.0%	±0.0%	∞
RF Ambient Noise	±1.0%	R	1.73	1.00	1.00	±0.6%	±0.6%	∞
RF Ambient Reflections	±1.0%	R	1.73	1.00	1.00	±0.6%	±0.6%	∞
Probe Positioner	±0.8%	R	1.73	1.00	1.00	±0.5%	±0.5%	∞
Probe Positioning	±6.7%	R	1.73	1.00	1.00	±3.9%	±3.9%	∞
Max. SAR Eval.	±4.0%	R	1.73	1.00	1.00	±2.3%	±2.3%	∞
Dipole Related								
Deviation of exp. Dipole	±5.5%	R	1.73	1.00	1.00	±3.2%	±3.2%	∞
Dipole Axis to Liquid Dist.	±2.0%	R	1.73	1.00	1.00	±1.2%	±1.2%	∞
Inoput Power & SAR Drift	±3.4%	R	1.73	1.00	1.00	±2.0%	±2.0%	∞
Phantom and Setup								
Phantom Uncertainty	±7.6%	R	1.73	1.00	1.00	±4.4%	±4.4%	∞
SAR Correction	±1.9%	R	1.73	1.00	0.84	±1.1%	±0.9%	∞
Liquid Conductivity (mea.)	±2.5%	N	1.00	0.78	0.71	±2.0%	±1.8%	∞
Liquid Permittivity (mea.)	±2.5%	N	1.00	0.23	0.26	±0.6%	±0.7%	∞
Temp. Unc. - Conductivity	±3.4%	R	1.73	0.78	0.71	±1.5%	±1.4%	∞
Temp. Unc. - Permittivity	±0.4%	R	1.73	0.23	0.26	±0.1%	±0.1%	∞
Combined Standard Uncertainty						±11.6%	±11.5%	
Expanded Uncertainty (95% conf. interval)			k=2			±23.1%	±23.0%	

2.7. Dielectric Parameter Measurement of Tissue Simulating Liquids

The dielectric properties of the tissue simulating liquids used were verified within 24 hours before the SAR measurement.

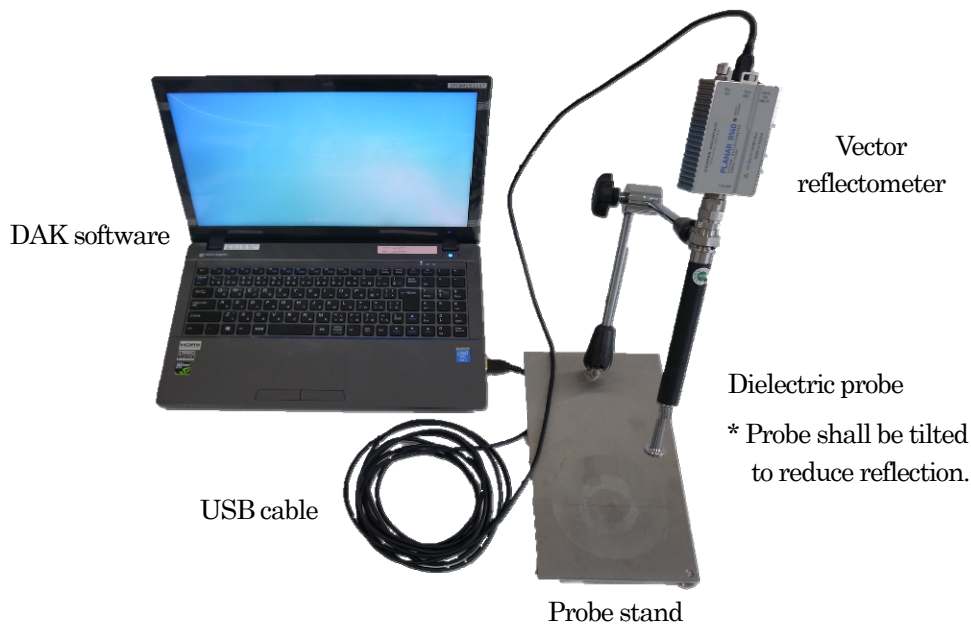

(a) Dielectric Parameter Measurement System



(b) Photo: Dielectric Parameter Measurement

Figure 2-3 Dielectric Parameter Measurement Set-up

*1 Target values are linearly interpolated between the values defined in KDB 865664 D01, when necessary.

*2 The deviation of measured values from target values must be within +/-5 %.

4th Shielded Room 2

TSL	Freq. (MHz)	Param.	Target *1	Meas.	Dev. (%) *2	Date	Amb. Temp. (deg. C)	Rel. Hum. (%RH)	Liquid Temp. (deg. C)	Note(s)
HBBL 1900-3800V3	2410	ϵ_r	39.26	39.24	-0.05	2015/12/10	25.0	37.0	24.3	
		σ (S/m)	1.76	1.79	1.46					
	2440	ϵ_r	39.21	38.98	-0.60					
		σ (S/m)	1.79	1.83	2.14					
	2460	ϵ_r	39.19	39.01	-0.44					
		σ (S/m)	1.81	1.85	2.18					
MBBL 1900-3800V3	2410	ϵ_r	52.75	51.49	-2.39	2015/12/11	25.0	61.0	24.3	
		σ (S/m)	1.90	1.95	2.70					
	2440	ϵ_r	52.71	51.47	-2.35					
		σ (S/m)	1.94	1.96	1.43					
	2460	ϵ_r	52.69	51.36	-2.52					
		σ (S/m)	1.96	2.01	2.22					
MBBL 1900-3800V3	2410	ϵ_r	52.75	51.24	-2.87	2015/12/14	25.0	51.0	24.2	
		σ (S/m)	1.90	1.94	2.27					
	2440	ϵ_r	52.71	51.16	-2.95					
		σ (S/m)	1.94	1.98	2.14					
	2460	ϵ_r	52.69	51.11	-2.99					
		σ (S/m)	1.96	2.00	1.95					

2.8. System Check Measurement

The system check was performed before each series of SAR measurements using the same probe calibration point and tissue-equivalent medium.

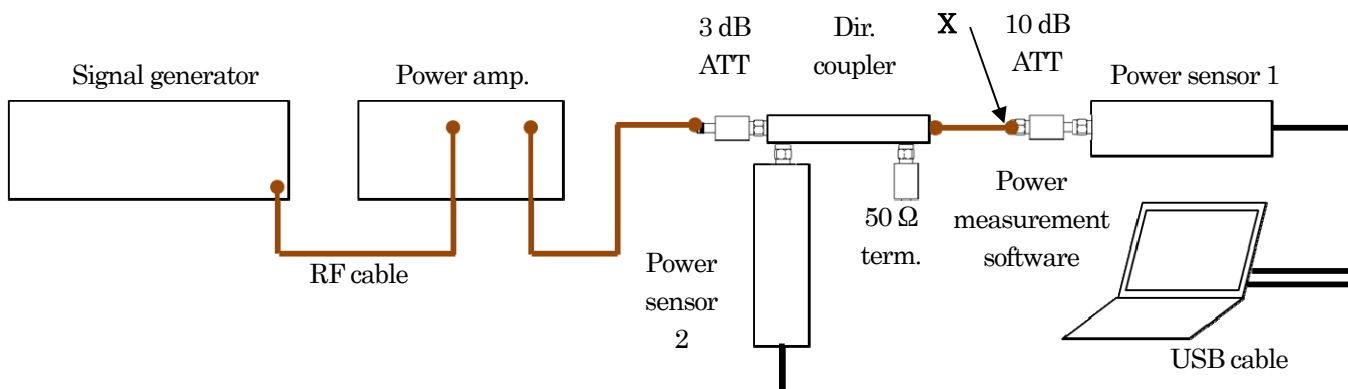

(a) Set-up 1: System Validation Dipole Input Power Adjustment

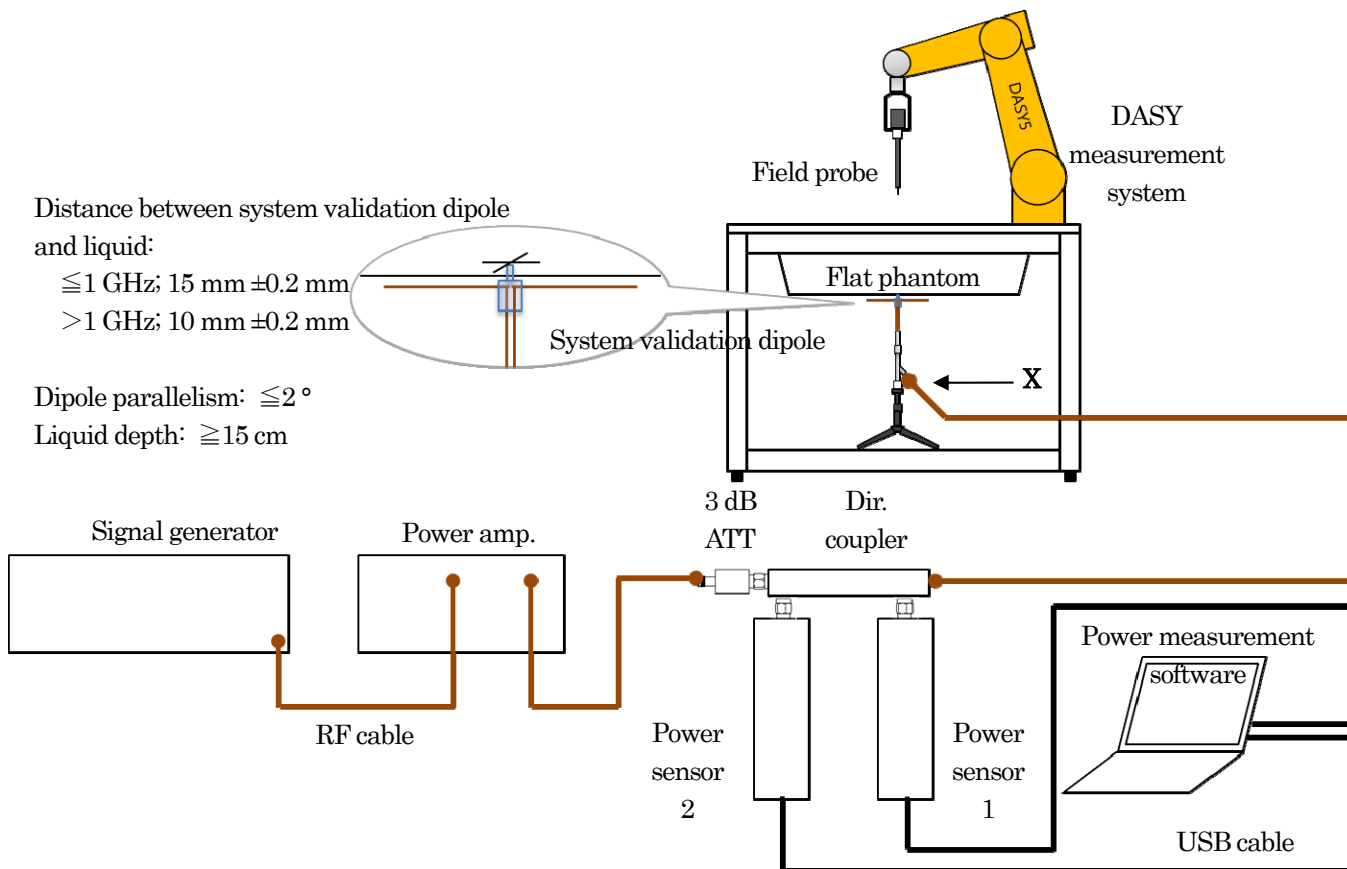

(b) Set-up 2: System Check Measurement

Figure 2-4 System Check Measurement Set-up

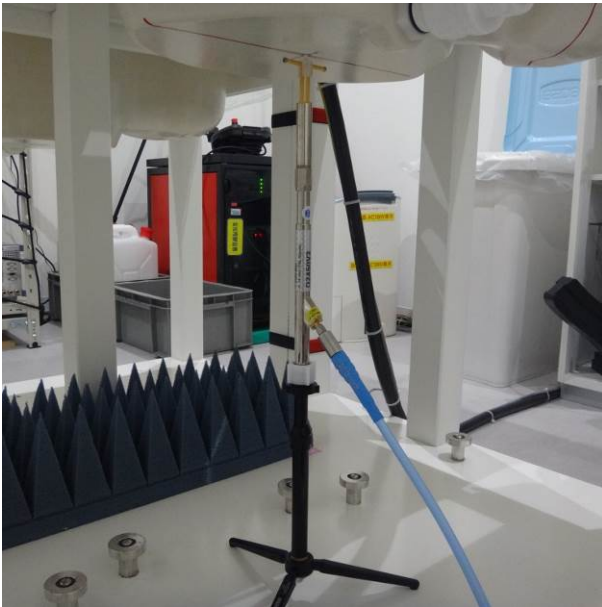

Head TSL



Body TSL

(c) Photo: System Validation Dipole Placement

Figure 2-4 System Check Measurement Set-up (continued)

*1 The normalized values (1 W) were calculated by normalizing the measured values to 1-W forward input power.

*2 The target values (1 W) are defined in IEEE Std 1528 and/or the calibration certificate of system validation dipoles used.

*3 The deviation of normalized values from target values must be within +/-10 %.

4th Shielded Room 2 (Head TSL)

System Validation Dipole	Freq. (MHz)	Param.	250 mW-Meas. (W/kg)	1 W-Norm. (W/kg) *1	1 W-Target (W/kg) *2	Dev. (%) *3	Date	Amb. Temp. (deg. C)	Rel. Hum. (%RH)	Liquid Temp. (deg. C)	Note(s)
D2450V2	2450	1-g SAR	13.40	53.60	53.80	-0.37	2015/12/10	25.0	37.0	24.3	
		10-g SAR	6.26	25.04	25.20	-0.63					

4th Shielded Room 2 (Body TSL)

System Validation Dipole	Freq. (MHz)	Param.	250 mW-Meas. (W/kg)	1 W-Norm. (W/kg) *1	1 W-Target (W/kg) *2	Dev. (%) *3	Date	Amb. Temp. (deg. C)	Rel. Hum. (%RH)	Liquid Temp. (deg. C)	Note(s)
D2450V2	2450	1-g SAR	13.30	53.20	52.40	1.53	2015/12/11	25.0	61.0	24.3	
		10-g SAR	6.24	24.96	24.60	1.46					
D2450V2	2450	1-g SAR	13.20	52.80	52.40	0.76	2015/12/14	25.0	51.0	24.2	
		10-g SAR	6.16	24.64	24.60	0.16					

3. Conducted Power Measurements

Conducted output power measurements, performed on the same test sample by UL Japan, Inc. before the SAR testing, were quoted as per the customer's request. Please refer to the Test Report No. 10879313S, issued by UL Japan, Inc.

3.1. Conducted Power Measurement Results

Wi-Fi 2.4 GHz 802.11b

Ch.	Freq. (MHz)	Power Setting	Data Rate (Mbps)	Max. Poss. Power (dBm)	Meas. Burst Averaged Power (dBm)	Within 2 dB of Max. Poss. Power	Meas. Frame Averaged Power (dBm)	SAR Tested	Note(s)
1	2412	Tune-up	1.0	19.0	18.02	Yes	18.01	Yes	
6	2437		1.0	19.0	18.05	Yes	18.04	Yes	
11	2462		1.0	19.0	18.15	Yes	18.14	Yes	Worst Ch

Wi-Fi 2.4 GHz 802.11g

Ch.	Freq. (MHz)	Power Setting	Data Rate (Mbps)	Max. Poss. Power (dBm)	Meas. Burst Averaged Power (dBm)	Within 2 dB of Max. Poss. Power	Meas. Frame Averaged Power (dBm)	SAR Tested	Note(s)
2	2417	Tune-up	6.0	19.0	17.61	Yes	17.49	No	
6	2437		6.0	19.0	17.69	Yes	17.57	No	Worst Ch
10	2457		6.0	19.0	17.66	Yes	17.55	No	

* Channels 2, 6, and 10 are measured since channels 1 and 11 require reduced output power, according to KDB 248227 D01.

* SAR is not required for 802.11g/n HT20 channels when the highest reported SAR for DSSS (802.11b) is adjusted by the ratio of OFDM to DSSS specified maximum output power and the adjusted SAR is ≤ 1.2 W/kg or 3 W/kg (1-g or 10-g respectively), according to KDB 248227 D01.

Wi-Fi 2.4 GHz 802.11n (HT20)

Ch.	Freq. (MHz)	Power Setting	MCS	Max. Poss. Power (dBm)	Meas. Burst Averaged Power (dBm)	Within 2 dB of Max. Poss. Power	Meas. Frame Averaged Power (dBm)	SAR Tested	Note(s)
2	2417	Tune-up	0	19.0	17.52	Yes	17.44	No	
6	2437		0	19.0	17.58	Yes	17.48	No	
10	2457		0	19.0	17.63	Yes	17.54	No	Worst Ch

* Channels 2, 6, and 10 are measured since channels 1 and 11 require reduced output power, according to KDB 248227 D01.

* SAR is not required for 802.11g/n HT20 channels when the highest reported SAR for DSSS (802.11b) is adjusted by the ratio of OFDM to DSSS specified maximum output power and the adjusted SAR is ≤ 1.2 W/kg or 3 W/kg (1-g or 10-g respectively), according to KDB 248227 D01.

Bluetooth (BLE)

Ch.	Freq. (MHz)	Power Setting	Data Rate (Mbps)	Max. Poss. Power (dBm)	Meas. Burst Averaged Power (dBm)	Within 2 dB of Max. Poss. Power	Meas. Frame Averaged Power (dBm)	SAR Tested	Note(s)
L	2402	Tune-up	-	9.5	8.65	Yes	6.63	No	
M	2440		-	9.5	8.95	Yes	6.92	No	Worst Ch
H	2480		-	9.5	8.39	Yes	6.36	No	

* SAR is not required for Bluetooth when SAR test exclusion is applied according to KDB 447498 D01.

3.2. Comparison of Conducted Power with Original Radio Test Report

	Mode	Max. Conducted Averaged Power	Note(s)
Original (Radio)	802.11b	18.19 dBm	Radio Test Report No. 10622710S-C, issued by UL Japan, Inc.
Class II Permissive Change (SAR)	802.11b	18.15 dBm	Burst averaged power, measured by UL Japan, Inc.
Deviation		-0.04 dB	

4. SAR Measurements

☒ <SAR Correction/Scaling>

According to KDB 865664 D01,

the maximum SAR values are determined by taking account of the following correction or scaling factors.

The maximum 1-g SAR and/or 10-g SAR values (reported SAR) are calculated by applying the Δ SAR positive correction for deviations of the tissue-equivalent liquid and the power scaling for the maximum duty factor and maximum possible power levels (maximum tune-up tolerance limit) to each measured 1-g SAR and/or 10-g SAR value:

$$\text{Reported SAR (W/kg)} = \text{Measured SAR (W/kg)} * \Delta\text{SAR positive correction factor} \\ * \text{Duty cycle scaling factor} * \text{Tune-up scaling factor}$$

where:

$$\Delta\text{SAR positive correction factor} = (100 - \Delta\text{SAR}^{*1}) / 100$$

$$\text{Duty cycle scaling factor} = \text{Max. possible duty cycle} / \text{Measured duty cycle used for the SAR measurement}$$

$$\text{Tune-up scaling factor} = \text{Max. possible power (mW)} / \text{Measured power used for the SAR measurement (mW)}$$

$$*1 \quad \Delta\text{SAR} (\%) = c_c * \Delta\epsilon_r + c_\sigma * \Delta\sigma$$

<For 1-g SAR>

$$c_c = -7.854 * 10^{-4} f^3 + 9.402 * 10^{-3} f^2 - 2.742 * 10^{-2} f - 0.2026$$

$$c_\sigma = 9.804 * 10^{-3} f^3 - 8.661 * 10^{-2} f^2 + 2.981 * 10^{-2} f + 0.7829$$

<For 10-g SAR>

$$c_c = 3.456 * 10^{-3} f^3 - 3.531 * 10^{-2} f^2 + 7.675 * 10^{-2} f - 0.1860$$

$$c_\sigma = 4.479 * 10^{-3} f^3 - 1.586 * 10^{-2} f^2 - 0.1972 f + 0.7717$$

where:

c_c coefficient representing the sensitivity of SAR to permittivity

$\Delta\epsilon_r$ percent change in permittivity

c_σ coefficient representing the sensitivity of SAR to conductivity

$\Delta\sigma$ percent change in conductivity

f frequency in GHz

A negative Δ SAR would translate to a lower measured SAR value than what would be measured if using dielectric properties equal to the target values.

A positive Δ SAR would translate to a higher measured SAR value than what would be measured if using dielectric properties equal to the target values.

SAR correction shall not be made when the Δ SAR has a positive sign to provide a conservative SAR value.

The SAR is only corrected when Δ SAR has a negative sign.

<SAR Test Reduction for Wi-Fi>

SAR test reduction for Wi-Fi is applied according to KDB 248227 D01.

The initial test position procedures

An “initial test position” is applied to further reduce the number of SAR tests for devices operating in next to the ear, UMPC mini-tablet or hotspot mode exposure configurations that require multiple test positions.

- 1) When the reported SAR of the initial test position is ≤ 0.4 W/kg or 1 W/kg (1-g or 10-g respectively), further SAR measurement is not required for the other (remaining) test positions in that exposure configuration and 802.11 transmission mode combinations within the frequency band or aggregated band. SAR is also not required for that exposure configuration in the subsequent test configuration(s).
- 2) When the reported SAR of the initial test position is > 0.4 W/kg or 1 W/kg (1-g or 10-g respectively), SAR is repeated for the 802.11 transmission mode configuration tested in the initial test position using subsequent highest extrapolated or estimated 1-g SAR conditions determined by area scans or next closest/smallest test separation distance and maximum RF coupling test positions based on manufacturer justification, on the highest maximum output power channel, until the reported SAR is ≤ 0.8 W/kg or 2 W/kg (1-g or 10-g respectively) or all required test positions (left, right, touch, tilt or subsequent surfaces and edges) are tested.
- 3) For all positions/configurations tested using the initial test position and subsequent test positions, when the reported SAR is > 0.8 W/kg or 2 W/kg (1-g or 10-g respectively), SAR is measured for these test positions/configurations on the subsequent next highest measured output power channel(s) until the reported SAR is ≤ 1.2 W/kg or 3 W/kg (1-g or 10-g respectively) or all required channels are tested.
 - a) Additional power measurements may be required for this step, which should be limited to those necessary for identifying the subsequent highest output power channels.

The 802.11b DSSS procedures

SAR is measured for 2.4 GHz 802.11b DSSS using either a fixed test position or, when applicable, the initial test position procedure.

- 1) When the reported SAR of the highest measured maximum output power channel for the exposure configuration is ≤ 0.8 W/kg or 2 W/kg (1-g or 10-g respectively), no further SAR testing is required for 802.11b DSSS in that exposure configuration.
- 2) When the reported SAR is > 0.8 W/kg or 2 W/kg (1-g or 10-g respectively), SAR is required for that exposure configuration using the next highest measured output power channel. When any reported SAR is > 1.2 W/kg or 3 W/kg (1-g or 10-g respectively), SAR is required for the third channel; i.e., all channels require testing.

For 2.4 GHz 802.11g/n OFDM configurations

SAR is not required for the following 2.4 GHz OFDM conditions.

- 1) When KDB Publication 447498 SAR test exclusion applies to the OFDM configuration.
- 2) When the highest reported SAR for DSSS is adjusted by the ratio of OFDM to DSSS specified maximum output power and the adjusted SAR is ≤ 1.2 W/kg or 3 W/kg (1-g or 10-g respectively).

The Initial Test Configuration Procedures

An initial test configuration is determined for OFDM transmission modes according to the channel bandwidth, modulation and data rate combination(s) with the highest maximum output power specified for production units in each standalone and aggregated frequency band. SAR is measured using the highest measured maximum output power channel. SAR test reduction for subsequent highest output test channels is determined according to reported SAR of the initial test configuration.

- 1) When the reported SAR of the initial test configuration is > 0.8 W/kg, SAR measurement is required for subsequent next highest measured output power channel(s) in the initial test configuration until reported SAR is ≤ 1.2 W/kg or all required channels are tested.

4.1. SAR Measurement Results

<Head-Worn SAR>

Wi-Fi 2.4 GHz

Date : 2015/12/10 Measured by : Y. Kabasawa
 Amb. Temp. : 25.0 deg. C Rel. hum. : 40.0 %RH

Mode	Ch.	Freq. (MHz)	Pos.	Dis. (mm)	Max. Poss. Power (dBm)	Meas. Power (dBm)	Max. Duty Cycle (%)	Meas. Duty Cycle (%)	Meas. 1-g SAR (W/kg)	Reported 1-g SAR (W/kg)	Liquid Temp. (deg. C)	Plot No.
Step 1: Worst Position Check												
802.11b	11	2462	Back	5	19.00	18.15	100.0	100.0	0.410	0.499	24.0	
			Left		19.00	18.15	100.0	100.0	0.552	0.671	23.9	
			Right		19.00	18.15	100.0	100.0	0.215	0.261	23.9	
			Top		19.00	18.15	100.0	100.0	0.089	0.108	24.0	
			Bottom		19.00	18.15	100.0	100.0	0.183	0.223	24.0	
Step 2: Worst Channel Check												
802.11b	1	2412	Left	5	19.00	18.02	100.0	100.0	0.593	0.743	24.1	1
	6	2437	Left		19.00	18.05	100.0	100.0	0.499	0.621	24.0	

* The burst averaged power values are used for power scaling since the maximum tune-up tolerance limits are defined as burst averaged values.

<Body-Worn SAR>

Wi-Fi 2.4 GHz

Date : 2015/12/11 Measured by : Y. Kabasawa
 Amb. Temp. : 25.0 deg. C Rel. hum. : 51.0 %RH

Mode	Ch.	Freq. (MHz)	Pos.	Dis. (mm)	Max. Poss. Power (dBm)	Meas. Power (dBm)	Max. Duty Cycle (%)	Meas. Duty Cycle (%)	Meas. 1-g SAR (W/kg)	Reported 1-g SAR (W/kg)	Liquid Temp. (deg. C)	Plot No.
Step 1: Worst Position Check												
802.11b	11	2462	Back	5	19.00	18.15	100.0	100.0	0.341	0.415	24.7	
			Left		19.00	18.15	100.0	100.0	0.567	0.690	24.5	
			Right		19.00	18.15	100.0	100.0	0.208	0.253	24.6	
			Top		19.00	18.15	100.0	100.0	0.078	0.095	24.6	
			Bottom		19.00	18.15	100.0	100.0	0.161	0.196	24.6	
Step 2: Worst Channel Check												
802.11b	1	2412	Left	5	19.00	18.02	100.0	100.0	0.571	0.716	24.4	2
	6	2437	Left		19.00	18.05	100.0	100.0	0.554	0.689	24.3	

* The burst averaged power values are used for power scaling since the maximum tune-up tolerance limits are defined as burst averaged values.

<Extremity SAR>

Wi-Fi 2.4 GHz

Date : 2015/12/14 Measured by : Y. Kabasawa
 Amb. Temp. : 25.0 deg. C Rel. hum. : 42.0 %RH

Mode	Ch.	Freq. (MHz)	Pos.	Dis. (mm)	Max. Poss. Power (dBm)	Meas. Power (dBm)	Max. Duty Cycle (%)	Meas. Duty Cycle (%)	Meas. 10-g SAR (W/kg)	Reported 10-g SAR (W/kg)	Liquid Temp. (deg. C)	Plot No.
Step 1: Worst Position Check												
802.11b	11	2462	Back	0	19.00	18.15	100.0	100.0	0.468	0.569	23.9	
			Left-Tilt		19.00	18.15	100.0	100.0	0.467	0.568	24.3	
			Bottom		19.00	18.15	100.0	100.0	0.145	0.176	23.9	
Step 2: Worst Channel Check												
802.11b	1	2412	Back	0	19.00	18.02	100.0	100.0	0.491	0.615	24.4	
	6	2437	Back		19.00	18.05	100.0	100.0	0.502	0.625	23.8	3

* The burst averaged power values are used for power scaling since the maximum tune-up tolerance limits are defined as burst averaged values.

4.2. SAR Measurement Variability

According to KDB 865664 D01, additional measurements are repeated after the completion of all measurements requiring the same head or body tissue-equivalent medium in a frequency band. The test device should be returned to ambient conditions (normal room temperature) with the battery fully charged before it is re-mounted on the device holder for the repeated measurement(s) to minimize any unexpected variations in the repeated results.

- 1) Repeated measurement is not required when the original highest measured SAR is < 0.8 or 2 W/kg (1-g or 10-g respectively); steps 2) through 4) do not apply.
- 2) When the original highest measured SAR is ≥ 0.8 or 2 W/kg (1-g or 10-g respectively), repeat that measurement once.
- 3) Perform a second repeated measurement only if the ratio of largest to smallest SAR for the original and first repeated measurements is > 1.20 or when the original or repeated measurement is ≥ 1.45 or 3.6 W/kg (~ 10% from the 1-g or 10-g respective SAR limit).
- 4) Perform a third repeated measurement only if the original, first, or second repeated measurement is ≥ 1.5 or 3.75 W/kg (1-g or 10-g respectively) and the ratio of largest to smallest SAR for the original, first and second repeated measurements is > 1.20.

Freq. Band (MHz)	RF Exposure Conditions	Position	Highest Meas. SAR (W/kg)		Repeat SAR	Repeated Meas. SAR (W/kg)	Ratio of Largest to Smallest SAR
			1-g SAR	10-g SAR			
Wi-Fi 2.4 GHz	Head-Worn	Left	1-g SAR	0.593	No	N/A	N/A
Wi-Fi 2.4 GHz	Body-Worn	Left	1-g SAR	0.571	No	N/A	N/A
Wi-Fi 2.4 GHz	Extremity	Back	10-g SAR	0.502	No	N/A	N/A

Appendix A. Plots of SAR Measurement

Please see the following page(s).

Plot No. 1

Date: 2015/12/10

Test Laboratory: Sony EMCS EMC/RF Test Laboratory Main Lab. Shielded Room 2

Wi-Fi 2.4 GHz (1ch)_Head-Worn_Left_5mm

DUT: Type1DR (installed in Digital Accessory 1DR003)

Communication System: UID 0, Wi-Fi_802.11b_1Mbps (0); Frequency: 2412 MHz

Medium parameters used (interpolated): $f = 2412$ MHz; $\sigma = 1.791$ S/m; $\epsilon_r = 39.224$; $\rho = 1000$ kg/m³

Phantom section: Flat Section

Measurement Standard: DASYS5 (IEEE/IEC/ANSI C63.19-2011)

DASY Configuration:

- Probe: EX3DV4 - SN7301; ConvF(7.32, 7.32, 7.32); Calibrated: 2015/06/19;
- Sensor-Surface: 2mm (Mechanical Surface Detection), $z = 1.0, 31.0$
- Electronics: DAE4 Sn482; Calibrated: 2015/08/25
- Phantom: SAM (20deg probe tilt) with CRP v5.0; Type: QD000P40CD; Serial: TP-1852
- DASY52 52.8.8(1222); SEMCAD X 14.6.10(7331)

Configuration/Wi-Fi 2.4GHz(1ch)_Head-Worn_Left_5mm/

Area Scan (6x11x1): Measurement grid: $dx=12$ mm, $dy=12$ mm

Maximum value of SAR (measured) = 0.854 W/kg

Configuration/Wi-Fi 2.4GHz(1ch)_Head-Worn_Left_5mm/

Zoom Scan (7x7x7)/Cube 0: Measurement grid: $dx=5$ mm, $dy=5$ mm, $dz=5$ mm

Reference Value = 21.90 V/m; Power Drift = 0.01 dB

Peak SAR (extrapolated) = 1.36 W/kg

SAR(1 g) = 0.593 W/kg; SAR(10 g) = 0.273 W/kg (SAR corrected for target medium)

Maximum value of SAR (measured) = 0.910 W/kg

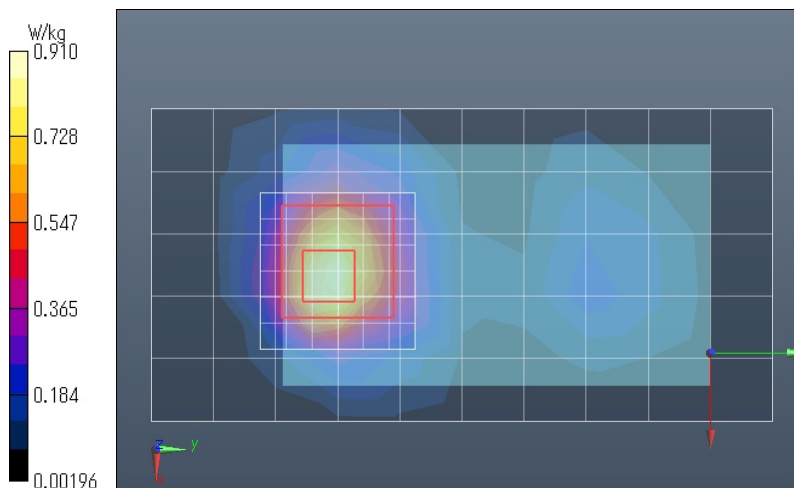

Plot No. 2

Date: 2015/12/11

Test Laboratory: Sony EMCS EMC/RF Test Laboratory Main Lab. Shielded Room 2

Wi-Fi 2.4 GHz (1ch)_Body-Worm_Left_5mm

DUT: Type1DR (installed in Digital Accessory 1DR003)

Communication System: UID 0, Wi-Fi_802.11b_1Mbps (0); Frequency: 2412 MHz

Medium parameters used (interpolated): $f = 2412$ MHz; $\sigma = 1.951$ S/m; $\epsilon_r = 51.494$; $\rho = 1000$ kg/m³

Phantom section: Flat Section

Measurement Standard: DASYS5 (IEEE/IEC/ANSI C63.19-2011)

DASY Configuration:

- Probe: EX3DV4 - SN7301; ConvF(7.43, 7.43, 7.43); Calibrated: 2015/06/19;
- Sensor-Surface: 2mm (Mechanical Surface Detection), $z = 1.0, 31.0$
- Electronics: DAE4 Sn482; Calibrated: 2015/08/25
- Phantom: SAM (20deg probe tilt) with CRP v5.0 back; Type: QD000P40CD; Serial: TP-1851
- DASY52 52.8.8(1222); SEMCAD X 14.6.10(7331)

Configuration/Wi-Fi 2.4GHz(1ch)_Body-Worm_Left_5mm/

Area Scan (6x11x1): Measurement grid: $dx=12$ mm, $dy=12$ mm

Maximum value of SAR (measured) = 0.813 W/kg

Configuration/Wi-Fi 2.4GHz(1ch)_Body-Worm_Left_5mm/

Zoom Scan (7x7x7)/Cube 0: Measurement grid: $dx=5$ mm, $dy=5$ mm, $dz=5$ mm

Reference Value = 20.50 V/m; Power Drift = 0.09 dB

Peak SAR (extrapolated) = 1.29 W/kg

SAR(1 g) = 0.571 W/kg; SAR(10 g) = 0.265 W/kg (SAR corrected for target medium)

Maximum value of SAR (measured) = 0.857 W/kg

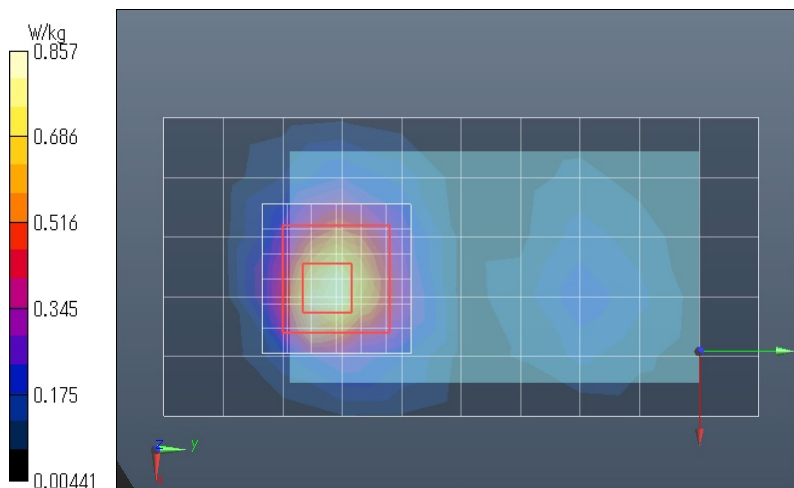

Plot No. 3

Date: 2015/12/14

Test Laboratory: Sony EMCS EMC/RF Test Laboratory Main Lab. Shielded Room 2

Wi-Fi 2.4 GHz (6ch)_Extremity_Back_0mm

DUT: Type1DR (installed in Digital Accessory 1DR003)

Communication System: UID 0, Wi-Fi_802.11b_1Mbps (0); Frequency: 2437 MHz

Medium parameters used (interpolated): $f = 2437$ MHz; $\sigma = 1.975$ S/m; $\epsilon_r = 51.159$; $\rho = 1000$ kg/m³

Phantom section: Flat Section

Measurement Standard: DASYS5 (IEEE/IEC/ANSI C63.19-2011)

DASY Configuration:

- Probe: EX3DV4 - SN7301; ConvF(7.43, 7.43, 7.43); Calibrated: 2015/06/19;
- Sensor-Surface: 2mm (Mechanical Surface Detection), $z = 1.0, 31.0$
- Electronics: DAE4 Sn482; Calibrated: 2015/08/25
- Phantom: ELI v5.0 (20deg probe tilt); Type: QDOVA002AA; Serial: 1259
- DASY52 52.8.8(1222); SEMCAD X 14.6.10(7331)

Configuration/Wi-Fi 2.4GHz (6ch)_Extremity_Back_0mm/

Area Scan (6x7x1): Measurement grid: $dx=12$ mm, $dy=12$ mm

Maximum value of SAR (measured) = 1.30 W/kg

Configuration/Wi-Fi 2.4GHz (6ch)_Extremity_Back_0mm/

Zoom Scan (7x7x7)/Cube 0: Measurement grid: $dx=5$ mm, $dy=5$ mm, $dz=5$ mm

Reference Value = 25.59 V/m; Power Drift = 0.11 dB

Peak SAR (extrapolated) = 2.55 W/kg

SAR(1 g) = 1.13 W/kg; **SAR(10 g) = 0.502 W/kg** (SAR corrected for target medium)

Maximum value of SAR (measured) = 1.78 W/kg

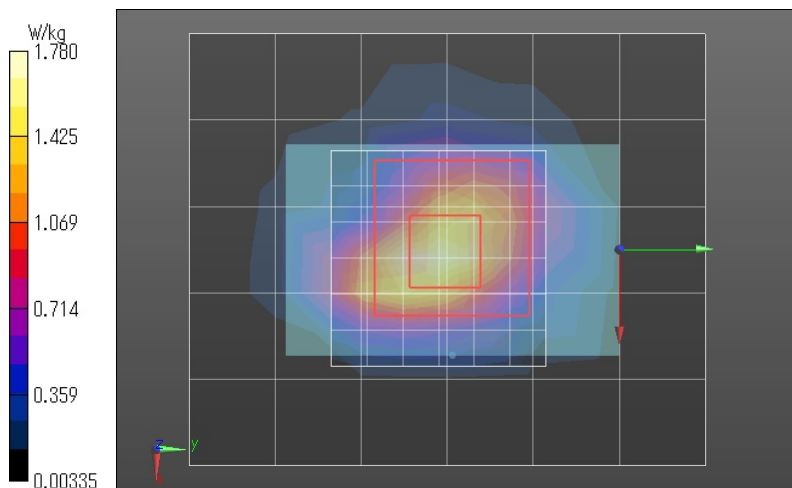

Appendix B. Plots of System Check

Please see the following page(s).

Test Laboratory: Sony EMCS EMC/RF Test Laboratory Main Lab. Shielded Room 2

Validation_D2450_HSL

DUT: Dipole 2450 MHz; Type: D2450V2; Serial: 936

Communication System: UID 0, CW; Frequency: 2450 MHz

Medium parameters used: $f = 2450$ MHz; $\sigma = 1.836$ S/m; $\epsilon_r = 39.056$; $\rho = 1000$ kg/m³

Phantom section: Flat Section

Measurement Standard: DASYS (IEEE/IEC/ANSI C63.19-2011)

DASY Configuration:

- Probe: EX3DV4 - SN7301; ConvF(7.32, 7.32, 7.32); Calibrated: 2015/06/19;
- Sensor-Surface: 2mm (Mechanical Surface Detection), $z = 1.0, 31.0$
- Electronics: DAE4 Sn482; Calibrated: 2015/08/25
- Phantom: SAM (20deg probe tilt) with CRP v5.0; Type: QD000P40CD; Serial: TP-1852
- DASYS 52.8.8(1222); SEMCAD X 14.6.10(7331)

System Performance Check at Frequencies above 2 GHz/

Validation D2450 HSL /Area Scan (8x8x1): Measurement grid: dx=12mm, dy=12mm

Maximum value of SAR (measured) = 14.6 W/kg

System Performance Check at Frequencies above 2 GHz/

Validation D2450 HSL 1st/Zoom Scan (7x7x7) (7x7x7)/Cube 0: Measurement grid: dx=5mm, dy=5mm, dz=5mm

Reference Value = 106.1 V/m; Power Drift = 0.06 dB

Peak SAR (extrapolated) = 27.5 W/kg

SAR(1 g) = 13.4 W/kg; SAR(10 g) = 6.26 W/kg (SAR corrected for target medium)

Maximum value of SAR (measured) = 20.3 W/kg

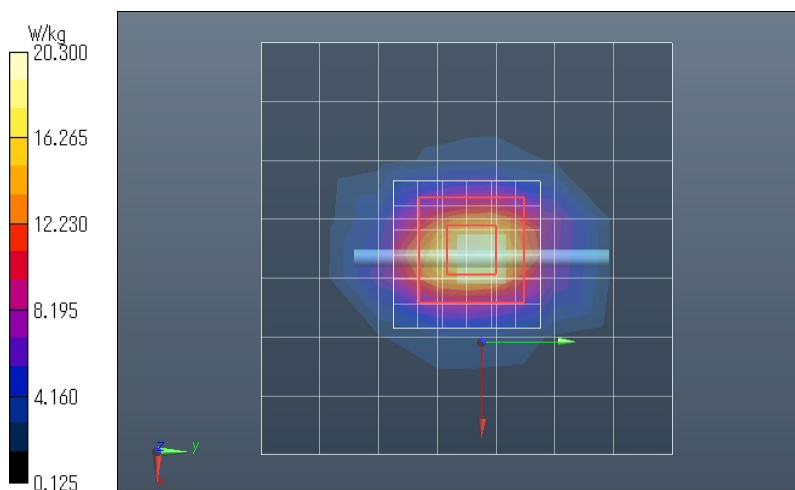

Test Laboratory: Sony EMCS EMC/RF Test Laboratory Main Lab. Shielded Room 2

Validation_D2450_MSL (1)

DUT: Dipole 2450 MHz; Type: D2450V2; Serial: 936

Communication System: UID 0, CW; Frequency: 2450 MHz

Medium parameters used: $f = 2450$ MHz; $\sigma = 1.994$ S/m; $\epsilon_r = 51.372$; $\rho = 1000$ kg/m³

Phantom section: Flat Section

Measurement Standard: DASYS5 (IEEE/IEC/ANSI C63.19-2011)

DASY Configuration:

- Probe: EX3DV4 - SN7301; ConvF(7.43, 7.43, 7.43); Calibrated: 2015/06/19;
- Sensor-Surface: 2mm (Mechanical Surface Detection), $z = 1.0, 31.0$
- Electronics: DAE4 Sn482; Calibrated: 2015/08/25
- Phantom: SAM (20deg probe tilt) with CRP v5.0 back; Type: QD000P40CD; Serial: TP-1851
- DASYS2 52.8.8(1222); SEMCAD X 14.6.10(7331)

System Performance Check at Frequencies above 2 GHz/Validation D2450 MSL/

Area Scan (8x8x1): Measurement grid: dx=12mm, dy=12mm

Maximum value of SAR (measured) = 15.9 W/kg

System Performance Check at Frequencies above 2 GHz/Validation D2450 MSL/

Zoom Scan (7x7x7) (7x7x7)/Cube 0: Measurement grid: dx=5mm, dy=5mm, dz=5mm

Reference Value = 101.7 V/m; Power Drift = 0.04 dB

Peak SAR (extrapolated) = 27.0 W/kg

SAR(1 g) = 13.3 W/kg; SAR(10 g) = 6.24 W/kg (SAR corrected for target medium)

Maximum value of SAR (measured) = 20.3 W/kg

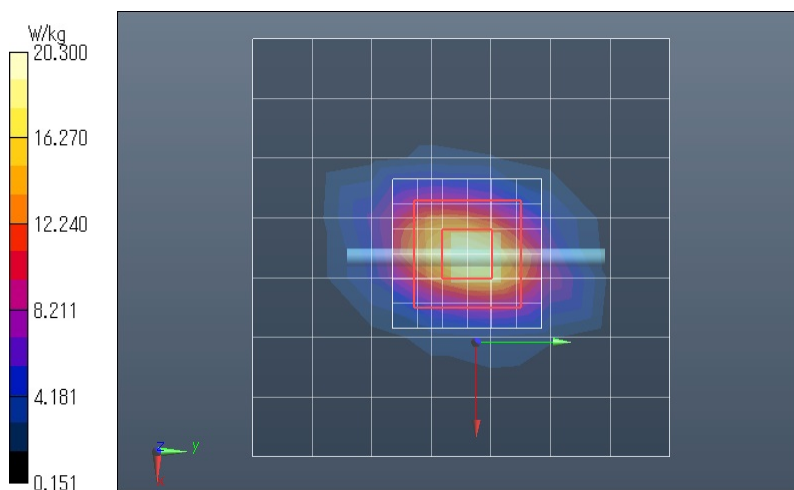

Test Laboratory: Sony EMCS EMC/RF Test Laboratory Main Lab. Shielded Room 2

Validation_D2450_MSL (2)

DUT: Dipole 2450 MHz; Type: D2450V2; Serial: 936

Communication System: UID 0, CW; Frequency: 2450 MHz

Medium parameters used: $f = 2450$ MHz; $\sigma = 1.994$ S/m; $\epsilon_r = 51.159$; $\rho = 1000$ kg/m³

Phantom section: Flat Section

Measurement Standard: DASYS5 (IEEE/IEC/ANSI C63.19-2011)

DASY Configuration:

- Probe: EX3DV4 - SN7301; ConvF(7.43, 7.43, 7.43); Calibrated: 2015/06/19;
- Sensor-Surface: 2mm (Mechanical Surface Detection), $z = 1.0, 31.0$
- Electronics: DAE4 Sn482; Calibrated: 2015/08/25
- Phantom: ELI v5.0 (20deg probe tilt); Type: QDOVA002AA; Serial: 1259
- DASYS2 52.8.8(1222); SEMCAD X 14.6.10(7331)

System Performance Check at Frequencies above 2 GHz/Validation D2450 MSL/

Area Scan (8x8x1): Measurement grid: dx=12mm, dy=12mm

Maximum value of SAR (measured) = 14.8 W/kg

System Performance Check at Frequencies above 2 GHz/Validation D2450 MSL/

Zoom Scan (7x7x7) (7x7x7)/Cube 0: Measurement grid: dx=5mm, dy=5mm, dz=5mm

Reference Value = 99.52 V/m; Power Drift = 0.23 dB

Peak SAR (extrapolated) = 26.4 W/kg

SAR(1 g) = 13.2 W/kg; SAR(10 g) = 6.16 W/kg (SAR corrected for target medium)

Maximum value of SAR (measured) = 19.8 W/kg

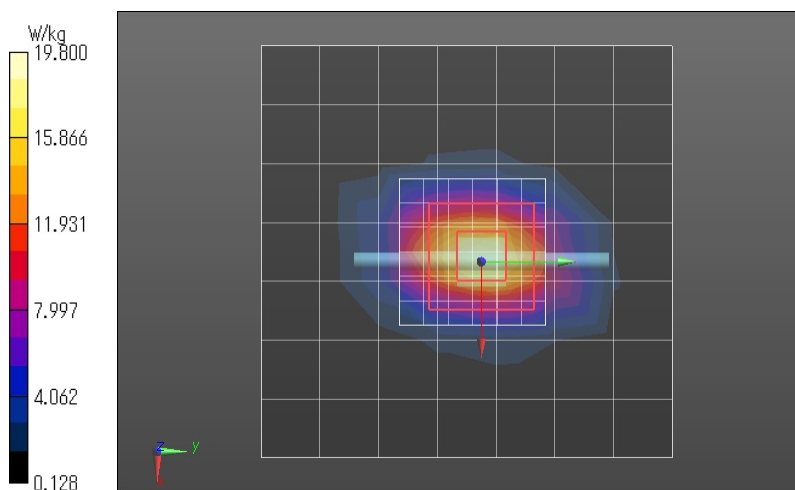

Appendix C. Calibration Certificate

C.1. E-Field Probe EX3DV4 (Serial No. 7301 / Control No. WA18)

Please see the following pages.

**Calibration Laboratory of
Schmid & Partner
Engineering AG**
Zeughausstrasse 43, 8004 Zurich, Switzerland



S Schweizerischer Kalibrierdienst
C Service suisse d'étalonnage
S Servizio svizzero di taratura
S Swiss Calibration Service

Accredited by the Swiss Accreditation Service (SAS)
The Swiss Accreditation Service is one of the signatories to the EA
Multilateral Agreement for the recognition of calibration certificates

Accreditation No.: **SCS 0108**

Client **Sony EMCS (Vitec)**

Certificate No: **EX3-7301_Jun15**

CALIBRATION CERTIFICATE

Object **EX3DV4 - SN:7301**

Calibration procedure(s) **QA CAL-01.v9, QA CAL-14.v4, QA CAL-23.v5, QA CAL-25.v6
Calibration procedure for dosimetric E-field probes**

Calibration date: **June 19, 2015**

This calibration certificate documents the traceability to national standards, which realize the physical units of measurements (SI).
The measurements and the uncertainties with confidence probability are given on the following pages and are part of the certificate.

All calibrations have been conducted in the closed laboratory facility: environment temperature (22 ± 3)°C and humidity < 70%.

Calibration Equipment used (M&TE critical for calibration)

Primary Standards	ID	Cal Date (Certificate No.)	Scheduled Calibration
Power meter E4419B	GB41293874	01-Apr-15 (No. 217-02128)	Mar-16
Power sensor E4412A	MY41498087	01-Apr-15 (No. 217-02128)	Mar-16
Reference 3 dB Attenuator	SN: S5054 (3c)	01-Apr-15 (No. 217-02129)	Mar-16
Reference 20 dB Attenuator	SN: S5277 (20x)	01-Apr-15 (No. 217-02132)	Mar-16
Reference 30 dB Attenuator	SN: S5129 (30b)	01-Apr-15 (No. 217-02133)	Mar-16
Reference Probe ES3DV2	SN: 3013	30-Dec-14 (No. ES3-3013_Dec14)	Dec-15
DAE4	SN: 660	14-Jan-15 (No. DAE4-660_Jan15)	Jan-16
Secondary Standards	ID	Check Date (in house)	Scheduled Check
RF generator HP 8648C	US3642U01700	4-Aug-99 (in house check Apr-13)	In house check: Apr-16
Network Analyzer HP 8753E	US37390585	18-Oct-01 (in house check Oct-14)	In house check: Oct-15

Calibrated by:	Name Claudio Leubler	Function Laboratory Technician	Signature
Approved by:	Name Katja Pokovic	Function Technical Manager	Signature

Issued: June 22, 2015

This calibration certificate shall not be reproduced except in full without written approval of the laboratory.

Calibration Laboratory of
Schmid & Partner
Engineering AG
Zeughausstrasse 43, 8004 Zurich, Switzerland



S Schweizerischer Kalibrierdienst
C Service suisse d'étalonnage
S Servizio svizzero di taratura
S Swiss Calibration Service

Accredited by the Swiss Accreditation Service (SAS)

Accreditation No.: SCS 0108

The Swiss Accreditation Service is one of the signatories to the EA
Multilateral Agreement for the recognition of calibration certificates

Glossary:

TSL	tissue simulating liquid
NORM _{x,y,z}	sensitivity in free space
ConvF	sensitivity in TSL / NORM _{x,y,z}
DCP	diode compression point
CF	crest factor (1/duty_cycle) of the RF signal
A, B, C, D	modulation dependent linearization parameters
Polarization φ	φ rotation around probe axis
Polarization ϑ	ϑ rotation around an axis that is in the plane normal to probe axis (at measurement center), i.e., $\vartheta = 0$ is normal to probe axis
Connector Angle	information used in DASY system to align probe sensor X to the robot coordinate system

Calibration is Performed According to the Following Standards:

- IEEE Std 1528-2013, "IEEE Recommended Practice for Determining the Peak Spatial-Averaged Specific Absorption Rate (SAR) in the Human Head from Wireless Communications Devices: Measurement Techniques", June 2013
- IEC 62209-1, "Procedure to measure the Specific Absorption Rate (SAR) for hand-held devices used in close proximity to the ear (frequency range of 300 MHz to 3 GHz)", February 2005

Methods Applied and Interpretation of Parameters:

- NORM_{x,y,z}**: Assessed for E-field polarization $\vartheta = 0$ ($f \leq 900$ MHz in TEM-cell; $f > 1800$ MHz: R22 waveguide). NORM_{x,y,z} are only intermediate values, i.e., the uncertainties of NORM_{x,y,z} does not affect the E²-field uncertainty inside TSL (see below ConvF).
- NORM(f)_{x,y,z} = NORM_{x,y,z} * frequency_response** (see Frequency Response Chart). This linearization is implemented in DASY4 software versions later than 4.2. The uncertainty of the frequency response is included in the stated uncertainty of ConvF.
- DCP_{x,y,z}**: DCP are numerical linearization parameters assessed based on the data of power sweep with CW signal (no uncertainty required). DCP does not depend on frequency nor media.
- PAR**: PAR is the Peak to Average Ratio that is not calibrated but determined based on the signal characteristics
- A_{x,y,z}; B_{x,y,z}; C_{x,y,z}; D_{x,y,z}; VR_{x,y,z}; A, B, C, D** are numerical linearization parameters assessed based on the data of power sweep for specific modulation signal. The parameters do not depend on frequency nor media. VR is the maximum calibration range expressed in RMS voltage across the diode.
- ConvF and Boundary Effect Parameters**: Assessed in flat phantom using E-field (or Temperature Transfer Standard for $f \leq 800$ MHz) and inside waveguide using analytical field distributions based on power measurements for $f > 800$ MHz. The same setups are used for assessment of the parameters applied for boundary compensation (alpha, depth) of which typical uncertainty values are given. These parameters are used in DASY4 software to improve probe accuracy close to the boundary. The sensitivity in TSL corresponds to NORM_{x,y,z} * ConvF whereby the uncertainty corresponds to that given for ConvF. A frequency dependent ConvF is used in DASY version 4.4 and higher which allows extending the validity from ± 50 MHz to ± 100 MHz.
- Spherical isotropy (3D deviation from isotropy)**: In a field of low gradients realized using a flat phantom exposed by a patch antenna.
- Sensor Offset**: The sensor offset corresponds to the offset of virtual measurement center from the probe tip (on probe axis). No tolerance required.
- Connector Angle**: The angle is assessed using the information gained by determining the NORM_x (no uncertainty required).

EX3DV4 – SN:7301

June 19, 2015

Probe EX3DV4

SN:7301

Manufactured: March 11, 2014
Calibrated: June 19, 2015

Calibrated for DASY/EASY Systems
(Note: non-compatible with DASY2 system!)

EX3DV4- SN:7301

June 19, 2015

DASY/EASY - Parameters of Probe: EX3DV4 - SN:7301**Basic Calibration Parameters**

	Sensor X	Sensor Y	Sensor Z	Unc (k=2)
Norm ($\mu\text{V}/(\text{V}/\text{m})^2$) ^A	0.55	0.32	0.61	$\pm 10.1 \%$
DCP (mV) ^B	98.3	101.4	95.7	

Modulation Calibration Parameters

UID	Communication System Name		A dB	B dB $\sqrt{\mu\text{V}}$	C	D dB	VR mV	Unc ^E (k=2)
0	CW	X	0.0	0.0	1.0	0.00	124.1	$\pm 3.5 \%$
		Y	0.0	0.0	1.0		124.0	
		Z	0.0	0.0	1.0		126.1	

The reported uncertainty of measurement is stated as the standard uncertainty of measurement multiplied by the coverage factor k=2, which for a normal distribution corresponds to a coverage probability of approximately 95%.

^A The uncertainties of NormX,Y,Z do not affect the E²-field uncertainty inside TSL (see Pages 5 and 6).

^B Numerical linearization parameter: uncertainty not required.

^E Uncertainty is determined using the max. deviation from linear response applying rectangular distribution and is expressed for the square of the field value.

EX3DV4- SN:7301

June 19, 2015

DASY/EASY - Parameters of Probe: EX3DV4 - SN:7301

Calibration Parameter Determined in Head Tissue Simulating Media

f (MHz) ^C	Relative Permittivity ^F	Conductivity (S/m) ^F	ConvF X	ConvF Y	ConvF Z	Alpha ^G	Depth ^G (mm)	Unct. (k=2)
750	41.9	0.89	10.29	10.29	10.29	0.31	1.10	± 12.0 %
835	41.5	0.90	9.90	9.90	9.90	0.27	1.22	± 12.0 %
900	41.5	0.97	9.66	9.66	9.66	0.26	1.27	± 12.0 %
1450	40.5	1.20	8.47	8.47	8.47	0.34	0.90	± 12.0 %
1750	40.1	1.37	8.35	8.35	8.35	0.38	0.81	± 12.0 %
1900	40.0	1.40	8.03	8.03	8.03	0.37	0.85	± 12.0 %
1950	40.0	1.40	7.85	7.85	7.85	0.33	0.85	± 12.0 %
2450	39.2	1.80	7.32	7.32	7.32	0.33	0.90	± 12.0 %
2600	39.0	1.96	7.19	7.19	7.19	0.42	0.84	± 12.0 %
3500	37.9	2.91	7.21	7.21	7.21	0.38	1.06	± 13.1 %
5200	36.0	4.66	5.47	5.47	5.47	0.30	1.80	± 13.1 %
5500	35.6	4.96	5.04	5.04	5.04	0.35	1.80	± 13.1 %
5800	35.3	5.27	4.72	4.72	4.72	0.40	1.80	± 13.1 %

^C Frequency validity above 300 MHz of ± 100 MHz only applies for DASY v4.4 and higher (see Page 2), else it is restricted to ± 50 MHz. The uncertainty is the RSS of the ConvF uncertainty at calibration frequency and the uncertainty for the indicated frequency band. Frequency validity below 300 MHz is ± 10, 25, 40, 50 and 70 MHz for ConvF assessments at 30, 64, 128, 150 and 220 MHz respectively. Above 5 GHz frequency validity can be extended to ± 110 MHz.

^F At frequencies below 3 GHz, the validity of tissue parameters (ϵ and σ) can be relaxed to ± 10% if liquid compensation formula is applied to measured SAR values. At frequencies above 3 GHz, the validity of tissue parameters (ϵ and σ) is restricted to ± 5%. The uncertainty is the RSS of the ConvF uncertainty for indicated target tissue parameters.

^G Alpha/Depth are determined during calibration. SPEAG warrants that the remaining deviation due to the boundary effect after compensation is always less than ± 1% for frequencies below 3 GHz and below ± 2% for frequencies between 3-6 GHz at any distance larger than half the probe tip diameter from the boundary.

EX3DV4- SN:7301

June 19, 2015

DASY/EASY - Parameters of Probe: EX3DV4 - SN:7301

Calibration Parameter Determined in Body Tissue Simulating Media

f (MHz) ^c	Relative Permittivity ^f	Conductivity (S/m) ^f	ConvF X	ConvF Y	ConvF Z	Alpha ^d	Depth (mm) ^d	Unct. (k=2)
750	55.5	0.96	9.72	9.72	9.72	0.32	1.13	± 12.0 %
835	55.2	0.97	9.69	9.69	9.69	0.31	1.14	± 12.0 %
900	55.0	1.05	9.52	9.52	9.52	0.35	1.05	± 12.0 %
1450	54.0	1.30	8.26	8.26	8.26	0.23	1.21	± 12.0 %
1750	53.4	1.49	8.12	8.12	8.12	0.35	0.88	± 12.0 %
1900	53.3	1.52	7.69	7.69	7.69	0.26	1.03	± 12.0 %
1950	53.3	1.52	8.01	8.01	8.01	0.39	0.83	± 12.0 %
2450	52.7	1.95	7.43	7.43	7.43	0.27	0.95	± 12.0 %
2600	52.5	2.16	7.28	7.28	7.28	0.22	0.99	± 12.0 %
3500	51.3	3.31	6.65	6.65	6.65	0.23	2.11	± 13.1 %
5200	49.0	5.30	4.85	4.85	4.85	0.40	1.90	± 13.1 %
5500	48.6	5.65	4.41	4.41	4.41	0.40	1.90	± 13.1 %
5800	48.2	6.00	4.51	4.51	4.51	0.45	1.90	± 13.1 %

^c Frequency validity above 300 MHz of ± 100 MHz only applies for DASY v4.4 and higher (see Page 2), else it is restricted to ± 50 MHz. The uncertainty is the RSS of the ConvF uncertainty at calibration frequency and the uncertainty for the indicated frequency band. Frequency validity below 300 MHz is ± 10, 25, 40, 50 and 70 MHz for ConvF assessments at 30, 64, 128, 150 and 220 MHz respectively. Above 5 GHz frequency validity can be extended to ± 110 MHz.

^f At frequencies below 3 GHz, the validity of tissue parameters (ϵ and σ) can be relaxed to ± 10% if liquid compensation formula is applied to measured SAR values. At frequencies above 3 GHz, the validity of tissue parameters (ϵ and σ) is restricted to ± 5%. The uncertainty is the RSS of the ConvF uncertainty for indicated target tissue parameters.

^d Alpha/Depth are determined during calibration. SPEAG warrants that the remaining deviation due to the boundary effect after compensation is always less than ± 1% for frequencies below 3 GHz and below ± 2% for frequencies between 3-6 GHz at any distance larger than half the probe tip diameter from the boundary.

EX3DV4- SN:7301

June 19, 2015

Frequency Response of E-Field (TEM-Cell:ifi110 EXX, Waveguide: R22)

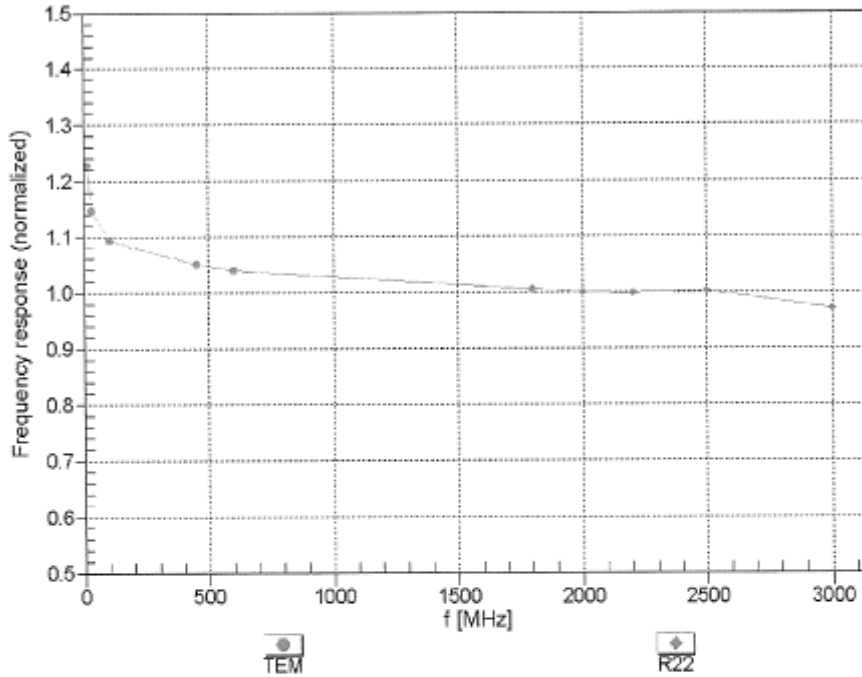

Uncertainty of Frequency Response of E-field: $\pm 6.3\%$ (k=2)

EX3DV4- SN:7301

June 19, 2015

Receiving Pattern (ϕ), $\theta = 0^\circ$

f=600 MHz,TEM

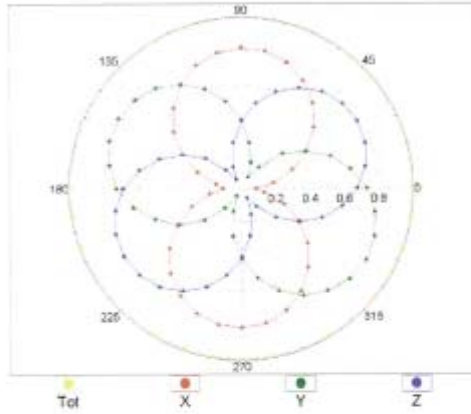

f=1800 MHz,R22

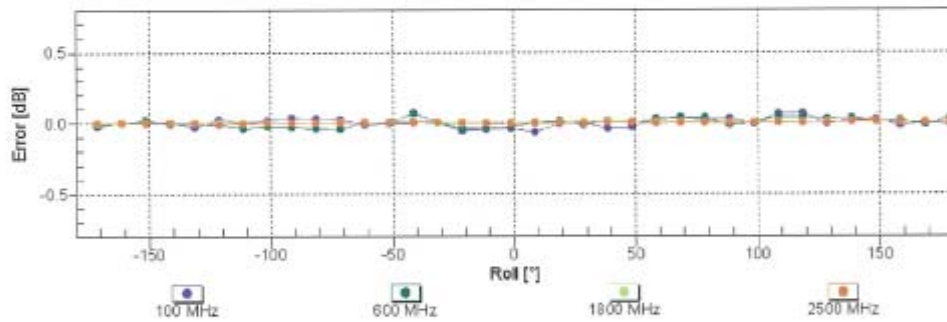
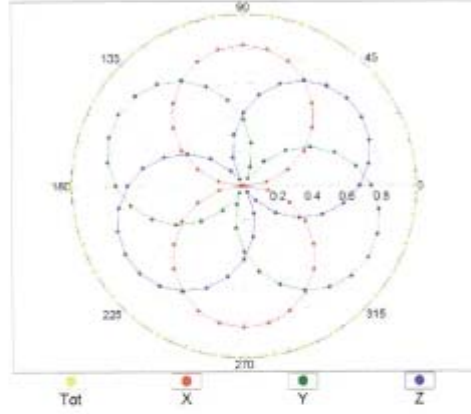

Uncertainty of Axial Isotropy Assessment: $\pm 0.5\%$ (k=2)

EX3DV4- SN:7301

June 19, 2015

Dynamic Range $f(\text{SAR}_{\text{head}})$ (TEM cell, $f_{\text{eval}} = 1900 \text{ MHz}$)

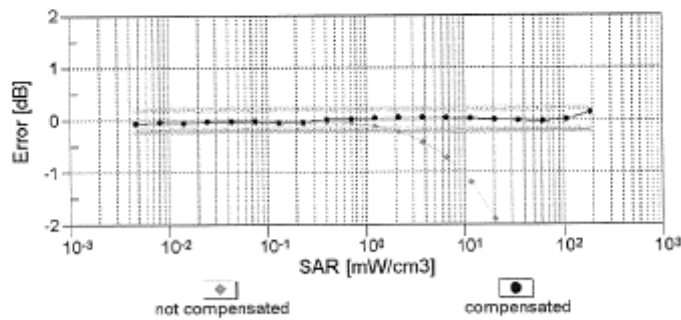
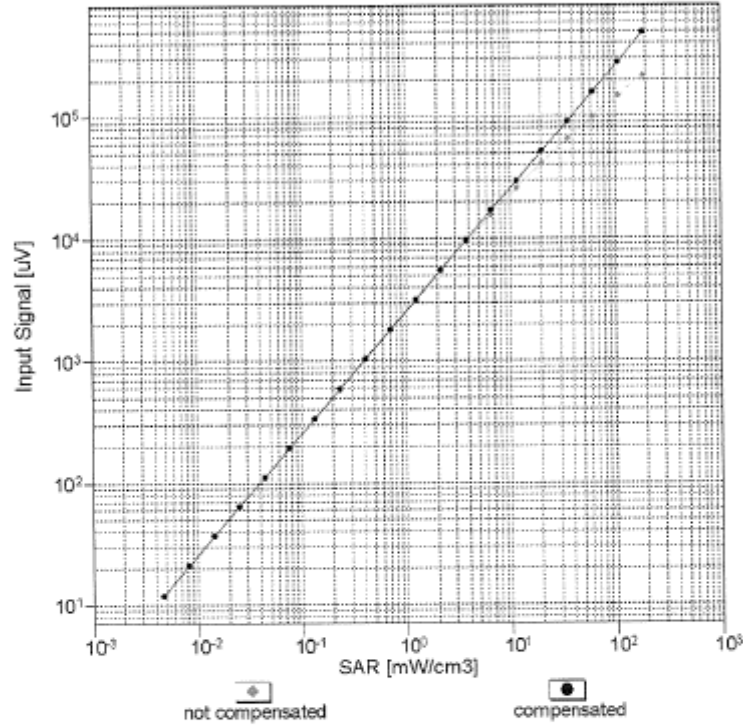

Uncertainty of Linearity Assessment: $\pm 0.6\%$ ($k=2$)

EX3DV4- SN:7301

June 19, 2015

Conversion Factor Assessment

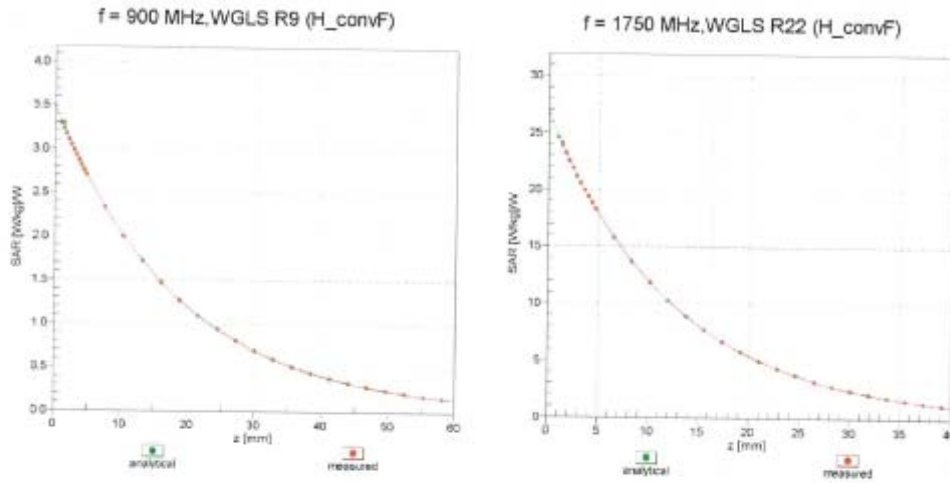

Deviation from Isotropy in Liquid Error (ϕ, ϑ), f = 900 MHz

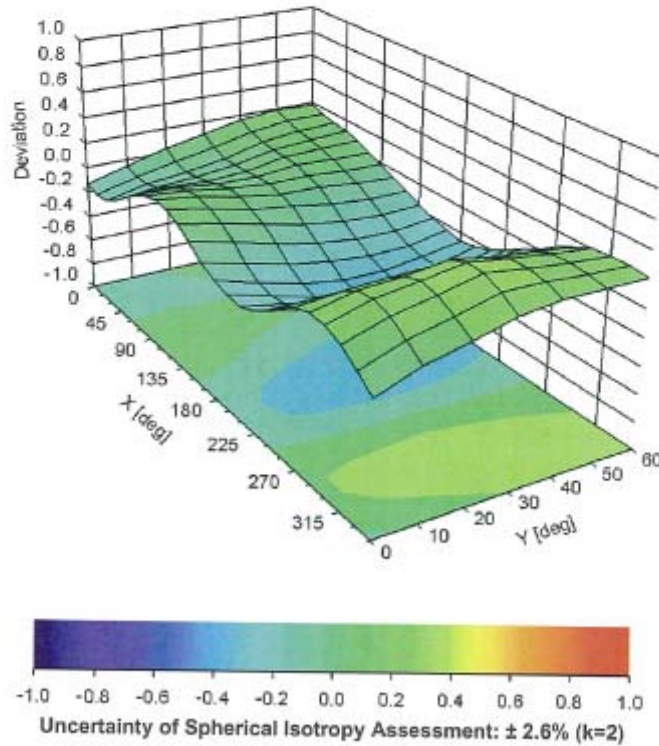

EX3DV4- SN:7301

June 19, 2015

DASY/EASY - Parameters of Probe: EX3DV4 - SN:7301

Other Probe Parameters

Sensor Arrangement	Triangular
Connector Angle (°)	138.6
Mechanical Surface Detection Mode	enabled
Optical Surface Detection Mode	disabled
Probe Overall Length	337 mm
Probe Body Diameter	10 mm
Tip Length	9 mm
Tip Diameter	2.5 mm
Probe Tip to Sensor X Calibration Point	1 mm
Probe Tip to Sensor Y Calibration Point	1 mm
Probe Tip to Sensor Z Calibration Point	1 mm
Recommended Measurement Distance from Surface	1.4 mm

C.2. System Validation Dipole D2450V2 (Serial No. 936 / Control No. WA26)

Please see the following pages.

**Calibration Laboratory of
Schmid & Partner
Engineering AG**
Zeughausstrasse 43, 8004 Zurich, Switzerland



S Schweizerischer Kalibrierdienst
C Service suisse d'étalonnage
S Servizio svizzero di taratura
S Swiss Calibration Service

Accredited by the Swiss Accreditation Service (SAS)
The Swiss Accreditation Service is one of the signatories to the EA
Multilateral Agreement for the recognition of calibration certificates

Accreditation No.: **SCS 0108**

Client **Sony EMCS (Vitec)**

Certificate No: **D2450V2-936_Jun15**

CALIBRATION CERTIFICATE

Object: **D2450V2 - SN:936**

Calibration procedure(s): **QA CAL-05.v9
Calibration procedure for dipole validation kits above 700 MHz**

Calibration date: **June 19, 2015**

This calibration certificate documents the traceability to national standards, which realize the physical units of measurements (SI).
The measurements and the uncertainties with confidence probability are given on the following pages and are part of the certificate.

All calibrations have been conducted in the closed laboratory facility: environment temperature (22 ± 3)°C and humidity < 70%.

Calibration Equipment used (M&TE critical for calibration)

Primary Standards	ID #	Cal Date (Certificate No.)	Scheduled Calibration
Power meter EPM-442A	GB37480704	07-Oct-14 (No. 217-02020)	Oct-15
Power sensor HP 8481A	US37292783	07-Oct-14 (No. 217-02020)	Oct-15
Power sensor HP 8481A	MY41092317	07-Oct-14 (No. 217-02021)	Oct-15
Reference 20 dB Attenuator	SN: 5058 (20k)	01-Apr-15 (No. 217-02131)	Mar-16
Type-N mismatch combination	SN: 5047.2 / 06327	01-Apr-15 (No. 217-02134)	Mar-16
Reference Probe ES3DV3	SN: 3205	30-Dec-14 (No. ES3-3205_Dec14)	Dec-15
DAE4	SN: 601	18-Aug-14 (No. DAE4-601_Aug14)	Aug-15

Secondary Standards	ID #	Check Date (in house)	Scheduled Check
RF generator R&S SMT-06	100005	04-Aug-99 (in house check Oct-13)	In house check: Oct-16
Network Analyzer HP 8753E	US37390585 S4206	18-Oct-01 (in house check Oct-14)	In house check: Oct-15

	Name	Function	Signature
Calibrated by:	Leif Klysner	Laboratory Technician	
Approved by:	Katja Pokovic	Technical Manager	

Issued: June 22, 2015

This calibration certificate shall not be reproduced except in full without written approval of the laboratory.

**Calibration Laboratory of
Schmid & Partner
Engineering AG**
Zeughausstrasse 43, 8004 Zurich, Switzerland



S Schweizerischer Kalibrierdienst
C Service suisse d'étalonnage
S Servizio svizzero di taratura
S Swiss Calibration Service

Accredited by the Swiss Accreditation Service (SAS)
The Swiss Accreditation Service is one of the signatories to the EA
Multilateral Agreement for the recognition of calibration certificates

Accreditation No.: **SCS 0108**

Glossary:

TSL	tissue simulating liquid
ConvF	sensitivity in TSL / NORM x,y,z
N/A	not applicable or not measured

Calibration is Performed According to the Following Standards:

- IEEE Std 1528-2013, "IEEE Recommended Practice for Determining the Peak Spatial-Averaged Specific Absorption Rate (SAR) in the Human Head from Wireless Communications Devices: Measurement Techniques", June 2013
- IEC 62209-1, "Procedure to measure the Specific Absorption Rate (SAR) for hand-held devices used in close proximity to the ear (frequency range of 300 MHz to 3 GHz)", February 2005
- IEC 62209-2, "Procedure to determine the Specific Absorption Rate (SAR) for wireless communication devices used in close proximity to the human body (frequency range of 30 MHz to 6 GHz)", March 2010
- KDB 865664, "SAR Measurement Requirements for 100 MHz to 6 GHz"

Additional Documentation:

- DASY4/5 System Handbook

Methods Applied and Interpretation of Parameters:

- Measurement Conditions:** Further details are available from the Validation Report at the end of the certificate. All figures stated in the certificate are valid at the frequency indicated.
- Antenna Parameters with TSL:** The dipole is mounted with the spacer to position its feed point exactly below the center marking of the flat phantom section, with the arms oriented parallel to the body axis.
- Feed Point Impedance and Return Loss:** These parameters are measured with the dipole positioned under the liquid filled phantom. The impedance stated is transformed from the measurement at the SMA connector to the feed point. The Return Loss ensures low reflected power. No uncertainty required.
- Electrical Delay:** One-way delay between the SMA connector and the antenna feed point. No uncertainty required.
- SAR measured:** SAR measured at the stated antenna input power.
- SAR normalized:** SAR as measured, normalized to an input power of 1 W at the antenna connector.
- SAR for nominal TSL parameters:** The measured TSL parameters are used to calculate the nominal SAR result.

The reported uncertainty of measurement is stated as the standard uncertainty of measurement multiplied by the coverage factor $k=2$, which for a normal distribution corresponds to a coverage probability of approximately 95%.

Measurement Conditions

DASY system configuration, as far as not given on page 1.

DASY Version	DASY5	V52.8.8
Extrapolation	Advanced Extrapolation	
Phantom	Modular Flat Phantom	
Distance Dipole Center - TSL	10 mm	with Spacer
Zoom Scan Resolution	dx, dy, dz = 5 mm	
Frequency	2450 MHz \pm 1 MHz	

Head TSL parameters

The following parameters and calculations were applied.

	Temperature	Permittivity	Conductivity
Nominal Head TSL parameters	22.0 °C	39.2	1.80 mho/m
Measured Head TSL parameters	(22.0 \pm 0.2) °C	38.2 \pm 6 %	1.88 mho/m \pm 6 %
Head TSL temperature change during test	< 0.5 °C	---	---

SAR result with Head TSL

SAR averaged over 1 cm ³ (1 g) of Head TSL	Condition	
SAR measured	250 mW input power	13.8 W/kg
SAR for nominal Head TSL parameters	normalized to 1W	53.8 W/kg \pm 17.0 % (k=2)

SAR averaged over 10 cm ³ (10 g) of Head TSL	condition	
SAR measured	250 mW input power	6.40 W/kg
SAR for nominal Head TSL parameters	normalized to 1W	25.2 W/kg \pm 16.5 % (k=2)

Body TSL parameters

The following parameters and calculations were applied.

	Temperature	Permittivity	Conductivity
Nominal Body TSL parameters	22.0 °C	52.7	1.95 mho/m
Measured Body TSL parameters	(22.0 \pm 0.2) °C	50.9 \pm 6 %	2.04 mho/m \pm 6 %
Body TSL temperature change during test	< 0.5 °C	---	---

SAR result with Body TSL

SAR averaged over 1 cm ³ (1 g) of Body TSL	Condition	
SAR measured	250 mW input power	13.5 W/kg
SAR for nominal Body TSL parameters	normalized to 1W	52.4 W/kg \pm 17.0 % (k=2)

SAR averaged over 10 cm ³ (10 g) of Body TSL	condition	
SAR measured	250 mW input power	6.25 W/kg
SAR for nominal Body TSL parameters	normalized to 1W	24.6 W/kg \pm 16.5 % (k=2)

Appendix (Additional assessments outside the scope of SCS 0108)**Antenna Parameters with Head TSL**

Impedance, transformed to feed point	56.1 Ω + 0.0 j Ω
Return Loss	- 24.8 dB

Antenna Parameters with Body TSL

Impedance, transformed to feed point	51.8 Ω + 2.8 j Ω
Return Loss	- 29.6 dB

General Antenna Parameters and Design

Electrical Delay (one direction)	1.152 ns
----------------------------------	----------

After long term use with 100W radiated power, only a slight warming of the dipole near the feedpoint can be measured.

The dipole is made of standard semirigid coaxial cable. The center conductor of the feeding line is directly connected to the second arm of the dipole. The antenna is therefore short-circuited for DC-signals. On some of the dipoles, small end caps are added to the dipole arms in order to improve matching when loaded according to the position as explained in the "Measurement Conditions" paragraph. The SAR data are not affected by this change. The overall dipole length is still according to the Standard.

No excessive force must be applied to the dipole arms, because they might bend or the soldered connections near the feedpoint may be damaged.

Additional EUT Data

Manufactured by	SPEAG
Manufactured on	March 13, 2014

DASY5 Validation Report for Head TSL

Date: 19.06.2015

Test Laboratory: SPEAG, Zurich, Switzerland

DUT: Dipole 2450 MHz; Type: D2450V2; Serial: D2450V2 - SN:936

Communication System: UID 0 - CW; Frequency: 2450 MHz

Medium parameters used: $f = 2450$ MHz; $\sigma = 1.88$ S/m; $\epsilon_r = 38.2$; $\rho = 1000$ kg/m³

Phantom section: Flat Section

Measurement Standard: DASY5 (IEEE/IEC/ANSI C63.19-2011)

DASY52 Configuration:

- Probe: ES3DV3 - SN3205; ConvF(4.54, 4.54, 4.54); Calibrated: 30.12.2014;
- Sensor-Surface: 3mm (Mechanical Surface Detection)
- Electronics: DAE4 Sn601; Calibrated: 18.08.2014
- Phantom: Flat Phantom 5.0 (front); Type: QD000P50AA; Serial: 1001
- DASY52 52.8.8(1222); SEMCAD X 14.6.10(7331)

Dipole Calibration for Head Tissue/Pin=250 mW, d=10mm/Zoom Scan (7x7x7)/Cube 0:

Measurement grid: dx=5mm, dy=5mm, dz=5mm

Reference Value = 102.0 V/m; Power Drift = 0.02 dB

Peak SAR (extrapolated) = 28.6 W/kg

SAR(1 g) = 13.8 W/kg; SAR(10 g) = 6.4 W/kg

Maximum value of SAR (measured) = 18.3 W/kg

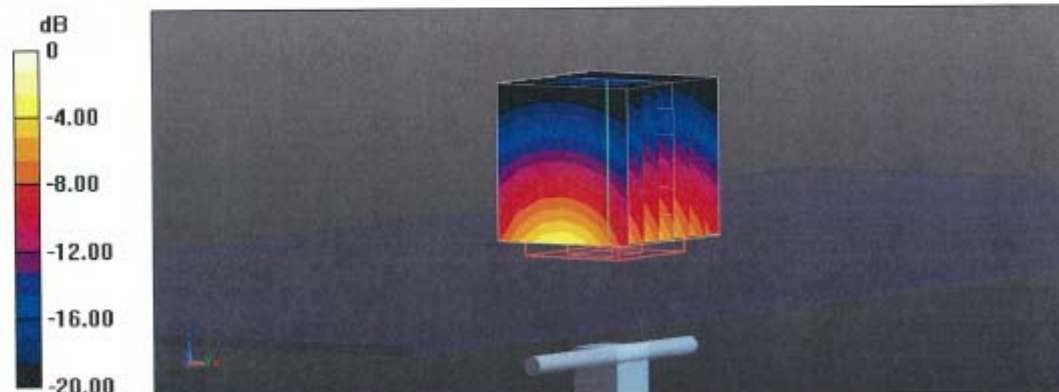

0 dB = 18.3 W/kg = 12.62 dBW/kg

Impedance Measurement Plot for Head TSL

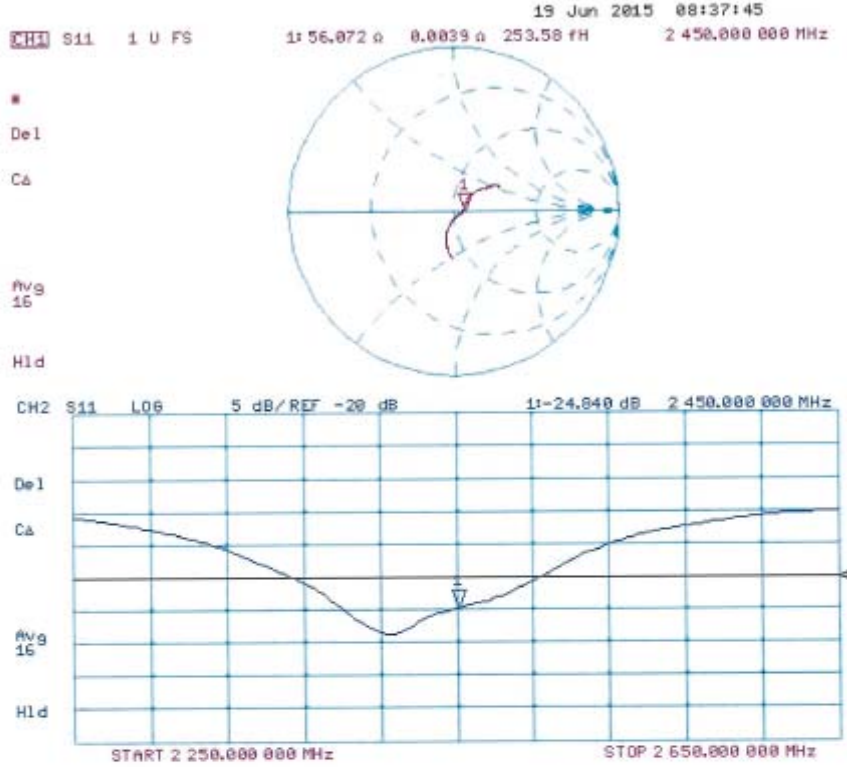

DASY5 Validation Report for Body TSL

Date: 19.06.2015

Test Laboratory: SPEAG, Zurich, Switzerland

DUT: Dipole 2450 MHz; Type: D2450V2; Serial: D2450V2 - SN:936

Communication System: UID 0 - CW; Frequency: 2450 MHz

Medium parameters used: $f = 2450$ MHz; $\sigma = 2.04$ S/m; $\epsilon_r = 50.9$; $\rho = 1000$ kg/m³

Phantom section: Flat Section

Measurement Standard: DASY5 (IEEE/IEC/ANSI C63.19-2011)

DASY52 Configuration:

- Probe: ES3DV3 - SN3205; ConvF(4.32, 4.32, 4.32); Calibrated: 30.12.2014;
- Sensor-Surface: 3mm (Mechanical Surface Detection)
- Electronics: DAE4 Sn601; Calibrated: 18.08.2014
- Phantom: Flat Phantom 5.0 (back); Type: QD000P50AA; Serial: 1002
- DASY52 52.8.8(1222); SEMCAD X 14.6.10(7331)

Dipole Calibration for Body Tissue/Pin=250 mW, d=10mm/Zoom Scan (7x7x7)/Cube 0:

Measurement grid: dx=5mm, dy=5mm, dz=5mm

Reference Value = 96.44 V/m; Power Drift = 0.00 dB

Peak SAR (extrapolated) = 28.2 W/kg

SAR(1 g) = 13.5 W/kg; SAR(10 g) = 6.25 W/kg

Maximum value of SAR (measured) = 17.9 W/kg



Impedance Measurement Plot for Body TSL

