



PowerTel 680

User Guide



Important Safety Instructions.....	6	Using the Wrist Shaker	58
Getting Started	8	Adding a Handset	66
Set up	8	Help and support	75
Phone Menu and Display Guide	15	Troubleshooting guide	75
Calling Functions	16	Technical details	78
Menu Options – Corded Phone	22	Default settings	79
Menu Options - Cordless Phone	40	Cordless handset	79
Using the answering machine.....	51	Maintenance and Warranty	81

FCC Compliance

The FCC requires that you will be advised of certain requirements involving the use of this telephone.

1. This equipment complies with Part 68 of the FCC rules. A label on the base unit of this equipment contains, among other information, the ACTA Registration Number (US:AAAEQ##TXXXX) and the Ringer Equivalence Number (REN) for this equipment. You must, upon request, provide this information to your telephone company.
2. An applicable certification jacks Universal Service Order Codes (USOC) for the equipment is provided (i.e., RJ11C) in the packaging with each piece of approved terminal equipment.
3. A plug and jack used to connect this equipment to the premises wiring and telephone network must comply with the applicable FCC Part 68 rules and requirements adopted by the ACTA. A compliant telephone cord and modular plug is provided with this product. It is designed to be connected to a compatible modular jack that is also compliant. See installation instructions for details.
4. The REN is useful to determine the quantity of devices you may connect to your telephone line and still have all of those devices ring when your number is called. In most, but not all areas, the sum of the REN of all devices should not exceed five (5.0). To be certain of the number of devices you may connect to your line, as determined by the REN, you should call your local telephone company to determine the maximum REN for your calling area.
NOTICE: If your home has specially wired alarm equipment connected to the telephone line, ensure the installation of this equipment does not disable your alarm equipment. If you have questions about what will disable alarm equipment, consult your telephone company or a qualified installer.
5. If your telephone causes harm to the telephone network, the telephone company may discontinue your service temporarily. If possible, they will notify you in advance. But if advance notice is not practical, you will be notified as soon as possible. You will be advised of your right to file a complaint with the FCC.
6. Your telephone company may make changes to its facilities, equipment, operations or procedures that could affect the proper operation of your equipment. If they do, you will be given advance notice so as to give you an opportunity to maintain uninterrupted service.
7. If you experience trouble with the telephone, please contact the Amplicom Service Center at 1-866-AMPLICOM (267-5426) for repair/warranty information. The telephone company may ask you to disconnect this equipment from the network until the problem have been corrected or you are sure that the equipment is not malfunctioning.
8. This equipment may not be used on coin service provided by the telephone company. Connection to party lines is subject to state tariffs. (Contact your state public utility commission or corporation commission for information.)

This device complies with Part 15 of the FCC Rules. Operation is subject to the following two conditions: (1) This device may not cause harmful interference, and (2) this device must accept any interference received, including interference that may cause undesired operation. Privacy of communications may not be ensured when using this phone. Changes or modifications not expressly approved in writing by Amplicom may void the user's authority to operate this equipment.

Some cordless phones operate at frequencies that may cause interference to nearby TVs and VCRs; to minimize or prevent such interference, the base of the cordless phone should not be placed near or on top of a TV or VCR; and, if interference is experienced, moving the cordless telephone farther away from the TV or VCR will often reduce or eliminate the interference.

NOTE:

1. This equipment has been tested and found to comply with the limits for a Class B digital device, pursuant to Part 15 of the FCC Rules. These limits are designed to provide reasonable protection against harmful interference in a residential installation. This equipment generates, uses and can radiate radio frequency energy and, if not installed and used in accordance with the instructions, may cause harmful interference to radio communications.

However, there is no guarantee that interference will not occur in a particular installation. If this equipment does cause harmful interference to radio or television reception, which can be determined by turning the equipment off and on, the user is encouraged to try to correct the interference by one or more of the following measures:

- Reorient or relocate the receiving antenna.
- Increase the separation between the equipment and receiver.
- Connect the equipment into an outlet on a circuit different from that to which the receiver is connected.
- Consult the dealer or an experienced radio/TV technician for help.

2. For body worn operation, this handset has been tested and meets the FCC RF exposure guidelines when used with the amplicom accessories supplied or designated for this product. Use of other accessories may not ensure compliance with FCC RF exposure guidelines.

CAUTION: To maintain the compliance with the FCC's RF exposure guideline, place the base unit at least 20 cm from nearby persons.

PowerTel 680 Cordless handset and charger base

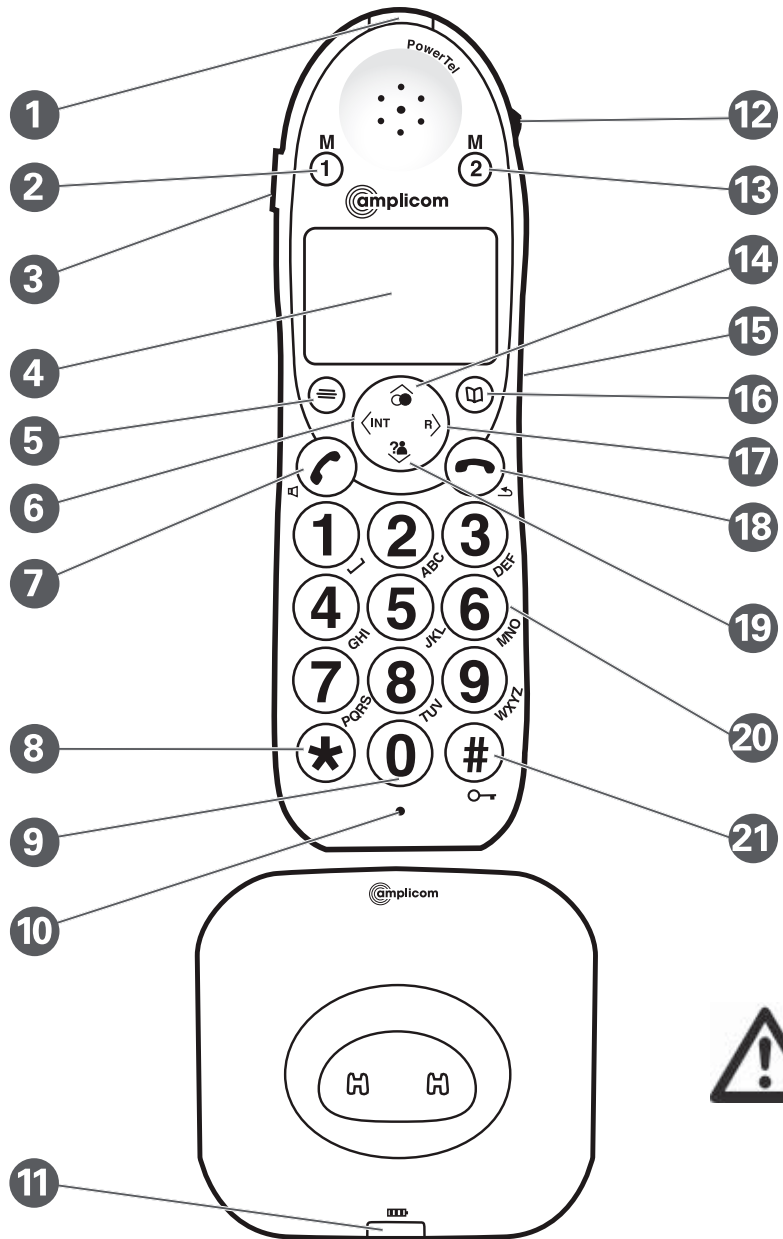

- | | |
|------------------------------------|-------------------------------------------------|
| 1 Incoming call/Boost light | 12 Volume up/down |
| 2 Memory 1 | 13 Memory 2 |
| 3 Boost | 14 Up/Redial |
| 4 Display | 15 Headset socket (Headset not included) |
| 5 Enter Menu/Mute/Delete | 16 Phone book/Save/OK |
| 6 Internal call | 17 Recall |
| 7 External call/Handsfree | 18 End call |
| 8 */Ringer on/off | 19 Down/Calls list/Equalizer |
| 9 Pause (long press 0) | 20 Keypad |
| 10 Microphone | 21 #/Keylock |
| 11 Charging | |



Warning: This Handset has been specially designed for individuals who are hard of hearing and has a normal volume which is louder than a standard phone. Use of the Boost memory feature can cause hearing damage to individuals who are not experiencing hearing loss.

Corded phone base

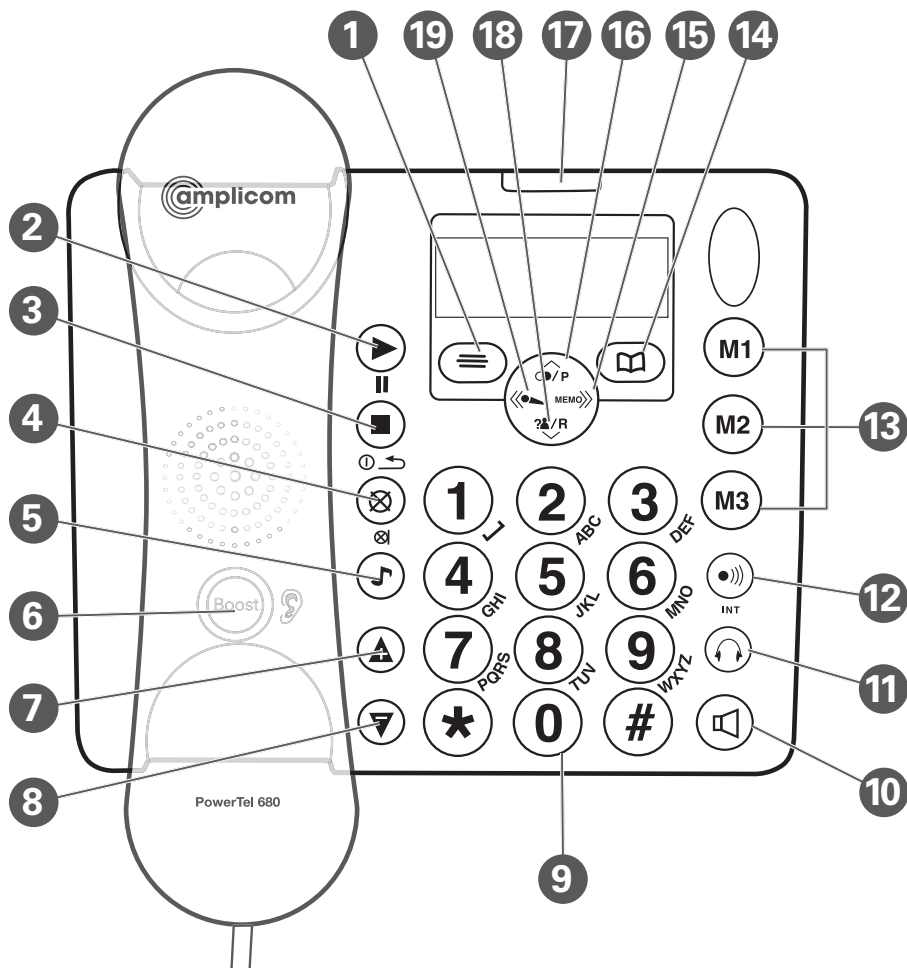

- 1** Menu/OK
- 2** Play/Pause
- 3** Stop/Esc/
Ans on off
- 4** Mute/
Delete
- 5** Equalizer
- 6** Boost
(under
handset)
- 7** Volume up
- 8** Volume
down
- 9** Keypad
- 10** Handsfree
- 11** Headset
- 12** Find handset/
Intercom/
Registration
- 13** Quick dial
memories/
User profiles
- 14** Phonebook
- 15** Fast forward/
Memo
- 16** Up/Redial/
Pause
- 17** Incoming
call light/
New
messages
received
- 18** Down/Calls
list/Recall
- 19** Rewind/
OGM

Wrist shaker

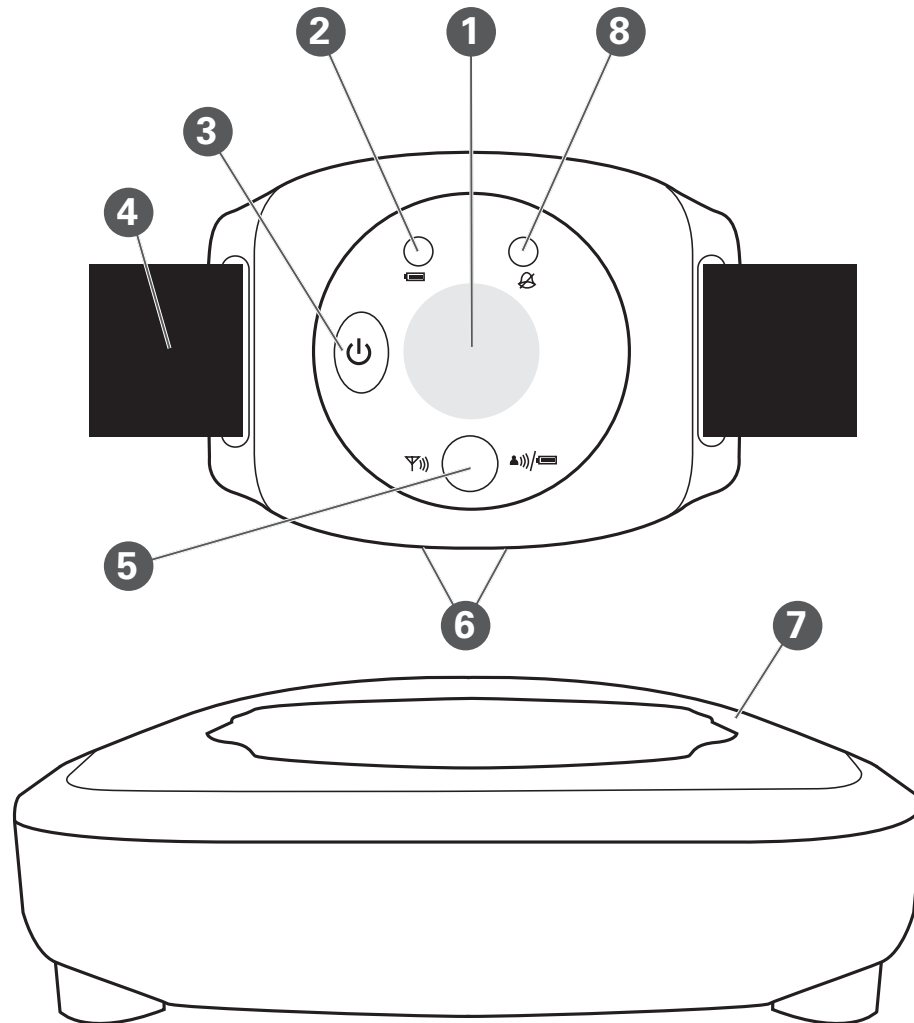

- 1 Emergency button
Note: Can only be used with the PowerTel 680 telephone
- 2 Battery charging red light
- 3 Power on/off
- 4 Wrist strap
- 5 Registration mode/
Out of range/Low battery
2 color green or red light
- 6 Charging contacts
- 7 Charging unit
- 8 Incoming call green light

Important Safety Instructions

When using your telephone equipment, basic safety precautions should always be followed to reduce the risk of fire, electric shock and injury to persons, including the following:

1. Do not use this product near water, for example, near a bath tub, wash bowl, kitchen sink or laundry tub, in a wet basement or near a swimming pool.
2. Do not use the telephone to report a gas leak in the vicinity of the leak.
3. Use only the power cord and batteries indicated in this manual. Do not dispose of batteries in a fire. They may explode. Check with local codes for possible special disposal instructions. Save these instructions for future use.

SAVE THESE INSTRUCTIONS

Intended use

This phone is suitable for use on a public telephone network. Any other use is considered unintended use. Unauthorized modification or reconstruction is not permitted. **Do not** open the device and attempt any repair work yourself.

Phone location

Locate the base, corded phone, and wrist-shaker base:

- On a dry, flat and stable surface
- Where the power cable will not be a trip hazard
- Where it is not obstructed by furniture

- At least three feet from other electrical appliances
- Away from smoke, dust, vibration, chemicals, moisture, heat or direct sunlight.

Power failure – What to do

Power failure can affect your phone and equipment. Only the corded phone will work if there is a power failure.

Medical equipment

Do not use the phone near emergency or intensive care medical equipment, or during an electrical storm. If you have a pacemaker check with a medical expert before using this product.

Hearing aid compatibility

This phone works with most popular hearing aids. However, given the wide range of hearing aids available, the phone may not function fully with every hearing aid.

Telephones identified with this logo have reduced noise and interference when used with most T-coil equipped hearing aids and cochlear implants. The TIA-1083 Compliant Logo is a trademark of the Telecommunications Industry Association. Used under license.



Caution: The phone will produce high volume when Boost is switched on.

Getting Started – Included Equipment

- 1 Corded Phone Base, Handset and Answering Machine
- 1 Cordless Handset
- 1 Battery Cover
- 1 Charger Base (For Cordless Handset)
- 2 Power Adapters
- 1 Telephone Cable
- 2 Rechargeable AAA 2.4V 750mAh NiMH Battery Packs
- 1 Wrist Shaker With Strap
- 1 Charger Unit for Wrist Shaker (With Power Adapter Plug Attached)

Set up

1. Connect the corded phone base

- Plug the power adapter into the back of the corded phone base and the other end into a wall socket. Turn the power on.
- Plug the telephone cable into the back of the corded phone base and the other end into the phone wall jack.
- Plug one end of the handset cable into the handset and the other end into the side of the base.

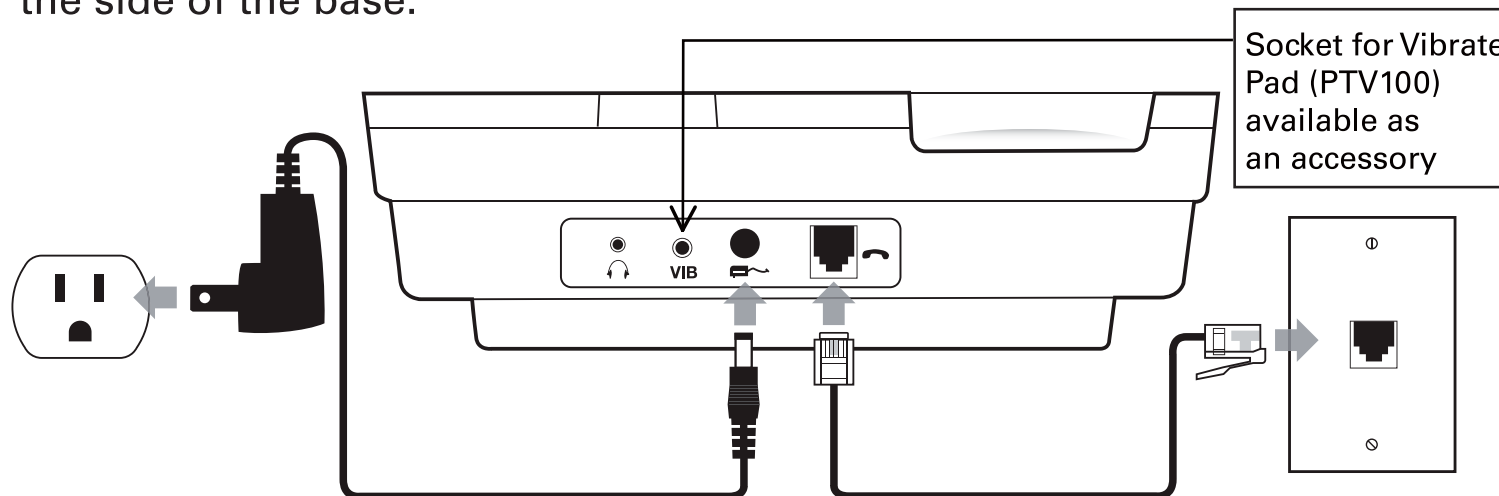

Important: Use only Power supply model S008CU1200067 supplied by Ten Pao Industrial Co., Ltd. for Base unit.

2. Connect cordless phone charger base

Plug the other power adapter that is already attached to charger base into the wall socket and switch the power on.

3. Install battery pack

Insert the rechargeable battery pack into the handset and plug it in as shown. Dispose of battery pack properly. Do not allow battery pack to come into contact with fire or water.

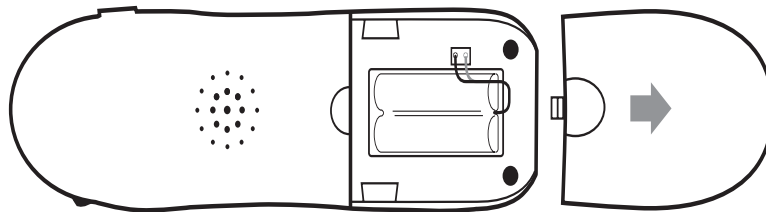

Caution: Risk of explosion if battery is replaced by an incorrect type. Dispose of used batteries according to the instructions.

4. Charge handset

Place the handset on its base to charge for a minimum of 15 hours before use.

Important: Only use the rechargeable battery pack model GPHCH73N07, 750mAh NiMH supplied by GPI INTERNATIONAL LIMITED.

5. Connect telephone cable

After initial charge, plug the telephone cable into the telephone wall socket.

Connect and charge wrist shaker

Important: Use only the power adapter supplied, otherwise wrist shaker may not work.

1. Plug in the charger unit

Plug the charger unit into the wall socket.

2. Place the wrist shaker in the charger unit

Place wrist shaker on its charger unit, with the two connection points facing down. A red light on the wrist shaker indicates it is charging properly. Charge the wrist shaker for 10 hours before use.

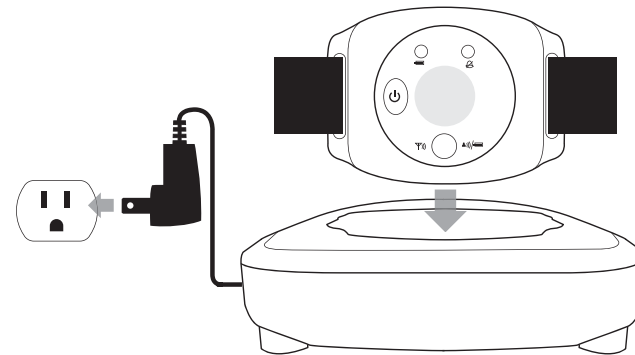



Note: When fully charged, the wrist shaker's battery will last five days. The larger red light will flash slowly when the battery is low and needs to charge for 10 hours.

3. Switch wrist shaker on/off

Press and hold  for five seconds, until the green light with the warning triangle comes on.

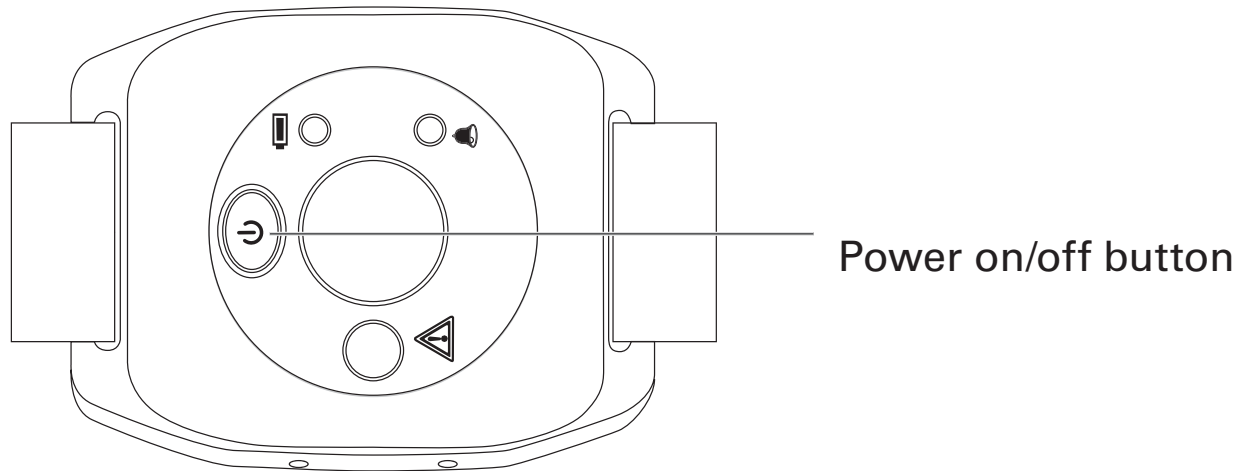







Note: The light flashes green then red if the wrist shaker is not registered or is out of range. Bring it closer to the PowerTel telephone to ensure it is within range. If the light still flashes, see page 57 for registration instructions.



Off: Press and hold  for about five seconds, until the green light goes off.

5. Turn on SOS Motor feature

The SOS Motor feature causes the wrist shaker to vibrate when a call comes in.

- i. At the corded phone base: Press  (under the display).
- ii. Use   to scroll to **SOS Motor**. Press  again.
- iii. Use   or   to scroll to **On**. Press  again. **Saved** is displayed.

Wrist strap

The wrist strap allows the wrist shaker to be worn like a watch. To attach or adjust the wrist strap:

1. Thread it from the back through one of the slots.
2. Slide the strap across the back of the wrist shaker.
3. Thread it back to front through the other slot.
4. Place the strap around the wrist and connect the velcro fasteners.

The telephones and wrist shaker are now ready for use!

Corded Phone Base Display Icons

The following icons can appear in the handset display:



Phone book mode



Ringer off



Handsfree mode



Call in progress



Boost receiver volume is on (Icon will flash)



Handset microphone is muted























You have new calls



Internal call in progress

Cordless Phone Handset Display Icons



The following icons can appear in the handset display:

- | | | | |
|-------------------------------------------------------------------------------------|-------------------------------|---------------------------------------------------------------------------------------|------------------------------------------------------------------|
|  | Menu |  | Play messages fast forward |
|  | Previous menu |  | Boost receiver volume is on
(Icon will flash) |
|  | Confirm / OK |  | Mute handset microphone |
|  | Phone book mode |  | New calls |
|  | More information to view up |  | Answering machine is on |
|  | More information to view down |  | Answering machine is off |
|  | Battery status |  | When steady— handset is in range |
|  | Ringer off |  | When flashing — handset out of range |
|  | Keylock is on |  | Internal call in progress (if additional handsets are installed) |
|  | Handsfree mode | | |
|  | Call in progress | | |
|  | Play new TAD messages | | |



Phone Menu and Display Guide



The phone menu display allows access to each phone's functionality. These features work from both the corded phone and the cordless handset.

Open main menu: Press .

Browse sub menu: Open the main menu and then press /P or /R.

Select sub menu item: Scroll using /P or /R until the menu item desired is highlighted and press .

Browse a function: Open the sub menu and press /P or .

Select a function: Scroll using /P or /R until the required function is highlighted and press .

Enter digits or letters: Use the keypad.



Confirm or save an entry or action: Press .

Cancel and return to standby: Press  (corded phone) or  (cordless handset).



Note: After 20 seconds, the phone will go into standby mode unless a button is pressed.

Calling Functions

Make a call using the corded phone

1. Enter the phone number.
2. Press  to delete a mistaken entry.
3. Dial the number by picking up the handset or by pressing .



Make a call using the cordless phone

1. Enter the phone number.
2. Press  to delete a mistaken entry.
3. Dial the number by pressing .

End a call





Return the corded phone to its base, or press  on the cordless handset.

Answer a call

1. Lift the handset off the base or press  on the corded handset.
2. For the cordless handset, press  and then speak into the phone.

Redial a number using the corded phone base





The phone stores the last 5 numbers dialed.

1. Open the redial list by pressing /P.
2. Scroll through the redial list using /P or /R until the desired number to redial is highlighted.
3. To dial the number lift the handset or press  to dial in handsfree mode.

Note: Each phone number will be announced from the redial list provided the Read Number feature is enabled. See page 24 for details.





Redial a number using the cordless handset

The phone stores the last 10 numbers dialed.





1. Open the redial list by pressing .
2. Scroll through the redial list using  or  until the desired number is highlighted and then press  to dial the number.

Call back a previous caller







The phone stores the last 30 incoming phone numbers.

1. Open the incoming calls list by pressing  / R .
2. Scroll to find the desired number using  / P or  / R , and pick up the corded handset or press  on the cordless handset.

Dial a number in the phone book

1. Open the phone book by pressing  .
2. Scroll to find the desired number using  / P or  / R , pick up the corded handset or press  on the cordless handset.

Dial a number using the quick dial buttons



1. Choose a quick dial number by pressing  ,  or  on the corded phone or  or  on the cordless handset.
2. Pick up the corded handset or press  on the cordless handset to dial the number.

Adjust the handset earpiece volume

Note: The handset earpiece volume is louder than a standard phone.



To adjust the volume during a call, push the button on the side of the handset up or down.

Boost the handset earpiece volume





To boost the handset earpiece volume during a call, press   (cordless phone) or  (corded phone). An image of an ear will flash in the display and the light on the top of the headset will be lit to show that boost is on.

Handsfree feature

Use the handsfree feature to talk to the caller without holding the handset or to let other people in the room listen to the conversation.



Corded Phone: Switch on handsfree mode by pressing . To adjust handsfree volume, press  or  (there are 5 levels).

Cordless Phone:

1. Switch on handsfree mode during a call by pressing the  key twice.
2. Exit handsfree mode by pressing .
3. To adjust the handsfree volume, use the switch on the right of the handset or the  or  buttons.

Note: Boost volume using   is not available during handsfree calling.

Use a headset (not included) with the corded phone

Plug a headset into the  socket on the back of the base and press . This socket can be used with headset KX-TCA94 supplied by Panasonic.

Use a headset (not included) with the cordless phone

Plug your headset into the headset socket marked  on the right side of the handset. This socket can be used with headset KX-TCA94 supplied by Panasonic.

Mute the phone

Muting the phone during a call will silence the mouthpiece on the phone so it does not transmit any noise to parties on the other end of the line.

Corded Phone:

To switch off the mouthpiece, press . **Mute** will be displayed.

To switch it on again, press . The display will show **Unmute**.

Cordless Phone:

To switch off the mouthpiece, press . **Mute On** will be displayed.





To switch it on again, press . The display will show **Off**.

Switch the cordless handset ringer on and off

To switch the ringer on and off, press and hold  for five seconds.

Lock and unlock the cordless handset keypad

Calls can still be answered as usual when the keypad is locked.

1. To lock the keypad, press and hold  for 2 seconds. The  icon will be displayed.
2. To unlock, press and release  then immediately, press and release .

Find handset

A missing handset can be located from the base.













1. Press  on the base. The handset(s) will beep.
2. Press any button on the handset to stop the handset(s) beeping.

Menu Options – corded phone











User Profiles



The phone can store 3 different user profiles with different settings for the Volume, Boost and Equalizer features. Each Profile can be given a personalized name.

Change a profile name

1. Open the menu by pressing , then scroll using /P or /R to highlight **Profile**. Then press .
2. Scroll using /P or /R to highlight **Profile 1, 2, or 3**. Then, press .
3. Scroll using /P or /R to highlight **Name**. Then, press .
4. Press  to delete current name.
5. Enter a new name (up to ten letters). Then, press .

Change a profile's handset Volume, Boost or Equalizer



1. Press , then scroll using /P or /R to highlight **Profile** and press  again.
2. Scroll using /P or /R to highlight **Profile 1, 2, or 3**. Then, press .
3. Scroll using /P or /R until the desired setting (Volume, Boost, or Equalizer) is highlighted. Press .

4. The current setting will be displayed.
5. Use /P or /R to change the setting. Press  .

Note: After changing any profile settings, press  to put the base back to standby.

Choose a profile for a call

A handset is required in order to choose a profile. A profile cannot be chosen using handsfree.

Before answering a phone call or before dialing a number to make a call, press ,  or  to select a profile. The display will confirm the choice, and the selected profile settings will be used.

Note: The system will return to its default settings if a call is not placed within 30 seconds after a profile has been selected.

Changing Menu Settings

Handset ringer melody — There are nine ringer melodies.

Handset ringer volume — There are five volume levels plus **Off**.

Base key tone — Pressing a button makes a key tone sound if On.

Base display contrast — There are five contrast levels.







Base display language — There are six languages: **English, German, French, Spanish, Dutch** and **Italian**.

Remember boost — When this feature is set to ON, pressing  causes the handset to remember and use the last boost setting for all calls.









Read number — With this feature set to **On**, each number is announced when someone: enters a phone number, presses a quick dial button, scrolls through entries in the phone book redial list, or accesses a call list.

Change to upper or lower case — In phone book, press ***** to change the case setting on the display (e.g. abc or ABC).











Changing Settings:

1. Open menu by pressing , then scroll using  or  to highlight the desired menu setting (see above) and press .
2. The current setting will be displayed.
3. Change the setting using  or  and press .

Change date/time

1. Open menu by pressing , then scroll using  or  to highlight the desired menu time (see above) and press .
2. Scroll using  or  to highlight **Date & Time** and press .
3. Enter the day, month and year and press .
4. Enter the hours (the handset has a 24-hour clock) and press .







Change clock hours to 12- or 24-hour format display

1. Open menu by pressing , then scroll using  or  to highlight **Time**. Press  again.
2. Scroll using  or  until you highlight **Format** and press .
3. The display will show the current time format setting (e.g. **24 hour**).
4. Change the time format using  or  and press .

Reset to default settings

It is easy to reset your handset to its default settings.

Note: Doing this will delete the phone book, calls and redial lists and any answering machine messages.

1. Open the menu by pressing , then scroll using  or  to highlight **Reset**. Press  again.
2. The display will show **Base Reset?** Press  to confirm or  to cancel.



Phone book – corded phone

Up to 200 names with phone numbers can be alphabetically stored in the phone book. To quickly find a phone book entry, simply enter the first letter of a stored name.

Note: Each phone book entry allows for up to 16 letters for any name and up to 24 digits for any phone number.

Important: Enter the area code for each phone number in the phone book

Keypad use for phone book







The keypad contains alpha-numeric keys. Pressing one key multiple times will scroll through the available letters and numbers which that key represents.

Other useful keys:













- Press **1** for a space
- Press **⊗** to delete a number or letter
- Press **0** or **1** for certain special characters

Note: To enter the same letter twice, enter the letter and then pause until the cursor moves to the next space before entering it again.

Enter a name and number in the phone book







1. Press and hold  for 2 seconds until the display shows **Enter Name** and a flashing cursor.
2. Use the keypad to enter the name to be stored. Then, press .
3. Enter the phone number to be stored. Then, press .
4. Scroll using  or  to choose a ringer melody for this name and number. Press . The display will show **Saved**.

Edit a phone book entry

1. Press .
2. Scroll using  or  to find the entry to edit.
3. Open options by pressing , then scroll using  or  to highlight **Edit**. Press .
4. Edit the name using  or **MEMO** to move the cursor, enter the new letters, and press .
5. Edit the phone number using  or **MEMO** to move the cursor, enter the new digits, and press .
6. Scroll using  or  to choose a ringer melody for this name and number

and press . The display will show **Saved**.



Delete a phone book entry

1. Press .
2. Scroll using  or  to find the entry to delete.
3. Open options by pressing , then scroll using  or  to highlight **Delete**, and press .
4. The display will show the **Delete?** Press  to confirm the deletion or  to cancel.









Delete all phone book entries

1. Press .
2. Open options by pressing , then scroll using  or  to highlight **Delete All**, and press .
3. The display will show **Delete All?** Press  to confirm the deletion or  to cancel.









Using quick dial memory – corded phone







A phone can store a name (max. 16 characters) and telephone number (max. 24 digits) under each of its quick dial memory buttons: ,  and .

Store a quick dial name and number









1. Choose the quick dial button under which to store a name and number by pressing either ,  or .
2. Press  twice.
3. Enter the name to store and press .
4. Enter the phone number to store and press .
5. Scroll  or  to choose a ringer melody for this name and number and press . The display shows **Saved**.

Edit a quick dial entry

1. Choose the quick dial entry to edit by pressing either ,  or .
2. Press . **Edit** is displayed, press  again.
3. Use  or **MEMO**  to move the cursor, enter the new letters, and press .

4. Use  or **MEMO**  to move the cursor, enter the new digits, and press .
5. Scroll using  or  to choose a ringer melody for this name and number and press . The display will show **Saved**.



Delete a quick dial entry

1. Choose the quick dial entry to delete by pressing either ,  or .
2. Press . Press /**R** to highlight **Delete** and press .
3. The display will show **Delete?** Press  to confirm or  to cancel.

Incoming Calls – corded phone

Note: You must subscribe to your phone service provider's Caller Display/ Caller ID service for this feature to work.



Incoming call telephone numbers will appear in the calls list. If the caller's number is stored in the phone book, the name will be displayed instead. A total of 30 incoming calls can be stored in the calls list (16 letters per name and 24 digits per number). The number of new calls received will be shown in the display with the flashing  icon. If the number does not appear, the caller's identification (Call Line ID) has been withheld by the caller.









Open and view the calls list by pressing . To scroll through the calls list, press  or . Other displayed information:

- **WITHHELD NUMBER** – withheld number, or ID information isn't available
- **INTERNATIONAL** – call is from another country or using an internet service
- **PAYPHONE** – caller is calling from a public payphone









Store numbers from a calls list to the phone book or quick dial memory (M1, M2, M3)

To store incoming call numbers to your phone book or quick dial list:







1. Press  to open the calls list at the most recent entry.
2. Scroll using  or  to find the entry to store.

3. Open options by pressing , then scroll using /P or /R to highlight **Save to PB** or **M1**, **M2** or **M3**, and press .
4. Enter a name for this stored number and press .
5. Edit the number for this name, if necessary, and press .
6. Scroll using /P or /R to choose a ringer melody and press .

Delete a single calls list entry

1. Press /R to open a calls list at the most recent entry.
2. Scroll using /P or /R to find the entry to delete.
3. Open options by pressing  and then scroll using /P or /R to highlight **Delete**, and press .
4. The display will show **Delete?** Press  to confirm or  to cancel.

Delete all calls list entries

1. Press /R to open a calls list at the most recent entry.
2. Press , and then scroll using  or  to highlight **Delete All**. Press .
3. The display will show **Delete All?** Press  to confirm or  to cancel.

Using the menu – cordless phone













Priority/Default Setting

Any changed settings in the menu will be saved as default. The phone also allows for two separate user profiles.













User Profiles

The phone can store 2 different user profiles with different settings for the Volume, Boost, and Equalizer features. Each Profile can be given a personalized name.

Change a profile name

1. Open the menu by pressing , scroll using  or  until **Profile** is highlighted and press .
2. Scroll using  or  until **Profile 1 or 2** is highlighted and press .
3. Scroll using  or  until **Name** is highlighted and press .
4. Delete the current name by pressing .
5. Enter a new name (up to ten letters) and press .





Change a profile's handset Volume or Equalizer

1. Open the menu by pressing , then scroll using  or  until you highlight **Profile** and press .
2. Scroll using  or  until **Profile 1** or **2** is highlighted, press .
3. Scroll using  or  until the desired setting is highlighted, press .
4. The current setting will be displayed.
5. Change the appropriate setting using  or  and press .

Note: Press  to exit the menu and return the handset to standby.

Choosing which profile to use

Note: Handset must be used to choose a profile for a call – a profile cannot be chosen using handsfree.

1. Before answering an incoming call, press  or .
2. The display will confirm your choice.
3. Before making a call, press and hold  or  to select a profile.

Note: Once a profile has been selected to use when making a call, the phone will return to the default settings after 30 seconds.

Changing Menu Settings

Handset ringer melody — There are ten ringer melodies.

Handset ringer volume — There are five volume levels plus **Off**.

Tone (“Equalizer”) setting — There are five tone settings.

Note: To adjust tone while making a call, press the  button to access the equalizer setting, press the  or  button to adjust the setting. Press the volume switch on the side of the phone to exit this mode.

Switch keypad beep on or off — Turns on or off the keypad beep.









Change contrast — There are five screen contrast levels.

Switch “auto talk” on or off — The phone will automatically answer a call when the handset is removed from its base when Auto Talk is **ON**. This is the default setting. If Auto talk is **OFF**, press the  button to answer any calls.

Change backlight timer — Choose between 10, 20, 30 or 40 seconds until the backlight timer switches off.

Switch confirmation beep on or off — There is a beep confirmation when a setting is changed. This can be switched on or off.

Change language — There are six display languages available on the handset: **English, German, French, Spanish, Dutch** and **Italian**.

1. Open the menu by pressing , then scroll  or  until **Handset** is highlighted and press .
2. Scroll  until the desired menu setting (see options above) is highlighted and press .
3. The current setting will be displayed.
4. Change the setting using  or  and press .

Changing Clock Settings







Change date/time — Enter the Date and Time settings.

Change clock to 12- or 24-hour format — Choose between a standard 12-hour format clock or a 24-hour format (military time).

Set alarm — Set an alarm date, time, melody, and reoccurrence.





Switch night light on or off — Sets the night light.



Note: The alarm must be set before the night light feature will work.

1. Open the menu by pressing , then scroll  or  until **Handset** is highlighted and press .
2. Scroll  until the desired clock setting (see options above) is highlighted and press .
3. The current setting will be displayed.
4. Enter the desired date and/or time setting required (the handset has a 24-hour clock) press .
5. An alarm melody and reoccurrence (**Once, Every Day, Mon to Fri, or OFF**) can be selected after the alarm time is set.









Changing Base Settings

Change base ringer melody — There are ten base ringer melodies.

1. Open the menu by pressing , then scroll  or  until **Base settings** is highlighted and press .
2. **Ring tone** is highlighted, press .

3. The ringer melody setting (e.g. **8**) will be displayed.
4. Change the ringer melody using  or  and press .

Change base ringer volume — There are five volume levels plus Off.

1. Open the menu by pressing , then scroll using  or  until **Base settings** is highlighted and press .
2. Scroll  until **Ringer volume** is highlighted and press .
3. The current base ringer volume level (e.g. **5**) will be displayed.
4. Change the base ringer volume using  or  and press .

Phone book

Up to 200 names with phone numbers can be alphabetically stored in the phone book. To quickly find a phone book entry, simply enter the first letter of the stored name.

Note: Each phone book entry allows for up to 16 letters for any name and up to 24 digits for any phone number.



Important: Enter the area code for each phone number stored.

Keypad use for phone book

The keypad contains alpha-numeric keys. Pressing one key multiple times will









scroll through the available letters and numbers which that key represents.

Other useful keys:





- press  for a space
- press  to delete a number or letter entered
- press  to change from upper case (e.g. ABC) to lower case (e.g. abc)









Note: To enter the same letter twice, enter the letter and then pause until the cursor moves to the next space before entering it again.

Enter a name and number in the phone book







1. Open the phone book by pressing .
2. Press . The display will show **New entry**, press  again.
3. Enter the name to store and press .
4. Enter the phone number to store and press .
5. Scroll using  or  to choose a ringer for this entry and press .

Edit a phone book entry



1. Open the phone book by pressing .
2. Scroll using  or  to find the entry to edit and press .







3. Scroll  to display **Edit entry** and press .
4. Press  to delete characters, use the keypad to enter new ones, press .
5. Press  to delete digits, use the keypad to enter new ones, press .
6. Scroll using  or  to choose a ringer for this entry and press .

Delete a phone book entry or all entries









1. Open your phone book by pressing .
2. Scroll using  or  to find the entry to delete or highlight any entry to delete all entries.
3. Press  to display either **Delete entry** or **Delete all** and press .
4. Press  to confirm or  to cancel.

Using quick dial memory buttons







One name (max. 16 characters) and one telephone number (max. 24 digits) can be stored under each of the quick dial memory buttons:  and .

1. Press the  or  quick dial button.
2. Press . The display will show **New entry**, press  again.
3. Enter the name to store using the keypad and press .
4. Enter the phone number to store and press . **Saved** will be displayed.

Edit a quick dial entry

1. Choose the quick dial entry to edit by pressing either  or .
2. Press . The display will show **Edit entry**, press  again.
3. Press  to delete characters, use the keypad to enter new ones, press .
4. Press  to delete digits, use the keypad to enter new ones, then press . The display will show **Saved**.





Delete a quick dial entry

1. Choose the quick dial entry to delete by pressing either  or .
2. Press . Scroll  to **Delete entry** and press .
3. Display will show **Delete entry?** Press  to confirm or  to cancel.

Incoming calls





Note: you must subscribe to your phone service provider's Caller Display/ Caller ID service for this feature to work.





Incoming call telephone numbers will appear in the calls list. If the caller's number is stored in the phone book, the name will be displayed instead. A total of 30 incoming calls can be stored in the calls list (16 letters per name and 24 digits per number). The number of new calls received will be shown in the display with the flashing  icon. If the number does not appear, this is because the caller's identification (Call Line ID) has been withheld by the caller.

Open the calls list by pressing the  button. Scroll through the calls list by pressing  or . To display more information including the date and time of the call, press **R** .









- **WITHHELD NUMBER** – withheld number, or ID information isn't available
- **INTERNATIONAL** – call is from another country or using an internet service
- **PAYPHONE** – caller is calling from a public payphone

Store numbers from the calls list to the phone book





1. Press  to open the calls list at the most recent entry.
2. Scroll using  or  to find the entry to store and press .
3. The display will show **Save to phbk**, press .

4. Using the keypad, enter a name for this stored number and press .
5. Edit the number for this name, if needed, and press .
6. Scroll using  or  to choose the ringer for this entry and press .

Delete a single entry

1. Press  to open the calls list at the most recent entry.
2. Scroll using  or  to find the listed to delete and press .
3. Scroll  until **Delete** is highlighted and press .
4. Confirm or cancel to delete the calls list entry by pressing  or .

Delete all calls list entries

1. Press  to open the calls list at the most recent entry.
2. Scroll  until **Delete all** is highlighted and press .
3. The display will show **Delete all Calls?** Press  or  to cancel.

Using the answering machine

After setting up the phone system, use the following steps to set up and use the answering machine.

Switch answering machine on or off







Press  to turn the answering machine off and on.

The current answer mode will be announced.

When new messages are received, the message counter on the base and the base indicator light flash. The message counter also indicates the number of messages.



Set the language

Choose the answering machine voice prompt language: English, Spanish or French.

1. Press and hold  twice.
2. Scroll using  or  to highlight **Language** and press .
3. Choose the language using  or  and press .

Set the answer mode

Choose the answer mode: Answer & Record or Answer only. With the machine in Answer only mode, callers will not be able to leave a message.



1. Press  to switch the answering machine on.
2. To change the mode between **Answer & Record**, **Answer Only** or **Answer Off**, press and hold  for two seconds.

Check the outgoing message

Press  to hear the current outgoing message.

Record an outgoing message







The outgoing message must be less than two minutes long. To change the default answering message:

1. Press and hold  on the base for two seconds. Record the new message after the beep.
2. To stop recording, press . To listen to the recorded message, press .

Note: to return to the default message, press and hold  while the outgoing message is playing.



Set the answer delay

Choose the number of times the phone will ring before the answering machine answers an incoming call. Or, choose Time Saver, if no one will be available to answer the phone. Time Saver is useful if someone will be calling in from a different phone to listen to messages: if the machine answers after 2 rings, there are new messages to listen to. If it answers after 5 rings, there are no new messages. This feature gives the option of hanging up after 3 rings (because there are no new messages) to save time and avoid being charged for the call.

1. Press  twice.
2. Scroll using  or  to highlight **Answer Delay**. Press .
3. The display will show the current answer delay setting (e.g. **5** rings).
4. Choose the number of desired rings (2–9) or Time Saver using  or , and press .

Record a memo





Memo messages can be played back like normal messages.

1. Press and hold **MEMO**  for two seconds.
2. After the beep, record the memo.
3. Press  to stop recording.



Listen to messages or memos using the corded phone

Messages and memos are played in reverse order, with newer messages played first. The time and date of each message or memo is announced before playback.







Use the following buttons to control message playback:

- To play or pause, press 
- To stop, press 
- To rewind, press 
- To fast forward, press **MEMO** 







Delete a single message or memo

1. Press  to play a message or memo.
2. To delete it, press and hold  during playback.

Delete all messages and memos

1. Press  twice.
2. Scroll using  or  to highlight **Del. All Msgs.** Press .
3. The display will show **Delete All?**
4. To confirm, press . Or to cancel, press .

Listen to messages or memos using the cordless handset

1. Open the answering machine menu by pressing .
2. When **Ans Machine** is displayed, press .
3. Scroll using  or  to display either **Play New Msgs** or **Play All Msgs**, then press . Or press phone book button to play new messages.
4. Press  to return to standby.

Memory full







When the memory is full, the answering machine announces that fact, automatically stops taking more messages, and switches to **Answer Only** mode. Some existing messages or memos must be deleted before any new messages can be recorded.

Access the answering machine from a remote location

Messages on the answering machine can be listened to from other phones, including mobile phones.

A PIN (Personal Identification Number) code is required to access the answering machine. The default code is **000**. Change the PIN code to keep messages secure.

Change PIN

1. Press  twice, then scroll using  or  to highlight **Remote PIN**, and press .
2. Enter the old PIN, and press .
3. Enter the new PIN, and press .

Call in to check messages

1. Dial the system's phone number from a remote phone and wait until the answering machine picks up the call.
2. Press  twice, then enter the 3 digit PIN after the voice prompt.
3. Refer to the next section, "Manage messages from another phone" for additional instructions.

Note: if the wrong PIN is entered three times, the answering machine will hang up, and it will be necessary to call again and enter the correct PIN.

Manage messages using another phone

Use these numbers to manage messages from a remote location.

Press...

1 to **Rewind**

2 to **Play** or **Pause** your **messages**

3 to **Fast Forward** through your messages

4 to **Hear** the **outgoing message**

5 to **Record outgoing message** (**6** to **stop** recording)

6 to **Stop** messages

7 to **Delete current message**

8 to **Turn OFF** answering machine

9 to **Turn ON** answering machine

0 to **Delete all** old messages

to **Record a memo** (**6** to **stop** recording)

Using the wrist shaker

Switch on

Press and hold  for five seconds. The green light with the warning triangle will come on.

Switch off

Press and hold  for five seconds, until the green light goes off.

Incoming calls

When you receive an incoming call, the green light will flash and the wrist shaker will vibrate.

Note: The SOS Motor feature must be turned on for the wrist shaker to vibrate. See page 10 for instructions.

The call can be answered by pressing the large emergency button  in the middle of the wrist shaker if it is within range of the Powertel phone. It is not possible to speak to a caller via the wrist shaker.

When the emergency button on the wrist shaker has been pressed, the PowerTel phone will answer the call in handsfree mode. That enables speaking to the caller via the phone without picking up the handset.











To end the call, just press and release the emergency button  again.

Emergency call

It is possible to program up to 3 numbers to be dialled in an emergency under the M1, M2 and M3 buttons on the telephone.

Important: Under no circumstances should 911 (Emergency services) be stored as a personal emergency number.

Storing emergency numbers in the telephone

1. Press one of the red ,  or  button on the telephone. A previously stored number or **M1 Empty** (or M2, M3 as appropriate) will be displayed.
2. Press the left hand menu button  under the display. This display shows **Add New** or **Edit**. Press  again.
3. Using the keypad, enter the name for this telephone number (maximum of 16 characters).
4. Press  to save the name.
5. Enter the telephone number. To delete a mistake, press the red button on the left hand side  for each character or digit to be deleted.
6. Use the  or  buttons on the central round button to select a ringing melody for the quick dial number. Press  to confirm.

SOS message

The PowerTel 680 telephone has a pre-recorded SOS message to use, or one can record a personal emergency message.





The pre-recorded emergency message is: "This is an emergency call. To accept this message, press **0**."

Record a personal SOS message at the base

When an emergency call gets activated, the numbers stored under the M1, M2 and M3 buttons on the PowerTel 680 telephone are repeatedly dialed in turn until one of the numbers is answered. The emergency message is then played.

In the personal emergency message, it is very important to include:





- That the call is an emergency
- The name of the person needing help
- That the person answering the call must press **0** to accept the emergency call.

1. Press . Then, use  **P** to scroll to **SOS Message**.
2. Press  to select again.
3. Use  **P** to scroll to **Record**.
4. Press  to start recording the message.

SOS Record is displayed. Remember to speak slowly and clearly while facing the telephone.

5. Press  again to stop the recording. **SOS Play** will be displayed and the message will automatically be played back.

Listen to the personal SOS message

1. Press , then press /P to scroll to **SOS Message**.
2. Press the  button to select.
3. **Playback** is displayed. Press .
4. **SOS Play** is displayed, and the message is played back.

Delete personal SOS message

1. When message is played back press and hold . The personal message will be deleted and the pre-recorded emergency message will now be used.

Activating an emergency call



When an emergency call is activated from the wrist shaker, the PowerTel 680 telephone will go to handsfree mode and will beep for 15 seconds.



The emergency numbers stored under the M1, M2 and M3 buttons (see page 30) are then automatically dialed, one after the other, at 60 second intervals. This process is audible.

The person answering the emergency call will hear the SOS message. When that person presses the 0 button, he or she will be able to talk to you via the

handsfree on the PowerTel 680 telephone for 3 minutes.

During the last 10 seconds of this 3 minute, a warning beep sounds to indicate that the call is about to be disconnected.

If no numbers have been stored under the ,  or  keys on the PowerTel 680, then a long continuous tone sounds after the beep tone for 15 seconds, after that beep tone, and no numbers will be dialed.

If only 1 or 2 numbers have been stored under the ,  or  keys, then the numbers that have been stored will be dialed.

Important: The wrist shaker must be in range of the telephone to be able to make an emergency call. An emergency call is not possible if the wrist shaker batteries are not charged. If the emergency message is delivered to an answer phone or voicemail service then the dialing sequence will continue to the next number until such time that the recipient accepts the call by pressing '0.'

To activate an emergency call

1. Press and hold the large emergency button  in the middle of the wrist shaker for 5 seconds.



To cancel an emergency call

1. Press and hold the large emergency button  in the middle of the wrist shaker for 5 seconds.

Register wrist shaker

Important: It is necessary to register the wrist shaker if it has become de-registered from the telephone or if a new wrist shaker needs to be registered.

At the wrist shaker:

1. Turn on the wrist shaker by pressing and holding  for about five seconds.
2. After the wrist shaker is On, press and hold  again for about 12 seconds, until the registration light flashes green. The wrist shaker will be in registration for about 1 minute.

At the corded phone base:

3. Press and hold  for at least 10 seconds, until **Register** is displayed (for about 10 seconds).

Note: To locate the registration key , see the At a Glance section for the corded phone base at the beginning of this guide.

4. The registration light unit glows a steady green when the wrist shaker is registered (i.e. it isn't flashing).

Note: the registration light will flash green and red if the wrist shaker either isn't registered or is out of range.

Adding a Handset

Note: The following features are only available to if an additional handset(s) has been registered to the current phone system.

Register a handset

Only register a handset if it has become de-registered from the base or if it was purchased separately.

Important: make sure any handset is fully charged before registering.

At the handset:

1. Press and hold  for approx 10 seconds until the display shows **Press and hold Page key**.











At the base:

2. Press and hold  for at least 10 seconds until the display shows **Register**.









De-register a handset

De-register a handset if too many are currently registered on the phone system, or if the handset develops a fault and needs to be replaced.



To De-register a handset

1. Open the menu by pressing , then scroll using  or  until **Handset** is highlighted and press .
2. Scroll using  or  until **Registration** is highlighted and press . Then scroll  to highlight **De-register** and press .
3. Enter the PIN code (default PIN 0000) and press .
4. Enter the handset's internal number (e.g. 1) and press  to confirm.

Change handset name

1. Open the menu by pressing , then scroll using  or  until **Handset** is highlighted and press .
2. Scroll using  or  until **Handset name** is highlighted and press .
3. Delete the current name by pressing .
4. Enter a new name (up to 12 letters) and press .



Transfer an external call internally

1. During an external call, press and hold  INT until a short beep is heard, then enter the internal call number of the handset to transfer the call to.
2. To accept the call on the receiving handset, press .





Note: If no one picks up the call being transferred, re-answer the call at the current phone by pressing  .

Make an internal call

If two or more handsets are registered to the base internal calls between handsets can be made. Each handset will have been allocated a handset number when registered, e.g. **HS1**, **HS2** etc. These calls are free of charge.

1. Press and hold  . The display will show **Handset?** Enter the internal call number of the handset desired.
2. To accept the call on the receiving handset, press .
3. End the call by pressing .

Make a conference call











1. During an external call, press and hold  until a short beep is heard, then enter the internal call number of the handset to transfer to.
2. To accept the call on the receiving handset, press .
3. Once the call has been received on the other handset , activate the conference call by pressing and releasing the  button.
4. Place the external call on hold by pressing  (if necessary).
5. The conference call will end when  is pressed.

Copy phone book entries to another registered handset







Note: Phone books can only be copied to another handset if that handset is registered on the same phone system.









- A single entry (Copy entry)
- Entries not already on the handset being copying to (Copy append)
- All entries (Copy all)

Important: when “copy all” is selected, all existing entries on the handset being copied to will be deleted. To prevent this from happening use “Copy append.”









1. Open the phone book by pressing .
2. Scroll using  or  to find the entry or entries to copy and press .
3. Scroll  to either **Copy entry**, **Copy append**, or **Copy all** and press .
4. Scroll  **INT** or **R**  to highlight the handset number to copy to and press .
5. Pick up the handset where copying entries to and press .

Copy a profile

1. Open the menu by pressing , then scroll using  or  until **Profile** is highlighted and press .
2. Scroll using  or  until **Profile 1** or **2** is highlighted and press .

3. Scroll using  or  until **Copy** is highlighted and press .
4. Scroll using  **INT** or  **R** until the handset (e.g. **2**, **3** or **4**) to copy the profile to is highlighted, and press .
5. On the copy-to handset, press  to confirm or  to cancel.

Setting or Changing system PIN code











1. Open the menu by pressing , then scroll using  or  until **Base settings** is highlighted and press .
2. Scroll using  or  until **System PIN** is highlighted and press .
3. Enter the old PIN code (default PIN is 0000) and press .
4. The phone will prompt for a new 4 digit PIN code (entered twice), press .

Important: Do not change or reset the PIN code unless instructed by customer service.







Use on a private branch exchange



If the phone is on an exchange (e.g. dial 9 to get an outside line), calls can be transferred or called back by using the **R** button. Check with the system administrator for system set-up and instructions. Private exchanges are normally used in a business-setting.

To set recall time using the corded phone

1. Open your menu by pressing , then scroll using /P or /R to highlight **Settings** and press .
2. Scroll using /P or /R to highlight **Recall** and press .
3. The current recall timing setting (e.g. **Short**) will be displayed.
4. Choose the desired recall time setting (Short or Long) using /P or /R and press .

To set the recall time using the corded phone

1. Open the menu by pressing , then scroll using /P or /R until **Base settings** is highlighted and press .
2. Scroll using /P or /R until **Recall** is highlighted and press .
3. The current recall timing setting (e.g. **Short**) will be displayed.

4. Choose the desired recall timing setting (Short or Long) using  or  and press .

Insert a dialing pause

Insert a pause before the dial tone if the system requires an outside line which takes awhile to connect.

To insert a dialling pause using your corded phone, enter the number to reach the outside line and then press . A **P** on your display will show dialling pause is active.





To insert a dialling pause using your cordless handset, enter the number to reach the outside line and then press  for two seconds. A **P** on the display will show dialling pause is active.







Note: A dialing pause can be used with a phone number in the phone book.

Set the dial mode











There is a choice of two dialing modes: tone and pulse. The default setting is **TONE** and this is the correct setting for use within the United States.

To change dial mode using the corded phone

1. Press , then scroll using  or  to highlight **Settings** and press .

2. Scroll using /P or /R to highlight **Dial Mode** and press .
3. The current dial mode setting (e.g. **Tone**) will be displayed.
4. Choose the desired dial mode setting (Tone or Pulse) using /P or /R and press .







To change the dial mode using the cordless phone

1. Open the menu by pressing , scroll using  or  until **Base settings** is highlighted and press .
2. Scroll using  or  until **Dial Mode** is highlighted and press .
3. The current dial mode setting (e.g. **Tone**) is displayed.
4. Choose the dial mode setting required (Tone or Pulse) using  or  and press .



Reset to default settings

Important: Resetting to default will NOT delete phone book entries.

To reset to default settings on the corded phone

1. Press , then scroll using  or  to highlight **Reset**. Press .
2. The display will show **Base Reset?** Confirm or cancel the reset to default settings by pressing  or .

To reset to default settings on the cordless handset

1. Press **R**  for 10 seconds.
2. Confirm or cancel the reset to default settings by pressing  or .

Help and support

Some issues may simply be resolved by disconnecting the power to the unit. In such instances the power to the main base station should be switched off and battery pack in the handset should also be removed for about 20 minutes. After 20 minutes, replace the battery pack and reconnect everything to determine if this has resolved the issue.

Troubleshooting guide

I can't make phone calls

1. Make sure the phone cable is connected properly. Make sure you are using the phone cable that came with your phone.
2. Make sure the base is plugged in, switched on and working.
3. If you're using the cordless handset, make sure you are not located too far from the base (the phone should work up to 325 yards outdoors and up to 53 yards indoors).
4. Test the phone line and socket by using another phone.

I keep losing my connection on the cordless handset

1. Make sure you aren't too far from the base (in ideal conditions, it should work up to 325 yards outdoors and up to 53 yards indoors).
2. The base may not be in an ideal location – see Safety Information.

My handset keeps switching off

1. It may need recharging. So it can charge fully, place your handset on its charger base for at least 15 hours with the charger base plugged in and working.
2. Replace the rechargeable battery pack. Any replacement battery packs should be the same type as those provided.

The phone system isn't responding

You may need to reset to default settings. Please see page 54.

Answering machine won't record messages or memos

1. Check that the answering machine is connected and switched on.
2. Answering memory may be full. See page 31.

Caller's identification (Call Line ID) isn't working

1. Check you have this service on your phone line. Please call your network provider.
2. The caller may have withheld their phone number.

My handset or base doesn't ring

Check that the ringer is on.

I've got a buzzing noise on my radio, TV, or computer

We suggest you use your cordless handset at least 3 feet away from electrical equipment and mobile phones.

There is interference in the earpiece and/or internet connection is very slow when using the phone

You must plug the phone into the wall socket via an ADSL filter if you have

broadband internet on your phone line.

The white light on the base is constantly flashing

You have new answering machine message(s). Press  to listen to them and the flashing will stop. My answering machine won't record messages or memos

1. Check that your answering machine is connected and switched on.
2. Answering memory may be full. See page 89.

My remote access isn't working

1. Check you're using the correct PIN. See page 89.
2. Make sure you're using a touchtone phone.

Energy efficient power adapter

The included power adapter meets the eco-design requirements of the European Union (Directive 2005/32/EG).



Disposal

The  symbol on this product indicates that electrical and electronic apparatus and battery pack must be disposed of **separately** from domestic waste at suitable collection points provided by the public waste authorities.

Technical details

Standard	DECT ¹ GAP ²
Power supply (base station)	Input: 100-240V~50/60Hz 250mA Output: 12VDC 670mA
Range	Outdoors Approx 325 yards/300m Indoors Approx 53 yards/50m
Standby	Up to 100hrs
Maximum Talk Time	Up to 10hrs
Rechargeable battery pack	AAA 2.4V 750mAh NiMH
Dialling mode	Tone (DTMF) Pulse
Optimum ambient temperature	32°F to 113°F (0°C to 45°C)
Optimum relative humidity	20% to 80%
Recall	300, 600 ms

¹ DECT: Digital Enhanced Cordless Telecommunication

² GAP: Generic Access Profile = standard for the operation of handsets and base stations from different manufacturers.



Default settings

Cordless handset

Language	English
Handset name	PowerTel
Handset ringing melody (external)	7
Handset ringing melody (internal)	9
Handset ringing volume	5
Base ringing melody	8
Base ringing volume	5
Keypad beep	On
Auto talk	On
Contrast	3
Backlight time	10s
Boost memory	Off
Recall time	600ms
Dialing mode	Tone
PIN code	0000

Telephone answering machine

Language	English
Answer mode	Answer and record
PIN code for remote access	000
Answer delay	3
Time format	12 hour

Corded phone default settings

Language	English
Answer mode	Answer and Record
PIN code for remote access	000
Answer delay	5
External memory	8
Internal memory	9
Ringing volume	5
Key tone	On
Contrast	4
Boost memory	Off
Shaker	On
Dialing mode	Tone

Maintenance and Warranty

Maintenance

- Please clean your equipment's surfaces with a soft, lint-free cloth.
- Never use cleaning agents or solvents.

Warranty

AMPLICOM equipment is produced and tested according to the latest production methods. The implementation of carefully chosen materials and highly developed technologies ensure trouble free functioning and a long service life. The terms of the warranty do not apply where the cause of the equipment malfunction is the fault of the telephone network operator or any interposed private branch extension system. The terms of the warranty do not apply to the rechargeable battery pack or power packs used in the products. The period of warranty is 24 months from the date of purchase.

All deficiencies resulting from material or production faults which occur during the period of warranty will be eliminated free of charge. Rights to claims under the terms of warranty are annulled following intervention by the purchaser or third parties. Damage caused as a result of improper handling or operation, incorrect positioning or storing, improper connection or installation, Acts of God or other external influence are not covered by the terms of warranty.

In the case of complaints, we reserve the right to repair or replace defect parts or provide a replacement device. Replacement parts or devices become

our property.

Rights to compensation in the case of damage are excluded where there is no evidence of intent or gross negligence by the manufacturer.

If your equipment shows signs of defect during the period of warranty, please return to the sales outlet in which you purchased the AMPLICOM equipment together with the purchase receipt. All rights to claims under the terms of warranty in accordance with this agreement must be asserted exclusively with regard to your sales outlet.

Two years after the purchase of our products, claims under the terms of warranty can no longer be asserted.

Declaration of conformity

The ETL Listed Mark is an alternative to the CSA and UL marks. ETL Testing Laboratories owned by Intertek Testing Services (ITS) is recognized by OSHA as a Nationally Recognized Testing Laboratory (NRTL). ITS tests products according to nearly 200 safety and performance standards. The ETL Listed Mark is accepted throughout the United States when denoting compliance with nationally recognized standards such as ANSI, IEC, UL, and CSA.



This certification mark indicates that the product has been tested to and has met the minimum requirements of a widely recognized (consensus) U.S. product safety standard, that the manufacturing site has been audited, and that the applicant has agreed to a program of periodic factory follow-up inspections to verify continued conformance.

A

Adjusting the handsfree volume 19
Adjusting the earpiece volume 18
Alarm 38
Answering machine 45-51
Auto talk 36

B

Backlight timer 36
Base ringer melody 36
Base ringer volume 39
Base settings 22
Boost memory 24
Boosting the earpiece volume 19

C

Changing the system's PIN code 50, 62
Change case 24, 40
Charging the battery pack 9
Checking messages 50
Check the contents of the box 8
Conference calls 60
Connecting the base and charger 9-10
Contrast 24

D

Date/time 25
Default settings 26
De-register a handset 58
Dial mode 64
Dialing pause 64
Dialing from the phone book 18
Dialing from a quick dial button 18
Display icons 13-14

E

Earpiece volume 18
End a call 16, 52
Entering names in the phone book 32
Equalizer 35

F

Find a handset 21

H

Handset name 59
Handset ringer melody 24
Handset ringer on/off 14
Handset ringer volume 36
Handsfree 19
Headset use 20

I

Internal calls 60

K

Keypad lock 21
Keypad beep on/off 36

L

Language 37

M

Making a call 16
Making internal calls 60
Memory full 49
Mute 20

P

Phone book 32

Q

Quick dial 53

R

Record outgoing message 46
Redial 17
Register a handset 58
Remotely checking messages 49
Reset to default settings 66

T

Tone control (see Equalizer)

U

Using a headset 20
Using the menu 36

V

Volume 18, 19, 21, 22