

Compliance report of W5 ESL

Customer:
W5networks

Date:
January 8, 2008

TDK Report:
TTS-TR-T112-129

Test performed by:
TDK R&D Corporation
1101 Cypress Creek Rd
Cedar Park, TX 78613

	Technician	Checked by
Radiated 30 MHz to 40 GHz	A. Medina	K. Yata
Report	A. Medina	P. Carson/K. Yata



NVLAP LAB Code: 200430-0

1. Executive Summary

An EMC evaluation to determine compliance of the W5 ESL with requirements of FCC 47 CFR Part 15, Subpart F Section 15.517 was conducted. All references are to the most current version of the Code of Federal Regulations 47 that are currently in effect. In accordance with §2.1033, the following data is presented in support of the Certification of the W5 ESL. The client should retain a copy of this document on file for at least 5 years after the manufacturing of the product has been discontinued.

Test Description	FCC 47 CFR Section	Compliance
Operational Limitations	15.517(a)	The client has been notified of these limitations. In normal operating mode the transmitter will only send data when associated with a receiver. See section 5 for detail
UWB Bandwidth	15.517(b)	Yes
Radiated Emissions	15.517(c), 15.209	Yes
Radiated Emissions in GPS Bands	15.517(d)	Yes
Peak Emissions within a 50 MHz Bandwidth	15.517(e)	Yes
Labelling Requirements	15.517(f)	Yes

Report prepared by



Armando Medina

January 8, 2008

Approved by



Kunio Yata

January 11, 2008

This document contains confidential information and cannot be disclosed outside of W5networks or any affiliated company in whole or in part without the express written permission of TDK R&D Corporation.

2. Task Description

2.1. Scope

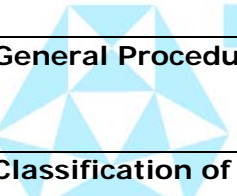
 Reference	<p>FCC ET Docket No. 98-153, FCC 02-48 First R&O; FCC 47 CFR, Part 15, Subpart A; FCC 47 CFR, Part 15, Subpart B; FCC 47 CFR, Part 15, Subpart C; FCC 47 CFR, Part 15, Subpart F</p> <p>FCC ET Docket No. 04-352, Petition for Waiver of the Part 15 UWB Regulations Filed by MBOA-SIG (Adopted: March 10, 2005)</p>
Title	<p>Revision of Part 15 of the Commission's Rules Regarding Ultra-Wideband Transmissions Systems; Code of Federal Regulations, Part 15 Subpart A: General Code of Federal Regulations, Part 15 Subpart B: Unintentional Radiators Code of Federal Regulations, Part 15 Subpart C: Intentional Radiators Code of Federal Regulations, Part 15 Subpart F: Ultra-Wideband Operation</p>
Purpose of Test	<p>To gain FCC Certification for technical requirements for Indoor UWB Systems operating between 3.1 GHz and 10.6 GHz.</p>
Test Procedures	<p>The tests were conducted in accordance with the following documents:</p> <p>FCC ET Docket 98-153, FCC 02-48 First R&O</p> <p>ANSI C63.4: 2003: Methods of Measurement of Radio-Noise Emissions from Low-Voltage Electrical and Electronic Equipment in the Range of 9 kHz to 40 GHz</p> <p>FCC Code of Federal Regulations 47, Part 15 Subpart A: General</p> <p>FCC ET Docket No. 04-352, Petition for Waiver of the Part 15 UWB Regulations Filed by MBOA-SIG (Adopted: March 10, 2005)</p>
 General Procedures	<p>FCC Code of Federal Regulations 47, Part 2 Frequency Allocations and Radio Treaty Matter: General Rules and Regulations</p>
Classification of EUT	<p>Indoor Ultra-Wideband System</p>

2.2. Related Submittal(s)/Grant(s)

None

2.3. Test Plan Reference

Publication	Year	Title
FCC 47 CFR, Part 15, Subpart A	10/2004	Code of Federal Regulations, Part 15 Subpart A: General
FCC 47 CFR, Part 15, Subpart B	10/2004	Code of Federal Regulations, Part 15 Subpart B: Unintentional Radiators
FCC 47 CFR, Part 15, Subpart C	10/2004	Code of Federal Regulations, Part 15 Subpart C: Intentional Radiators
FCC 47 CFR, Part 15, Subpart F	10/2004	Code of Federal Regulations, Part 15 Subpart F: Ultra-Wideband Operation
FCC ET Docket 98-153, FCC 02-48 First R&O	04/2002	Revision of Part 15 of the Commission's Rules Regarding Ultra-Wideband Transmissions Systems: First Report & Order
ANSI C63.4	01/2004	Methods of Measurement of Radio-Noise Emissions from Low-Voltage Electrical and Electronic Equipment in the Range of 9 kHz to 40 GHz

2.4. Client Information

APPLICANT	
Name:	W5networks
Address:	48389 Fremont Boulevard, Fremont, CA 94538
Contact Person:	Jason Okamoto

MANUFACTURER	
Name:	W5networks
Address:	48389 Fremont Boulevard, Fremont, CA 94538
Contact Person:	Jason Okamoto

2.5. Equipment Under Test (EUT)

The following information (with the exception of the date information) has been supplied by the applicant.

The test results in this report pertain only to the item tested.

General	
Brand Name	W5networks
Product Name	W5 ESL
Model Name or Number	Cosmos-Small-6, Cosmos-Large-57
Serial Number	6 and 57
Type of Equipment	Electronic Shelf Label
Input Power Supply Type	Internal battery
Classification	Indoor Ultra-Wideband system

Technical	
Power Supply Requirements	Internal 3V Lithium battery
RF Output Rating	-42 dBm EIRP @ 3 meters
Operating Frequency Range	3931.250 MHz – 4731.250 MHz
RF Output Impedance	50 Ω
Channel Spacing	N/A
Pulse Width	N/A
Pulse Repetition Frequency	N/A
10 dB Bandwidth	>500 MHz
Modulation/Constellation	BPSK
Oscillators' Frequencies	1443.750MHz
EUT Ports	None
Antenna Connector Type	Not applicable
Antenna Description	Folded Dipole

Logistics	
EUT Receive Date	December 10, 2007
EUT Receive Condition	Good
Test Start Date	December 10, 2007
Test Completion Date	January 4, 2008

2.5.1.Support Equipment

Description	Manufacturer	Model No.	Serial No.	FCC ID
Access Point (AP)	W5networks	AP-1NB	W5N-APB2-02	VG5AP1NB
Antenna Panel	W5networks	APX200137XX	APX200137XX	NA
LD1 Bring Up Board	W5networks	SLA000726XX	A01-19	NA
AC Power Adapter (AP)	PHIHONG	PSA65U-120	P52002095A7	No ID
AC Power Adapter (Bring Up Board)	CUI Inc	EPA-121DA-05	None	No ID
USB cable	CHINGLUNG	E238846	None	NA
Ethernet cable	CP Technologies	E197532	None	NA
Ethernet Power cable (modified)	Hyper-Data	E151955	None	NA
Serial Cable	Unknown	Unknown	None	NA
Serial to USB cable	AirLink	AC-USBS	None	NA
AC Power Adapter (PC)	DELL	HA65NS1-00	CN-0HN662-47890-78N-C6XT	No ID
Laptop PC	IBM	vostro 1500	6810846013	No ID

2.5.2.I/O Cables

Not Applicable

2.5.3. Justification

The EUT was configured to run preliminary scans in a continuous transmission mode where the symbols can be sent in a random sequence. The random sequence smoothes out the spectrum and makes the signal more white noise like. To insure maximum emissions

were detected, the system was rotated 360°, the antenna height was varied from 1 to 4 meters in 1 meter steps above the ground plane and positioned in both horizontal and vertical polarizations. The maximum emissions for the ESL's Cosmos-Small-6 with 51mm and Cosmos-Large-57 with 71mm displays are represented in the collected data enclosed.

Above 960 MHz, the measurements were made at equal or less than 1 meter due to the extremely low emission limits outside the UWB bandwidth margins. At 3 meters, the instrument noise floor is at or above the limits specified in 15.517(c). The intentional emissions were measured at 3 meter distance.

The highest frequency employed in 47 CFR Section 15.33 to determine the frequency range over which radiated emissions are made were based on the center frequency, f_c , unless a higher frequency was generated within the UWB device. For measuring emission levels, the spectrum was investigated from the lowest frequency generated in the UWB, without going below 9 kHz, up to the frequency range shown in Section 15.33(a) of 47 CFR or up to $f_c + 3/(\text{pulse width in seconds})$, whichever was higher. There is no requirement to measure emissions beyond 40 GHz provided f_c was less than 10 GHz; beyond 100 GHz if f_c was at or above 10 GHz and below 30 GHz; or beyond 200 GHz if f_c was at or above 30 GHz.

The center frequency f_c was found to be 4532 MHz for Cosmos-Small-6 and 4533.5 MHz for Cosmos-Large-57. Therefore; the highest frequency to be measured was 40 GHz.

2.5.4. Mode(s) of Operation

The device complies with §15.517(a)(5)

2.6. Modifications Required for Compliance

No modifications were required to bring the unit into compliance with the appropriate sections of FCC 47 CFR Part 15.



3. Facilities and Accreditation

3.1. Facilities and Equipment

The entire EMC test facility (comprising of the open area test site, semi-anechoic chamber, fully anechoic antenna/high frequency chamber, and support test instrumentation) is located at 1101 Cypress Creek Rd, Cedar Park, TX USA 78613.



All measurement facilities are constructed in conformance with the requirements of ANSI C63.7, ANSI C63.4 and CISPR Publication 22.

The test receiver instrumentation (e.g. receiver, analyzer, QP adapter, pre-selector) and LISN's conform to the CISPR Publication 16-2 (Specifications for Radio Interference Measuring Apparatus and Measurement Methods) Publication 16-1 where required.

3.2. Laboratory Accreditations and Listings

The test facilities used to perform radiated and conducted emissions tests are accredited by National Voluntary Laboratory Accreditation Program for the specific scope of accreditation under Lab Code: 200430-0 to perform Electromagnetic Compatibility tests according to FCC 47 CFR, Part 15 and CISPR 22 requirements. No part of this report may be used to claim or imply product endorsement by NVLAP or any agency of the US Government.

3.3. Table of Accreditations and Listings

Country	Agency	Accreditation	Logo
USA	NVLAP	200430-0	 NVLAP LAB Code: 200430-0
USA	FCC	94066	

4. Test Equipments and Procedure

4.1. Test and Measurement Equipment

Test Equipment Matrix				
Description	Make	Model No.	Serial No.	Cal Due
EMI Receiver RF Section	HP	8546A	3520A00237	01/20/08
EMI Receiver RF Filter Section	HP	85460A	3448A00238	01/20/08
PSA	Agilent	E4448A	US42070173	12/29/07
PSA	Agilent	E4448A	MY46180748	11/14/08
Preamplifier	Quinstar	QLN-2230J0	7164001	05/01/08
Preamplifier	Quinstar	QLN-3330J0	7164002	05/01/08
Preamplifier	TDK	PA-02	0900002	05/21/08
Hybrid Log Antenna	TDK	HLP-3003C	130258	03/09/08
Horn Antenna	TDK	HRN0118	130091	06/10/08
Horn Antenna	ARA	SWH-28	1008	06/01/08
Horn Antenna	ARA	SWH-29	1003	06/01/08
RF Cable	Semflex	59082-283	1000	05/22/08
RF Cable	Semflex	59082-285	1000	05/22/08
RF Cable	MicroCoax	UFB142A-0-1574- 200200	211499-001	05/23/08
RF Cable	MicroCoax	UFB142A-0-0788- 200200	10235-001	05/23/08
RF Cable	Huber+Suhner	Sucoflex 106P	181543-003	02/14/08
RF Cable	Huber+Suhner	Sucoflex 106P	181543-009	08/16/08
LISN	EMCO	3810/2NM	9702-1823	06/28/08

4.2. Measuring Instrument Calibration

The measuring equipment utilized to perform the tests documented in this report have been calibrated in accordance with the manufacturer's recommendations, and are traceable to recognized national standards.

4.3. Measurement Uncertainty

Compliance of the product is based on the reported measured values. However, the measurement uncertainty is included for informational purposes in the table below.

Radiated Emissions			
Frequency Range	1 m	3 m	10 m
30 MHz to 200 MHz	N/A	± 3.8 dB	± 3.5 dB
200 MHz to 1 GHz	N/A	± 3.8 dB	± 3.5 dB
1 GHz to 18 GHz	± 4.5 dB	± 4.6 dB	N/A
18 GHz to 40 GHz	± 4.2 dB	N/A	N/A

Conducted Emissions	
Frequency Range	
150 kHz to 30 MHz	± 2.6 dB

Note: The combined level of uncertainty in each case above was expanded to provide a confidence level of approximately 95% (k=2).

4.4. Test Setup for UWB Device Tests

4.4.1. EUT Setup

The EUT was powered by an internal 3V lithium battery. To activate UWB circuit, EUT was programmed by supporting software and activated utilizing an Access Point (AP). A continuous transmission of random data was sent at 1.38 kbps. All supporting equipment was removed and system acted as stand-alone.

Setup Diagram:

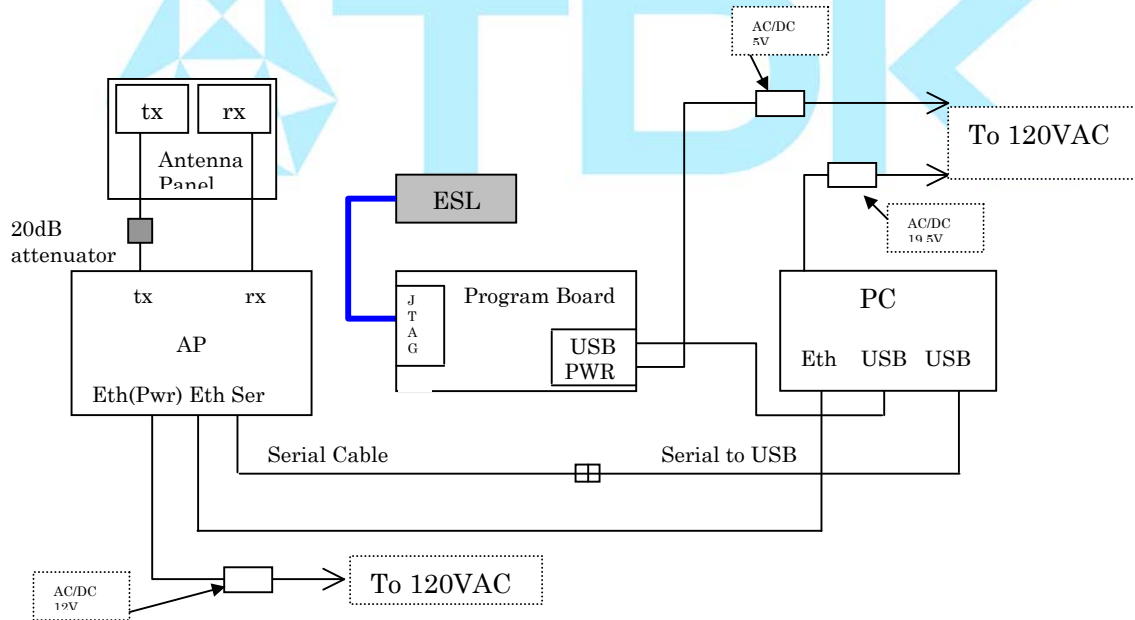

4.4.2. Radiated Emission Test Setup

In order to test compliance of EUT, facilities described section 3, and test and measurement equipment listed in section 4.1, were used. For all measurements the EUT was located on a table whose top was 80 cm above the ground plane. The table was constructed of non-conductive materials and the dimensions were 0.8 meter by 1.2 meter. The table was located in the center of the turntable.

For the test four types of receive antennas were used depending on frequency range. The antenna was held on an antenna mast which has the ability to switch the polarization of the receive antenna by 90 degree by means of mechanical rotation. The distance between the EUT and the receive antenna was equal or less than 3 meters, depending on the test. Shorter measurement distances may be used to improve the measurement system's noise floor. As Subpart F description is based on the measurement in distance of 3 meters, the data obtained at 1 meter distance was compared to the calculated limit for 1m distance:

Limit at 1meter distance (dBm)

$$= \text{limit at 3 meter distance (dBm)} - 20\log(1/3)(\text{dB})$$

$$= \text{limit at 3 m distance (dBm)} - 9.54(\text{dB}).$$

The maximization of the radiated signal was achieved by rotating the EUT over 360 degrees in the azimuth, because the EUT is designed for table top usage so that orienting the EUT in three orthogonal axes was

difficult. Additionally, the receive antenna was scanned in height from 1 meter to 4 meters (while maintaining boresight alignment) with both horizontal and vertical polarizations being recorded. The maximization was performed by use of automated software with CPU controlled maximum-hold function for both single and multiple sweeps.

The spectrum analyzer and EMI receiver was set up as described in each test procedure in section 6. The data used to determine compliance of EUT was calculated from the data following the method described in section 4.6. The equipment set up for the radiated emissions tests followed the guidelines in ANSI C63.4: latest edition.

4.4.3. Conducted Emission Test Setup

Not Applicable.



4.4.4. Test Configuration Photographs

EUT Setup



3600 MHz – 5200 MHz

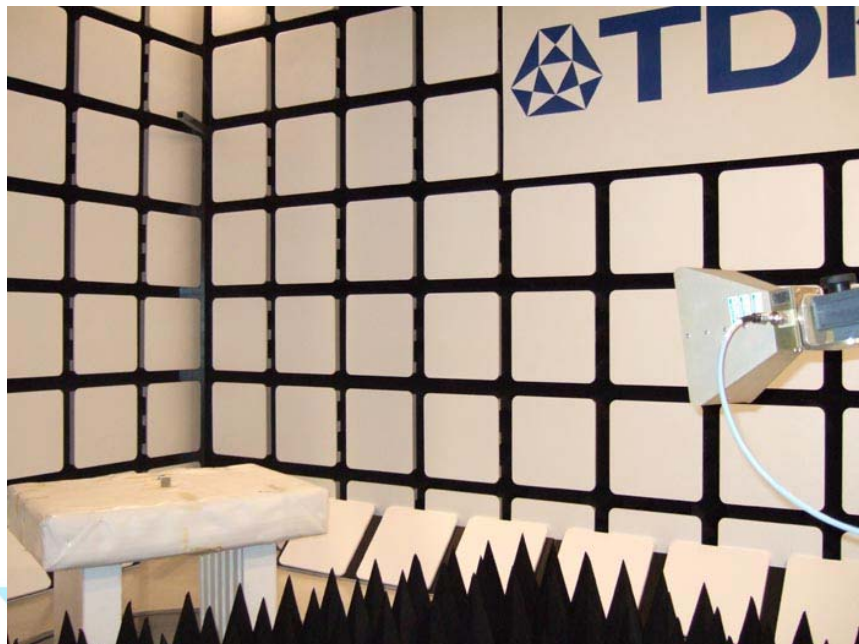

960 MHz – 40 GHz



30 MHz – 960 MHz



4.4.5.EUT Setup for Digital Circuitry Radiated Emission Tests

In order to test compliance of EUT, facilities described section 3, and test and measurement equipment-listed section 4.1, were used. For all measurements, the EUT was located on a table whose top was 0.8 m above the ground plane. The table was constructed of non-conductive materials and the dimensions were 0.8 meter by 1.2 meter. The table was located in the center of the turntable.

4.5. Measurement Calculations

4.5.1.Field Strength Calculations

The field strength is calculated by taking the received spectrum analyzer (or receiver) signal and adjusting it by the system parameters. These system parameters are the antenna factor (AF); any cable, coupler, filter or switching losses (CL); and the preamplifier gain (PG). The basic formula is displayed below.

$$E \text{ (dB}\mu\text{V/m)} = SA \text{ (dB}\mu\text{V)} + AF \text{ (dB/m)} + CL \text{ (dB)} - PG \text{ (dB)}$$

Where:

E is the electric field represented in dB μ V/m

SA is the spectrum analyser (or receiver) reading in dB μ V

AF is the receive antenna's factor in dB/m

CL is the cable, etc. system losses in dB

PG is the external pre-amplifier gain in dB

Assume a spectrum analyzer reading of 50 dB μ V at 80 MHz on a 3 meter site. With an antenna factor of 10 dB/m, system losses of about 1.5 dB, and a pre-amplifier gain of 25 dB, the resulting electric field strength would be calculated as follows.

$$E \text{ (dB}\mu\text{V/m)} = 50 \text{ (dB}\mu\text{V)} + 10 \text{ (dB/m)} + 1.5 \text{ (dB)} - 25 \text{ (dB)} = 36.5 \text{ dB}\mu\text{V/m}$$

4.5.2.EIRP Calculations

As defined in FCC 47 CFR Part 15, Subpart F (15.503 k), EIRP is the equivalent isotropic radiated power, i.e. the product of the power supplied to the antenna and the antenna gain in a given direction

relative to an isotropic antenna. The EIRP, in terms of dBm, can be converted to field strength, in dB μ V/m at 3 meters, by adding 95.2 dB. Conversely, the field strength in dB μ V/m at 3 meters can be converted to the EIRP in dBm by subtracting 95.2 dB. As used in Subpart F, EIRP refers to the highest signal strength measured in any direction and at any frequency from the UWB device, as tested in accordance with the procedures specified in 15.31(a) and 15.523 of FCC 47 CFR.

As in the example above, assume a spectrum analyzer reading of 50 dB μ V at 80 MHz on a 3 m site. With an antenna factor of 10 dB/m, system losses of about 1.5 dB, and a pre-amplifier gain of 25 dB, the resulting electric field strength would be calculated as follows.

$$E \text{ (dB}\mu\text{V/m)} = 50 \text{ (dB}\mu\text{V)} + 10 \text{ (dB/m)} + 1.5 \text{ (dB)} - 25 \text{ (dB)} = 36.5 \text{ dB}\mu\text{V/m}$$

Now to convert to an EIRP reading at 3 meters use $EIRP \text{ (dBm)} = E \text{ (dB}\mu\text{V/m)} - 95.2 \text{ (dB)}$

$$EIRP \text{ (dBm)} = 36.5 \text{ (dB}\mu\text{V/m)} - 95.2 \text{ (dB)} = -58.7 \text{ dBm}$$

4.5.3.UWB Maximum Permissible Exposure

Transmitter Category: Mobile Device. A mobile device is defined as a transmitting device designed to be used in other than fixed location and the be generally used in such as way that a separation distance of at least 20 cm is normally maintained between the transmitter's radiating structures and the body of the user or nearby persons. The FCC rules for evaluating mobile devices for RF compliance are found in 47 CFR §2.1091.

Device Usage: General Population/Uncontrolled Exposure. The general population/uncontrolled exposure limits are applicable to situation in which the general public may be exposed or in which persons who are exposed as a consequence of their employment may not be made fully aware of the potential for exposure or cannot exercise control over their exposure.

Exposure Calculation: According to §1.1310 of the FCC rules, the power density limit for the General Population/Uncontrolled Exposure is 1 mW/cm². According to the mobile product device category, this value is to be calculated at a distance of 20 cm. The following formula is used to calculate the power density.

$$S = \frac{PG}{4\pi r^2} = \frac{EIRP}{4\pi r^2}$$

Where:

S = Power Density

P = Power at the Antenna Terminal

G = Gain of the Transmit Antenna

EIRP = Effective Isotropic Radiated Power

r = Measurement Distance

From the measurement data we can see that the peak detected EIRP at 3 meters distance and 3 MHz RBW yields a result of -40.15 dBm. Translated to 20 cm this would yield a result of -16.63 dBm. Correlating this to a worst-case scenario with a 50 MHz RBW would yield 7.81 dBm EIRP. 7.81 dBm is equal to 6.04 mW EIRP. Plugging this into the above equation yields:

$$S = \frac{6.04}{4\pi(20)^2} = 0.00120 \text{ mW} / \text{cm}^2$$

Based on these worse case calculations the device is well below the maximum permissible exposure limit of $1 \text{ mW}/\text{cm}^2$ by a large margin.



5. Operational Limitations

FCC 47 CFR Section 15.517 (a)(1)

Indoor UWB devices, by the nature of their design, must be capable of operation only indoors. The necessity to operate with a fixed indoor infrastructure, *e.g.*, a transmitter that must be connected to the AC power lines, may be considered sufficient to demonstrate this.

In order for the ESL to transmit it must be associated with an Access Point and receive an RF signal from the Access Point. The Access Point operates in the UNII bands and transmits a pilot signal which the ESL uses to set its frequency of operation. Without the presence of the pilot signal the ESL cannot transmit. Since the Access Point is powered solely from the AC mains this system is intended only to operate indoors. The ESL is designed to be securely mounted to the edge of store shelves adjacent to products in order to display product prices. The mounting mechanism locks the ESL in place on the shelf and requires a special key for removal.

FCC 47 CFR Section 15.517 (a)(2)

The emissions from equipment operated under this section shall not be intentionally directed outside of the building in which the equipment is located, such as through a window or a doorway, to perform an outside function, such as the detection of persons about to enter a building.

The client has been informed of this requirement.

FCC 47 CFR Section 15.517 (a)(3)

The use of outdoor mounted antennas, *e.g.*, antennas mounted on the outside of a building or on a telephone pole, or any other outdoors infrastructure is prohibited.

The client has been informed of this requirement.

FCC 47 CFR Section 15.517 (a)(4)

Field disturbance sensors installed inside of metal or underground storage tanks are considered to operate indoors provided the emissions are directed towards the ground.

Not applicable for this client.

FCC 47 CFR Section 15.517 (a)(5)

A communications system shall transmit only when the intentional radiator is sending information to an associated receiver.

The client has been informed of this requirement.



Test Limits, Procedures, Results and Setups

5.1. UWB Bandwidth

5.1.1. Test Limits

Ultra-wideband (UWB) transmitter. An intentional radiator that, at any point in time, has a fractional bandwidth equal to or greater than 0.20 or has a UWB bandwidth equal to or greater than 500 MHz, regardless of the fractional bandwidth

The UWB bandwidth is the frequency band bounded by the points that are 10 dB below the highest radiated emission, as based on the complete transmission system including the antenna. The upper boundary is designated f_H and the lower boundary is designated f_L . The frequency at which the highest radiated emission occurs is designated f_M .

Center frequency. The center frequency, f_C , equals $(f_H + f_L)/2$.

Fractional bandwidth. The fractional bandwidth equals $2(f_H - f_L)/(f_H + f_L)$.

As per section 15.517(b), the UWB bandwidth of a UWB system operating under the provisions of this section must be contained between 3100 MHz and 10600 MHz.

5.1.2. Test Procedure

Facilities and equipment was set up as described in section 4; resolution bandwidth (RBW) of 3 MHz, video bandwidth (VBW) of 3 MHz, peak detector, and the sweep time was set to auto. The EUT was located at 3 meter distance from the receive antenna.

Maximum emission amplitude was determined from the measured data for both horizontal and vertical polarization and the higher amplitude of emission of these two polarizations was used to determine the frequency at which the highest radiated emission occurs, f_M . Next, the points that are 10dB or more below the highest radiated emission were observed in a search from f_M in both the lower and higher frequency direction in the measured frequency EIRP graph, they are denoted as f_L and f_H , respectively. The UWB bandwidth is the difference between f_L and f_H .

Both horizontal and vertical polarizations were taken into account to determine the full UWB BW on the maximized (in azimuth and elevation) signals.

5.1.3. Test Results

UWB Bandwidth Requirements: 51mm

47 CFR, Part 15, Subpart F, §15.517(b)

Cosmos-Small-6

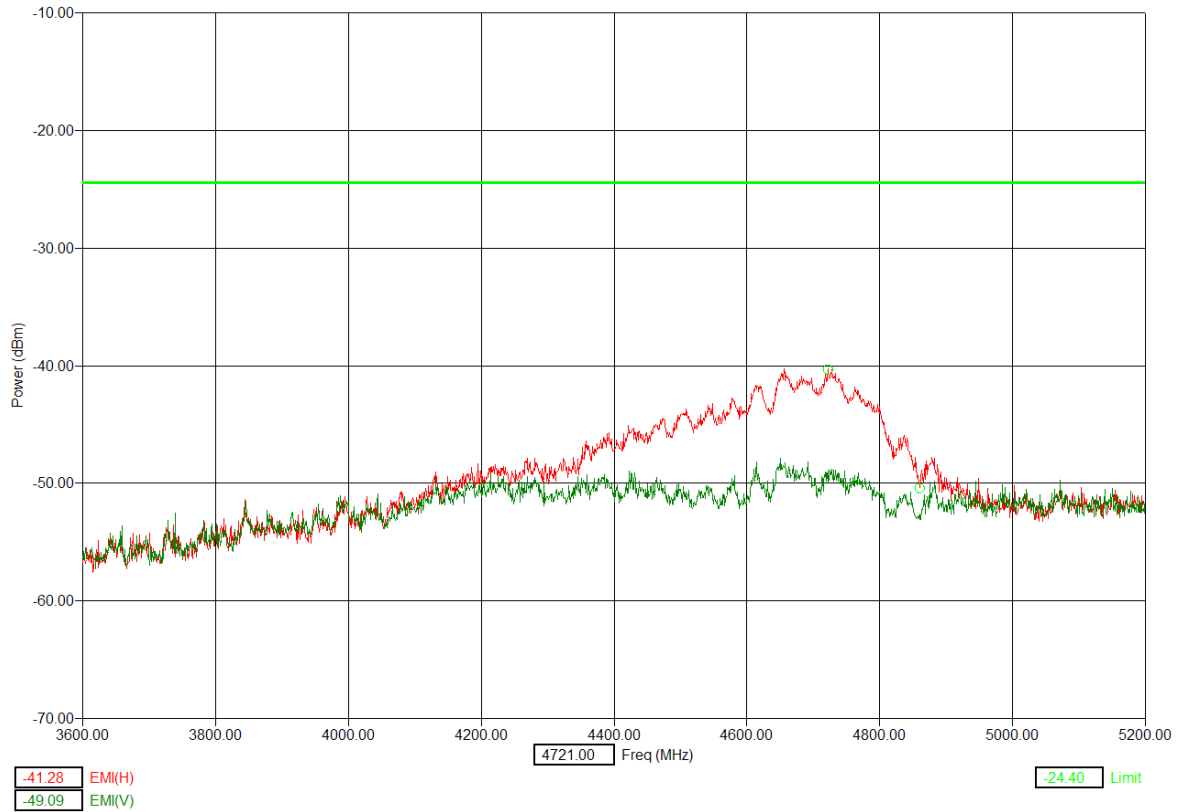

Frequency: 3600 MHz to 5200 MHz

UWB BW = 658 MHz;

$F_L = 4203$ MHz; $F_H = 4861$ MHz; $F_M = 4722$ MHz; $F_C = 4532$ MHz

Measurements made with 3 MHz RBW / 3 MHz VBW, peak detector

Measurement Time auto for sweep

Measurement Distance: 3 meters



UWB Bandwidth Requirements: 71mm

47 CFR, Part 15, Subpart F, §15.517(b)

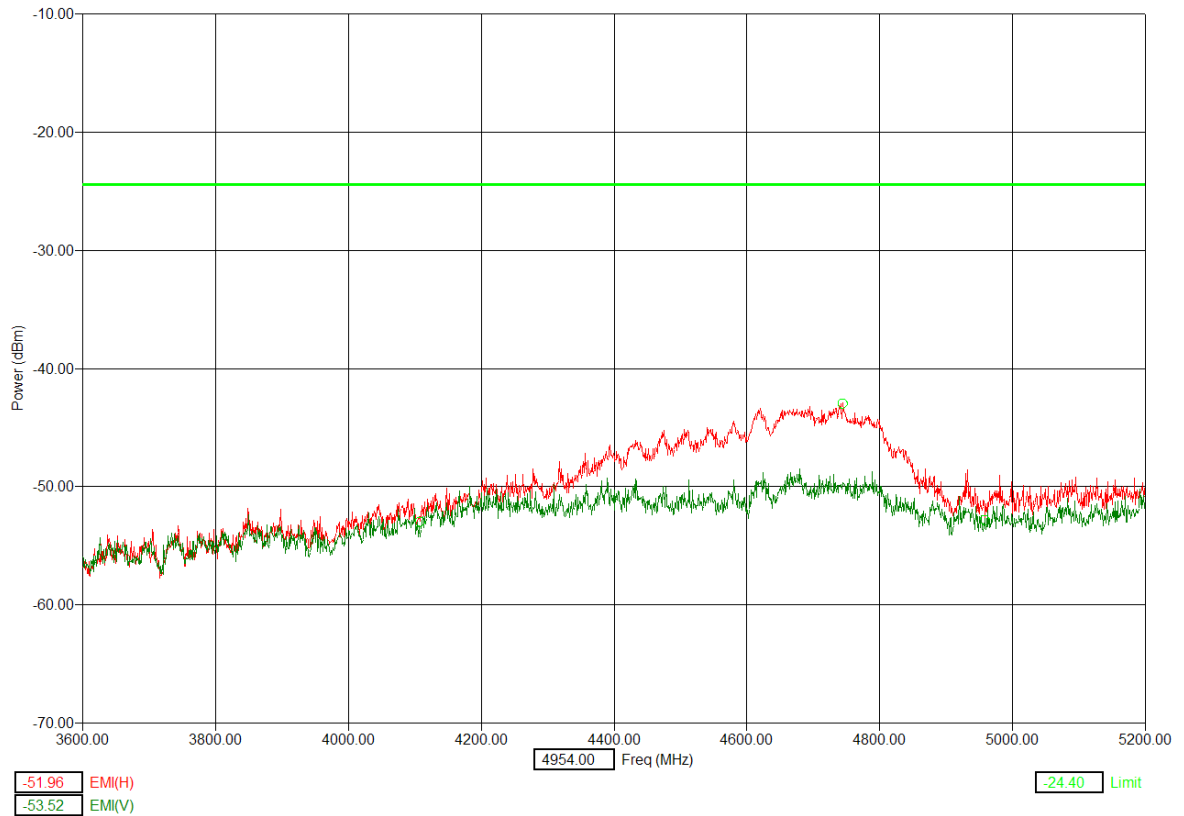

Frequency: 3600 MHz to 5200 MHz

UWB BW = 851 MHz;

$F_L = 4108$ MHz; $F_H = 4959$ MHz; $F_M = 4745$ MHz; $F_C = 4533.5$ MHz

Measurements made with 3 MHz RBW / 3 MHz VBW, peak detector

Measurement Time auto for sweep

Measurement Distance: 3 meters



5.2. Radiated Emissions, UWB Specific Requirements

5.2.1. Test Limits

The radiated emissions at or below 960 MHz shall not exceed the emission levels in Section 15.209 Table below.

Frequency (MHz)	E-Field ($\mu\text{V}/\text{m}$)	E- Field ($\text{dB}\mu\text{V}/\text{m}$)	Distance (m)
0.009 to 0.490	2400/F(kHz)	67.6 – 20Log[F(kHz)]	300
0.490 to 1.705	24000/F(kHz)	87.6 – 20Log[F(kHz)]	30
1.705 to 30.0	30	29.5	30
30 to 88	100	40.0	3
88 to 216	150	43.5	3
216 to 960	200	46.0	3

The radiated emissions above 960 MHz shall not exceed the RMS detected limits in Section 15.517c table below when measured using a resolution bandwidth of 1 MHz.

Frequency (MHz)	EIRP (dBm)	E- Field ($\text{dB}\mu\text{V}/\text{m}$)	Distance (m)
960 to 1610	-75.3	19.9	3
1610 to 1990	-53.3	41.9	3
1990 to 3100	-51.3	43.9	3
3100 to 10600	-41.3	53.9	3
Above 10600	-51.3	43.9	3

From 47 CFR Section 15.521(c): As noted in Section 15.3(k), digital circuitry that is used only to enable the operation of a transmitter and that does not control additional functions or capabilities is not classified as a digital device. Instead, the emissions from that digital circuitry are subject to the same limits as those applicable to the transmitter. If it can be clearly demonstrated that an emission from a UWB transmitter is due solely to emissions from digital circuitry contained within the transmitter and that the emission is not intended to be radiated from

the transmitter's antenna, the limits shown in Section 15.209 shall apply to that emission rather than the limits specified in this section.

5.2.2. Test Procedure

The measurements made over the frequency range from 30 MHz to 960 MHz were maximized using an EMI receiver with peak detector capabilities. Measurements of the radiated field from 30 MHz to 960 MHz were made with the measurement antenna located a distance of 3 meters from the EUT and the final measurements utilizing a quasi-peak detector at the frequencies with the largest amplitudes. The relative CISPR resolutions bandwidth of 120 kHz was used for these measurements. In the case where there was sufficient margin between the peak detected maximized spectrum and the quasi-peak limit lines, no additional measurements were undertaken.

Measurements above 960 MHz were maximized using a spectrum analyzer with RMS detector capabilities. A spectrum analyzer was used for the final measurements utilizing an RMS detector at the frequencies with the largest amplitudes. The prescribed RBW of 1 MHz and VBW of 3 MHz, and a 1 msec averaging time were used for these measurements. Measurements of the radiated field at frequencies above 960 MHz were made with the measurement antenna located a distance of 1 meter or less from the EUT.

The equipment set up for the radiated emissions tests followed the guidelines in ANSI C63.4.

5.2.3. Test Results

The spectrum between 30 MHz and 960 MHz contained no intentional radiation and lies below the limits. The spectrum between 960 MHz and 12 GHz contained intentional UWB signals between 3100 MHz and 10600 MHz and lie below the limits. No other intentional emissions above 10600 MHz were detected. The maximum frequency tested was 40 GHz.

Per 47 CFR, Part 15, Subpart F, §15.521(c) (§15.209) all digital emissions from the transmitter whether radiating from the antenna port or not intended to be radiated from the antenna port meet the 15.209 subpart C limits.

Additional measurements in the 960 MHz to 40 GHz range were performed to determine the nature of all unintentional emissions in this span. Conducted antenna port measurement and terminated antenna

port measurement were done in the 960 MHz to 8 GHz range to show that all noise peaks have the same frequency and polarization and are determined to be emission from the digital circuit and are not intended to be radiated from the antenna.

Per 47 CFR, Part 15, Subpart F, §15.505(a) (§15.109) all emissions from the digital devices not directly associated with the operation of the transmitter meets the Class B limits of §15.109

Refer to the UWB Radiated Emissions 960 MHz to 40 GHz section for specific data presentation.



UWB Radiated Emissions 30 MHz to 960 MHz Requirements:

47 CFR, Part 15, Subpart F, §15.517(c) (§15.209)

51mm

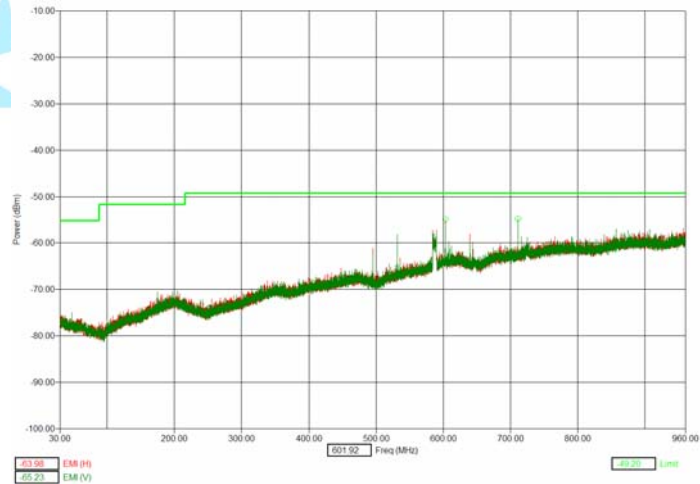

71mm

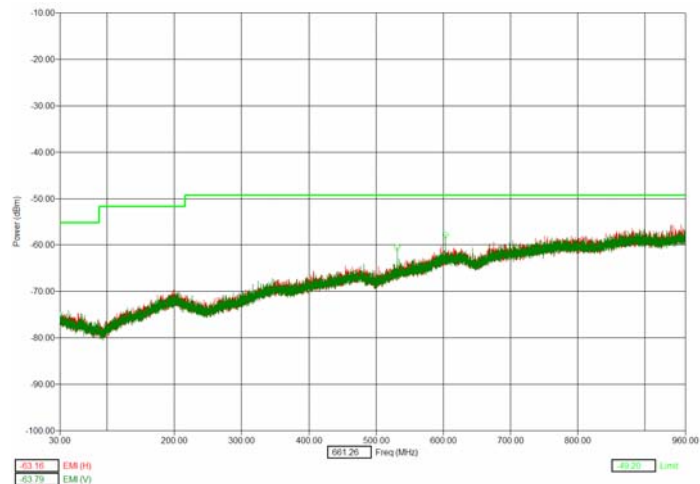

Frequency: 30 MHz to 960 MHz

In both polarizations the peak-detected measurements were below the quasi-peak limit

Measurements made with 120 kHz RBW, VBW auto, at 3 meter distance

Measurement Time auto for sweep

Limit line converted to dBm

All digital emissions from the transmitter whether radiating from the antenna port or not intended to be radiated from the antenna port meet the limits of 47 CFR, Part 15, Subpart F, §15.517(c) (§15.209)

Identification of spike Emissions 30 MHz to 960 MHz

51mm

Freq (Max) (MHz)	Pol	(QP) EMI (dBm)	(QP) Margin (dB)	Limit (dBm)	Twr Ht (cm)	Ttbl Agl (deg)
603.26	H	-57.48	8.28	-49.20	154.39	68.00
711.28	V	-59.08	9.88	-49.20	281.95	22.00

71mm

Freq (Max) (MHz)	Pol	(QP) EMI (dBm)	(QP) Margin (dB)	Limit (dBm)	Twr Ht (cm)	Ttbl Agl (deg)
531.23	H	-64.32	15.12	-49.20	328.91	195.00
603.28	V	-61.53	12.33	-49.20	142.30	220.00



UWB Radiated Emissions 960 MHz to 8 GHz Requirements:

47 CFR, Part 15, Subpart F, §15.517(c) (§15.209)

51mm

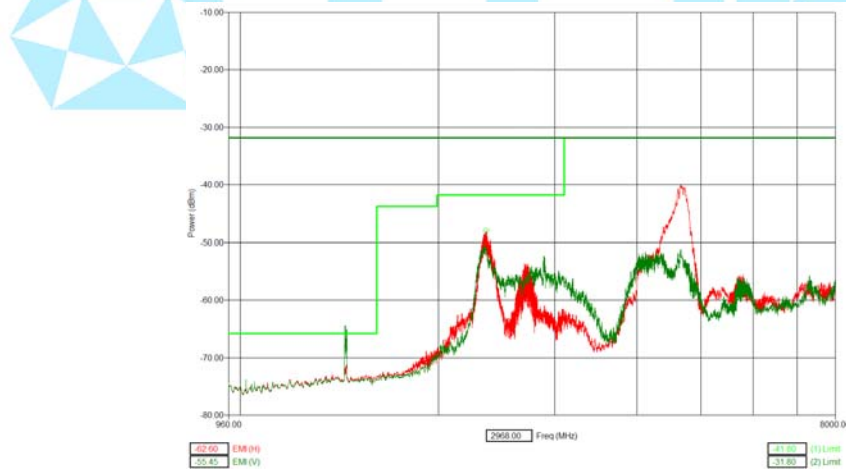

71mm

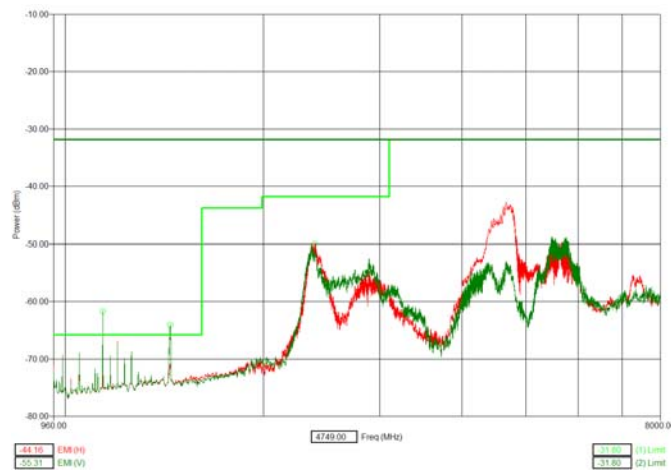

Frequency: 960 MHz to 8 GHz

Measurements made with 1 MHz RBW / 3 MHz VBW at 1 meter distance

Measurement time 1 msec per frequency

Limit line converted to account for 1 meter measurement distance

Total range maximized. Additional final measurement done at peak

All digital emissions from the transmitter radiating from the antenna port meet the limits of 47 CFR, Part 15, Subpart F, §15.517(c) (§15.209). See the following graphs for expanded detail of the emissions caused by digital emissions.

Identification of digital noise 960 MHz to 8 GHz:

51mm

Freq (Max) (MHz)	Pol	(RMS) EMI (dBm)	(RMS) Margin (dB)	Limit (dBm)	Twr Ht (cm)	Ttbl Agl (deg)
2359.98	H	-48.76	16.96	-31.80	106.00	188.00

71mm

Freq (Max) (MHz)	Pol	(RMS) EMI (dBm)	(RMS) Margin (dB)	Limit (dBm)	Twr Ht (cm)	Ttbl Agl (deg)
1139.91	V	-61.47	29.67	-31.80	192.00	360.00
1444.79	V	-73.34	41.54	-31.80	146.00	163.00
2394.33	H	-50.20	18.40	-31.80	107.00	194.00

All digital emissions not intended to be radiated from the antenna port meet the limits of 47 CFR, Part §15.209, Subpart C.



UWB Radiated Emissions 3600 MHz – 5200 MHz

47 CFR, Part 15, Subpart F, §15.517(c) (§15.209)

51mm

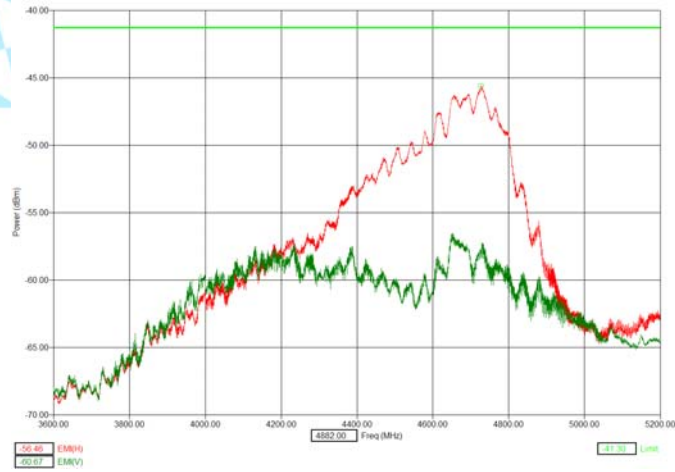
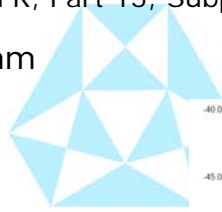

71mm

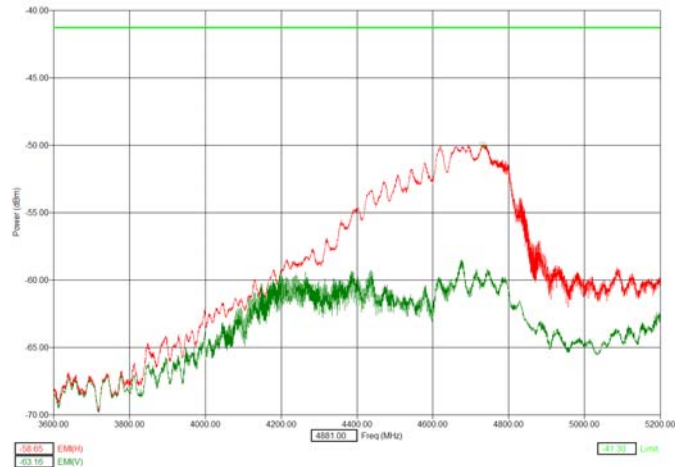

Frequency: 3150 MHz to 4800 MHz

Measurements made with 1 MHz RBW / 3 MHz VBW at 3 meter distance

Measurement time 1 msec per frequency

Antenna height 1 to 4 meters, 1 meter steps, antenna boresighted to EUT.



Final Measurements 3600 MHz to 5200 MHz:

51mm

Freq (Max) (MHz)	Pol	(RMS) EMI (dBm)	(RMS) Margin (dB)	Twr Ht (cm)	Ttbl Agl (deg)
4727.17	H	-45.88	4.58	100.00	182.00

71mm

Freq (Max) (MHz)	Pol	(RMS) EMI (dBm)	(RMS) Margin (dB)	Twr Ht (cm)	Ttbl Agl (deg)
4730.76	H	-49.63	8.33	100.00	360.00



UWB Radiated Emissions 8 GHz to 12 GHz Requirements:

47 CFR, Part 15, Subpart F, §15.517(c) (§15.209)

51 mm

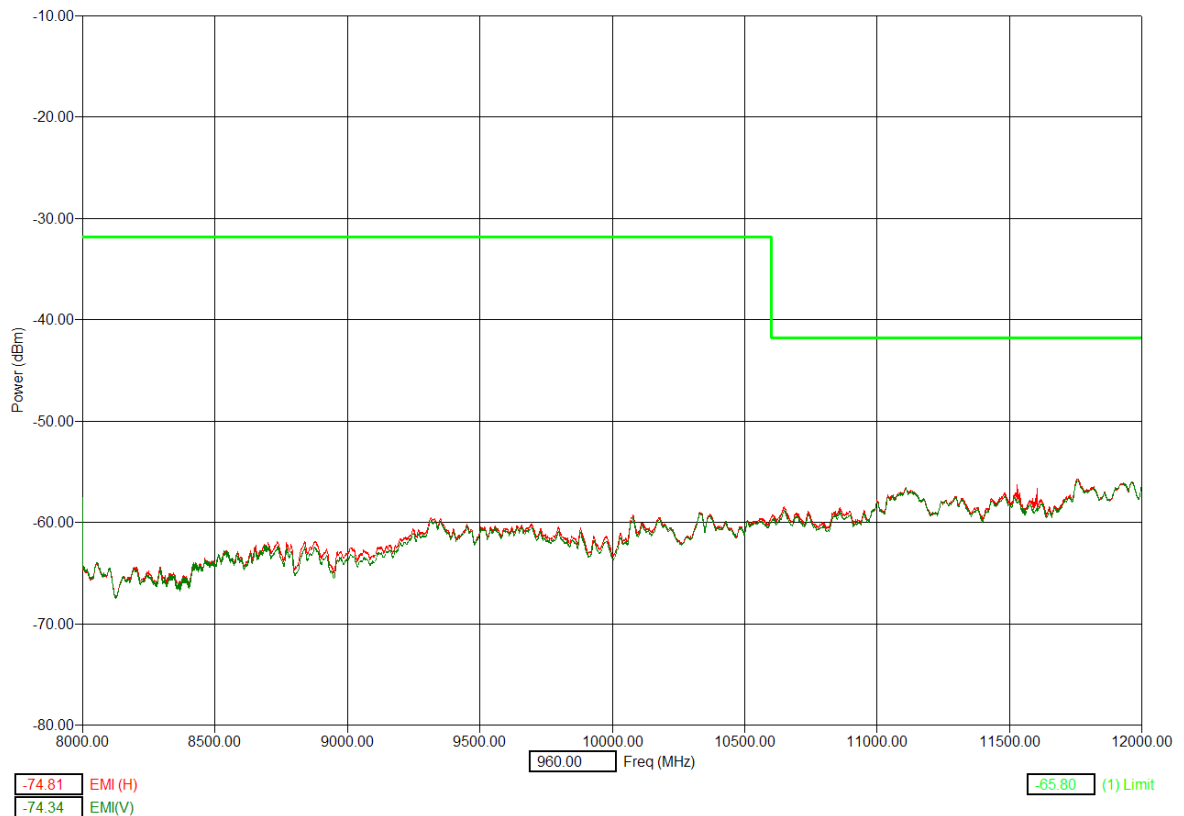

Frequency: 8 GHz to 12 GHz

In both polarizations the measurements were below the RMS limit line

Measurements made with 1 MHz RBW / 3 MHz VBW at 0.5 meter distance

Measurement Time 1 msec per frequency

Limit line converted to account for 0.5 meter measurement distance

All digital emissions from the transmitter whether radiating from the antenna port or not intended to be radiated from the antenna port meet the limits of 47 CFR, Part 15, Subpart F, §15.517(c) (§15.209)

UWB Radiated Emissions 12 GHz to 18 GHz Requirements:

47 CFR, Part 15, Subpart F, §15.517(c) (§15.209)

51 mm



Frequency: 12 GHz to 18 GHz

In both polarizations the measurements were below the RMS limit line

Measurements made with 1 MHz RBW / 3 MHz VBW at 1 meter distance

Measurement Time 1 msec per frequency

Limit line converted to account for 1 meter measurement distance

No unintentional digital emissions were detected in this range

All digital emissions from the transmitter whether radiating from the antenna port or not intended to be radiated from the antenna port meet the limits of 47 CFR, Part 15, Subpart F, §15.517(c) (§15.209)

UWB Radiated Emissions 18 GHz to 26 GHz Requirements:

47 CFR, Part 15, Subpart F, §15.517(c) (§15.209)

51 mm

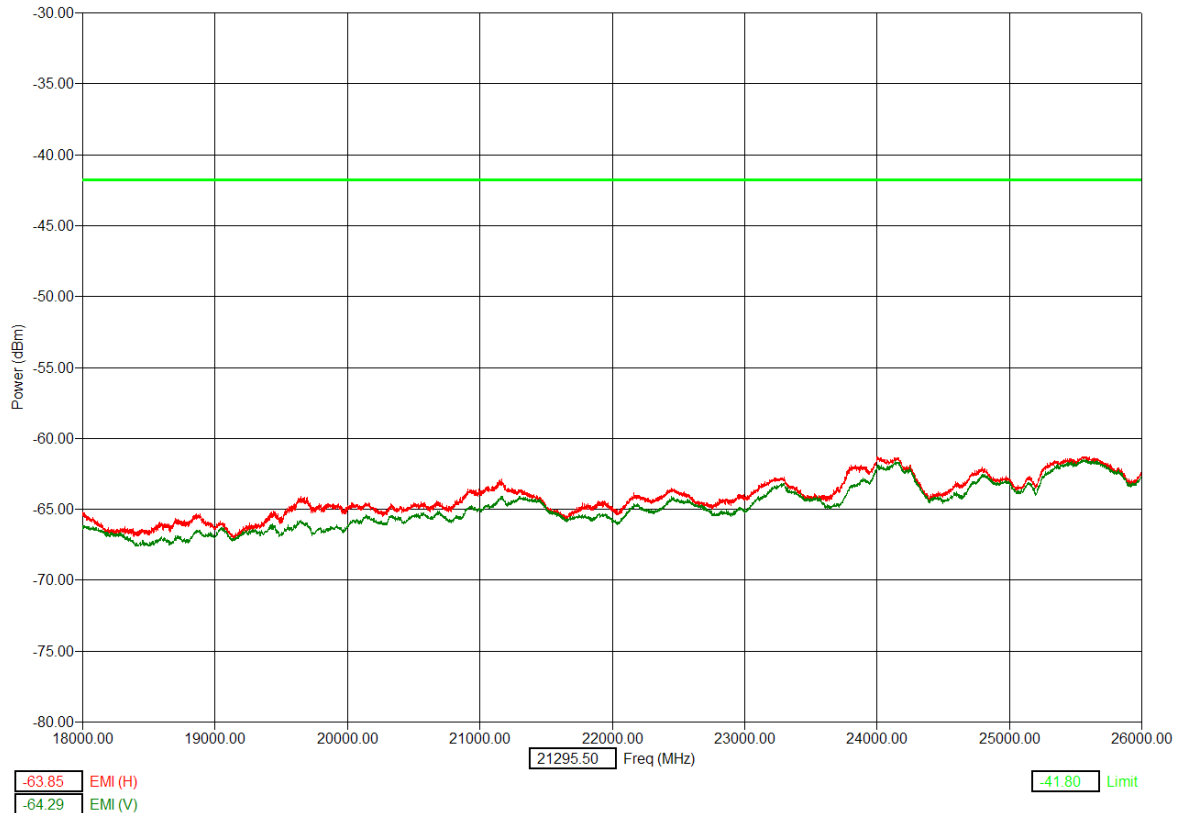

Frequency: 18 GHz to 26 GHz

In both polarizations the measurements were below the RMS limit line

Measurements made with 1 MHz RBW / 3 MHz VBW at 1 meter distance

Measurement Time 1 msec per frequency

Limit line converted to account for 1 meter measurement distance

No unintentional digital emissions were detected in this range

All digital emissions from the transmitter whether radiating from the antenna port or not intended to be radiated from the antenna port meet the limits of 47 CFR, Part 15, Subpart F, §15.517(c) (§15.209)

UWB Radiated Emissions 26 GHz to 40 GHz Requirements:

47 CFR, Part 15, Subpart F, §15.517(c) (§15.209)

51 mm

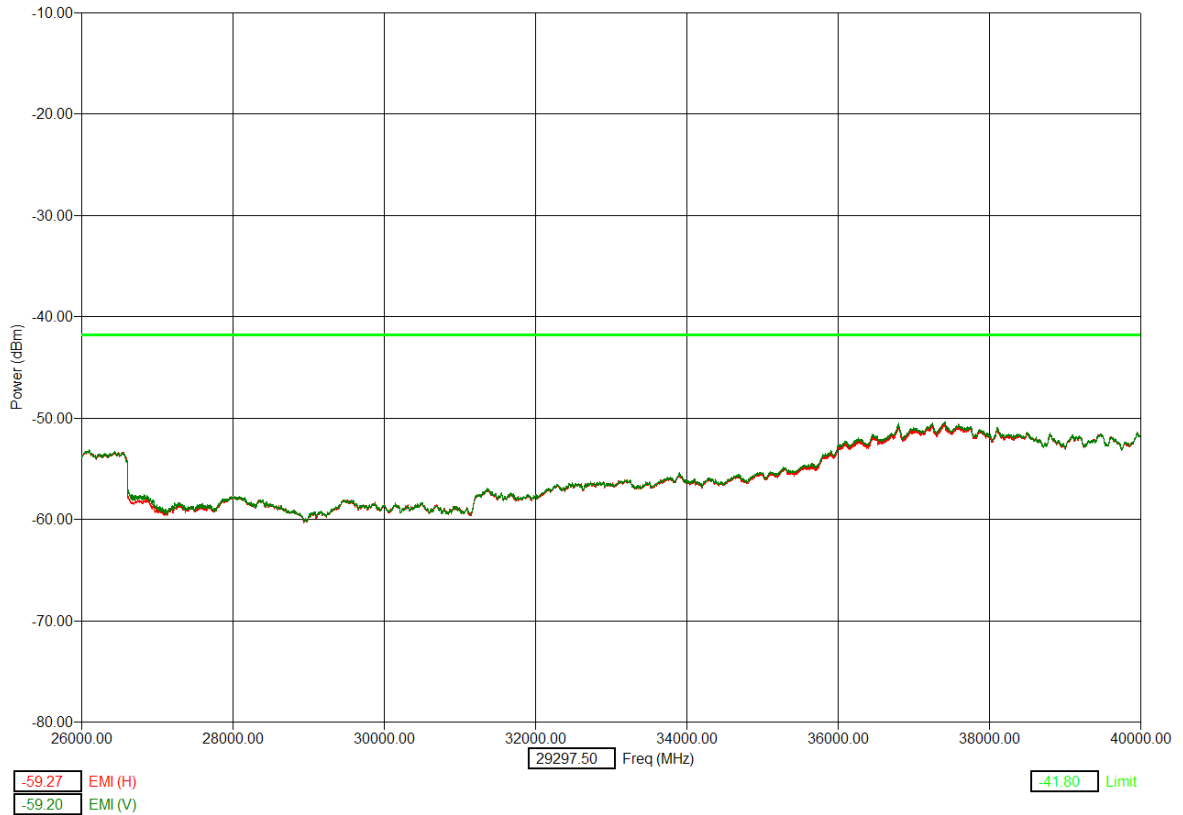

Frequency: 26 GHz to 40 GHz

In both polarizations the measurements were below the RMS limit line

Measurements made with 1 MHz RBW / 3 MHz VBW at 0.5 meter distance

Measurement Time 1 msec per frequency

Limit line converted to account for 0.5 meter measurement distance

No unintentional digital emissions were detected in this range

All digital emissions from the transmitter whether radiating from the antenna port or not intended to be radiated from the antenna port meet the limits of 47 CFR, Part 15, Subpart F, §15.517(c) (§15.209)

5.3. Radiated Emissions in GPS Bands

5.3.1. Test Limits

In addition to the radiated emission limits specified in the table in paragraph 6.2.1 of this report, UWB transmitters operating under the provisions of this section shall not exceed the following average limits when measured using a resolution bandwidth of no less than 1 kHz.

Frequency (MHz)	EIRP (dBm)	E- Field (dB μ V/m)	Distance (m)
1164 to 1240	-85.3	9.9	3
1559 to 1610	-85.3	9.9	3

5.3.2. Test Procedure

The measurements made over the frequency range from 1164 MHz to 1240 MHz and from 1559 MHz to 1610 MHz were maximized using a spectrum analyzer with RMS detector capabilities. A spectrum analyzer was used for the final measurements utilizing an RMS detector at the frequencies with the largest amplitudes. The prescribed RBW of 10 kHz and VBW of 10 kHz with a suitable averaging time were used for these measurements.

Measurements of the radiated field at these frequencies were made with the measurement antenna located a distance of 1 meter from the EUT to improve the measurement system's noise floor. In the case where there was sufficient margin between the RMS detected maximized spectrum and the RMS limit lines, no additional measurements were undertaken.

The equipment set up for the radiated emissions tests followed the guidelines in ANSI C63.4.



5.3.3. Test Results

UWB Radiated Emissions GPS Band Requirements:

47 CFR, Part 15, Subpart F, §15.517(d)

51 mm

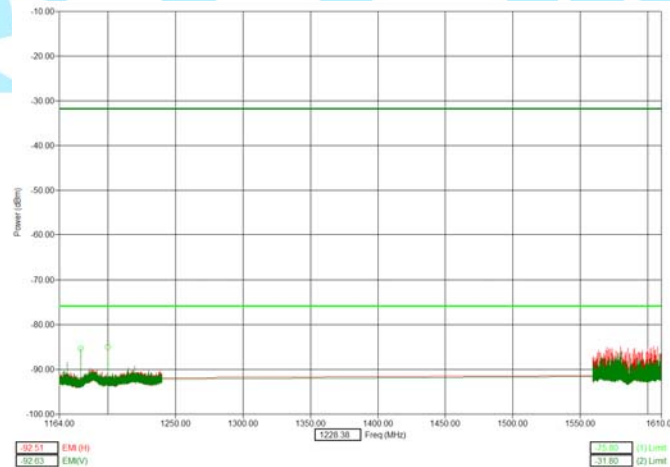

71 mm

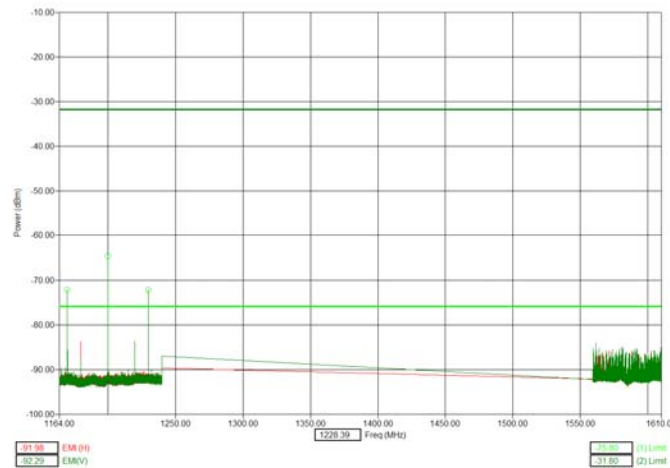

Lower limit line is 47 CFR, Part 15 sub part F

Top limit line is 47 CFR, Part 15 sub part C

Frequency: 1164 MHz to 1240 MHz and 1559 MHz to 1610 MHz

In both polarizations the measurements were below the RMS limit line

Measurements made with 10 kHz RBW / 10 kHz VBW at 1 meter distance

Measurement Time 1 msec per frequency

Limit lines converted to account for 1 meter measurement distance

All digital emissions from the transmitter radiating from the antenna port meet the limits of 47 CFR, Part 15, Subpart F, §15.517(d) (§15.209). See the following graphs for expanded detail of the emissions caused by digital emissions.

Identification of digital noise GPS Bands:

51 mm

Freq (Max) (MHz)	Pol	(RMS) EMI (dBm)	(RMS) Margin (dB)	Limit (dBm)	Twr Ht (cm)	Ttbl Agl (deg)
1180.00	V	-81.95	50.15	-31.80	177.00	347.00
1200.00	H	-83.98	52.18	-31.80	186.86	304.00

71 mm

Freq (Max) (MHz)	Pol	(RMS) EMI (dBm)	(RMS) Margin (dB)	Limit (dBm)	Twr Ht (cm)	Ttbl Agl (deg)
1170.00	V	-68.38	36.58	-31.80	139.00	221.00
1200.00	V	-61.77	29.97	-31.80	175.00	348.00
1230.00	V	-67.61	35.81	-31.80	168.00	20.00

All digital emissions not intended to be radiated from the antenna port meet the limits of 47 CFR, Part §15.209, Subpart C.



5.4. Peak Radiated Emissions in a 50 MHz RBW

5.4.1. Test Limits

There is a limit on the peak level of the emissions contained within a 50 MHz bandwidth centered on the frequency at which the highest radiated emission occurs, f_M . That limit is 0 dBm EIRP. It is acceptable to employ a different resolution bandwidth, and a correspondingly different peak emission limit, following the procedures described in Section §15.521.

5.4.2. Test Procedure

The measurements made over the intentionally radiating frequency range of the EUT, from 3100 MHz to 10600 MHz, were maximized using a spectrum analyzer with peak detector capabilities. A spectrum analyzer was used for the final measurement utilizing a peak detector at the frequency with the largest amplitude.

The spectrum analyzer did not support the prescribed resolution bandwidth of 50 MHz. However, when a peak measurement is required, it is acceptable to use a resolution bandwidth other than the 50 MHz specified in 47 CFR Part 15, Subpart F. The resolution bandwidth for this measurement was set to 3 MHz. The measurement was centered on the frequency at which the highest radiated emission occurred, f_M . The video bandwidth was 3 MHz.

Since a resolution bandwidth other than 50 MHz was employed, the peak EIRP limit has to be adjusted by the resolution bandwidth ratio of $20\log(\text{RBW}/50)\text{dB}$, where RBW is the resolution bandwidth used for the measurement expressed in MHz.

The equipment set up for the radiated emissions tests followed the guidelines in ANSI C63.4.



5.4.3. Test Results

UWB Peak Radiated Emissions in 50 MHz RBW Requirements:

47 CFR, Part 15, Subpart F, §15.517(e)

51 mm

71 mm

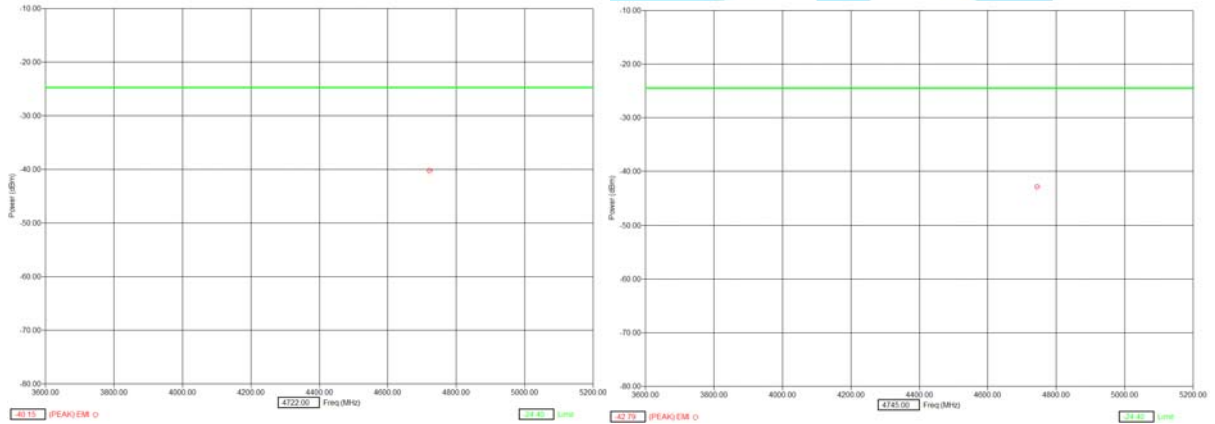

Measurements made with 3 MHz RBW / 3 MHz VBW at 3 meter distance.

Measurement Time auto for sweep

Limit line converted to account for 3 MHz RBW as per FCC requirements:
 $20\text{LOG}(\text{RBW}/50)$

Total Range Maximized. Final measurement done at peak

51 mm

Freq (Max) (MHz)	Pol	(PEAK) EMI (dBm)	(PEAK) Margin (dB)	Limit (dBm)	Twr Ht (cm)	Ttbl Agl (deg)
4723.87	H	-40.15	15.75	-24.4	100.00	13.00

71 mm

Freq (Max) (MHz)	Pol	(PEAK) EMI (dBm)	(PEAK) Margin (dB)	Limit (dBm)	Twr Ht (cm)	Ttbl Agl (deg)
4740.37	H	-42.79	18.39	-24.40	104.00	10.00



5.5. AC Mains Line-Conducted Disturbance

5.5.1. Test Limits

For an intentional radiator that is designed to be connected to the public utility (AC) power line, the radio frequency voltage that is conducted back onto the AC power line on any frequency or frequencies within the band 150 kHz to 30 MHz shall not exceed the limits in the following table, as measured using a 50 μ H/50 ohms line impedance stabilization network (LISN). Compliance with the provisions of this paragraph shall be based on the measurement of the radio frequency voltage between each power line and ground at the power terminal.

Frequency Range (MHz)	Conducted Limit (dB μ V)	
	Quasi-Peak	Average
0.15 to 0.5	66 to 56*	56 to 46*
0.5 to 5	56	46
5 to 30	60	50

* Decreases with logarithm of the frequency

5.5.2. Test Procedure

Measurements were carried out using quasi-peak and average detector receivers in accordance with ANSI C63.4. A LISN was required to provide defined impedance at high frequencies across the power feed at the point of measurement of terminal voltage and also to provide isolation of the circuit under test from the ambient noise on the power lines. A LISN as defined in ANSI C63.4.

Conducted disturbance was measured between the phase lead and the reference ground, and between the neutral lead and the reference ground. Both measured values were reported.

5.5.3. Test Results

Not Applicable

6. Labeling and Instruction Manual Requirements

A UWB device subject to certification shall be labeled as followed in a conspicuous location on the device:

“This device complies with Part 15 of the FCC Rules. Operation is subject to the following two conditions: (1) This device may not cause harmful interference, and (2) this device must accept any interference received, including interference that may cause undesired operation.”

- (1) Where a device is constructed in two or more sections connected by wires and marketed together, the statement specified directly above this section is required to be affixed only to the main control unit.
- (2) When the device is so small or for such use that it is not practicable to place the statement specified under paragraph (a) of this section on it, the information required by this paragraph shall be placed in a prominent location in the instruction manual or pamphlet supplied to the user or, alternatively, shall be placed on the container in which the device is marketed. However, the FCC identifier or the unique identifier, as appropriate, must be displayed on the device.

The users' manual or instruction manual for an intentional or unintentional radiator shall caution the user that changes or modifications not expressly approved by the party responsible for compliance could void the user's authority to operate the equipment.



7. Certification Information

The following is extracted from Title 47 of the Code of Federal regulations, Part 2, Subpart I – Marketing of Radio Frequency Devices.

§ 2.801 Radio Frequency Device Defined

As used in this part, a radio frequency device is any device that in its operation is capable of emitting radio frequency by radiation, conduction or other means. Radio frequency devices include, but are not limited to:

- (a) The various types of radio communication transmitting devices described throughout this chapter.
- (b) The incidental, unintentional and intentional radiators defined in Part 15 of this chapter.
- (c) The industrial, scientific and medical equipment described in part 18 of this chapter.
- (d) Any part or component thereof that in use emits radio frequency energy by radiation, conduction or other means.

§ 2.803 Marketing of Radio Frequency Devices Prior to Equipment Authorization

- (a) Except as provided elsewhere in this chapter no person shall sell or lease, or offer for sale or lease (including advertising for sale or lease), or import, ship or distribute for the purpose of selling or leasing or offering for sale or lease, any radio frequency device unless:
 - (1) In the case of a device subject to certification, such device has been authorized by the Commission in accordance with the rules in this chapter and is properly identified and labeled as required by §2.925 and other relevant sections in this chapter; or
 - (2) In the case of a device that is not required to have grant of equipment authorization issued by the Commission, but which must comply with the specified technical standards prior to use, such device also complies with all applicable administrative (including verification of the equipment or authorization under a Declaration of Conformity, where required), technical, labeling and identification requirements specified in this chapter.

(e) Notwithstanding the provisions of paragraph (a) of this section, the offer for sale solely to business, commercial, industrial, scientific or medical users (but not an offer for sale to other parties or to end users located in a residential environment) of a radio frequency device that is in the conceptual, developmental, design or pre-production stage is permitted prior to equipment authorization or, for devices not subject to the equipment authorization requirements, prior to a determination of compliance with the applicable technical requirements provided that the prospective buyer is advised in writing at the time of the offer for sale that the equipment is subject to FCC rules and that the equipment will comply with the appropriate rules before delivery to the buyer or to centers of distribution.

(e)(1) Notwithstanding the provisions of paragraph (a) of this section, prior to equipment authorization or determination of compliance with the applicable technical requirements any radio frequency device may be operated, but not marketed, for the following purposes and under the following conditions:

(i) Compliance testing;

(ii) Demonstrations at a trade show provide the notice contained in paragraph (c) of this section is displayed in a conspicuous location on, or immediately adjacent to, the device;

(iii) Demonstrations at an exhibition conducted at a business, commercial, industrial, scientific or medical location, but excluding locations in a residential environment, provided the notice contained in paragraphs (c) or (d) of this section, as appropriate, is displayed in a conspicuous location on, or immediately adjacent to, the device;

(iv) Evaluation of the product performance and determination of customer acceptability, provided such operation takes place at the manufacturer's facilities during developmental, design or pre-production states; or

(v) Evaluation of product performance and determination of customer acceptability where customer acceptability of a radio frequency device cannot be determined at the manufacturer's facilities because of size, unique capability of the device, provided the device is operated at a business, commercial, industrial, scientific or medical user's site, but not at a residential site, during the development, design or pre-production stages.

(e)(2) For the purpose of paragraphs (e)(1)(iv) and (e)(1)(v) of this section, the term manufacturer's facilities includes the

facilities of the party responsible for compliance with the regulations and the manufacturer's premises, as well as the facilities of other entities working under the authorization of the responsible party in connection with the development and manufacture, but not the marketing, of the equipment.

- (f) For radio frequency devices subject to verification and sold solely to business, commercial, industrial, scientific and medical users (excluding products sold to other parties or for operation in residential environment), parties responsible for verification of the devices shall have the option of ensuring compliance with the applicable technical specifications of this chapter at each end user's location after installation, provided that the purchase or lease agreement includes a proviso that such a determination of compliance be made and is the responsibility of the party responsible for verification of the equipment.

The following is extracted from Title 47 of the Code of Federal Regulations, Part 2, Subpart J – Equipment Authorization Procedures:

§ 2.901 Basis and Purpose

- (a) In order to carry out its responsibilities under the Communications Act and the various treaties and international regulations and in order to promote efficient use of the radio spectrum, the Commission has developed technical standards for radio frequency equipment and parts or components thereof. The technical standards applicable to individual types are found in that part of the rules governing the service wherein the equipment is to be operated. In addition to the technical standards provided, the rules governing the service may require that such equipment be verified by the manufacturer or importer be authorized under the Declaration of Conformity, or receive an equipment authorization from the Commission by one of the following procedures: certification or registration.
- (b) The following sections describe the verification procedure, the procedure for a Declaration of Conformity, or the procedures to be followed in obtaining certification from the Commission and the conditions attendant to such a grant, whichever is applicable.

§ 2.907 Certification

- (a) Certification is an equipment authorization issued by the Commission, based on representation and test data submitted by the applicant.
- (b) Certification attaches to all units subsequently marketed by the grantee which are identical (see Section 2.908) to the sample tested except for permissive changes or other variations authorized by the Commission pursuant to Section 2.1043.

§ 2.948 Description of Measurement Facilities

- (a) Each party making measurements of equipment that is subject to an equipment authorization under Part 15 or Part 18 of this chapter, regardless of whether the measurements are filed with the Commission or kept on file by the party responsible for compliance of equipment marketed within the US or its possessions, shall compile a description of the measurement facilities employed.
 - (1) If the measured equipment is subject to the verification procedure, the description of the measurement facilities shall be retained by the party responsible for verification of the equipment.
 - (i) If the equipment is verified through measurements performed by an independent laboratory, it is acceptable for the party responsible for verification of the equipment to rely upon the description of the measurement facilities retained by or placed on file with the Commission by that laboratory. In this situation, the party responsible for the verification of the equipment is not required to retain a duplicate copy of the description of the measurement facilities.
 - (ii) If the equipment is verified based on measurements performed at the installation site of the equipment, no specific site calibration data is required. It is acceptable to retain the description of the measurement facilities at the site that the measurements were performed.
 - (2) If the equipment is to be authorized by the Commission under the certification procedure, the description of the measurement facilities shall be filed with the Commission's Laboratory in Columbia, Maryland. The data describing the measurement facilities need only be filed once but must be updated as changes are made to

the measurement facilities or as otherwise described in this section. At least every three years, the organization responsible for filing the data with the Commission shall certify that the data on file is current.



TDK

(END OF DOCUMENT)

