

**TEST REPORT**

**Report Number: 3164295MPK-001**  
**Project Number: 3164295 & 3164837**  
**Report Date: October 01, 2008**

**Testing performed on the**  
**Advanced Control Pedal Master for the WHITESTAR Signature™ system NGP680702**  
**Model: Advanced Control Pedal Master**  
**FCC ID: VGESIGACPM**  
**IC : 7228A-SIGACPM**  
**to**

**FCC Part 15.247 and RSS-210 Annex 8**  
**For**

**Advanced Medical Optics**



A2LA Certificate Number: 1755-01

Test Performed by:  
Intertek  
1365 Adams Court  
Menlo Park, CA 94025

Test Authorized by:  
Advanced Medical Optics  
1700 E. Saint Andrew Place  
Santa Ana, CA 92705 USA

Prepared by:   
Krishna K Vemuri

**Date:** October 01, 2008

Reviewed by:   
David Chernomordik

**Date:** October 01, 2008

*This report is for the exclusive use of Intertek's Client and is provided pursuant to the agreement between Intertek and its Client. Intertek's responsibility and liability are limited to the terms and conditions of the agreement. Intertek assumes no liability to any party, other than to the Client in accordance with the agreement, for any loss, expense or damage occasioned by the use of this report. Only the Client is authorized to copy or distribute this report and then only in its entirety. Any use of the Intertek name or one of its marks for the sale or advertisement of the tested material, product or service must first be approved in writing by Intertek. The observations and test results in this report are relevant only to the sample tested. This report by itself does not imply that the material, product, or service is or has ever been under an Intertek certification program. This report must not be used to claim product endorsement by A2LA, NIST nor any other agency of the U.S. Government.*

**Report No. 3164295MPK-001**

**Equipment Under Test:** Advanced Control Pedal Master for the  
WHITESTAR Signature™ system NGP680702  
**Trade Name:** Advanced Medical Optics  
**Model No.:** Advanced Control Pedal Master  
**FCC ID:** VGESIGACPM  
**IC:** 7228A-SIGACPM

**Applicant:** Advanced Medical Optics  
**Contact:** Mr. Dung Ma  
**Address:** 1700 E. Saint Andrew Place  
Santa Ana, CA 92705  
**Country** USA

**Tel. Number:** 714-247-8579  
**Fax number:** 714-247-8678

**Applicable Regulation:** FCC Part 15, Subpart C

**Test Site Location:** ITS – Site 1  
1365 Adams Drive  
Menlo Park, CA 94025

**Date of Test:** August 20 to September 24, 2008

*We attest to the accuracy of this report:*



---

Krishna K Vemuri  
Test Engineer



---

David Chernomordik  
EMC Technical Manager

TABLE OF CONTENTS

**1.0 Introduction .....4**  
1.1 Summary of Tests .....4

**2.0 General Description.....5**  
2.1 Product Description .....5  
2.2 Related Submittal(s) Grants.....5  
2.3 Test Methodology.....6  
2.4 Test Facility .....6

**3.0 System Test Configuration .....7**  
3.1 Support Equipment.....7  
3.2 Block Diagram of Test Setup .....7  
3.3 Justification .....9  
3.4 Software Exercise Program .....9  
3.5 Mode of Operation During Test .....9  
3.6 Modifications Required for Compliance .....9

**4.0 Measurement Results .....10**  
4.1 Conducted Output Power at Antenna Terminals .....10  
4.2 Hopping Channel 20-dB Bandwidth .....17  
4.3 Carrier Frequency Separation .....24  
4.4 Number of Hopping Channels.....26  
4.5 Average Channel Occupancy Time .....28  
4.6 Out-of Band-Conducted Emissions .....31  
4.7 Out-of-Band Radiated Emissions (except emissions in restricted bands).....65  
4.8 Transmitter Radiated Emissions in Restricted Bands .....66  
4.9 Radiated Emissions from Digital Parts and Receiver .....75  
4.10 AC Line Conducted Emission .....78

**5.0 RF Exposure evaluation.....79**

**6.0 List of test equipment.....80**

**7.0 Document History.....81**

**8.0 Appendix A –Graphs for Duty cycle measurement.....82**

## 1.0 Introduction

The Equipment under Test (EUT) is a device with two Bluetooth transceivers operating in the 2.4GHz frequency band.

This report is designed to show compliance of the 2.4 GHz transceiver with FCC Part 15.247 and RSS-210 requirements.

### 1.1 Summary of Tests

TEST	REFERENCE FCC 17.247	REFERENCE RSS-210	RESULTS
Output power	15.247(b)	A8.4(2)	Complies
20-dB Bandwidth	15.247(a)(1)	A8.1(a)	Complies
Channel Separation	15.247(a)(1)	A8.1(b)	Complies
Number of Hopping Channels	15.247(a)(1)	A8.1(d)	Complies
Average Channel Occupancy Time	15.47(a)(1)	A8.1(d)	Complies
Out-of-band Antenna Conducted Emission	15.247(c)	A8.5	Complies
Out-of-Band Radiated Emission (except emissions in Restricted Bands)	15.247(c)	A8.5	Not Applicable. The device passed Out-of-band Antenna Conducted Emission
Radiated Emission in Restricted Bands	15.247(c), 15.205	2.2	Complies
RF exposure	15.247(i)	RSS-102	Complies
AC Conducted Emission	15.207	RSS-GEN	Not Applicable. The EUT does not have any direct connection to public power network. In normal use, EUT is installed inside the host unit and it is DC powered internally.
Radiated Emission from Digital Parts and receiver	15.109	ICES-003	Complies

## 2.0 General Description

### 2.1 Product Description

The WHITESTAR Signature Advanced Control Pedal system consists of the Advanced Control Pedal Master (EUT in this report) and Advanced Control Pedal Slave which reside in the WHITESTAR Signature™ system NGP680702. Each device: Master and Slave consists two Bluetooth radios (transceivers), operating simultaneously in the 2.4 GHz frequency band. Both transmitters report the data alternatively to the host. This radio subsystem is used to communicate the footpedal control signal to the WHITESTAR Signature™ system for use in cataract surgery.

#### Overview of the EUT (Master)

<b>Applicant</b>	Advanced Medical Optics 1700 E. Saint Andrew Place Santa Ana, CA 92705 USA
<b>Manufacturer name &amp; address</b>	Advanced Medical Optics 1700 E. Saint Andrew Place Santa Ana, CA 92705 USA
<b>Trade Name &amp; Part No.</b>	Advanced Control Pedal Master
<b>FCC Identifier</b>	VGESIGACPM
<b>IC</b>	7228A-SIGACPM
<b>Use of Product</b>	WhiteStar Signature Advanced Control Pedal
<b>Type of Transmission</b>	Spread Spectrum, Frequency Hopping
<b>Rated RF Output</b>	1 mW
<b>Frequency Range</b>	2402-2480 MHz
<b>Number of Channel(s)</b>	79
<b>Modulation Type</b>	GFSK
<b>Data Rate</b>	1 Mbps
<b>Antenna(s) type &amp; Gain</b>	On-board antenna, 1.8 dBi,

A pre-production version of the sample was received on August 20, 2008 in good condition. As declared by the Applicant, it is identical to production units.

Test start date: August 20, 2008

Test end date: September 24, 2008

### 2.2 Related Submittal(s) Grants

The FCC Part 15.247 Application for FHSS transmitter with the FCC ID: VGESIGACPS and IC: 7228A-SIGACPS.

### 2.3 Test Methodology

Radiated and AC Line conducted emissions measurements were performed according to the procedures in ANSI C63.4 (2003). Radiated tests were performed at an antenna to EUT distance of 3 meters, unless stated otherwise in the "**Data Sheet**" of this Application. All other measurements were made in accordance with the procedures described in DA 00-705.

### 2.4 Test Facility

Then radiated emission test site and conducted measurement facility used to collect the data is 10m semi-anechoic chamber located in Menlo Park, California. This test facility and site measurement data have been fully placed on file with the FCC.

### 3.0 System Test Configuration

#### 3.1 Support Equipment

Item #	Description	Model No.	Serial No.
1	LAMBDA power supply	Vega 650	2060530007
2	Laptop	Compaq Armada	ITS# 013112

#### 3.2 Block Diagram of Test Setup

##### Test Setup for RF Conducted measurements

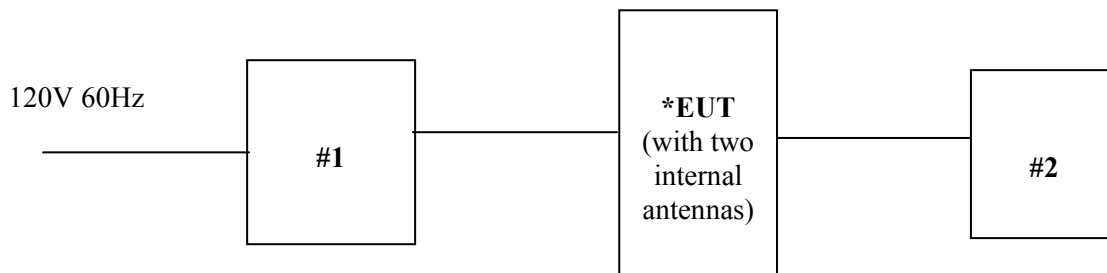

\* Client disconnect the antennas and installed cables for all antenna conducted measurements.

<b>S</b> = Shielded	<b>F</b> = With Ferrite
<b>U</b> = Unshielded	<b>m</b> = Length in Meters

**Test Setup for Radiated measurements**

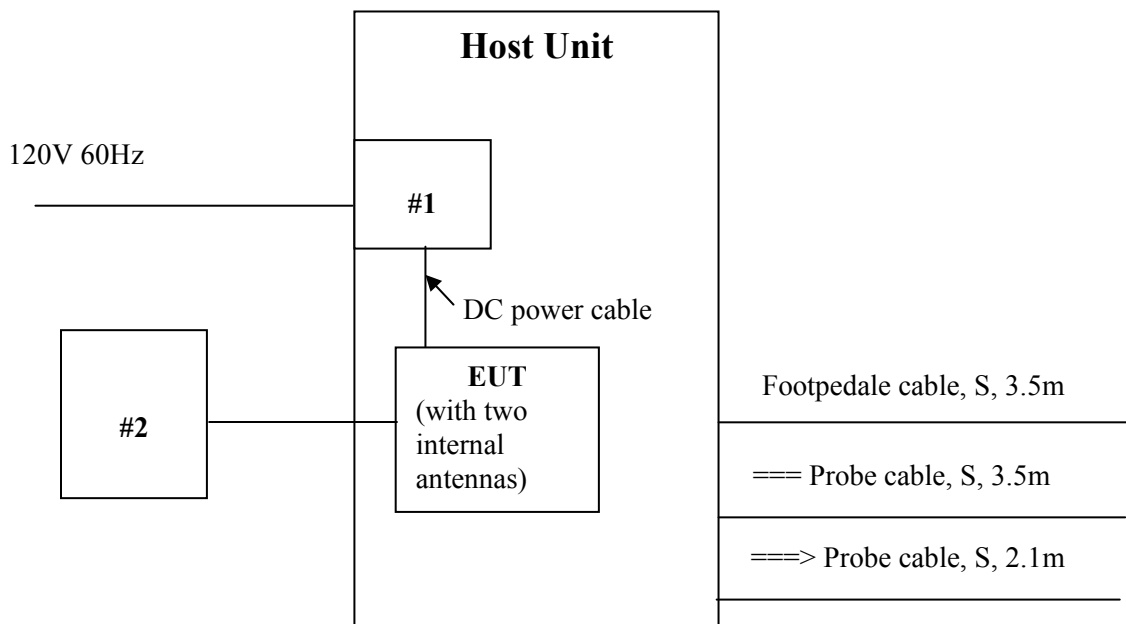

<b>S</b> = Shielded	<b>F</b> = With Ferrite
<b>U</b> = Unshielded	<b>m</b> = Length in Meters



### 3.3 Justification

For radiated emission measurements the EUT is placed on a non-conductive table. The EUT is attached to peripherals and they are connected and operational (as typical as possible). The EUT is wired to transmit full power. During testing, all cables are manipulated to produce worst-case emissions.

In normal operation, EUT is installed inside the host unit and it is DC powered internally. For testing the EUT was attached to a test board, connected to a laptop, which provides the power to the EUT and control the radio by the test software.

Since two transmitters are identical by design, all RF conducted tests were performed on one transmitter and limited tests (output power and spurious emissions) on the second transmitter. Radiated emission tests were performed when both transmitters are transmitting simultaneously.

### 3.4 Software Exercise Program

The EUT exercise program used during radiated and conducted testing was provided by the Applicant.

### 3.5 Mode of Operation During Test

The EUT was tested in two modes: hopping mode as in normal use and hopping disabled mode in which the EUT was transmitting at the lowest, middle, and highest channels (frequencies).

### 3.6 Modifications Required for Compliance

No modifications were installed by Intertek Testing Services during compliance testing in order to bring the product into compliance (Please note that this list does not include changes made specifically by Advanced Medical Optics prior to compliance testing).

#### 4.0 Measurement Results

##### 4.1 Conducted Output Power at Antenna Terminals FCC 15.247(b)(1)

###### Requirements

For systems operating in the 2400-2483.5 MHz band employing at least 75 hopping channels, the maximum peak output power is 1 watt (30 dBm), for all other systems 0.125 W (21 dBm).

###### Procedure

The antenna port of the EUT was connected to the input of a spectrum analyzer. Power was read directly and cable loss correction was added to the reading to obtain the power at the EUT antenna terminal.

###### Test Results

###### Transmitter 1 (Tx1)

Frequency (MHz)	Output in dBm	Output in mW	Plot number
2402	-0.58	0.875	1.1
2440	-1.13	0.771	1.2
2480	-1.90	0.646	1.3

###### Transmitter 2 (Tx2)

Frequency (MHz)	Output in dBm	Output in mW	Plot number
2402	-1.07	0.782	1.4
2440	-1.33	0.736	1.5
2480	-2.21	0.601	1.6

Notes: 1. Hopping function was disabled during the test.  
2. The EUT's antenna has less than 6 dBi gain.

Plot 1.1

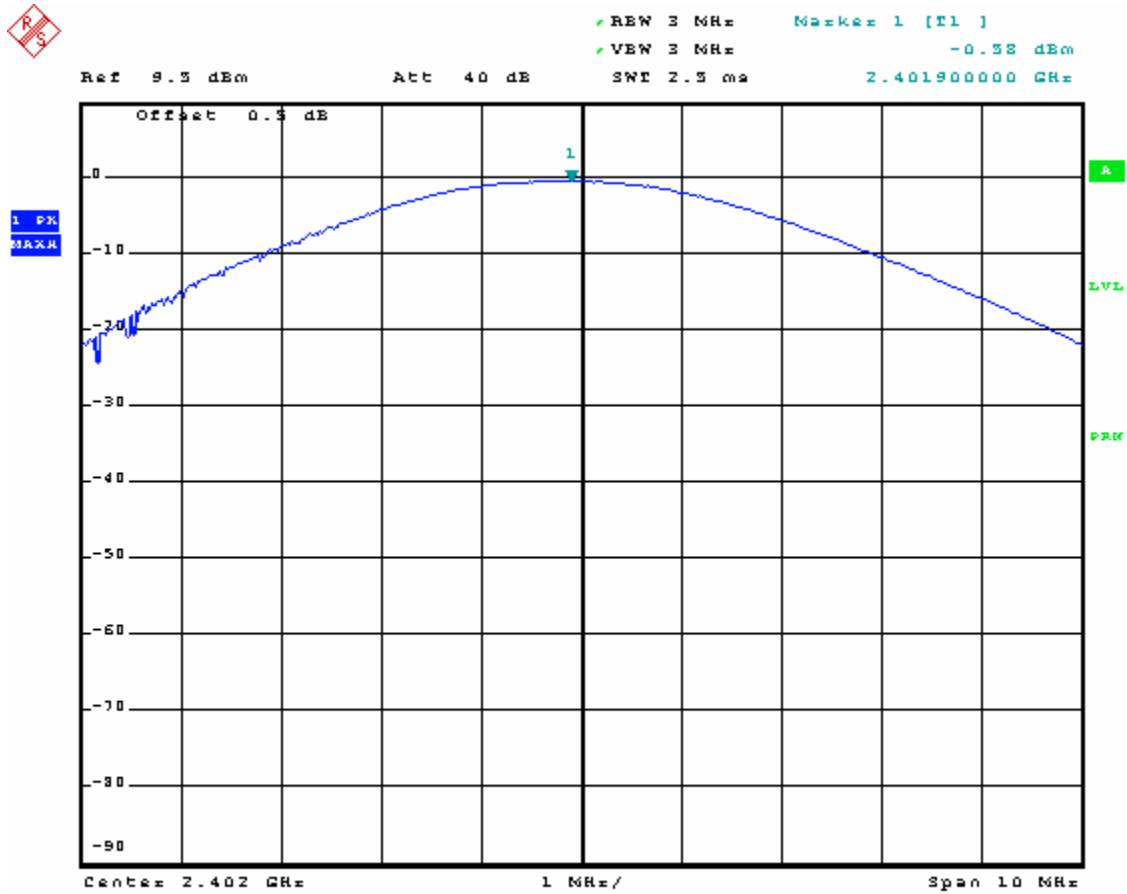

Comment: Output Power, Tx1  
 Date: 21.AUG.2008 16:08:52

Plot 1.2

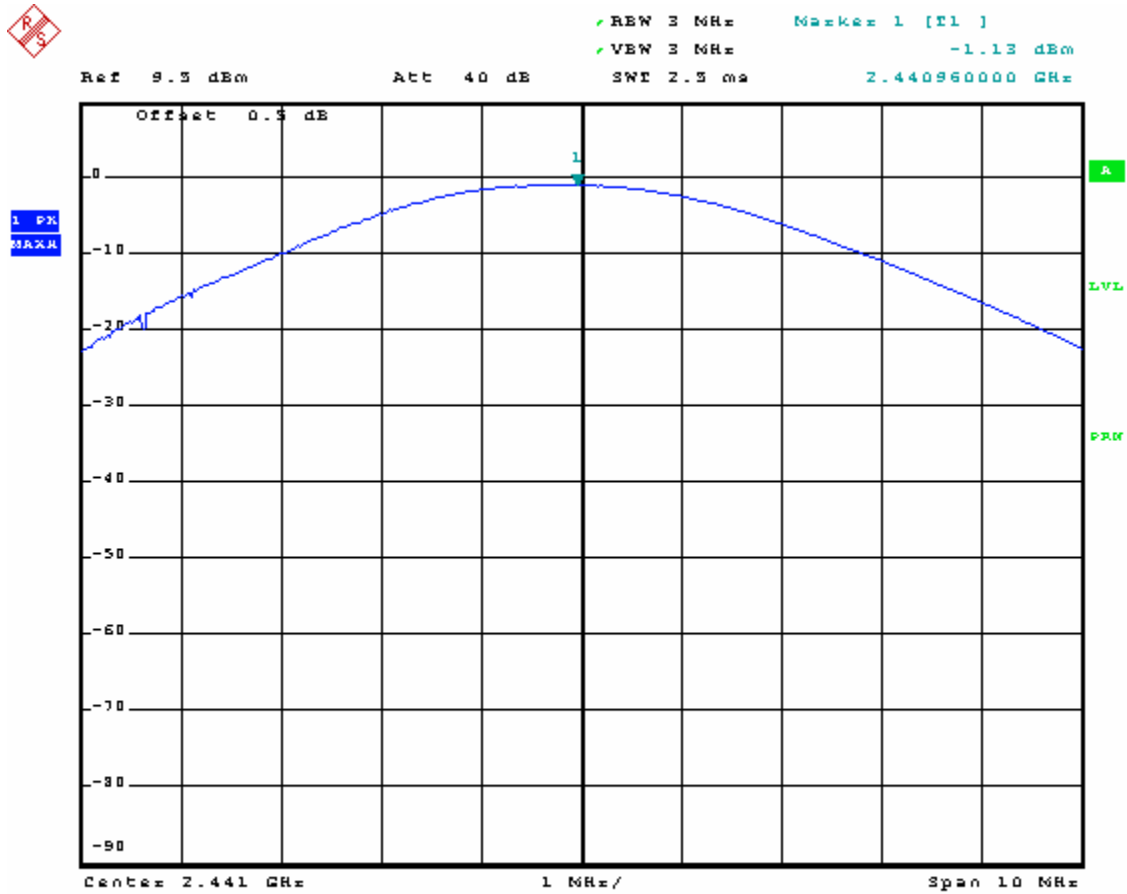

Comment: Output Power, Tx1  
 Date: 21.AUG.2008 16:10:40

Plot 1.3

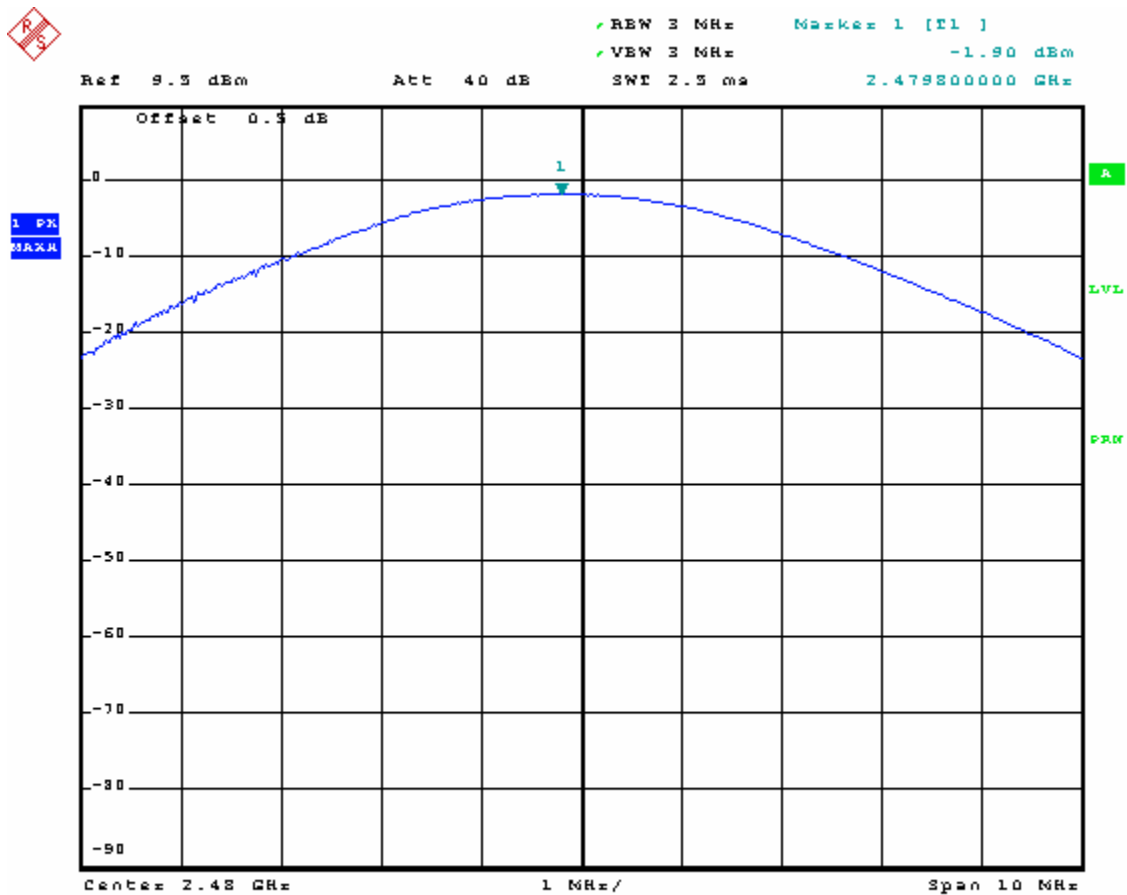

Comment: Output Power, Tx1  
Date: 21.AUG.2008 16:12:59

Plot 1.4

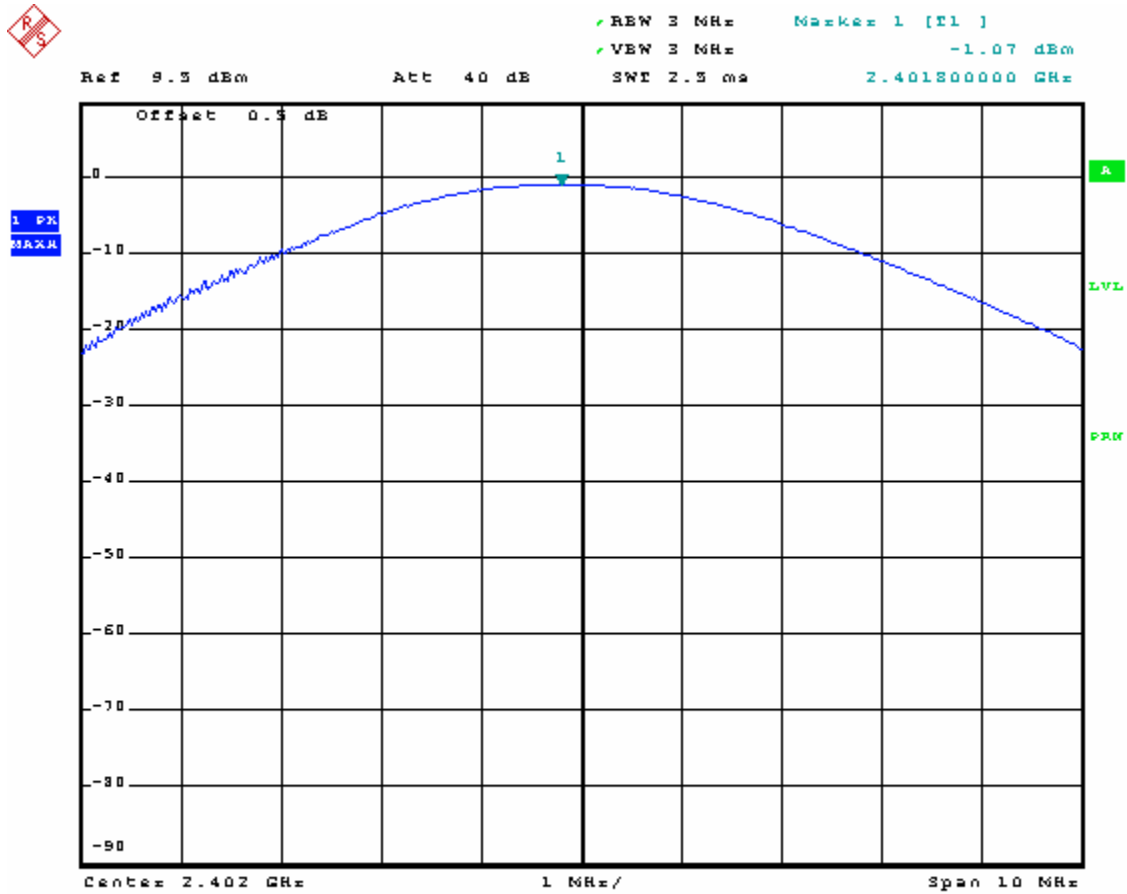

Comment: Output Power, Tx2  
Date: 21.AUG.2008 16:20:02

Plot 1.5

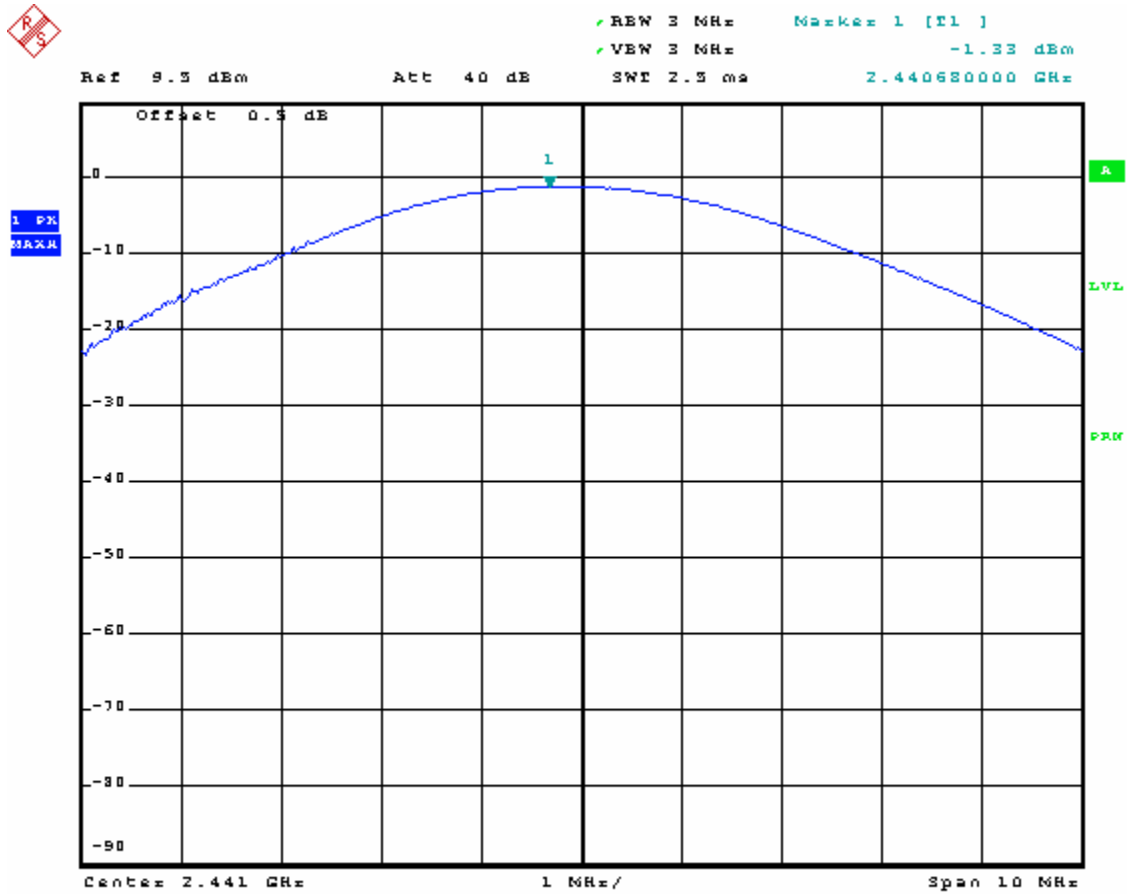

Comment: Output Power, Tx2  
 Date: 21.AUG.2008 16:22:02

Plot 1.6



\*RBW 3 MHz      Marker 1 [T1 ]  
 \*VBW 3 MHz                         -2.21 dBm  
 SWT 2.5 ms                         2.479800000 GHz

Ref 9.5 dBm                    Att 40 dB

1 PK  
MAXH

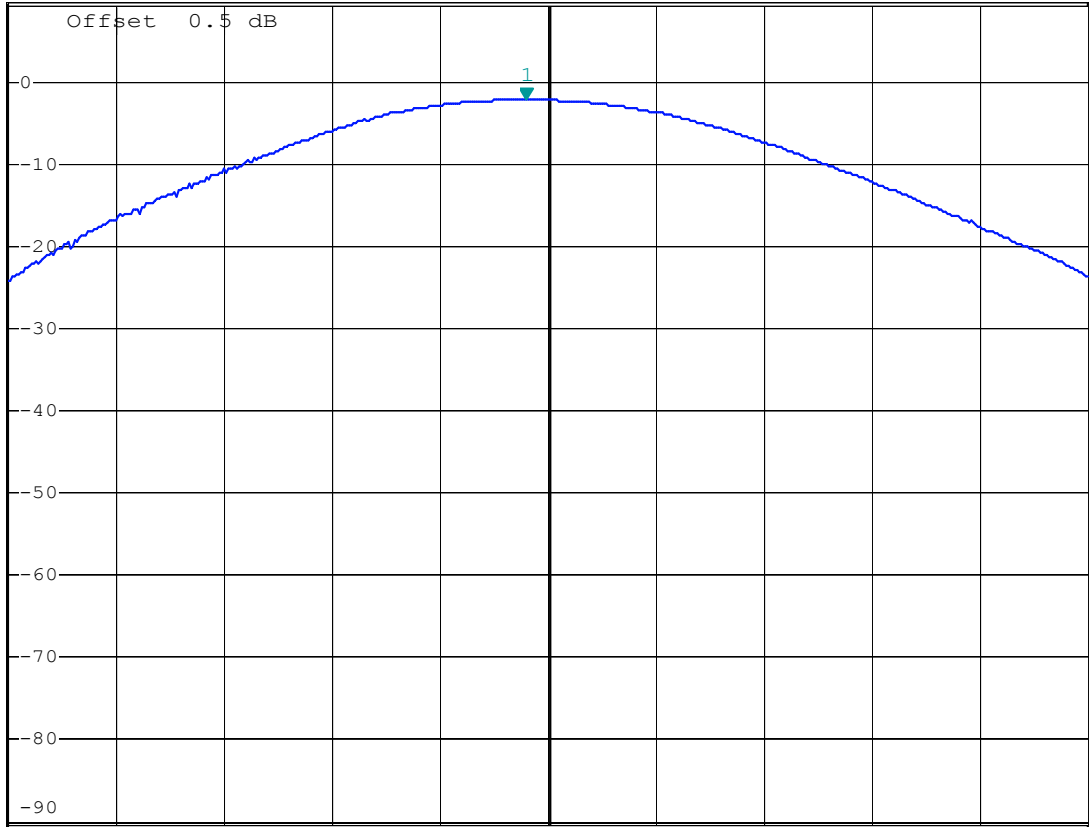

Center 2.48 GHz                    1 MHz/                    Span 10 MHz

Comment: Output Power, Tx2  
 Date:            21.AUG.2008 16:34:43



4.2 Hopping Channel 20-dB Bandwidth  
FCC 15.247(a)

Procedure

The antenna port of the EUT was connected to the input of a spectrum analyzer. The spectrum analyzer resolution bandwidth was set to approximately 1% of the 20-dB Bandwidth. The 20-dB Bandwidth was measured by using the DELTA MARKER function of the analyzer.

In addition, the occupied bandwidth (99%) was measured.

Test Results

Frequency (MHz)	20-dB channel bandwidth (MHz)	Plot
2402	1.020	2.1
2440	1.020	2.2
2480	1.020	2.3

Frequency (MHz)	Occupied bandwidth (MHz)	Plot
2402	0.980	2.4
2440	0.980	2.5
2480	0.980	2.6

Plot 2.1



Comment: 20-dB Bandwidth, Fx1  
 Date: 21.AUG.2008 19:51:59

Plot 2.2



1 PK  
VIEW

\*RBW 10 kHz    Marker 3 [T1 ]  
 \*VBW 100 kHz    -3.58 dBm  
 Ref 13 dBm    Att 50 dB    SWT 20 ms    2.440848000 GHz

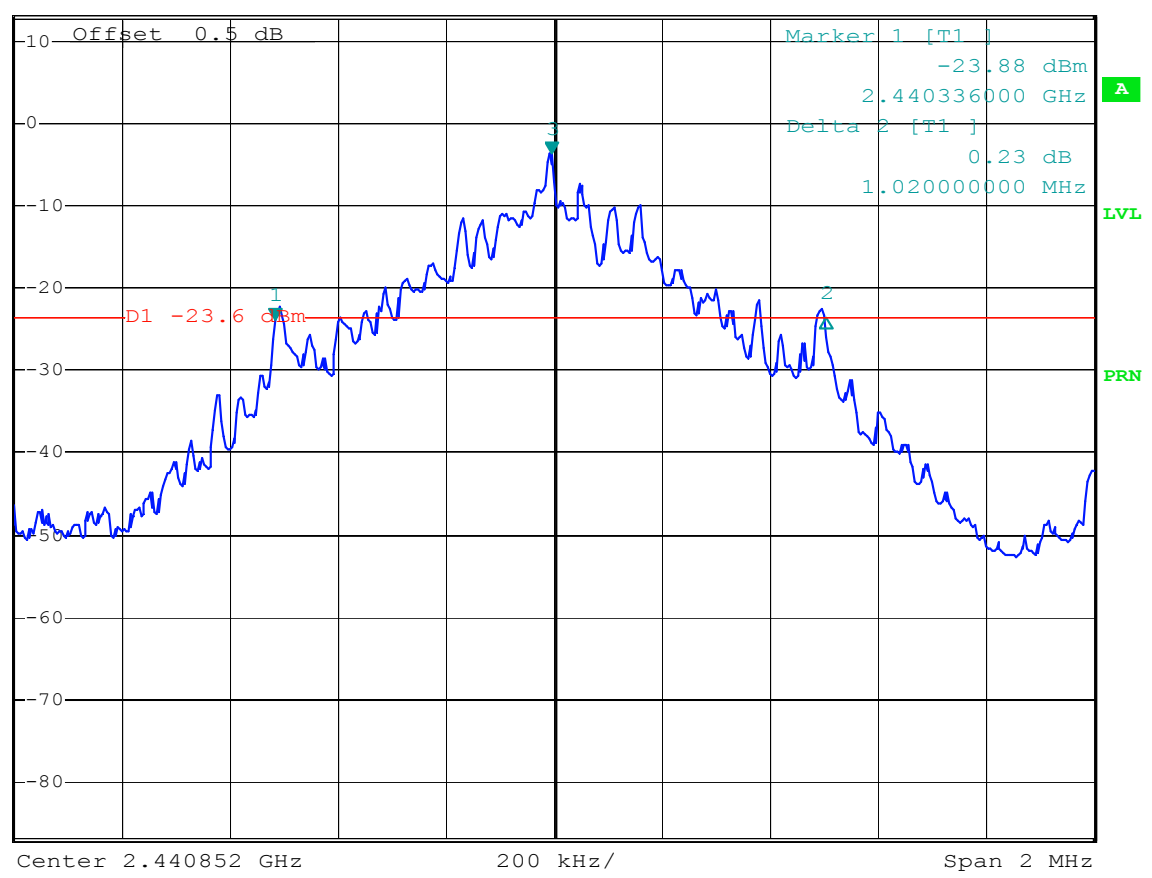

Comment: 20-dB Bandwidth, Tx1  
 Date: 21.AUG.2008 20:38:00

Plot 2.3

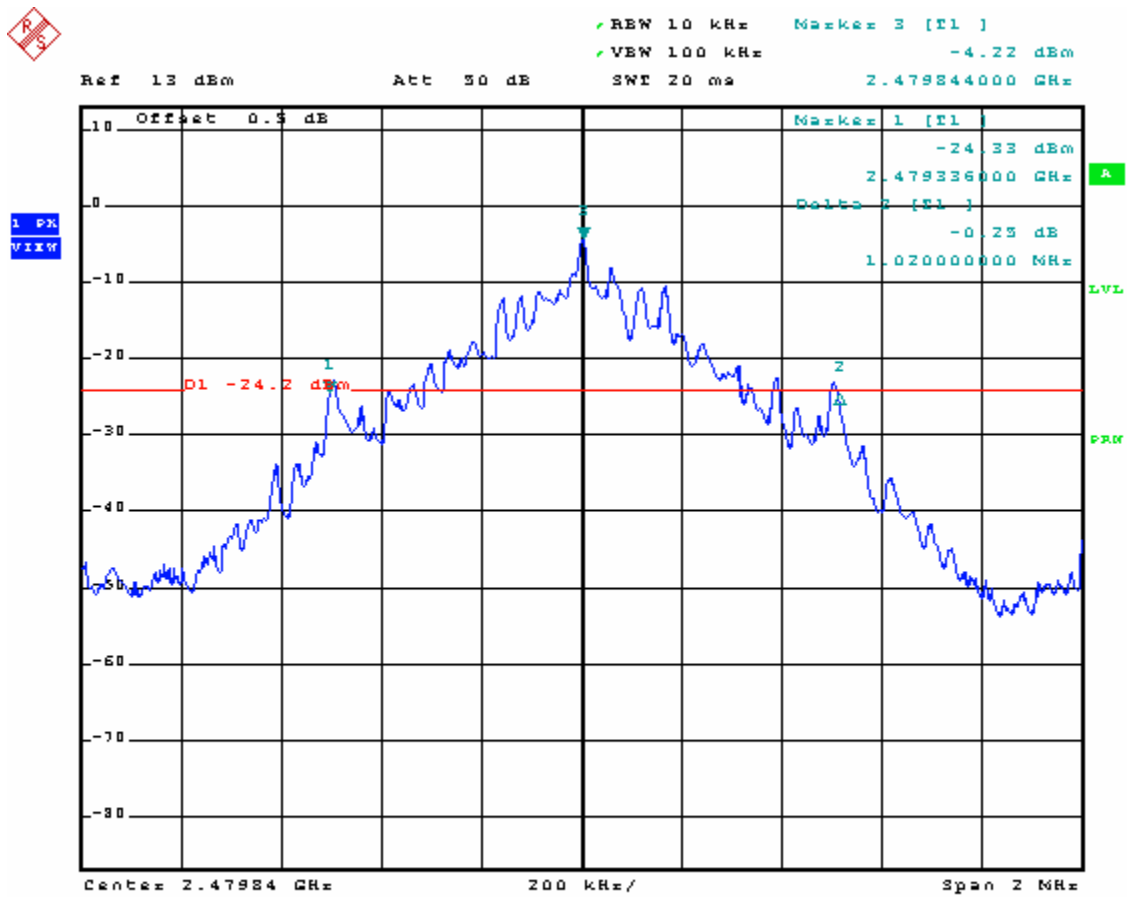

Plot 2.4

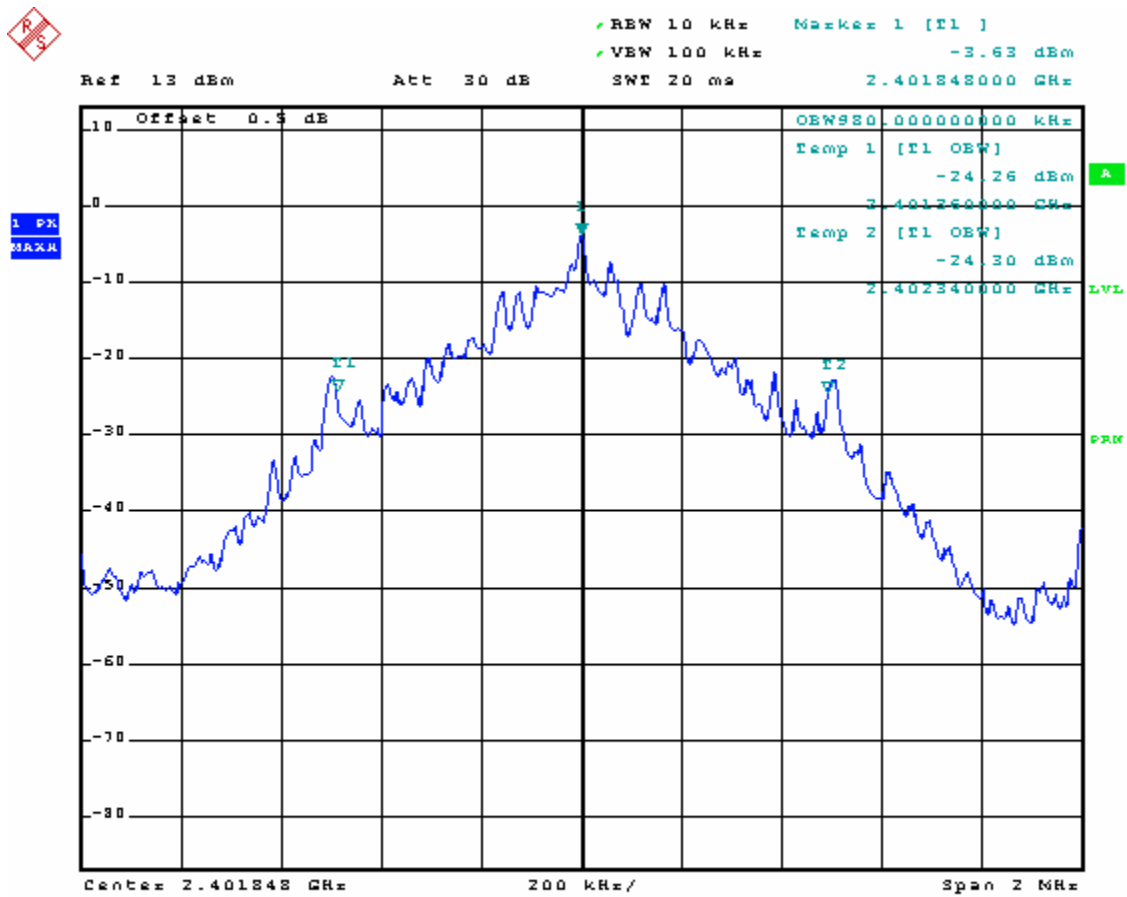

Comment: Occupied Bandwidth, Tx1  
 Date: 21.AUG.2008 21:02:44

Plot 2.5

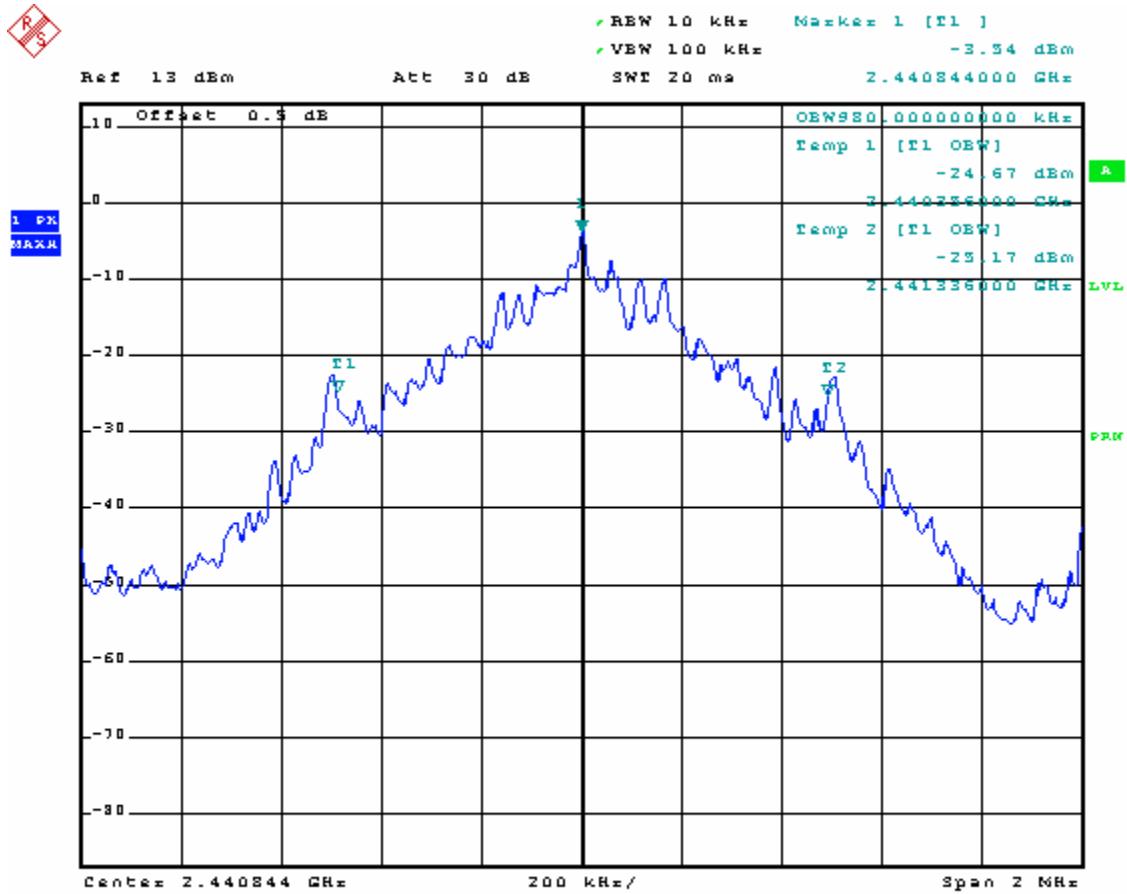

Comment: Occupied Bandwidth, Tx1  
 Date: 21.AUG.2008 21:04:37

Plot 2.6

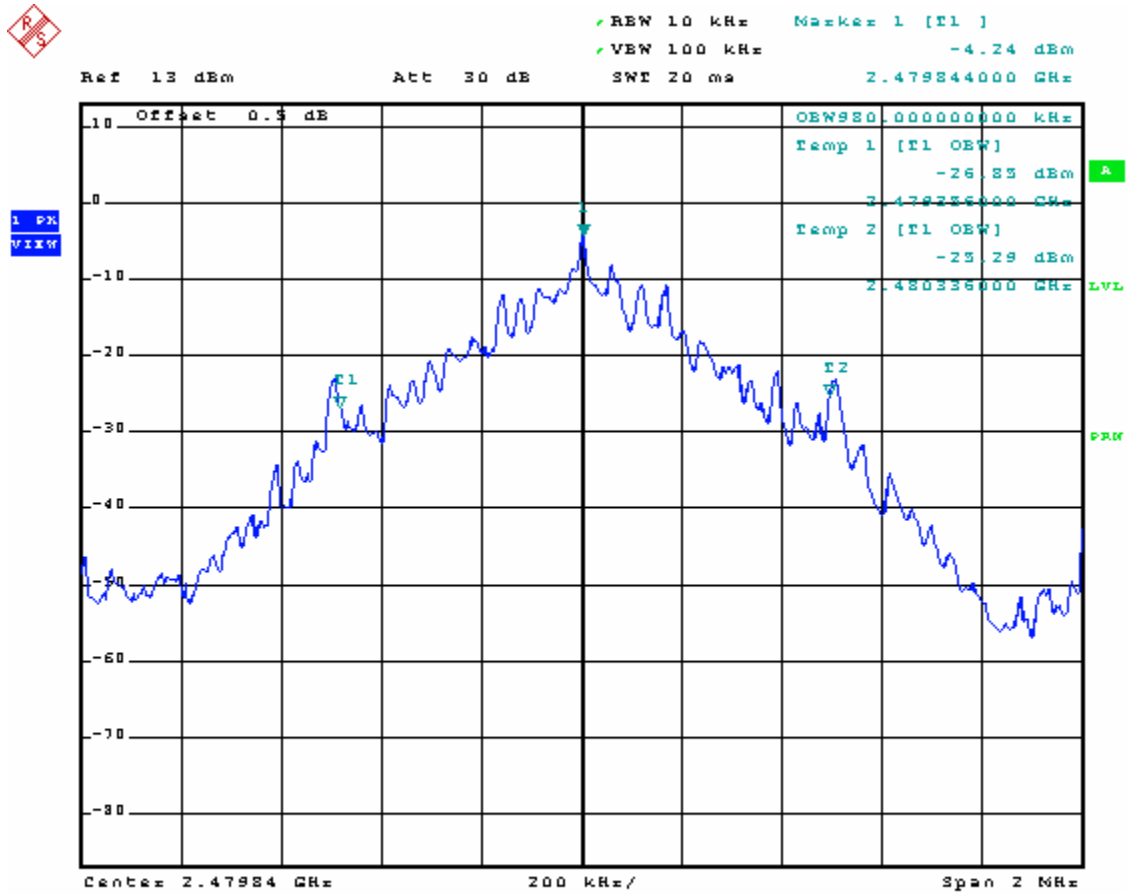

Comment: Occupied Bandwidth, Tx1  
 Date: 21.AUG.2008 20:59:37

4.3 Carrier Frequency Separation  
FCC Ref: 15.247(a)(1)

Requirement

Systems shall have hopping channel carrier frequencies that are separated by 25 kHz or two-thirds of the 20-dB bandwidth of the hopping channel, whichever is greater.

Procedure

Using the DELTA MARKER function of the analyzer, the frequency separation between two adjacent channels was measured and compared against the limit.

Test Results

Please refer to the attached spectrum analyzer plot # 3.1 for the test result.  
The channel separation is 1.008 MHz.



Plot 3.1

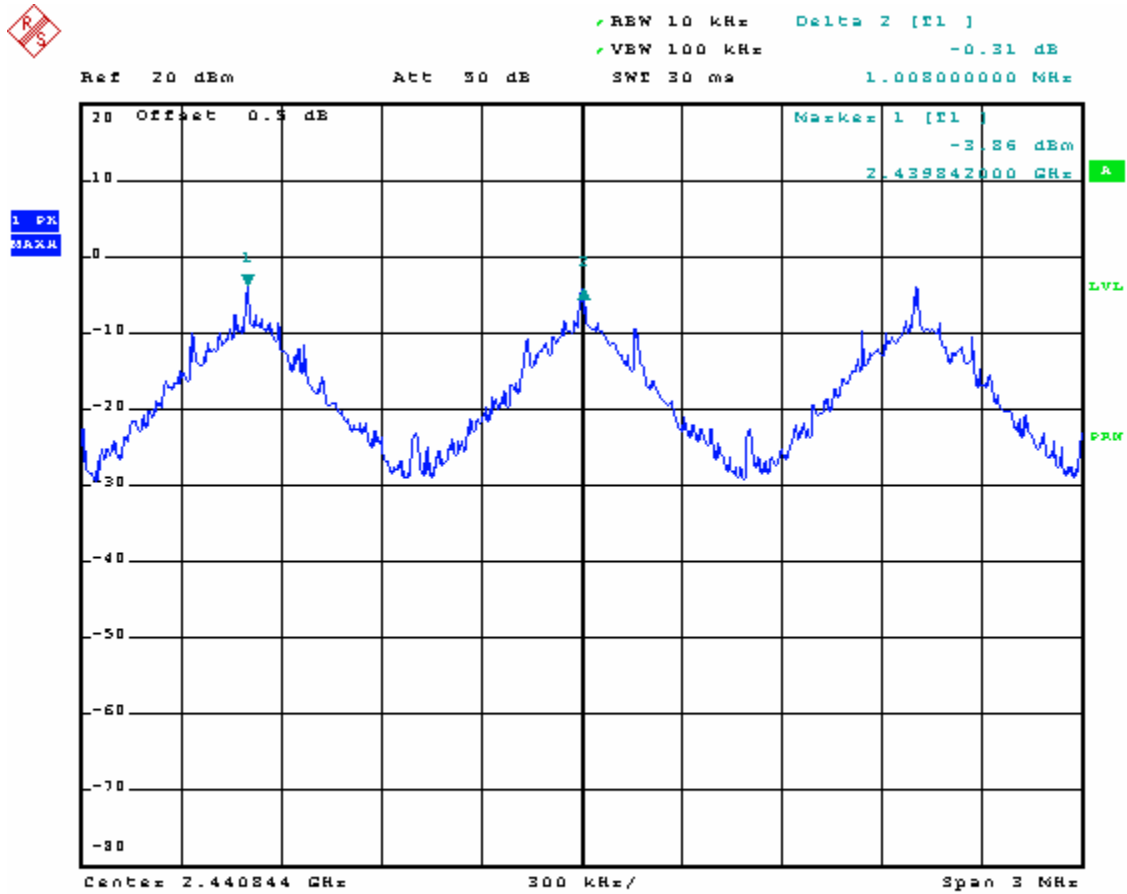

Comment: Carrier frequency separation, Tx1  
 Date: 21.AUG.2008 21:18:38

4.4 Number of Hopping Channels  
FCC Ref: 15.247(a)(1)(iii)

Requirement

Systems operating in the 2400-2483.5 MHz band shall use at least 15 hopping channels.

Procedure

With the analyzer set to MAX HOLD, readings were taken for 2 - 3 minutes The channel peaks so recorded and compared to the minimum number of channels required in the regulation.

Test Results

Number of hopping channels	79
----------------------------	----

Refer to attached spectrum analyzer charts: Plots 4.1

Plot 4.1

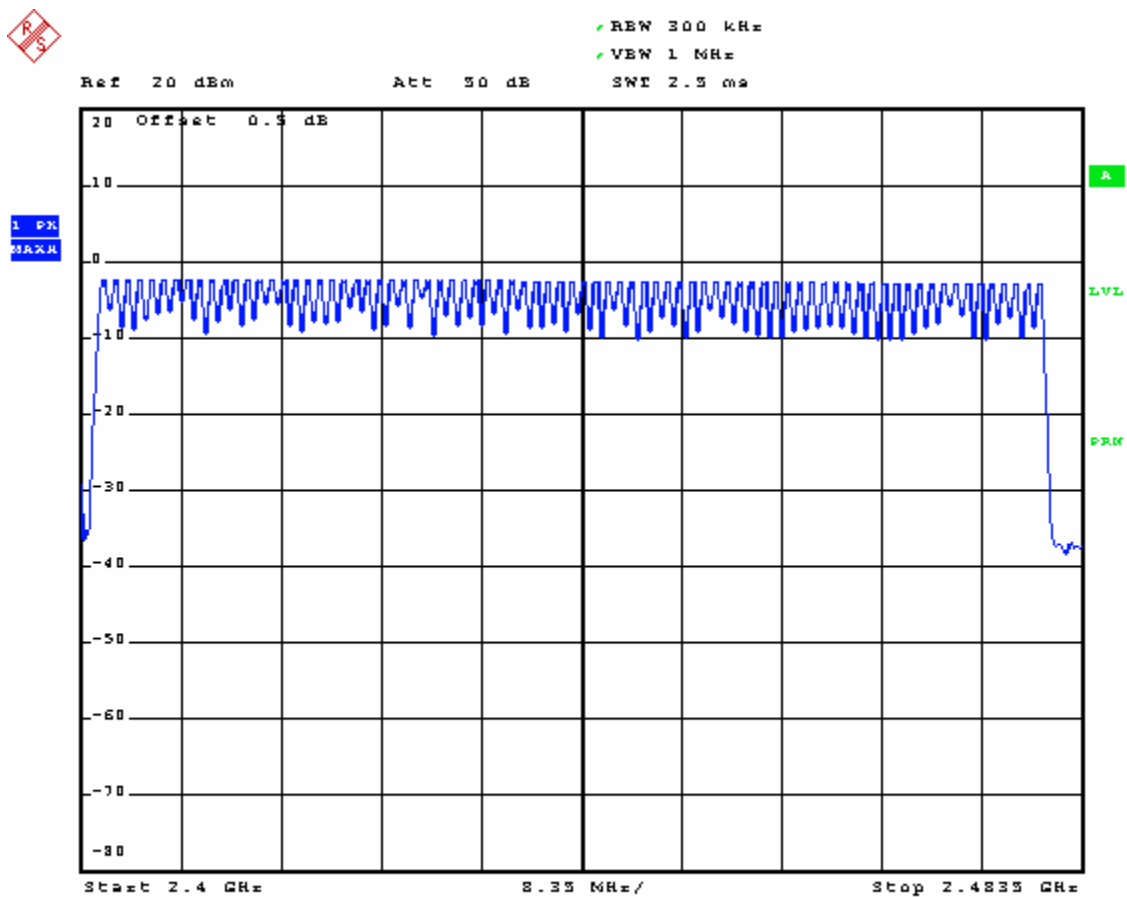

Comment: Number of hopping channels, 1x1  
Date: 21.AUG.2008 21:23:14

4.5 Average Channel Occupancy Time  
FCC 15.247(a)(1)(ii)(iii)

Requirement

For systems operating in the 2400-2483.5 MHz band, the average time of occupancy on any channel shall not be greater than 0.4 second within a period of 0.4 second multiplied by the number of hopping channels employed.

Procedure

The spectrum analyzer center frequency was set to one of the known hopping channels, the SPAN was set to ZERO SPANS, and the TRIGGER was set to VIDEO. The time duration of the transmission so captured was measured with the MARKER DELTA function.

Since the radio is employed 79 hopping channels, the Occupancy Time was calculated for the period of  $0.4 * 79 = 31.6$  sec.

Test Results

Occupancy Time (see plots 5.1 and 5.2)

$0.00288 * 13 * 10 = 0.3744$  sec.

Refer to attached spectrum analyzer plots 5.1-5.2 for details.

Plot 5.1

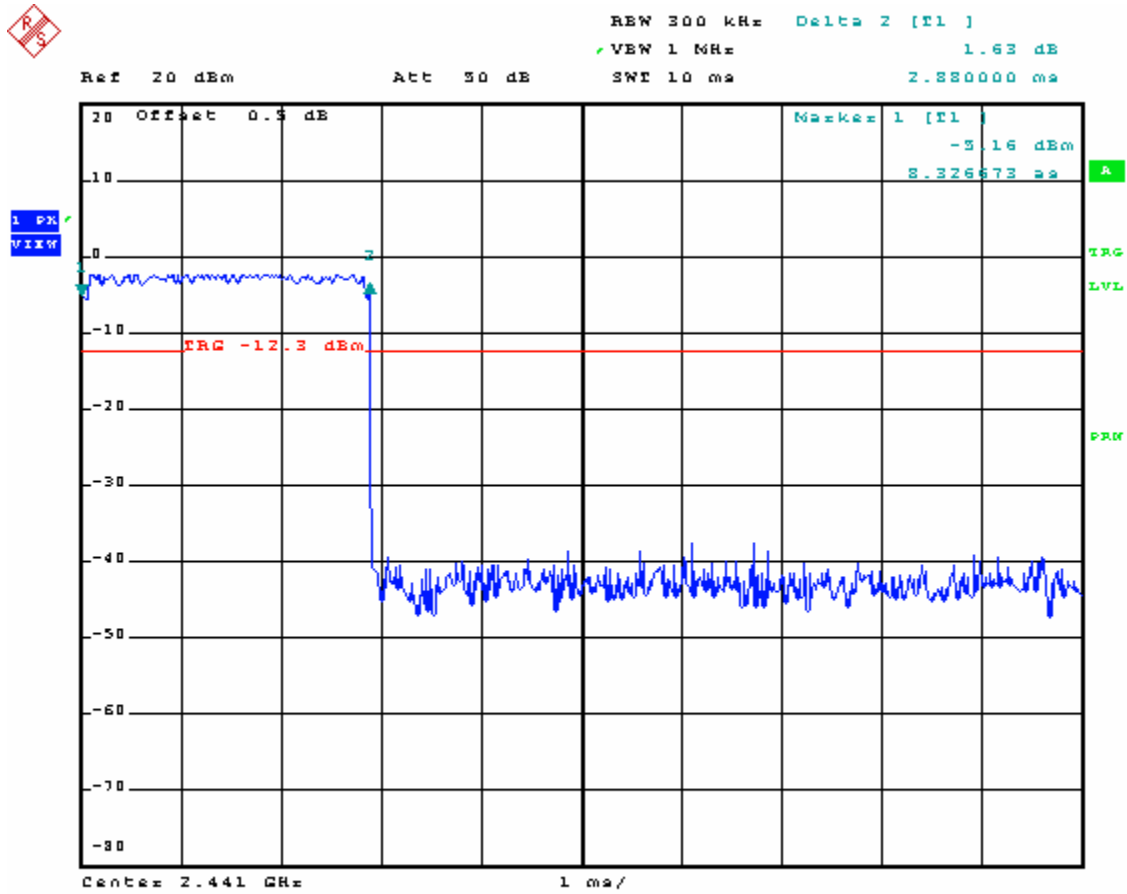

Comment: Dwell time, Ex1  
 Date: 21.AUG.2008 21:34:55

Plot 5.2

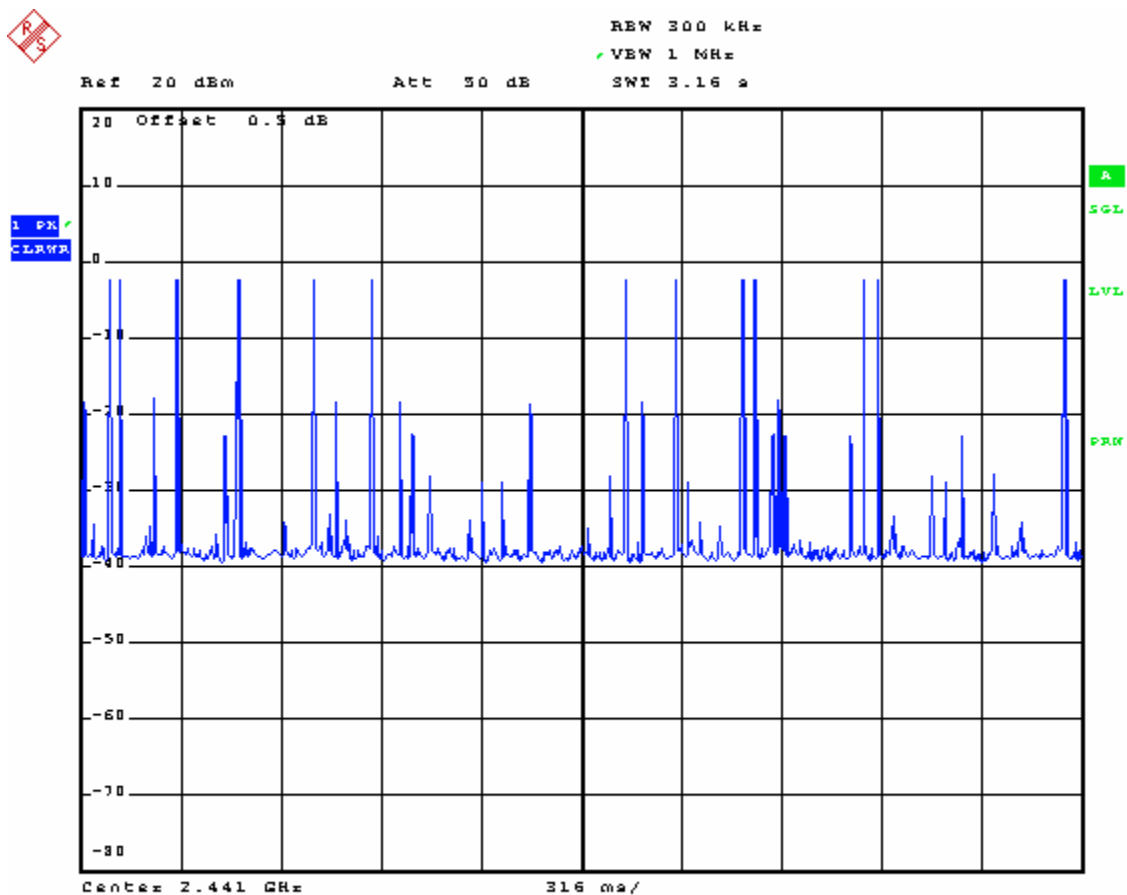

Comment: Dwell time, Ex1  
Date: 21.AUG.2008 21:40:07

4.6 Out-of Band-Conducted Emissions  
FCC 15.247(c)

Requirement

In any 100 kHz bandwidth outside the EUT pass-band, the RF power shall be at least 20 dB below that of the maximum in-band 100 kHz emission.

Procedure

A spectrum analyzer was connected to the antenna port of the transmitter. Analyzer Resolution Bandwidth was set to 100 kHz. For each channel investigated, the in-band and out-of-band emission measurements were performed. The out-of-band emissions were measured from 30 MHz to 25 GHz.

Test Result

Refer to the following plots for the test result:

Transmitter 1 (Tx1)

Description	Comments	Plot number
In-band Emissions, F=2402 MHz		6.1
In-band Emissions, F=2441 MHz		6.5
In-band Emissions, F=2480 MHz		6.9
Emissions on the low band-edge frequency	Fixed channel, 2402 MHz	6.13
Emissions on the low band-edge frequency	Hopping mode	6.14
Emissions on the high band-edge frequency	Fixed channel, 2480 MHz	6.15
Emissions on the high band-edge frequency	Hopping mode	6.16
Out-of-band low Channel Emissions	Fixed channel, 2402 MHz	6.2 – 6.4
Out-of-band middle Channel Emissions	Fixed channel, 2441 MHz	6.6 – 6.8
Out-of-band high Channel Emissions	Fixed channel, 2480 MHz	6.10 – 6.12

The attenuation is more than 20 dB.

Transmitter 1 (Tx2)

Description	Comments	Plot number
In-band Emissions, F=2402 MHz		6.17
In-band Emissions, F=2441 MHz		6.21
In-band Emissions, F=2480 MHz		6.25
Emissions on the low band-edge frequency	Fixed channel, 2402 MHz	6.29
Emissions on the low band-edge frequency	Hopping mode	6.30
Emissions on the high band-edge frequency	Fixed channel, 2480 MHz	6.31
Emissions on the high band-edge frequency	Hopping mode	6.32
Out-of-band low Channel Emissions	Fixed channel, 2402 MHz	6.18 – 6.20
Out-of-band middle Channel Emissions	Fixed channel, 2441 MHz	6.22 – 6.24
Out-of-band high Channel Emissions	Fixed channel, 2480 MHz	6.26 – 6.28

The attenuation is more than 20 dB.



Plot 6.1

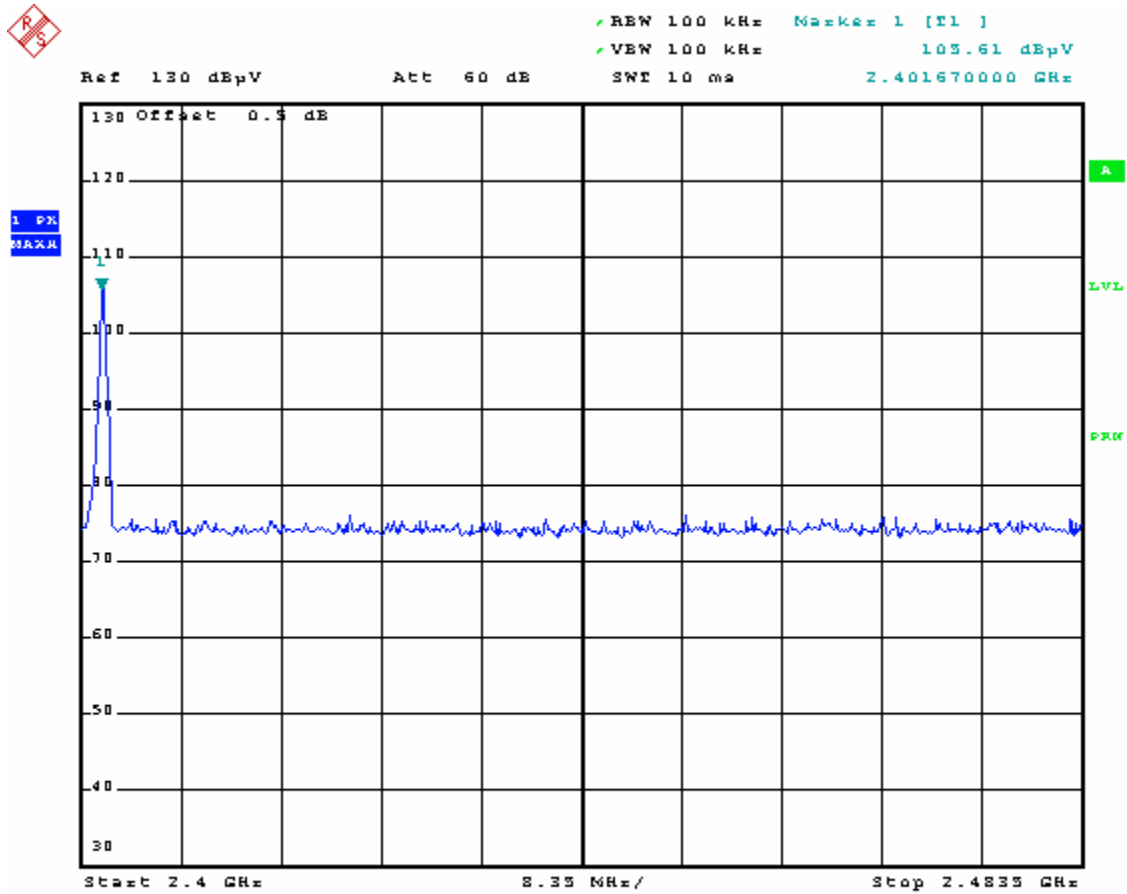

Comment: In-band emissions, Freq 2402MHz, Tx1  
Date: 21.AUG.2008 16:53:03

Plot 6.2

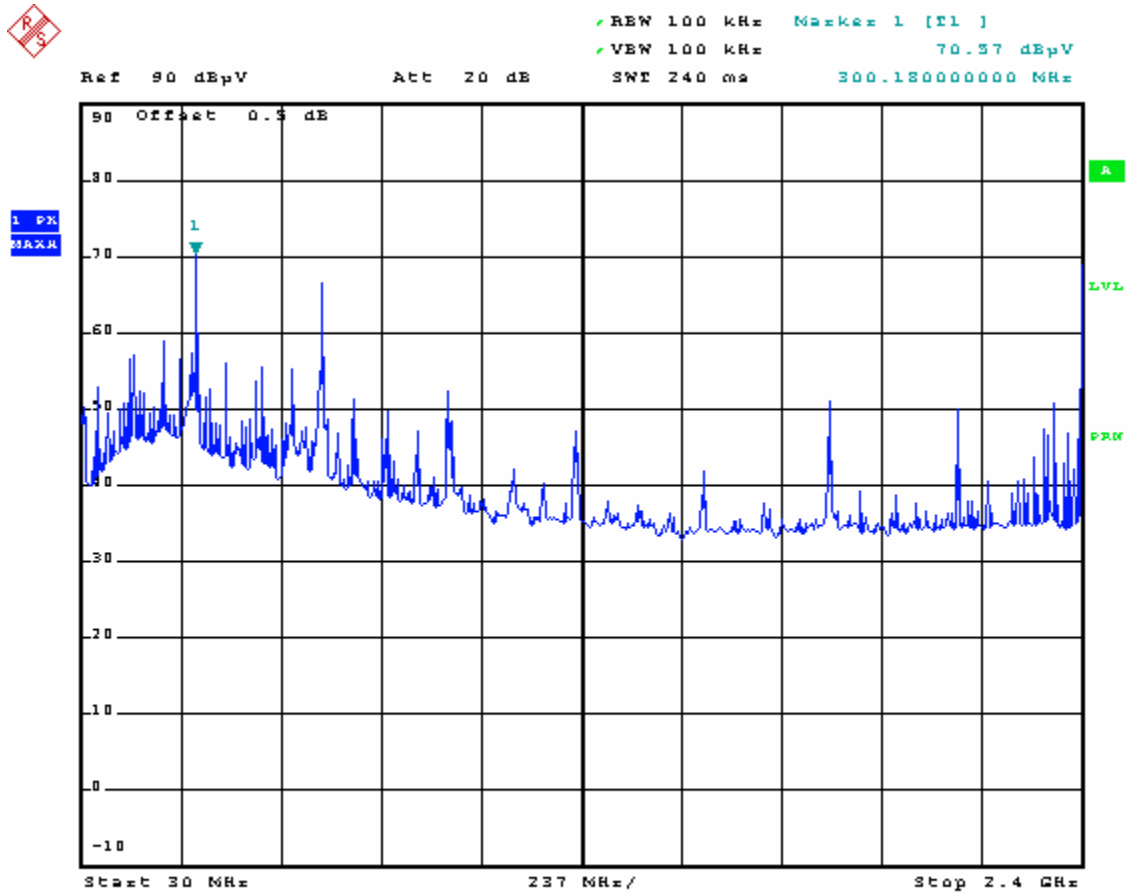

Comment: Spurious emissions, Freq 2402MHz, Ex1  
 Date: 21.AUG.2008 16:56:46

Plot 6.3

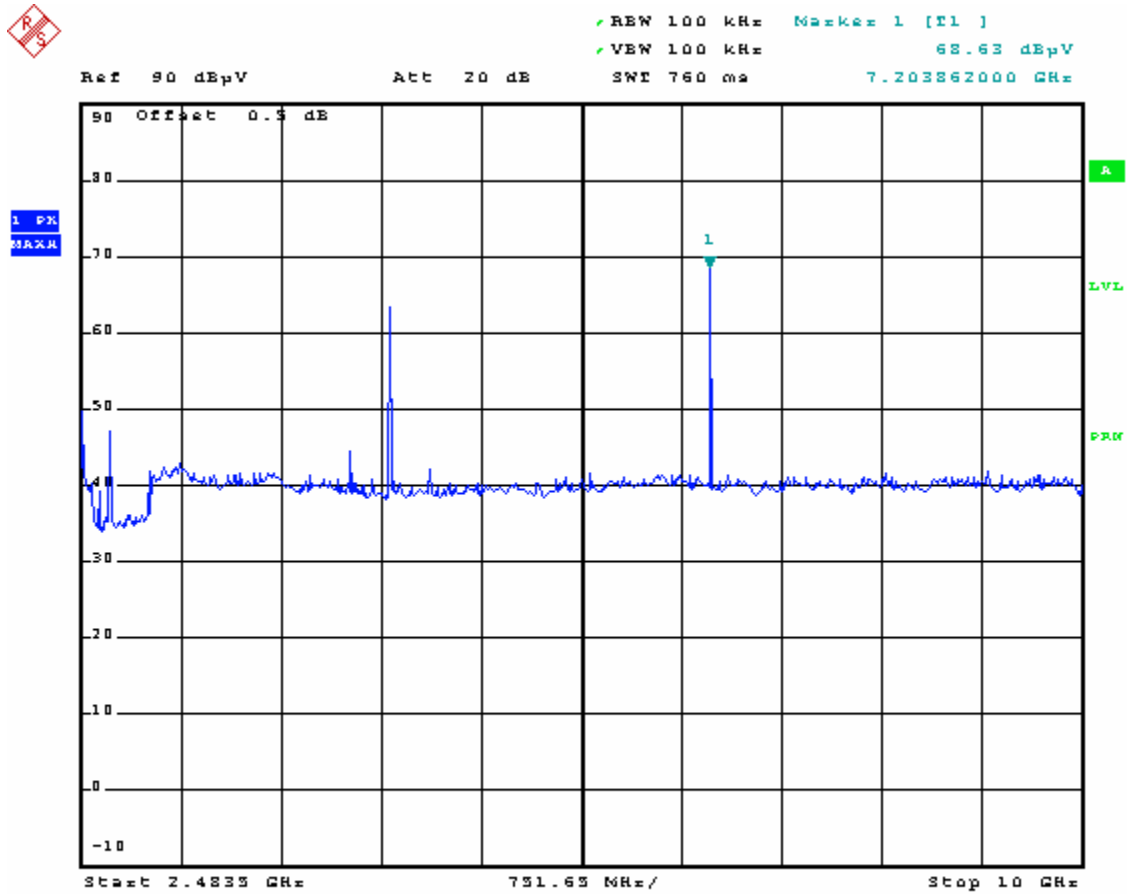

Comment: Spurious emissions, Freq 2402MHz, Ex1  
Date: 21.AUG.2008 16:58:14

Plot 6.4

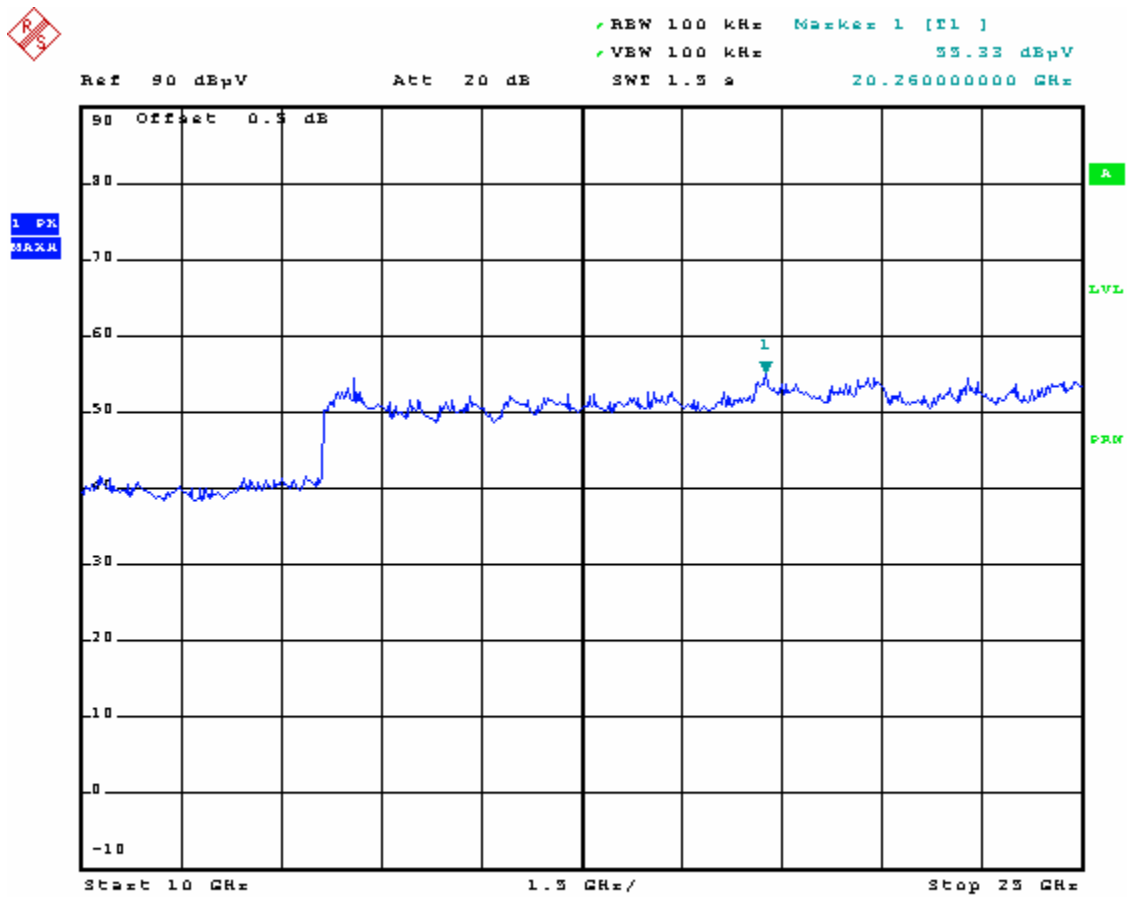

Comment: Spurious emissions, Freq 2402MHz, Ex1  
 Date: 21.AUG.2008 16:59:44

Plot 6.5

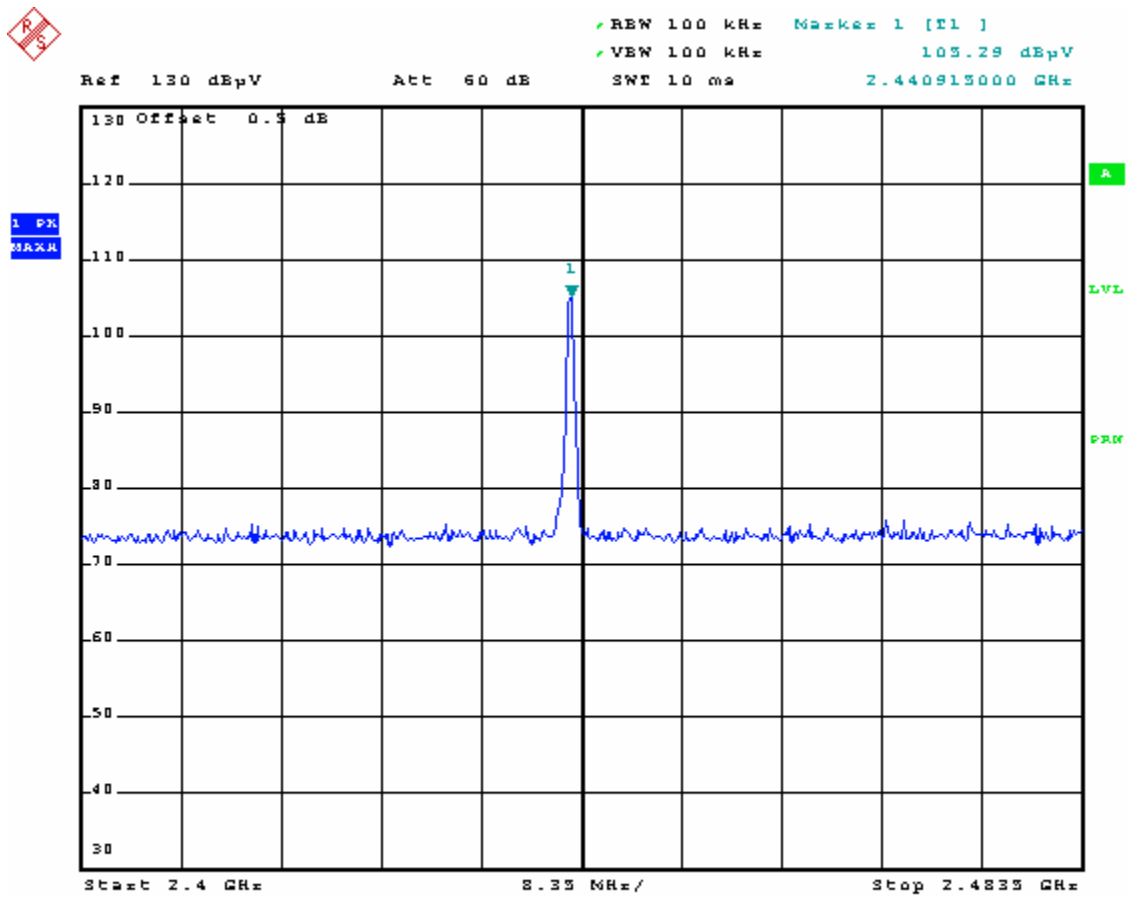

Comment: In-band emissions, Freq 2441MHz, Tx1  
 Date: 21.AUG.2008 17:03:37

Plot 6.6

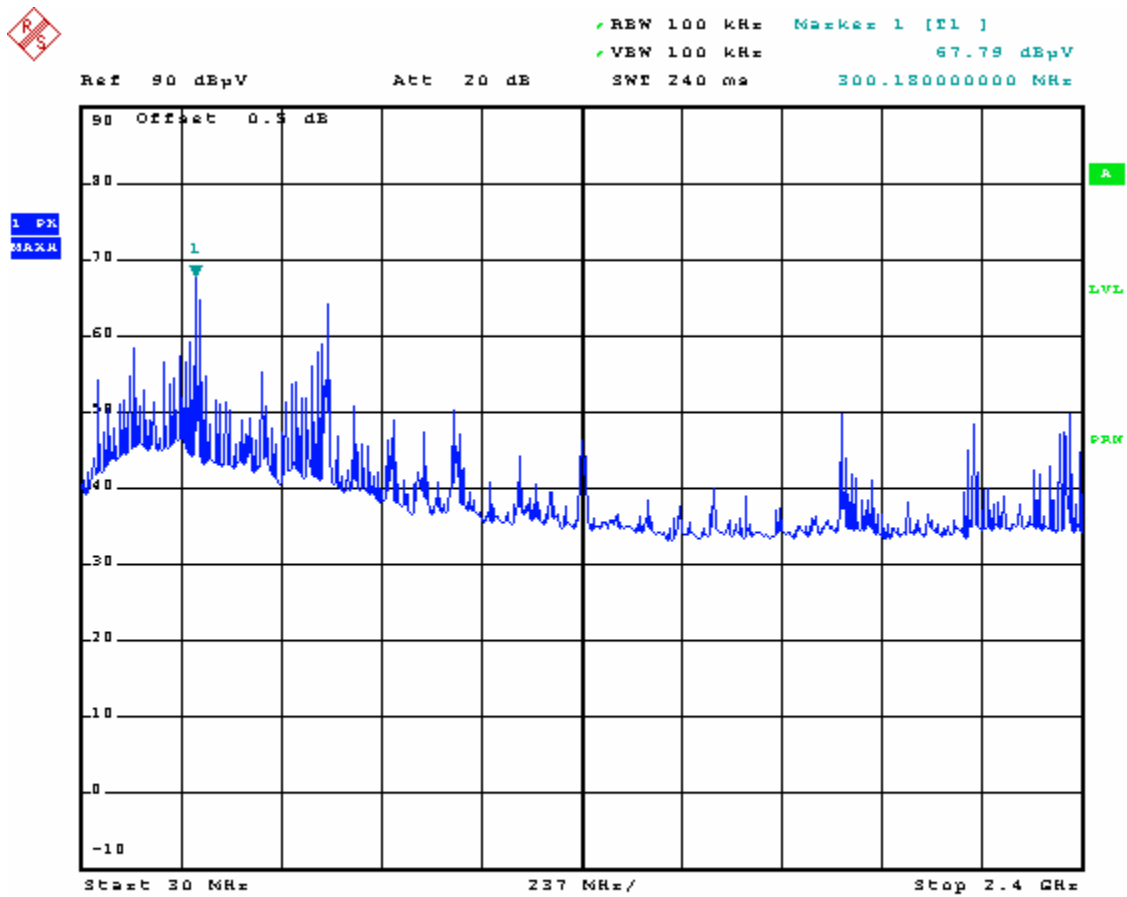

Comment: Spurious emissions, Freq 2441MHz, Ex1  
 Date: 21.AUG.2008 17:08:13

Plot 6.7

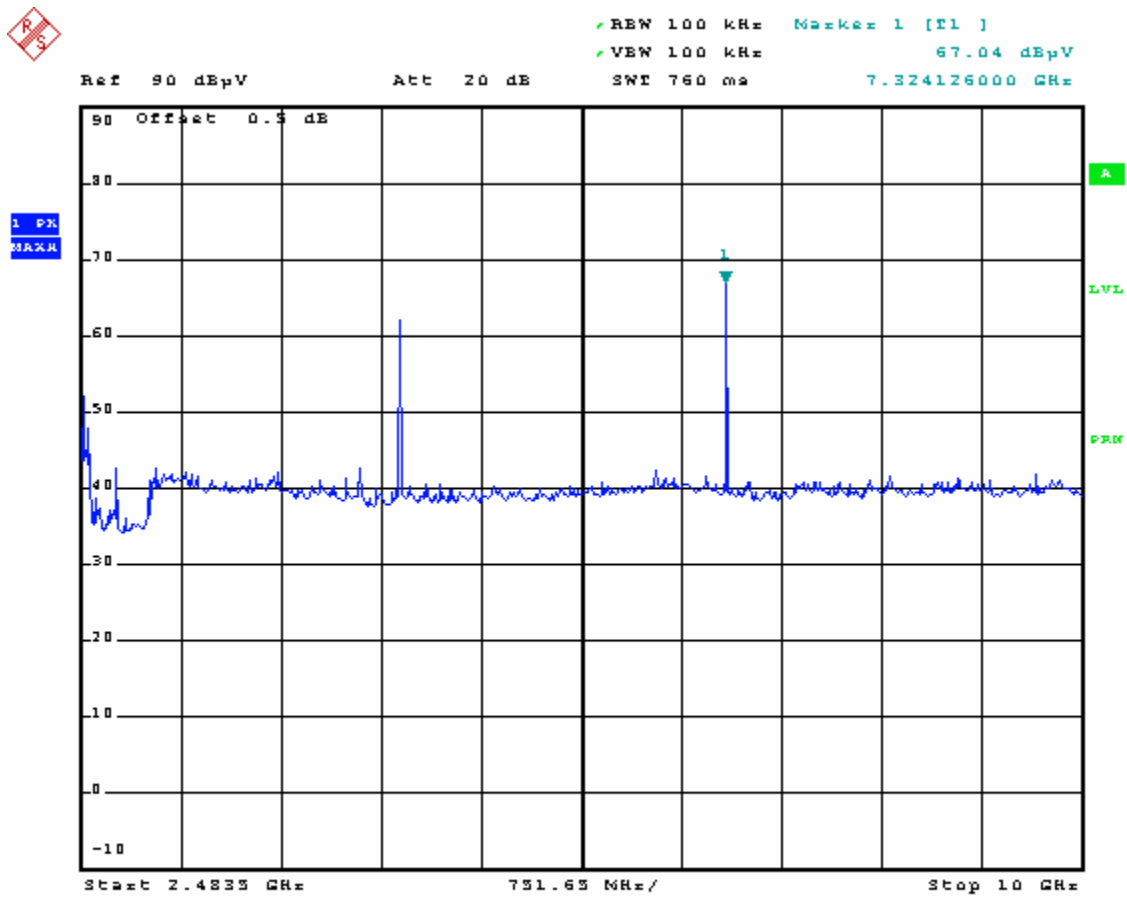

Comment: Spurious emissions, Freq 2441MHz, Ex1  
 Date: 21.AUG.2008 17:09:04

Plot 6.8

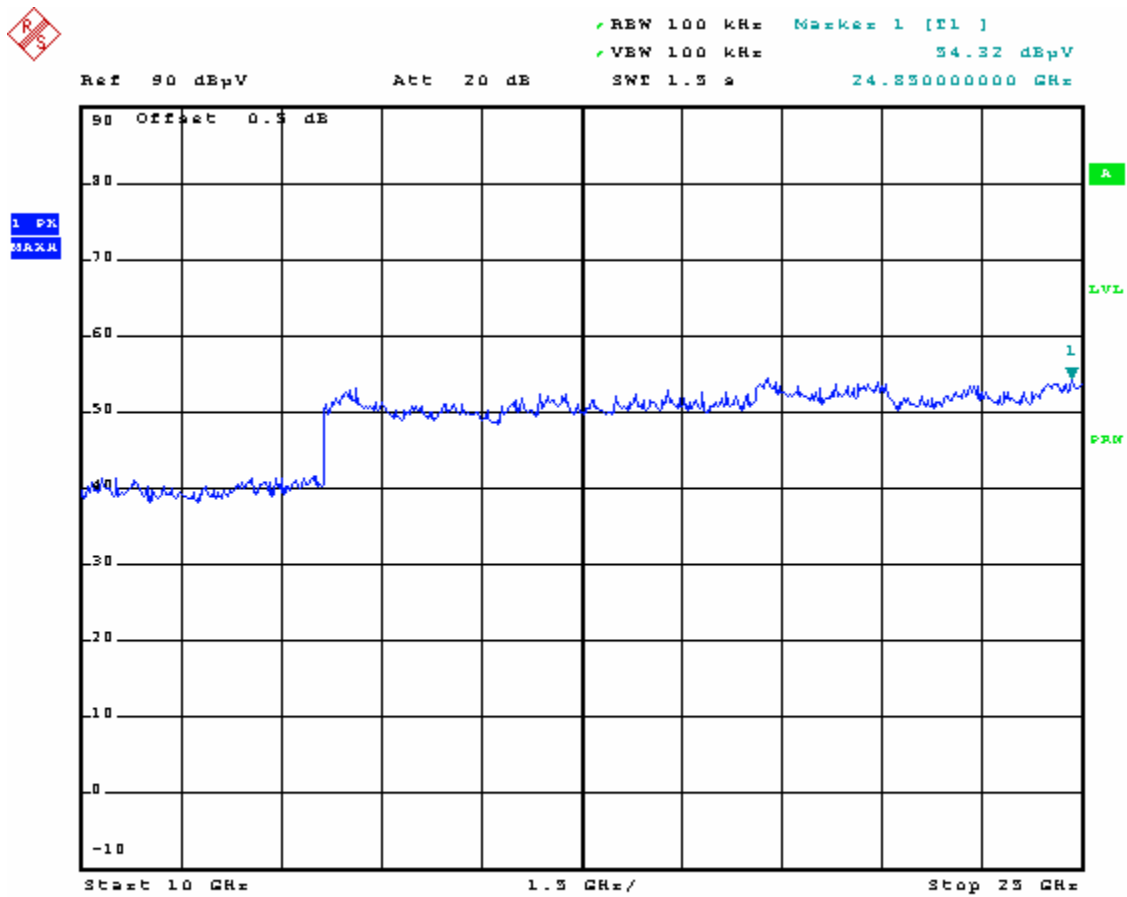

Comment: Spurious emissions, Freq 2441MHz, Ex1  
 Date: 21.AUG.2008 17:09:56



Plot 6.9

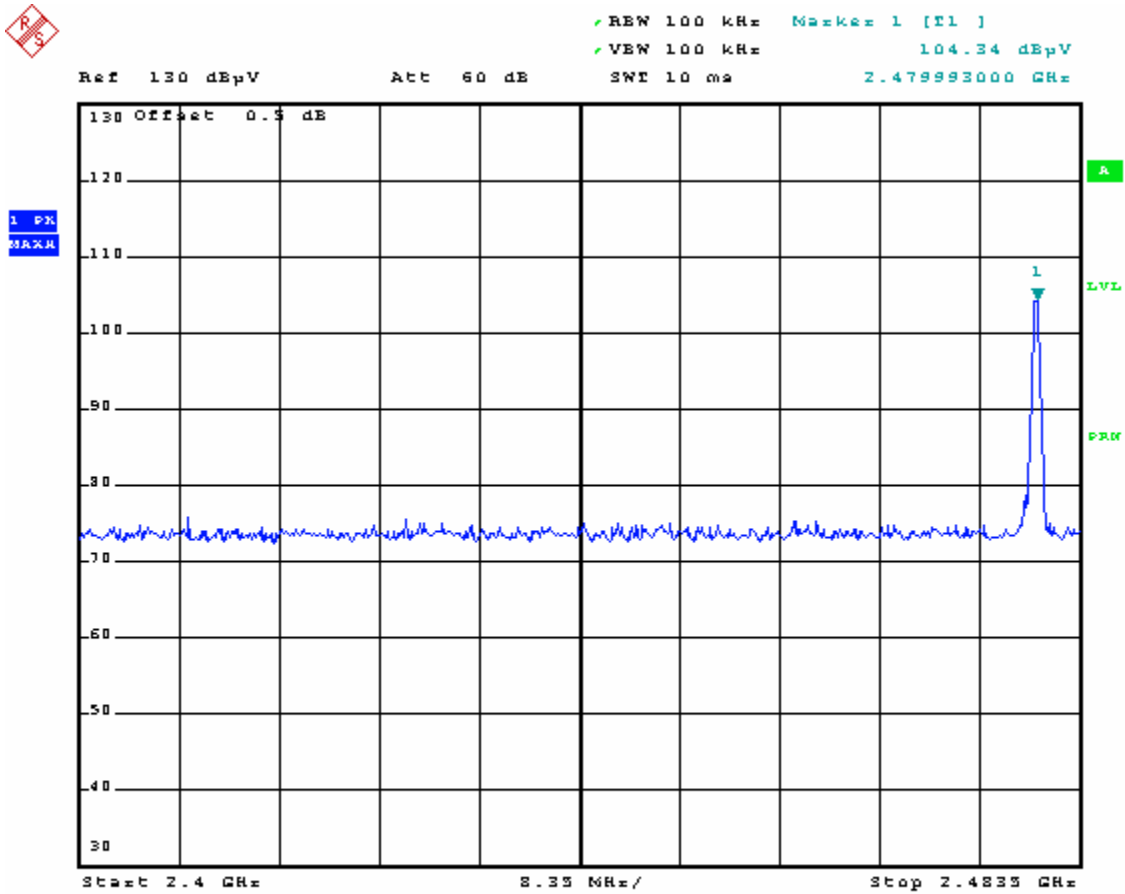

Comment: In-band emissions, Freq 2480MHz, Tx1  
 Date: 21.AUG.2008 17:14:06

Plot 6.10

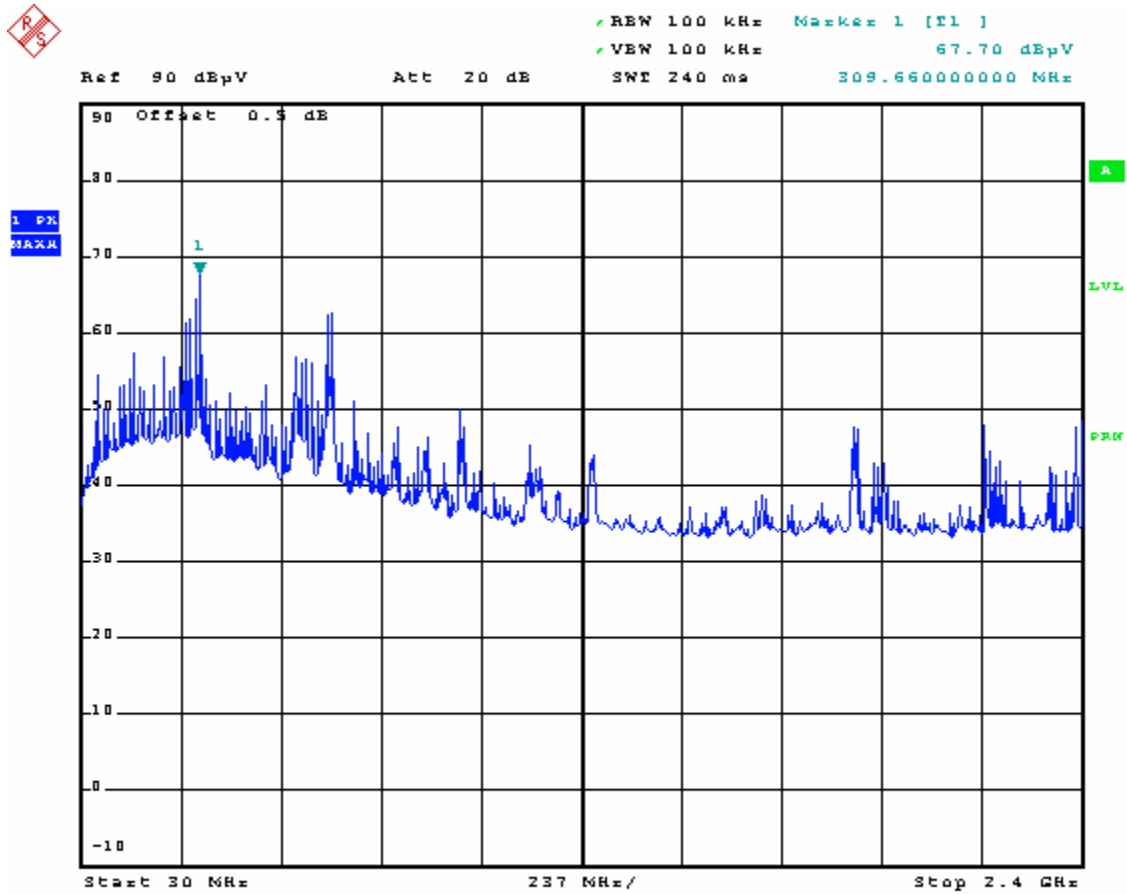

Comment: Spurious emission, Freq 248MHz, Ex1  
 Date: 21.AUG.2008 17:16:00

Plot 6.11

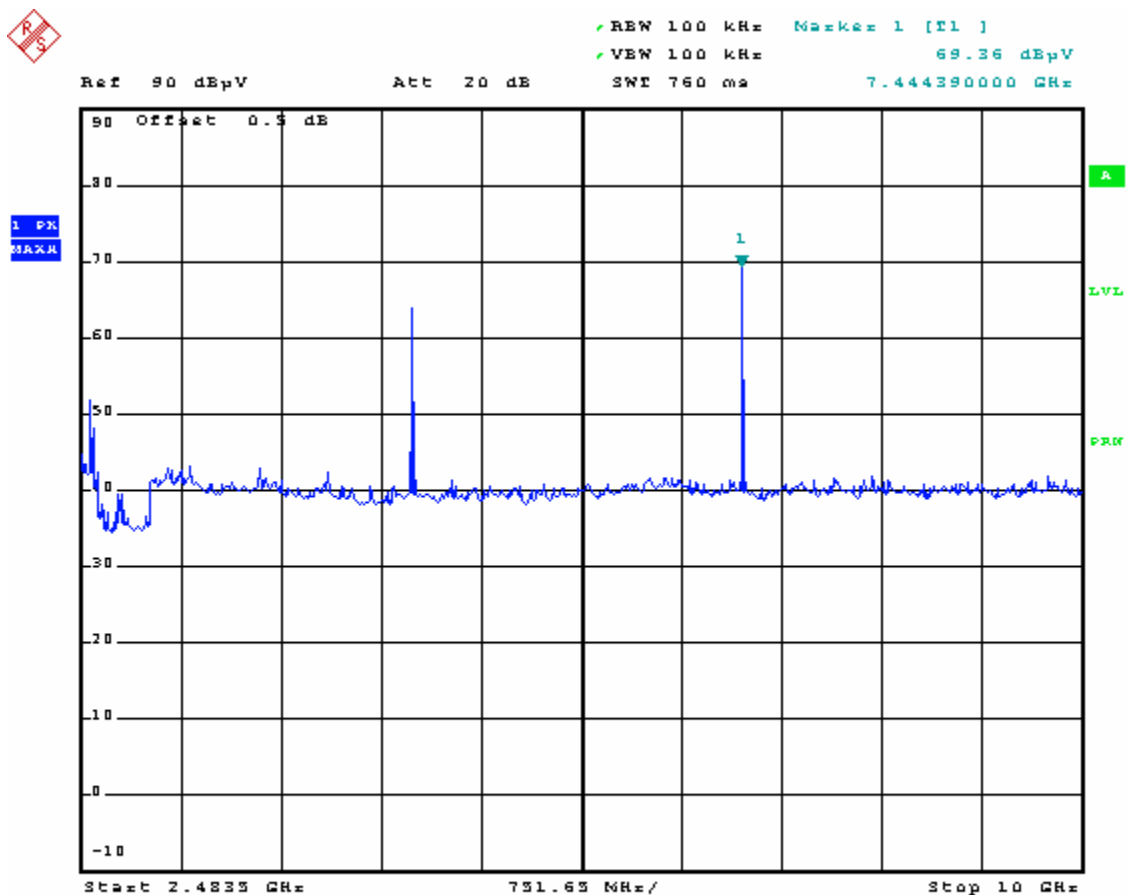

Comment: Spurious emissions, Freq 2480MHz, Ex1  
 Date: 21.AUG.2008 17:17:16

Plot 6.12

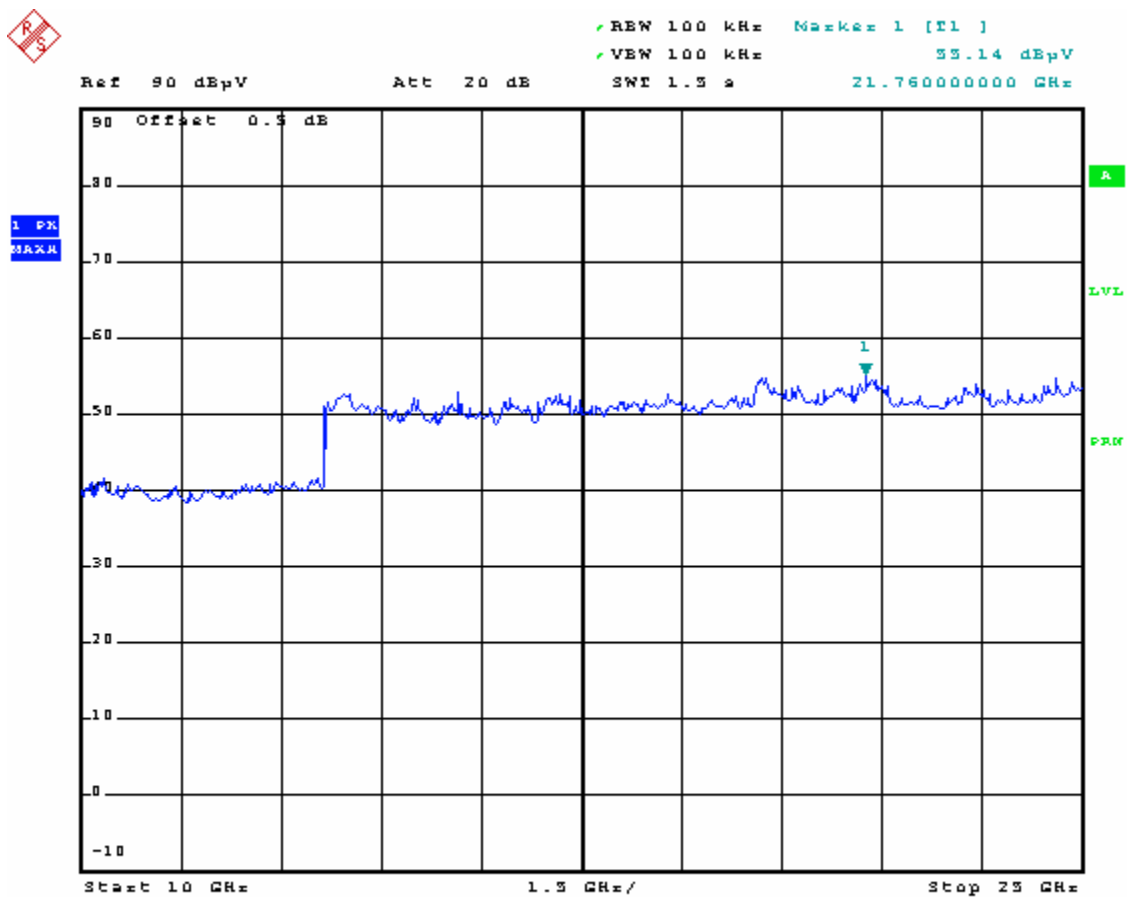

Comment: Spurious emissions, Freq 2480MHz, Ex1  
 Date: 21.AUG.2008 17:18:30

Plot 6.13

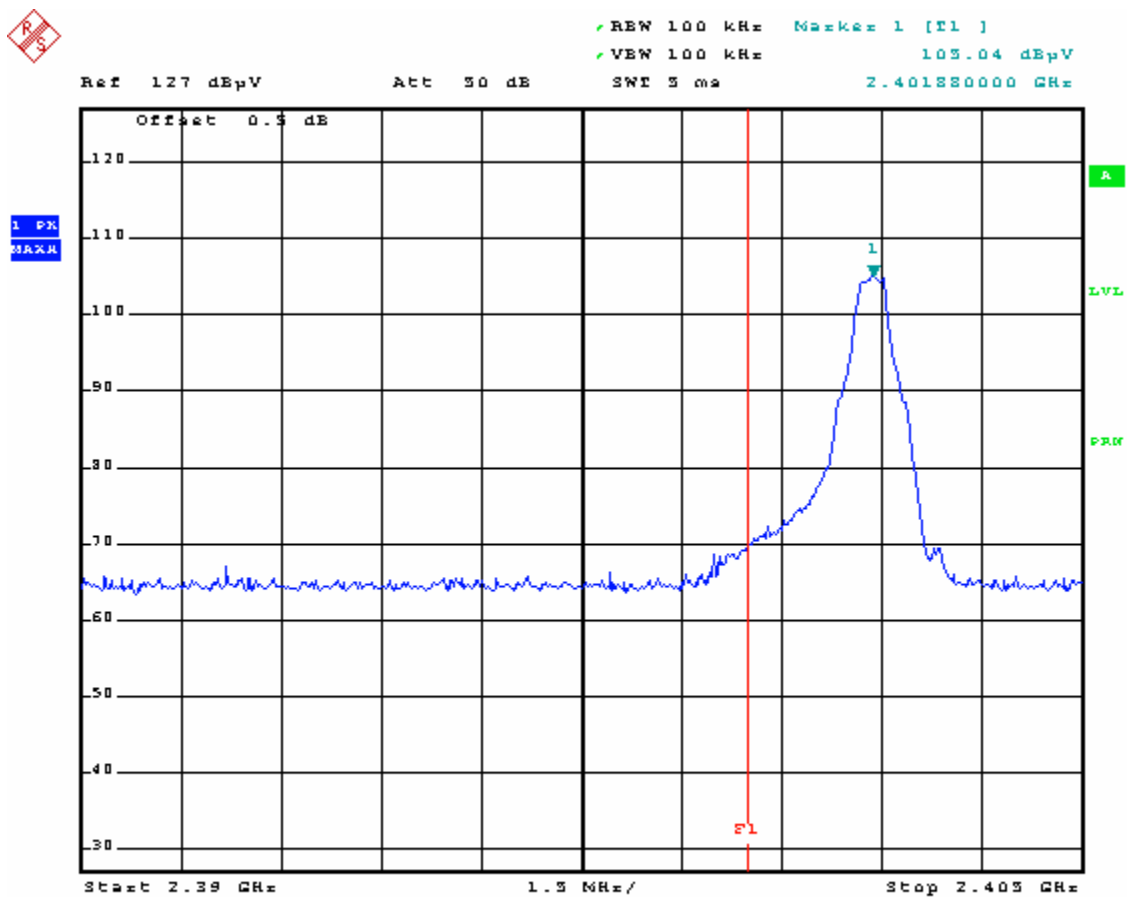

Comment: Spurious emissions, Freq 2402MHz, Ex1  
 Date: 21.AUG.2008 22:08:21

Plot 6.14

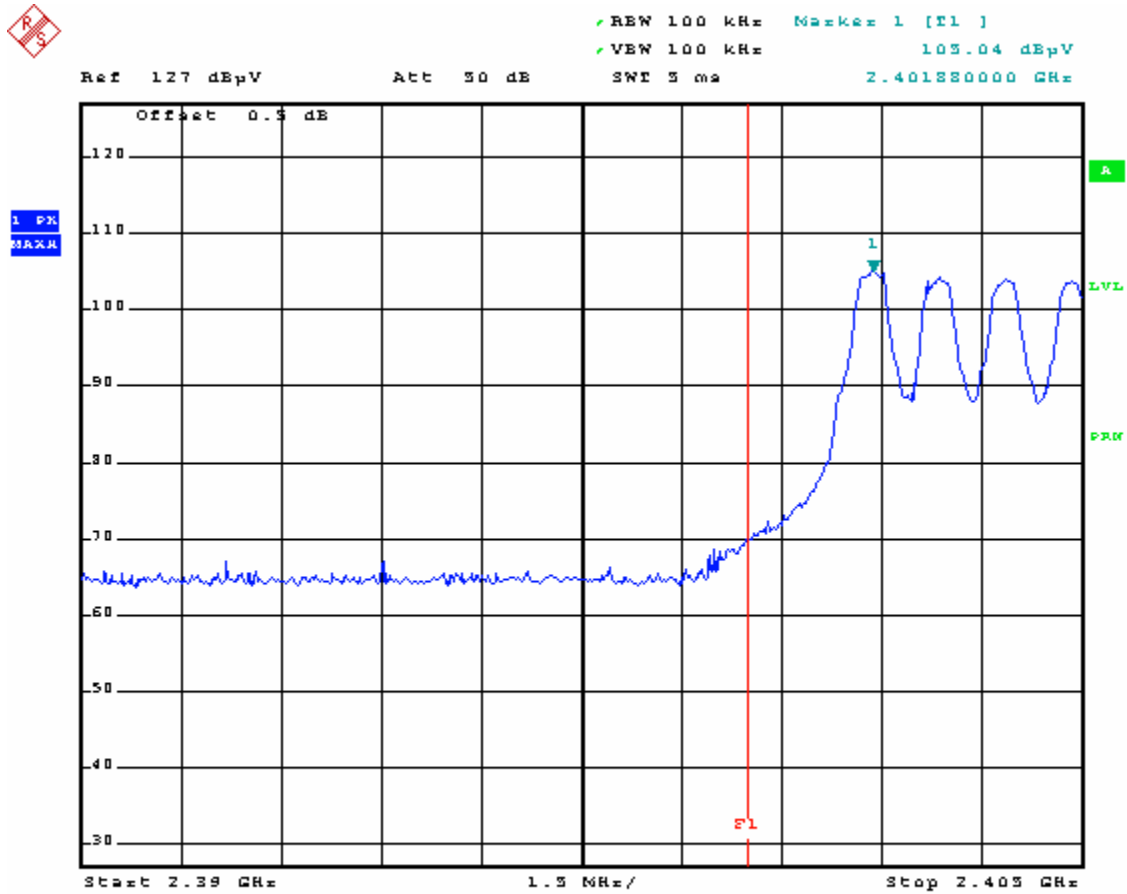

Comment: Spurious emissions, Freq 2402MHz, Ex1  
Date:            21.AUG.2008 22:10:15

Plot 6.15

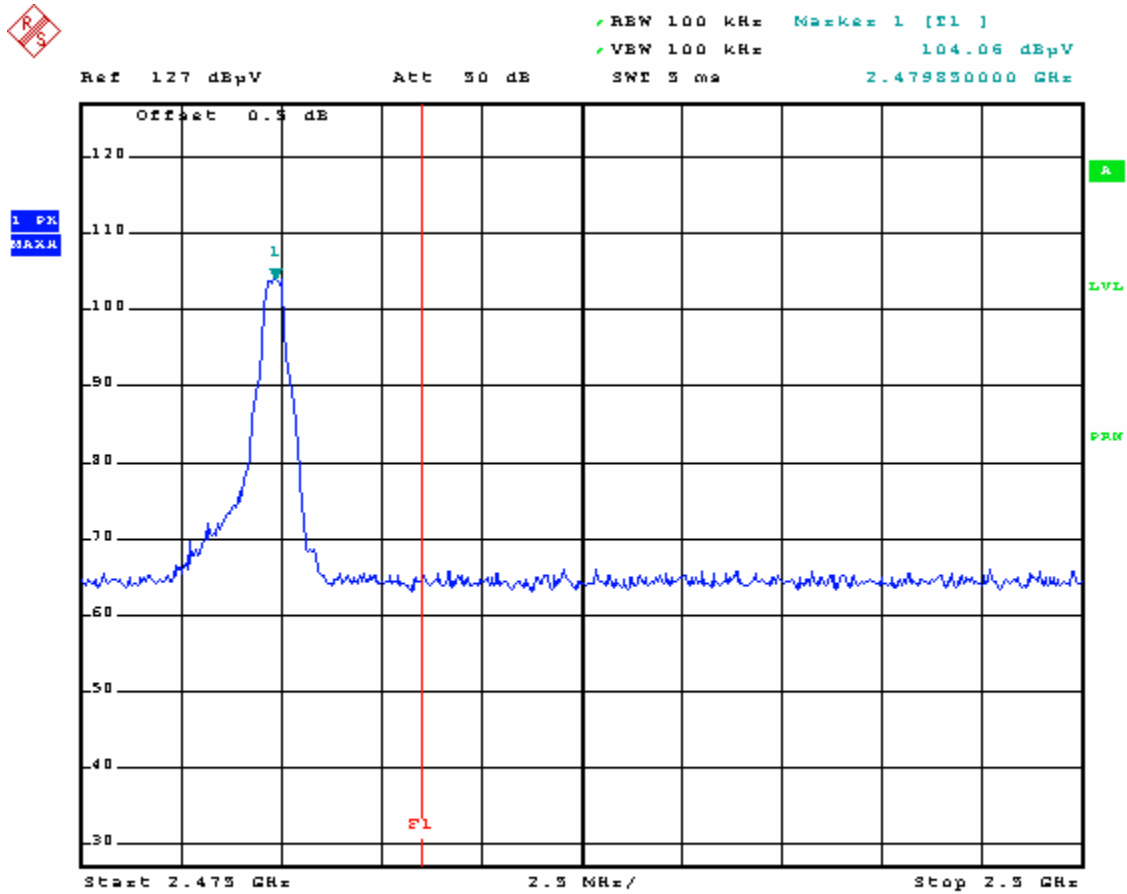

Comment: Spurious emissions, Freq 2480MHz, Fx1  
 Date:            21.AUG.2008 22:14:21

Plot 6.16

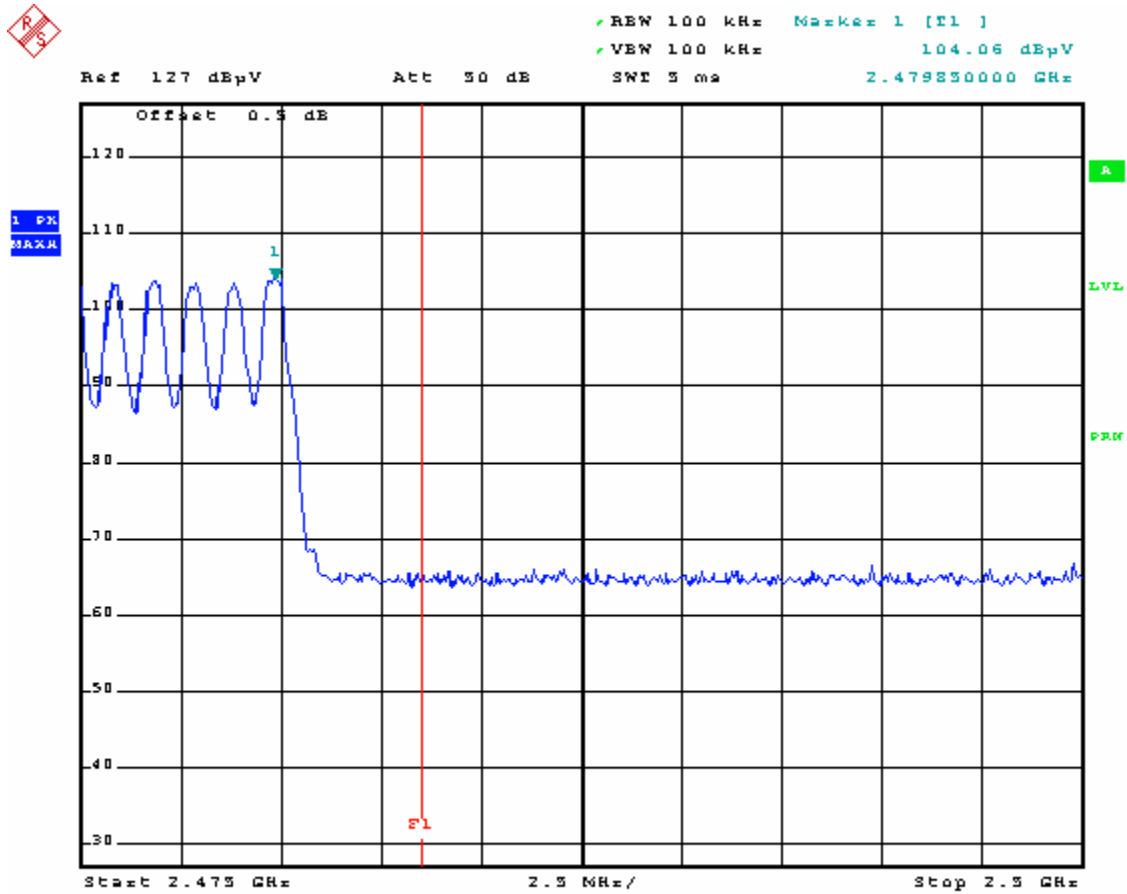

Comment: Spurious emissions, Freq 2480MHz, Fx1  
 Date: 21.AUG.2008 22:16:41



Plot 6.17

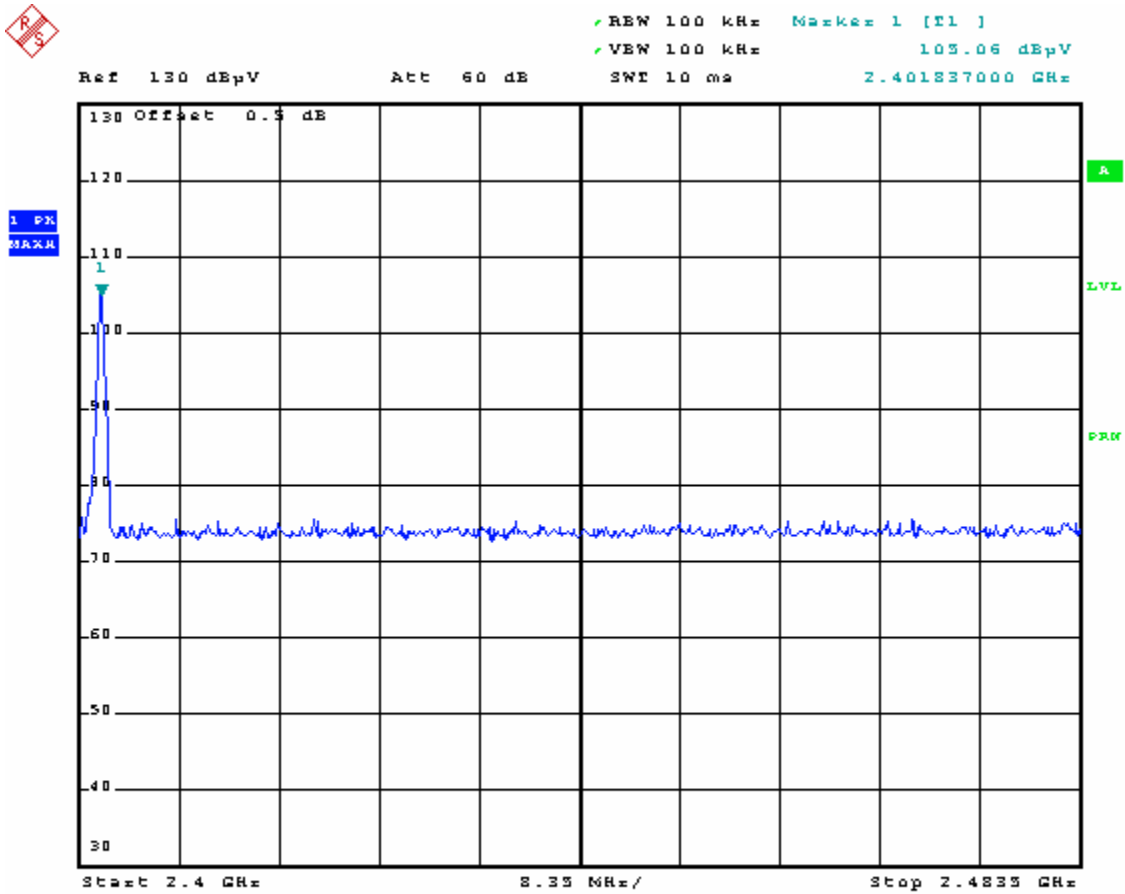

Comment: In-band emissions, Freq 2402MHz, Tx2  
 Date: 21.AUG.2008 17:41:46

Plot 6.18

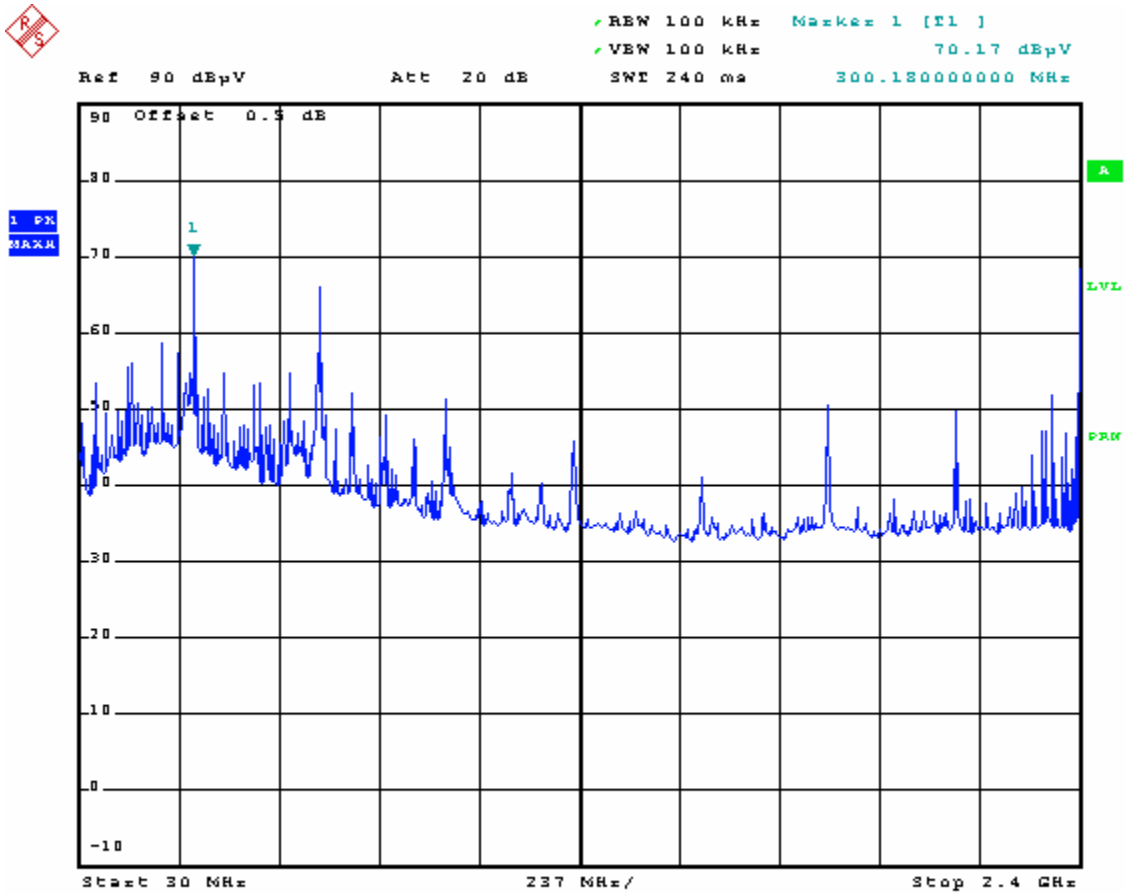

Comment: Spurious emissions, Freq 2402MHz, Ex2  
 Date: 21.AUG.2008 17:43:22

Plot 6.19

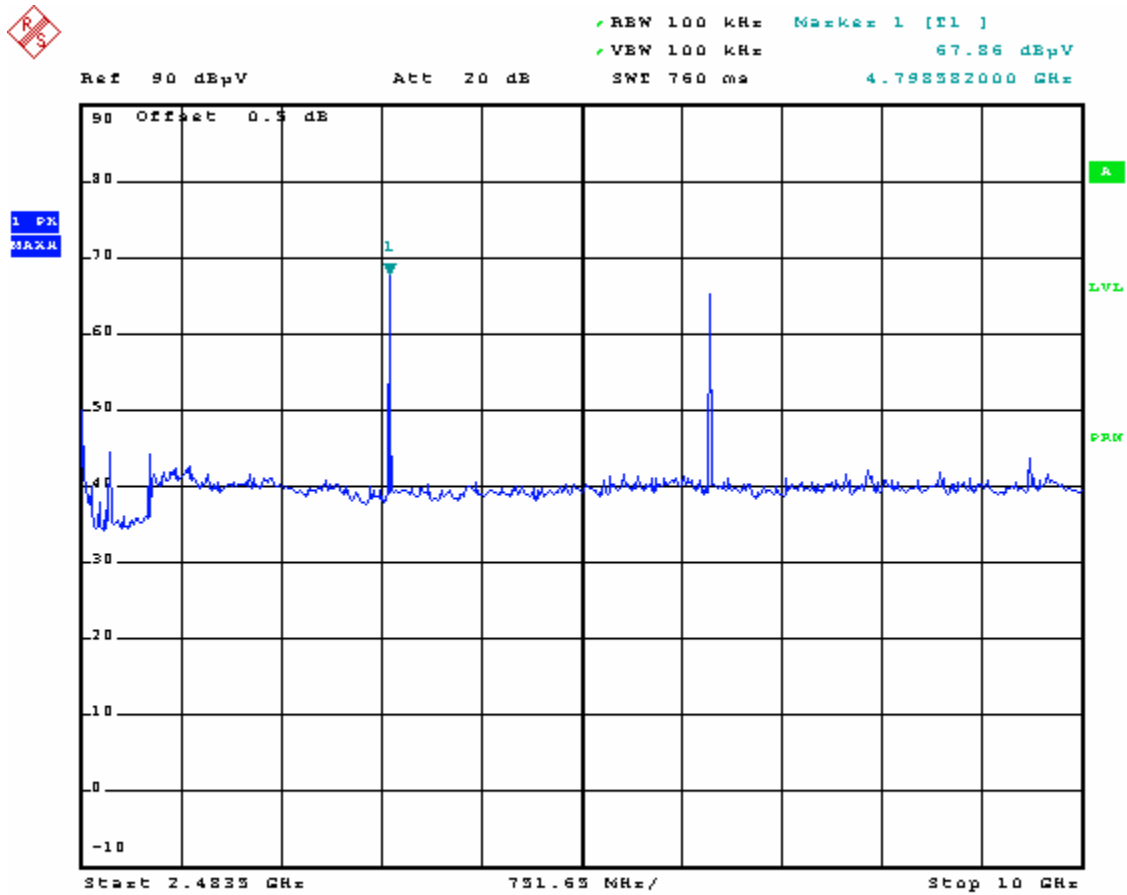

Comment: Spurious emissions, Freq 2402MHz, Tx2  
 Date: 21.AUG.2008 17:44:24

Plot 6.20

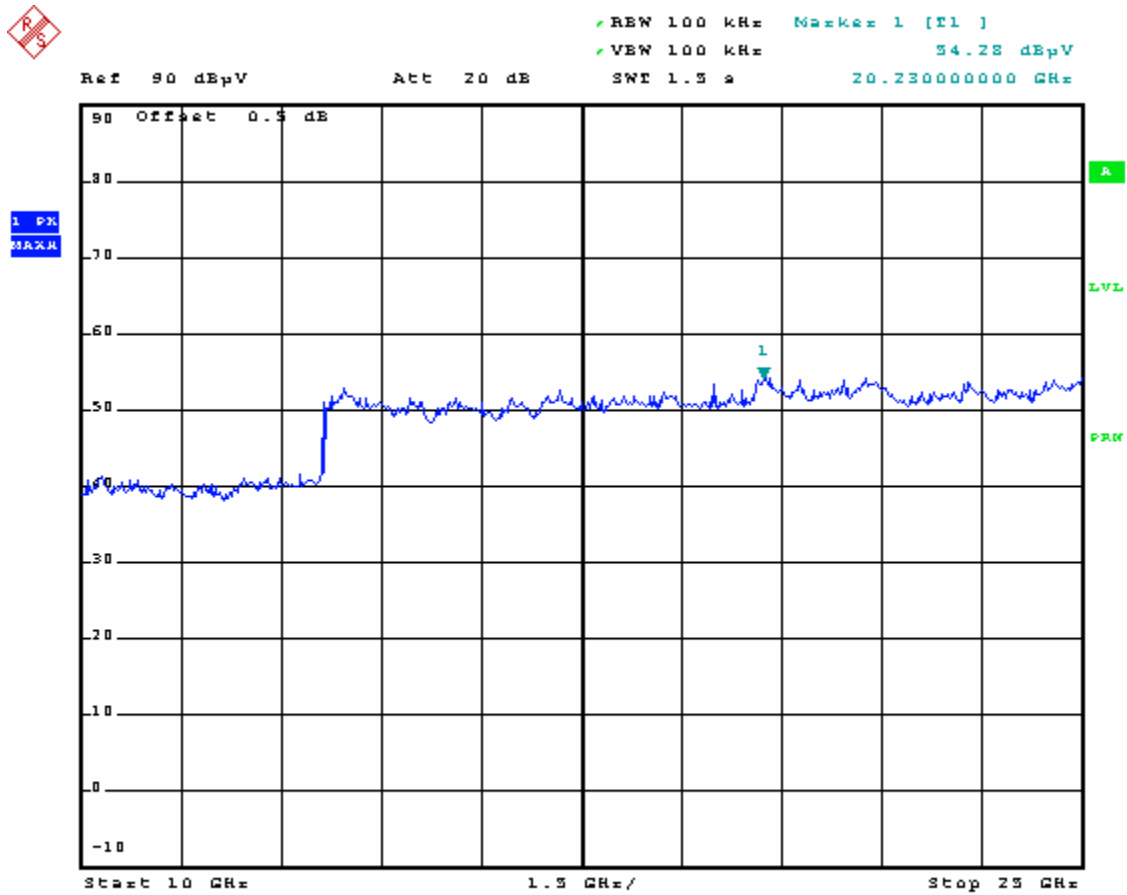

Comment: Spurious emissions, Freq 2402MHz, Ex2  
 Date: 21.AUG.2008 17:43:28

Plot 6.21

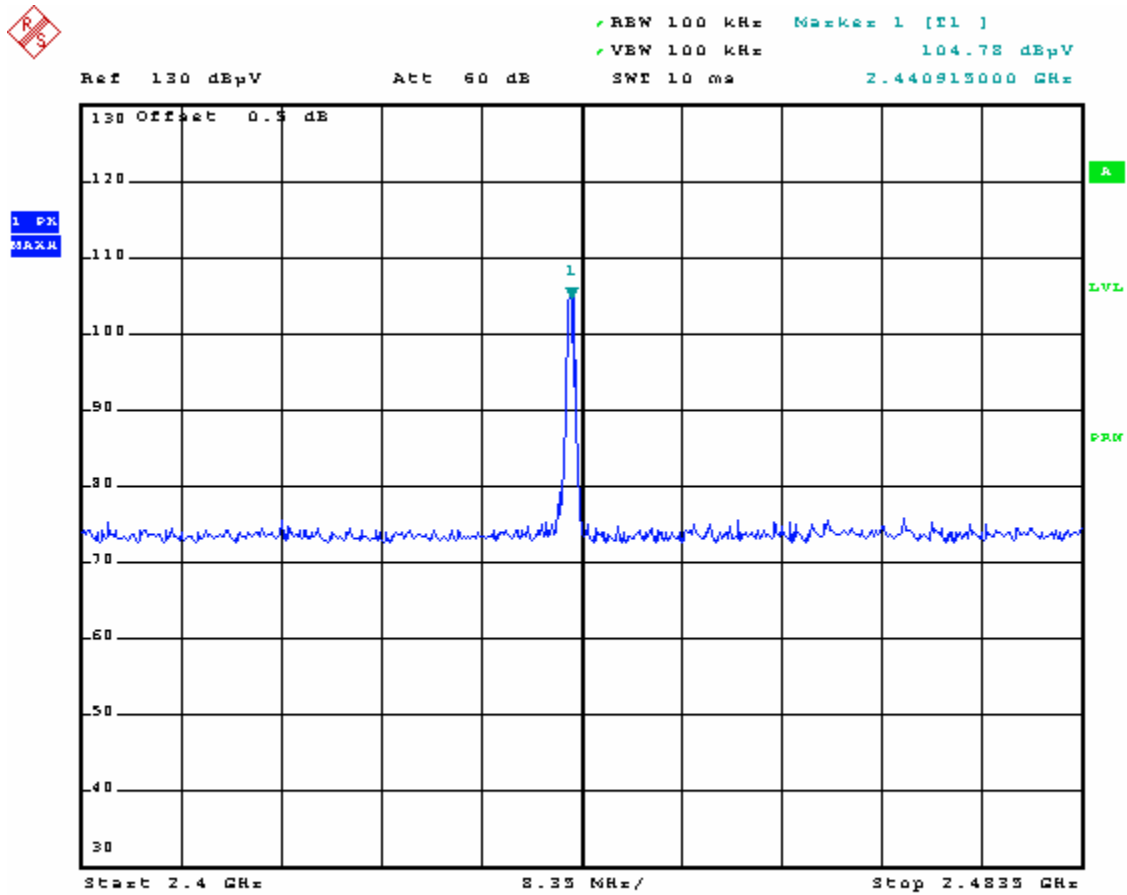

Comment: In-band emissions, Freq 2441MHz, Tx2  
 Date: 21.AUG.2008 18:08:05

Plot 6.22

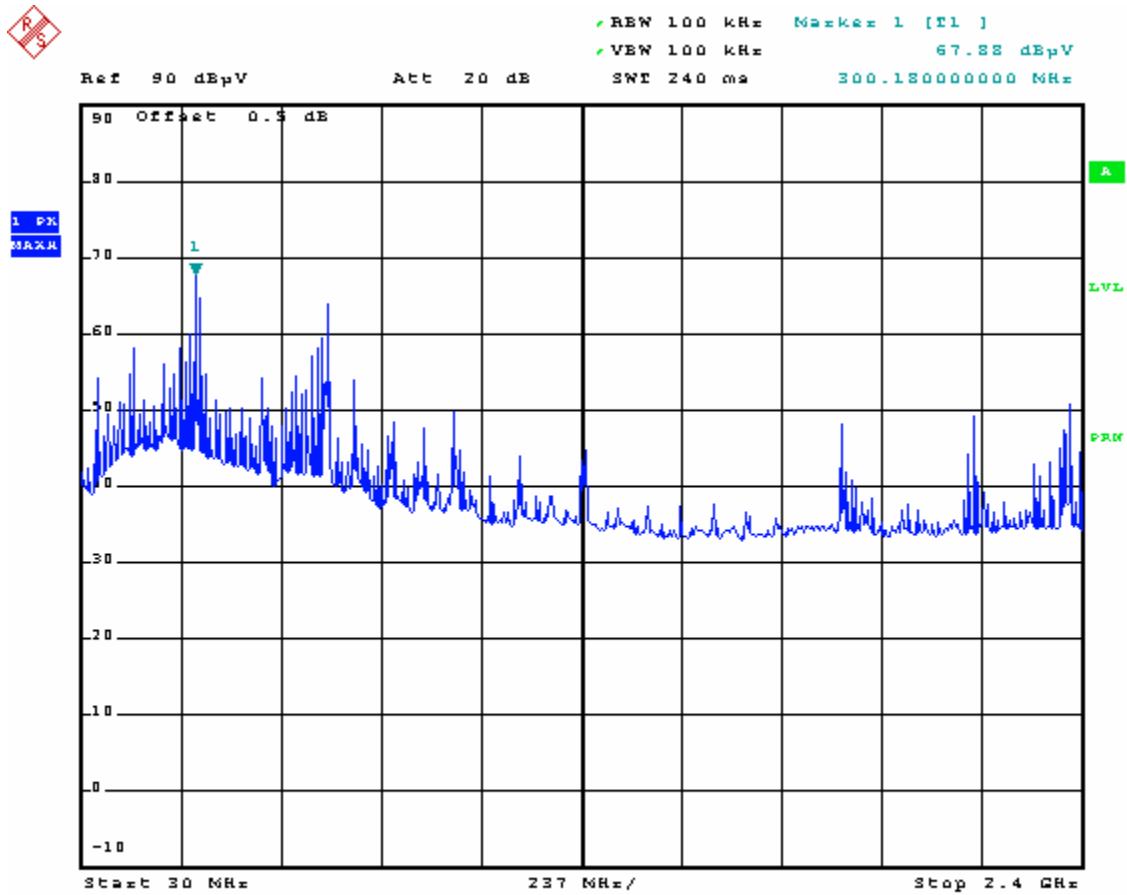

Comment: Spurious emissions, Freq 2441MHz, Tx2  
 Date: 21.AUG.2008 18:10:12

Plot 6.23

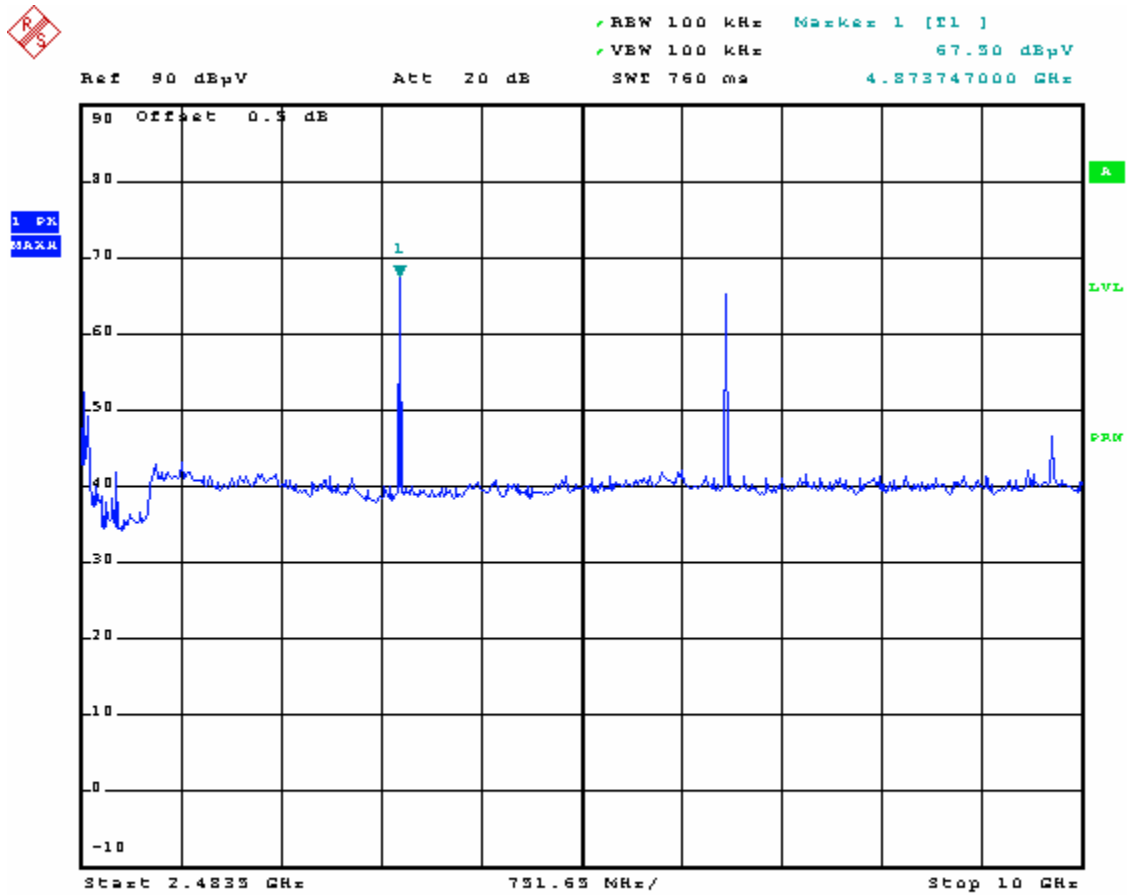

Comment: Spurious emissions, Freq 2441MHz, Tx2  
 Date: 21.AUG.2008 18:11:33

Plot 6.24

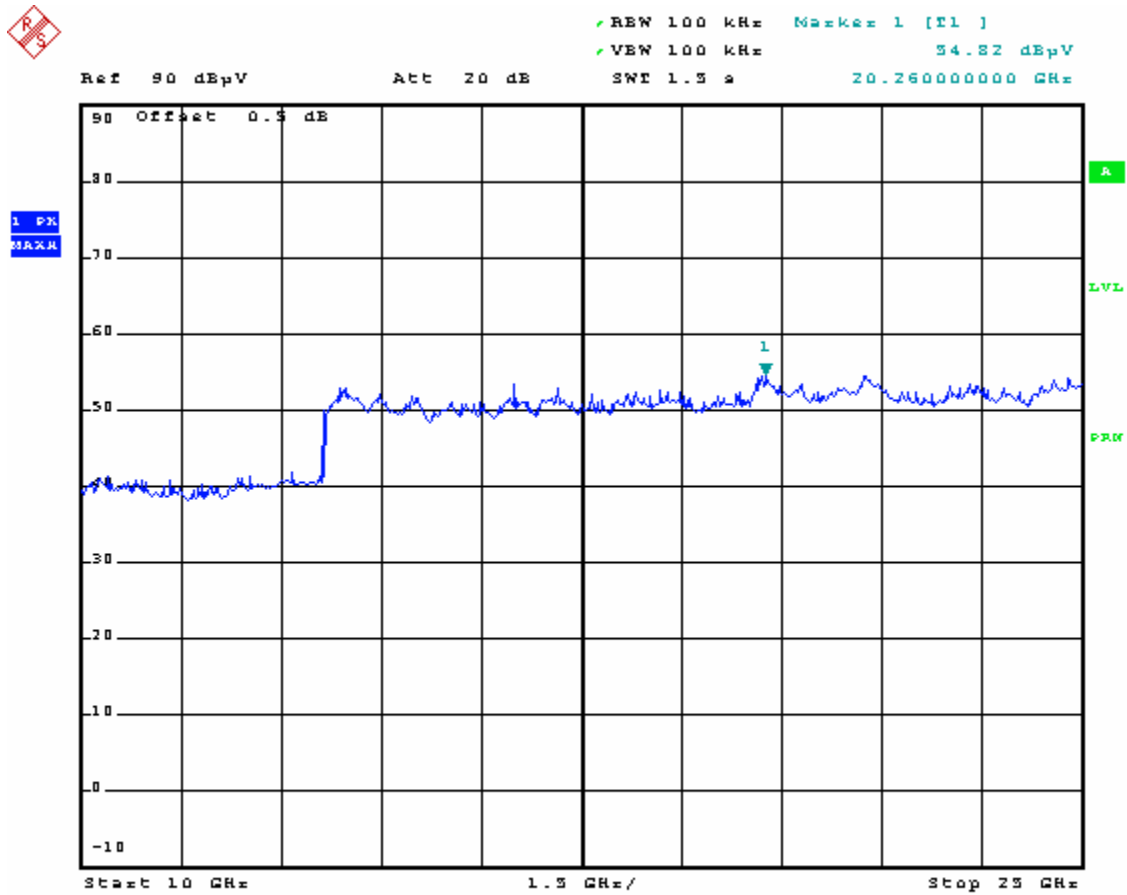

Comment: Spurious emissions, Freq 2441MHz, Ex2  
 Date: 21.AUG.2008 18:12:34



Plot 6.25

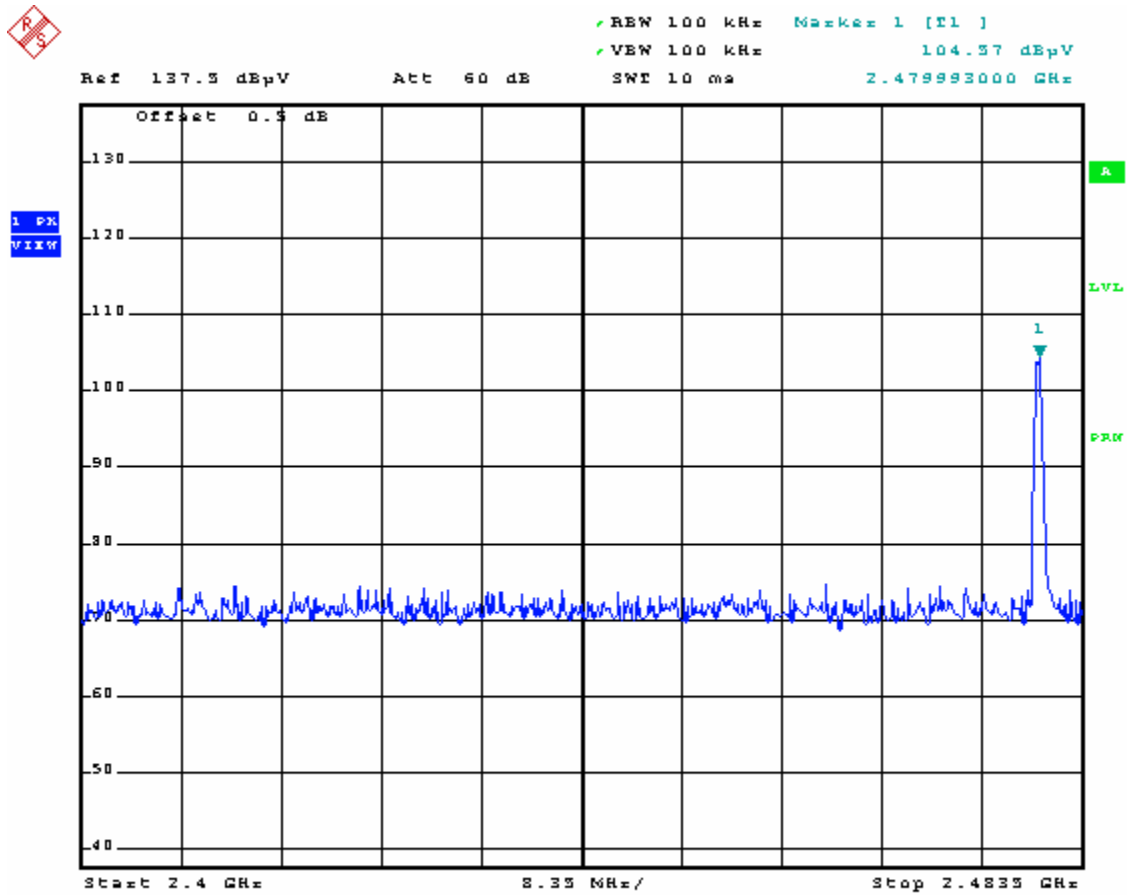

Comment: In-band emissions, Freq 2480MHz, Tx2  
 Date: 21.AUG.2008 19:00:21

Plot 6.26

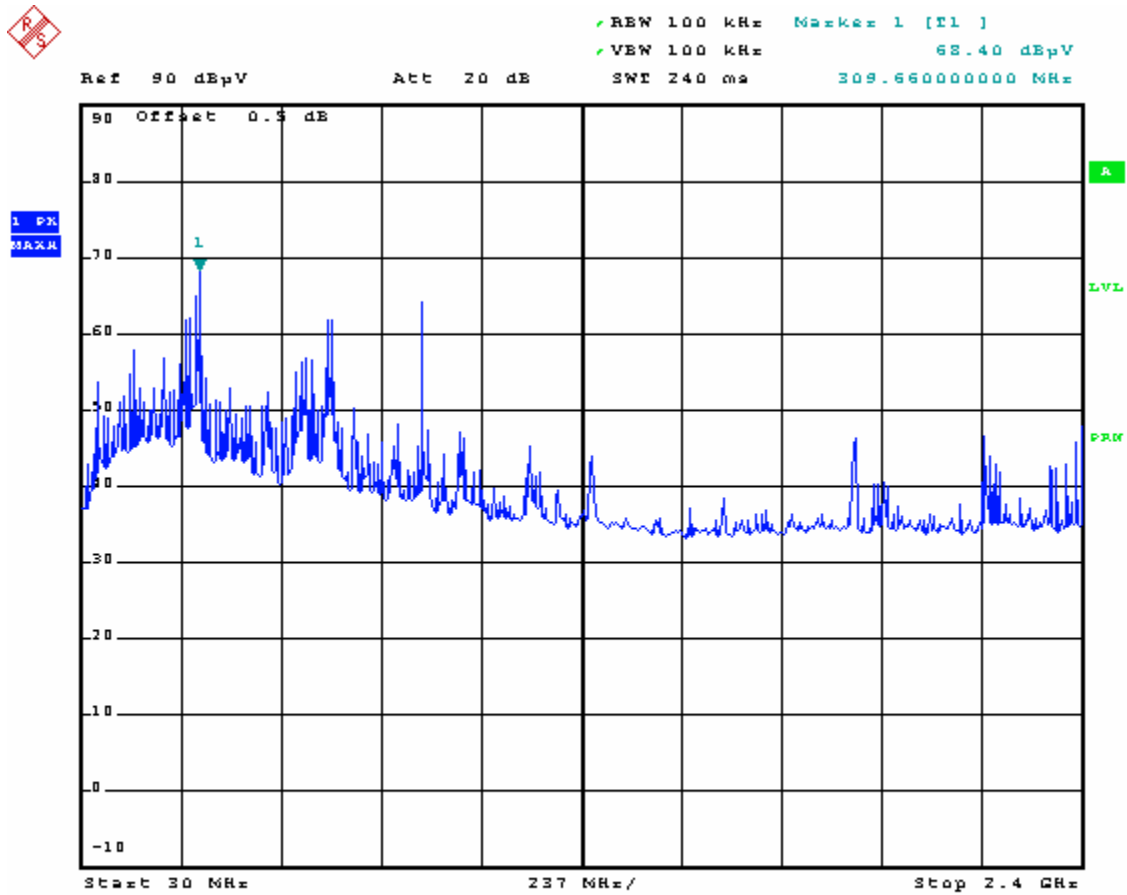

Comment: Spurious emissions, Freq 2480MHz, Tx2  
 Date: 21.AUG.2008 19:04:24

Plot 6.27

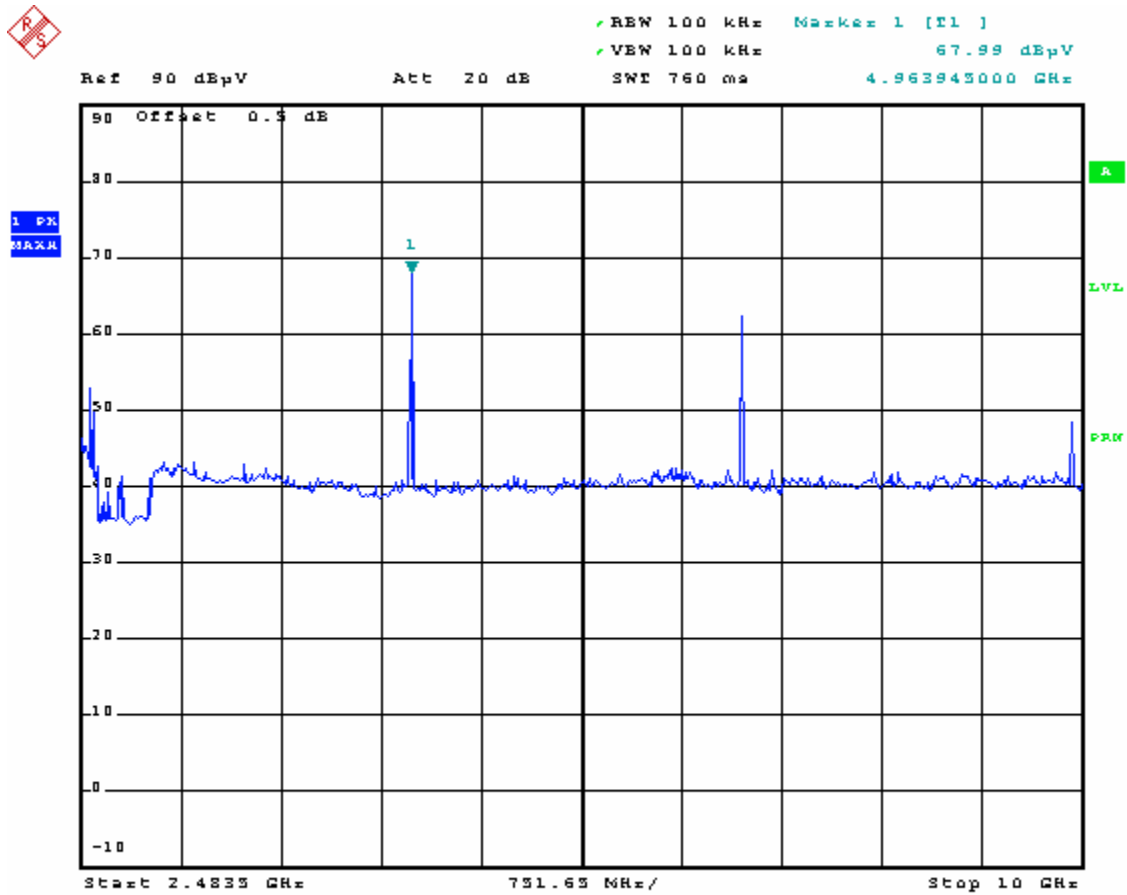

Comment: Spurious emissions, Freq 2480MHz, Tx2  
 Date: 21.AUG.2008 19:08:11

Plot 6.28

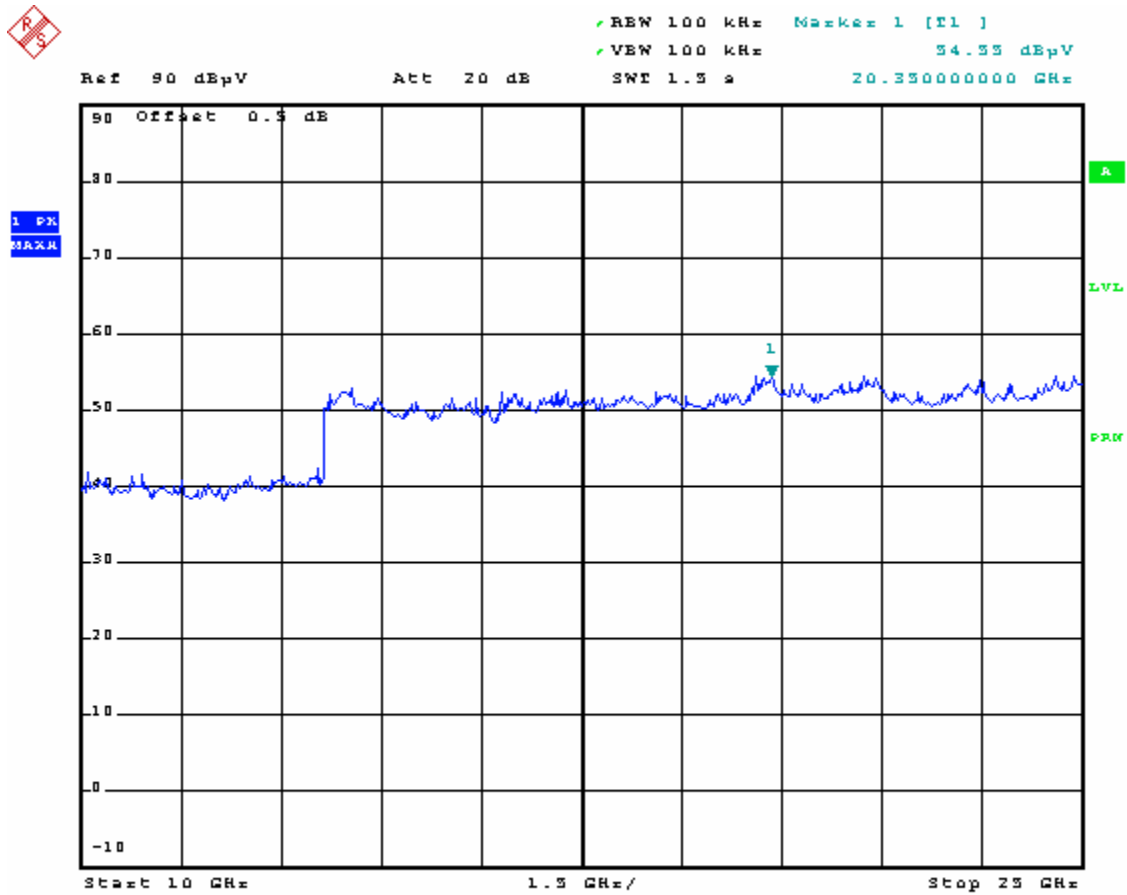

Comment: Spurious emissions, Freq 2480MHz, Tx2  
 Date: 21.AUG.2008 19:09:14

Plot 6.29

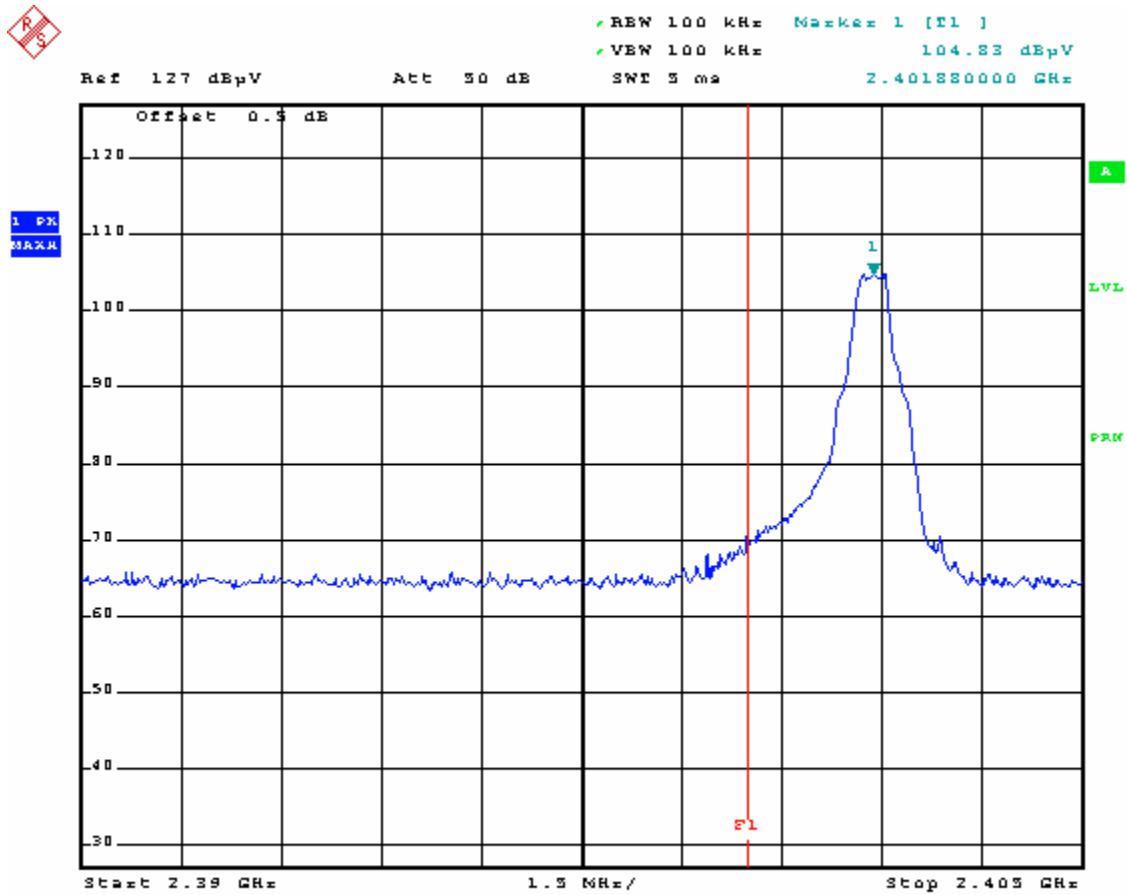

Comment: Spurious emissions, Freq 2402MHz, Tx2  
 Date: 21.AUG.2008 22:36:35

Plot 6.30

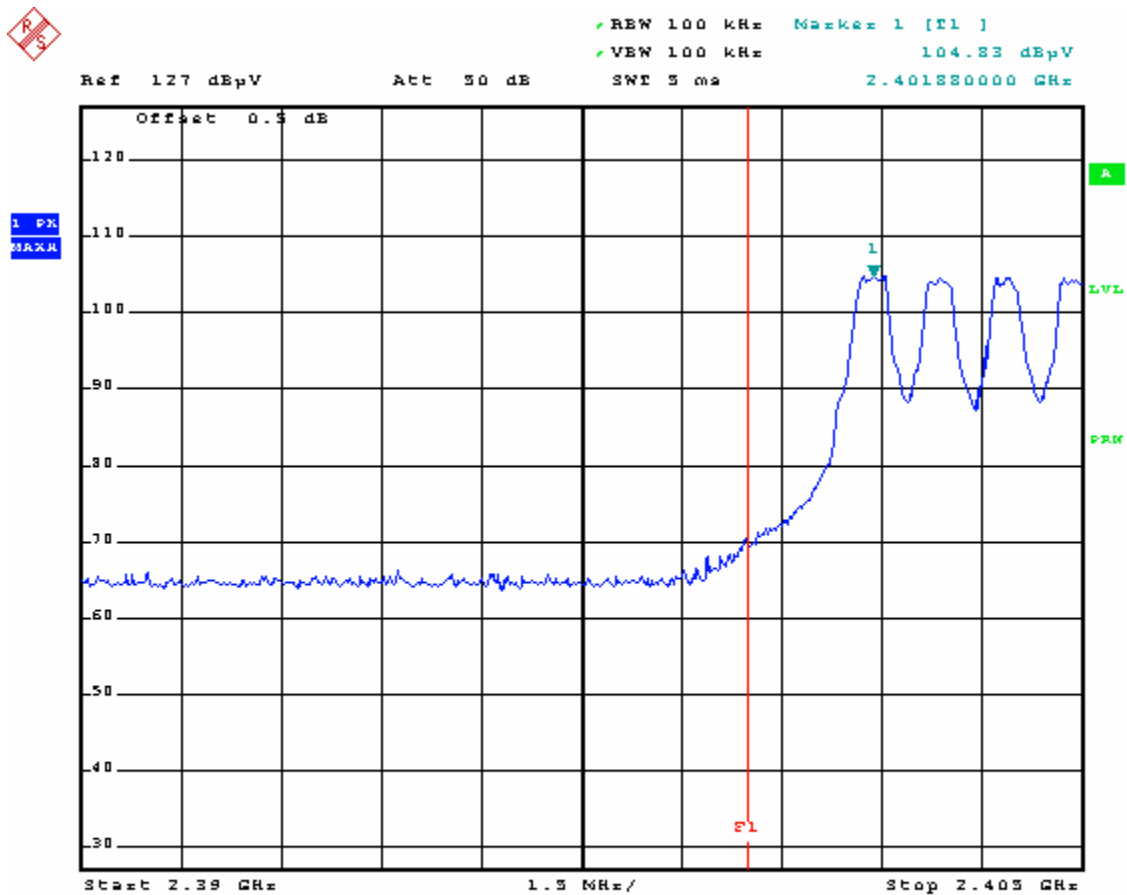

Comment: Spurious emissions, Freq 2402MHz, Tx2  
 Date: 21.AUG.2008 22:39:14

Plot 6.31

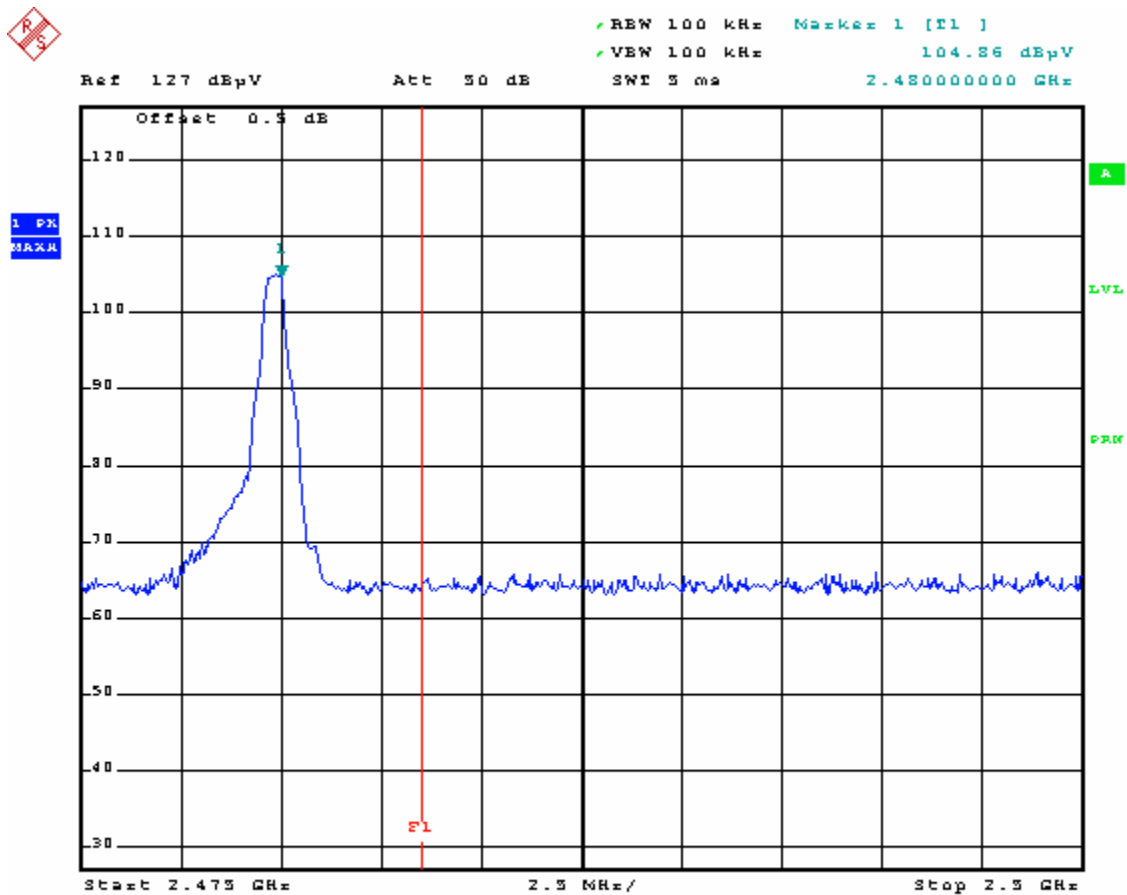

Comment: Spurious emissions, Freq 2480MHz, Tx2  
 Date: 21.AUG.2008 22:29:35

Plot 6.32

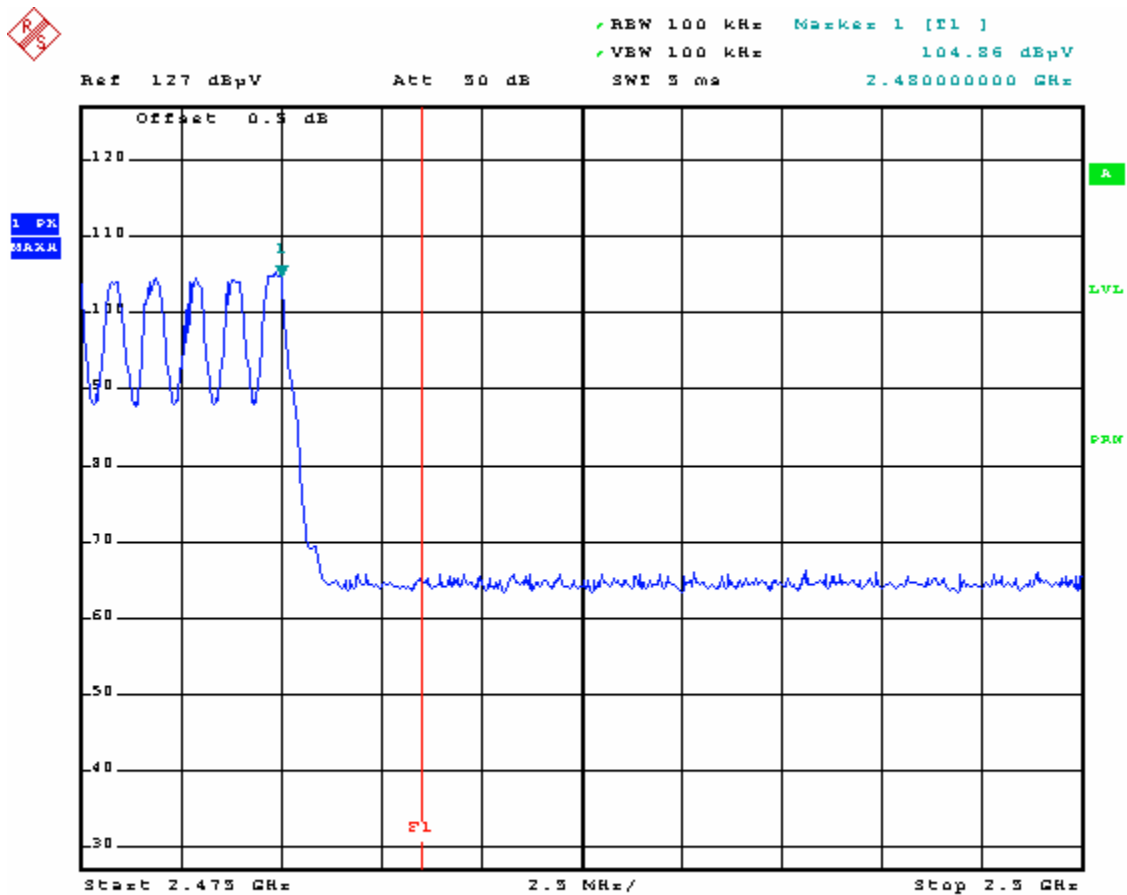

Comment: Spurious emissions, Freq 2480MHz, Tx2  
Date: 21.AUG.2008 22:31:07



4.7 Out-of-Band Radiated Emissions (except emissions in restricted bands)  
FCC 15.247(c)

For out-of-band radiated emissions (except for frequencies in restricted bands) that are close to or that exceed the 20 dB attenuation requirement described in the specification, radiated measurements were performed at a 3 m separation distance to determine whether these emissions complied with the general radiated emission requirement.

Not performed, the EUT passed out-of-band antenna conducted emission test.

#### 4.8 Transmitter Radiated Emissions in Restricted Bands FCC 15.247 (c), 15.205

##### Procedure

Radiated emission measurements were performed from 30 MHz to 25,000 MHz. Spectrum Analyzer Resolution Bandwidth is 100 kHz or greater for frequencies 30 MHz to 1000 MHz, 1 MHz - for frequencies above 1000 MHz.

The EUT is placed on a non-conductive table. If the EUT attaches to peripherals, they are connected and operational (as typical as possible). During testing, all cables were manipulated to produce worst case emissions. The signal is maximized through rotation. The antenna height and polarization are varied during the search for maximum signal level. The antenna height is varied from 1 to 4 meters.

Radiated emissions are taken at three meters unless the signal level is too low for measurement at that distance. If necessary, a pre-amplifier is used and/or the test is conducted at a closer distance. All readings are extrapolated back to the equivalent three-meter reading using inverse scaling with distance.

Data is included of the worst case configuration (the configuration which resulted in the highest emission levels). A sample calculation, configuration photographs and data tables of the emissions are included.

##### Field Strength Calculation

The field strength is calculated by adding the Antenna Factor and Cable Factor, and subtracting the Amplifier Gain (if any) from the measured reading. The basic equation with a sample calculation is as follows:

$$FS = RA + AF + CF - AG$$

Where FS = Field Strength in dB( $\mu$ V/m)

RA = Receiver Amplitude (including preamplifier) in dB( $\mu$ V)

CF = Cable Attenuation Factor in dB

AF = Antenna Factor in dB

AG = Amplifier Gain in dB

Assume a receiver reading of 52.0 dB( $\mu$ V) is obtained. The antennas factor of 7.4 dB(1/m) and cable factor of 1.6 dB is added. The amplifier gain of 29 dB is subtracted, giving field strength of 32 dB( $\mu$ V/m). This value in dB( $\mu$ V/m) was converted to its corresponding level in  $\mu$ V/m.

$$RA = 52.0 \text{ dB}(\mu\text{V})$$

$$AF = 7.4 \text{ dB}(1/\text{m})$$

$$CF = 1.6 \text{ dB}$$

$$AG = 29.0 \text{ dB}$$

$$FS = 52.0 + 7.4 + 1.6 - 29.0 = 32 \text{ dB}(\mu\text{V}/\text{m})$$

$$\text{Level in } \mu\text{V}/\text{m} = \text{Common Antilogarithm} [(32 \text{ dB}\mu\text{V}/\text{m})/20] = 39.8 \mu\text{V}/\text{m}$$

## Result

The data on the following pages list the significant emission frequencies, the limit and the margin of compliance.

The radiated emissions in the restricted bands near the operating band are presented on the following Plots 8.1 – 8.6. On these plots antenna factor and cable loss are included in the OFFSET of the spectrum analyzer reading, therefore the readings are field strength.

The EUT passed the test by 0.5 dB.

Test Result	
FCC Part 15.247 Radiated Emission in Restricted Bands	
Temperature: 20 C	Advanced Medical Optics
Humidity: 50 %	Model: Advanced Control Pedal Master
Test distance = 3 m	
Test date: September 04, 2008	

Frequency MHz	Detector	SA reading dB(uV)	Correction Factor dB	Duty * cycle dB	Ant. Factor dB(1/m)	Field Strength dB(uV/m)	Limit dB(uV/m)	Margin dB
Tx at 2402 MHz								
4804	Peak	50.7	-25.8	--	33.0	57.9	74	-16.1
12010	Peak	34.5	-20.8	--	39.2	52.9	74	-21.1
4804	Aver	41.2	-25.8	2.3	33.0	46.1	54	-7.9
12010	Aver	21.2	-20.8	2.3	39.2	37.3	54	-16.7
Tx at 2441 MHz								
4882	Peak	54.1	-25.2	--	33.2	62.1	74	-11.9
7323	Peak	50.5	-22.6	--	36.1	64	74	-10.0
12205	Peak	35.6	-21	--	39	53.6	74	-20.4
4882	Aver	42.0	-25.2	2.3	33.2	47.7	54	-6.3
7323	Aver	40.2	-22.6	2.3	36.1	51.4	54	-2.6
12205	Aver	24.0	-21	2.3	39	39.7	54	-14.3
Tx at 2480 MHz								
4960	Peak	50.8	-24.9	--	33.4	59.3	74	-14.7
7440	Peak	49.4	-22.6	--	36.4	63.2	74	-10.8
12400	Peak	33.9	-21.3	--	38.7	51.3	74	-22.7
4960	Aver	40.6	-24.9	2.3	33.4	46.8	54	-7.2
7440	Aver	41.8	-22.6	2.3	36.6	53.5	54	-0.5
12400	Aver	22.5	-21.3	2.3	38.7	37.6	54	-16.4

\* See Appendix A for Duty cycle measurement.

- a) RBW = 1 MHz, VBW = 1 MHz - for peak measurements  
RBW = 1MHz, VBW = 100 Hz - for average measurements
- b) Correction Factor: Pre-amplifier gain + Cable loss + HP-Filter loss

Plot 8.1

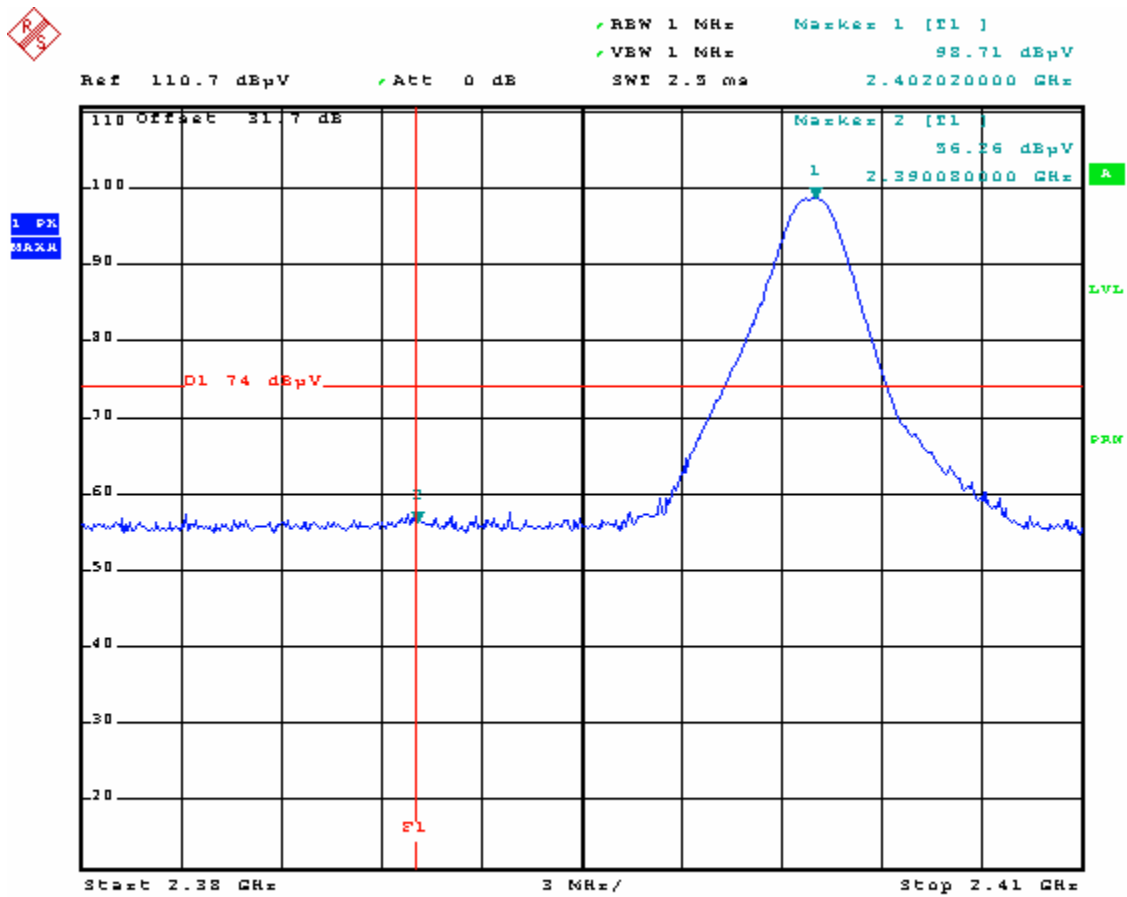

Comment: Emissions on band-edge frequency, peak, freq 2402MHz  
 Date: 27.AUG.2008 16:50:35

Plot 8.2

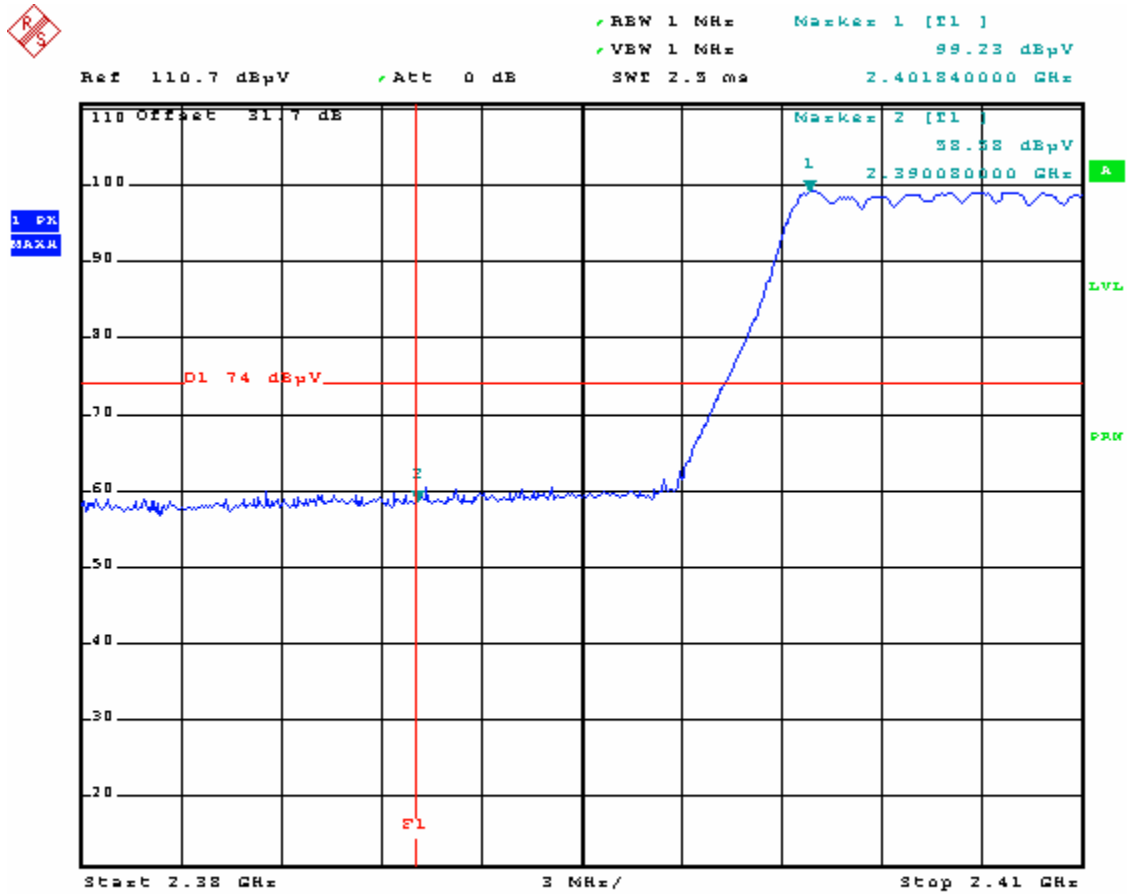

Comment: Emissions on band-edge frequency, peak, freq 2402MHz  
 Date: 27.AUG.2008 16:31:25

Plot 8.3

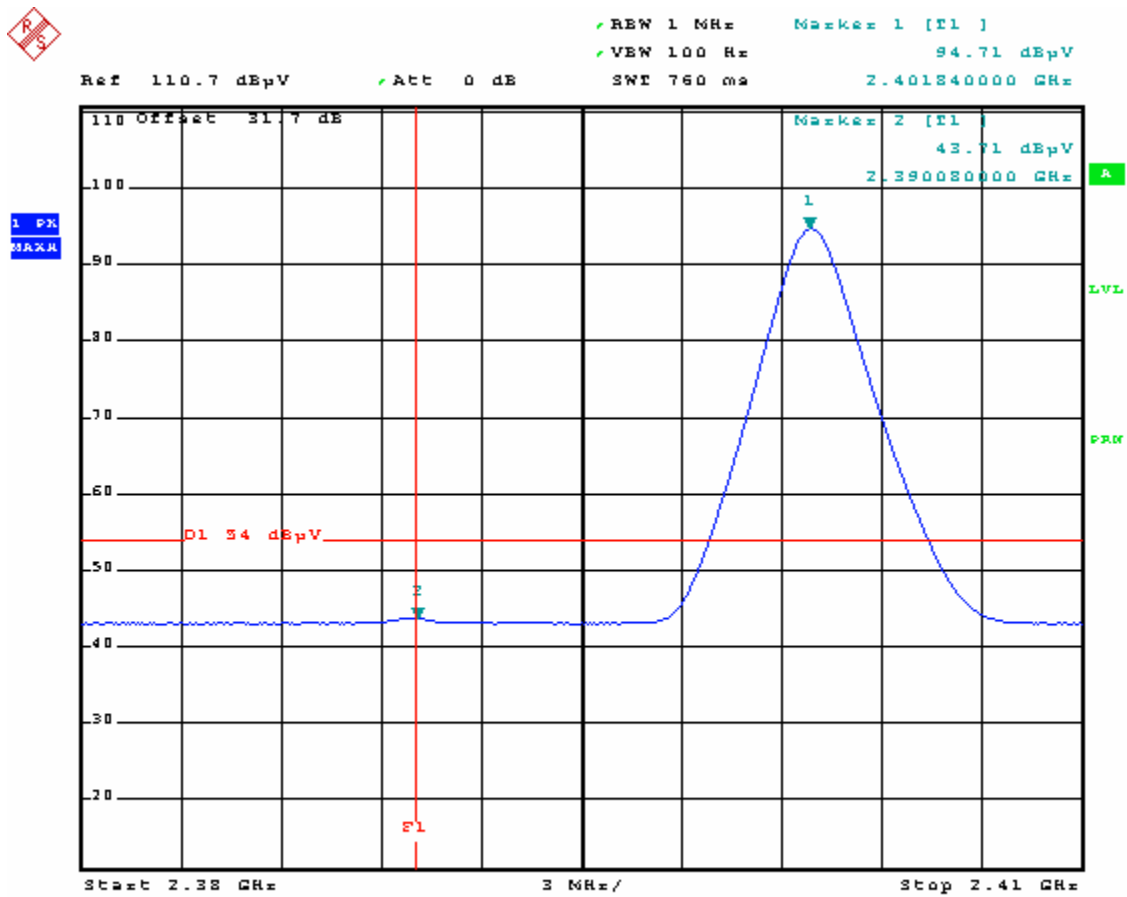

Comment: Emissions on band-edge frequency, average, freq 2402MHz  
 Date: 27.AUG.2008 16:39:44

Plot 8.4

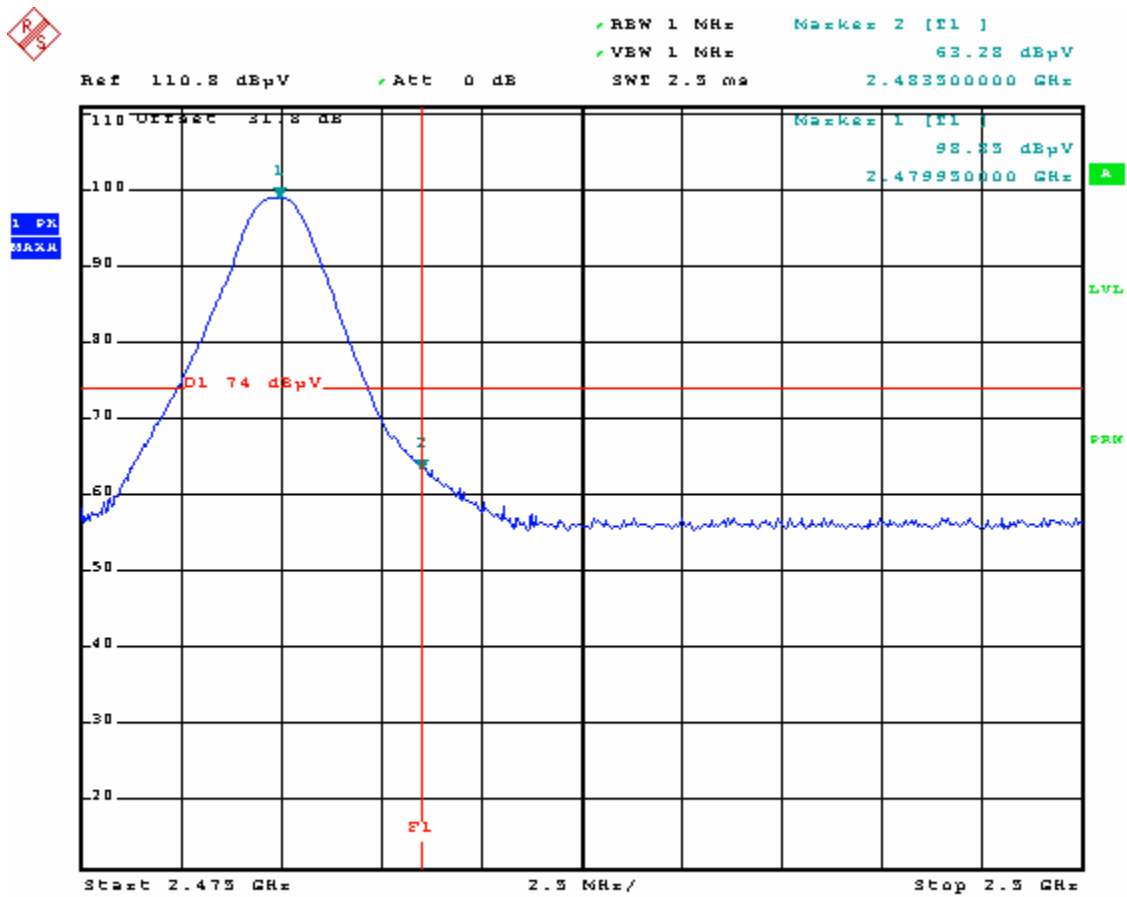

Comment: Emissions on band-edge frequency, peak, freq 2480MHz  
 Date: 27.AUG.2008 17:11:22



Plot 8.5

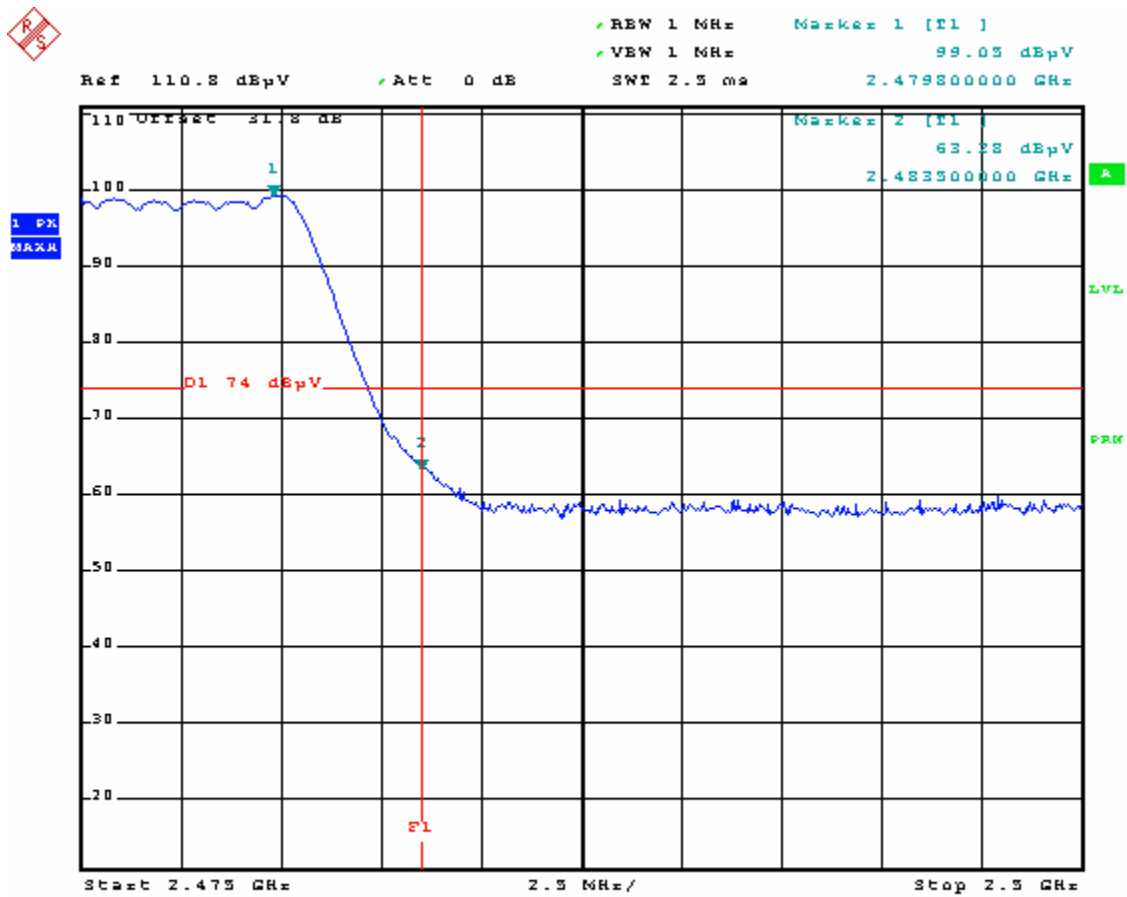

Comment: Emissions on band-edge frequency, peak, freq 2480MHz  
 Date: 27.AUG.2008 17:44:53

Plot 8.6

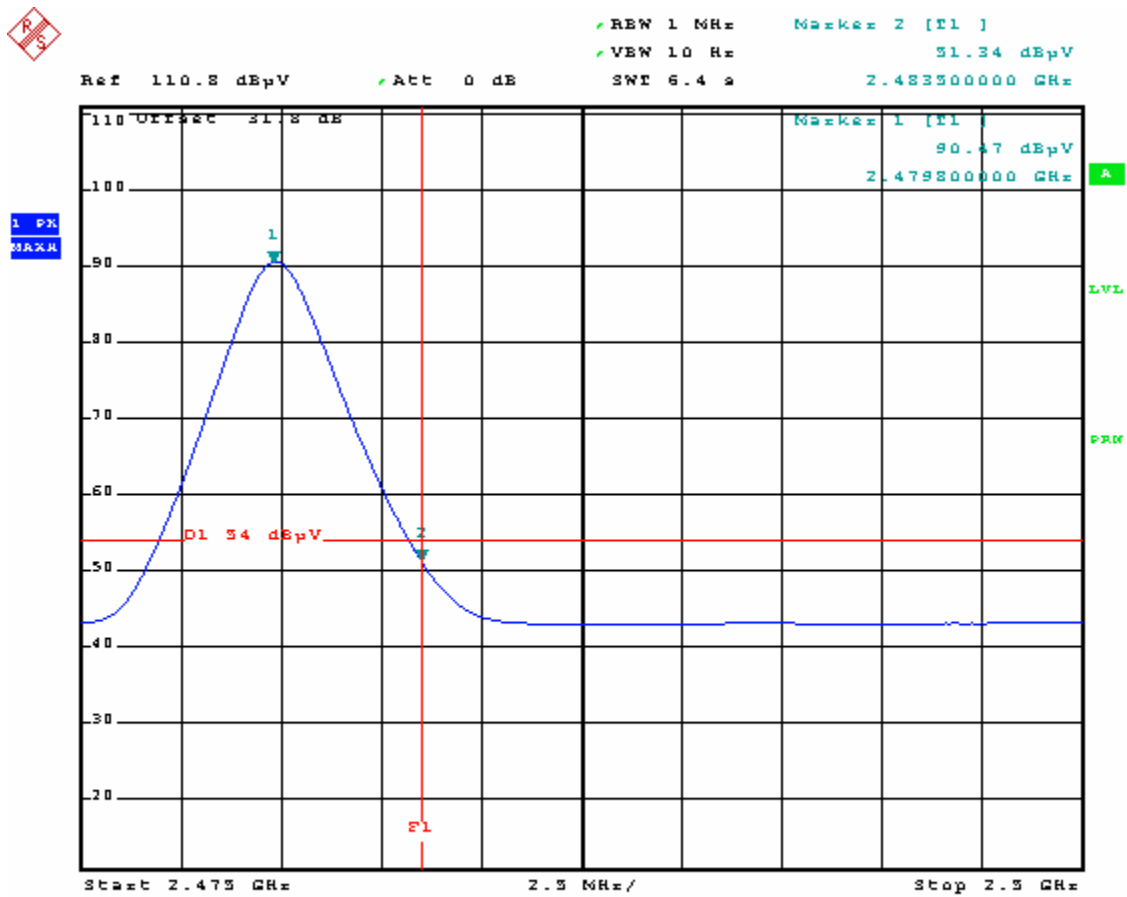

Comment: Emissions on band-edge frequency, average, freq 2480MHz  
 Date: 27.AUG.2008 17:52:20

4.9 Radiated Emissions from Digital Parts and Receiver  
FCC Ref: 15.109

Test Limit

*Limits for Electromagnetic Radiated Emissions, FCC Section 15.109(b) and ICES 003 \**

Frequency (MHz)	Class A at 10m dB(µV/m)	Class B at 3m dB(µV/m)
30-88	39	40.0
88-216	43.5	43.5
216-960	46.4	46.0
Above 960	49.5	54.0

\* According to FCC Part 15.109(g) an alternative to the radiated emission limits shown above, digital devices may be shown to comply with the limit of CISPR Pub. 22

Test Results

Radiated emission measurements were performed from 30 MHz to 1000 MHz. Spectrum Analyzer Resolution Bandwidth is 100 kHz or greater below 1000 MHz and 1 MHz - above 1000 MHz.

The EUT passed by 1.5 dB for Class B.

Intertek Testing Services  
 Radiated Emissions 30 MHz - 1000 MHz  
 FCC Part 15 Class B (Pk-Horizontal)

Operator: KK

Model Number: Advanced Control Pedal Master

04:45:16 PM, Tuesday, August 26, 2008

Company: Advanced Medical Optics

Frequency (MHz)	Peak FS dB(uV/m)	Limit@3m dB(uV/m)	Margin dB	RA dB(uV)	CF dB	AG dB	DCF dB	AF dB(1/m)
84.97	36.5	40.0	-3.5	50.0	0.9	32.0	10.5	7.1
88.00	34.3	40.0	-5.7	48.0	0.9	32.0	10.5	6.9
201.37	33.5	43.5	-10.0	43.8	1.5	32.0	10.5	9.7
246.63	32.9	46.0	-13.1	41.8	1.6	32.0	10.5	10.9
267.65	32.4	46.0	-13.6	40.2	1.7	32.0	10.5	12.0
326.66	35.2	46.0	-10.8	38.9	1.9	32.0	10.5	16.0
399.41	32.5	46.0	-13.5	35.7	2.1	32.1	10.5	16.3
466.50	34.3	46.0	-11.7	36.1	2.3	32.2	10.5	17.7
651.61	35.7	46.0	-10.3	34.5	2.7	32.5	10.5	20.5
931.29	36.8	46.0	-9.2	31.1	3.3	31.5	10.5	23.4

Test Mode: Rx mode

Temperature: 20 C

Humidity : 50 %

Intertek Testing Services  
Radiated Emissions 30 MHz - 1000 MHz  
FCC Part 15 Class B (Pk-Vertical)

Operator: KK

Model Number: Advanced Control Pedal Master

04:53:18 PM, Tuesday, August 26, 2008

Company: Advanced Medical Optics

Frequency (MHz)	Peak FS dB(uV/m)	Limit@3m dB(uV/m)	Margin dB	RA dB(uV)	CF dB	AG dB	DCF dB	AF dB(1/m)
80.93	38.4	40.0	-1.6	51.3	0.9	32.0	10.5	7.7
84.97	37.6	40.0	-2.4	51.0	0.9	32.0	10.5	7.2
88.00	37.4	40.0	-2.6	51.2	0.9	32.0	10.5	6.8
230.47	37.1	46.0	-8.9	45.5	1.6	32.0	10.5	11.5
267.65	37.5	46.0	-8.5	44.7	1.7	32.0	10.5	12.6
334.74	35.9	46.0	-10.1	40.3	1.9	32.0	10.5	15.2
399.41	35.7	46.0	-10.3	39.1	2.1	32.1	10.5	16.1
455.99	35.5	46.0	-10.5	37.8	2.3	32.2	10.5	17.1
465.69	35.4	46.0	-10.6	37.3	2.3	32.2	10.5	17.5
666.97	36.6	46.0	-9.4	35.1	2.7	32.5	10.5	20.8
692.03	35.4	46.0	-10.6	33.6	2.8	32.5	10.5	21.0
712.23	35.2	46.0	-10.8	33.1	2.8	32.5	10.5	21.3
762.35	36.0	46.0	-10.0	33.4	2.9	32.4	10.5	21.6
799.53	35.6	46.0	-10.4	33.1	3.0	32.4	10.5	21.4
846.42	35.4	46.0	-10.6	31.8	3.1	32.1	10.5	22.1

Test Mode: Rx mode

Temperature: 20 C

Humidity : 50 %

4.10 AC Line Conducted Emission  
FCC 15.207:

Not Applicable. The EUT does not have any direct connection to public power network. In normal use, EUT is installed inside the host unit and it is DC powered internally.

## 5.0 RF Exposure evaluation

The EUT is a Bluetooth device used in mobile application, at least 20 cm from any body part of the user or near by persons.

The maximum conducted power is 0.875 mW; antenna is fix-mounted, 1.8 dBi gain. Therefore, to comply with RF Exposure Requirement, the MPE is calculated.

The maximum Peak EIRP calculated is 1.22 dBm or 1.3 mW. Taking into consideration that two transmitters are transmitting simultaneously, the sum of EIRP is 2.6 mW

The Power Density can be calculated using the formula

$$S = \text{EIRP} / 4\pi D^2$$

Where: S is Power Density in  $\text{W}/\text{m}^2$   
D is the distance from the antenna.

It is considered that 20cm is the minimum distance that user can go closer to the EUT (Advanced Control Pedal Master) which is installed inside the Console of WhiteStar Signature Advanced Control Pedal system.

At 0.2 m,  $S = 0.0052 \text{ W}/\text{m}^2$ , which is below the MPE Limit of  $10 \text{ W}/\text{m}^2$

## 6.0 List of test equipment

Measurement equipment used for emission compliance testing utilized the equipment on the following list:

Equipment	Manufacturer	Model/Type	Serial #	Cal Int	Cal Due
EMI Receiver	Hewlett Packard	8546A	3710A00373	12	10/02/08
Spectrum Analyzer	R & S	FSP40	036612004	12	10/01/08
BI-Log Antenna	EMCO	3143	9509-1160	12	09/05/08
Horn Antenna	EMCO	3115	8812-3049	12	7/29/09
Pre-Amplifier	Sonoma Inst.	310	185634	12	09/26/08
Pre-Amplifier	Miteq	AMF-4D-001180-24-10P	799159	12	7/28/09

# No Calibration required



**7.0 Document History**

<b>Revision/ Job Number</b>	<b>Writer Initials</b>	<b>Date</b>	<b>Change</b>
1.0 / 3164295, 3164837	KK	October 01, 2008	Original document

## 8.0 Appendix A –Graphs for Duty cycle measurement

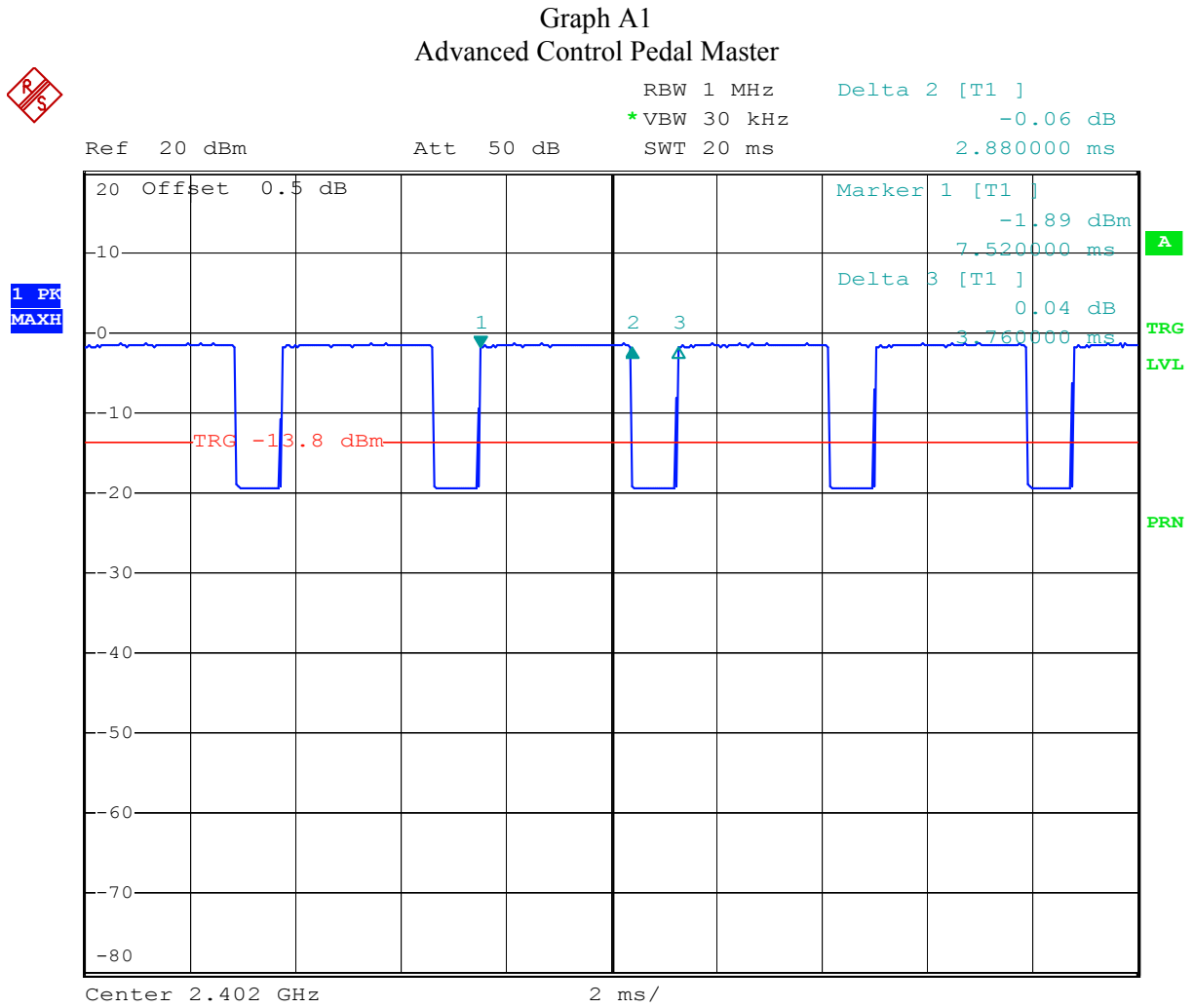

Comment: Duty cycle, freq 2402MHz, Tx1  
 Date: 28.AUG.2008 13:04:43

Graph A2  
Advanced Control Pedal Master



1 PK  
MAXH

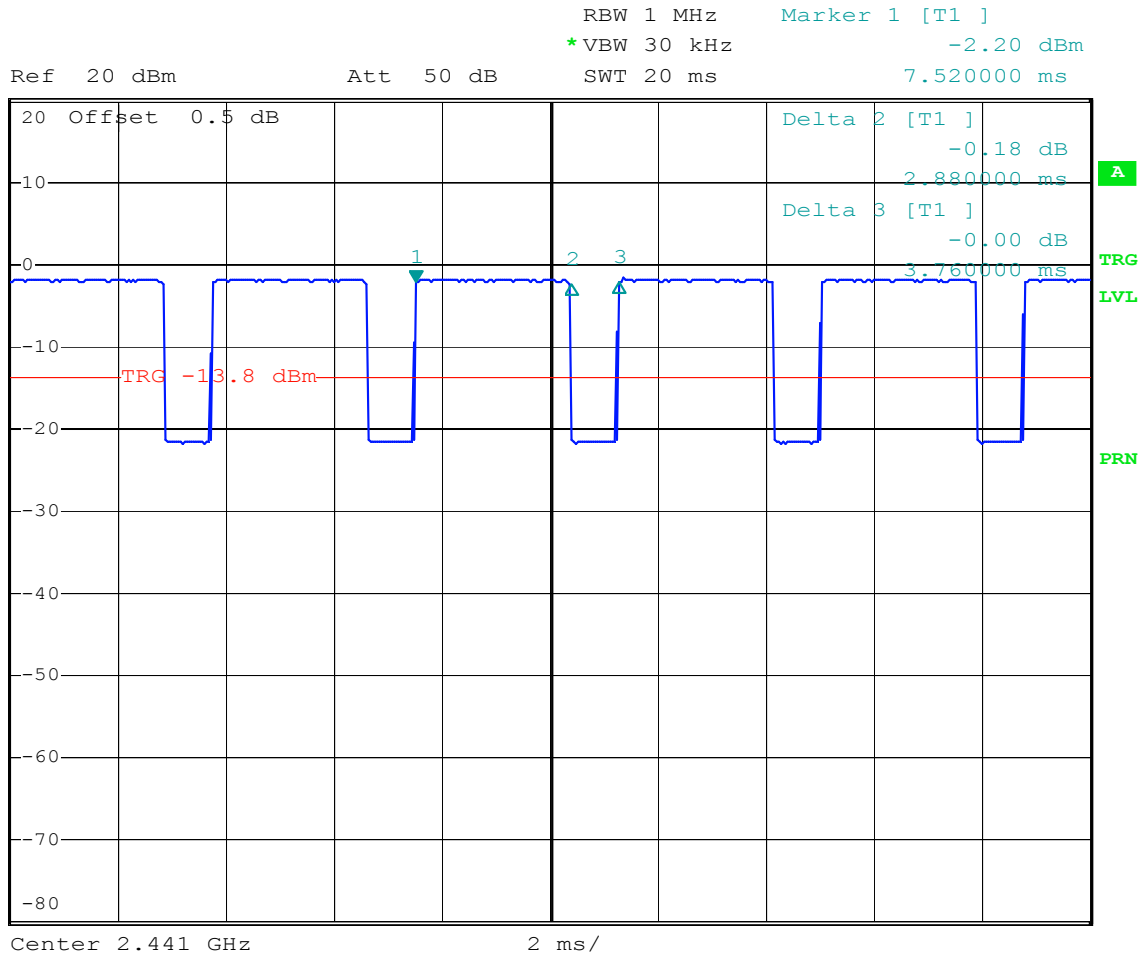

Comment: Duty cycle, freq 2441MHz, Tx1  
Date: 28.AUG.2008 13:07:31

Graph A3  
Advanced Control Pedal Master

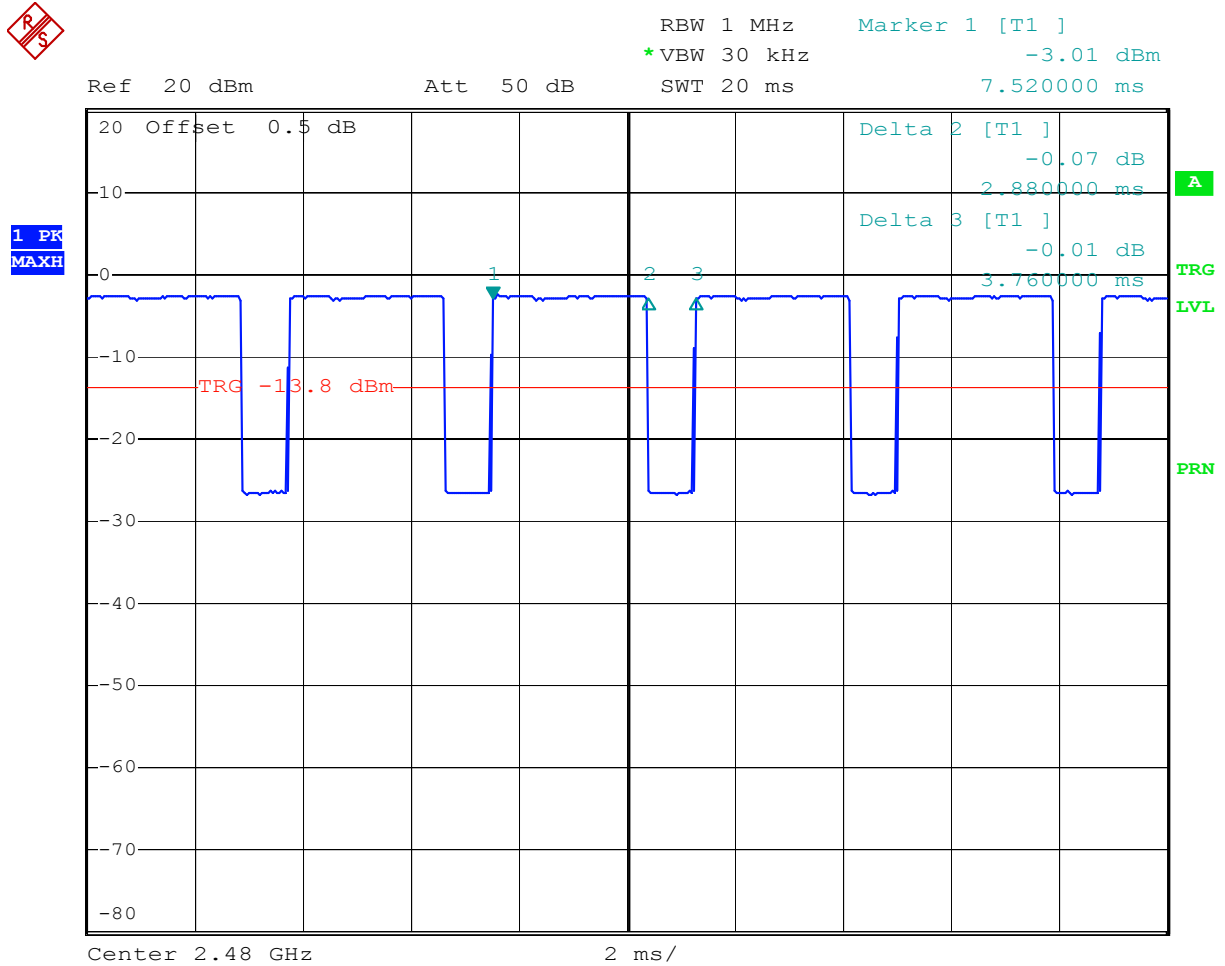

Comment: Duty cycle, freq 2480MHz, Tx1  
 Date: 28.AUG.2008 13:09:40