



# RF Exposure Report

(Part 2: Test Under Dynamic Transmission Condition)

**FCC ID** : V65E7200  
**Equipment** : Smartphone  
**Brand Name** : Kyocera  
**Model Name** : E7200  
**Applicant** : Kyocera Corporation % Kyocera International, Inc.  
8611 Balboa Avenue, San Diego, CA 92123  
**Manufacturer** : Kyocera Corporation  
2-1-1 Kagahara, Tsuzuki-ku, Yokohama-shi,  
Kanagawa 224-8502, Japan  
**Standard** : FCC 47 CFR Part 2 (2.1093)

We, SPORTON INTERNATIONAL INC., would like to declare that the tested sample has been evaluated in accordance with the test procedures and has been in compliance with the applicable technical standards.

The test results in this report apply exclusively to the tested model / sample. Without written approval of SPORTON INTERNATIONAL INC. Laboratory, the test report shall not be reproduced except in full.

Approved by: Cona Huang / Deputy Manager

**Sporton International Inc. EMC & Wireless Communications Laboratory**

No.52, Huaya 1st Rd., Guishan Dist., Taoyuan City 333, Taiwan



**Table of Contents**

**1. Introduction ..... 4**

**2. PD Time Averaging Validation Test Procedures ..... 5**

    2.1 Test sequence for validation in mmW NR transmission ..... 5

    2.2 Test configuration selection criteria for validating Smart Transmit feature ..... 5

    2.3 Test procedures for mmW radiated power measurements ..... 5

    2.4 Test procedure for time-varying PD measurements ..... 10

**3. Test Configurations ..... 12**

    3.1 LTE + mmW NR transmission ..... 12

**4. Radiated Power Test Results for mmW Smart Transmit Feature Validation ..... 13**

    4.1 Measurement Setup ..... 13

    4.2 mmW NR radiated power test results ..... 14

**5. PD Test Results for mmW Smart Transmit Feature Validation ..... 29**

    5.1 Measurement setup ..... 29

    5.2 PD measurement results for maximum power transmission scenario ..... 30

**6. Conclusions ..... 33**

**Appendix E. Plots of System Performance Check**

**Appendix F. DASY Calibration Certificate**

**Appendix G. Test Setup Photos**



### History of this test report

Report No.	Version	Description	Issued Date
FA332106	01	Initial issue of report	Apr. 07, 2023
FA332106	02	Update section4.2	Apr. 24, 2023



1. Introduction

The equipment under test (EUT) is a portable handset (FCC ID: V65E7200), it contains the Qualcomm modem supporting mmW 5G NR bands. Both of these modems are enabled with version19 Qualcomm Smart Transmit feature to control and manage transmitting power in real time and to ensure at all times the time-averaged RF exposure is in compliance with the FCC requirement.

This purpose of the Part 2 report is to demonstrate the EUT complies with FCC RF exposure requirement under Tx varying transmission scenarios, thereby validity of Qualcomm Smart Transmit feature for FCC equipment authorization

The P\_limit and input.power.limit used in this report is determined in Part 0 and Part 1 reports. Refer to PART 0 SAR AND POWER DENSITY CHAR REPORT, for product description and terminology used in this report.

Test Lab Information

Table with 2 columns: Test Firm Name, Test Firm Information, Date of Start during the Test, Date of End during the Test, Test Engineers, Report Producer. Rows include Sporton International Inc., contact info, dates (2023/3/23, 2023/3/27), and names (Steven Chang, Aaron Chen, Carlie Tsai).

## **2. PD Time Averaging Validation Test Procedures**

This chapter provides the test plan and test procedures for validating Qualcomm Smart Transmit feature for mmW transmission. For this EUT, millimeter wave (mmW) transmission is only in non-standalone mode, i.e., it requires an LTE link as anchor.

### **2.1 Test sequence for validation in mmW NR transmission**

In 5G mmW NR transmission, the test sequence for validation is with the callbox requesting EUT's Tx power in 5G mmW NR at maximum power all the time.

### **2.2 Test configuration selection criteria for validating Smart Transmit feature**

#### **2.2.1 Test configuration selection for time-varying Tx power transmission**

The Smart Transmit time averaging feature operation is independent of bands, modes, channels, and antenna configurations (beams) for a given technology. Hence, validation of Smart Transmit in any one band/mode/channel per technology is sufficient.

#### **2.2.2 Test configuration selection for change in antenna configuration (beam)**

The Smart Transmit time averaging feature operation is independent of bands, modes, channels, and antenna configurations (beams) for a given technology. Hence, validation of Smart Transmit with beam switch between any two beams is sufficient.

#### **2.2.3 Test configuration selection for SAR vs. PD exposure switch during transmission**

The Smart Transmit time averaging feature operation is independent of the nature of exposure (SAR vs. PD) and ensures total time-averaged RF exposure compliance. Hence, validation of Smart Transmit in any one band/mode/channel/beam for mmW + sub-6 (LTE) transmission is sufficient, where the exposure varies among SAR dominant scenario, SAR+PD scenario, and PD dominant scenario.

### **2.3 Test procedures for mmW radiated power measurements**

Perform conducted power measurement (for  $f < 6\text{GHz}$ ) and radiated power measurement (for  $f > 6\text{GHz}$ ) for LTE + mmW transmission to validate Smart Transmit time averaging feature in the various transmission scenarios described in Section 2.

This section provides general conducted power measurement procedures to perform compliance test under dynamic transmission scenarios described in Section 2. In practice, an adjustment can be made in these procedures. The justification/clarification may be provided.

#### **2.3.1 Time-varying Tx power scenario**

The purpose of the test is to demonstrate the effectiveness of power limiting enforcement and that the time-averaged Tx power when converted into RF exposure values does not exceed the FCC limit at all times (see Eq. (2a), (2b) & (2c) in Section 2).

#### **Test procedure:**

1. Measure conducted Tx power corresponding to  $P_{limit}$  for LTE in selected band, and measure radiated Tx power corresponding to *input.power.limit* in desired mmW band/channel/beam by following below steps:
  - a. Measure radiated power corresponding to mmW *input.power.limit* by setting up the EUT's Tx power in desired band/channel/beam at *input.power.limit* in Factory Test Mode (FTM). This test is performed in a calibrated anechoic chamber. Rotate the EUT to obtain maximum radiated Tx power, keep the EUT in this

- position and do not disturb the position of the EUT inside the anechoic chamber for the rest of this test.
- b. Reset EUT to place in online mode and establish radio link in LTE, measure conducted Tx power corresponding to LTE  $P_{limit}$  with Smart Transmit enabled and *Reserve\_power\_margin* set to 0 dB, callbox set to request maximum power.
2. Set *Reserve\_power\_margin* to actual (intended) value and reset power on EUT to enable Smart Transmit. With EUT setup for a mmW NR call in the desired/selected LTE band and mmW NR band, perform the following steps:
    - a. Establish LTE and mmW NR connection in desired band/channel/beam used in Step 1. As soon as the mmW connection is established, immediately request all-down bits on LTE link. With callbox requesting EUT's Tx power to be at maximum mmW power to test predominantly PD exposure scenario (as SAR exposure is less when LTE's Tx power is at low power).
    - b. After 120s, request LTE to go all-up bits for at least 100s. SAR exposure is dominant. There are two scenarios:
      - i. If  $P_{limit} < P_{max}$  for LTE, then the RF exposure margin (provided to mmW NR) gradually runs out (due to high SAR exposure). This results in gradual reduction in the 5G mmW NR transmission power and eventually seized 5G mmW NR transmission when LTE goes to  $P_{reserve}$  level.
      - ii. If  $P_{limit} \geq P_{max}$  for LTE, then the 5G mmW NR transmission's averaged power should gradually reduce but the mmW NR connection can sustain all the time (assuming TxAGC uncertainty = 0dB).
    - c. Record the conducted Tx power of LTE and radiated Tx power of mmW for the full duration of this test of at least 300s.
  3. Once the measurement is done, extract instantaneous Tx power versus time for both LTE and mmW links. Convert the conducted Tx power for LTE into 1gSAR or 10gSAR value using Eq. (2a) and  $P_{limit}$  measured in Step 1.b, and then divide by FCC limit of 1.6 W/kg for 1gSAR or 4.0 W/kg for 10gSAR to obtain instantaneous normalized 1gSAR or 10gSAR versus time. Perform 100s running average to determine normalized 100s-averaged 1gSAR or 10gSAR versus time.

**NOTE:** In Eq.(2a), instantaneous Tx power is converted into instantaneous 1gSAR or 10gSAR value by applying the measured worst-case 1gSAR or 10gSAR value at  $P_{limit}$  for the corresponding technology/band/antenna/DSI reported in Part 1 report.

4. Similarly, convert the radiated Tx power for mmW into 4cm<sup>2</sup>PD value using Eq. (2b) and the radiated Tx power limit (i.e., radiated Tx power at *input.power.limit*) measured in Step 1.a, then divide by FCC 4cm<sup>2</sup>PD limit of 10W/m<sup>2</sup> to obtain instantaneous normalized 4cm<sup>2</sup>PD versus time. Perform 4s running average to determine normalized 4s-averaged 4cm<sup>2</sup>PD versus time.

**NOTE:** In Eq.(2b), instantaneous radiated Tx power is converted into instantaneous 4cm<sup>2</sup>PD by applying the worst-case 4cm<sup>2</sup>PD value measured at *input.power.limit* for the selected band/beam in Part 1 report.

5. Make one plot containing: (a) instantaneous conducted Tx power for LTE versus time, (b) computed 100s-averaged conducted Tx power for LTE versus time, (c)

instantaneous radiated Tx power for mmW versus time, as measured in Step 2, (d) computed 4s-averaged radiated Tx power for mmW versus time, and (e) time-averaged conducted and radiated power limits for LTE and mmW radio using Eq. (5a) & (5b), respectively:

$$\text{Time averaged LTE power limit} = \text{meas. } P_{\text{limit}} + 10 \times \log\left(\frac{\text{FCC SAR limit}}{\text{meas.SAR\_Plimit}}\right) \quad (5a)$$

$$\text{Time averaged mmW NR power limit} = \text{meas. EIRP}_{\text{input.power.limit}} + 10 \times \log\left(\frac{\text{FCC PD limit}}{\text{meas.PD\_input.power.limit}}\right) \quad (5b)$$

where  $\text{meas. EIRP}_{\text{input.power.limit}}$  and  $\text{meas. PD\_input.power.limit}$  correspond to measured EIRP at  $\text{input.power.limit}$  and measured power density at  $\text{input.power.limit}$ .

6. Make another plot containing: (a) computed normalized 100s-averaged 1gSAR or 10gSAR versus time determined in Step 3, (b) computed normalized 4s-averaged 4cm<sup>2</sup>PD versus time determined in Step 4, and (c) corresponding total normalized time-averaged RF exposure (sum of steps (6.a) and (6.b)) versus time.

The validation criteria are, at all times, the total normalized time-averaged RF exposure versus time determined in Step 6.c shall not exceed the normalized limit of 1.0 of FCC requirement (i.e., Eq. (2c)).

### 2.3.2 Switch in SAR vs. PD exposure during transmission

This test is to demonstrate that Smart Transmit feature is independent of the nature of exposure (SAR vs. PD), accurately accounts for switching in exposures among SAR dominant, SAR+PD, and PD dominant scenarios, and ensures total time-averaged RF exposure compliance.

#### Test procedure:

1. Measure conducted Tx power corresponding to  $P_{\text{limit}}$  for LTE in selected band, and measure radiated Tx power corresponding to  $\text{input.power.limit}$  in desired mmW band/channel/beam by following below steps:
  - a. Measure radiated power corresponding to  $\text{input.power.limit}$  by setting up the EUT's Tx power in desired band/channel/beam at  $\text{input.power.limit}$  in FTM. This test is performed in a calibrated anechoic chamber. Rotate the EUT to obtain maximum radiated Tx power, keep the EUT in this position and do not disturb the position of the EUT inside the anechoic chamber for the rest of this test.
  - b. Reset EUT to place in online mode and establish radio link in LTE, measure conducted Tx power corresponding to LTE  $P_{\text{limit}}$  with Smart Transmit enabled and  $\text{Reserve\_power\_margin}$  set to 0 dB, callbox set to request maximum power.
2. Set  $\text{Reserve\_power\_margin}$  to actual (intended) value and reset power in EUT, with EUT setup for LTE + mmW call, perform the following steps:
  - a. Establish LTE (sub-6) and mmW NR connection with callbox.
  - b. As soon as the mmW connection is established, immediately request all-down bits on LTE link. Continue LTE (all-down bits) + mmW transmission for more than 100s duration to test predominantly PD exposure scenario (as SAR exposure is negligible from all-down bits in LTE).
  - c. After 120s, request LTE to go all-up bits, mmW transmission should gradually run out of RF exposure margin if LTE's  $P_{\text{limit}} < P_{\text{max}}$  and seize mmW transmission

(SAR only scenario); or mmW transmission should gradually reduce in Tx power and will sustain the connection if LTE's  $P_{limit} > P_{max}$ .

- d. After 120s, request LTE to go all-down bits, mmW transmission should start getting back RF exposure margin and resume transmission again.
  - e. Record the conducted Tx power of LTE and radiated Tx power of mmW for the entire duration of this test of at least 300s.
3. Once the measurement is done, extract instantaneous Tx power versus time for both LTE and mmW links. Convert the conducted Tx power for LTE into 1gSAR or 10gSAR value using Eq. (2a) and  $P_{limit}$  measured in Step 1.b, and then divide by FCC limit of 1.6 W/kg for 1gSAR or 4.0 W/kg for 10gSAR to obtain instantaneous normalized 1gSAR or 10gSAR versus time. Perform 100s running average to determine normalized 100s-averaged 1gSAR or 10gSAR versus time.

**NOTE:** In Eq.(2a), instantaneous Tx power is converted into instantaneous 1gSAR or 10gSAR value by applying the measured worst-case 1gSAR or 10gSAR value at  $P_{limit}$  for the corresponding technology/band/antenna/DSI reported in Part 1 report.

4. Similarly, convert the radiated Tx power for mmW into 4cm<sup>2</sup>PD value using Eq. (2b) and the radiated Tx power limit (i.e., radiated Tx power at *input.power.limit*) measured in Step 1.a, then divide this by FCC 4cm<sup>2</sup>PD limit of 10W/m<sup>2</sup> to obtain instantaneous normalized 4cm<sup>2</sup>PD versus time. Perform 4s running average to determine normalized 4s-averaged 4cm<sup>2</sup>PD versus time.

**NOTE:** In Eq.(2b), instantaneous radiated Tx power is converted into instantaneous 4cm<sup>2</sup>PD by applying the worst-case 4cm<sup>2</sup>PD value measured at *input.power.limit* for the selected band/beam in Part 1 report.

5. Make one plot containing: (a) instantaneous conducted Tx power for LTE versus time, (b) computed 100s-averaged conducted Tx power for LTE versus time, (c) instantaneous radiated Tx power for mmW versus time, as measured in Step 2, (d) computed 4s-averaged radiated Tx power for mmW versus time, and (e) time-averaged conducted and radiated power limits for LTE and mmW radio using Eq. (5a) & (5b), respectively.
6. Make another plot containing: (a) computed normalized 100s-averaged 1gSAR or 10gSAR versus time determined in Step 3, (b) computed normalized 4s-averaged 4cm<sup>2</sup>PD versus time determined in Step 4, and (c) corresponding total normalized time-averaged RF exposure (sum of steps (6.a) and (6.b)) versus time.

The validation criteria are, at all times, the total normalized time-averaged RF exposure versus time determined in Step 6.c shall not exceed the normalized limit of 1.0 of FCC requirement (i.e., Eq. (2c)).

### 2.3.3 Change in antenna configuration (beam)

This test is to demonstrate the correct power control by Smart Transmit during changes in antenna configuration (beam). Since the *input.power.limit* varies with beam, the Eq. (2a), (2b) and (2c) in Section 2 are written as below for transmission scenario having change in beam,

$$1g\_or\_10gSAR(t) = \frac{conducted\_Tx\_power(t)}{conducted\_Tx\_power\_P_{limit}} * 1g\_or\_10gSAR\_P_{limit} \quad (8a)$$



$$4cm^2 PD_1(t) = \frac{radiated\_Tx\_power\_1(t)}{radiated\_Tx\_power\_input.power.limit\_1} * 4cm^2 PD\_input.power.limit\_1 \quad (8b)$$

$$4cm^2 PD_2(t) = \frac{radiated\_Tx\_power\_2(t)}{radiated\_Tx\_power\_input.power.limit\_2} * 4cm^2 PD\_input.power.limit\_2 \quad (8c)$$

$$\frac{\frac{1}{T_{SAR}} \int_{t-T_{SAR}}^t 1g\_or\_10gSAR(t)dt}{FCC SAR limit} + \frac{\frac{1}{T_{PD}} \left[ \int_{t-T_{PD}}^{t_1} 4cm^2 PD_1(t)dt + \int_{t_1}^t 4cm^2 PD_2(t)dt \right]}{FCC 4cm^2 PD limit} \leq 1 \quad (8d)$$

where,  $conducted\_Tx\_power(t)$ ,  $conducted\_Tx\_power\_P_{limit}$ , and  $1g\_or\_10gSAR\_P_{limit}$  correspond to the measured instantaneous conducted Tx power, measured conducted Tx power at  $P_{limit}$ , and measured  $1gSAR$  or  $10gSAR$  values at  $P_{limit}$  corresponding to LTE transmission. Similarly,  $radiated\_Tx\_power\_1(t)$ ,  $radiated\_Tx\_power\_input.power.limit\_1$ , and  $4cm^2 PD\_input.power.limit\_1$  correspond to the measured instantaneous radiated Tx power, radiated Tx power at  $input.power.limit$ , and  $4cm^2 PD$  value at  $input.power.limit$  of beam 1;  $radiated\_Tx\_power\_2(t)$ ,  $radiated\_Tx\_power\_input.power.limit\_2$ , and  $4cm^2 PD\_input.power.limit\_2$  correspond to the measured instantaneous radiated Tx power, radiated Tx power at  $input.power.limit$ , and  $4cm^2 PD$  value at  $input.power.limit$  of beam 2 corresponding to mmW transmission.

### Test procedure:

1. Measure conducted Tx power corresponding to  $P_{limit}$  for LTE in selected band, and measure radiated Tx power corresponding to  $input.power.limit$  in desired mmW band/channel/beam by following below steps:
  - a. Measure radiated power corresponding to mmW  $input.power.limit$  by setting up the EUT's Tx power in desired band/channel at  $input.power.limit$  of beam 1 in FTM. Do not disturb the position of the EUT inside the anechoic chamber for the rest of this test. Repeat this Step 1.a for beam 2.
  - b. Reset EUT to place in online mode and establish radio link in LTE, measure conducted Tx power corresponding to LTE  $P_{limit}$  with Smart Transmit enabled and  $Reserve\_power\_margin$  set to 0 dB, callbox set to request maximum power.
2. Set  $Reserve\_power\_margin$  to actual (intended) value and reset power in EUT, With EUT setup for LTE + mmW connection, perform the following steps:
  - a. Establish LTE (sub-6) and mmW NR connection in beam 1. As soon as the mmW connection is established, immediately request all-down bits on LTE link with the callbox requesting EUT's Tx power to be at maximum mmW power.
  - b. After beam 1 continues transmission for at least 20s, request the EUT to change from beam 1 to beam 2, and continue transmitting with beam 2 for at least 20s.
  - c. Record the conducted Tx power of LTE and radiated Tx power of mmW for the entire duration of this test.
3. Once the measurement is done, extract instantaneous Tx power versus time for both LTE and mmW links. Convert the conducted Tx power for LTE into  $1gSAR$  or  $10gSAR$  value using the similar approach described in Step 3 of Section 2.3.2. Perform 100s running average to determine normalized 100s-averaged  $1gSAR$  versus time.

4. Similarly, convert the radiated Tx power for mmW NR into  $4\text{cm}^2\text{PD}$  value using Eq. (8b), (8c) and the radiated Tx power limits (i.e., radiated Tx power at *input.power.limit*) measured in Step 1.a for beam 1 and beam 2, respectively, and then divide the resulted PD values by FCC  $4\text{cm}^2\text{PD}$  limit of  $10\text{W}/\text{m}^2$  to obtain instantaneous normalized  $4\text{cm}^2\text{PD}$  versus time for beam 1 and beam 2. Perform 4s running average to determine normalized 4s-averaged  $4\text{cm}^2\text{PD}$  versus time.

**NOTE:** In Eq.(8b) and (8c), instantaneous radiated Tx power of beam 1 and beam 2 is converted into instantaneous  $4\text{cm}^2\text{PD}$  by applying the worst-case  $4\text{cm}^2\text{PD}$  value measured at the *input.power.limit* of beam 1 and beam 2 in Part 1 report, respectively.

5. Since the measured radiated powers for beam 1 and beam 2 in Step 1.a were performed at an arbitrary rotation of EUT in anechoic chamber, repeat Step 1.a of this procedure by rotating the EUT to determine maximum radiated power at *input.power.limit* in FTM mode for both beams separately. Re-scale the measured instantaneous radiated power in Step 2.c by the delta in radiated power measured in Step 5 and the radiated power measured in Step 1.a for plotting purposes in next Step. In other words, this step essentially converts measured instantaneous radiated power during the measurement in Step 2 into maximum instantaneous radiated power for both beams. Perform 4s running average to compute 4s-averaged radiated Tx power. Additionally, use these EIRP values measured at *input.power.limit* at respective peak locations to determine the EIRP limits (using Eq. (5b)) for both these beams.
6. Make one plot containing: (a) instantaneous conducted Tx power for LTE versus time, (b) computed 100s-averaged conducted Tx power for LTE versus time, (c) instantaneous radiated Tx power for mmW versus time, as obtained in Step 5, (d) computed 4s-averaged radiated Tx power for mmW versus time, as obtained in Step 5, and (e) time-averaged conducted and radiated power limits for LTE and mmW radio, respectively.
7. Make another plot containing: (a) computed normalized 100s-averaged 1gSAR versus time determined in Step 3, (b) computed normalized 4s-averaged  $4\text{cm}^2\text{PD}$  versus time determined in Step 4, and (c) corresponding total normalized time-averaged RF exposure (sum of steps (6.a) and (6.b)) versus time.

The validation criteria are, at all times, the total normalized time-averaged RF exposure versus time determined in Step 6.c shall not exceed the normalized limit of 1.0 of FCC requirement (i.e., (8d)).

## **2.4 Test procedure for time-varying PD measurements**

The following steps are used to perform the validation through PD measurement for transmission scenario 1 described in Section 2:

1. Place the EUT on the cDASY6 platform to perform PD measurement in the worst-case position/surface for the selected mmW band/beam. In PD measurement, the callbox is set to request maximum Tx power from EUT all the time. Hence, "path loss" calibration between callbox antenna and EUT is not needed in this test.
2. Time averaging feature validation:
  - a. Measure conducted Tx power corresponding to  $P_{limit}$  for LTE in selected band, and measure point E-field corresponding to *input.power.limit* in desired mmW band/channel/beam by following the below steps:

- i. Measure conducted Tx power corresponding to LTE  $P_{limit}$  with Smart Transmit enabled and *Reserve\_power\_margin* set to 0 dB, with callbox set to request maximum power.
  - ii. Measure point E-field at peak location of fast area scan corresponding to *input.power.limit* by setting up the EUT's Tx power in desired mmW band/channel/beam at *input.power.limit* in FTM. Do not disturb the position of EUT and mmW cDASY6 probe.
- b. Set *Reserve\_power\_margin* to actual value (i.e., intended value) and reset power on EUT, place EUT in online mode. With EUT setup for LTE (sub-6) + mmW NR call, as soon as the mmW NR connection is established, request all-down bits on LTE link. Continue LTE (all-down bits) + mmW transmission for more than 100s duration to test predominantly PD exposure scenario. After 120s, request LTE to go all-up bits, mmW transmission should gradually reduce. Simultaneously, record the conducted Tx power of LTE transmission using power meter and point E-field (in terms of ratio of  $\frac{[pointE(t)]^2}{[pointE\_input.power.limit]^2}$ ) of mmW transmission using cDASY6 E-field probe at peak location identified in Step 2.a.ii for the entire duration of this test of at least 300s.
- c. Once the measurement is done, extract instantaneous conducted Tx power versus time for LTE transmission and  $\frac{[pointE(t)]^2}{[pointE\_input.power.limit]^2}$  ratio versus time from cDASY6 system for mmW transmission. Convert the conducted Tx power for LTE into 1gSAR or 10gSAR value using Eq. (4a) and  $P_{limit}$  measured in Step 2.a.i, and then divide this by FCC limit of 1.6 W/kg for 1gSAR or 4.0 W/kg for 10gSAR to obtain instantaneous normalized 1gSAR or 10gSAR versus time. Perform 100s running average to determine normalized 100s-averaged 1gSAR or 10gSAR versus time

**NOTE:** In Eq.(4a), instantaneous Tx power is converted into instantaneous 1gSAR or 10gSAR value by applying the measured worst-case 1gSAR or 10gSAR value at  $P_{limit}$  for the corresponding technology/band reported in Part 1 report.

- d. Similarly, convert the point E-field for mmW transmission into  $4cm^2PD$  value using Eq. (4b) and radiated power limit measured in Step 2.a.ii, and then divide this by FCC  $4cm^2PD$  limit of  $10W/m^2$  to obtain instantaneous normalized  $4cm^2PD$  versus time. Perform 4s running average to determine normalized 4s-averaged  $4cm^2PD$  versus time.
- e. Make one plot containing: (i) computed normalized 100s-averaged 1gSAR or 10gSAR versus time determined in Step 2.c, (ii) computed normalized 4s-averaged  $4cm^2PD$  versus time determined in Step 2.d, and (iii) corresponding total normalized time-averaged RF exposure (sum of steps (2.e.i) and (2.e.ii)) versus time.

The validation criteria are, at all times, the total normalized time-averaged RF exposure versus time determined in Step 2.e.iii shall not exceed the normalized limit of 1.0 of FCC requirement (i.e., Eq. (4c)).



### 3. Test Configurations

#### 3.1 LTE + mmW NR transmission

Based on the selection criteria described in Section 2.2, the selections for LTE and mmW NR validation test are listed in Table 5-3. The radio configurations used in this test are listed in Table 5-4.

**Table 5-3: Selections for LTE + mmW NR validation measurements**

Transmission Scenario	Test	Technology and Band	mmW Beam
Time-varying Tx power test	1. Cond. & Rad. Power meas.	LTE Band 2 and n260	Beam ID 36
		LTE Band 2 and n261	Beam ID 24
Switch in SAR vs. PD	1. Cond. & Rad. Power meas.	LTE Band 2 and n260	Beam ID 36
		LTE Band 2 and n261	Beam ID 24
Beam switch test	1. Cond. & Rad. Power meas.	LTE Band 2 and n260	Beam ID 36 to Beam ID 4
		LTE Band 2 and n261	Beam ID 24 to Beam ID 4

**Table 5-4: Test configuration for LTE + mmW NR validation**

Tech	Band	Beam ID	Antenna	DSI	Mode	UL Duty Cycle
LTE	2	-	0	4	QPSK	100%
mmW NR	N260	36,4	QTM#1	--	CP-OFDM, QPSK	>75%
	N261	24,4	QTM#1	--	CP-OFDM, QPSK	>75%

\* mmW NR callbox UL duty cycle should be configured to be greater than 75% for all LTE+mmW NR Part 2 tests. The base station uplink is configured in 76 slots among total 79 slots.

## 4. Radiated Power Test Results for mmW Smart Transmit Feature Validation

### 4.1 Measurement Setup

The Keysight Technologies E7515B UXM callbox is used in this test. The test setup is shown in Figure 8-1a and the schematic of the setup is shown in Figure 8-1b (see Appendix E for missing figures). The UXM callbox has two RF radio heads to up/down convert IF to mmW frequencies, which in turn are connected to two horn antennas for V- and H-polarizations for downlink communication. In the uplink, a directional coupler is used in the path of one of the horn antennas to measure and record radiated power using a Rohde & Schwarz NR50S power sensor. Note here that the isolation of the directional coupler may not be sufficient to attenuate the downlink signal from the callbox, which will result in high noise floor masking the recording of radiated power from EUT. In that case, either lower the downlink signal strength emanating from the RF radio heads of callbox or add an attenuator between callbox radio heads and directional coupler. Additionally, note that since the measurements performed in this validation are all relative, measurement of EUT's radiated power in one polarization is sufficient. The EUT is placed inside an anechoic chamber with V- and H-pol horn antennas to establish the radio link as shown in Figure 8-1. The callbox's LTE port is directly connected to the EUT's RF port via a directional coupler to measure the EUT's conducted Tx power using a Rohde & Schwarz NR8S power sensor. Additionally, EUT is connected to the PC via USB connection for sending beam switch command. Care is taken to route the USB cable and RF cable (for LTE connection) away from the EUT's mmW antenna modules.

Setup in Figure 8-1 is used for the test scenario 1, 5 and 6 described in Section 2. The test procedures described in Section 2 are followed. The path losses from the EUT to both the power meters are calibrated and used as offset in the power meter.

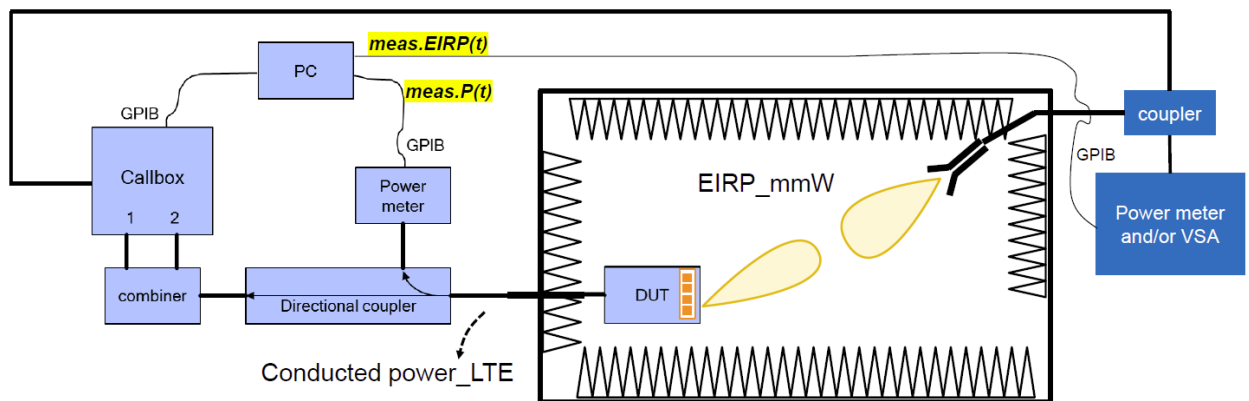

Figure 8-1 mmW NR radiated power measurement setup

Both the callbox and power meters are connected to the PC using USB cables. Test scripts are custom made for automation of establishing LTE + mmW call, conducted Tx power recording for LTE and radiated Tx power recording for mmW. These tests are manually stopped after desired time duration. Test script is programmed to set LTE Tx power to all-down bits on the callbox immediately after the mmW link is established, and programmed to set toggle between all-up and all-down bits depending on the transmission scenario being evaluated. Similarly, test script is also programmed to send beam switch command manually to the EUT via USB connection. For all the tests, the callbox is set to request maximum Tx power in mmW NR radio from EUT all the time.

Test configurations for this validation are detailed in Section 5.2. Test procedures are listed in Section 2.3.

**4.2 mmW NR radiated power test results**

To demonstrate the compliance, the conducted Tx power of LTE B2 in DSI = 4 is converted to 1gSAR exposure by applying the corresponding worst-case 1gSAR value at  $P_{limit}$  as reported in Part 1 report and listed in Table 8-1 of this report.

Similarly, following Step 4 in Section 2.3.1, radiated Tx power of mmW Band n260 and n261 for the beams tested is converted by applying the corresponding worst-case 4cm<sup>2</sup>PD values from Part 1 report, and listed in below Table 8-1. Qualcomm Smart Transmit feature operates based on time-averaged Tx power reported on a per symbol basis, which is independent of modulation, channel and bandwidth (RBs), therefore the worst-case 4cm<sup>2</sup>PD was conducted with the EUT in FTM mode, with CW modulation and 100% duty cycle. cDASY6 system verification for power density measurement is provided in Appendix D and E, and the associated SPEAG certificates are attached in Appendix F.

Both the worst-case 1gSAR and 4cm<sup>2</sup>PD values used in this section are listed in Table 8-1. The measured EIRP at *input.power.limit* for the beams tested in this section are also listed in Table 8-1.

**Table 8-1: Worst-case 1gSAR, 4cm<sup>2</sup> avg. PD and EIRP measured at *input.power.limit* for the selected configurations**

Tech	Band	Antenna	Beam ID	Input.power.limit (dBm)	Meas. 4cm <sup>2</sup> PD		Meas. EIRP at Input.power.limit (dBm)
					at Input.power.limit (W/m <sup>2</sup> )	configuration	
mmW NR	N260	QTM#1	36	2.55	2.88	Rear Face	11.53
			4	6	1.27	Rear Face	3.99
mmW NR	N261	QTM#1	24	-0.34	2.21	Rear Face	10
			4	6	1.47	Rear Face	8.09

Tech	Band	Antenna	DSI	Meas. Plimit (dBm)	Meas. 1gSAR	
					At Plimit (W/kg)	configuration
LTE	2	0	4	23	1	Rear face

The 4cm<sup>2</sup>-averaged PD distributions for the highest PD value per band, as listed in Table 8-1, are plotted below:

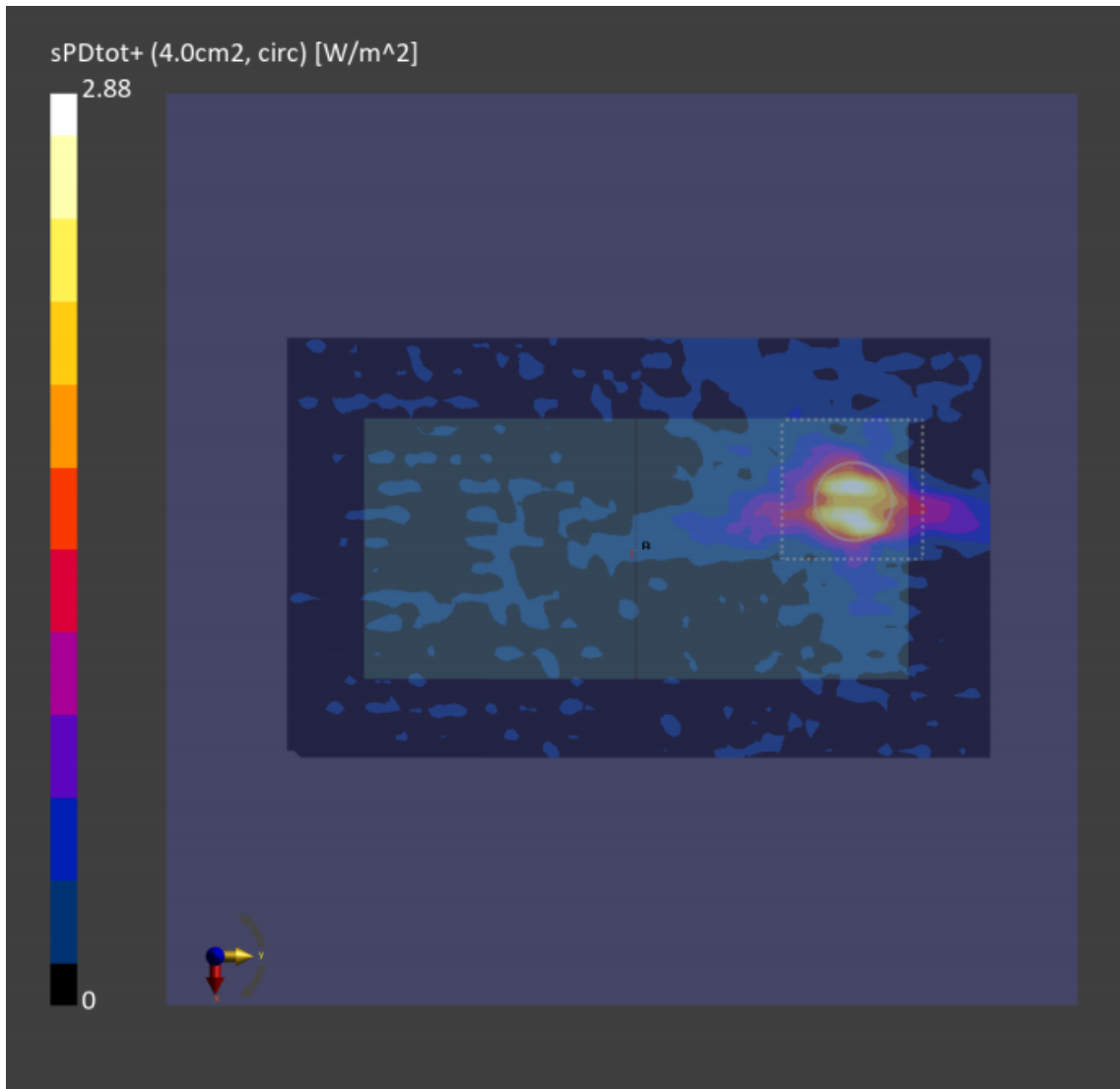

Figure8-3: 4cm<sup>2</sup>-averaged power density distribution measured at input.power.limit of 2.55 dBm on the Back for n260 beam 36

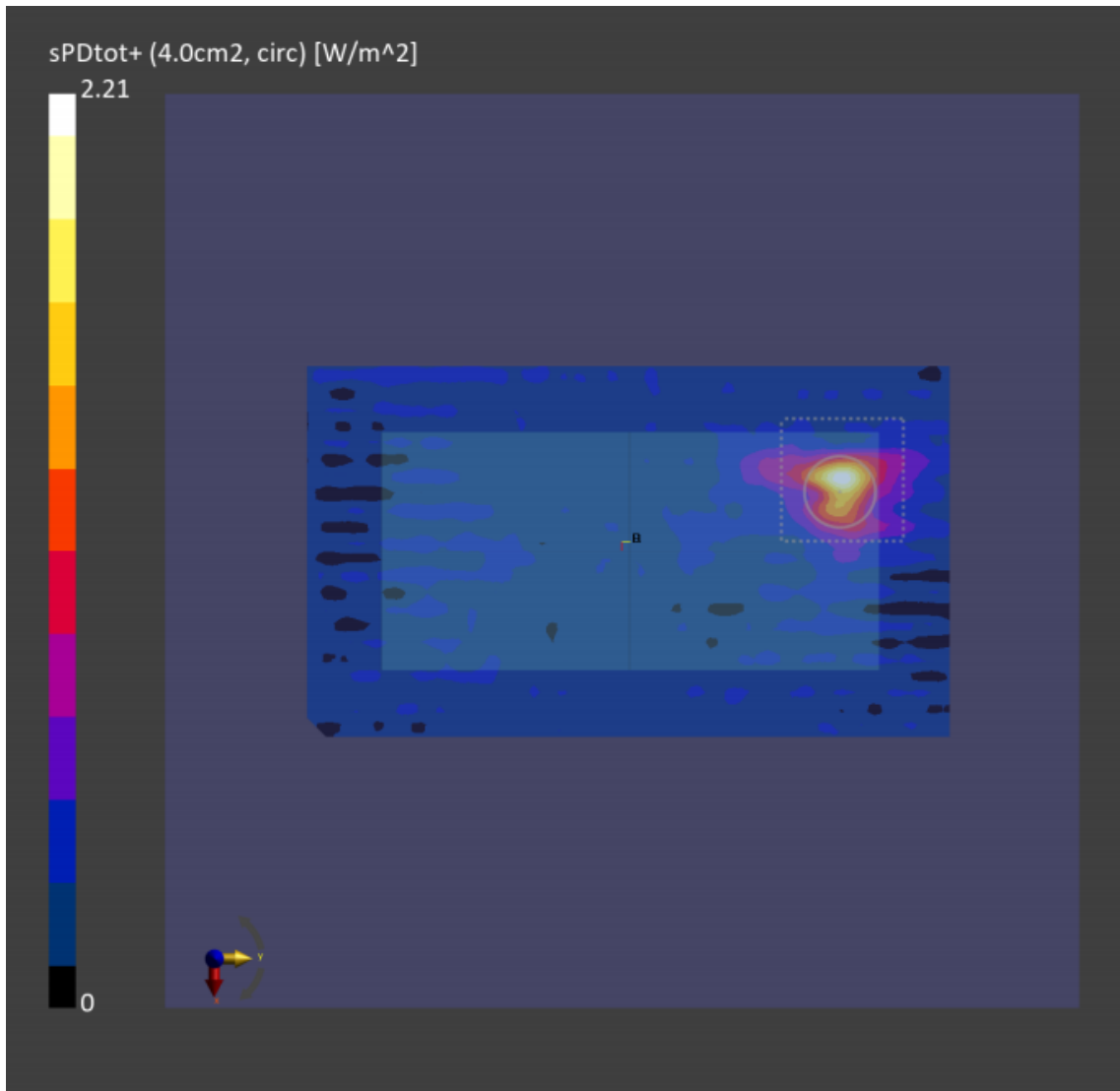

Figure 8-4: 4cm2-averaged power density distribution measured at *input.power.limit* of - 0.34dBm on the back surface for n261 beam 24



### 6.2.1 Maximum Tx power test results for n260

This test was measured with LTE B2 (DSI = 4) and mmW Band n260 Beam ID 36, by following the detailed test procedure described in Section 2.3.1.

Instantaneous and 100s-averaged conducted LTE Tx power versus time, instantaneous and 4s-averaged radiated mmW Tx power versus time, time-averaged conducted LTE Tx power limit and time-averaged radiated mmW Tx power limit:

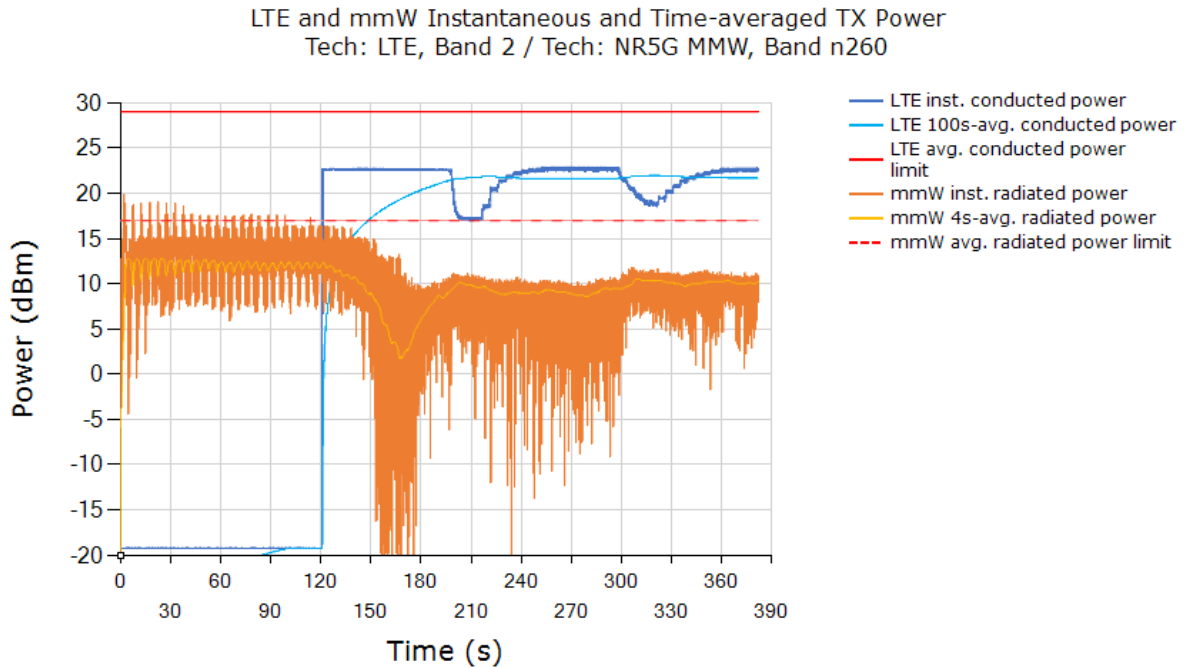

Above time-averaged conducted Tx power for LTE B2 and radiated Tx power for mmW NR n260 Beam ID 36 are converted into time-averaged 1gSAR and time-averaged 4cm<sup>2</sup>PD using Equation (2a) and (2b), which are divided by FCC 1gSAR limit of 1.6 W/kg and 4cm<sup>2</sup>PD limit of 10 W/m<sup>2</sup>, respectively, to obtain normalized exposures versus time. Below plot shows (a) normalized time-averaged 1gSAR versus time, (b) normalized time-averaged 4cm<sup>2</sup>-avg.PD versus time, (c) sum of normalized time-averaged 1gSAR and normalized time-averaged 4cm<sup>2</sup>-avg.PD:

Total Normalized Time-averaged RF Exposure  
 Tech: LTE, Band 2 / Tech: NR5G MMW, Band n260

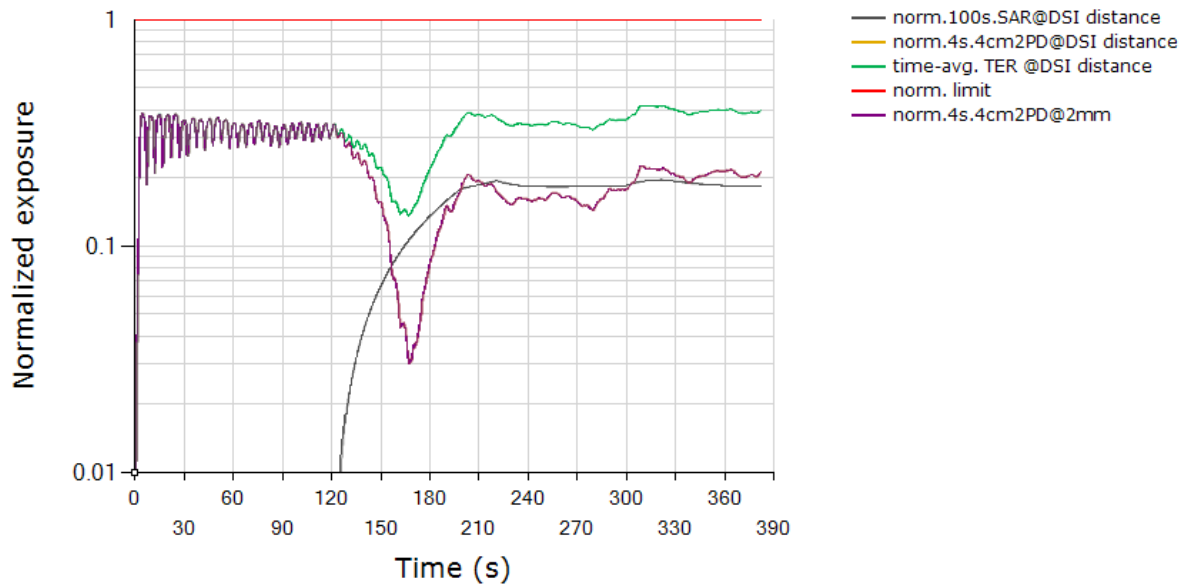

	Exposure Ratio
FCC requirement for total RF exposure (normalized)	1.0
Max total normalized time-averaged RF exposure (green curve)	0.419
Validated	

Plot notes:

5G mmW NR call was established at 0s time mark and LTE was placed in all-down bits immediately after 5G mmW NR call was established. Between 0s~120s, mmW exposure is the dominant contributor. Here, Smart Transmit feature allocates a maximum of 100% for mmW. From Table 8-1, this corresponds to a normalized 4cm<sup>2</sup>PD exposure value for Beam ID 36 of  $(100\% * 2.88\text{W/m}^2) / (10 \text{ W/m}^2) = 28.80\% \pm 2.1\text{dB}$  device related uncertainty (see green/orange curve between 0s~120s). At ~120s time mark, LTE is set to all-up bits, taking away margin from mmW exposure gradually. Towards the end of test, LTE is the dominant contributor towards RF exposure, i.e., corresponding normalized 1gSAR exposure value of  $(100\% * 1\text{W/kg}) / (1.6 \text{ W/kg}) = 62.50\% +1\text{dB} \sim -1\text{dB}$  design related uncertainty.

As can be seen, the power limiting enforcement is effective and the total normalized time-averaged RF exposure does not exceed 1.0. Therefore, Qualcomm<sup>®</sup> Smart Transmit time averaging feature is validated.

### 6.2.2 Maximum Tx power test results for n261

This test was measured with LTE B2 (DSI = 4) and mmW Band n261 Beam ID 24, by following the detailed test procedure described in Section 2.3.1.

Instantaneous and 100s-averaged conducted LTE Tx power versus time, instantaneous and 4s-averaged radiated mmW Tx power versus time, time-averaged conducted LTE Tx power limit and time-averaged radiated mmW Tx power limit:

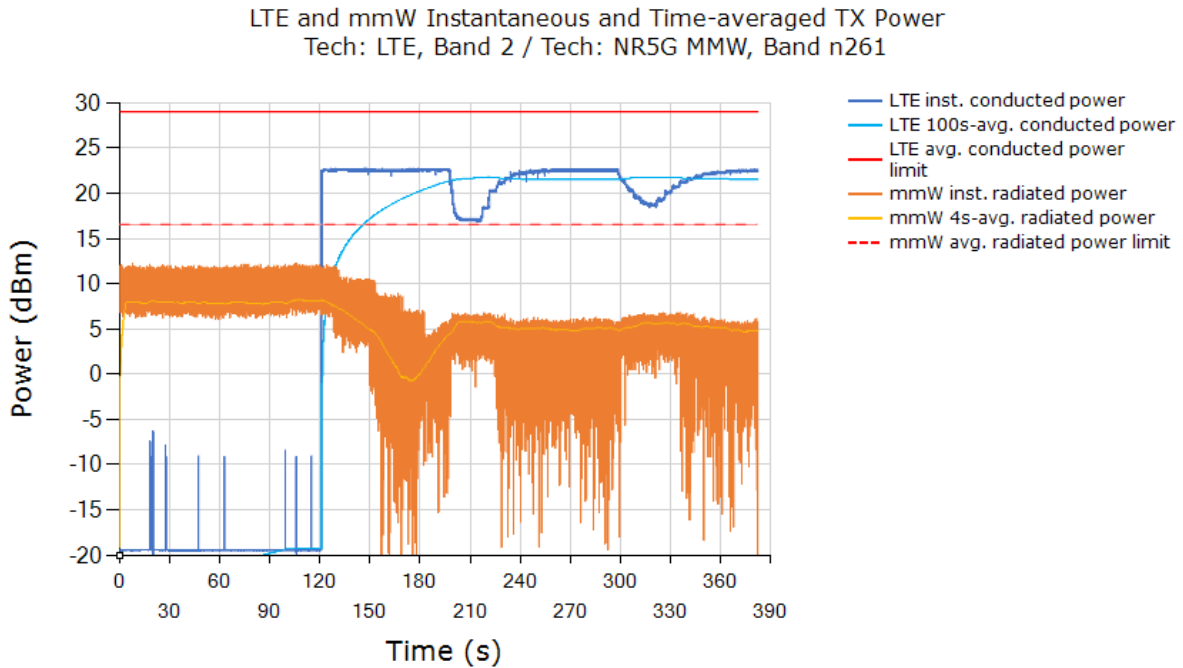

Above time-averaged conducted Tx power for LTE B2 and radiated Tx power for mmW NR n261 Beam ID 24 are converted into time-averaged 1gSAR and time-averaged 4cm<sup>2</sup>PD using Equation (2a) and (2b), which are divided by FCC 1gSAR limit of 1.6 W/kg and 4cm<sup>2</sup>PD limit of 10 W/m<sup>2</sup>, respectively, to obtain normalized exposures versus time. Below plot shows (a) normalized time-averaged 1gSAR versus time, (b) normalized time-averaged 4cm<sup>2</sup>-avg.PD versus time, (c) sum of normalized time-averaged 1gSAR and normalized time-averaged 4cm<sup>2</sup>-avg.PD:

Total Normalized Time-averaged RF Exposure  
 Tech: LTE, Band 2 / Tech: NR5G MMW, Band n261

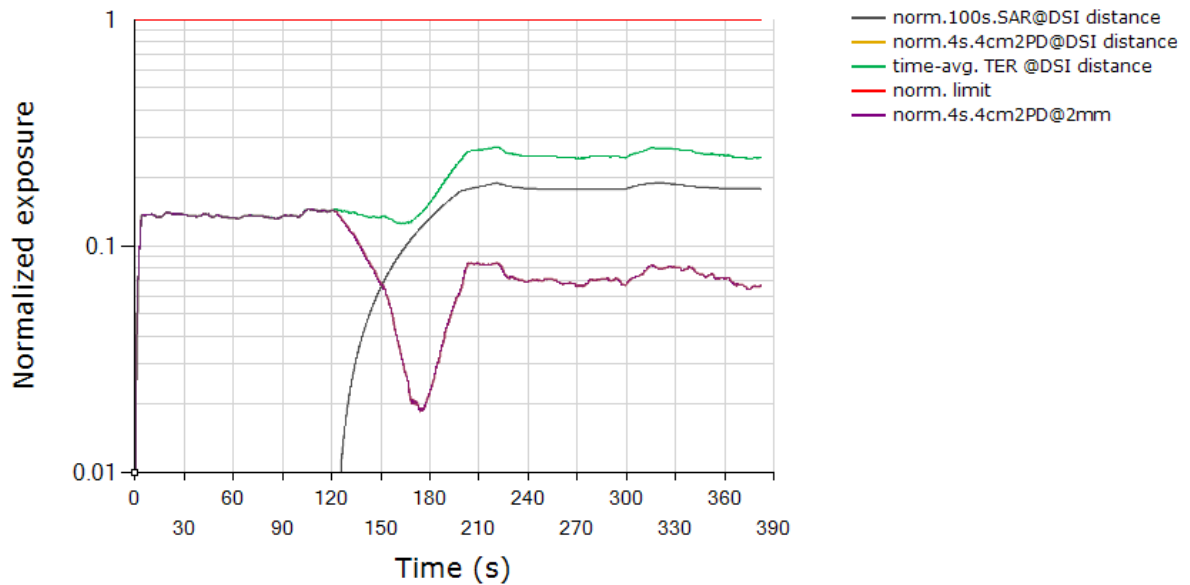

	Exposure ratio
FCC requirement for total RF exposure (normalized)	1.0
Max total normalized time-averaged RF exposure (green curve)	0.274
Validated	

Plot notes:

5G mmW NR call was established at ~0s time mark and LTE was placed in all-down bits immediately after 5G mmW NR call was established. Between 0s~120s, mmW exposure is the dominant contributor. Here, Smart Transmit feature allocates a maximum of 100% for mmW. From Table 8-1, this corresponds to a normalized 4cm<sup>2</sup>PD exposure value for Beam ID 24 of  $(100\% * 2.21\text{W}/\text{m}^2) / (10\text{ W}/\text{m}^2) = 22.10\% \pm 2.1\text{dB}$  device related uncertainty (see green/orange curve between 0s~120s). At ~120s time mark, LTE is set to all-up bits, taking away margin from mmW exposure gradually. Towards the end of test, LTE is the dominant contributor towards RF exposure, i.e., corresponding normalized 1gSAR exposure value of  $(100\% * 1\text{ W}/\text{kg}) / (1.6\text{ W}/\text{kg}) = 62.50\% +1\text{dB} \sim -1\text{dB}$  design related uncertainty.

As can be seen, the power limiting enforcement is effective and the total normalized time-averaged RF exposure does not exceed 1.0. Therefore, Qualcomm® Smart Transmit time averaging feature is validated.

**6.2.3 Switch in SAR vs. PD exposure test results for n260**

This test was measured with LTE B2 (DSI = 4) and mmW Band n260 Beam ID 36, by following the detailed test procedure is described in Section 2.3.2.

Instantaneous and 100s-averaged conducted LTE Tx power versus time, instantaneous and 4s-averaged radiated mmW Tx power versus time, time-averaged conducted LTE Tx power limit and time-averaged radiated mmW Tx power limit:

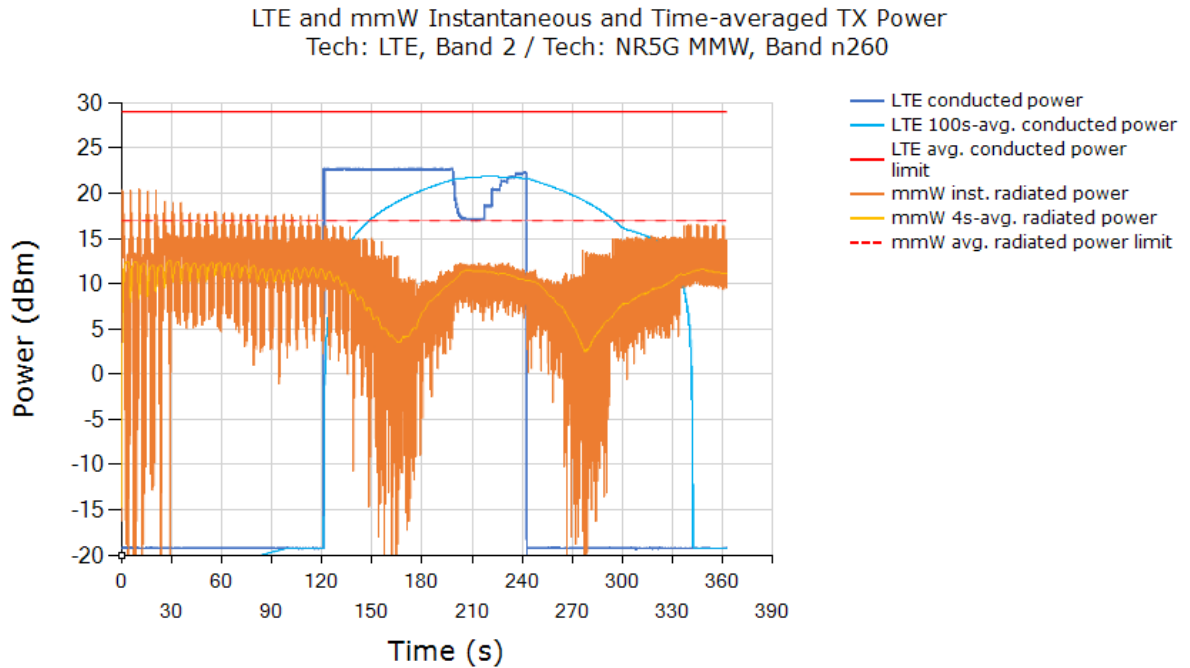

From the above plot, it is predominantly instantaneous PD exposure between 0s ~ 120s, it is instantaneous SAR+PD exposure between 120s ~ 160s, it is predominantly instantaneous SAR exposure between 160s ~ 240s, and above 240s, it is predominantly instantaneous PD exposure.

Normalized time-averaged exposures for LTE (1gSAR) and mmW (4cm²PD), as well as total normalized time-averaged exposure versus time:

Total Normalized Time-averaged RF Exposure  
 Tech: LTE, Band 2 / Tech: NR5G MMW, Band n260

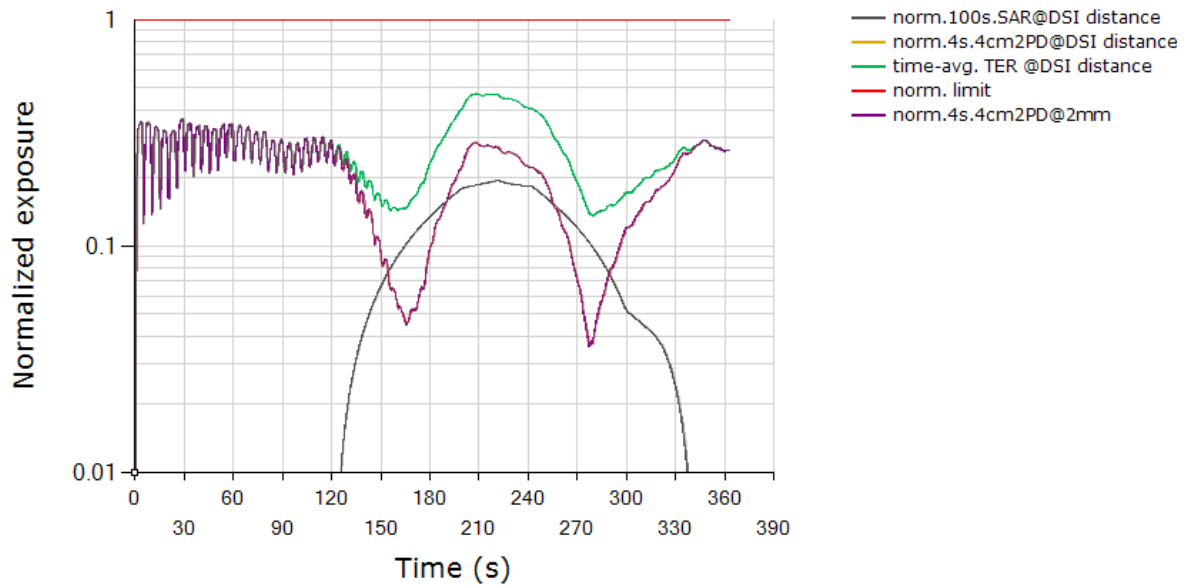

	Exposure Ratio
FCC requirement for total RF exposure (normalized)	1.0
Max total normalized time-averaged RF exposure (green curve)	0.472
Validated	

Plot notes: ...

5G mmW NR call was established at ~0s time mark and LTE was placed in all-downbits immediately after 5G mmW NR call was established. Between 0s~120s, mmW exposure is the dominant contributor. Here, Smart Transmit feature allocates a maximum of 100% for mmW. From Table 8-1, this corresponds to a normalized 4cm2PD exposure value for Beam ID 36 of  $(100\% * 2.88\text{W}/\text{m}^2) / (10\text{ W}/\text{m}^2) = 28.80\% \pm 2.1\text{dB}$  device related uncertainty (see orange/green curve between 0s~120s). At ~120s time mark, LTE is set to all-up bits, taking away margin from mmW exposure gradually (orange curve for mmW exposure goes down while black curve for LTE exposure goes up). At ~240s time mark, LTE is set to all-down bits, which results in mmW getting back RF margin slowly as seen by gradual increase in mmW exposure (orange curve for mmW exposure goes up while black curve for LTE exposure goes down). The calculated maximum RF exposure from LTE corresponds to normalized 1gSAR exposure value of  $(100\% * 1\text{W}/\text{kg}) / (1.6\text{ W}/\text{kg}) = 62.50\% + " +1\text{dB} \sim -1\text{dB} "$  design related uncertainty

As can be seen, the power limiting enforcement is effective during transmission when SAR and PD exposures are switched, and the total normalized time-averaged RF exposure does not exceed 1.0. Therefore, Qualcomm® Smart Transmit time averaging feature is validated

6.2.4 Switch in SAR vs. PD exposure test results for n261

This test was measured with LTE B2 (DSI = 4) and mmW Band n261 Beam ID 24, by following the detailed test procedure is described in Section 2.3.2.

Instantaneous and 100s-averaged conducted LTE Tx power versus time, instantaneous and 4s-averaged radiated mmW Tx power versus time, time-averaged conducted LTE Tx power limit and time-averaged radiated mmW Tx power limit:

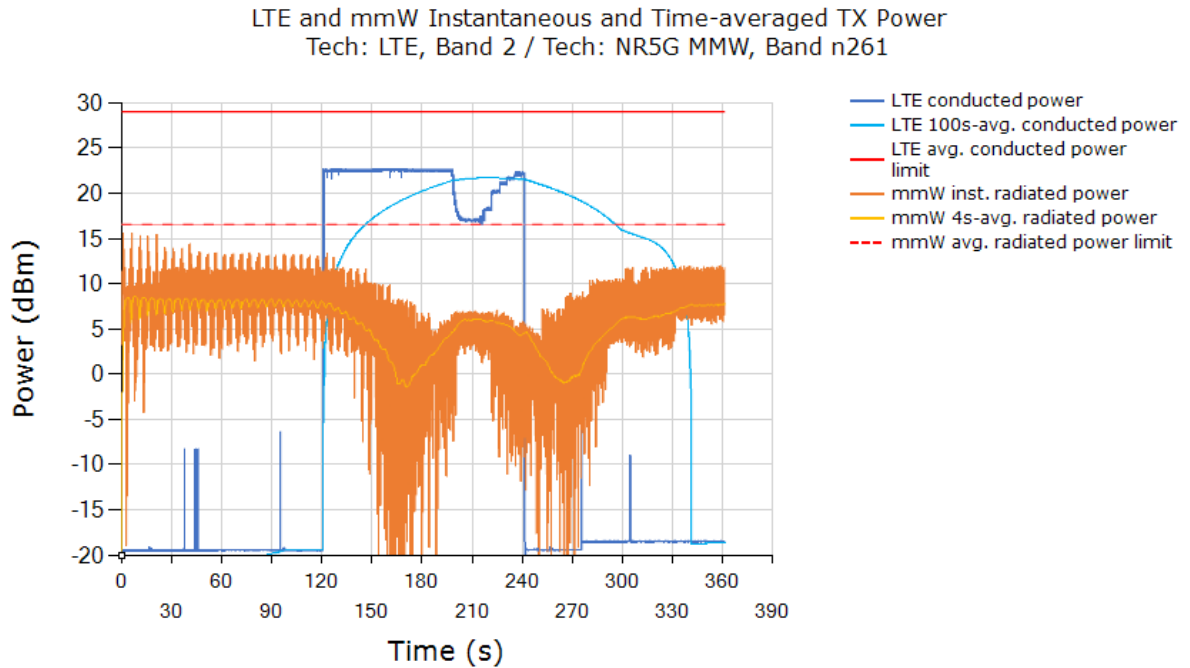

From the above plot, it is predominantly instantaneous PD exposure between 0s ~ 120s, it is instantaneous SAR+PD exposure between 120s ~ 140s, it is predominantly instantaneous SAR exposure between 140s ~ 240s, and above 240s, it is predominantly instantaneous PD exposure.

Normalized time-averaged exposures for LTE (1gSAR) and mmW (4cm²PD), as well as total normalized time-averaged exposure versus time:

Total Normalized Time-averaged RF Exposure  
 Tech: LTE, Band 2 / Tech: NR5G MMW, Band n261

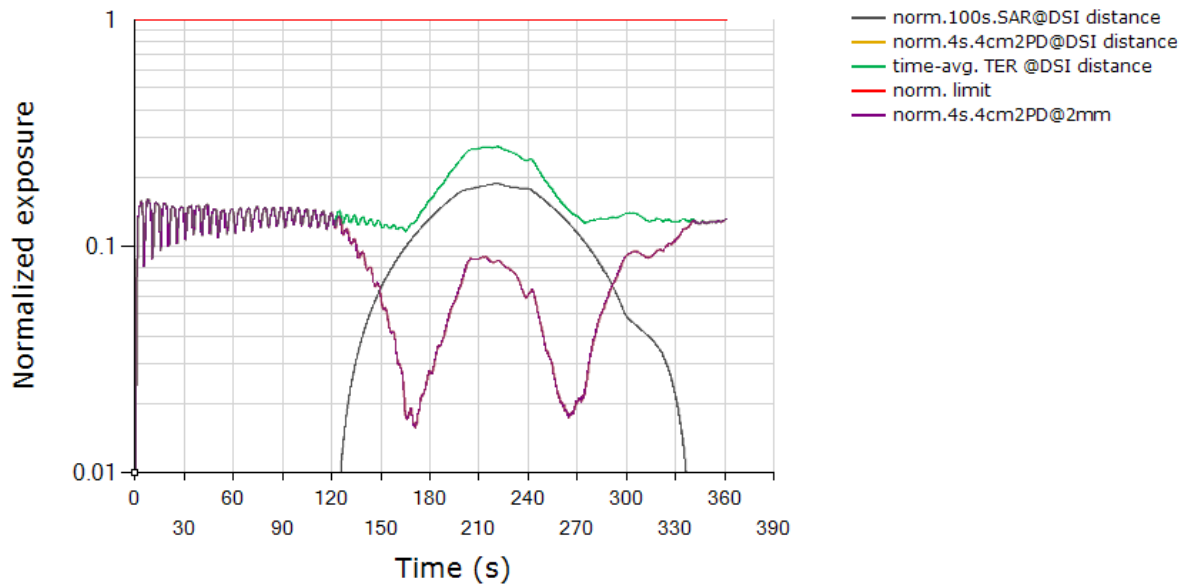

	Exposure Ratio
FCC requirement for total RF exposure (normalized)	1.0
Max total normalized time-averaged RF exposure (green curve)	0.276
Validated	

Plot notes: ...

5G mmW NR call was established at ~0s time mark and LTE was placed in all-down

bits immediately after 5G mmW NR call was established. Between 0s~120s, mmW exposure is the dominant contributor. Here, Smart Transmit feature allocates a maximum of 100% for mmW. From Table 8-1, this corresponds to a normalized 4cm2PD exposure value for Beam ID 24 of  $(100\% * 2.21W/m^2)/(10 W/m^2) = 22.10\% \pm 2.1dB$  device related uncertainty (see orange/green curve between 0s~120s). At ~120s time mark, LTE is set to all-up bits, taking away margin from mmW exposure gradually (orange curve for mmW exposure goes down while black curve for LTE exposure goes up). At ~240s time mark, LTE is set to all-down bits, which results in mmW getting back RF margin slowly as seen by gradual increase in mmW exposure (orange curve for mmW exposure goes up while black curve for LTE exposure goes down). The calculated maximum RF exposure from LTE corresponds to normalized 1gSAR exposure value of  $(100\% * 1W/kg)/(1.6 W/kg) = 62.50\% +1dB - 1dB$  design related uncertainty.

As can be seen, the power limiting enforcement is effective during transmission when SAR and PD exposures are switched, and the total normalized time-averaged RF exposure does not exceed 1.0. Therefore, Qualcomm® Smart Transmit time averaging feature is validated.



**6.2.5 Change in Beam test results for n260**

This test was measured with LTE B2 (DSI = 4) and mmW Band n260, with beam switch from Beam ID 36 to Beam ID 4, by following the test procedure is described in Section 2.3.3.

Instantaneous conducted LTE Tx power versus time, instantaneous and 4s-averaged radiated mmW Tx power versus time, time-averaged radiated mmW Tx power limits for Beam ID 36 and Beam ID 4:

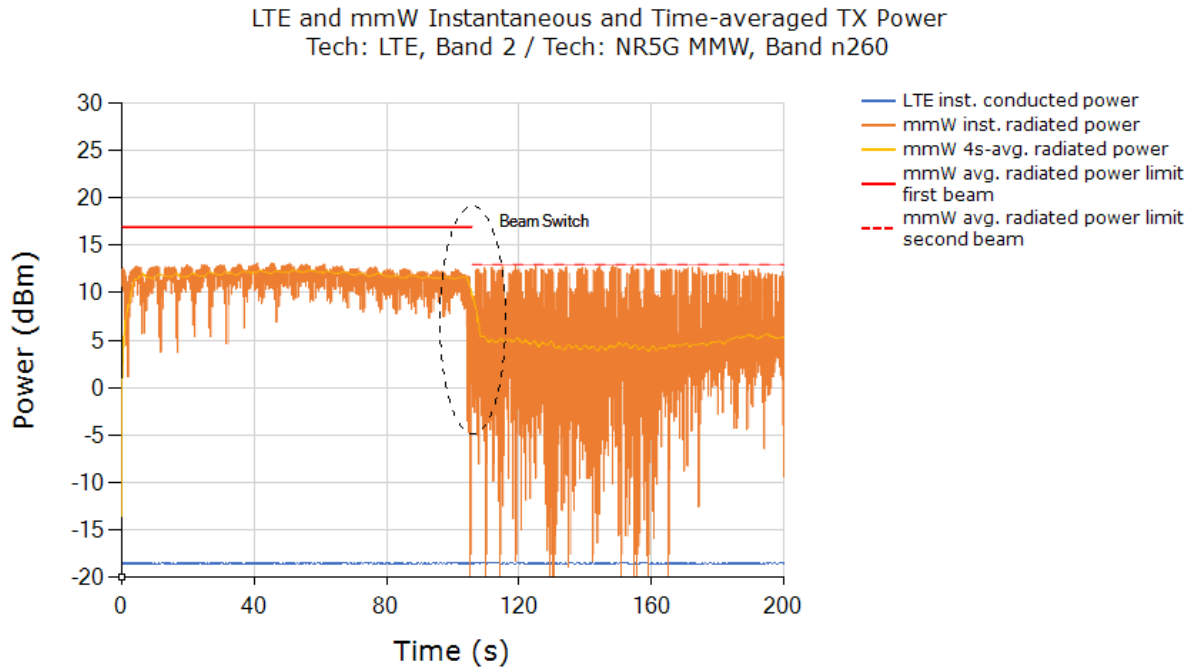

Normalized time-averaged exposures for LTE and mmW (4cm<sup>2</sup>PD), as well as total normalized time-averaged exposure versus time:

Total Normalized Time-averaged RF Exposure  
 Tech: LTE, Band 2 / Tech: NR5G MMW, Band n260

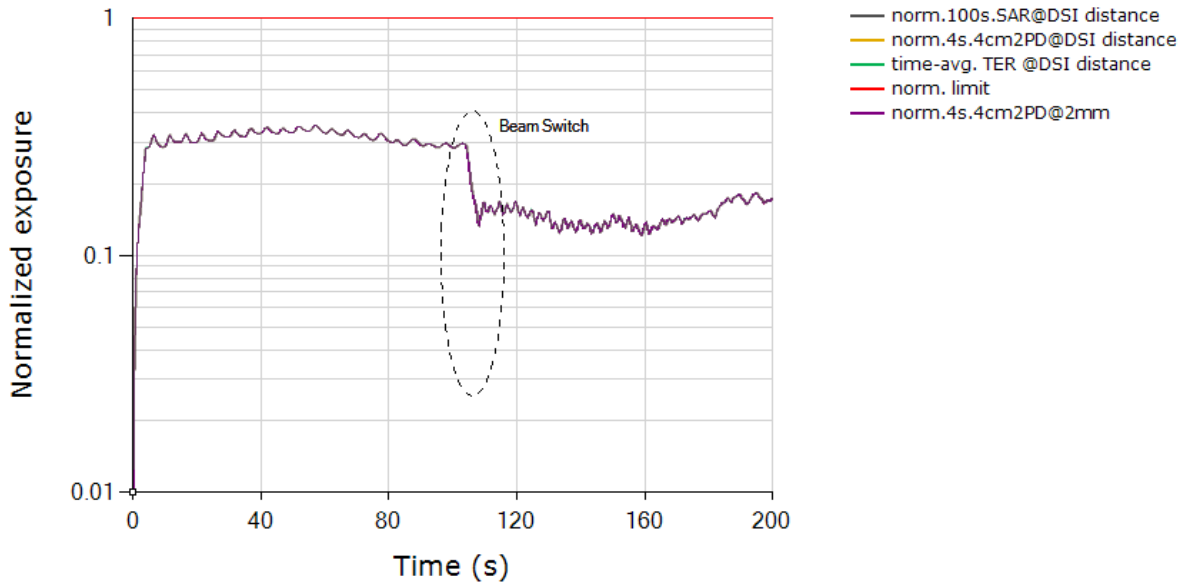

	Exposure ratio
FCC requirement for total RF exposure (normalized)	1.0
Max total normalized time-averaged RF exposure (green curve)	0.353
Validated	

Plot notes: ...

5G mmW NR call was established at ~10s time mark and LTE was placed in all-down bits during this test. For this test, mmW exposure is the dominant contributor as LTE is left in all-down bits. Here, Smart Transmit feature allocates a maximum of 100% for mmW. From Table 8-1 exposure between 10s ~100s corresponds to a normalized 4cm2PD exposure value for Beam ID 36 of  $(100\% * 2.88\text{W/m}^2) / (10 \text{ W/m}^2) = 28.80\% \pm 2.1\text{dB}$  device related uncertainty. At ~100s time mark (shown in black dotted ellipse), beam was switched to Beam ID 4 resulting in a normalized 4cm2PD exposure value of  $(100\% * 1.27\text{W/m}^2) / (10 \text{ W/m}^2) = 12.70\% \pm 2.1\text{dB}$  device related uncertainty. Additionally, during the switch, the ratio between the averaged radiated powers of the two beams (yellow curve) should correspond to the difference in EIRPs measured at each corresponding input.power.limit for these beams listed in Table 8-1, i.e., 3.17dB  $\pm 2.1\text{dB}$  device uncertainty.

As can be seen, the power limiting enforcement is effective during switching beam switching, and the normalized time-averaged RF exposure does not exceed 1.0. Therefore, Qualcomm® Smart Transmit time averaging feature is validated

### 6.2.6 Change in Beam test results for n261

This test was measured with LTE B2 (DSI = 4) and mmW Band n261, with beam switch from Beam ID 24 to Beam ID 4, by following the test procedure is described in Section 2.3.3.

Instantaneous conducted LTE Tx power versus time, instantaneous and 4s-averaged radiated mmW Tx power versus time, time-averaged radiated mmW Tx power limits for Beam ID 24 and Beam ID 4:

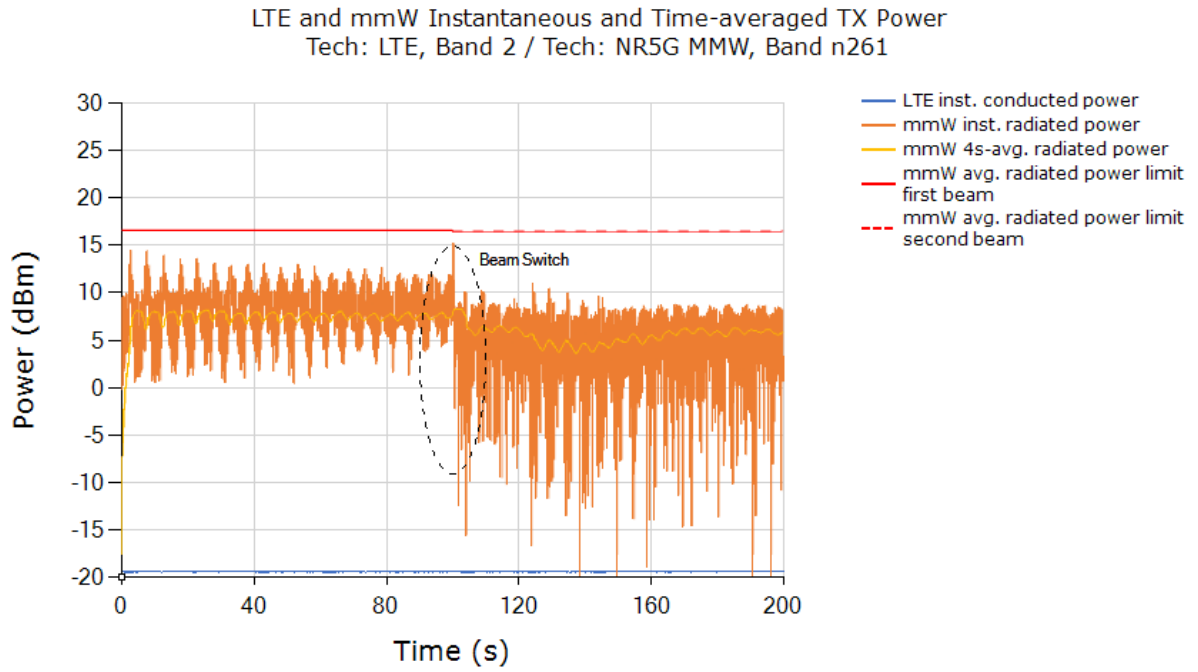

Normalized time-averaged exposures for LTE and mmW (4cm<sup>2</sup>PD), as well as total normalized time-averaged exposure versus time:

Total Normalized Time-averaged RF Exposure  
 Tech: LTE, Band 2 / Tech: NR5G MMW, Band n261

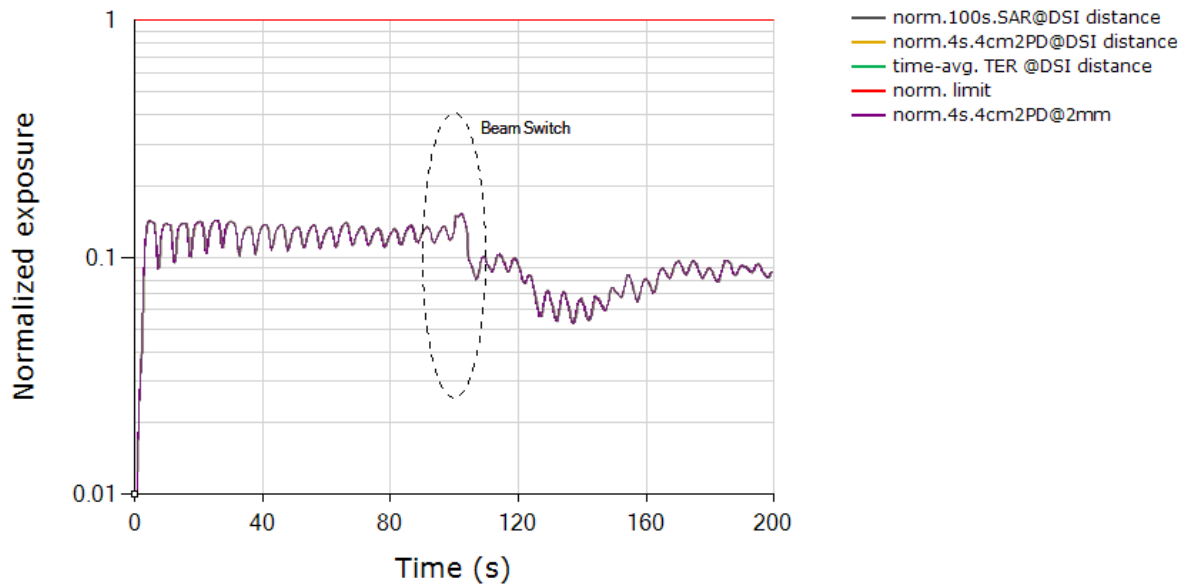

	Exposure Ratio
FCC requirement for total RF exposure (normalized)	1.0
Max total normalized time-averaged RF exposure (green curve)	0.153
Validated	

Plot notes: ...

5G mmW NR call was established at ~10s time mark and LTE was placed in all-down bits during the test. For this test, mmW exposure is the dominant contributor as LTE is left in all-down bits. Here, Smart Transmit feature allocates a maximum of 100% for mmW. From Table 8-1 exposure between 10s ~100s corresponds to a normalized 4cm2PD exposure value for Beam ID 24 of  $(100\% * 2.21W/m^2)/(10 W/m^2) = 22.10\% \pm 2.1dB$  device related uncertainty. At ~100s time mark (shown in black dotted ellipse), beam was switched to Beam ID 4 resulting in a normalized 4cm2PD exposure value of  $(100\% * 1.47W/m^2)/(10 W/m^2) = 14.70\% \pm 2.1dB$  device related uncertainty. Additionally, during the switch, the ratio between the averaged radiated powers of the two beams (yellow curve) should correspond to the difference in EIRPs measured at each corresponding input.power.limit for these beams listed in Table 8-1, i.e., 1.81 dB  $\pm 2.1dB$  device uncertainty.

As can be seen, the power limiting enforcement is effective during transmission when SAR and PD exposures are switched, and the total normalized time-averaged RF exposure does not exceed 1.0. Therefore, Qualcomm® Smart Transmit time averaging feature is validated

## 5. PD Test Results for mmW Smart Transmit Feature Validation

### 5.1 Measurement setup

The measurement setup is similar to normal PD measurements, the EUT is positioned on cDASY6 platform, and is connected with the callbox (conducted for LTE and wirelessly for mmW). Keysight UXM callbox is set to request maximum mmW Tx power from EUT all the time. Hence, “path loss” calibration between callbox antenna and EUT is not needed in this test. The callbox’s LTE port is directly connected to the EUT’s RF port via a directional coupler to measure the EUT’s conducted Tx power using a Rohde & Schwarz NR8S power sensor. Additionally, EUT is connected to the PC via USB connection for toggling between FTM and online mode with Smart Transmit enabled following the test procedures described Section 2.4.

Figure 9-1 shows the schematic of this measurement setup.

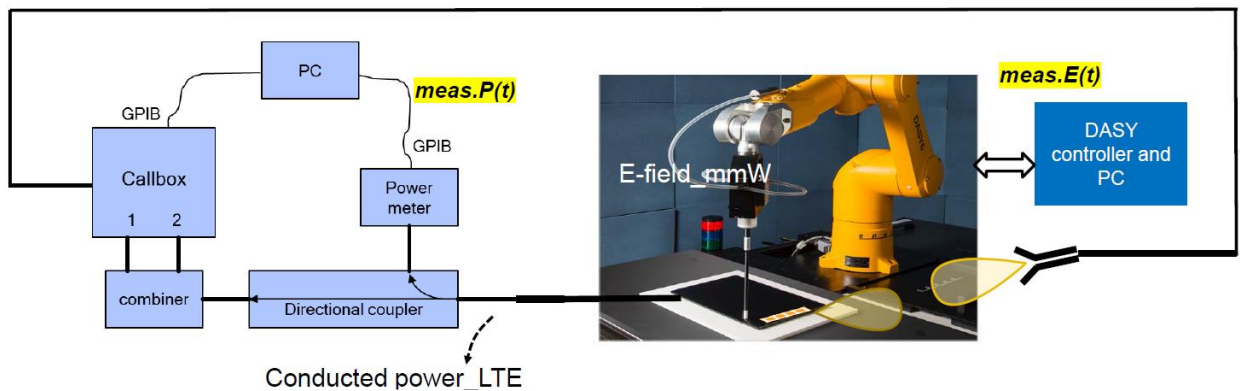

**Figure 9-1 PD measurement setup**

Both callbox and power meters are connected to the PC using USB cables. Test scripts are custom made for automation of establishing LTE + mmW call, and for conducted Tx power recording of LTE transmission. These tests are manually stopped after desired time duration. Once the mmW link is established, LTE Tx power is programmed to toggle between all-up and all-down bits on the callbox. For all the tests, the callbox is set to request maximum Tx power in mmW NR radio from EUT all the time. Therefore, the calibration for the pathloss between the EUT and the horn antenna connected to the remote radio head of the callbox is not required.

Power meter readings are periodically recorded every 10ms on NR8S power sensor for LTE conducted Tx power. Time-averaged E-field measurements are performed using EUmWVx mmW probe at peak location of fast area scan. The distance between EUmWVx mmW probe tip to EUT surface is ~0.5 mm, and the distance between EUmWVx mmW probe sensor to probe tip is 1.5 mm. cDASY6 records relative point E-field (i.e., ratio  $\frac{[pointE(t)]^2}{[pointE\_input.power.limit]^2}$ ) versus time for mmW NR transmission.

**5.2 PD measurement results for maximum power transmission scenario**

The following configurations were measured by following the detailed test procedure is described in Section 2.4:

1. LTE B2 (DSI = 4) and mmW Band n260 Beam ID 36
2. LTE B2 (DSI = 4) and mmW Band n261 Beam ID 24

The measured conducted Tx power of LTE and ratio of  $\frac{[pointE(t)]^2}{[pointE\_input.power.limit]^2}$  of mmW is converted into 1gSAR and 4cm<sup>2</sup>PD value, respectively, using Eq. (4a) and (4b), rewritten below:

$$1g\_or\_10gSAR(t) = \frac{conducted\_Tx\_power(t)}{conducted\_Tx\_power\_P_{limit}} * 1g\_or\_10gSAR\_P_{limit} \tag{4a}$$

$$4cm^2PD(t) = \frac{[pointE(t)]^2}{[pointE\_input.power.limit]^2} * 4cm^2PD\_input.power.limit \tag{4b}$$

$$\frac{\frac{1}{T_{SAR}} \int_{t-T_{SAR}}^t 1g\_or\_10gSAR(t) dt}{FCC\ SAR\ limit} + \frac{\frac{1}{T_{PD}} \int_{t-T_{PD}}^t 4cm^2PD(t) dt}{FCC\ 4cm^2PD\ limit} \leq 1 \tag{4c}$$

where, *conducted\_Tx\_power(t)*, *conducted\_Tx\_power\_P<sub>limit</sub>*, and *1g\_or\_10gSAR\_P<sub>limit</sub>* correspond to the measured instantaneous conducted Tx power, measured conducted Tx power at *P<sub>limit</sub>*, and measured 1gSAR or 10gSAR values at *P<sub>limit</sub>* corresponding to LTE transmission. Similarly, *pointE(t)*, *pointE\_input.power.limit*, and *4cm<sup>2</sup>PD@input.power.limit* correspond to the measured instantaneous E-field, E-field at *input.power.limit*, and 4cm<sup>2</sup>PD value at *input.power.limit* corresponding to mmW transmission.

**NOTE:** cDASY6 system measures relative E-field, and provides ratio of

$$\frac{[pointE(t)]^2}{[pointE\_input.power.limit]^2} \text{ versus time.}$$

The radio configurations tested are described in Table 5-3 and 5-4. The 1gSAR at *P<sub>limit</sub>* for LTE B2 (DSI = 4), the measured 4cm<sup>2</sup>PD at *input.power.limit* of mmW Band n260 Beam ID 36, and Band n261 Beam ID 24, are all listed in Table 8-1.

7.2.1 PD test results for n260

Step 2.e plot (in Section 2.4) for normalized instantaneous and time-averaged exposures for LTE and mmW n260 Beam ID 36

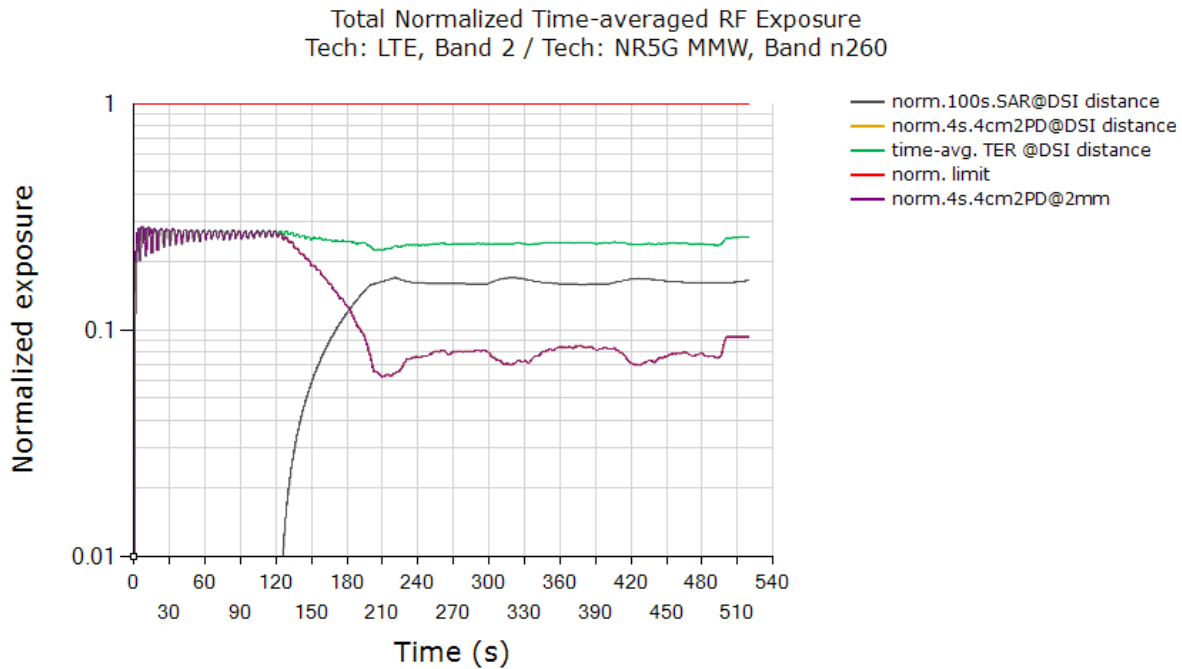

FCC limit for total RF exposure	1.0
Max total normalized time-averaged RF exposure (green curve)	0.286
Validated	

Plot notes: .....

LTE was placed in all-down bits immediately after 5G mmW NR call was established. Between 0s~120s, mmW exposure is the dominant contributor. Here, Smart Transmit feature allocates a maximum of 100% for mmW. From Table 8-1, this corresponds to a normalized 4cm2PD exposure value for Beam ID 36 of  $(100\% * 2.88\text{W/m}^2) / (10\text{ W/m}^2) = 28.80\% \pm 2.1\text{dB}$  device related uncertainty (see orange/green curve between 0s~120s). Around 120s time mark, LTE is set to all-up bits, taking away margin from mmW exposure gradually. Towards the end of the test, LTE is the dominant contributor towards RF exposure, i.e., corresponding normalized 1gSAR exposure value of  $(100\% * 1\text{W/kg}) / (1.6\text{ W/kg}) = 62.50\% + 1\text{dB} \sim -1\text{dB}$  design related uncertainty.

As can be seen, the power limiting enforcement is effective and the total normalized time-averaged RF exposure does not exceed 1.0. Therefore, Qualcomm® Smart Transmit time averaging feature is validated

7.2.2 PD test results for n261

Step 2.e plot (in Section 2.4) for normalized instantaneous and time-averaged exposures for LTE and mmW n261 Beam ID 24:

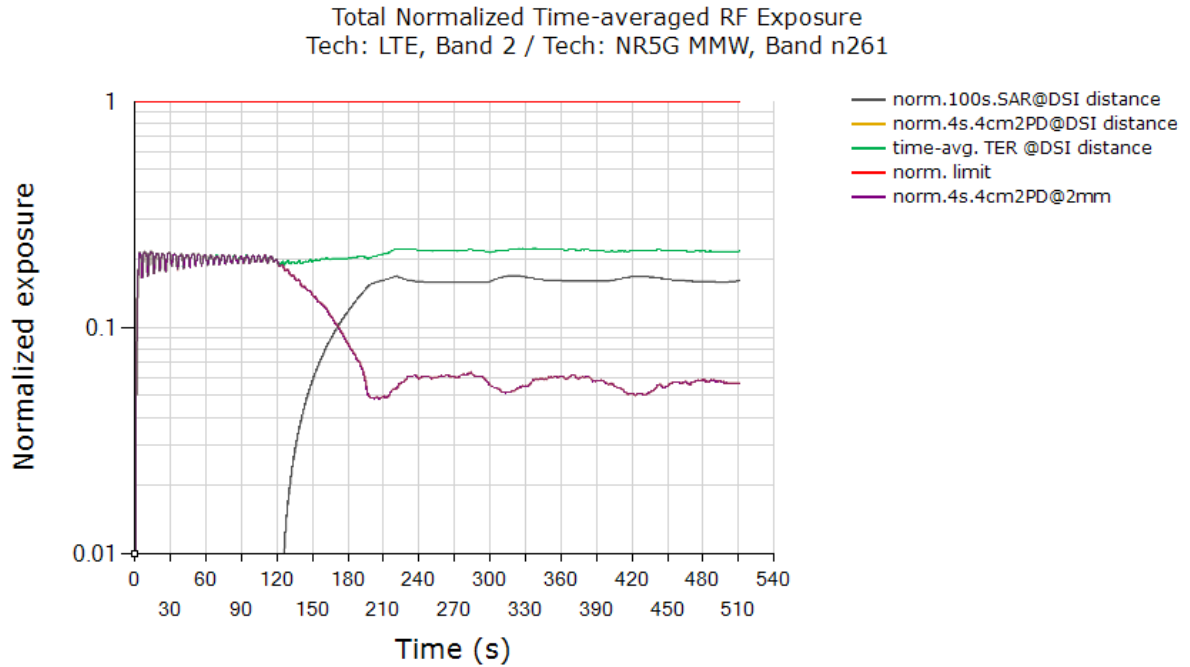

FCC limit for total RF exposure	1.0
Max total normalized time-averaged RF exposure (green curve)	0.224
Validated	

Plot notes:

LTE was placed in all-down bits immediately after 5G mmW NR call was established. Between 0s~120s, mmW exposure is the dominant contributor. Here, Smart Transmit feature allocates a maximum of 100% for mmW. From Table 8-1, this corresponds to a normalized 4cm2PD exposure value for Beam ID 24 of  $(100\% * 2.21W/m^2)/(10 W/m^2) = 22.10\% \pm 2.1dB$  device related uncertainty (see orange/green curve between 0s~120s). Around 120s time mark, LTE is set to all-up bits, taking away margin from mmW exposure gradually. Towards the end of the test, LTE is the dominant contributor towards RF exposure, i.e., corresponding normalized 1gSAR exposure value of  $(100\% * 1W/kg)/(1.6 W/kg) = 62.50\% + " +1dB \sim -1dB "$  design related uncertainty.

As can be seen, the power limiting enforcement is effective and the total normalized time-averaged RF exposure does not exceed 1.0. Therefore, Qualcomm® Smart Transmit time averaging feature is validated.





## **6. Conclusions**

Qualcomm Smart Transmit feature employed has been validated through the conducted/radiated power measurement, as well as SAR and PD measurement. As demonstrated in this report, the power limiting enforcement is effective and the total normalized time-averaged RF exposure does not exceed 1.0 for all the transmission scenarios described in Section 2. Therefore, the EUT complies with FCC RF exposure requirement.

## Appendix A. Test Sequences

1. Test sequence is generated based on below parameters of the EUT:

- a. Measured maximum power ( $P_{max}$ )
- b. Measured Tx\_power\_at\_SAR\_design\_target ( $P_{limit}$ )
- c. Reserve\_power\_margin (dB)
  - $P_{reserve} \text{ (dBm)} = \text{measured } P_{limit} \text{ (dBm)} - \text{Reserve\_power\_margin (dB)}$
- d. SAR\_time\_window (100s for FCC)

2. Test Sequence 1 Waveform:

Based on the parameters above, the Test Sequence 1 is generated with one transition between high and low Tx powers. Here, high power =  $P_{max}$ ; low power =  $P_{max}/2$ , and the transition occurs after 80 seconds at high power  $P_{max}$ . As long as the power enforcement is taking into effective during one 100s/60s time window, the validation test with this defined test sequence 1 is valid, otherwise, select other radio configuration (band/DSI within the same technology group) having lower  $P_{limit}$  for this test. The Test sequence 1 waveform is shown below:

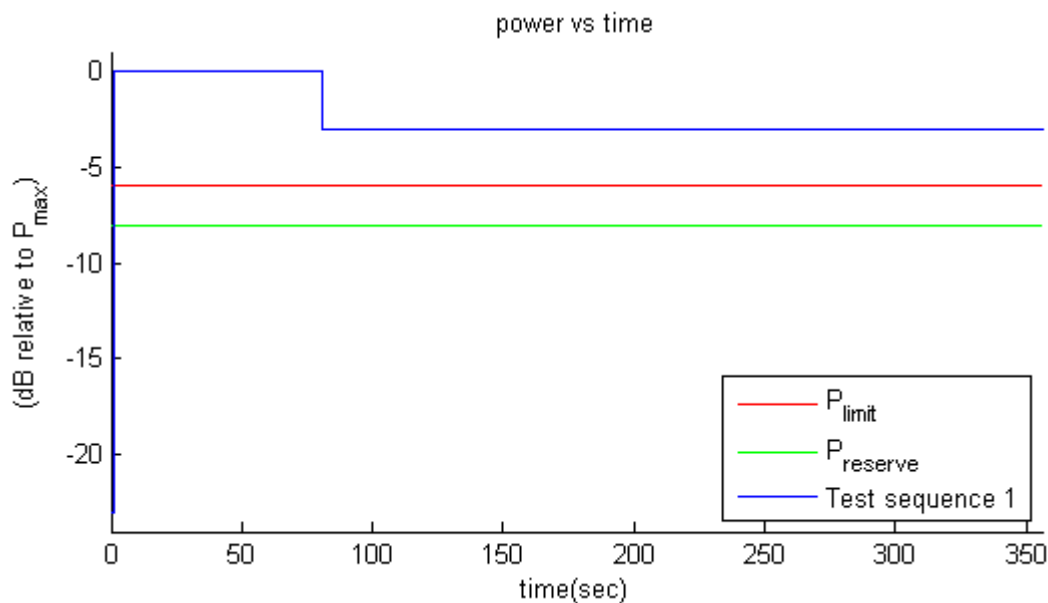

Figure A-1 Test sequence 1 waveform



3. Test Sequence 2 Waveform:

Based on the parameters in A-1, the Test Sequence 2 is generated as described in Table 10-1, which contains two 170 second-long sequences (yellow and green highlighted rows) that are mirrored around the center row of 20s, resulting in a total duration of 360 seconds:

Table A-1 Test Sequence 2

Time duration (seconds)	dB relative to $P_{limit}$ or $P_{reserve}$
15	$P_{reserve} - 2$
20	$P_{limit}$
20	$(P_{limit} + P_{max})/2$ averaged in mW and rounded to nearest 0.1 dB step
10	$P_{reserve} - 6$
20	$P_{max}$
15	$P_{limit}$
15	$P_{reserve} - 5$
20	$P_{max}$
10	$P_{reserve} - 3$
15	$P_{limit}$
10	$P_{reserve} - 4$
20	$(P_{limit} + P_{max})/2$ averaged in mW and rounded to nearest 0.1 dB step
10	$P_{reserve} - 4$
15	$P_{limit}$
10	$P_{reserve} - 3$
20	$P_{max}$
15	$P_{reserve} - 5$
15	$P_{limit}$
20	$P_{max}$
10	$P_{reserve} - 6$
20	$(P_{limit} + P_{max})/2$ averaged in mW and rounded to nearest 0.1 dB step
20	$P_{limit}$
15	$P_{reserve} - 2$

The Test Sequence 2 waveform is shown in Figure A-2.

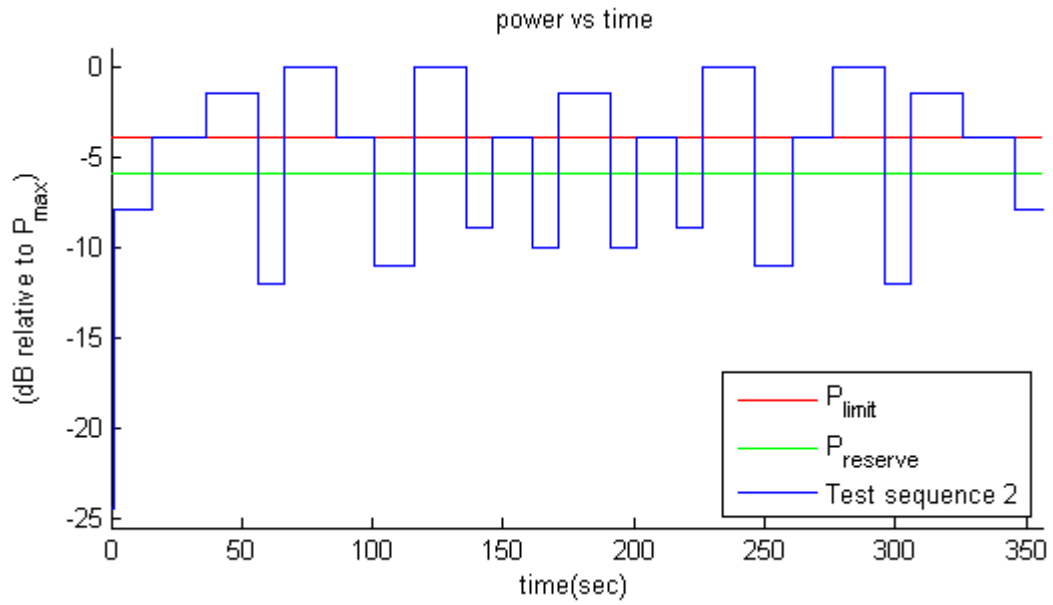



## Appendix B. Test Procedures for 5G NR + LTE Radio

Appendix B provides the test procedures for validating Qualcomm Smart Transmit feature for LTE + 5G NR non-standalone (NSA) mode transmission scenario, where sub-6GHz LTE link acts as an anchor.

### 1 Time-varying Tx power test for 5G NR in NSA mode

Follows Section 3.2.1 to select test configurations for time-varying test. This test is performed with two pre-defined test sequences (described in Section 3.1) applied to 5G NR (with LTE on all-down bits or low power for the entire test after establishing the LTE+5G NR call with the callbox). Follow the test procedures described in Section 3.3.1 to demonstrate the effectiveness of power limiting enforcement and that the time averaged Tx power of 5G NR when converted into 1gSAR values does not exceed the regulatory limit at all times (see Eq. (1a) and (1b)). 5G NR response to test sequence1 and test sequence2 will be similar to other technologies (say, LTE), and are shown in Sections 6.3.7 and 6.3.8.

### 2 Switch in SAR exposure between LTE vs. 5G NR during transmission

This test is to demonstrate that Smart Transmit feature accurately accounts for switching in exposures among SAR for LTE radio only, SAR from both LTE radio and 5G NR, and SAR from 5G NR only scenarios, and ensures total time-averaged RF exposure compliance with FCC limit.

#### Test procedure:

1. Measure conducted Tx power corresponding to  $P_{limit}$  for LTE and 5G NR in selected band. Test condition to measure conducted  $P_{limit}$  is:
  - Establish device in call with the callbox for LTE in desired band. Measure conducted Tx power corresponding to LTE  $P_{limit}$  with Smart Transmit enabled and *Reserve\_power\_margin* set to 0 dB, callbox set to request maximum power.
  - Repeat above step to measure conducted Tx power corresponding to 5G NR  $P_{limit}$ . If testing LTE+5G NR in non-standalone mode, then establish LTE+5G NR call with callbox and request all down bits for radio1 LTE. In this scenario, with callbox requesting maximum power from 5G NR, measured conducted Tx power corresponds to radio2  $P_{limit}$  (as radio1 LTE is at all-down bits)
1. Set *Reserve\_power\_margin* to actual (intended) value with EUT setup for LTE + 5G NR call. First, establish LTE connection in all-up bits with the callbox, and then 5G NR connection is added with callbox requesting UE to transmit at maximum power in 5G NR. As soon as the 5G NR connection is established, request all-down bits on LTE link (otherwise, 5G NR will not have sufficient RF exposure margin to sustain the call with LTE in all-up bits). Continue LTE (all-down bits)+5G NR transmission for more than one time-window duration to test predominantly 5G NR SAR exposure scenario (as SAR exposure is negligible from all-down bits in LTE). After at least one time-window, request LTE to go all-up bits to test LTE SAR and 5G NR SAR exposure scenario. After at least one more time-window, drop (or request all-down bits) 5G NR transmission to test predominantly LTE SAR exposure scenario. Continue the test for at least one more



time-window. Record the conducted Tx powers for both LTE and 5G NR for the entire duration of this test.

2. Once the measurement is done, extract instantaneous Tx power versus time for both LTE and 5G NR links. Similar to technology/band switch test in Section 3.3.3, convert the conducted Tx power for both these radios into 1gSAR value (see Eq. (6a) and (6b)) using corresponding technology/band  $P_{limit}$  measured in Step 1, and then perform 100s running average to determine time-averaged 1gSAR versus time as illustrated in Figure 3-1.
3. Make one plot containing: (a) instantaneous Tx power versus time measured in Step 2.
4. Make another plot containing: (a) instantaneous 1gSAR versus time determined in Step 3, (b) computed time-averaged 1gSAR versus time determined in Step 3, and (c) corresponding regulatory  $1gSAR_{limit}$  of 1.6W/kg.

The validation criteria is, at all times, the time-averaged 1gSAR versus time shall not exceed the regulatory  $1gSAR_{limit}$  of 1.6W/kg.



## **Appendix C. Test Procedures for inter-band UL CA**

Appendix C provides the test procedures for validating Qualcomm Smart Transmit feature for Switch in SAR exposure between PCC vs. SCC during inter-band ULCA transmission mode transmission scenario.

### **1 Switch in SAR exposure between PCC vs. SCC during inter-band ULCA transmission**

This test is to demonstrate that Smart Transmit feature accurately accounts for switching in exposures among SAR for PCC radio only, SAR from both PCC & SCC radios, and SAR from SCC radio only scenarios, and ensures total time-averaged RF exposure compliance with FCC limit.

#### **Test procedure:**

1. Measure *Plimit* for PCC and SCC in selected band. Test condition to measure conducted *Plimit* is:
  - Establish a LTE call with single active Tx in desired PCC band. Measure conducted Tx power corresponding to LTE *Plimit* with Smart Transmit enabled and *Reserve\_power\_margin* set to 0 dB, callbox set to request maximum power.
  - Repeat above step to measure *Plimit* corresponding to LTE SCC band under single active Tx scenario.
2. Set *Reserve\_power\_margin* to actual (intended) value, with EUT setup for interband ULCA call. First, establish interband ULCA connection with the callbox, and as soon as the connection is established, request all-down bits (or low power) on PCC link and then request UE to transmit at maximum power in SCC link. Continue PCC (all-down bits)+SCC transmission for more than one time-window duration to test predominantly SCC SAR exposure scenario (as SAR exposure from PCC is negligible from all-down bits). After at least one time-window, request PCC to go all-up bits to test PCC SAR and SCC SAR exposure scenario. After at least one more time-window, drop (or request all-down bits) SCC transmission to test predominantly PCC SAR exposure scenario. Continue the test for at least one more time-window. Record the conducted Tx powers for both PCC and SCC for the entire duration of this test.
3. Once the measurement is done, extract instantaneous Tx power versus time for both PCC and SCC links. Similar to technology/band switch test in Section 3.3.3, convert the conducted Tx power for both these radios into 1g\_or\_10gSAR value (see Eq. (6a) and (6b)) using corresponding technology/band *Plimit* measured in Step 1, and then



perform 100s running average to determine time-averaged 1g\_or\_10gSAR versus time as illustrated in Figure 5-1. Note that here it is assumed both radios have Tx frequencies < 3GHz, otherwise, 60s running average should be performed for radios having Tx frequency between 3GHz and 6GHz.

4. Make one plot containing: (a) instantaneous Tx power versus time measured in Step 2.

Make another plot containing: (a) instantaneous 1gSAR versus time determined in Step 3, (b) computed time-averaged 1gSAR versus time determined in Step 3, and (c) corresponding regulatory 1g\_or\_10gSARlimit limit.

The validation criteria is, at all times, the time-averaged 1g\_or\_10gSAR versus time shall not exceed the regulatory 1g\_or\_10gSARlimit limit.



## Appendix D. cDASY6 System Verification

### 1 The system to be used for the near field power density measurement

- SPEAG DASY6 system
- SPEAG cDASY6 5G module software
- EUmmWVx probe
- 5G Phantom cover

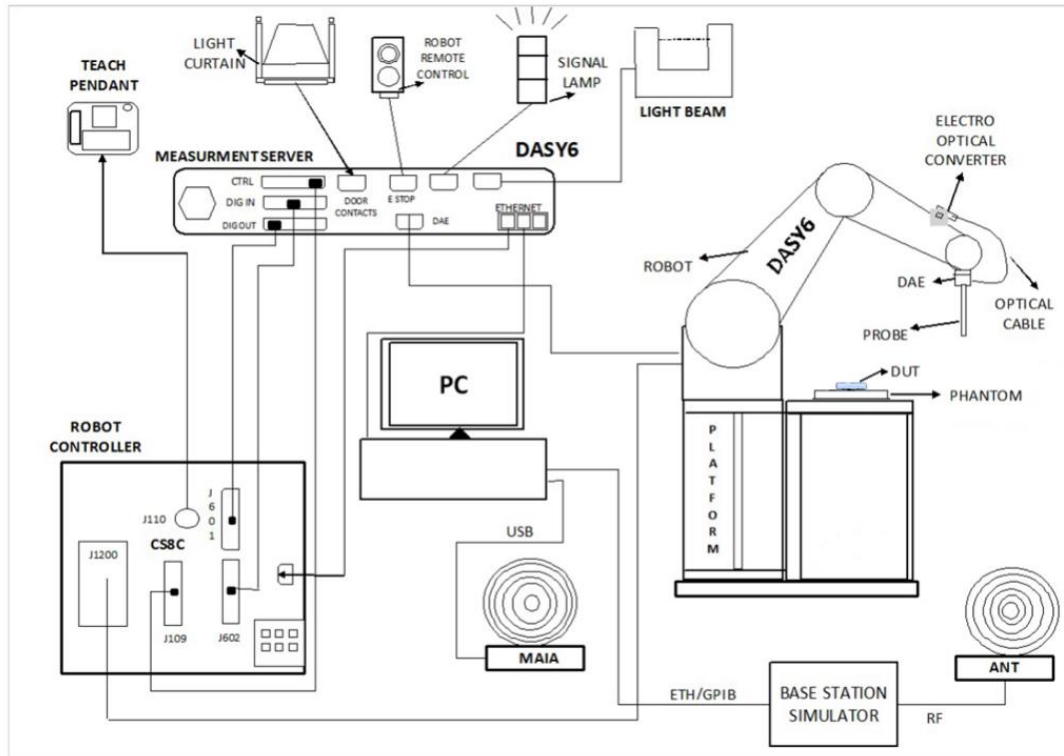

### 2 Test Side Location

Sporton Lab and below test site location are accredited to ISO 17025 by Taiwan Accreditation Foundation (TAF code: 1190) and the FCC designation No. TW1190 under the FCC 2.948(e) by Mutual Recognition Agreement (MRA) in FCC test.

Test Site	SPORTON INTERNATIONAL INC. EMC & Wireless Communications Laboratory
Test Site Location	TW1190 No. 52, Huaya 1st Rd., Guishan Dist., Taoyuan City 333, CHINESE TAIPEI
Test Site No.	SAR06-HY

### 3 E UmmWave Probe

The probe design allows measurements at distances as small as 2 mm from the sensors to the surface of the device under test (DUT). The typical sensor to probe tip distance is 1.5 mm.

<b>Frequency</b>	750 MHz – 110 GHz
<b>Probe Overall Length</b>	320 mm
<b>Probe Body Diameter</b>	8.0 mm
<b>Tip Length</b>	23.0 mm
<b>Tip Diameter</b>	8.0 mm
<b>Probe's two dipoles length</b>	0.9 mm – Diode loaded
<b>Dynamic Range</b>	< 20 V/m - 10000 V/m with PRE-10 (min < 50 V/m - 3000 V/m)
<b>Position Precision</b>	< 0.2 mm
<b>Distance between diode sensors and probe's tip</b>	1.5 mm
<b>Minimum Mechanical separation between probe tip and a Surface</b>	0.5 mm
<b>Applications</b>	E-field measurements of 5G devices and other mm-wave transmitters operating above 10GHz in < 2 mm distance from device (free-space) Power density, H-field and far-field analysis using total field reconstruction.
<b>Compatibility</b>	cDASY6 + 5G-Module SW1.0 and higher

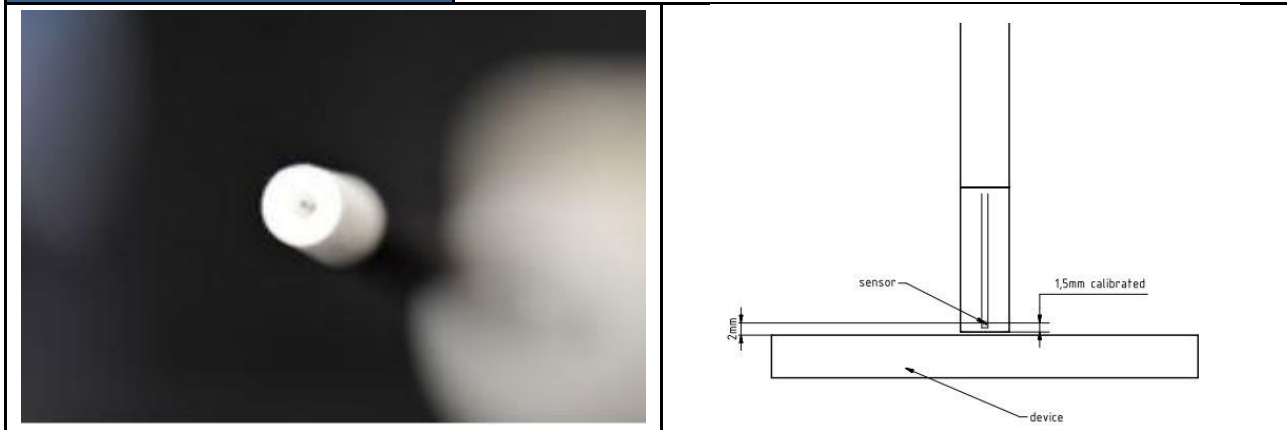

#### 4 EUmWave Verification source

<b>Model</b>	Ka-band horn antenna
<b>Calibrated frequency:</b>	30 GHz at 10mm from the case surface
<b>Frequency accuracy</b>	± 100 MHz
<b>E-field polarization</b>	linear
<b>Harmonics</b>	-20 dBc
<b>Total radiated power</b>	14 dBm
<b>Power stability</b>	0.05 dB
<b>Power consumption</b>	5 W
<b>Size</b>	100 x 100 x 100 mm
<b>Weight</b>	1 kg

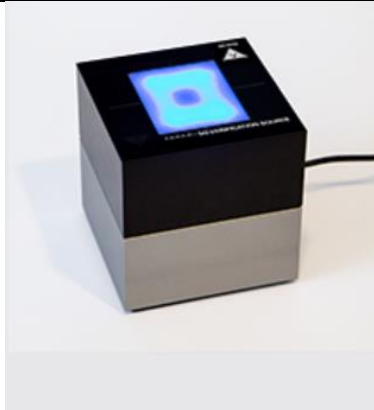

#### 5 SAR E-Field Probe

<b>Construction</b>	Symmetric design with triangular core Built-in shielding against static charges PEEK enclosure material (resistant to organic solvents, e.g., DGBE)	
<b>Frequency</b>	10 MHz – >6 GHz Linearity: ±0.2 dB (30 MHz – 6 GHz)	
<b>Directivity</b>	±0.3 dB in TSL (rotation around probe axis) ±0.5 dB in TSL (rotation normal to probe axis)	
<b>Dynamic Range</b>	10 µW/g – >100 mW/g Linearity: ±0.2 dB (noise: typically <1 µW/g)	
<b>Dimensions</b>	Overall length: 337 mm (tip: 20 mm) Tip diameter: 2.5 mm (body: 12 mm) Typical distance from probe tip to dipole centers: 1 mm	

#### 6 Data Acquisition Electronics (DAE)

The data acquisition electronics (DAE) consists of a highly sensitive electrometer-grade preamplifier with auto-zeroing, a channel and gain-switching multiplexer, a fast 16 bit AD-converter and a command decoder and control logic unit. Transmission to the measurement server is accomplished through an optical downlink for data and status information as well as an optical uplink for commands and the clock.

The input impedance of the DAE is 200 MOhm; the inputs are symmetrical and floating. Common mode rejection is above 80 dB.

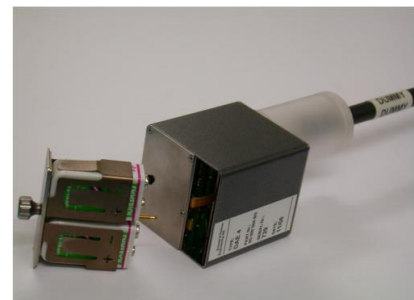



### 7 Test Equipment List

Manufacturer	Name of Equipment	Type/Model	Serial Number	Calibration	
				Last Cal.	Due Date
SPEAG	5G Verification Source	30GHz	1007	Nov. 18, 2022	Nov. 17, 2023
SPEAG	Data Acquisition Electronics	DAE4	854	Aug. 24, 2022	Aug. 23, 2023
SPEAG	E-Field mmWave Probe	EUmmWV4	9441	Nov. 18, 2022	Nov. 17, 2023
Bojay	mmwave measurement horn antenna	AQRH-15	000023	Note 1	
R&S	Wideband Radio Communication Tester	CMW500	169351	Oct. 18, 2022	Oct. 17, 2023
R&S	Power Sensor	NRP50S	100983	Nov. 10, 2022	Nov. 09, 2023
R&S	Power Sensor	NRP8S	109687	Sep. 05, 2022	Sep. 04, 2023
RCPTWN	Thermometer	HTC-1	TM685-1	Jun. 27, 2022	Jun. 26, 2023
SCHWARZBECK	18GHz~40GHzSHF-EHF Horn Antenna	BBHA 9170	BBHA9170251	Note 1	
Warison	10-50 GHz Directional Coupler	WCOU-10-50S-10	WR889BMC481	Note 1	



### 8 Power Density system verification and validation

The system performance check verifies that the system operates within its specifications. The EUT is replaced by a calibrated source, the same spatial resolution, measurement region and the test separation used in the calibration was applied to system check. Through visual inspection into the measured power density distribution, both spatially (shape) and numerically (level) have no noticeable difference. The measured results should be within 1 of the calibrated targets.

Frequency [GHz]	Grid step	Grid extent X/Y [mm]	Measurement points
10	0.25 ( $\frac{\lambda}{4}$ )	120/120	16 × 16
30	0.25 ( $\frac{\lambda}{4}$ )	60/60	24 × 24
60	0.25 ( $\frac{\lambda}{4}$ )	32.5/32.5	26 × 26
90	0.25 ( $\frac{\lambda}{4}$ )	30/30	36 × 36

Settings for measurement of verification sources

#### <PD System Verification Results>

Date	Frequency (GHz)	5G Verification Source	Probe S/N	DAE S/N	Distance (mm)	Measured 4 cm <sup>2</sup> (W/m <sup>2</sup> )	Targeted 4 cm <sup>2</sup> (W/m <sup>2</sup> )	Deviation (dB)
2023/3/23	30G	30GHz_1007	9441	854	5.55	37.9	35.9	0.24