



FCC 47 CFR PART 15 SUBPART C

TEST REPORT

For

Headset

Model: JC01

Trade Name: JAWBONE

Issued to

Aliph com

99 Rhode Island Street, 3rd Floor. San Francisco, CA 94103 United States

Issued by

**Compliance Certification Services Inc.
No.81-1, Lane 210, Bade 2nd Rd., Lujhu Township,
Taoyuan County 33841, Taiwan, R.O.C.**

TEL: 886-3-324-0332

FAX: 886-3-324-5235

<http://www.ccsrf.com>

service@ccsrf.com



Testing Laboratory
0363

Note: *This report shall not be reproduced except in full, without the written approval of Compliance Certification Services Inc. This document may be altered or revised by Compliance Certification Services Inc. personnel only, and shall be noted in the revision section of the document. The client should not use it to claim product endorsement by TAF, A2LA, NIST or any government agencies. The test results in the report only apply to the tested sample.*



Revision History

Rev.	Issue Date	Revisions	Effect Page	Revised By
00	October 21, 2013	Initial Issue	ALL	Landy Huang



TABLE OF CONTENTS

1	TEST RESULT CERTIFICATION	4
2	EUT DESCRIPTION	5
3	TEST METHODOLOGY	6
3.1.	EUT CONFIGURATION	6
3.2.	EUT EXERCISE	6
3.3.	GENERAL TEST PROCEDURES	6
3.4.	FCC PART 15.205 RESTRICTED BANDS OF OPERATIONS	7
3.5.	DESCRIPTION OF TEST MODES	8
4	INSTRUMENT CALIBRATION	9
4.1.	MEASUREMENT EQUIPMENT USED	9
4.2.	MEASUREMENT UNCERTAINTY	11
5	FACILITIES AND ACCREDITATIONS	12
5.1.	FACILITIES	12
5.2.	EQUIPMENT	12
5.3.	TABLE OF ACCREDITATIONS AND LISTINGS	13
6	SETUP OF EQUIPMENT UNDER TEST	14
6.1.	SETUP CONFIGURATION OF EUT	14
6.2.	SUPPORT EQUIPMENT	14
7	FCC PART 15.247 REQUIREMENTS	15
7.1.	6DB BANDWIDTH	15
7.2.	PEAK POWER	18
7.3.	AVERAGE POWER	19
7.4.	BAND EDGES MEASUREMENT	20
7.5.	PEAK POWER SPECTRAL DENSITY	27
7.6.	SPURIOUS EMISSIONS	30
7.7.	POWERLINE CONDUCTED EMISSIONS	40
8	PHOTOGRAPHS OF TEST SETUP	43
	APPENDIX 1: PHOTOGRAPHS OF EUT	47



1 TEST RESULT CERTIFICATION

Applicant: **Aliph com**
 99 Rhode Island Street, 3rd Floor. San Francisco, CA 94103
 United States

Manufacturer: **Cheng Uei Precision Industry Co., Ltd.**
 18, Chung Shan Road, Tu Cheng Dist., New Taipei City
 23680, Taiwan

Equipment Under Test: Headset

Trade Name: JAWBONE

Model: JC01

Date of Test: August 27 ~ September 18, 2013

APPLICABLE STANDARDS	
STANDARD	TEST RESULT
FCC 47 CFR Part 15 Subpart C	No non-compliance noted

We hereby certify that:

The above equipment was tested by Compliance Certification Services Inc. The test data, data evaluation, test procedures, and equipment configurations shown in this report were made in accordance with the procedures given in ANSI C63.4 and the energy emitted by the sample EUT tested as described in this report is in compliance with the requirements of FCC Rules Part 15.207, 15.209, 15.247.

The test results of this report relate only to the tested sample EUT identified in this report.

Approved by:

 Stan Lin
 Section Manager

Reviewed by:

 Angel Hu
 Section Manager



2 EUT DESCRIPTION

Product	Headset		
Trade Name	JAWBONE		
Model Number	JC01		
Model Name Discrepancy	N/A		
EUT Power Rating	5VDC From PC 3.7VDC From Battery		
Operating Frequency Range	2402 ~ 2480 MHz		
Transmit Power	2.52dBm (0.0018W)		
Modulation Technique	GFSK (1Mbps)		
Number of Channels	40 Channels		
Antenna Specification	Monopole Antenna / Gain: -0.65dBi		
CHARGER Manufacturer	JAWBONE	Model	JC02

Remark:

1. The sample selected for test was production product and was provided by manufacturer.
2. This submittal(s) (test report) is intended for FCC ID: **V3J-JC01** filing to comply with Section 15.207, 15.209 and 15.247 of the FCC Part 15, Subpart C Rules.



3 TEST METHODOLOGY

The tests documented in this report were performed in accordance with ANSI C63.4 (2009), KDB558074 and FCC CFR 47 15.207, 15.209 and 15.247.

3.1. EUT CONFIGURATION

The EUT configuration for testing is installed on RF field strength measurement to meet the Commissions requirement and operating in a manner that intends to maximize its emission characteristics in a continuous normal application.

3.2. EUT EXERCISE

The EUT was operated in the engineering mode to fix the TX frequency that was for the purpose of the measurements.

According to its specifications, the EUT must comply with the requirements of the Section 15.207, 15.209 and 15.247 under the FCC Rules Part 15 Subpart C.

3.3. GENERAL TEST PROCEDURES

Conducted Emissions

The EUT is placed on the turntable, which is 0.8 m above ground plane. According to the requirements in Section 13.1.4.1 of ANSI C63.4 (2009) Conducted emissions from the EUT measured in the frequency range between 0.15 MHz and 30MHz using CISPR Quasi-peak and average detector modes.

Radiated Emissions

The EUT is placed on a turn table, which is 0.8 m above ground plane. The turntable shall rotate 360 degrees to determine the position of maximum emission level. EUT is set 3m away from the receiving antenna, which varied from 1m to 4m to find out the highest emission. And also, each emission was to be maximized by changing the polarization of receiving antenna both horizontal and vertical. In order to find out the maximum emissions, exploratory radiated emission measurements were made according to the requirements in Section 13.1.4.1 of ANSI C63.4.



3.4. FCC PART 15.205 RESTRICTED BANDS OF OPERATIONS

(a) Except as shown in paragraph (d) of this section, only spurious emissions are permitted in any of the frequency bands listed below:

MHz	MHz	MHz	GHz
0.090 - 0.110	16.42 - 16.423	399.9 - 410	4.5 - 5.15
¹ 0.495 - 0.505	16.69475 - 16.69525	608 - 614	5.35 - 5.46
2.1735 - 2.1905	16.80425 - 16.80475	960 - 1240	7.25 - 7.75
4.125 - 4.128	25.5 - 25.67	1300 - 1427	8.025 - 8.5
4.17725 - 4.17775	37.5 - 38.25	1435 - 1626.5	9.0 - 9.2
4.20725 - 4.20775	73 - 74.6	1645.5 - 1646.5	9.3 - 9.5
6.215 - 6.218	74.8 - 75.2	1660 - 1710	10.6 - 12.7
6.26775 - 6.26825	108 - 121.94	1718.8 - 1722.2	13.25 - 13.4
6.31175 - 6.31225	123 - 138	2200 - 2300	14.47 - 14.5
8.291 - 8.294	149.9 - 150.05	2310 - 2390	15.35 - 16.2
8.362 - 8.366	156.52475 -	2483.5 - 2500	17.7 - 21.4
8.37625 - 8.38675	156.52525	2655 - 2900	22.01 - 23.12
8.41425 - 8.41475	156.7 - 156.9	3260 - 3267	23.6 - 24.0
12.29 - 12.293	162.0125 - 167.17	3332 - 3339	31.2 - 31.8
12.51975 - 12.52025	167.72 - 173.2	3345.8 - 3358	36.43 - 36.5
12.57675 - 12.57725	240 - 285	3600 - 4400	(²)
13.36 - 13.41	322 - 335.4		

¹ Until February 1, 1999, this restricted band shall be 0.490-0.510 MHz.

² Above 38.6

(b) Except as provided in paragraphs (d) and (e), the field strength of emissions appearing within these frequency bands shall not exceed the limits shown in Section 15.209. At frequencies equal to or less than 1000 MHz, compliance with the limits in Section 15.209 shall be demonstrated using measurement instrumentation employing a CISPR quasi-peak detector. Above 1000 MHz, compliance with the emission limits in Section 15.209 shall be demonstrated based on the average value of the measured emissions. The provisions in Section 15.35 apply to these measurements.



3.5. DESCRIPTION OF TEST MODES

The EUT (model: JC01) had been tested under operating condition and had been reported as worst case on this test report.

Test program used to control the EUT for staying in continuous transmitting mode was programmed.

After verification, all tests were carried out with the worst case test modes as shown below except radiated spurious emission below 1GHz and power line conducted emissions below 30MHz, which worst case was in normal link mode only.

Channel Low (2402MHz), Mid (2440MHz) and High (2480MHz) with 1Mbps data rate was chosen for full testing.

The field strength of spurious emission was measured in the following position: EUT stand-up position (Z axis), lie-down position (X, Y axis). The worst emission was found in lie-down position (X axis) and the worst case was recorded.



4 INSTRUMENT CALIBRATION

The measuring equipment, which was utilized in performing the tests documented herein, has been calibrated in accordance with the manufacturer's recommendations for utilizing calibration equipment, which is traceable to recognized national standards.

4.1. MEASUREMENT EQUIPMENT USED

Equipment Used for Emissions Measurement

Conducted Emissions Test Site				
Name of Equipment	Manufacturer	Model	Serial Number	Calibration Due
Spectrum Analyzer	Agilent	N9010A	MY52220817	01/13/2014
Power meter	Anritsu	ML2495A	1033009	02/22/2014
Power Sensor	Anritsu	MA2411B	0917221	09/29/2014
Spectrum Analyzer	Agilent	N9010A	MY52220817	09/29/2014

3M Semi Anechoic Chamber				
Name of Equipment	Manufacturer	Model	Serial Number	Calibration Due
Spectrum Analyzer	Agilent	E4446A	MY48250064	01/13/2014
Pre-Amplifier	HP	8447D	2944A06530	04/23/2014
Pre-Amplifier	EMEC	EM01M26G	060570	07/25/2014
Pre-Amplifier	MITEQ	AMF-6F-26040 0-40-8P	985646	08/08/2014
Pre-Amplifier	Agilent	8449B	3008A01738	04/23/2014
EMI Test Receiver	SCHAFFNER	SCR 3501	430	03/24/2014
Loop Antenna	EMCO	6502	2356	06/12/2014
Bilog Antenna	TESEQ	CBL 6112D	35378	09/11/2014
Horn Antenna	EMCO	3115	00022250	08/04/2014
Horn Antenna	EMCO	3116	00026370	01/07/2014
Antenna Tower	CCS	CC-A-1F	N/A	N.C.R
Turn Table	CCS	CC-T-1F	N/A	N.C.R
Test S/W	EZ-EMC			

NOTE: 1. The calibration interval of the above test instruments is 12 months and the calibrations are traceable to NML/ROC and NIST/USA.
 2. N.C.R = No Calibration Request.



Powerline Conducted Emissions Test Site #4				
Name of Equipment	Manufacturer	Model	Serial Number	Calibration Due
EMI Test Receiver	R&S	ESCI	100782	06/14/2014
LISN	R&S	ENV216	100066	09/01/2014
LISN	R&S	ENV 4200	830326/016	05/30/2014
ISN	FCC	FCC-TLISN-T2-02	20587	08/01/2014
ISN	TESEQ	ISN-T8	30843	08/16/2014
Current Probe	FCC	F-35	506	07/19/2014
ISN	TESEQ	ISN ST08	27907	09/30/2014
Test S/W	EZ-EMC			

NOTE: 1. The calibration interval of the above test instruments is 12 months and the calibrations are traceable to NML/ROC and NIST/USA.

2. N.C.R = No Calibration Request.



4.2. MEASUREMENT UNCERTAINTY

For the test methods, according to the present document, the measurement uncertainty figures shall be calculated in accordance with TR 100 028-1 [2] and shall correspond to an expansion factor (coverage factor) $k = 1,96$ or $k = 2$ (which provide confidence levels of respectively 95 % and 95,45 % in the case where the distributions characterizing the actual measurement uncertainties are normal (Gaussian)).

Table 6 is based on such expansion factors.

Table 6: Maximum measurement uncertainty

Parameter	Uncertainty
Powerline Conducted Emission	± 0.9203
3M Semi Anechoic Chamber / 30MHz ~ 200MHz	± 3.5921
3M Semi Anechoic Chamber / 200MHz ~ 1GHz	± 3.5657
3M Semi Anechoic Chamber / 1 ~ 8GHz	± 2.5873
3M Semi Anechoic Chamber / 8 ~ 18GHz	± 2.6646
3M Semi Anechoic Chamber / 18 ~ 26GHz	± 2.9617
3M Semi Anechoic Chamber / 26 ~ 40GHz	± 3.4250

Remark: This uncertainty represents an expanded uncertainty expressed at approximately the 95% confidence level using a coverage factor of $k=2$.



5 FACILITIES AND ACCREDITATIONS

5.1. FACILITIES

All measurement facilities used to collect the measurement data are located at

- No.199, Chunghsen Road, Hsintien City, Taipei Hsien, Taiwan, R.O.C.
Tel: 886-2-2217-0894 / Fax: 886-2-2217-1029

- No.11, Wugong 6th Rd., Wugu Industrial Park, Taipei Hsien 248, Taiwan
Tel: 886-2-2299-9720 / Fax: 886-2-2298-4045

- No.81-1, Lane 210, Bade 2nd Rd., Lujhu Township, Taoyuan County 33841, Taiwan, R.O.C.
Tel: 886-3-324-0332 / Fax: 886-3-324-5235

The sites are constructed in conformance with the requirements of ANSI C63.7, ANSI C63.4 and CISPR Publication 22.

5.2. EQUIPMENT

Radiated emissions are measured with one or more of the following types of linearly polarized antennas: tuned dipole, biconical, log periodic, bi-log, and/or ridged waveguide, horn. Spectrum analyzers with pre-selectors and quasi-peak detectors are used to perform radiated measurements.



Conducted emissions are measured with Line Impedance Stabilization Networks and EMI Test Receivers.

Calibrated wideband preamplifiers, coaxial cables, and coaxial attenuators are also used for making measurements.

All receiving equipment conforms to CISPR Publication 16-1, "Radio Interference Measuring Apparatus and Measurement Methods."



5.3. TABLE OF ACCREDITATIONS AND LISTINGS

Country	Agency	Scope of Accreditation	Logo
USA	A2LA	CFR 47, FCC Part15/18, CISPR 22, EN 55022, ICES-003, AS/NZS CISPR 22, VCCI V-3, EN 55011, CISPR 11, IEC/EN 61000-4-2/3/4/5/6/8/11, EN 61000-6-1/2/3/4, EN 55024, CISPR 24, AS/NZS CISPR 24, AS/NZS 61000.6.2, EN 55014-1/-2, ETSI EN 300 386 v1.3.2/v1.3.3, IEC/EN 61000-3-2, AS/NZS 61000.3.2, IEC/EN 61000-3-3, AS/NZS 61000.3.3	 TESTING CERT #0824.01
USA	FCC MRA	3 meter Open Area Test Sites to perform FCC Part 15/18 measurements	
Japan	VCCI	3/10 meter Open Area Test Sites and conducted test sites to perform radiated/conducted measurements	VCCI R-2882/2541/2798/725/1868 C-402/747/912 T-1930/1646
Taiwan	TAF	EN 55014-1, CISPR 14, CNS 13781-1, EN 55013, CISPR 13, CNS 13439, EN 55011, CISPR 11, CNS 13803, PLMN09, IS2045-0, LP0002 FCC Part 27/90, Part 15B/C/D/E, RSS-192/193/210/310 ETSI EN 300 328/ 300 220-1/ 300 220-2/ 301 893/ 301 489-01/ 301 489-03/ 301 489-07 / 301 489-17/ 300 440-1/ 300 440-2 AS/NZS 4268, AS/NZS 4771 CISPR 22, EN 55022, CNS 13438, AS/NZS CISPR 22, VCCI, IEC/EN 61000-4-2/3/4/5/6/8/11, CNS 14676-2/3/4/5/6/8, CNS 14934-2/3, CNS 13783-1, CNS 13439, CNS 13803	
Taiwan	BSMI	CNS 13438, CNS 13783-1, CNS 13439, CNS 14115	SL2-IS-E-0014 / IN-E-0014 /A1-E-0014 /R1-E-0014 /R2-E-0014 /L1-E-0014
Canada	Industry Canada	RSS-Gen Issue 3	

Note: No part of this report may be used to claim or imply product endorsement by A2LA, TAF or other government agency.



6 SETUP OF EQUIPMENT UNDER TEST

6.1. SETUP CONFIGURATION OF EUT

See test photographs attached in Appendix 1 for the actual connections between EUT and support equipment.

6.2. SUPPORT EQUIPMENT

For Radiated Emission (Below 1GHz) and Power Line Conducted Emission measurement							
No.	Equipment	Model No.	Serial No.	FCC ID	Trade Name	Data Cable	Power Cord
1	Notebook PC	S7110	DU4A00EG0944P01 0	FCC DoC	Fujitsu	N/A	AC I/P: Unshielded, 1.8m DC O/P: Unshielded, 1.8m with a core
2	LCD Monitor	U2410	CN-OJ257M-72872- 99N-O5AL	FCC DoC	DELL	D-Sub Cable: Shielded, 1.8m with two core	Unshielded, 1.8m
3	USB Mouse	M-UVE69	N/A	FCC DoC	HP	Unshielded, 1.8m	N/A

For Conducted & Radiated Emission measurement (Above 1GHz):							
No.	Equipment	Model No.	Serial No.	FCC ID	Trade Name	Data Cable	Power Cord
1	Notebook PC	S7110	DU4A00EG0944P01 0	FCC DoC	Fujitsu	N/A	AC I/P: Unshielded, 1.8m DC O/P: Unshielded, 1.8m with a core

Remark: Grounding was established in accordance with the manufacturer's requirements and conditions for the intended use.



7 FCC PART 15.247 REQUIREMENTS

7.1. 6dB bandwidth

LIMIT

According to §15.247(a)(2), systems using digital modulation techniques may operate in the 902 - 928 MHz, 2400 - 2483.5 MHz, and 5725 - 5850 MHz bands. The minimum 6 dB bandwidth shall be at least 500 kHz.

Test Configuration

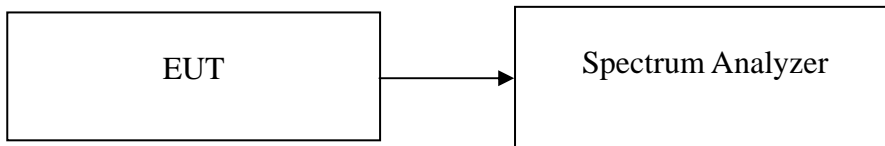

TEST PROCEDURE

The transmitter output is connected to the spectrum analyzer. Set the RBW=100kHz the emission bandwidth, VBW $\geq 3 \times$ RBW, Detector = Peak, Trace mode = max hold, Sweep = auto couple. Measure the maximum width of the emission that is constrained by the frequencies associated with the two amplitude points (upper and lower) that are attenuated by 6dB relative to the maximum level measured in the fundamental emission.

TEST RESULTS

No non-compliance noted

Test Data

Channel	Frequency (MHz)	6dB Bandwidth (kHz)	Limit (kHz)	Test Result
Low	2402	580	>500	PASS
Mid	2440	580		PASS
High	2480	580		PASS



Test Plot

CH Low

Agilent

R T

Mkr1 580 kHz
0.47 dB

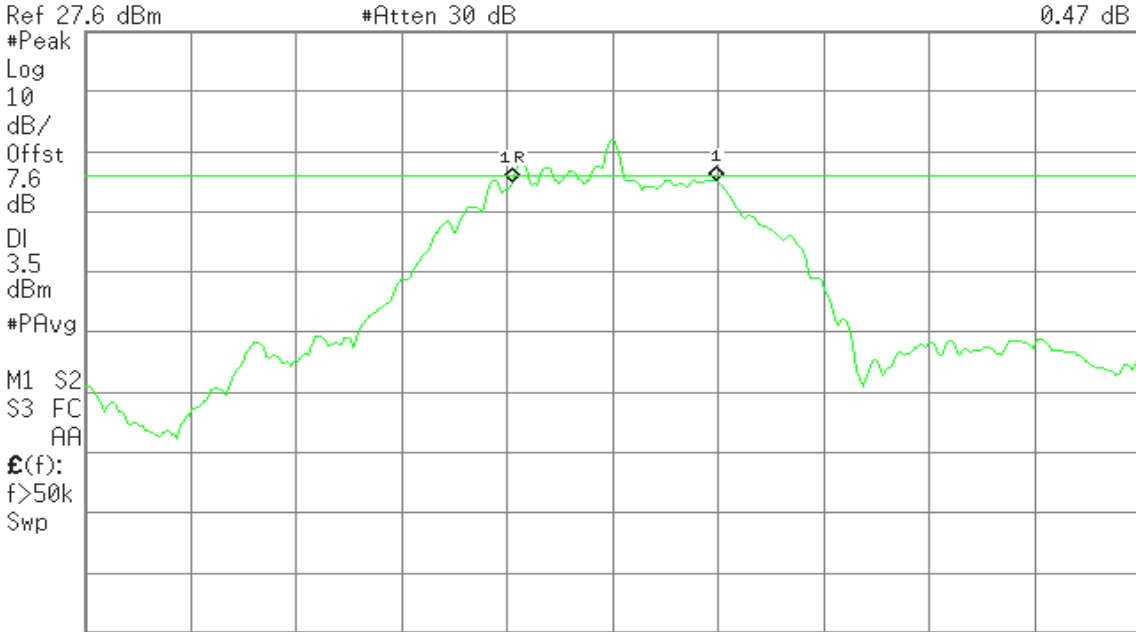

Center 2.402 000 GHz Span 3 MHz
#Res BW 30 kHz #VBW 100 kHz Sweep 3.2 ms (601 pts)

CH Mid

Agilent

R T

Mkr1 580 kHz
0.42 dB

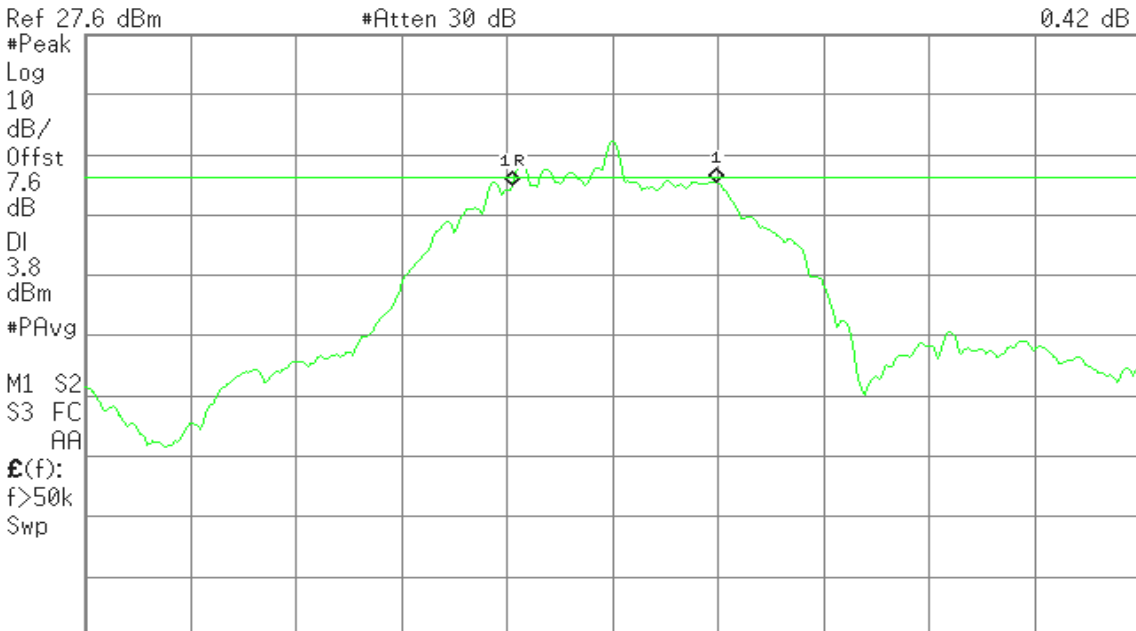

Center 2.440 000 GHz Span 3 MHz
#Res BW 30 kHz #VBW 100 kHz Sweep 3.2 ms (601 pts)



CH High

Agilent

R T

Mkr1 580 kHz
0.18 dB

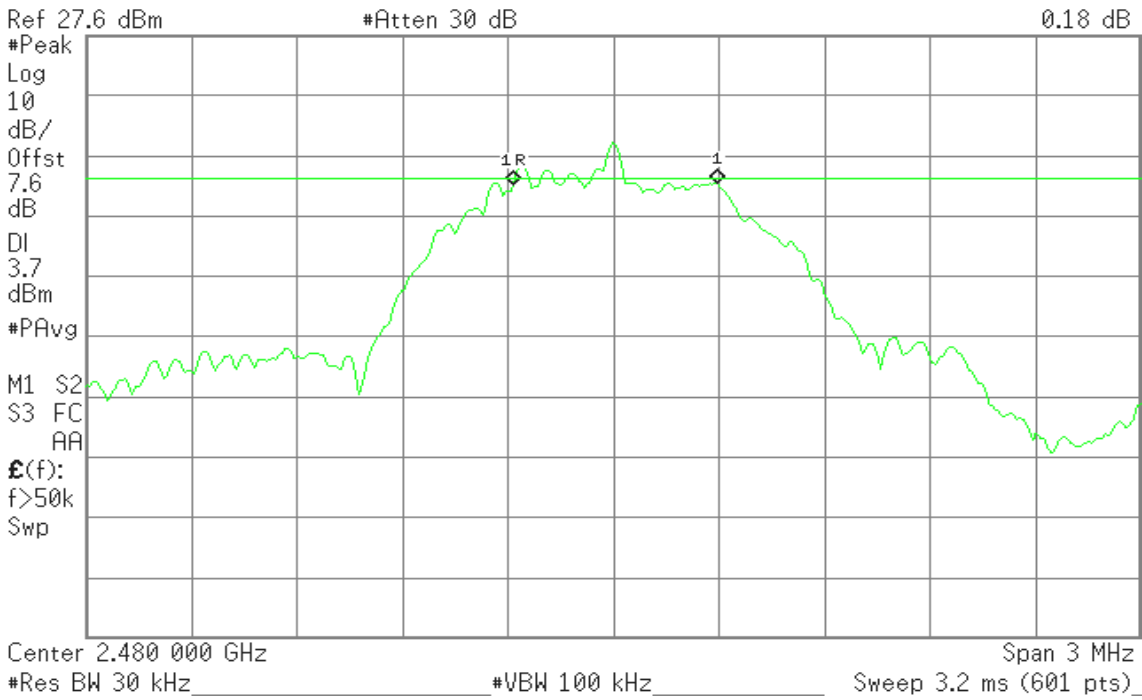



7.2. PEAK POWER

LIMIT

According to §15.247, the maximum peak output power of the intentional radiator shall not exceed the following:

1. According to §15.247(b)(3), for systems using digital modulation in the bands of 902-928 MHz, 2400-2483.5 MHz, and 5725-5850 MHz: 1 watt.
2. According to §15.247(b) (4), the conducted output power limit specified in paragraph (b) of this section is based on the use of antennas with directional gains that do not exceed 6 dBi. Except as shown in paragraph (c) of this section, if transmitting antennas of directional gain greater than 6 dBi are used, the conducted output power from the intentional radiator shall be reduced below the stated values in paragraphs (b)(1), (b)(2), and (b)(3) of this section, as appropriate, by the amount in dB that the directional gain of the antenna exceeds 6 dBi.

TEST CONFIGURATION

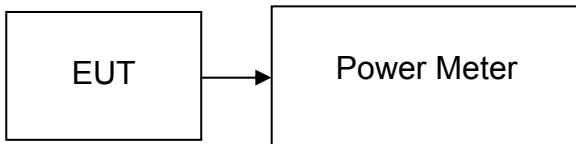

TEST PROCEDURE

Per KDB 558074 v03r01

The transmitter output is connected to the Power Meter. The Power Meter is set to the peak power detection.

TEST RESULTS

No non-compliance noted

TEST DATA

Channel	Frequency (MHz)	Output Power (dBm)	Output Power (W)	Limit (W)	Test Result
Low	2402	1.52	0.0014	1	PASS
Mid	2440	1.88	0.0015		PASS
High	2480	2.52	0.0018		PASS



7.3. AVERAGE POWER

LIMIT

None; for reporting purposes only.

TEST CONFIGURATION

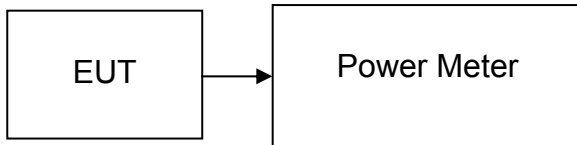

TEST PROCEDURE

Per KDB 558074 v03r01

The transmitter output is connected to the Power Meter. The Power Meter is set to the peak power detection.

TEST RESULTS

No non-compliance noted

TEST DATA

Channel	Frequency (MHz)	Output Power (dBm)	Output Power (W)
Low	2402	-1.10	0.0008
Mid	2440	-0.73	0.0008
High	2480	-0.09	0.0010



7.4. BAND EDGES MEASUREMENT

LIMIT

According to §15.247(d), in any 100 kHz bandwidth outside the frequency bands in which the spread spectrum intentional radiator is operating, the radio frequency power that is produced by the intentional radiator shall be at least 20 dB below that in the 100 kHz bandwidth within the band that contains the highest level of the desired power, based on either an RF conducted or a radiated measurement, provided the transmitter demonstrates compliance with the peak conducted power limits. In addition, radiated emissions which fall in the restricted bands, as defined in §15.205(a), must also comply with the radiated emission limits specified in 15.209(a) (see Section 15.205(c)).

TEST CONFIGURATION

For Radiated

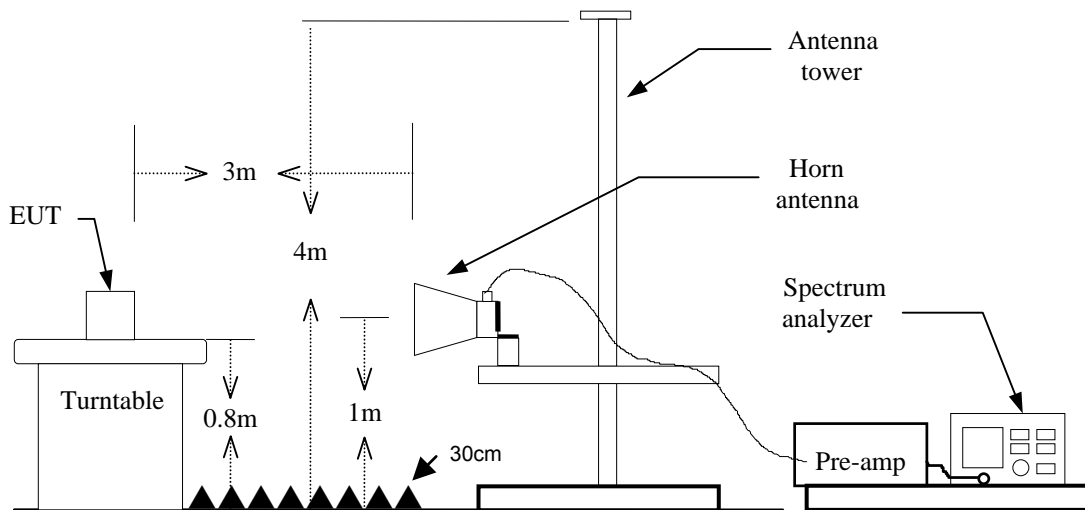

For Conducted

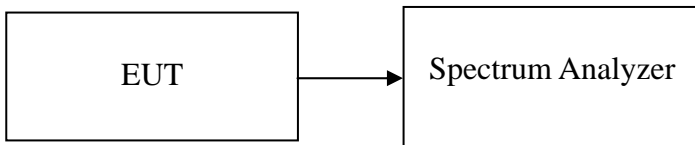



TEST PROCEDURE

For Radiated

1. The EUT is placed on a turntable, which is 0.8m above the ground plane.
2. The turntable shall be rotated for 360 degrees to determine the position of maximum emission level.
3. EUT is set 3m away from the receiving antenna, which is varied from 1m to 4m to find out the highest emission.
4. Set the spectrum analyzer in the following setting in order to capture the lower and upper band-edges of the emission:
 - (a) PEAK: RBW=1MHz / VBW=3MHz / Sweep=AUTO
 - (b) AVERAGE: RBW=1MHz / VBW= 10Hz / Sweep=AUTO
5. Repeat the procedures until all the PEAK and AVERAGE versus POLARIZATION are measured.

For Conducted

Conducted RF measurements of the transmitter output were made to confirm that the EUT antenna port conducted emissions meet the specified limit and to identify any spurious signals that require further investigation or measurements on the radiated emissions site.

The transmitter output is connected to the spectrum analyzer. The resolution bandwidth is set to 100 kHz. The video bandwidth is set to 100 kHz.

TEST RESULTS

Refer to attach spectrum analyzer data chart.



CH Low

Detector mode: Peak

Polarity: Vertical

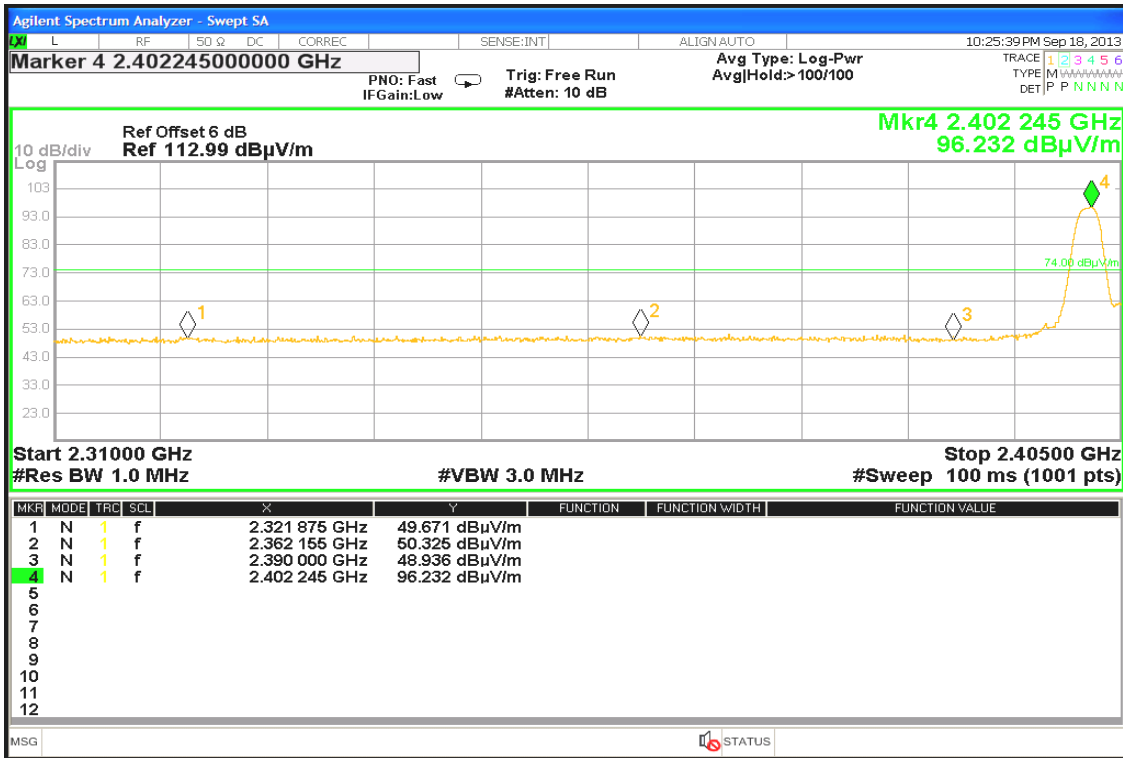

Detector mode: Average

Polarity: Vertical

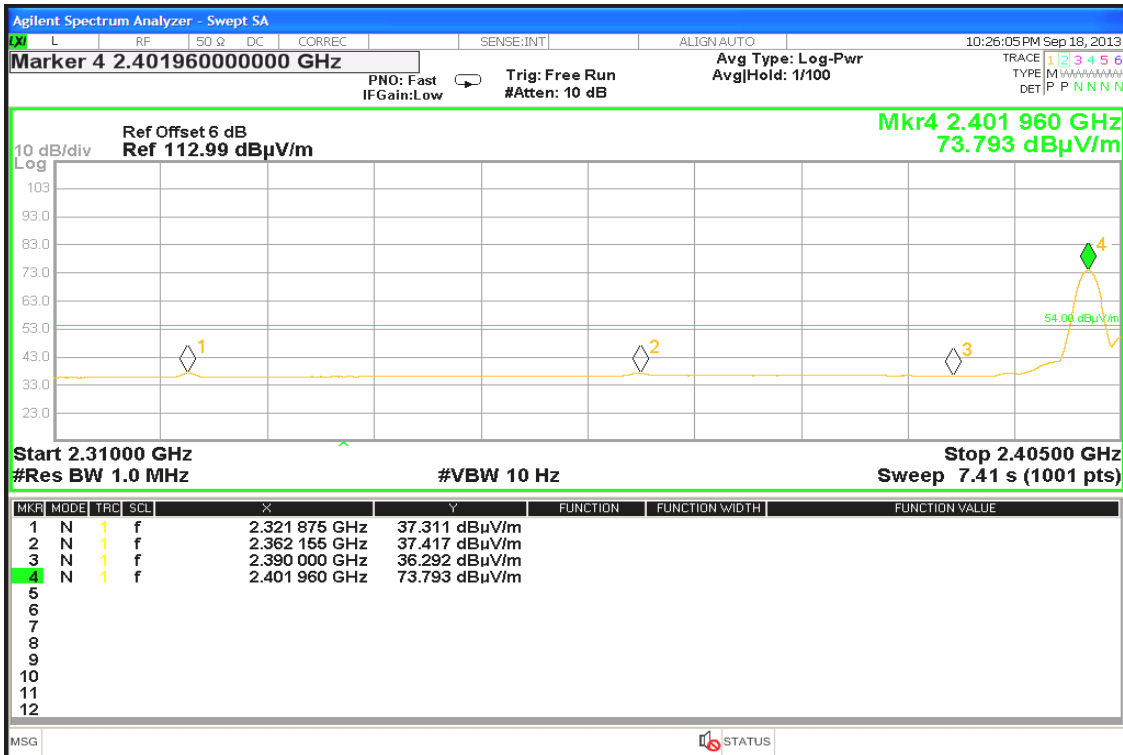



Detector mode: Peak

Polarity: Horizontal

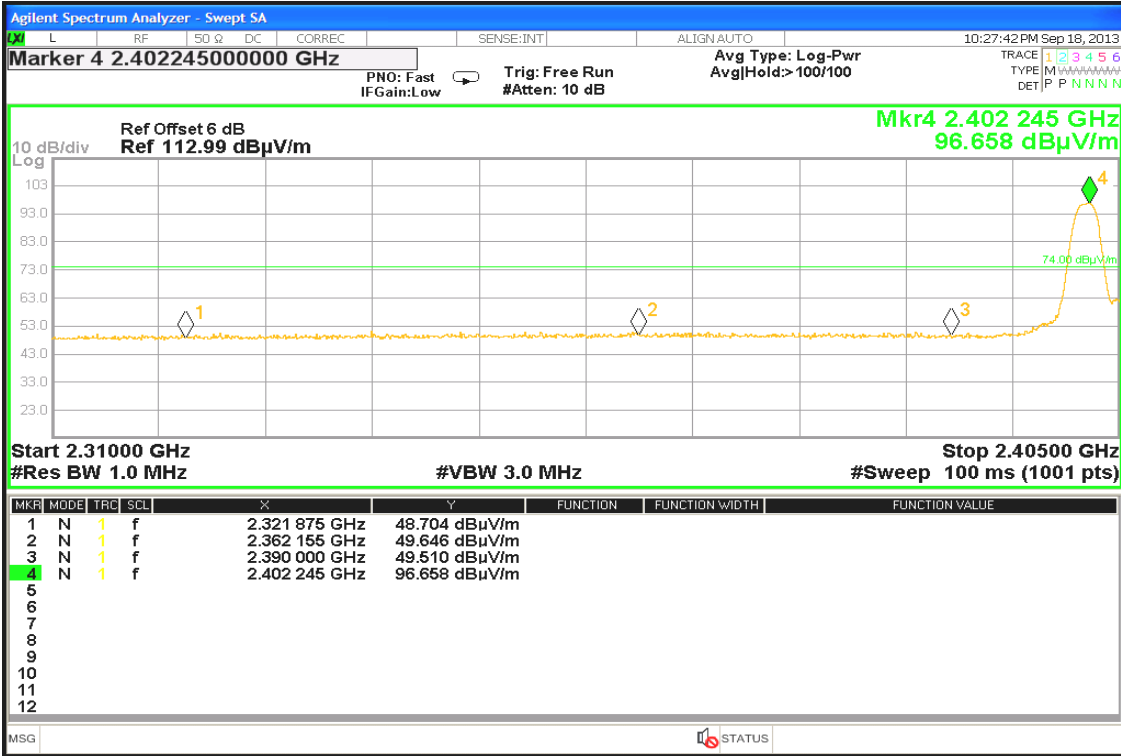

Detector mode: Average

Polarity: Horizontal

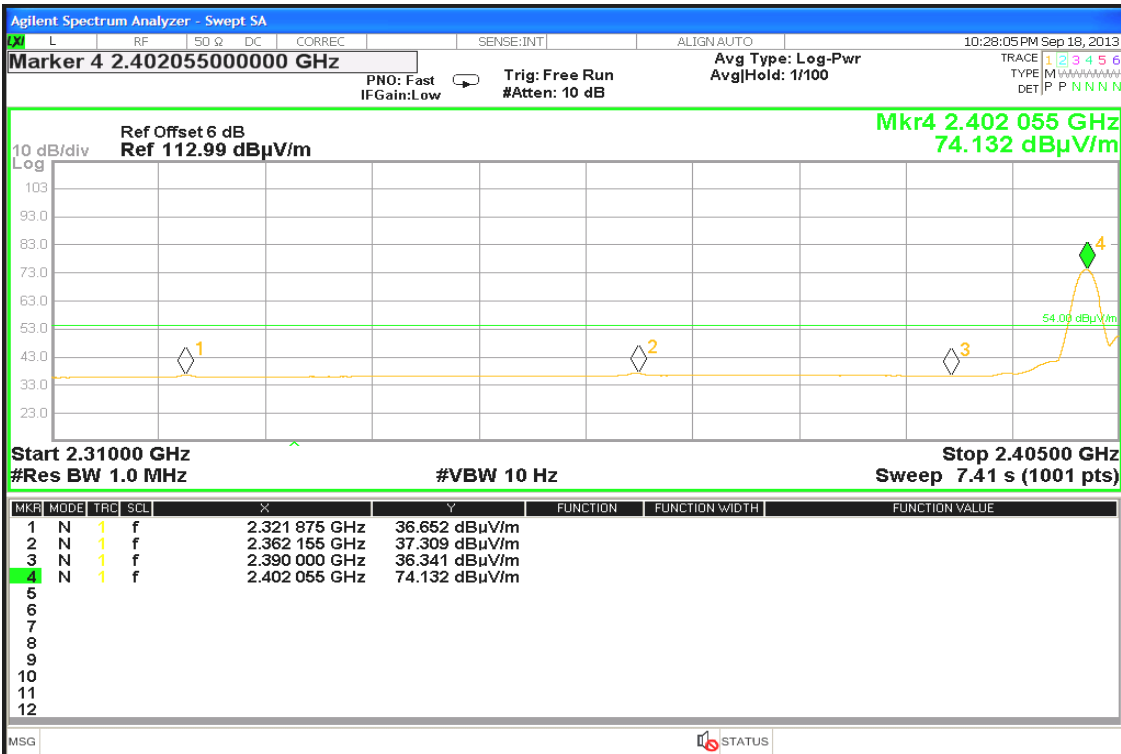



CH High

Detector mode: Peak

Polarity: Vertical

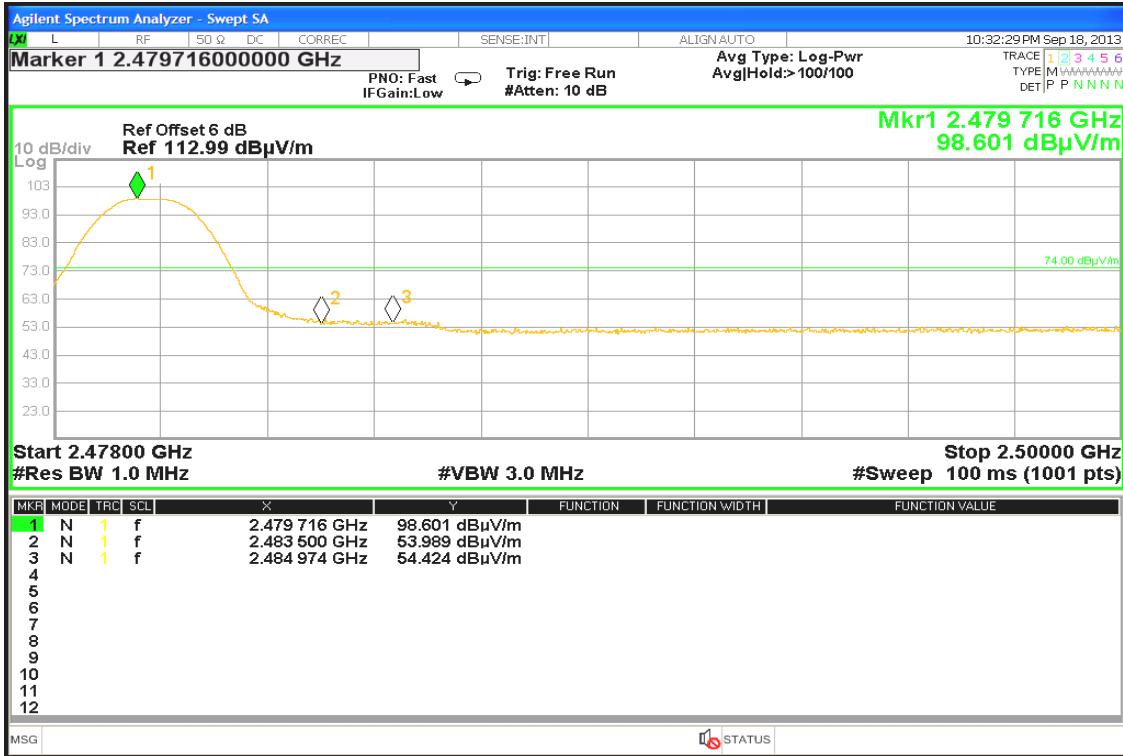

Detector mode: Average

Polarity: Vertical

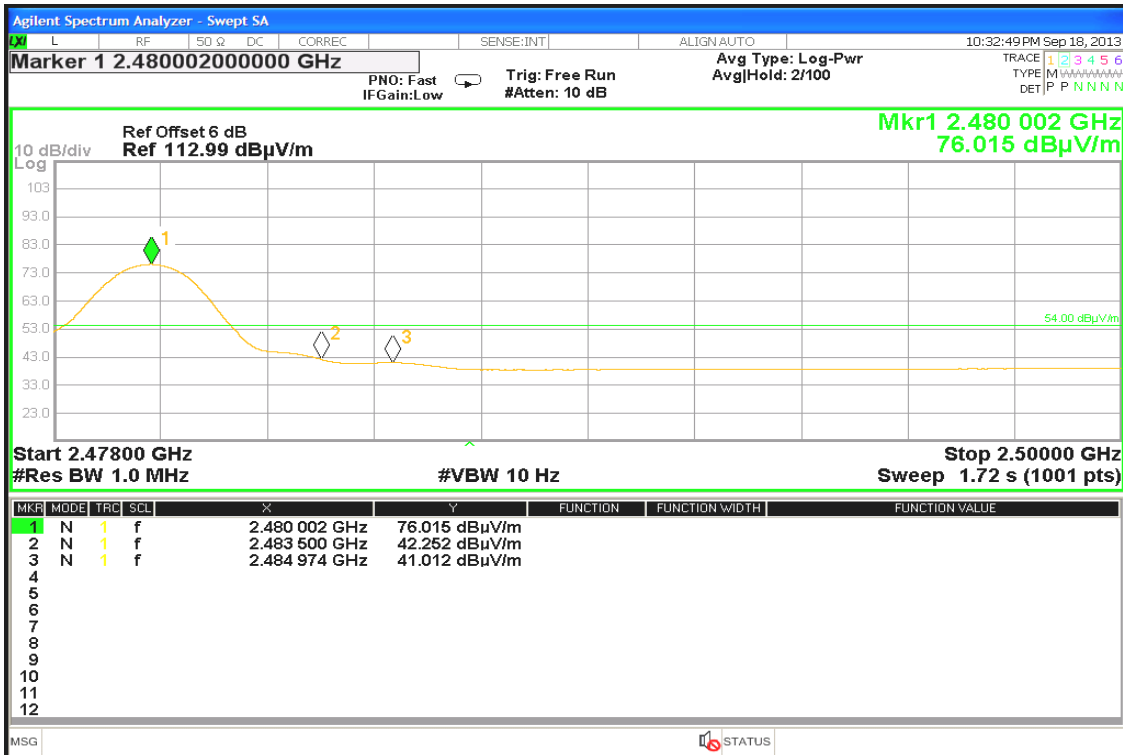



Detector mode: Peak

Polarity: Horizontal

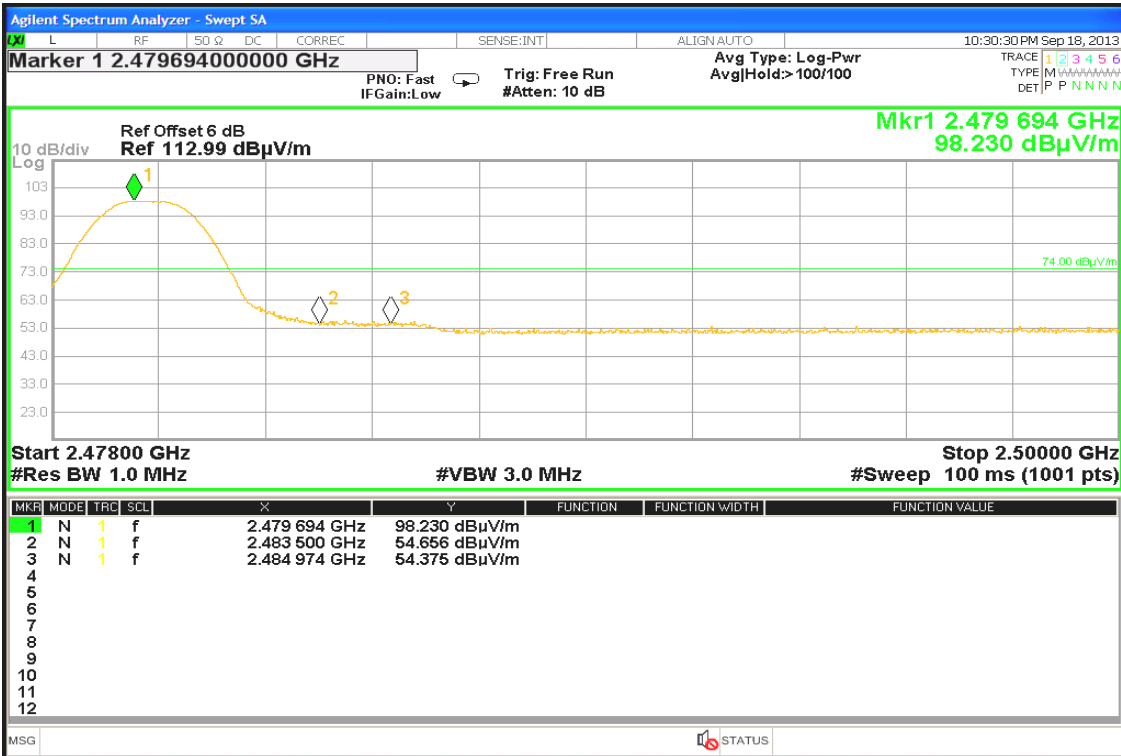

Detector mode: Average

Polarity: Horizontal

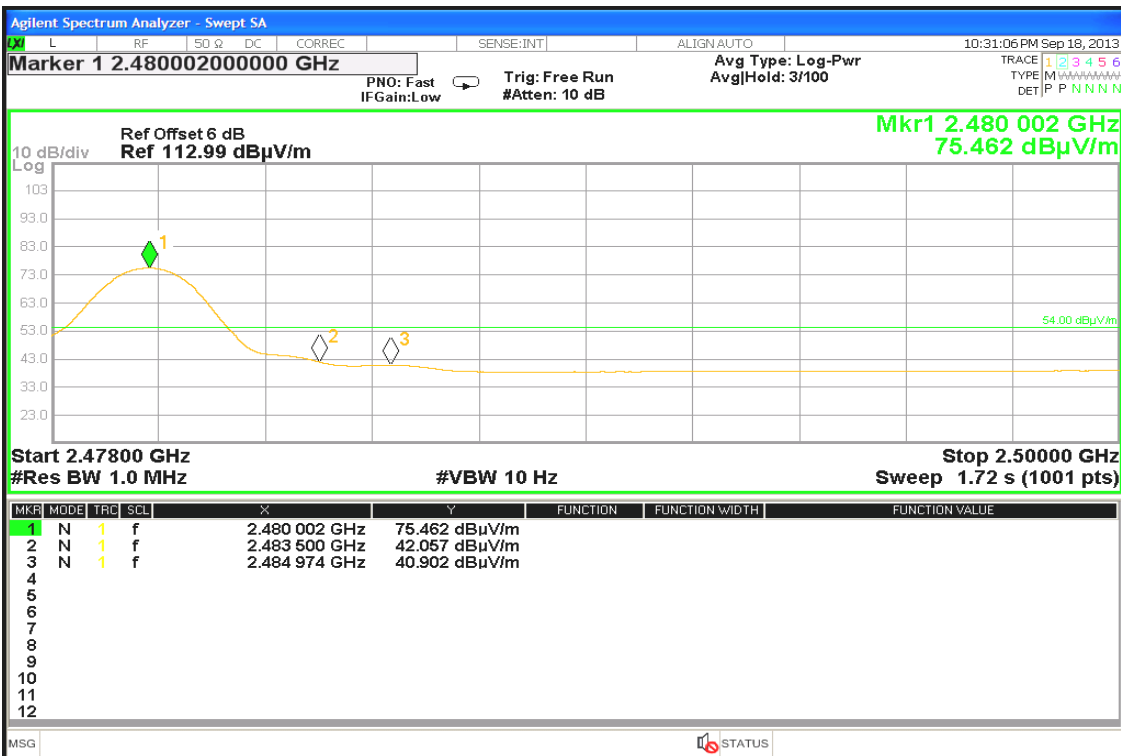



Conducted band-edge

CH Low

Agilent

R T

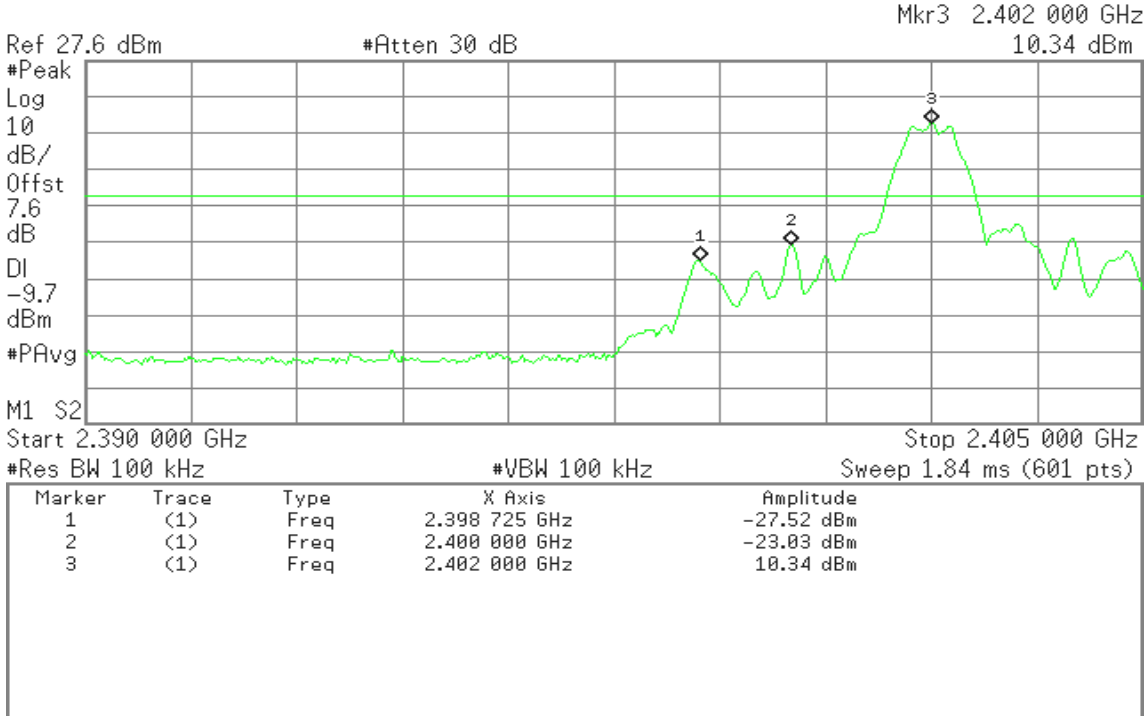

CH High

Agilent

R T

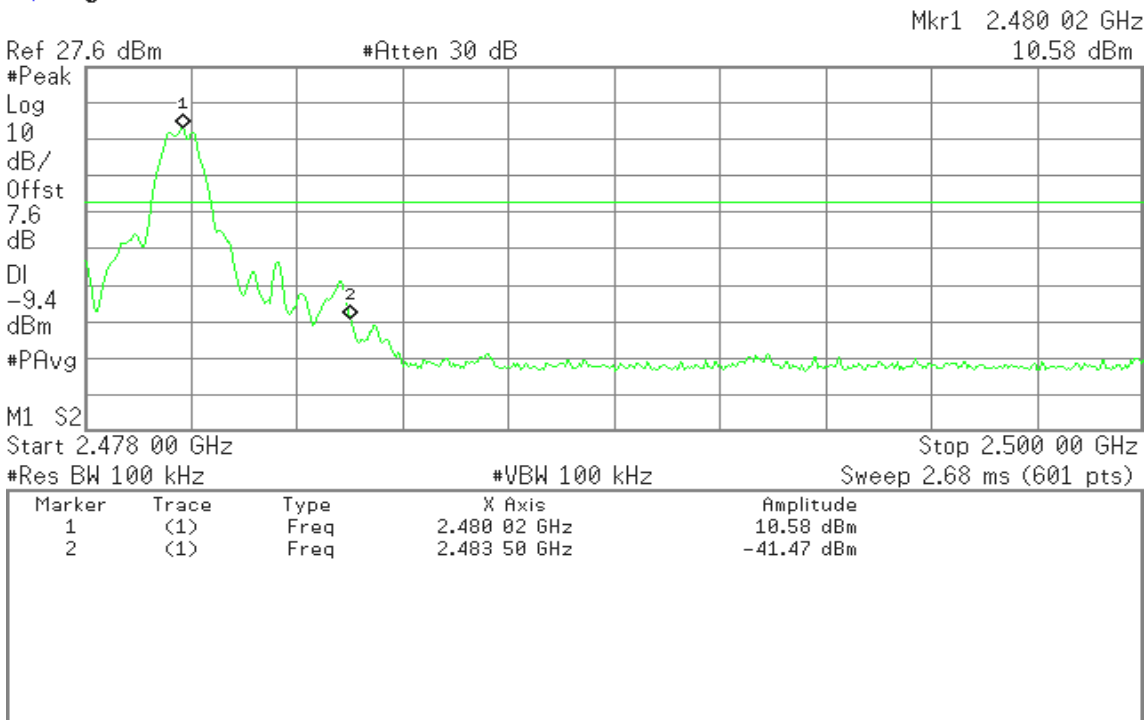



7.5. PEAK POWER SPECTRAL DENSITY

LIMIT

1. According to §15.247(e), for digitally modulated systems, the power spectral density conducted from the intentional radiator to the antenna shall not be greater than 8 dBm in any 3 kHz band during any time interval of continuous transmission.
2. According to §15.247(f), the digital modulation operation of the hybrid system, with the frequency hopping turned off, shall comply with the power density requirements of paragraph (d) of this section.

Test Configuration

TEST PROCEDURE

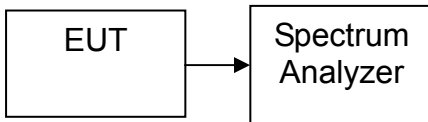

Per KDB 558074 v03r01

This procedure must be used if maximum peak conducted output power was used to demonstrate compliance to the fundamental output power limit, and is optional if the maximum (average) conducted output power was used to demonstrate compliance.

1. Set analyzer center frequency to DTS channel center frequency.
2. Set the span to 1.5 times the DTS channel bandwidth.
3. Set the RBW \geq 3 kHz.
4. Set the VBW \geq 3 x RBW.
5. Detector = peak.
6. Sweep time = auto couple.
7. Trace mode = max hold.
8. Allow trace to fully stabilize.

Use the peak marker function to determine the maximum amplitude level.

If measured value exceeds limit, reduce RBW (no less than 3 kHz) and repeat

TEST RESULTS

No non-compliance noted

TEST DATA

Channel	Frequency (MHz)	PPSD (dBm)	Limit (dBm)	Result
Low	2402	-5.09	8.00	PASS
Mid	2440	-5.02		PASS
High	2480	-5.21		PASS



Test Plot

CH Low

Agilent

R T

Mkr1 2.401 865 4 GHz
-5.09 dBm

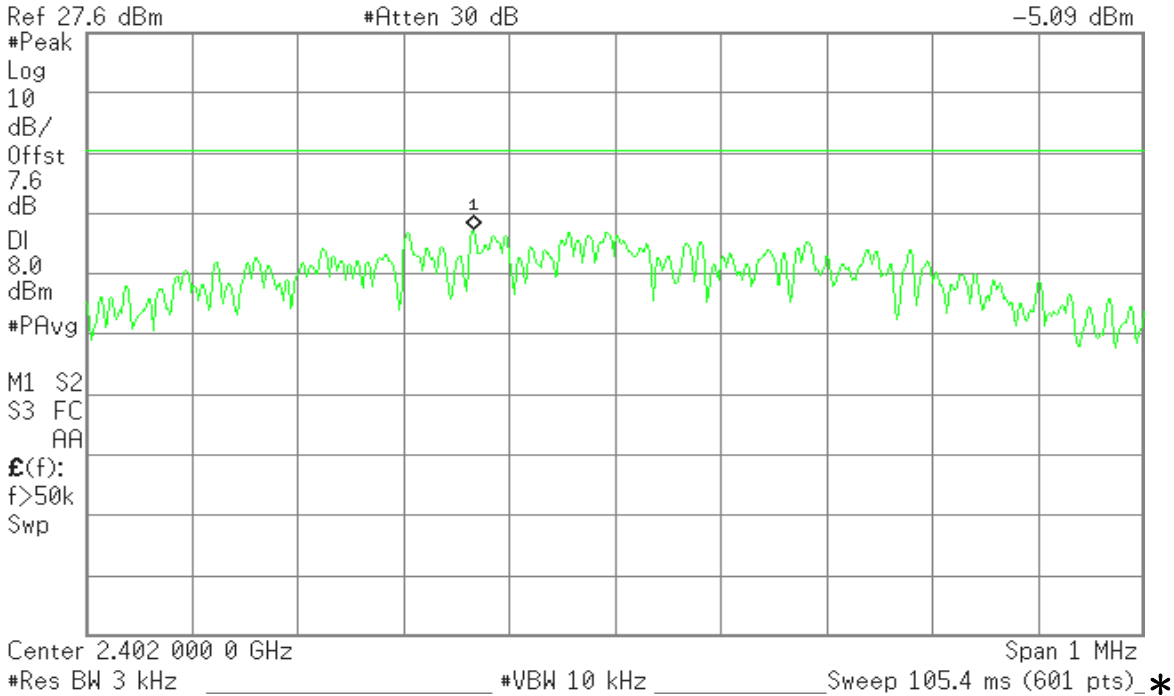

CH Mid

Agilent

R T

Mkr1 2.439 865 3 GHz
-5.02 dBm

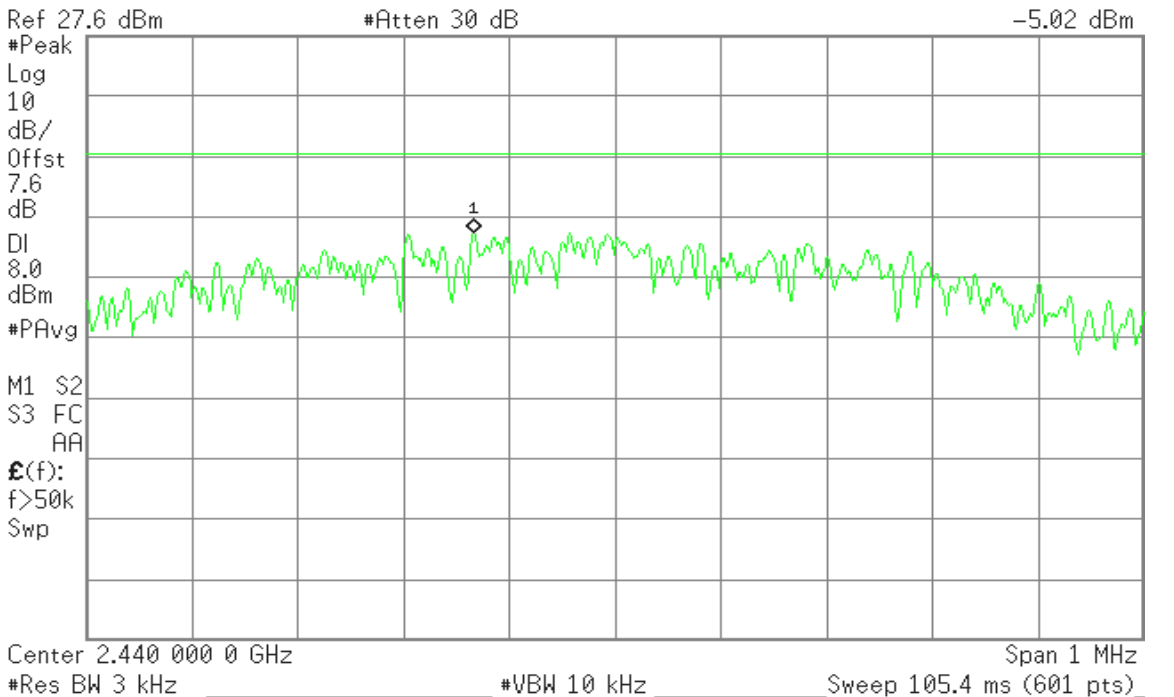



CH High

* Agilent

R T

Mkr1 2.479 989 9 GHz
-5.21 dBm

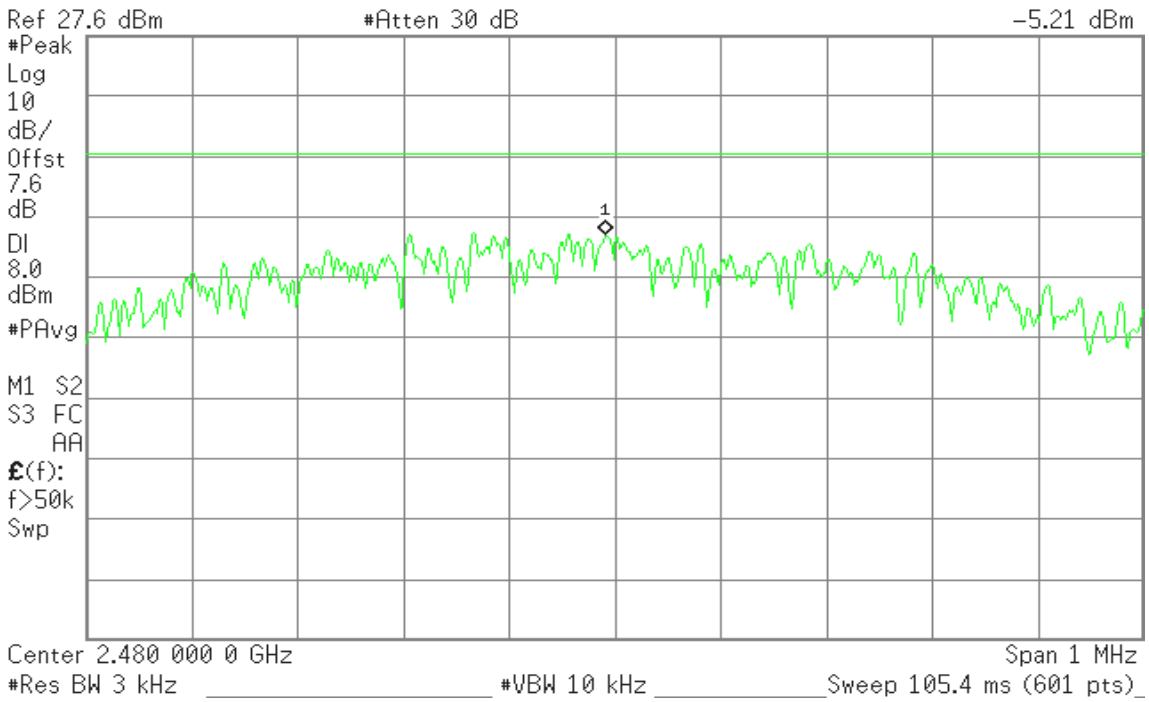



7.6. SPURIOUS EMISSIONS

7.6.1. Conducted Measurement

LIMIT

In any 100 kHz bandwidth outside the frequency band in which the spread spectrum or digitally modulated intentional radiator is operating, the radio frequency power that is produced by the intentional radiator shall be at least 20 dB below that in the 100 kHz bandwidth within the band that contains the highest level of the desired power, based on either an RF conducted or a radiated measurement. Attenuation below the general limits specified in Section 15.209(a) is not required. In addition, radiated emissions which fall in the restricted bands, as defined in Section 15.205(a), must also comply with the radiated emission limits specified in Section 15.209(a) (see Section 15.205(c)).

TEST CONFIGURATION

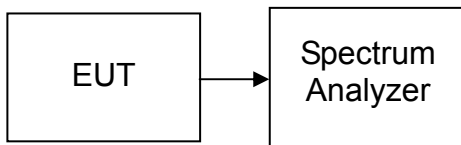

TEST PROCEDURE

Conducted RF measurements of the transmitter output were made to confirm that the EUT antenna port conducted emissions meet the specified limit and to identify any spurious signals that require further investigation or measurements on the radiated emissions site.

The transmitter output is connected to the spectrum analyzer. The resolution bandwidth is set to 100 kHz. The video bandwidth is set to 100 kHz.

Measurements are made over the 30MHz to 26GHz range with the transmitter set to the lowest, middle, and highest channels.

TEST RESULTS

No non-compliance noted

TEST DATA

Refer to attach spectrum analyzer data chart.



Test Plot

Spurious Emissions

CH Low

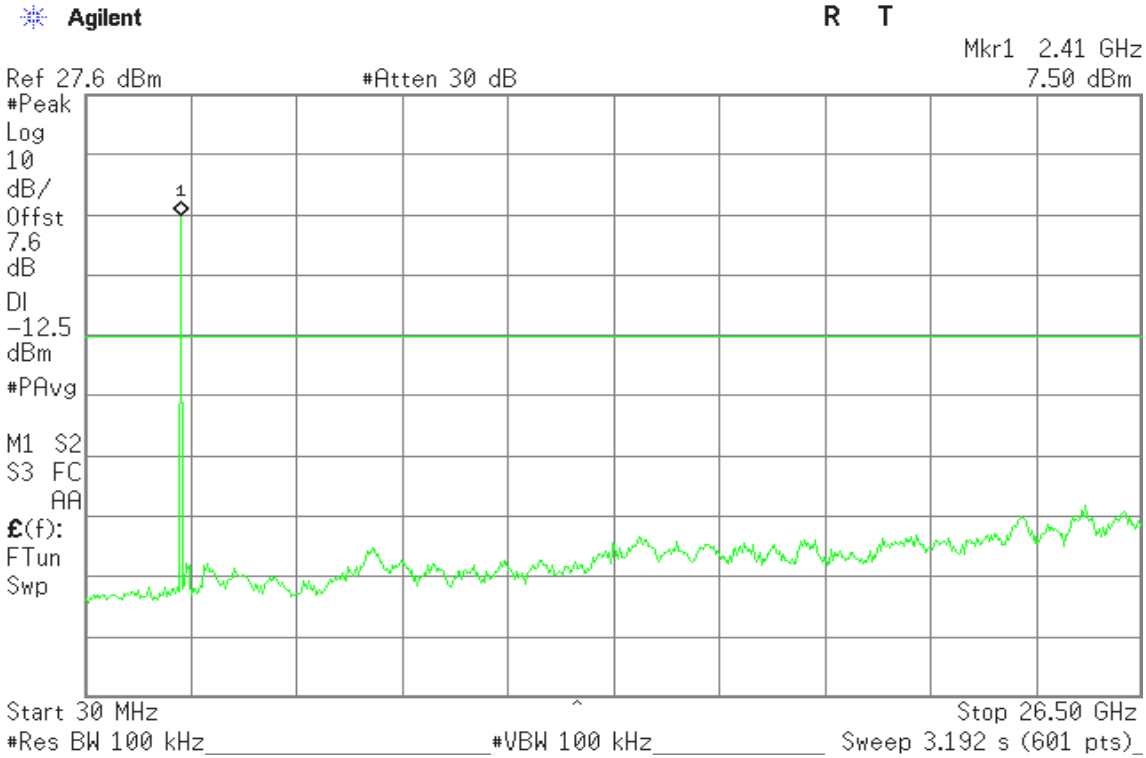

CH Mid

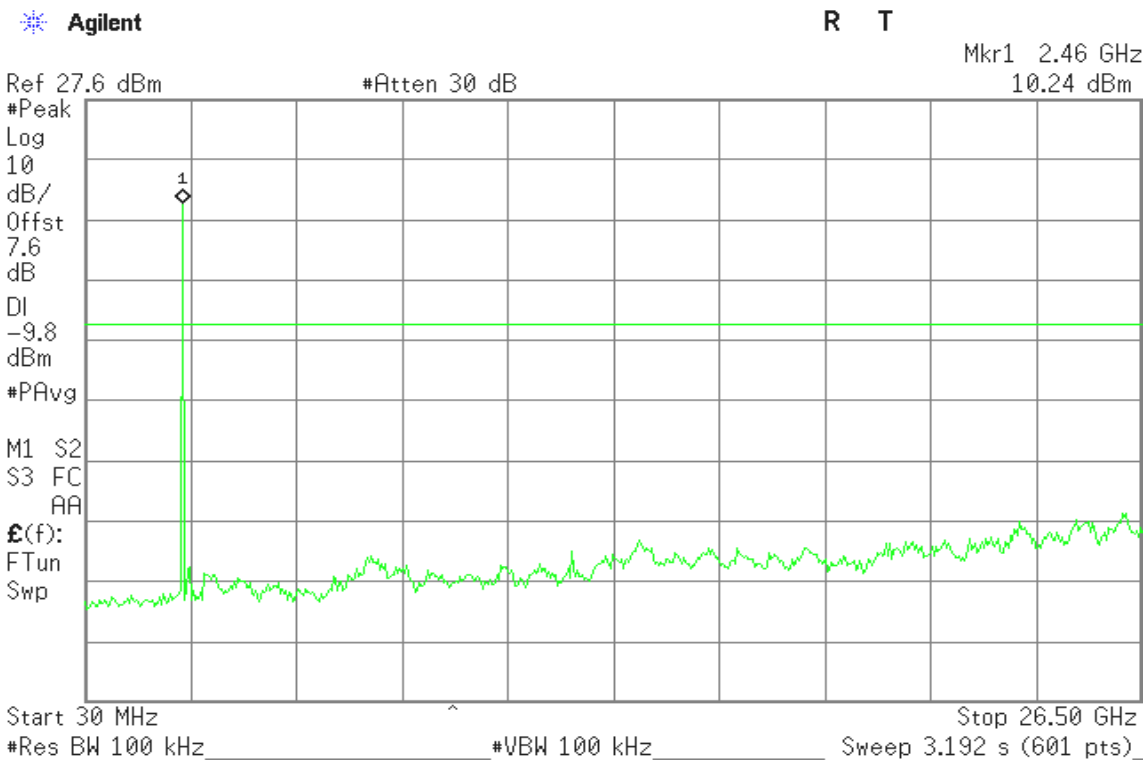



CH High

Agilent

R T

Mkr1 2.50 GHz
8.98 dBm

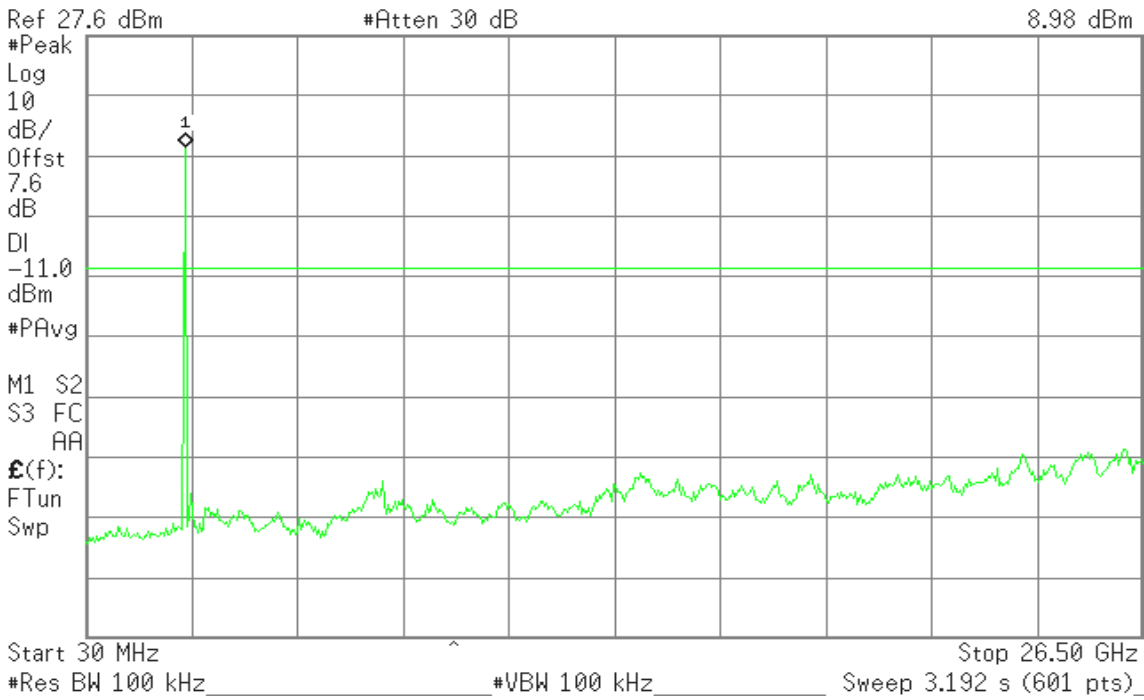



7.6.2. RADIATED EMISSIONS

LIMIT

1. According to §15.209(a), except as provided elsewhere in this Subpart, the emissions from an intentional radiator shall not exceed the field strength levels specified in the following table:

Frequency (MHz)	Field Strength (µV/m)	Measurement Distance (m)
0.009-0.490	2400/F(kHz)	300
0.490-1.705	24000/F(kHz)	30
1.705-30.0	30	30
30-88	100*	3
88-216	150*	3
216-960	200*	3
Above 960	500	3

Remark: Except as provided in paragraph (g), fundamental emissions from intentional radiators operating under this Section shall not be located in the frequency bands 54-72 MHz, 76-88 MHz, 174-216 MHz or 470-806 MHz. However, operation within these frequency bands is permitted under other sections of this Part, e.g., Sections 15.231 and 15.241.

2. In the emission table above, the tighter limit applies at the band edges.

Frequency (Hz)	Field Strength (µV/m at 3-meter)	Field Strength (dBµV/m at 3-meter)
30-88	100	40
88-216	150	43.5
216-960	200	46
Above 960	500	54



TEST CONFIGURATION

9kHz ~ 30MHz

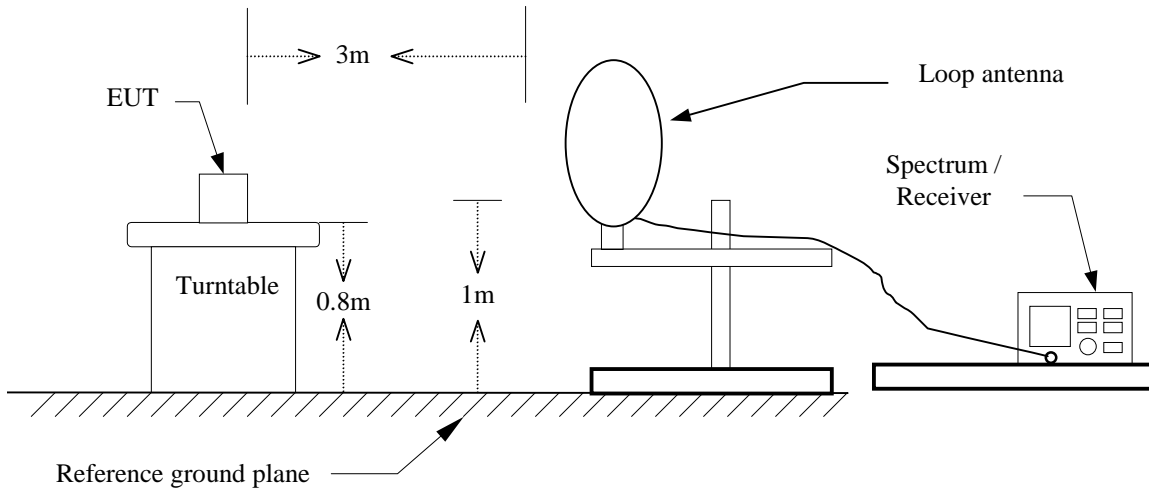

30MHz ~ 1GHz

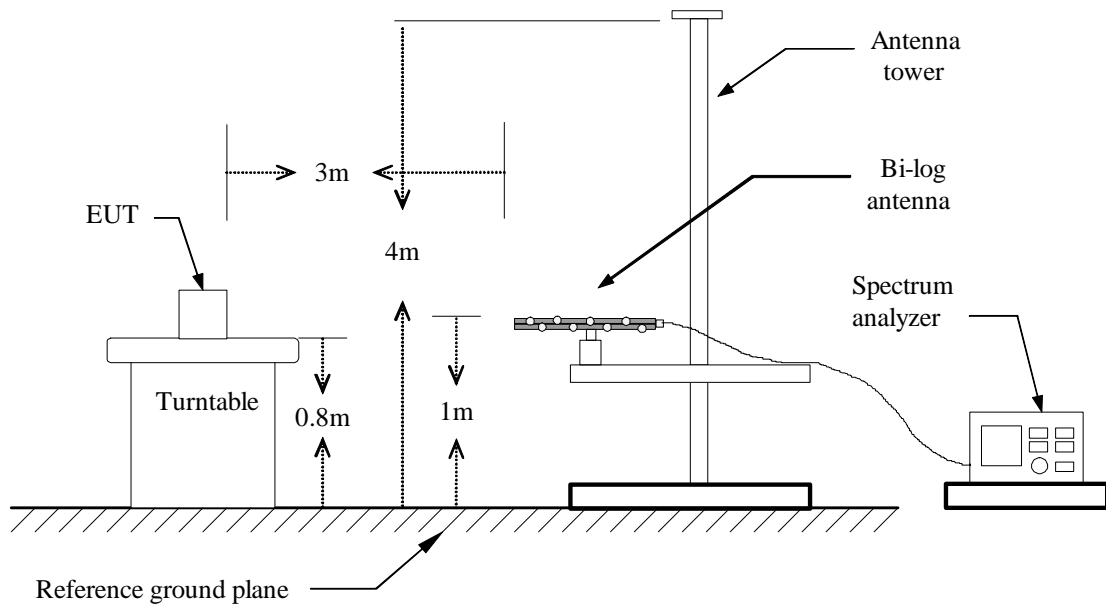



Above 1 GHz

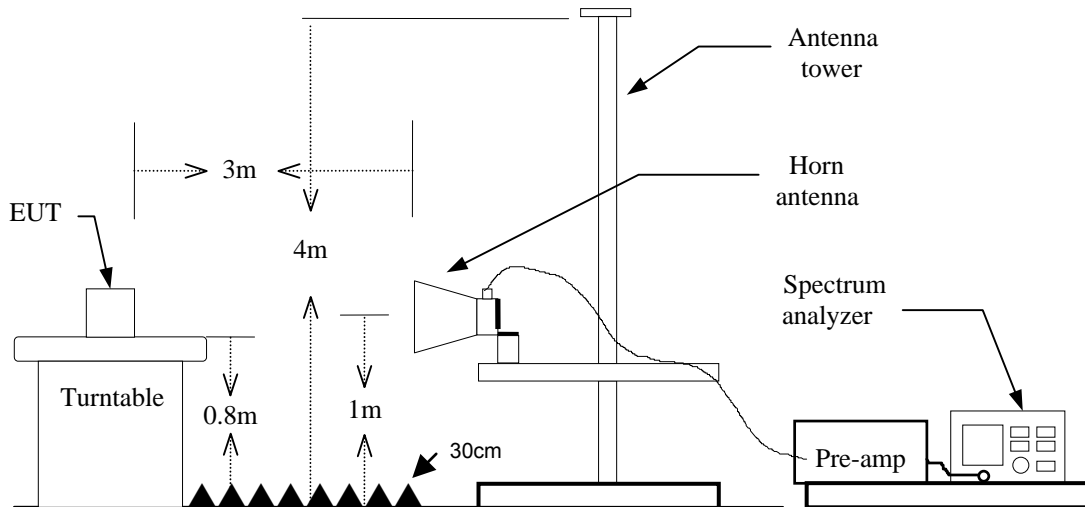

TEST PROCEDURE

1. The EUT is placed on a turntable, which is 0.8m above ground plane.
2. The turntable shall be rotated for 360 degrees to determine the position of maximum emission level.
3. EUT is set 3m away from the receiving antenna, which is varied from 1m to 4m to find out the highest emissions.
4. Maximum procedure was performed on the six highest emissions to ensure EUT compliance.
5. And also, each emission was to be maximized by changing the polarization of receiving antenna both horizontal and vertical.
6. Set the spectrum analyzer in the following setting as:

Below 30MHz

RBW=10kHz / VBW=30kHz / Sweep=AUTO

30 ~ 1000MHz:

RBW=100kHz / VBW=300KHz / Sweep=AUTO

Above 1GHz:

- a) PEAK: RBW=VBW=1MHz / Sweep=AUTO
- b) AVERAGE: RBW=1MHz / VBW=10Hz / Sweep=AUTO

7. Repeat above procedures until the measurements for all frequencies are complete.

In case the emission is lower than 30MHz. loop antenna has to be used for measurement and the recorded data should be QP measured by receiver. High - Low scan is not required in this case



TEST RESULTS

Below 1 GHz (9kHz ~ 30MHz)

No emission found between lowest internal used/generated frequency to 30MHz

Below 1 GHz (30 ~ 1000MHz)

No non-compliance noted

TEST DATA

Below 1 GHz

Operation Mode:	Transmitting	Test Date:	2013/8/27
Temperature:	26°C	Tested by:	Louis Shen
Humidity:	56 % RH	Polarity:	Ver. / Hor.

Frequency (MHz)	Reading (dBuV)	Correction Factor (dB/m)	Result (dBuV/m)	Limit (dBuV/m)	Margin (dB)	Ant. Pol. (H/V)	Remark
33.5700	30.40	-10.05	20.35	40.00	-19.65	V	QP
108.0200	45.00	-15.37	29.63	43.50	-13.87	V	QP
198.8700	40.00	-16.68	23.32	43.50	-20.18	V	QP
399.7500	50.30	-9.83	40.47	46.00	-5.53	V	QP
423.5600	42.40	-9.70	32.70	46.00	-13.30	V	QP
662.8600	43.30	-6.92	36.38	46.00	-9.62	V	QP
358.0600	46.10	-10.65	35.45	46.00	-10.55	H	QP
373.2400	45.00	-10.36	34.64	46.00	-11.36	H	QP
399.7800	52.70	-9.83	42.87	46.00	-3.13	H	QP
423.2000	45.30	-9.71	35.59	46.00	-10.41	H	QP
577.0800	46.50	-7.88	38.62	46.00	-7.38	H	QP
666.3600	42.00	-6.91	35.09	46.00	-10.91	H	QP

Remark:

- No emission found between lowest internal used / generated frequency to 30 MHz. (9kHz ~ 30MHz)*
- Measuring frequencies from 30 MHz to the 1GHz.*
- Radiated emissions measured in frequency range from 30 MHz to 1000MHz were made with an instrument using Peak detector mode.*
- Data of measurement within this frequency range shown " --- " in the table above means the reading of emissions are attenuated more than 20dB below the permissible limits or the field strength is too small to be measured.*
- The IF bandwidth of SPA between 30MHz to 1GHz was 100kHz.*



Above 1 GHz

Operation Mode: TX / CH Low **Test Date:** 2013/9/17
Temperature: 26°C **Tested by:** Francis Lee
Humidity: 56% RH **Polarity:** Ver. / Hor.

Freq. (MHz)	Reading (dBuV)	Correct Factor (dB/m)	Result (dBuV/m)	Limit (dBuV/m)	Margin (dB)	Ant. Pol H/V	Remark
1294.000	55.20	-8.61	46.59	74.00	-27.41	V	peak
2294.000	51.61	-1.54	50.07	74.00	-23.93	V	peak
2482.000	51.80	-1.06	50.74	74.00	-23.26	V	peak
3565.000	41.75	2.69	44.44	74.00	-29.56	V	peak
4985.000	37.37	5.18	42.55	74.00	-31.45	V	peak
7255.000	37.37	10.29	47.66	74.00	-26.34	V	peak
1406.000	51.03	-7.03	44.00	74.00	-30.00	H	peak
2132.000	50.26	-3.71	46.55	74.00	-27.45	H	peak
2562.000	50.40	-3.53	46.87	74.00	-27.13	H	peak
3595.000	39.67	4.05	43.72	74.00	-30.28	H	peak
5630.000	39.84	8.87	48.71	74.00	-25.29	H	peak
7170.000	39.16	10.45	49.61	74.00	-24.39	H	peak

Remark:

1. Measuring frequencies from 1 GHz to the 10th harmonic of highest fundamental frequency.
2. Radiated emissions measured in frequency above 1000MHz were made with an instrument using peak/average detector mode.
3. Average test would be performed if the peak result were greater than the average limit or as required by the applicant.
4. Data of measurement within this frequency range shown " --- " in the table above means the reading of emissions are attenuated more than 20dB below the permissible limits or the field strength is too small to be measured.
5. Measurements above show only up to 6 maximum emissions noted, or would be lesser, with " N/A " remark, if no specific emissions from the EUT are recorded (ie: margin>20dB from the applicable limit) and considered that's already beyond the background noise floor.
6. Margin (dB) = Remark result (dBuV/m) – Average limit (dBuV/m).



Operation Mode: TX / CH Mid **Test Date:** 2013/9/17
Temperature: 26°C **Tested by:** Francis Lee
Humidity: 56% RH **Polarity:** Ver. / Hor.

Freq. (MHz)	Reading (dBuV)	Correct Factor (dB/m)	Result (dBuV/m)	Limit (dBuV/m)	Margin (dB)	Ant. Pol H/V	Remark
1224.000	53.88	-8.48	45.40	74.00	-28.60	V	peak
1598.000	53.34	-4.80	48.54	74.00	-25.46	V	peak
2494.000	51.83	-0.97	50.86	74.00	-23.14	V	peak
3355.000	41.06	1.10	42.16	74.00	-31.84	V	peak
5615.000	36.80	5.91	42.71	74.00	-31.29	V	peak
7210.000	39.13	10.10	49.23	74.00	-24.77	V	peak
1400.000	51.12	-6.90	44.22	74.00	-29.78	H	peak
2132.000	50.24	-3.71	46.53	74.00	-27.47	H	peak
2856.000	49.34	-2.06	47.28	74.00	-26.72	H	peak
3880.000	38.93	5.20	44.13	74.00	-29.87	H	peak
5995.000	39.67	8.85	48.52	74.00	-25.48	H	peak
7315.000	40.12	11.74	51.86	74.00	-22.14	H	peak

Remark:

1. Measuring frequencies from 1 GHz to the 10th harmonic of highest fundamental frequency.
2. Radiated emissions measured in frequency above 1000MHz were made with an instrument using peak/average detector mode.
3. Average test would be performed if the peak result were greater than the average limit or as required by the applicant.
4. Data of measurement within this frequency range shown " --- " in the table above means the reading of emissions are attenuated more than 20dB below the permissible limits or the field strength is too small to be measured.
5. Measurements above show only up to 6 maximum emissions noted, or would be lesser, with " N/A " remark, if no specific emissions from the EUT are recorded (ie: margin>20dB from the applicable limit) and considered that's already beyond the background noise floor.
6. Margin (dB) = Remark result (dBuV/m) – Average limit (dBuV/m).



Operation Mode: TX / CH High

Test Date: 2013/9/17

Temperature: 26°C

Tested by: Francis Lee

Humidity: 56% RH

Polarity: Ver. / Hor.

Freq. (MHz)	Reading (dBuV)	Correct Factor (dB/m)	Result (dBuV/m)	Limit (dBuV/m)	Margin (dB)	Ant. Pol H/V	Remark
3590.000	40.37	2.86	43.23	74.00	-30.77	V	peak
5530.000	38.55	6.13	44.68	74.00	-29.32	V	peak
7350.000	36.49	10.89	47.38	74.00	-26.62	V	peak
1296.000	57.54	-8.61	48.93	74.00	-25.07	V	peak
1928.000	50.59	-2.44	48.15	74.00	-25.85	V	peak
2640.000	50.93	-1.89	49.04	74.00	-24.96	V	peak
1384.000	51.32	-7.31	44.01	74.00	-29.99	H	peak
2132.000	50.58	-3.71	46.87	74.00	-27.13	H	peak
2888.000	49.53	-1.82	47.71	74.00	-26.29	H	peak
3775.000	37.25	4.77	42.02	74.00	-31.98	H	peak
5450.000	35.85	8.63	44.48	74.00	-29.52	H	peak
7240.000	36.71	11.02	47.73	74.00	-26.27	H	peak

Remark:

1. Measuring frequencies from 1 GHz to the 10th harmonic of highest fundamental frequency.
2. Radiated emissions measured in frequency above 1000MHz were made with an instrument using peak/average detector mode.
3. Average test would be performed if the peak result were greater than the average limit or as required by the applicant.
4. Data of measurement within this frequency range shown " --- " in the table above means the reading of emissions are attenuated more than 20dB below the permissible limits or the field strength is too small to be measured.
5. Measurements above show only up to 6 maximum emissions noted, or would be lesser, with " N/A " remark, if no specific emissions from the EUT are recorded (ie: margin>20dB from the applicable limit) and considered that's already beyond the background noise floor.
6. Margin (dB) = Remark result (dBuV/m) – Average limit (dBuV/m).



7.7. POWERLINE CONDUCTED EMISSIONS

LIMIT

For an intentional radiator which is designed to be connected to the public utility (AC) power line, the radio frequency voltage that is conducted back onto the AC power line on any frequency or frequencies within the band 150 kHz to 30 MHz shall not exceed 250 microvolts (The limit decreases linearly with the logarithm of the frequency in the range 0.15 MHz to 0.50 MHz). The limits at specific frequency range is listed as follows:

Frequency Range (MHz)	Limits (dB μ V)	
	Quasi-peak	Average
0.15 to 0.50	66 to 56	56 to 46
0.50 to 5	56	46
5 to 30	60	50

Compliance with this provision shall be based on the measurement of the radio frequency voltage between each power line (LINE and NEUTRAL) and ground at the power terminals.

TEST CONFIGURATION

See test photographs attached in Appendix 1 for the actual connections between EUT and support equipment.

TEST PROCEDURE

1. The EUT was placed on a table, which is 0.8m above ground plane.
2. Maximum procedure was performed on the six highest emissions to ensure EUT compliance.
3. Repeat above procedures until all frequency measured were complete.

TEST RESULTS

The initial step in collecting conducted data is a spectrum analyzer peak scan of the measurement range. Significant peaks are then marked as shown on the following data page, and these signals are then quasi-peaked.



TEST DATA

Operation Mode: Normal Link Test Date: 2013/8/29
Temperature: 25°C Tested by: Louis Shen
Humidity: 57% RH Test

Table with 11 columns: Freq. (MHz), QP Reading, AV Reading, Corr. factor, QP Result, AV Result, QP Limit, AV Limit, QP Margin, AV Margin, Note. It contains two groups of data rows, each with 6 rows.

Remark:

- 1. Measuring frequencies from 0.15 MHz to 30MHz.
2. The emissions measured in frequency range from 0.15 MHz to 30MHz were made with an instrument using Quasi-peak detector and average detector.
3. "---" denotes the emission level was or more than 2dB below the Average limit
4. The IF bandwidth of SPA between 0.15MHz to 30MHz was 10kHz; the IF bandwidth of Test Receiver between 0.15MHz to 30MHz was 9kHz;
5. L1 = Line One (Live Line) / L2 = Line Two (Neutral Line)



Test Plots

Conducted emissions (Line 1)

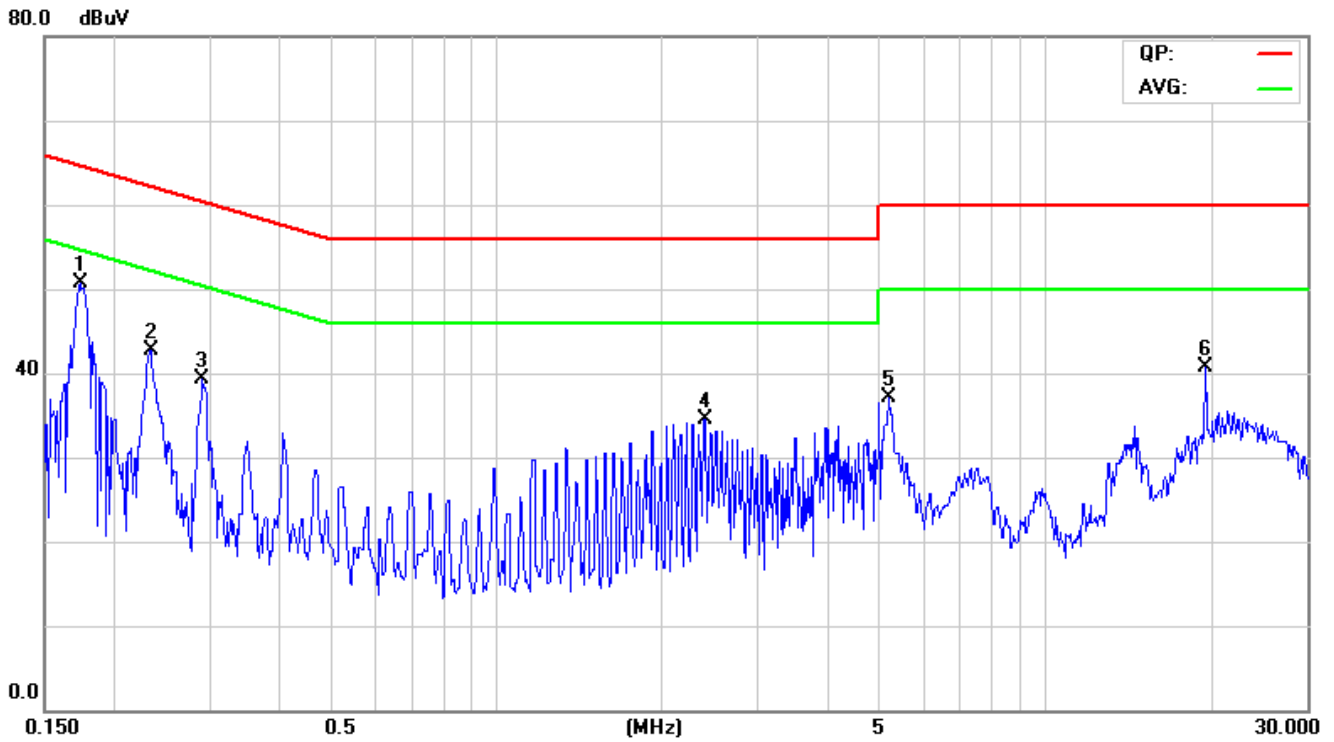

Conducted emissions (Line 2)

