



FCC RADIO TEST REPORT

FCC ID : UZ7WR50
Equipment : RFID Accessory
Brand Name : Zebra
Model Name : WR50
Applicant : Zebra Technologies Corporation
1 Zebra Plaza, Holtsville, NY 11742
Manufacturer : Zebra Technologies Corporation
1 Zebra Plaza, Holtsville, NY 11742
Standard : FCC Part 15 Subpart C §15.247

The product was received on Apr. 10, 2023 and testing was started from Apr. 12, 2023 to May 13, 2023. We, Sporton International Inc. Wensan Laboratory, would like to declare that the tested sample has been evaluated in accordance with the test procedures and has been in compliance with the applicable technical standards.

The test results in this report apply exclusively to the tested model / sample. Without written approval of Sporton International Inc. Wensan Laboratory, the test report shall not be reproduced except in full.

Approved by: Louis Wu

Sporton International Inc. Wensan Laboratory

No.58, Aly. 75, Ln. 564, Wenhua 3rd, Rd., Guishan Dist., Taoyuan City 333010, Taiwan (R.O.C.)



Table of Contents

History of this test report.....	3
Summary of Test Result.....	4
1 General Description.....	5
1.1 Product Feature of Equipment Under Test.....	5
1.2 Product Specification of Equipment Under Test.....	7
1.3 Modification of EUT	7
1.4 Testing Location	8
1.5 Applicable Standards.....	8
2 Test Configuration of Equipment Under Test.....	9
2.1 Carrier Frequency Channel	9
2.2 Test Mode.....	10
2.3 Connection Diagram of Test System.....	11
2.4 Support Unit used in test configuration and system	12
2.5 EUT Operation Test Setup	12
2.6 Measurement Results Explanation Example.....	13
3 Test Result.....	14
3.1 Number of Channel Measurement	14
3.2 Hopping Channel Separation Measurement	17
3.3 Dwell Time Measurement.....	20
3.4 20dB and 99% Bandwidth Measurement	23
3.5 Output Power Measurement.....	28
3.6 Conducted Band Edges Measurement.....	30
3.7 Conducted Spurious Emission Measurement	33
3.8 Radiated Band Edges and Spurious Emission Measurement	36
3.9 AC Power Line Conducted Emissions Measurement.....	40
3.10 Antenna Requirements.....	42
4 List of Measuring Equipment	43
5 Measurement Uncertainty	45
Appendix A. AC Conducted Emission Test Result	
Appendix B. Radiated Spurious Emission	
Appendix C. Radiated Spurious Emission Plots	
Appendix D. Duty Cycle Plots	
Appendix E. Setup Photographs	



Summary of Test Result

Report Clause	Ref Std. Clause	Test Items	Result (PASS/FAIL)	Remark
3.1	15.247(a)(1)	Number of Channels	Pass	-
3.2	15.247(a)(1)	Hopping Channel Separation	Pass	-
3.3	15.247(a)(1)	Dwell Time of Each Channel	Pass	-
3.4	15.247(a)(1)	20dB Bandwidth	Pass	-
3.4	2.1049	99% Occupied Bandwidth	Reporting Only	-
3.5	15.247(b)(1)	Output Power	Pass	-
3.6	15.247(d)	Conducted Band Edges	Pass	-
3.7	15.247(d)	Conducted Spurious Emission	Pass	-
3.8	15.247(d)	Radiated Band Edges and Radiated Spurious Emission	Pass	6.04 dB under the limit at 30.810 MHz
3.9	15.207	AC Conducted Emission	Pass	19.02 dB under the limit at 0.172 MHz
3.10	15.203 & 15.247(b)	Antenna Requirement	Pass	-

Conformity Assessment Condition:

1. The test results (PASS/FAIL) with all measurement uncertainty excluded are presented against the regulation limits or in accordance with the requirements stipulated by the applicant/manufacturer who shall bear all the risks of non-compliance that may potentially occur if measurement uncertainty is taken into account.
2. The measurement uncertainty please refer to each test result in the section "Measurement Uncertainty".

Disclaimer:

The product specifications of the EUT presented in the test report that may affect the test assessments are declared by the manufacturer who shall take full responsibility for the authenticity.

Reviewed by: Wei Chen**Report Producer: Rachel Hsieh**



1 General Description

1.1 Product Feature of Equipment Under Test

Product Feature	
Equipment	RFID Accessory
Brand Name	Zebra
Model Name	WR50
Sample 1	EUT with Host (SKU 2)
Sample 2	EUT with Host (SKU 4)
Sample 3	EUT with Host (SKU 6)
Sample 4	EUT with Host (SKU 8)
FCC ID	UZ7WR50
Installed into the Host	Equipment name: WS50 Wearable Computer Brand name: Zebra Model name: WS5001
EUT supports Radios application	UHF RFID
HW Version	DV1.2
FW Version	PAAFBS00-001-R07
MFD	23FEB23
EUT Stage	Identical Prototype

Remark: The above EUT's information was declared by manufacturer.

<Host Information>

Helix SKU	Scanner	Battery	Camera	Mounting
SKU 2	SE4770	3X (2400mAh)	N/A	Finger Trigger
SKU 4	SE4770	3X (2400mAh)	N/A	RIFD BOH
SKU 6	SE4770	3X (2400mAh)	N/A	RFID Wrist /W external antenna
SKU 8	SE4770	3X (2400mAh)	N/A	RFID BOH /W external antenna

Specification of Accessories				
AC Adapter	Brand Name	Zebra	Model Number	PWR-WUA5V12W0US
3X Battery	Brand Name	Zebra	Model Number	BT-000446A
USB charging cable with cup	Brand Name	Zebra	Model Number	CBL-WS5X-USB1-01
USB C CABLE	Brand Name	Zebra	Model Number	CBL-TC2X-USBC-01
WS50 Wearable Computer	Brand Name	Zebra	Model Number	WS5001



Supported Unit used in test configuration and system				
WS50 RFID Shell	Brand Name	Zebra	Part Number	SG-WS5X-SHLRS-01
WS50 Replacement Deflector for RFID Shell	Brand Name	Zebra	Part Number	SG-WS5X-DFLTR-01
Replacement Finger Trigger for Converged	Brand Name	Zebra	Part Number	SG-WS5X-TRGA-01
WS50 Spare Finger Strap for Converged and RFID Trigger, 10 Pack	Brand Name	Zebra	Part Number	SG-WS5X-STRP-10
WS50 RFID Back of Hand Mount (SKU 4 & 8)	Brand Name	Zebra	Part Number	SG-WS5X-BHRS-01
WS50 RFID Wrist Mount Plate (SKU 6)	Brand Name	Zebra	Part Number	SG-WS5X-WSTRS-01
Wrist Mount for WS50 RFID, Right Arm, Large (SKU 6)	Brand Name	Zebra	Part Number	SG-WS5X-WMTRRL-01
Wrist Mount for WS50 RFID, Right Arm, Small (SKU 6)	Brand Name	Zebra	Part Number	SG-WS5X-WMTRRS-01
Wrist Mount for WS50 RFID, Left Arm, Large (SKU 6)	Brand Name	Zebra	Part Number	SG-WS5X-WMTRLL-01
Wrist Mount for WS50 RFID, Left Arm, Small (SKU 6)	Brand Name	Zebra	Part Number	SG-WS5X-WMTRLS-01
WS50 RFID Back of Hand Mount with Wrist Antenna Holder, Right Large (SKU 8)	Brand Name	Zebra	Part Number	SG-WS5X-BHWRRRL-01
WS50 RFID Back of Hand Mount with Wrist Antenna Holder, Right Medium (SKU 8)	Brand Name	Zebra	Part Number	SG-WS5X-BHWRRM-01
WS50 RFID Back of Hand Mount with Wrist Antenna Holder, Right Small (SKU 8)	Brand Name	Zebra	Part Number	SG-WS5X-BHWRRS-01
WS50 RFID Back of Hand Mount with Wrist Antenna Holder, Left Large (SKU 8)	Brand Name	Zebra	Part Number	SG-WS5X-BHWRLRL-01
WS50 RFID Back of Hand Mount with Wrist Antenna Holder, Left Medium (SKU 8)	Brand Name	Zebra	Part Number	SG-WS5X-BHWRLM-01
WS50 RFID Back of Hand Mount with Wrist Antenna Holder, Left Small (SKU 8)	Brand Name	Zebra	Part Number	SG-WS5X-BHWRLS-01
WS50 UHF RFID Antenna Cable, 800MHz, 210mm Length for Wrist Mount, EMEA	Brand Name	Zebra	Part Number	CBL-WS5X-ANTR8S-01
WS50 UHF RFID Antenna Cable, 800MHz, 330mm length for Back of Hand Mount, EMEA	Brand Name	Zebra	Part Number	CBL-WS5X-ANTR8L-01
WS50 UHF RFID Antenna Cable, 900MHz, 210mm length for Wrist Mount, North America and Rest of World Minus EMEA	Brand Name	Zebra	Part Number	CBL-WS5X-ANTR9S-01
WS50 UHF RFID Antenna Cable, 900MHz, 330mm length for Back of Hand Mount, North America and Rest of World Minus EMEA	Brand Name	Zebra	Part Number	CBL-WS5X-ANTR9L-01



1.2 Product Specification of Equipment Under Test

Product Specification is subject to this standard	
Tx/Rx Frequency Range	902.75 MHz ~ 927.25 MHz
Number of Channels	50
Maximum Output Power to Antenna	<Internal Antenna> 22.65 dBm (0.1841 W) <External Antenna> 22.80 dBm (0.1905 W)
20dB Bandwidth	<Internal Antenna> 0.067 MHz <External Antenna> 0.067 MHz
99% Occupied Bandwidth	<Internal Antenna> 0.061 MHz <External Antenna> 0.061 MHz
Antenna Type / Gain	<Internal Antenna> PIFA Antenna with gain -0.91 dBi <External Antenna> Patch Antenna with gain 1.65 dBi
Type of Modulation	ASK

Remark: The above EUT's information was declared by manufacturer. Please refer to Disclaimer in report summary.

1.3 Modification of EUT

No modifications are made to the EUT during all test items.



1.4 Testing Location

Test Site	Sporton International Inc. EMC & Wireless Communications Laboratory
Test Site Location	No.52, Huaya 1st Rd., Guishan Dist., Taoyuan City 333, Taiwan (R.O.C.) TEL: +886-3-327-3456 FAX: +886-3-328-4978
Test Site No.	Sporton Site No. CO05-HY (TAF Code: 1190)
Remark	The Conducted test item subcontracted to Sporton International Inc. EMC & Wireless Communications Laboratory.

Note: The test site complies with ANSI C63.4 2014 requirement.

Test Site	Sporton International Inc. Wensan Laboratory
Test Site Location	No.58, Aly. 75, Ln. 564, Wenhua 3rd, Rd., Guishan Dist., Taoyuan City 333010, Taiwan (R.O.C.) TEL: +886-3-327-0868 FAX: +886-3-327-0855
Test Site No.	Sporton Site No. TH05-HY, 03CH11-HY

Note: The test site complies with ANSI C63.4 2014 requirement.

FCC designation No.: TW1190 and TW3786

1.5 Applicable Standards

According to the specifications of the manufacturer, the EUT must comply with the requirements of the following standards:

- ♦ FCC Part 15 Subpart C §15.247
- ♦ FCC KDB Publication No. 558074 D01 DTS Meas. Guidance v05r01
- ♦ FCC KDB 414788 D01 Radiated Test Site v01r01
- ♦ ANSI C63.10-2013

Remark:

1. All test items were verified and recorded according to the standards and without any deviation during the test.
2. The TAF code is not including all the FCC KDB listed without accreditation.
3. This EUT has also been tested and complied with the requirements of FCC Part 15, Subpart B, recorded in a separate test report.



2 Test Configuration of Equipment Under Test

2.1 Carrier Frequency Channel

Frequency Band	Channel	Freq. (MHz)	Channel	Freq. (MHz)
902.75-927.25 MHz	1	915.45	28	922.20
	2	915.70	29	922.45
	3	915.95	30	922.70
	4	916.20	31	922.95
	5	916.45	32	923.20
	6	916.70	33	923.45
	7	916.95	34	923.70
	8	917.20	35	923.95
	9	917.45	36	924.20
	10	917.70	37	924.45
	11	917.95	38	924.70
	12	918.20	39	924.95
	13	918.45	40	925.20
	14	918.70	41	925.45
	15	918.95	42	925.70
	16	919.20	43	925.95
	17	919.45	44	926.20
	18	919.70	45	926.45
	19	919.95	46	926.70
	20	920.20	47	926.95
	21	920.45	48	927.20
	22	920.70	49	927.45
	23	920.95	50	927.70
	24	921.20		
	25	921.45		
	26	921.70		
	27	921.95		



2.2 Test Mode

- a. The EUT has been associated with peripherals and configuration operated in a manner tended to maximize its emission characteristics in a typical application. Frequency range investigated: conduction emission (150 kHz to 30 MHz), radiation emission (9 kHz to the 10th harmonic of the highest fundamental frequency or to 40 GHz, whichever is lower). For radiated measurement, the measured emission level of the EUT was maximized by rotating the EUT on a turntable, adjusting the orientation of the EUT and EUT antenna in three orthogonal axis (X: flat, Y: portrait, Z: landscape), and adjusting the measurement antenna orientation, following C63.10 exploratory test procedures and find Y plane as worst plane.
- b. AC power line Conducted Emission was tested under maximum output power.

The following summary table is showing all test modes to demonstrate in compliance with the standard.

Summary table of Test Cases	
Test Item	UHF RFID
Conducted Test Cases	<p><Internal Antenna and External Antenna></p> <p>Mode 1: UHF RFID Tx 917.9 MHz</p> <p>Mode 2: UHF RFID Tx 922.7 MHz</p> <p>Mode 3: UHF RFID Tx 927.7 MHz</p>
Radiated Test Cases	<p><Internal Antenna></p> <p>Mode 1: UHF RFID Tx 917.9 MHz</p> <p>Mode 2: UHF RFID Tx 922.7 MHz</p> <p>Mode 3: UHF RFID Tx 927.7 MHz</p> <p><External Antenna></p> <p>Mode 1: UHF RFID Tx 927.7 MHz</p>
AC Conducted Emission	<p>Mode 1: Bluetooth Link + WLAN (2.4GHz) Link + NFC on + RFID Idle + Scanner Scan Bar Code + USB C Cable (Charging with Adapter) + Replacement Finger Trigger for Converged for Sample 1</p>
<p>Remark: For Radiated Test Cases, the tests were performed with WS50 UHF RFID Antenna Cable, 900MHz, 330mm length for Back of Hand Mount, North America and Rest of World Minus EMEA, Sample 1 and Sample 4.</p>	

2.3 Connection Diagram of Test System

<AC Conducted Emission Mode>

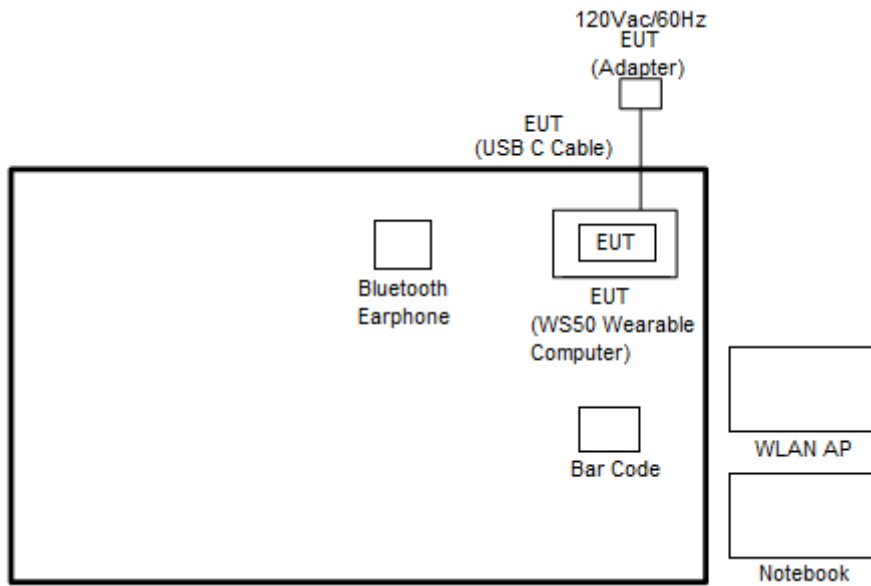

<Radiated Spurious Emission Mode for Internal Antenna>

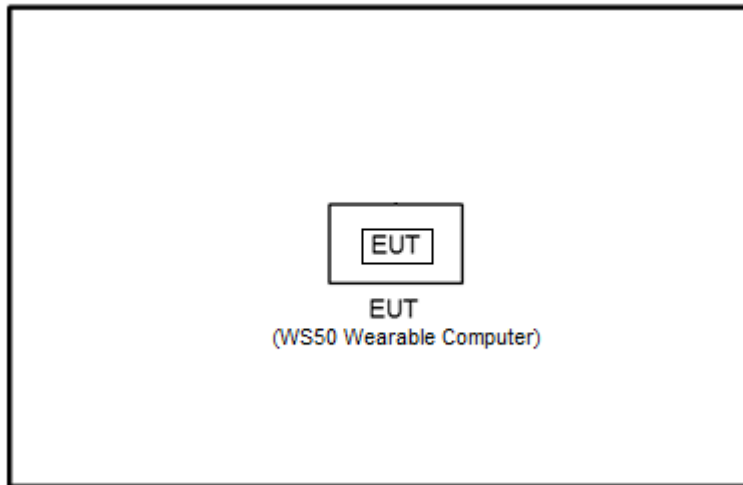

<Radiated Spurious Emission Mode for External Antenna>

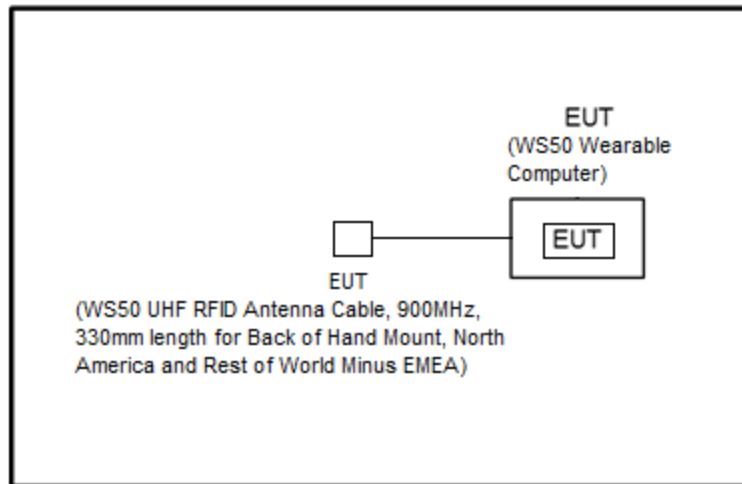

2.4 Support Unit used in test configuration and system

Item	Equipment	Brand Name	Model Name	FCC ID	Data Cable	Power Cord
1.	Notebook	Dell	Latitude 3400	FCC DoC	N/A	AC I/P: Unshielded, 1.2 m DC O/P: Shielded, 1.8 m
2.	Bluetooth Earphone	Sony Ericsson	MW600	PY700A2029	N/A	N/A
3.	WLAN AP	ASUS	RT-AC66U	MSQ-RTAC66U	N/A	Unshielded, 1.8 m
4.	Bar Code	N/A	N/A	N/A	N/A	N/A

2.5 EUT Operation Test Setup

The RF test items, utility “HWTestApp 1.8” was installed in Host which was programmed in order to make the EUT get into the engineering modes to provide channel selection, power level, data rate and the application type and for continuous transmitting signals.



2.6 Measurement Results Explanation Example

For all conducted test items:

The offset level is set in the spectrum analyzer to compensate the RF cable loss and attenuator factor between EUT conducted output port and spectrum analyzer. With the offset compensation, the spectrum analyzer reading level is exactly the EUT RF output level.

Example:

The spectrum analyzer offset is derived from RF cable loss and attenuator factor.

Offset = RF cable loss + attenuator factor.

Following shows an offset computation example with cable loss 4.2 dB and 10 dB attenuator.

$$\begin{aligned} \text{Offset(dB)} &= \text{RF cable loss(dB)} + \text{attenuator factor(dB)}. \\ &= 4.2 + 10 = 14.2 \text{ (dB)} \end{aligned}$$

3 Test Result

3.1 Number of Channel Measurement

3.1.1 Limits of Number of Hopping Frequency

Frequency hopping systems in the 902.75-927.25 MHz band shall use at least 25 channels.

3.1.2 Measuring Instruments

Please refer to the measuring equipment list in this test report.

3.1.3 Test Procedure

1. The testing follows ANSI C63.10-2013 clause 7.8.3.
2. The RF output of EUT was connected to the spectrum analyzer by RF cable and attenuator. The path loss was compensated to the results for each measurement.
3. Set the maximum power setting and enable the EUT to transmit continuously.
4. Enable the EUT hopping function.
5. Use the following spectrum analyzer settings: Span = the frequency band of operation; RBW = 300 kHz; VBW \geq RBW; Sweep = auto; Detector function = peak; Trace = max hold.
6. The number of hopping frequency used is defined as the number of total channel.
7. Record the measurement data derived from spectrum analyzer.

3.1.4 Test Setup

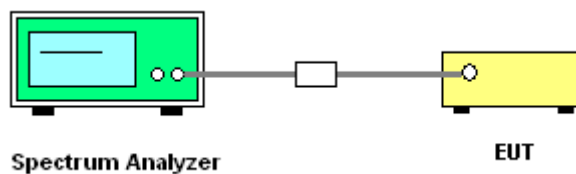



3.1.5 Test Result of Number of Hopping Frequency

Test Mode :	UHF RFID	Temperature :	20~25°C
Test Engineer :	Ray Wang	Relative Humidity :	50~56%

Number of Hopping (Channel)	Limits (Channel)	Pass/Fail
50	> 25	Pass

<Internal Antenna>

Number of Hopping Channel Plot on Channel 00 - 49

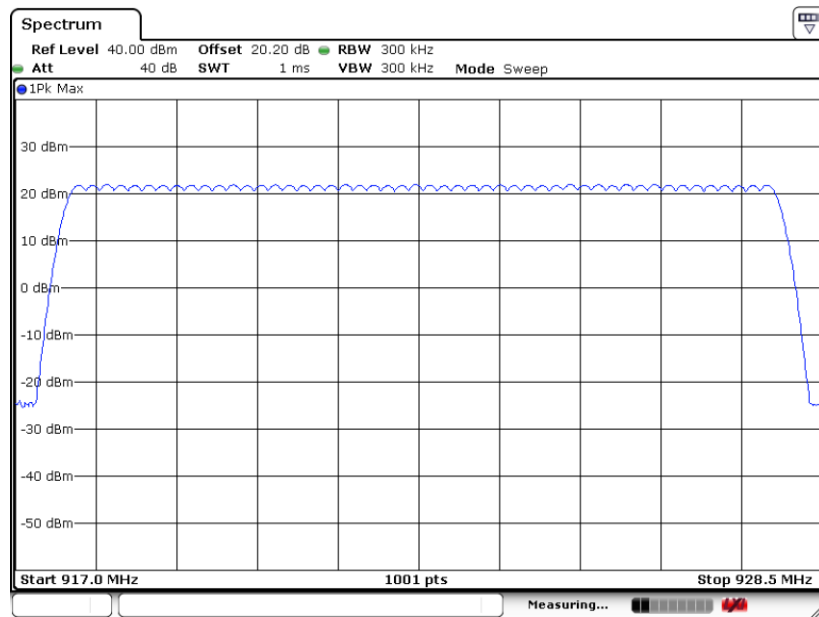

Date: 10.MAY.2023 01:40:40



<External Antenna>

Number of Hopping Channel Plot on Channel 00 - 49

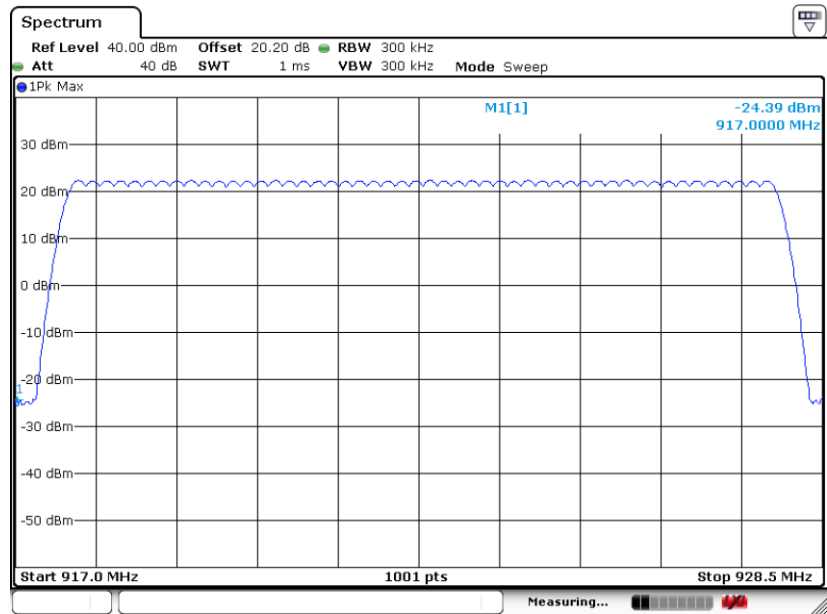

Date: 11.MAY.2023 01:05:55

3.2 Hopping Channel Separation Measurement

3.2.1 Limit of Hopping Channel Separation

Frequency hopping systems operating in the 902.75-927.25 MHz band may have hopping channel carrier frequencies that are 20 dB bandwidth of the hopping channel, whichever is greater.

3.2.2 Measuring Instruments

Please refer to the measuring equipment list in this test report.

3.2.3 Test Procedures

1. The testing follows ANSI C63.10-2013 clause 7.8.2.
2. The RF output of EUT was connected to the spectrum analyzer by RF cable and attenuator. The path loss was compensated to the results for each measurement.
3. Set the maximum power setting and enable the EUT to transmit continuously.
4. Enable the EUT hopping function.
5. Use the following spectrum analyzer settings:
Span = wide enough to capture the peaks of two adjacent channels;
RBW = 100 kHz; VBW \geq RBW; Sweep = auto; Detector function = peak; Trace = max hold.
6. Measure and record the results in the test report.

3.2.4 Test Setup

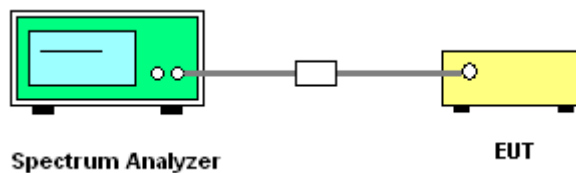



3.2.5 Test Result of Hopping Channel Separation

Test Mode :	UHF RFID	Temperature :	20~25°C
Test Engineer :	Ray Wang	Relative Humidity :	50~56%

<Internal Antenna>

Mod.	NTX	Freq. (MHz)	Hopping Channel Separation Measurement (MHz)	Hopping Channel Separation Limit (MHz)	Pass/Fail
UHF RFID	1	917.9	0.200	0.6690	Pass
UHF RFID	1	922.7	0.198	0.6690	Pass
UHF RFID	1	927.7	0.201	0.6690	Pass

Channel Separation Plot on 917.9 MHz

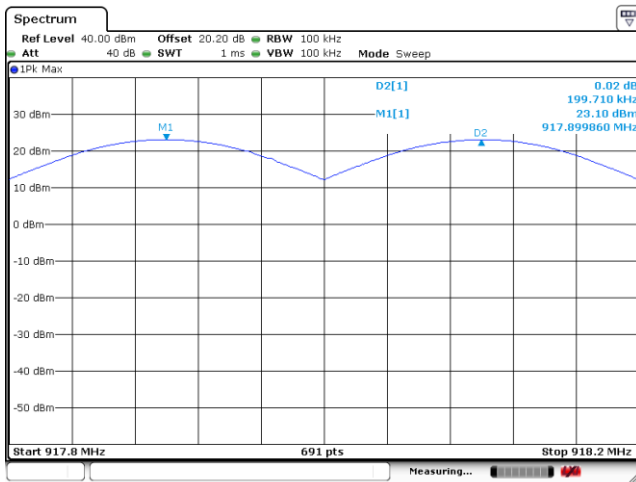

Date: 13 MAY 2023 06:29:27

Channel Separation Plot on 922.7 MHz

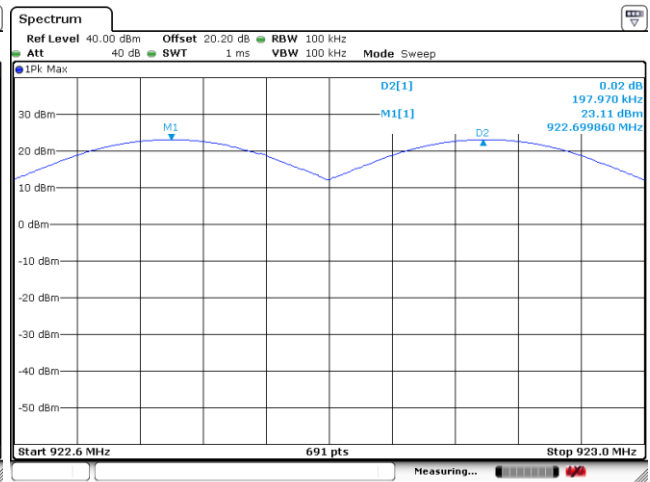

Date: 13 MAY 2023 06:38:40

Channel Separation Plot on 927.7 MHz

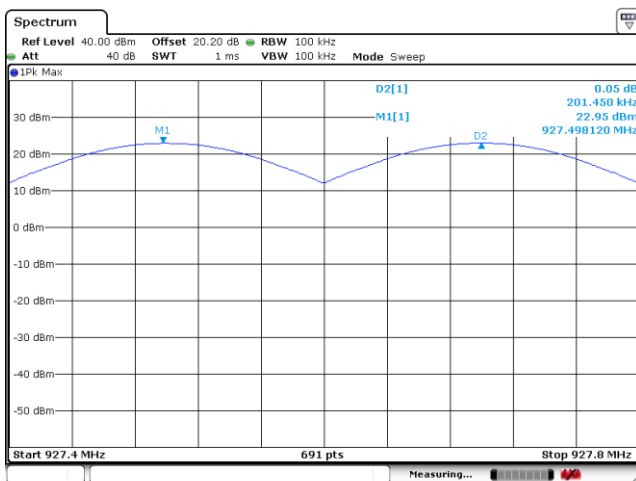

Date: 13 MAY 2023 06:43:48



<External Antenna>

Mod.	NTX	Freq. (MHz)	Hopping Channel Separation Measurement (MHz)	Hopping Channel Separation Measurement Limit (MHz)	Pass/Fail
UHF RFID	1	917.9	0.205	0.6690	Pass
UHF RFID	1	922.7	0.199	0.6690	Pass
UHF RFID	1	927.7	0.199	0.6690	Pass

Channel Separation Plot on 917.9 MHz

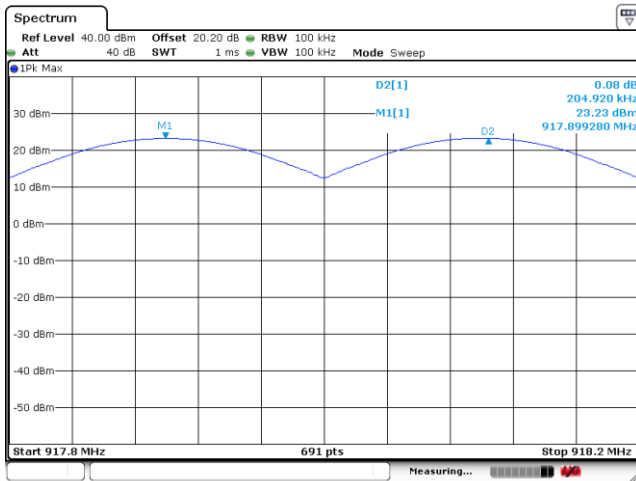

Channel Separation Plot on 922.7 MHz

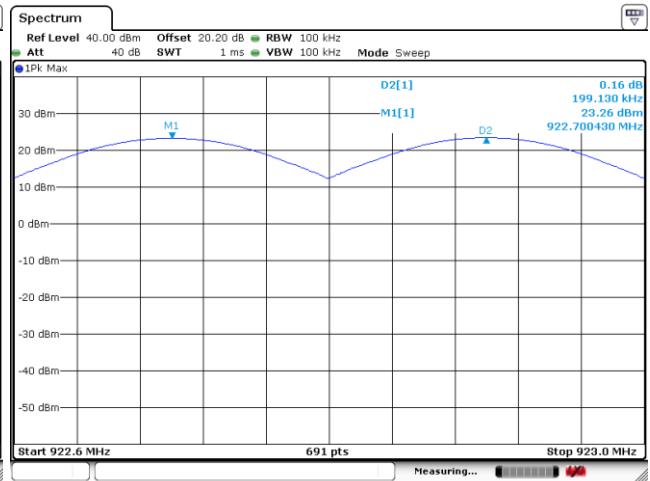

Channel Separation Plot on 927.7 MHz

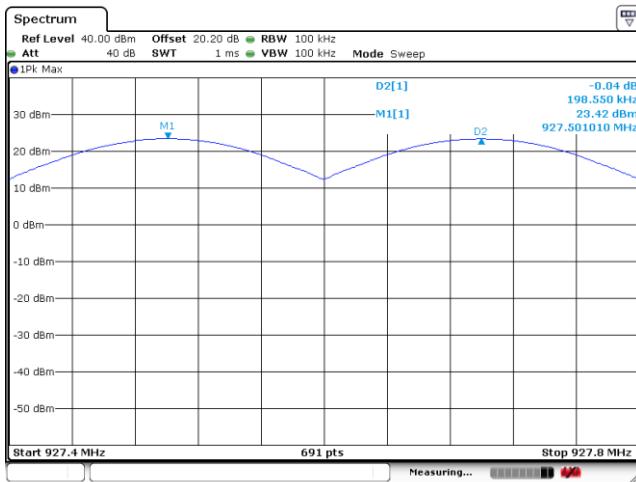

3.3 Dwell Time Measurement

3.3.1 Limit of Dwell Time

The average time of occupancy on any channel shall not be greater than 0.4 seconds within a period of 20 seconds multiplied by the number of hopping channels employed.

3.3.2 Measuring Instruments

Please refer to the measuring equipment list in this test report.

3.3.3 Test Procedures

1. The testing follows ANSI C63.10-2013 clause 7.8.4.
2. The RF output of EUT was connected to the spectrum analyzer by RF cable and attenuator. The path loss was compensated to the results for each measurement.
3. Set the maximum power setting and enable the EUT to transmit continuously.
4. Enable the EUT hopping function.
5. Use the following spectrum analyzer settings: Span = zero span, centered on a hopping channel; RBW = 1 MHz; VBW \geq RBW; Sweep = as necessary to capture the entire dwell time per hopping channel; Detector function = peak; Trace = max hold.
6. Measure and record the results in the test report.

3.3.4 Test Setup

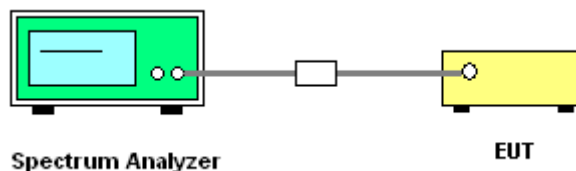



3.3.5 Test Result of Dwell Time

Test Mode :	UHF RFID	Temperature :	20~25°C
Test Engineer :	Ray Wang	Relative Humidity :	50~56%

<Internal Antenna>

Mod.	Channel Number Rate	Package Transfer Time (msec)	Hops Over Occupancy Time (hops)	Dwell Time (sec)	Limits (sec)	Pass/Fail
Nomal	50	300.00	1.00	0.300	0.4	Pass

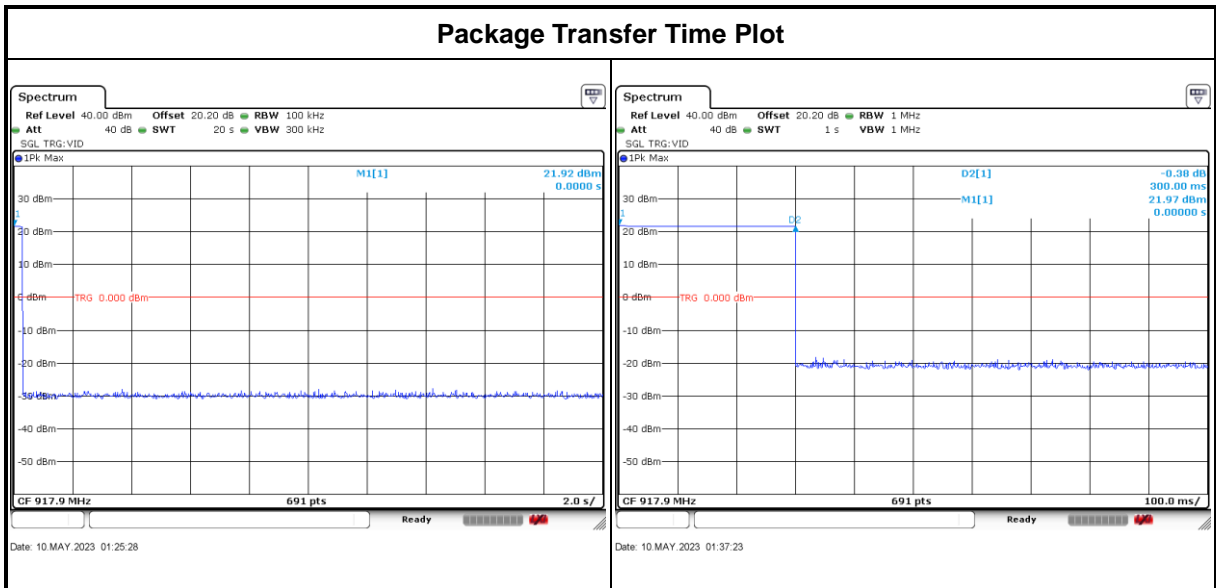

Remark: Dwell Time(s) = Hops Over Occupancy Time (hops) x Package Transfer Time



<External Antenna>

Mod.	Channel Number Rate	Package Transfer Time (msec)	Hops Over Occupancy Time (hops)	Dwell Time (sec)	Limits (sec)	Pass/Fail
Nomal	50	298.55	1.00	0.299	0.4	Pass

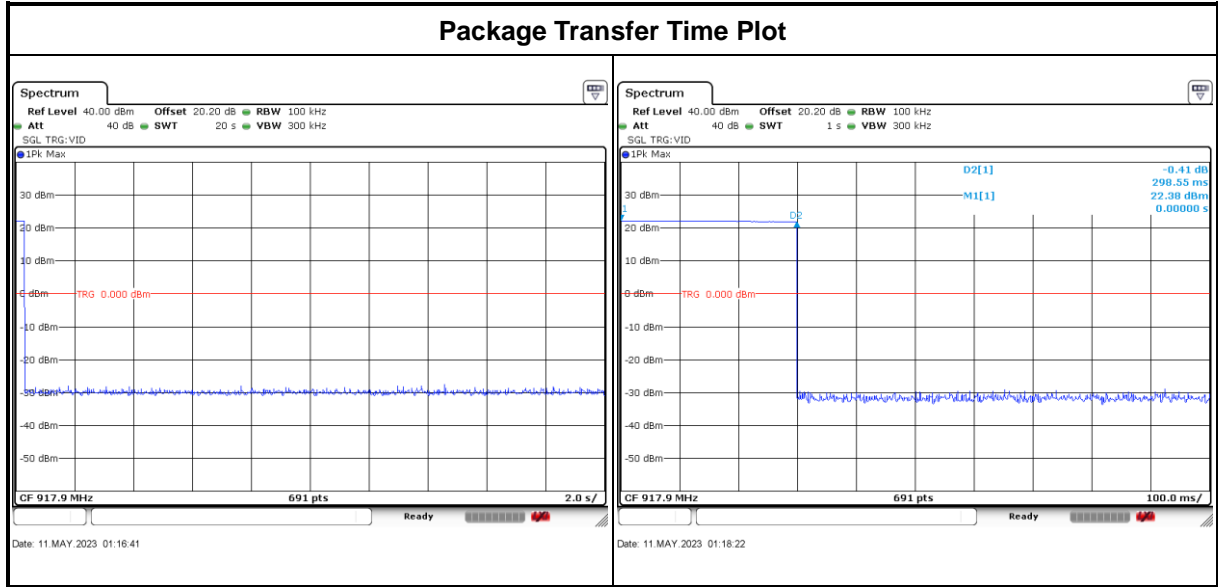

Remark: Dwell Time(s) = Hops Over Occupancy Time (hops) x Package Transfer Time

3.4 20dB and 99% Bandwidth Measurement

3.4.1 Limit of 20dB and 99% Bandwidth

Reporting only

3.4.2 Measuring Instruments

Please refer to the measuring equipment list in this test report.

3.4.3 Test Procedures

1. The testing follows ANSI C63.10-2013 clause 6.9.2 and 6.9.3.
2. The RF output of EUT was connected to the spectrum analyzer by RF cable and attenuator. The path loss was compensated to the results for each measurement.
3. Set the maximum power setting and enable the EUT to transmit continuously.
4. Use the following spectrum analyzer settings for 20 dB Bandwidth measurement.
Span = approximately 2 to 5 times the 20 dB bandwidth, centered on a hopping channel;
RBW \geq 1% of the 20 dB bandwidth; VBW \geq RBW; Sweep = auto; Detector function = peak;
Trace = max hold.
5. Use the following spectrum analyzer settings for 99 % Bandwidth measurement.
Span = approximately 1.5 to 5 times the 99% bandwidth, centered on a hopping channel;
RBW \geq 1-5% of the 99% bandwidth; VBW \geq 3 * RBW; Sweep = auto; Detector function = peak;
Trace = max hold.
6. Measure and record the results in the test report.

3.4.4 Test Setup





3.4.5 Test Result of 20dB Bandwidth

Test Mode :	UHF RFID	Temperature :	20~25°C
Test Engineer :	Ray Wang	Relative Humidity :	50~56%

<Internal Antenna>

Mod.	NTX	Freq.(MHz)	20db BW (MHz)	Pass/Fail
UHF RFID	1	917.9	0.067	Pass
UHF RFID	1	922.7	0.067	Pass
UHF RFID	1	927.7	0.067	Pass

20 dB Bandwidth Plot on 917.9 MHz

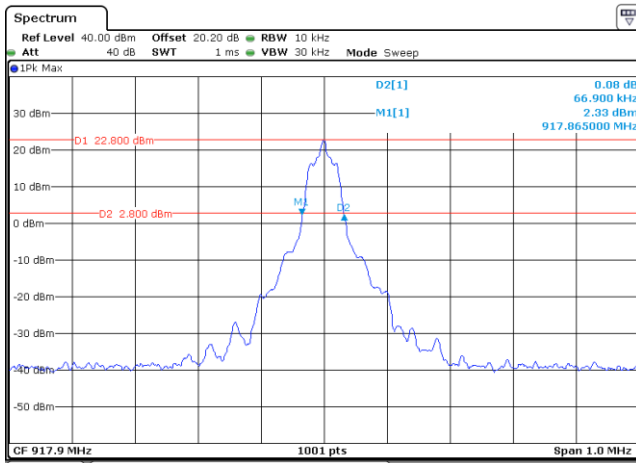

Date: 6 MAY 2023 05:34:20

20 dB Bandwidth Plot on 922.7 MHz

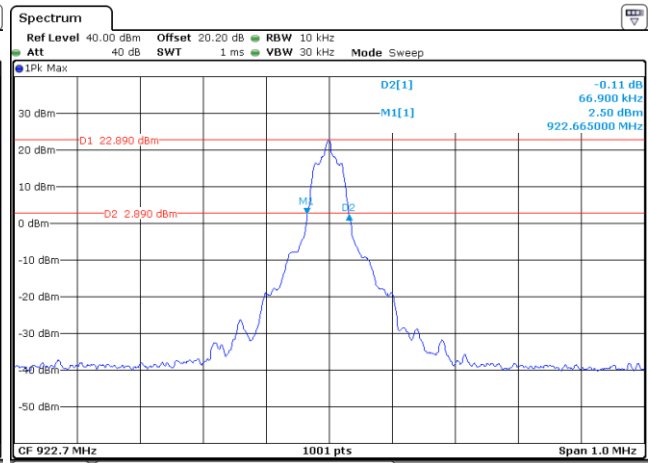

Date: 6 MAY 2023 05:29:47

20 dB Bandwidth Plot on 927.7 MHz

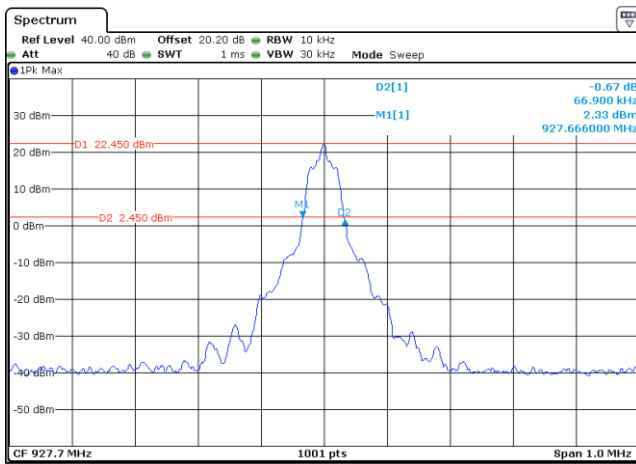

Date: 6 MAY 2023 04:17:25



<External Antenna>

Mod.	NTX	Freq.(MHz)	20db BW (MHz)	Pass/Fail
UHF RFID	1	917.9	0.067	Pass
UHF RFID	1	922.7	0.067	Pass
UHF RFID	1	927.7	0.067	Pass

20 dB Bandwidth Plot on 917.9 MHz

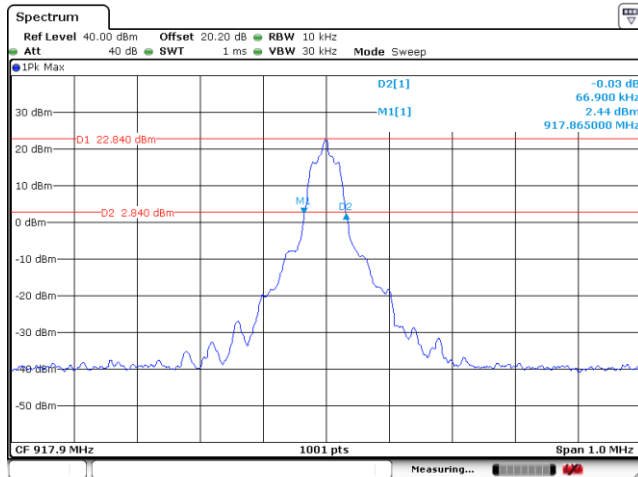

Date: 6 MAY 2023 05:06:40

20 dB Bandwidth Plot on 922.7 MHz

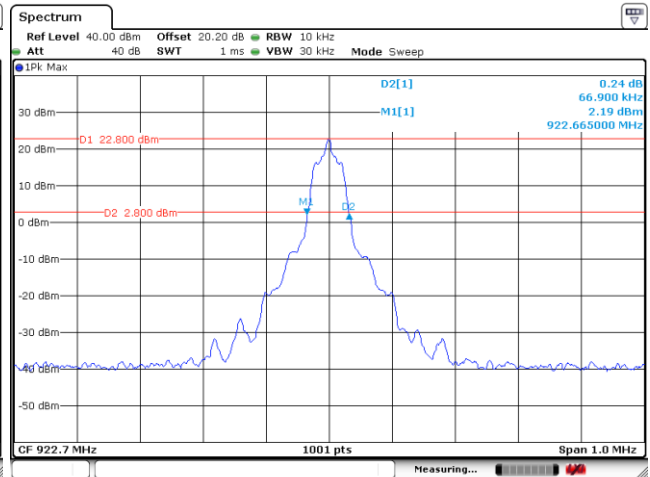

Date: 6 MAY 2023 05:20:42

20 dB Bandwidth Plot on 927.7 MHz

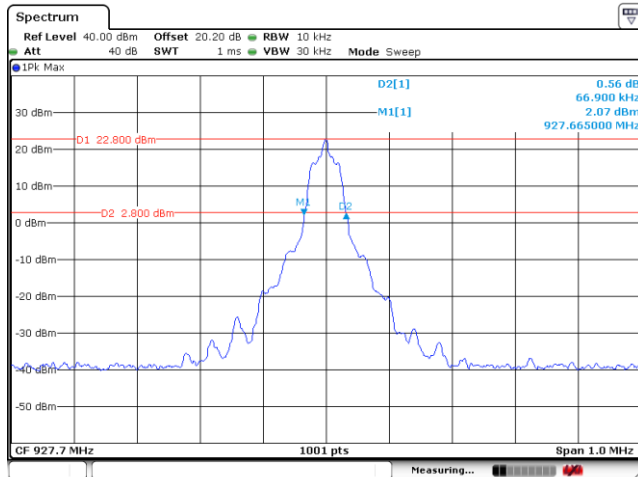

Date: 6 MAY 2023 05:40:54



3.4.6 Test Result of 99% Occupied Bandwidth

Test Mode :	UHF RFID	Temperature :	20~25°C
Test Engineer :	Ray Wang	Relative Humidity :	50~56%

<Internal Antenna>

Mod.	NTX	Freq. (MHz)	99% Bandwidth (MHz)	Pass/Fail
UHF RFID	1	917.9	0.061	Reporting Only
UHF RFID	1	922.7	0.061	Reporting Only
UHF RFID	1	927.7	0.061	Reporting Only

99% Occupied Bandwidth Plot on 917.9 MHz

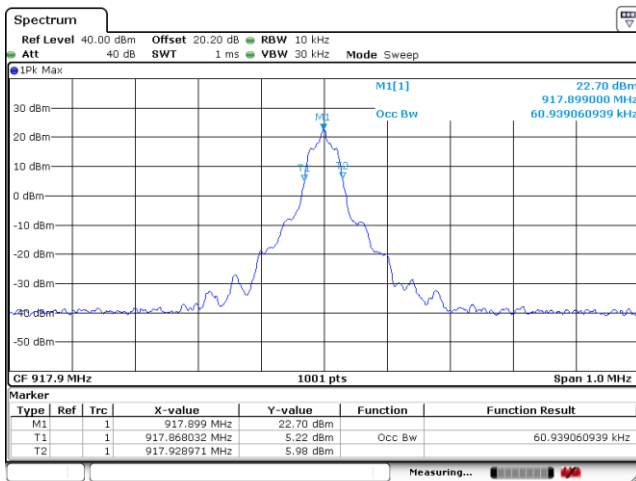

Date: 5.MAY.2023 08:02:28

99% Occupied Bandwidth Plot on 922.7 MHz

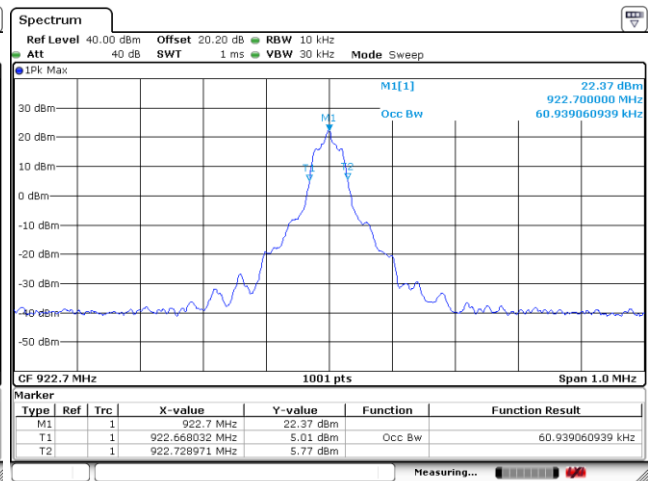

Date: 6 MAY 2023 04:07:46

99% Occupied Bandwidth Plot on 927.7 MHz

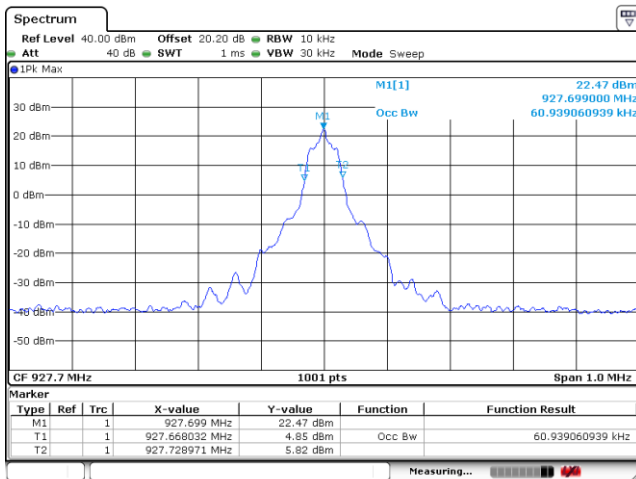

Date: 6.MAY.2023 04:20:20

Note: The occupied channel bandwidth is maintained within the band of operation for all of the modulations.



<External Antenna>

Mod.	NTX	Freq. (MHz)	99% Bandwidth (MHz)	Pass/Fail
UHF RFID	1	917.9	0.061	Reporting Only
UHF RFID	1	922.7	0.061	Reporting Only
UHF RFID	1	927.7	0.061	Reporting Only

99% Occupied Bandwidth Plot on 917.9 MHz

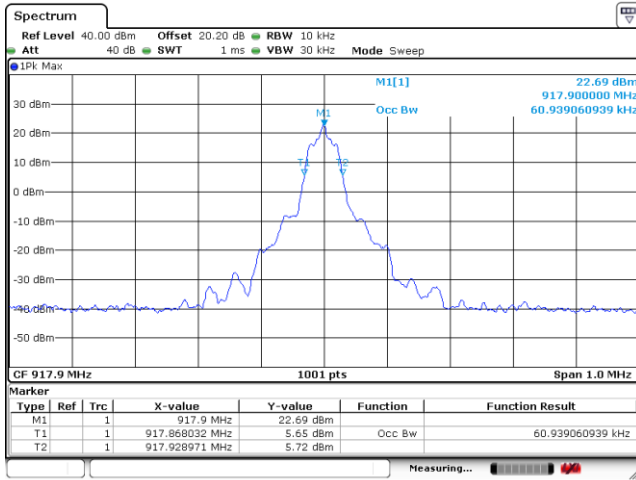

Date: 6 MAY 2023 05:07:59

99% Occupied Bandwidth Plot on 922.7 MHz

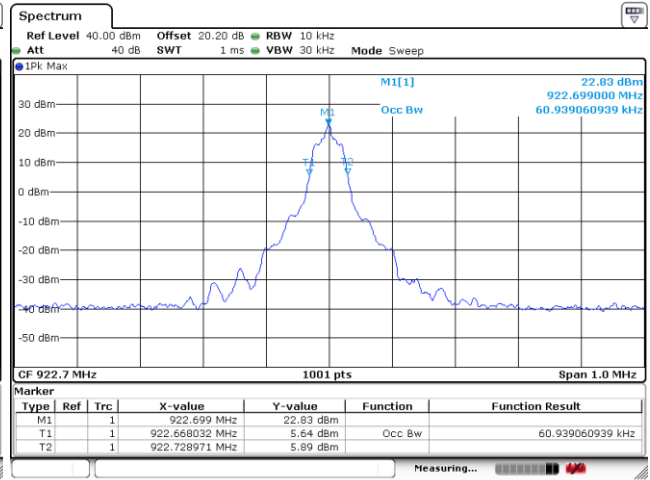

Date: 6 MAY 2023 05:18:42

99% Occupied Bandwidth Plot on 927.7 MHz

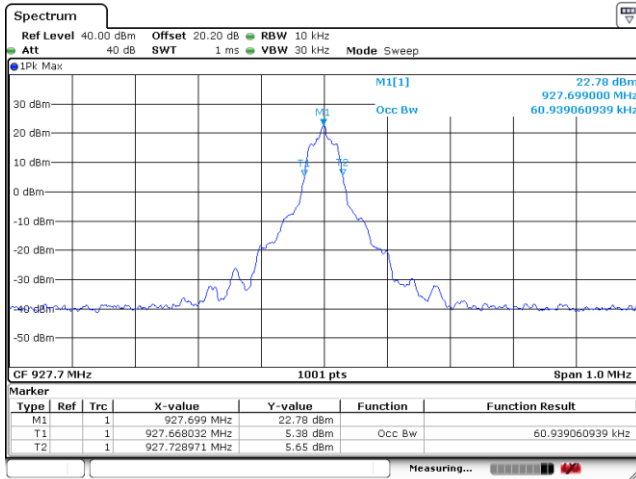

Date: 6 MAY 2023 05:42:28

Note: The occupied channel bandwidth is maintained within the band of operation for all of the modulations.

3.5 Output Power Measurement

3.5.1 Limit of Output Power

Section 15.247 (a) Operation under the provisions of this Section is limited to frequency hopping and digitally modulated intentional radiators that comply with the following provisions: (1)(i) For frequency hopping systems operating in the 902-928 MHz band: if the 20 dB bandwidth of the hopping channel is less than 250 kHz, the system shall use at least 50 hopping frequencies and the average time of occupancy on any frequency shall not be greater than 0.4 seconds within a 20 second period; if the 20 dB bandwidth of the hopping channel is 250 kHz or greater, the system shall use at least 25 hopping frequencies and the average time of occupancy on any frequency shall not be greater than 0.4 seconds within a 10 second period. The maximum allowed 20 dB bandwidth of the hopping channel is 500 kHz.

Section 15.247 (b) The maximum peak conducted output power of the intentional radiator shall not exceed the following: (2) For frequency hopping systems operating in the 902-928 MHz band: 1 watt for systems employing at least 50 hopping channels; and, 0.25 watts for systems employing less than 50 hopping channels, but at least 25 hopping channels, as permitted under paragraph (a)(1)(i) of this section.

3.5.2 Measuring Instruments

Please refer to the measuring equipment list in this test report.

3.5.3 Test Procedures

1. The testing follows ANSI C63.10-2013 clause 7.8.5.
2. The RF output of EUT was connected to the power meter by RF cable and attenuator. The path loss was compensated to the results for each measurement.
3. Set the maximum power setting and enable the EUT to transmit continuously.
4. Measure the conducted output power with cable loss and record the results in the test report.
5. Measure and record the results in the test report.

3.5.4 Test Setup

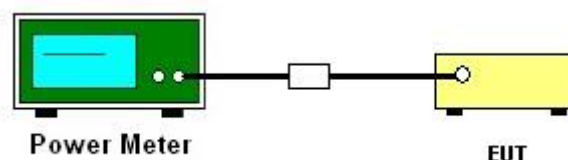



3.5.5 Test Result of Output Power

Test Mode :	UHF RFID	Temperature :	20~25°C
Test Engineer :	Ray Wang	Relative Humidity :	50~56%

<Internal Antenna>

Frequency (MHz)	RF Power (dBm)		
	UHF	Max. Limits (dBm)	Pass/Fail
917.9	22.65	33.00	Pass
922.7	22.60	33.00	Pass
927.7	22.58	33.00	Pass

<External Antenna>

Frequency (MHz)	RF Power (dBm)		
	UHF	Max. Limits (dBm)	Pass/Fail
917.9	22.80	33.00	Pass
922.7	22.75	33.00	Pass
927.7	22.71	33.00	Pass

3.5.6 Test Result of Average Power (Reporting Only)

Test Mode :	UHF RFID	Temperature :	20~25°C
Test Engineer :	Ray Wang	Relative Humidity :	50~56%

<Internal Antenna>

Frequency (MHz)	RF Power (dBm)
	UHF
917.9	22.40
922.7	22.40
927.7	22.30

<External Antenna>

Frequency (MHz)	RF Power (dBm)
	UHF
917.9	22.50
922.7	22.50
927.7	22.40

3.6 Conducted Band Edges Measurement

3.6.1 Limit of Band Edges

In any 100 kHz bandwidth outside the intentional radiation frequency band, the radio frequency power shall be at least 20 dB below the highest level of the radiated power. In addition, radiated emissions which fall in the restricted bands must also comply with the radiated emission limits.

3.6.2 Measuring Instruments

Please refer to the measuring equipment list in this test report.

3.6.3 Test Procedures

1. The testing follows ANSI C63.10-2013 clause 7.8.6.
2. Set the maximum power setting and enable the EUT to transmit continuously.
3. Set RBW = 100 kHz, VBW = 300 kHz. Band edge emissions must be at least 20 dB down from the highest emission level within the authorized band as measured with a 100 kHz RBW. The attenuation shall be 30 dB instead of 20 dB when RMS conducted output power procedure is used.
4. Enable hopping function of the EUT and then repeat step 2 and 3.
5. Measure and record the results in the test report.

3.6.4 Test Setup

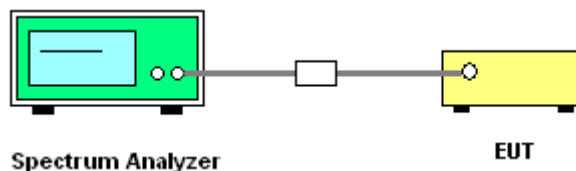



3.6.5 Test Result of Conducted Band Edges

Test Mode :	UHF RFID	Temperature :	20~25°C
Test Engineer :	Ray Wang	Relative Humidity :	50~56%

<Internal Antenna>

Low Band Edge Plot on 917.9 MHz

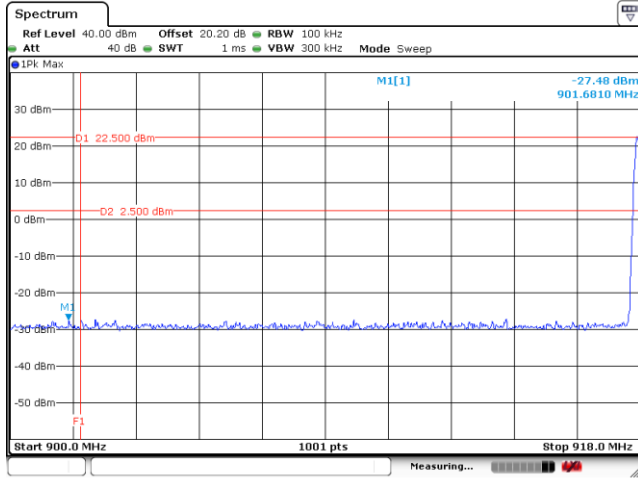

Date: 12.MAY.2023 03:13:34

High Band Edge Plot on 927.7 MHz

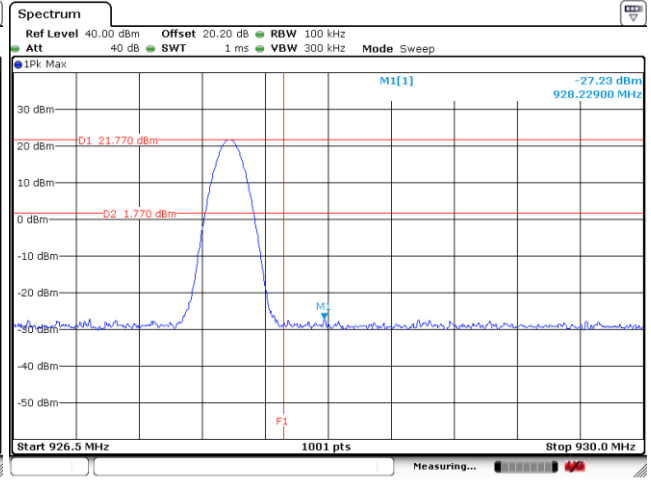

Date: 10.MAY.2023 02:25:55

<External Antenna>

Low Band Edge Plot on 917.9 MHz

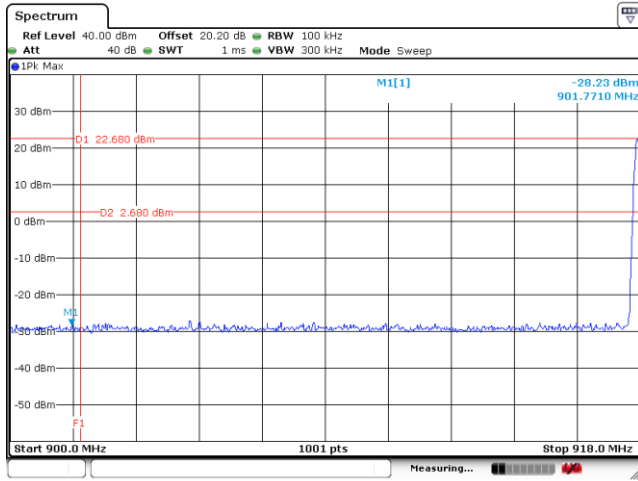

Date: 12.MAY.2023 03:21:39

High Band Edge Plot on 927.7 MHz

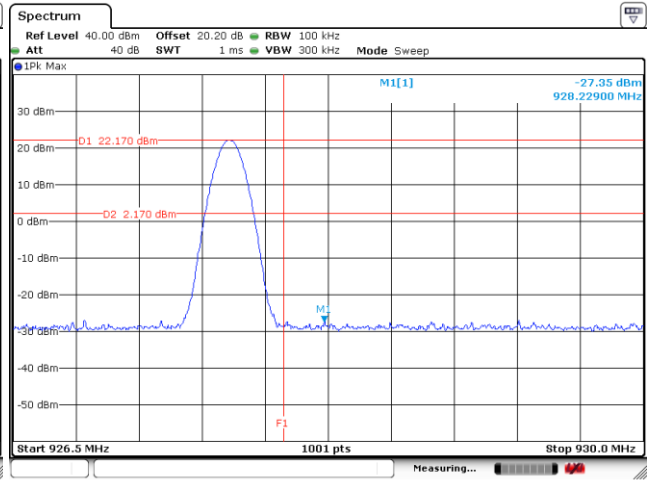

Date: 11.MAY.2023 01:25:00



3.6.6 Test Result of Conducted Hopping Mode Band Edges

Test Mode :	UHF RFID	Temperature :	20~25°C
Test Engineer :	Ray Wang	Relative Humidity :	50~56%

<Internal Antenna>

Hopping Mode Low Band Edge Plot on 917.9 MHz

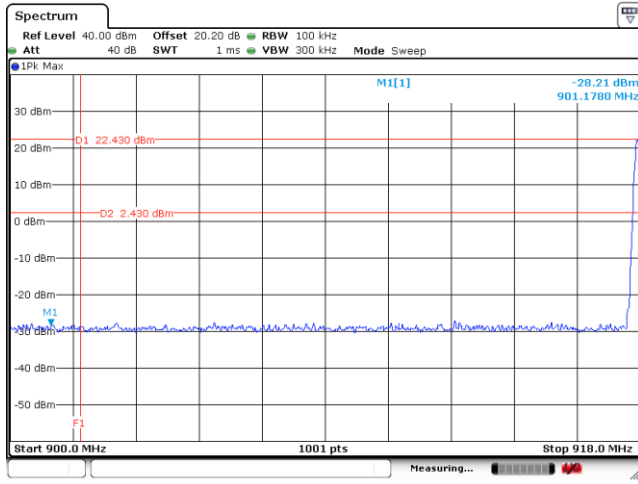

Date: 12.MAY.2023 03:31:13

Hopping Mode Low Band Edge Plot on 927.7 MHz

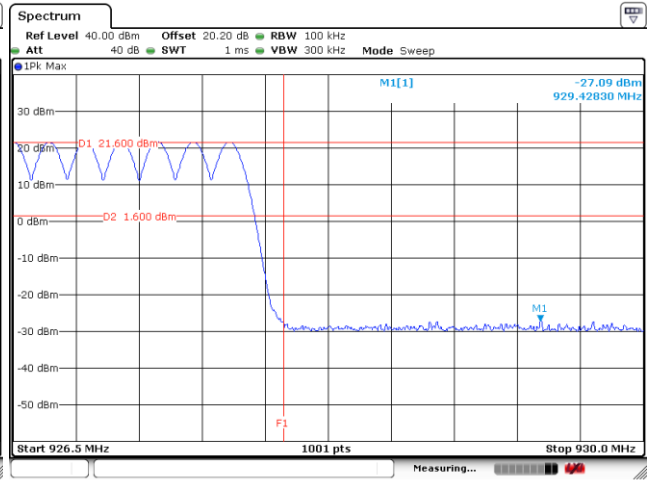

Date: 10.MAY.2023 02:21:43

<External Antenna>

Hopping Mode Low Band Edge Plot on 917.9 MHz

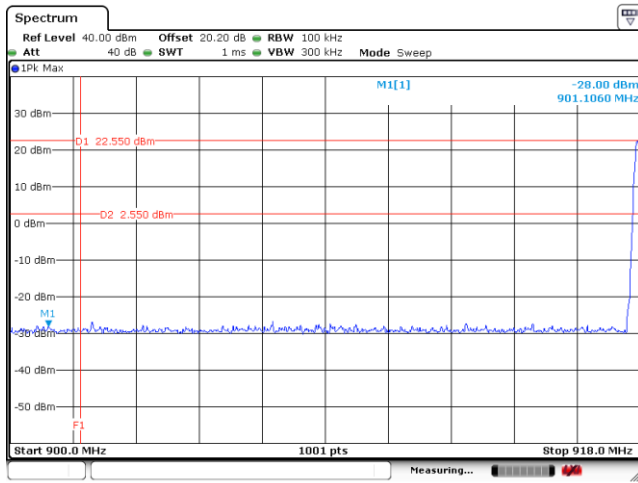

Date: 12.MAY.2023 03:28:15

Hopping Mode Low Band Edge Plot on 927.7 MHz

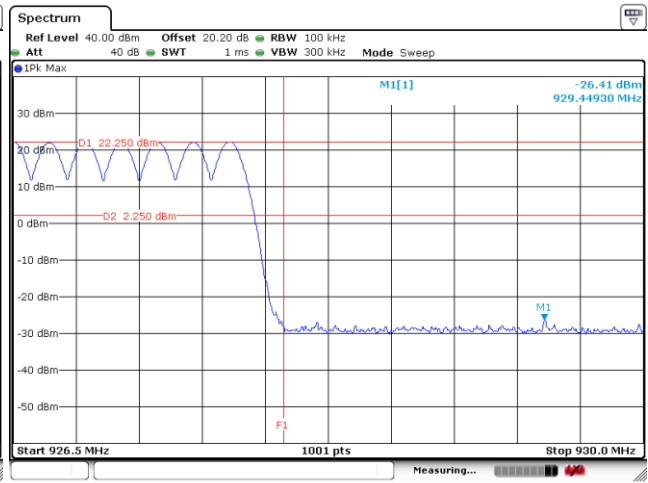

Date: 11.MAY.2023 01:13:07

3.7 Conducted Spurious Emission Measurement

3.7.1 Limit of Spurious Emission Measurement

In any 100 kHz bandwidth outside the intentional radiation frequency band, the radio frequency power shall be at least 20 dB below the highest level of the radiated power. In addition, radiated emissions which fall in the restricted bands must also comply with the radiated emission limits.

3.7.2 Measuring Instruments

Please refer to the measuring equipment list in this test report.

3.7.3 Test Procedure

1. The testing follows ANSI C63.10-2013 clause 7.8.8.
2. The RF output of EUT was connected to the spectrum analyzer by RF cable and attenuator. The path loss was compensated to the results for each measurement.
3. Set the maximum power setting and enable the EUT to transmit continuously.
4. Set RBW = 100 kHz, VBW = 300 kHz, scan up through 10th harmonic. All harmonics / spurs must be at least 20 dB down from the highest emission level within the authorized band as measured with a 100 kHz RBW.
5. Measure and record the results in the test report.
6. The RF fundamental frequency should be excluded against the limit line in the operating frequency band.

3.7.4 Test Setup





3.7.5 Test Result of Conducted Spurious Emission

Test Mode :	UHF RFID	Temperature :	20~25°C
Test Engineer :	Ray Wang	Relative Humidity :	50~56%

<Internal Antenna>

CSE Plot on 917.9 MHz between 30MHz ~ 10 GHz CSE Plot on 922.7 MHz between 30MHz ~ 10 GHz

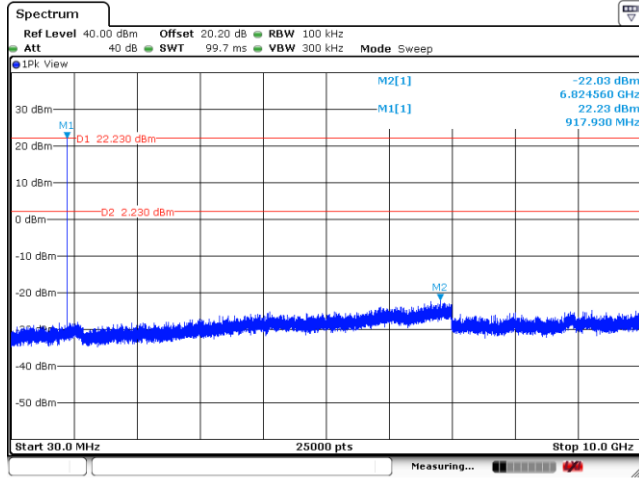

Date: 6 MAY 2023 04:28:50

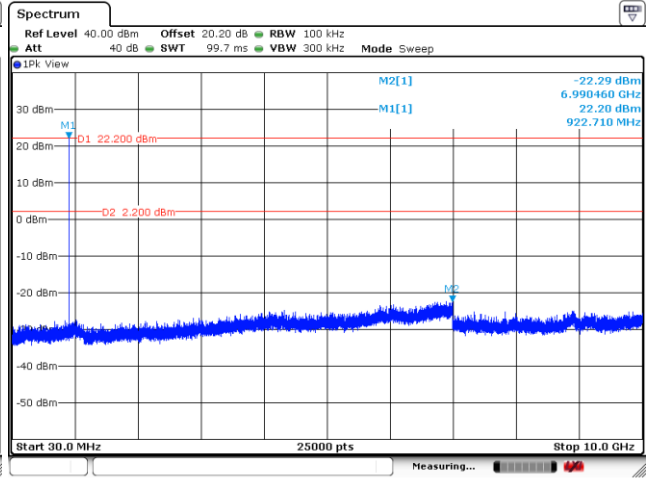

Date: 6 MAY 2023 04:05:44

CSE Plot on 927.7 MHz between 30MHz ~ 10 GHz

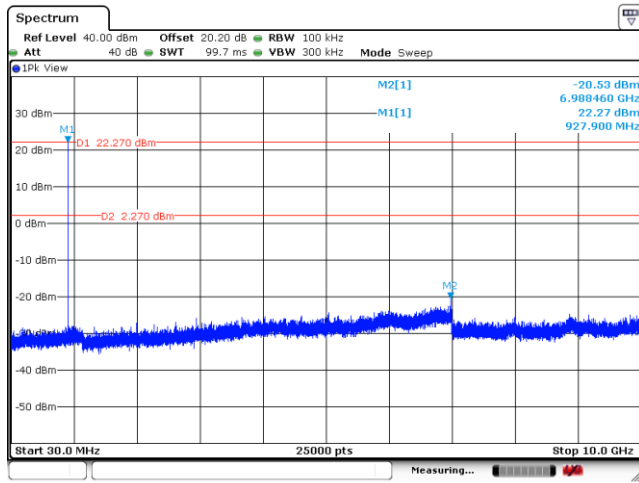

Date: 6 MAY 2023 04:22:40



<External Antenna>

CSE Plot on 917.9 MHz between 30MHz ~ 10 GHz

CSE Plot on 922.7 MHz between 30MHz ~ 10 GHz

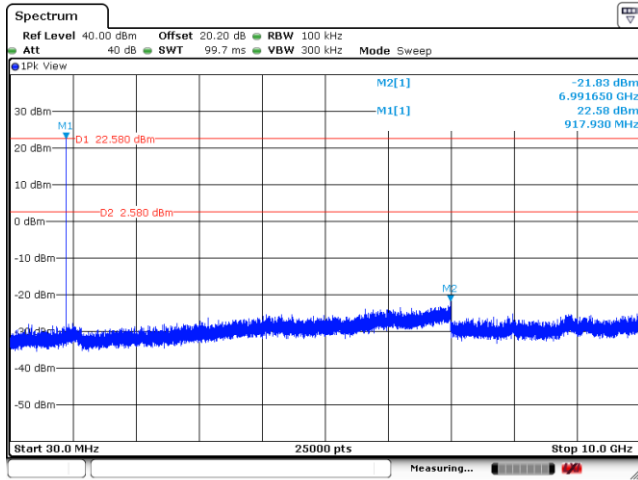

Date: 6 MAY 2023 05:11:40

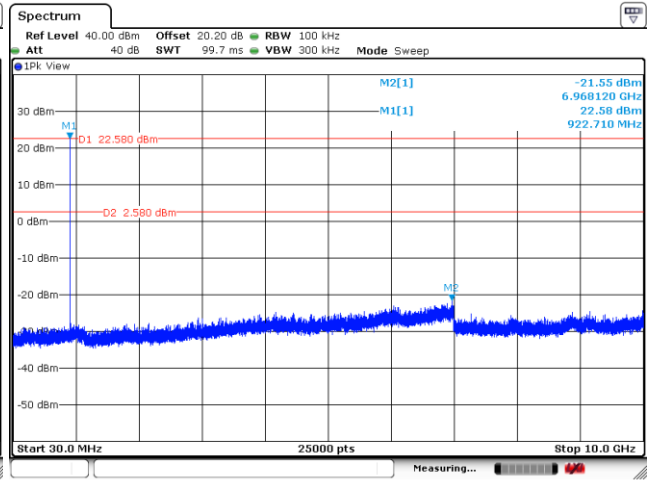

Date: 6 MAY 2023 05:15:51

CSE Plot on 927.7 MHz between 30MHz ~ 10 GHz

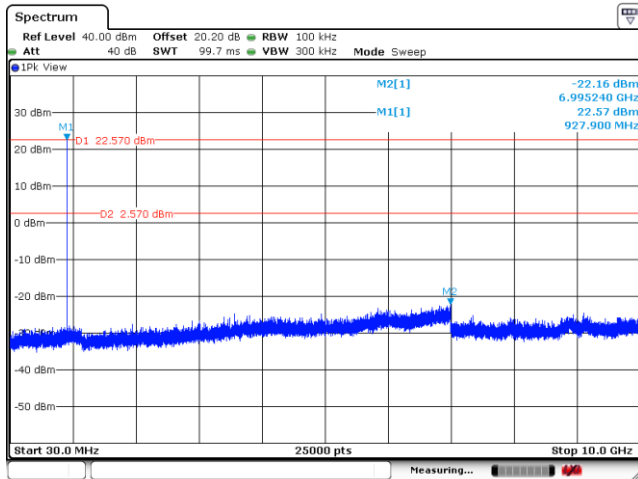

Date: 6 MAY 2023 05:44:38



3.8 Radiated Band Edges and Spurious Emission Measurement

3.8.1 Limit of Radiated Band Edges and Spurious Emission

In any 100 kHz bandwidth outside the intentional radiator frequency band, all harmonics/spurious must be at least 20 dB below the highest emission level within the authorized band. In addition, radiated emissions which fall in the restricted bands must also comply with the limits as below.

Frequency (MHz)	Field Strength (microvolts/meter)	Measurement Distance (meters)
0.009 – 0.490	2400/F(kHz)	300
0.490 – 1.705	24000/F(kHz)	30
1.705 – 30.0	30	30
30 – 88	100	3
88 – 216	150	3
216 - 960	200	3
Above 960	500	3

3.8.2 Measuring Instruments

Please refer to the measuring equipment list in this test report.



3.8.3 Test Procedures

1. The EUT is placed on a turntable with 0.8 meter for frequency below 1 GHz and 1.5 meter for frequency above 1 GHz respectively above ground.
2. The EUT is set 3 meters away from the receiving antenna, which is mounted on the top of a variable height antenna tower.
3. For each suspected emission, the EUT is arranged to its worst case and then tune the Antenna tower (from 1 m to 4 m) and turntable (from 0 degree to 360 degrees) to find the maximum reading. A pre-amp and a high pass filter are used for the test in order to get better signal level to comply with the guidelines.
4. Set the maximum power setting and enable the EUT to transmit continuously.
5. Use the following spectrum analyzer settings:
 - (1) Span shall wide enough to fully capture the emission being measured;
 - (2) Set RBW = 100 kHz for $f < 1$ GHz, RBW = 1 MHz for $f > 1$ GHz ; VBW \geq RBW; Sweep = auto; Detector function = peak; Trace = max hold for peak
 - (3) For average measurement: use duty cycle correction factor method per 15.35(c).
Duty cycle = On time/100 milliseconds
On time = $N_1 * L_1 + N_2 * L_2 + \dots + N_{n-1} * L_{n-1} + N_n * L_n$
Where N_1 is number of type 1 pulses, L_1 is length of type 1 pulses, etc.
Average Emission Level = Peak Emission Level + $20 * \log$ (Duty cycle)
6. Corrected Reading: Antenna Factor + Cable Loss + Read Level - Preamp Factor = Level
7. Radiated testing below 1 GHz is performed by adjusting the antenna tower from 1 m to 4 m and by rotating the turn table from 0 degree to 360 degrees to find the peak maximum hold reading. When there is no suspected emission found and the emission level is with at least 6 dB margin against QP limit line, the position is marked as “-“.
8. Radiated testing above 1 GHz is performed by adjusting the antenna tower from 1 m to 4 m and by rotating the turn table from 0 degree to 360 degrees to find the peak maximum hold reading for scanning all frequencies. When there is no suspected emission found and the harmonic emission level is with at least 6 dB margin against average limit line, the position is marked as “-“.

3.8.4 Test Setup

For radiated emissions below 30MHz

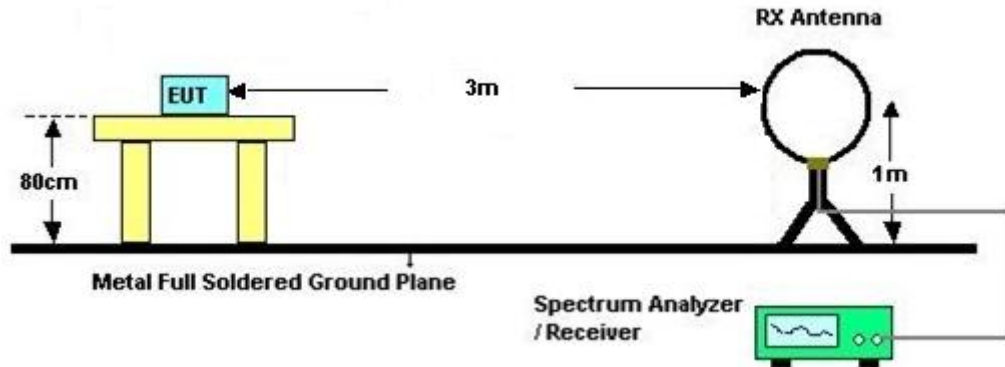

For radiated emissions from 30MHz to 1GHz

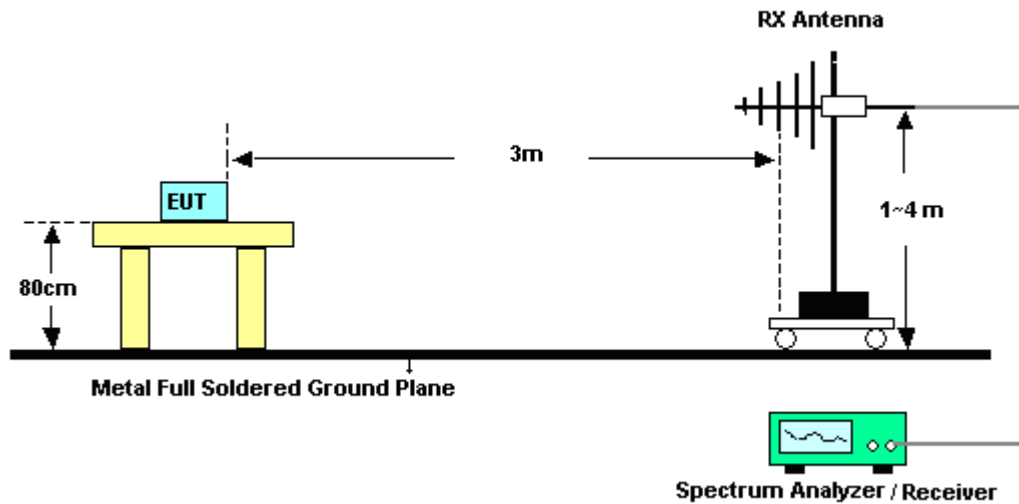

For radiated emissions above 1GHz

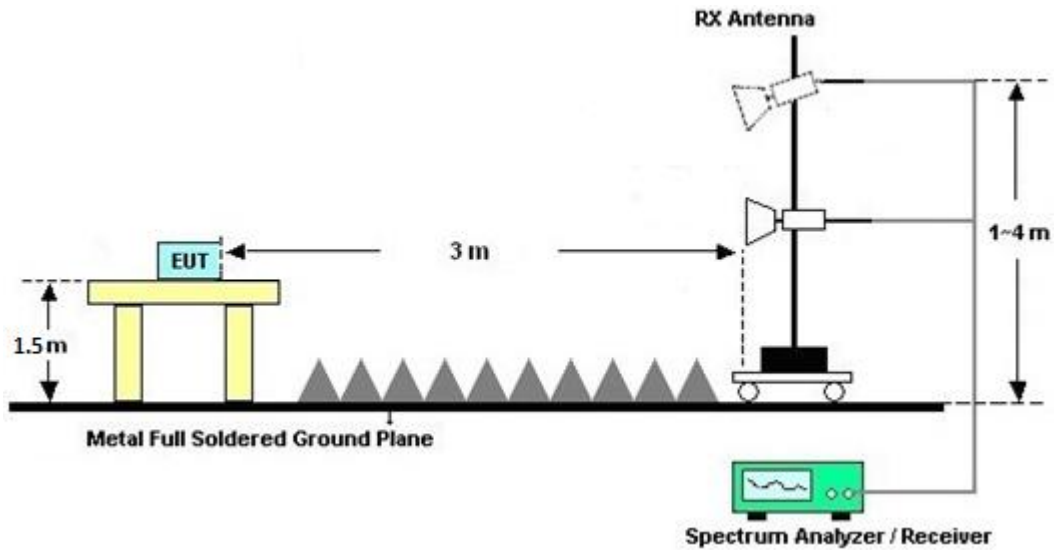

3.8.5 Test Results of Radiated Spurious Emissions (9 kHz ~ 30 MHz)

The low frequency, which started from 9 kHz to 30MHz, was pre-scanned and the result which was 20dB lower than the limit line was not reported.

There is adequate comparison measurement of both open-field test site and alternative test site - semi-Anechoic chamber according to 414788 D01 Radiated Test Site v01r01, and the result came out very similar.

3.8.6 Test Result of Radiated Spurious at Band Edges

Please refer to Appendix B and C.

3.8.7 Duty Cycle

Please refer to Appendix D.

3.8.8 Test Result of Radiated Spurious Emission

Please refer to Appendix B and C.



3.9 AC Power Line Conducted Emissions Measurement

3.9.1 Limit of AC Conducted Emission

For equipment that is designed to be connected to the public utility (AC) power line, the radio frequency voltage that is conducted back onto the AC power line on any frequency or frequencies within the band 150 kHz to 30 MHz shall not exceed the limits in the following table.

Frequency of Emission (MHz)	Conducted Limit (dBµV)	
	Quasi-Peak	Average
0.15-0.5	66 to 56*	56 to 46*
0.5-5	56	46
5-30	60	50

*Decreases with the logarithm of the frequency.

3.9.2 Measuring Instruments

Please refer to the measuring equipment list in this test report.

3.9.3 Test Procedures

1. The EUT was placed 0.4 meter from the conducting wall of the shielding room, and it was kept at least 80 centimeters from any other grounded conducting surface.
2. Connect EUT to the power mains through a line impedance stabilization network (LISN).
3. All the support units are connecting to the other LISN.
4. The LISN provides 50 ohm coupling impedance for the measuring instrument.
5. The FCC states that a 50 ohm, 50 microhenry LISN shall be used.
6. Both sides of AC line were checked for maximum conducted interference.
7. The frequency range from 150 kHz to 30 MHz was searched.
8. Set the test-receiver system to Peak Detect Function and specified bandwidth (IF Bandwidth = 9kHz) with Maximum Hold Mode. Then measurement is also conducted by Average Detector and Quasi-Peak Detector Function respectively.

3.9.4 Test setup



3.9.5 Test Result of AC Conducted Emission

Please refer to Appendix A.



3.10 Antenna Requirements

3.10.1 Standard Applicable

The use of a permanently attached antenna or of an antenna that uses a unique coupling to the intentional radiator shall be considered sufficient to comply with the rule.

3.10.2 Antenna Anti-Replacement Construction

An embedded-in antenna design is used.



4 List of Measuring Equipment

Instrument	Brand Name	Model No.	Serial No.	Characteristics	Calibration Date	Test Date	Due Date	Remark
Bilog Antenna	TESEQ	CBL 6111D & N-6-06	35414 & AT-N0602	30MHz~1GHz	Oct. 08, 2022	Apr. 12, 2023	Oct. 07, 2023	Radiation (03CH11-HY)
Horn Antenna	SCHWARZBECK	BBHA 9120 D	9120D-01620	1GHz~18GHz	Aug. 24, 2022	Apr. 12, 2023	Aug. 23, 2023	Radiation (03CH11-HY)
Amplifier	SONOMA	310N	187312	9kHz~1GHz	Dec. 09, 2022	Apr. 12, 2023	Dec. 08, 2023	Radiation (03CH11-HY)
Preamplifier	Keysight	83017A	MY53270080	1GHz~26.5GHz	Nov. 09, 2022	Apr. 12, 2023	Nov. 08, 2023	Radiation (03CH11-HY)
Preamplifier	Jet-Power	JPA0118-55-303	1710001800055007	1GHz~18GHz	Jun. 15, 2022	Apr. 12, 2023	Jun. 14, 2023	Radiation (03CH11-HY)
Spectrum Analyzer	Keysight	N9010A	MY54200486	10Hz~44GHz	Oct. 07, 2022	Apr. 12, 2023	Oct. 06, 2023	Radiation (03CH11-HY)
EMI Test Receiver	Keysight	N9038A(MXE)	MY54130085	20MHz~8.4GHz	Oct. 18, 2022	Apr. 12, 2023	Oct. 17, 2023	Radiation (03CH11-HY)
Controller	EMEC	EM 1000	N/A	Control Turn table & Ant Mast	N/A	Apr. 12, 2023	N/A	Radiation (03CH11-HY)
Antenna Mast	EMEC	AM-BS-4500-B	N/A	1~4m	N/A	Apr. 12, 2023	N/A	Radiation (03CH11-HY)
Turn Table	EMEC	TT 2000	N/A	0~360 Degree	N/A	Apr. 12, 2023	N/A	Radiation (03CH11-HY)
Software	Audix	E3 6.2009-8-24	RK-001053	N/A	N/A	Apr. 12, 2023	N/A	Radiation (03CH11-HY)
RF Cable	HUBER + SUHNER	SUCOFLEX 102	MY2859/2	30MHz~40GHz	Mar. 07, 2023	Apr. 12, 2023	Mar. 06, 2024	Radiation (03CH11-HY)
RF Cable	HUBER + SUHNER	SUCOFLEX 102	801595/2	30MHz~40GHz	Mar. 07, 2023	Apr. 12, 2023	Mar. 06, 2024	Radiation (03CH11-HY)
RF Cable	HUBER + SUHNER	SUCOFLEX 102	803951/2	9K~30M	Mar. 07, 2023	Apr. 12, 2023	Mar. 06, 2024	Radiation (03CH11-HY)
RF Cable	HUBER + SUHNER	SUCOFLEX 102	803951/2	30M~40G	Mar. 07, 2023	Apr. 12, 2023	Mar. 06, 2024	Radiation (03CH11-HY)
Hygrometer	TECPEL	DTM-303B	TP140325	N/A	Nov. 07, 2022	Apr. 12, 2023	Nov. 06, 2023	Radiation (03CH11-HY)
Filter	Wainwright	WLK4-1000-1530-8000-40SS	SN11	1.53G Low Pass	Sep. 12, 2022	Apr. 12, 2023	Sep. 11, 2023	Radiation (03CH11-HY)
Filter	Wainwright	WHKX12-2700-3000-18000-60SS	SN3	3GHz High Pass Filter	Sep. 12, 2022	Apr. 12, 2023	Sep. 11, 2023	Radiation (03CH11-HY)



Instrument	Brand Name	Model No.	Serial No.	Characteristics	Calibration Date	Test Date	Due Date	Remark
AC Power Source	ChainTek	APC-1000W	N/A	N/A	N/A	Apr. 18, 2023	N/A	Conduction (CO05-HY)
EMI Test Receiver	Rohde & Schwarz	ESR3	102388	9kHz~3.6GHz	Dec. 01, 2022	Apr. 18, 2023	Nov. 30, 2023	Conduction (CO05-HY)
Hygrometer	Testo	608-H1	34913912	N/A	Nov. 17, 2022	Apr. 18, 2023	Nov. 16, 2023	Conduction (CO05-HY)
LISN	Rohde & Schwarz	ENV216	100081	9kHz~30MHz	Nov. 17, 2022	Apr. 18, 2023	Nov. 16, 2023	Conduction (CO05-HY)
Software	Rohde & Schwarz	EMC32	N/A	N/A	N/A	Apr. 18, 2023	N/A	Conduction (CO05-HY)
Pulse Limiter	SCHWARZBECK	VTSD 9561-FN	00691	N/A	Aug. 01, 2022	Apr. 18, 2023	Jul. 31, 2023	Conduction (CO05-HY)
LISN Cable	MVE	RG-400	260260	N/A	Dec. 29, 2022	Apr. 18, 2023	Dec. 28, 2023	Conduction (CO05-HY)
Hygrometer	TECPEL	DTM-303A	TP201996	N/A	Nov. 17, 2022	Apr. 21, 2023~ May 13, 2023	Nov. 16, 2023	Conducted (TH05-HY)
Power Meter	Anritsu	ML2495A	1036004	N/A	Aug. 08, 2022	Apr. 21, 2023~ May 13, 2023	Aug. 07, 2023	Conducted (TH05-HY)
Power Sensor	DARE	RPR3006W	16I00054SNO12 (NO:113)	10MHz~6GHz	Dec. 13, 2022	Apr. 21, 2023~ May 13, 2023	Dec. 12, 2023	Conducted (TH05-HY)
Signal Analyzer	Rohde & Schwarz	FSV40	101905	10Hz - 40GHz	Aug. 03, 2022	Apr. 21, 2023~ May 13, 2023	Aug. 02, 2023	Conducted (TH05-HY)



5 Measurement Uncertainty

Uncertainty of Conducted Emission Measurement (150kHz ~ 30MHz)

Measuring Uncertainty for a Level of Confidence of 95% ($U = 2Uc(y)$)	3.5 dB
-------------------------------------------------------------------------	--------

Uncertainty of Radiated Emission Measurement (30 MHz ~ 1000 MHz)

Measuring Uncertainty for a Level of Confidence of 95% ($U = 2Uc(y)$)	6.3 dB
-------------------------------------------------------------------------	--------

Uncertainty of Radiated Emission Measurement (1000 MHz ~ 6000 MHz)

Measuring Uncertainty for a Level of Confidence of 95% ($U = 2Uc(y)$)	4.4 dB
-------------------------------------------------------------------------	--------

Uncertainty of Radiated Emission Measurement (6000 MHz ~ 18000 MHz)

Measuring Uncertainty for a Level of Confidence of 95% ($U = 2Uc(y)$)	4.8 dB
-------------------------------------------------------------------------	--------

Uncertainty of Radiated Emission Measurement (18000 MHz ~ 40000 MHz)

Measuring Uncertainty for a Level of Confidence of 95% ($U = 2Uc(y)$)	5.3 dB
-------------------------------------------------------------------------	--------



Appendix A. AC Conducted Emission Test Results

Test Engineer :	Calvin Wang	Temperature :	23~26°C
		Relative Humidity :	45~55%

EUT Information

Report NO : 100707-11
 Test Mode : Mode 1
 Test Voltage : 120Vac/60Hz
 Phase : Line

Full Spectrum

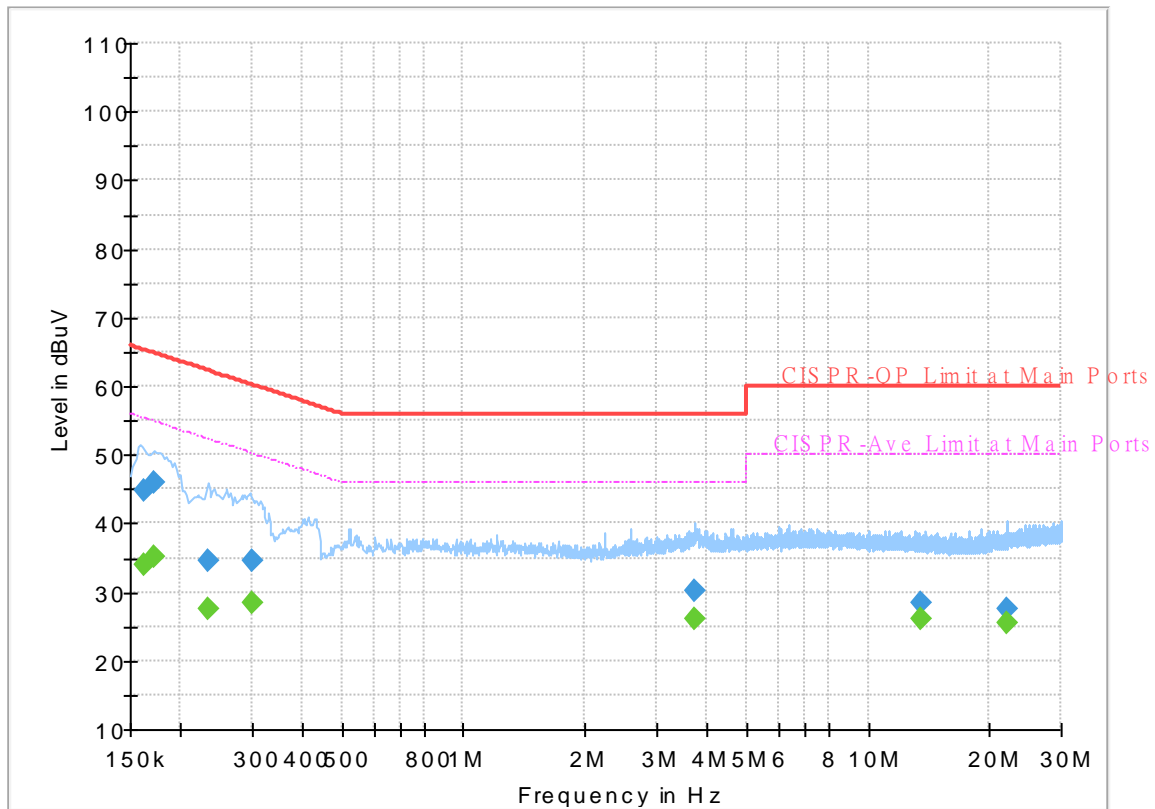

Final Result

Frequency (MHz)	QuasiPeak (dBuV)	CAverage (dBuV)	Limit (dBuV)	Margin (dB)	Line	Filter	Corr. (dB)
0.162420	---	33.95	55.34	21.39	L1	OFF	19.9
0.162420	44.84	---	65.34	20.50	L1	OFF	19.9
0.171690	---	35.28	54.88	19.60	L1	OFF	19.9
0.171690	45.86	---	64.88	19.02	L1	OFF	19.9
0.233160	---	27.65	52.34	24.69	L1	OFF	19.9
0.233160	34.52	---	62.34	27.82	L1	OFF	19.9
0.300750	---	28.46	50.22	21.76	L1	OFF	19.9
0.300750	34.48	---	60.22	25.74	L1	OFF	19.9
3.720030	---	25.95	46.00	20.05	L1	OFF	20.0
3.720030	30.30	---	56.00	25.70	L1	OFF	20.0
13.560900	---	25.97	50.00	24.03	L1	OFF	20.4
13.560900	28.49	---	60.00	31.51	L1	OFF	20.4
21.993000	---	25.59	50.00	24.41	L1	OFF	20.6
21.993000	27.61	---	60.00	32.39	L1	OFF	20.6

EUT Information

Report NO : 100707-11
 Test Mode : Mode 1
 Test Voltage : 120Vac/60Hz
 Phase : Neutral

Full Spectrum

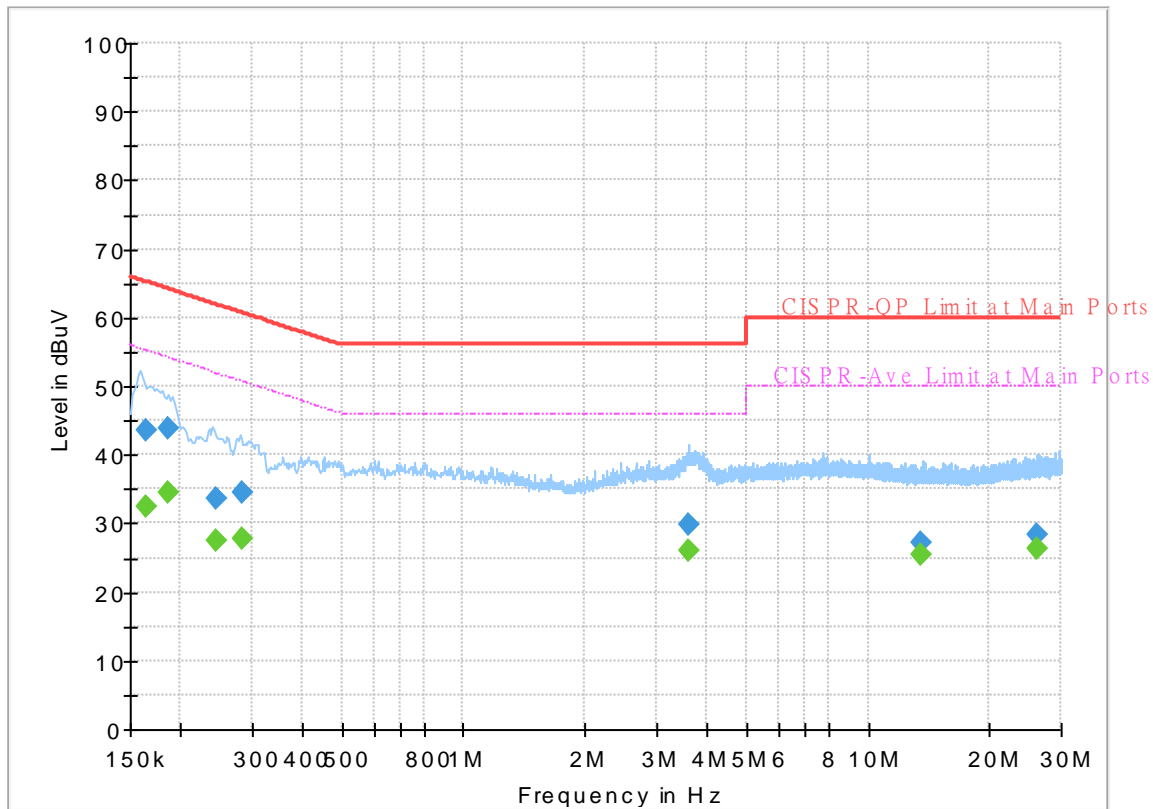

Final Result

Frequency (MHz)	QuasiPeak (dBuV)	CAverage (dBuV)	Limit (dBuV)	Margin (dB)	Line	Filter	Corr. (dB)
0.163500	---	32.50	55.28	22.78	N	OFF	19.9
0.163500	43.64	---	65.28	21.64	N	OFF	19.9
0.186000	---	34.54	54.21	19.67	N	OFF	19.9
0.186000	43.91	---	64.21	20.30	N	OFF	19.9
0.244500	---	27.46	51.94	24.48	N	OFF	19.9
0.244500	33.53	---	61.94	28.41	N	OFF	19.9
0.283830	---	27.86	50.70	22.84	N	OFF	19.9
0.283830	34.51	---	60.70	26.19	N	OFF	19.9
3.621750	---	25.89	46.00	20.11	N	OFF	20.0
3.621750	29.83	---	56.00	26.17	N	OFF	20.0
13.555500	---	25.40	50.00	24.60	N	OFF	20.4
13.555500	27.16	---	60.00	32.84	N	OFF	20.4
26.123730	---	26.40	50.00	23.60	N	OFF	20.8
26.123730	28.32	---	60.00	31.68	N	OFF	20.8



Appendix B. Radiated Spurious Emission

Test Engineer :	Yuan Lee and Bank Lin	Temperature :	20.2~20.7°C
		Relative Humidity :	65.1~65.9%

<Internal Antenna>

UHF RFID

UHF RFID (Band Edge @ 3m)

UHF RFID	Note	Frequency (MHz)	Level (dBμV/m)	Margin (dB)	Limit Line (dBμV/m)	Read Level (dBμV)	Antenna Factor (dB/m)	Path Loss (dB)	Preamp Factor (dB)	Ant Pos (cm)	Table Pos (deg)	Peak Avg. (P/A)	Pol. (H/V)	
RFID 917.9MHz		30	33.72	-6.28	40	31.23	23.92	10.72	32.15	-	-	P	H	
		120.45	27.6	-15.9	43.5	30.84	17.28	11.64	32.16	-	-	P	H	
		259.23	29.69	-16.31	46	29.96	19.36	12.39	32.02	-	-	P	H	
		431.6	34.43	-11.57	46	30.6	22.73	13.04	31.94	-	-	P	H	
		498.8	35.78	-10.22	46	30.99	23.63	13.33	32.17	-	-	P	H	
		625.5	37.72	-8.28	46	30.15	25.89	13.73	32.05	-	-	P	H	
	*	917.9	121.72	-	-	109.71	28.68	14.41	31.08	100	360	P	H	
													P	H
			30.54	33.77	-6.23	40	31.52	23.68	10.73	32.16	-	-	P	V
			136.38	27.84	-15.66	43.5	30.93	17.34	11.73	32.16	-	-	P	V
			255.18	33.36	-12.64	46	34.3	18.72	12.37	32.03	-	-	P	V
			321.7	33.16	-12.84	46	33.14	19.4	12.62	32	-	-	P	V
			486.2	35.49	-10.51	46	30.84	23.48	13.26	32.09	-	-	P	V
			580.7	37.6	-8.4	46	30.83	25.26	13.58	32.07	-	-	P	V
	*		917.9	112.96	-	-	100.95	28.68	14.41	31.08	149	293	P	V
												P	V	

Remark	1. No other spurious found.
	2. All results are PASS against Peak and Average limit line.
	3. Non restricted band limit is radio frequency level down 20db.
	4. The emission position marked as "-" means no suspected emission found and emission level has at least 6dB margin against limit or emission is noise floor only.



UHF RFID	Note	Frequency (MHz)	Level (dBµV/m)	Margin (dB)	Limit Line (dBµV/m)	Read Level (dBµV)	Antenna Factor (dB/m)	Path Loss (dB)	Preamp Factor (dB)	Ant Pos (cm)	Table Pos (deg)	Peak Avg. (P/A)	Pol. (H/V)	
RFID 922.7MHz		30	33.85	-6.15	40	31.36	23.92	10.72	32.15	-	-	P	H	
		133.14	26.87	-16.63	43.5	30.01	17.29	11.73	32.16	-	-	P	H	
		266.52	29.59	-16.41	46	29.97	19.23	12.41	32.02	-	-	P	H	
		377.7	31.72	-14.28	46	30.08	20.87	12.82	32.05	-	-	P	H	
		492.5	35.53	-10.47	46	30.83	23.54	13.29	32.13	-	-	P	H	
		563.9	38.45	-7.55	46	31.1	25.78	13.56	31.99	-	-	P	H	
	*	922.7	121.86	-	-	109.59	28.88	14.43	31.04	100	360	P	H	
													P	H
			30	33.78	-6.22	40	31.29	23.92	10.72	32.15	-	-	P	V
			125.31	27.73	-15.77	43.5	30.79	17.44	11.66	32.16	-	-	P	V
			258.96	30.14	-15.86	46	30.45	19.32	12.39	32.02	-	-	P	V
			482.7	35.46	-10.54	46	30.86	23.42	13.25	32.07	-	-	P	V
			565.3	37.79	-8.21	46	30.52	25.71	13.56	32	-	-	P	V
			628.3	38.32	-7.68	46	30.62	26	13.74	32.04	-	-	P	V
	*		922.7	113.24	-	-	100.97	28.88	14.43	31.04	149	289	P	V
													P	V
Remark	<ol style="list-style-type: none"> No other spurious found. All results are PASS against Peak and Average limit line. Non restricted band limit is radio frequency level down 20db. The emission position marked as "-" means no suspected emission found and emission level has at least 6dB margin against limit or emission is noise floor only. 													



UHF RFID	Note	Frequency (MHz)	Level (dBµV/m)	Margin (dB)	Limit Line (dBµV/m)	Read Level (dBµV)	Antenna Factor (dB/m)	Path Loss (dB)	Preamp Factor (dB)	Ant Pos (cm)	Table Pos (deg)	Peak Avg. (P/A)	Pol. (H/V)	
RFID 927.7MHz		30	33.9	-6.1	40	31.41	23.92	10.72	32.15	-	-	P	H	
		130.17	27.85	-15.65	43.5	30.96	17.34	11.71	32.16	-	-	P	H	
		259.23	30.03	-15.97	46	30.3	19.36	12.39	32.02	-	-	P	H	
		433	34.6	-11.4	46	30.76	22.72	13.05	31.93	-	-	P	H	
		558.3	37.77	-8.23	46	30.4	25.8	13.54	31.97	-	-	P	H	
		619.2	37.74	-8.26	46	30.53	25.59	13.7	32.08	-	-	P	H	
	*	927.7	122.03	-	-	109.45	29.12	14.46	31	100	360	P	H	
													P	H
			30.81	33.96	-6.04	40	31.82	23.56	10.74	32.16	-	-	P	V
			81.03	27.61	-12.39	40	35.12	13.29	11.36	32.16	-	-	P	V
			263.55	29.37	-16.63	46	29.33	19.65	12.41	32.02	-	-	P	V
			430.9	35.06	-10.94	46	31.22	22.74	13.04	31.94	-	-	P	V
			570.9	37.78	-8.22	46	30.71	25.53	13.57	32.03	-	-	P	V
			618.5	37.41	-8.59	46	30.21	25.58	13.7	32.08	-	-	P	V
	*		927.7	113.18	-	-	100.6	29.12	14.46	31	150	292	P	V
												P	V	
Remark	<ol style="list-style-type: none"> No other spurious found. All results are PASS against Peak and Average limit line. Non restricted band limit is radio frequency level down 20db. The emission position marked as "-" means no suspected emission found and emission level has at least 6dB margin against limit or emission is noise floor only. 													



UHF RFID

UHF RFID (Harmonic @ 3m)

UHF RFID	Note	Frequency	Level	Margin	Limit	Read	Antenna	Path	Preamp	Ant	Table	Peak	Pol.
		(MHz)	(dBµV/m)	(dB)	(dBµV/m)	(dBµV)	(dB/m)	(dB)	(dB)	(cm)	(deg)	(P/A)	(H/V)
RFID 917.9MHz		2753.7	42.03	-11.97	54	39.66	28.51	7.98	34.12	100	96	P	H
		2753.7	49.15	-24.85	74	46.78	28.51	7.98	34.12	100	96	A	H
		3671.6	44.8	-9.2	54	62.85	29.84	10.87	58.76	103	113	P	H
		3671.6	46.3	-27.7	74	64.35	29.84	10.87	58.76	103	113	A	H
		4589.5	41.7	-32.3	74	55.05	31.9	12.53	57.78	-	-	P	H
		7343.2	43.89	-30.11	74	51.48	36.73	14.41	58.73	-	-	P	H
		8261.1	45.37	-28.63	74	51.27	37.02	15.41	58.33	-	-	P	H
		9179	45.97	-28.03	74	49.71	38.22	16.49	58.45	-	-	P	H
		2753.7	45.26	-8.74	54	42.89	28.51	7.98	34.12	127	210	P	V
		2753.7	50.93	-23.07	74	48.56	28.51	7.98	34.12	127	210	A	V
		3671.6	40.64	-13.36	54	58.69	29.84	10.87	58.76	100	233	P	V
		3671.6	41.97	-32.03	74	60.02	29.84	10.87	58.76	100	233	A	V
		4589.5	42.26	-31.74	74	55.61	31.9	12.53	57.78	-	-	P	V
		7343.2	44.52	-29.48	74	52.11	36.73	14.41	58.73	-	-	P	V
		8261.1	45.72	-28.28	74	51.62	37.02	15.41	58.33	-	-	P	V
		9179	45.59	-28.41	74	49.33	38.22	16.49	58.45	-	-	P	V
Remark	<ol style="list-style-type: none"> No other spurious found. All results are PASS against Peak and Average limit line. Non restricted band limit is radio frequency level down 20db. The emission position marked as "-" means no suspected emission found with sufficient margin against limit line or noise floor only. 												



UHF RFID	Note	Frequency (MHz)	Level (dBμV/m)	Margin (dB)	Limit Line (dBμV/m)	Read Level (dBμV)	Antenna Factor (dB/m)	Path Loss (dB)	Preamp Factor (dB)	Ant Pos (cm)	Table Pos (deg)	Peak Avg. (P/A)	Pol. (H/V)	
RFID 922.7MHz		2768.1	45.17	-8.83	54	42.76	28.54	7.99	34.12	110	110	P	H	
		2768.1	50.09	-23.91	74	47.68	28.54	7.99	34.12	110	110	A	H	
		3690.8	42.27	-11.73	54	60.24	29.88	10.87	58.72	107	98	P	H	
		3690.8	45.15	-28.85	74	63.12	29.88	10.87	58.72	107	98	A	H	
		4613.5	41.57	-32.43	74	54.95	31.95	12.47	57.8	-	-	P	H	
		7381.6	42.56	-31.44	74	50.36	36.57	14.35	58.72	-	-	P	H	
		8304.3	44.27	-29.73	74	50.04	37.09	15.45	58.31	-	-	P	H	
														H
			2768.1	46.05	-7.95	54	43.64	28.54	7.99	34.12	100	211	P	V
			2768.1	50.58	-23.42	74	48.17	28.54	7.99	34.12	100	211	A	V
			3690.8	41.91	-12.09	54	59.88	29.88	10.87	58.72	100	154	P	V
			3690.8	42.32	-31.68	74	60.29	29.88	10.87	58.72	100	154	A	V
			4613.5	41.32	-32.68	74	54.7	31.95	12.47	57.8	-	-	P	V
			7381.6	42.92	-31.08	74	50.72	36.57	14.35	58.72	-	-	P	V
			8304.3	44.55	-29.45	74	50.32	37.09	15.45	58.31	-	-	P	V
														V
	Remark	<ol style="list-style-type: none"> No other spurious found. All results are PASS against Peak and Average limit line. Non restricted band limit is radio frequency level down 20db. The emission position marked as "-" means no suspected emission found with sufficient margin against limit line or noise floor only. 												



UHF RFID	Note	Frequency (MHz)	Level (dBμV/m)	Margin (dB)	Limit Line (dBμV/m)	Read Level (dBμV)	Antenna Factor (dB/m)	Path Loss (dB)	Preamp Factor (dB)	Ant Pos (cm)	Table Pos (deg)	Peak Avg. (P/A)	Pol. (H/V)	
RFID 927.7MHz		2783.1	46.58	-7.42	54	44.13	28.57	8	34.12	107	110	P	H	
		2783.1	51.71	-22.29	74	49.26	28.57	8	34.12	107	110	A	H	
		3710.8	44.54	-9.46	54	62.38	29.96	10.87	58.67	113	244	P	H	
		3710.8	44.73	-29.27	74	62.57	29.96	10.87	58.67	113	244	A	H	
		4638.5	41.96	-32.04	74	55.36	32.05	12.37	57.82	-	-	P	H	
		7421.6	42.8	-31.2	74	50.66	36.46	14.39	58.71	-	-	P	H	
		8349.3	44.36	-29.64	74	50.15	37	15.49	58.28	-	-	P	H	
														H
			2783.1	46.55	-7.45	54	44.1	28.57	8	34.12	100	239	P	V
			2783.1	50.73	-23.27	74	48.28	28.57	8	34.12	100	239	A	V
			3710.8	38.29	-15.71	54	56.13	29.96	10.87	58.67	105	231	P	V
			3710.8	42.4	-31.6	74	60.24	29.96	10.87	58.67	105	231	A	V
			4638.5	40.86	-33.14	74	54.26	32.05	12.37	57.82	-	-	P	V
			7421.6	43.05	-30.95	74	50.91	36.46	14.39	58.71	-	-	P	V
			8349.3	44.11	-29.89	74	49.9	37	15.49	58.28	-	-	P	V
														V
Remark	<ol style="list-style-type: none"> No other spurious found. All results are PASS against Peak and Average limit line. Non restricted band limit is radio frequency level down 20db. The emission position marked as "-" means no suspected emission found with sufficient margin against limit line or noise floor only. 													



<External Antenna>

UHF RFID

UHF RFID (Band Edge @ 3m)

UHF RFID	Note	Frequency	Level	Margin	Limit Line	Read Level	Antenna Factor	Path Loss	Preamp Factor	Ant Pos	Table Pos	Peak Avg.	Pol.	
		(MHz)	(dBμV/m)	(dB)	(dBμV/m)	(dBμV)	(dB/m)	(dB)	(dB)	(cm)	(deg)	(P/A)	(H/V)	
RFID 927.7MHz		30	33.65	-6.35	40	31.16	23.92	10.72	32.15	-	-	P	H	
		178.23	30.68	-12.82	43.5	35.94	14.83	11.97	32.06	-	-	P	H	
		262.74	30.2	-15.8	46	30.2	19.61	12.41	32.02	-	-	P	H	
		449.8	34.26	-11.74	46	30.07	22.94	13.1	31.85	-	-	P	H	
		559.7	37.4	-8.6	46	29.98	25.85	13.54	31.97	-	-	P	H	
		630.4	38.21	-7.79	46	30.45	26.04	13.75	32.03	-	-	P	H	
	*	927.7	119.35	-	-	106.77	29.12	14.46	31	100	309	P	H	
													P	H
			30.81	33.87	-6.13	40	31.73	23.56	10.74	32.16	-	-	P	V
			118.02	27.7	-15.8	43.5	31.1	17.15	11.61	32.16	-	-	P	V
			288.66	29.62	-16.38	46	30.26	18.87	12.5	32.01	-	-	P	V
			418.3	33.95	-12.05	46	30.49	22.48	12.98	32	-	-	P	V
			559.7	38	-8	46	30.58	25.85	13.54	31.97	-	-	P	V
			627.6	37.63	-8.37	46	29.96	25.97	13.74	32.04	-	-	P	V
	*		927.7	108.51	-	-	95.93	29.12	14.46	31	106	267	P	V
												P	V	
Remark	<ol style="list-style-type: none"> No other spurious found. All results are PASS against Peak and Average limit line. Non restricted band limit is radio frequency level down 20db. The emission position marked as "-" means no suspected emission found and emission level has at least 6dB margin against limit or emission is noise floor only. 													



UHF RFID

UHF RFID (Harmonic @ 3m)

UHF RFID	Note	Frequency	Level	Margin	Limit	Read	Antenna	Path	Preamp	Ant	Table	Peak	Pol.	
		(MHz)	(dBµV/m)	(dB)	(dBµV/m)	(dBµV)	(dB/m)	(dB)	(dB)	(cm)	(deg)	(P/A)	(H/V)	
RFID 927.7MHz		1855.4	43.34	-30.66	74	45.48	25.53	6.29	34.49	-	-	P	H	
		2783.1	44.23	-29.77	74	41.78	28.57	7.64	34.12	-	-	A	H	
		3710.8	43.4	-10.6	54	61.24	29.96	10.02	58.67	100	110	P	H	
		3710.8	45.19	-28.81	74	63.03	29.96	10.02	58.67	100	110	A	H	
		4638.5	43.77	-30.23	74	57.17	32.05	11.78	57.82	-	-	P	H	
		7421.6	44.62	-29.38	74	52.48	36.46	13.91	58.71	-	-	P	H	
		8349.3	45.29	-28.71	74	51.08	37	15.09	58.28	-	-	P	H	
													P	H
			1855.4	42.62	-31.38	74	44.76	25.53	6.29	34.49	-	-	P	V
			2783.1	45.2	-28.8	74	42.75	28.57	7.64	34.12	-	-	A	V
			3710.8	41.92	-12.08	54	59.76	29.96	10.02	58.67	300	297	P	V
			3710.8	45	-29	74	62.84	29.96	10.02	58.67	300	297	A	V
			4638.5	43.21	-30.79	74	56.61	32.05	11.78	57.82	-	-	P	V
			7421.6	43.69	-30.31	74	51.55	36.46	13.91	58.71	-	-	P	V
			8349.3	46.94	-27.06	74	52.73	37	15.09	58.28	-	-	P	V
													P	V
Remark	<ol style="list-style-type: none"> No other spurious found. All results are PASS against Peak and Average limit line. Non restricted band limit is radio frequency level down 20db. The emission position marked as "-" means no suspected emission found with sufficient margin against limit line or noise floor only. 													



Note symbol

*	Fundamental Frequency which can be ignored. However, the level of any unwanted emissions shall not exceed the level of the fundamental frequency.
!	Test result is over limit line.
P/A	Peak or Average
H/V	Horizontal or Vertical



A calculation example for radiated spurious emission is shown as below:

UHF RFID	Note	Frequency	Level	Margin	Limit	Read	Antenna	Path	Preamp	Ant	Table	Peak	Pol.
		(MHz)	(dBμV/m)	(dB)	(dBμV/m)	(dBμV)	(dB/m)	(dB)	(dB)	(cm)	(deg)	(P/A)	(H/V)
UHF RFID 913.25MHz		2739.75	38.54	-35.46	74	55.12	32.46	9.82	58.86	103	308	P	H

1. Path Loss(dB) = Cable loss(dB) + Filter loss(dB) + Attenuator loss(dB)
2. Level(dBμV/m) =
Antenna Factor(dB/m) + Path Loss(dB) + Read Level(dBμV) - Preamp Factor(dB)
3. Margin(dB) = Level(dBμV/m) – Limit Line(dBμV/m)

For Peak Limit @ 2739.75MHz:

1. Level(dBμV/m)
= Antenna Factor(dB/m) + Path Loss(dB) + Read Level(dBμV) - Preamp Factor(dB)
= 32.46(dB/m) + 9.82(dB) + 55.12(dBμV) – 58.86 (dB)
= 38.54 (dBμV/m)
2. Margin(dB)
= Level(dBμV/m) – Limit Line(dBμV/m)
= 38.54(dBμV/m) – 74(dBμV/m)
= -35.46(dB)

Peak measured complies with the limit line, so test result is “PASS”.



Appendix C. Radiated Spurious Emission Plots

Test Engineer :	Yuan Lee and Bank Lin	Temperature :	20.2~20.7°C
		Relative Humidity :	65.1~65.9%



<Internal Antenna>

RFID (Band Edge @ 3m)

RFID	RFID	
	RFID 917.9MHz	
	Horizontal	Vertical
Peak Avg.	<p>Site : 03CH11-HY Condition : QP 3m 2_BTL06_35414_221008 HORIZONTAL</p>	<p>Site : 03CH11-HY Condition : QP 3m 2_BTL06_35414_221008 VERTICAL</p>



RFID	RFID	
	RFID 922.7MHz	
	Horizontal	Vertical
Peak Avg.	<p>Horizontal spectrum plot showing Level (dBuV/m) vs Frequency (MHz). The plot includes a peak at 922.7 MHz. The date is 2023-04-12. The site is 03CH11-HY and the condition is QP 3m 2_B1LOG_35414_221008 HORIZONTAL.</p>	<p>Vertical spectrum plot showing Level (dBuV/m) vs Frequency (MHz). The plot includes a peak at 922.7 MHz. The date is 2023-04-12. The site is 03CH11-HY and the condition is QP 3m 2_B1LOG_35414_221008 VERTICAL.</p>



RFID	RFID	
	RFID 927.7MHz	
	Horizontal	Vertical
Peak Avg.	<p>Horizontal spectrum plot showing Level (dBuV/m) vs Frequency (MHz). The plot displays a baseline level around 30-40 dBuV/m with a prominent peak at 927.7 MHz. The peak is labeled 'QP'. The date is 2023-04-12. The site is 03CH11-HY and the condition is QP 3m 2_B1LOG_35414_221008 HORIZONTAL.</p>	<p>Vertical spectrum plot showing Level (dBuV/m) vs Frequency (MHz). The plot displays a baseline level around 30-40 dBuV/m with a prominent peak at 927.7 MHz. The peak is labeled 'QP'. The date is 2023-04-12. The site is 03CH11-HY and the condition is QP 3m 2_B1LOG_35414_221008 VERTICAL.</p>



RFID (Harmonic @ 3m)

RFID	RFID	
	RFID 917.9MHz	
	Horizontal	Vertical
Peak Avg.	<p>Site : 03CH11-HY Condition : PEAK_74 3m 91200_01620_220824 HORIZONTAL</p>	<p>Site : 03CH11-HY Condition : PEAK_74 3m 91200_01620_220824 VERTICAL</p>

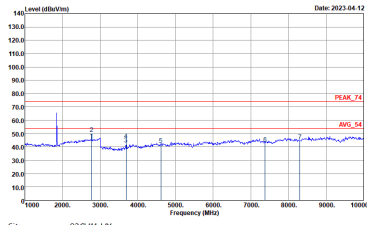
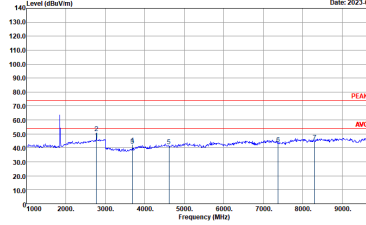

RFID	RFID	
	RFID 922.7MHz	
	Horizontal	Vertical
<p>Peak Avg.</p>	 <p>Site : 03CH11-HY Condition : PEAK_74 3m 9120D_01620_220824 HORIZONTAL : .</p>	 <p>Site : 03CH11-HY Condition : PEAK_74 3m 9120D_01620_220824 VERTICAL : .</p>



RFID	RFID	
	RFID 927.7MHz	
	Horizontal	Vertical
Peak Avg.	<p>Horizontal graph showing Level (dBuV/m) vs Frequency (MHz). The y-axis ranges from 10.0 to 140.0 dBuV/m, and the x-axis ranges from 50 to 1000 MHz. A prominent peak is observed at 927.7 MHz, reaching approximately 130 dBuV/m. The baseline level is around 30-40 dBuV/m. The graph is dated 2023-04-12. Site: 03CH11-HY, Condition: QP 3m 2_B1LOG_35414_221008 HORIZONTAL.</p>	<p>Vertical graph showing Level (dBuV/m) vs Frequency (MHz). The y-axis ranges from 10.0 to 140.0 dBuV/m, and the x-axis ranges from 50 to 1000 MHz. A prominent peak is observed at 927.7 MHz, reaching approximately 130 dBuV/m. The baseline level is around 30-40 dBuV/m. The graph is dated 2023-04-12. Site: 03CH11-HY, Condition: QP 3m 2_B1LOG_35414_221008 VERTICAL.</p>



<External Antenna>

RFID (Band Edge @ 3m)

RFID	RFID	
	RFID 927.7MHz	
	Horizontal	Vertical
Peak Avg.	<p>Site : 03CH11-HY Condition : QP 3m 2_BTL06_35414_221008 HORIZONTAL</p>	<p>Site : 03CH11-HY Condition : QP 3m 2_BTL06_35414_221008 VERTICAL</p>

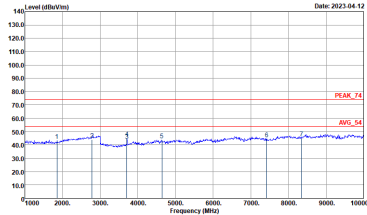
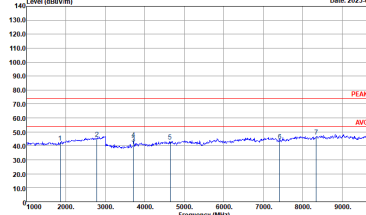

RFID (Harmonic @ 3m)

RFID	RFID	
	RFID 927.7MHz	
	Horizontal	Vertical
<p>Peak Avg.</p>	 <p>Site : 03CH11-HY Condition : PEAK_74 3m 91200_01620_220824 HORIZONTAL</p>	 <p>Site : 03CH11-HY Condition : PEAK_74 3m 91200_01620_220824 VERTICAL</p>



Appendix D. Duty Cycle Plots

<Internal Antenna>

Band	Duty Cycle(%)	T(us)	1/T(kHz)	VBW Setting
UHF RFID	87.47	49200	0.02	30Hz

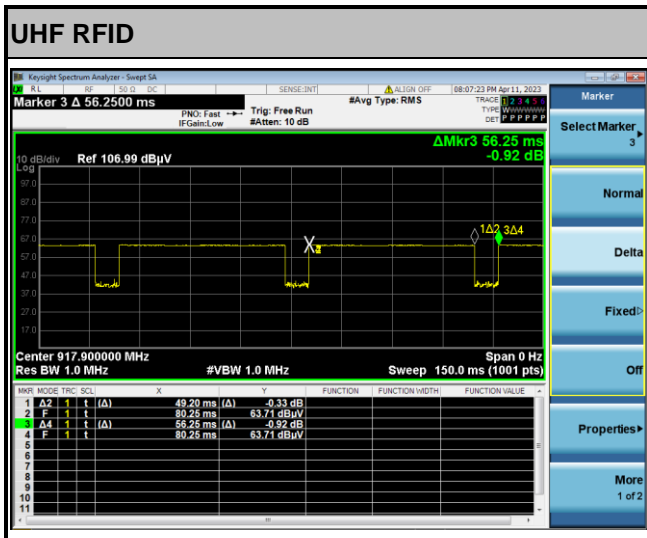

<External Antenna>

Band	Duty Cycle(%)	T(us)	1/T(kHz)	VBW Setting
UHF RFID	87.20	49050	0.02	30Hz

