

FCC SAR Test Report

APPLICANT : Zebra Technologies Corporation
EQUIPMENT : Touch computer
BRAND NAME : Zebra
MODEL NAME : TC75EK
FCC ID : UZ7TC75EK
STANDARD : FCC 47 CFR Part 2 (2.1093)
ANSI/IEEE C95.1-1992
IEEE 1528-2013

We, SPORTON INTERNATIONAL INC., would like to declare that the tested sample has been evaluated in accordance with the procedures and had been in compliance with the applicable technical standards.

The test results in this report apply exclusively to the tested model / sample. Without written approval of SPORTON INTERNATIONAL INC., the test report shall not be reproduced except in full.

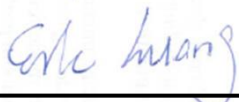

Reviewed by: Eric Huang / Deputy Manager



Approved by: Jones Tsai / Manager



SPORTON INTERNATIONAL INC.

No.52, Hwa Ya 1st Rd., Hwa Ya Technology Park, Kwei-Shan District, Taoyuan City, Taiwan (R.O.C.)



Table of Contents

1. Statement of Compliance 4
2. Administration Data 5
3. Guidance Applied..... 5
4. Equipment Under Test (EUT) Information..... 6
4.1 General Information 6
4.2 General LTE SAR Test and Reporting Considerations 8
5. RF Exposure Limits.....10
5.1 Uncontrolled Environment.....10
5.2 Controlled Environment.....10
6. Specific Absorption Rate (SAR).....11
6.1 Introduction 11
6.2 SAR Definition..... 11
7. System Description and Setup12
7.1 E-Field Probe13
7.2 Data Acquisition Electronics (DAE)13
7.3 Phantom.....14
7.4 Device Holder.....15
8. Measurement Procedures16
8.1 Spatial Peak SAR Evaluation16
8.2 Power Reference Measurement.....17
8.3 Area Scan17
8.4 Zoom Scan.....18
8.5 Volume Scan Procedures.....18
8.6 Power Drift Monitoring.....18
9. Test Equipment List19
10. System Verification20
10.1 Tissue Simulating Liquids.....20
10.2 Tissue Verification21
10.3 System Performance Check Results.....22
11. RF Exposure Positions23
11.1 Ear and handset reference point23
11.2 Definition of the cheek position.....24
11.3 Definition of the tilt position.....25
11.4 Body Worn Accessory26
11.5 Wireless Router.....26
12. Conducted RF Output Power (Unit: dBm).....27
13. Bluetooth Exclusions Applied68
14. Antenna Location69
15. SAR Test Results70
15.1 Head SAR72
15.2 Hotspot SAR75
15.3 Body Worn Accessory SAR.....79
15.4 Repeated SAR Measurement83
16. Simultaneous Transmission Analysis.....84
16.1 Head Exposure Conditions85
16.2 Hotspot Exposure Conditions.....86
16.3 Body-Worn Accessory Exposure Conditions88
16.4 SPLSR Evaluation and Analysis.....90
17. Uncertainty Assessment94
18. References97
Appendix A. Plots of System Performance Check
Appendix B. Plots of High SAR Measurement
Appendix C. DASYS Calibration Certificate
Appendix D. Test Setup Photos



1. Statement of Compliance

The maximum results of Specific Absorption Rate (SAR) found during testing for **Zebra Technologies Corporation, Touch computer, TC75EK**, are as follows.

Equipment Class	Frequency Band	Highest SAR Summary			Highest Simultaneous Transmission 1g SAR (W/kg)
		Head (Separation 0mm)	Body-worn (Separation 15mm)	Hotspot (Separation 10mm)	
		1g SAR (W/kg)			
Licensed	GSM850	0.85	1.11	1.14	1.59
	GSM1900	0.24	1.28	1.30	
	WCDMA II	0.25	1.22	1.16	
	WCDMA IV	0.26	1.24	1.07	
	WCDMA V	0.44	0.48	0.66	
	CDMA BC0	0.45	0.59	0.65	
	CDMA BC1	0.22	1.00	1.14	
	CDMA BC10	0.37	0.47	0.53	
	LTE Band 4	0.21	0.91	1.19	
	LTE Band 12 / 17	0.28	0.36	0.46	
	LTE Band 13	0.28	0.34	0.48	
	LTE Band 2 / 25	0.26	1.09	1.09	
	LTE Band 5 / 26	0.32	0.44	0.47	
DTS	2.4GHz WLAN	0.31	0.15	0.33	1.54
NII	5GHz WLAN	0.12	0.37	0.55	1.59
DSS	Bluetooth		< 0.01		1.58
Date of Testing:		2016/9/5 ~ 2016/9/13			
Remark : 1. LTE band 2 / 5 / 17 SAR test was covered by Band 25 / 26 / 12 ; according to April 2015 TCB workshop, SAR test for overlapping LTE bands can be reduced if, a. the maximum output power, including tolerance, for the smaller band is ≤ the larger band to qualify for the SAR test exclusion b. the channel bandwidth and other operating parameters for the smaller band are fully supported by the larger band					

This device is in compliance with Specific Absorption Rate (SAR) for general population/uncontrolled exposure limits (1.6 W/kg) specified in FCC 47 CFR part 2 (2.1093) and ANSI/IEEE C95.1-1992, and had been tested in accordance with the measurement methods and procedures specified in IEEE 1528-2013 and FCC KDB publications



2. Administration Data

Testing Laboratory	
Test Site	SPORTON INTERNATIONAL INC.
Test Site Location	No.52, Hwa Ya 1st Rd., Hwa Ya Technology Park, Kwei-Shan District, Taoyuan City, Taiwan (R.O.C.) TEL: +886-3-327-3456 FAX: +886-3-328-4978

Applicant	
Company Name	Zebra Technologies Corporation
Address	1 Zebra Plaza Holtsville, NY 11742

Manufacturer	
Company Name	Wistron Corporation
Address	21F, No. 88, Sec. 1, Hsin Tai Wu Rd., Hsichih Dist, New Taipei City 221, Taiwan R.O.C.

3. Guidance Applied

The Specific Absorption Rate (SAR) testing specification, method, and procedure for this device is in accordance with the following standards:

- FCC 47 CFR Part 2 (2.1093)
- ANSI/IEEE C95.1-1992
- IEEE 1528-2013
- FCC KDB 865664 D01 SAR Measurement 100 MHz to 6 GHz v01r04
- FCC KDB 865664 D02 SAR Reporting v01r02
- FCC KDB 447498 D01 General RF Exposure Guidance v06
- FCC KDB 648474 D04 SAR Evaluation Considerations for Wireless Handsets v01r03
- FCC KDB 248227 D01 802.11 Wi-Fi SAR v02r02
- FCC KDB 941225 D01 3G SAR Procedures v03r01
- FCC KDB 941225 D05 SAR for LTE Devices v02r05
- FCC KDB 941225 D06 Hotspot Mode SAR v02r01



4. Equipment Under Test (EUT) Information

4.1 General Information

Product Feature & Specification	
Equipment Name	Touch computer
Brand Name	Zebra
Model Name	TC75EK
FCC ID	UZ7TC75EK
IMEI Code	359111070013885
Wireless Technology and Frequency Range	GSM850: 824.2 MHz ~ 848.8 MHz GSM1900: 1850.2 MHz ~ 1909.8 MHz WCDMA Band II: 1852.4 MHz ~ 1907.6 MHz WCDMA Band IV: 1712.4 MHz ~ 1752.6 MHz WCDMA Band V: 826.4 MHz ~ 846.6 MHz CDMA2000 BC0: 824.7 MHz ~ 848.31 MHz CDMA 2000 BC1: 1851.25 MHz ~ 1908.75 MHz CDMA 2000 BC10: 817.9 MHz ~ 823.1 MHz LTE Band 2: 1850 MHz ~ 1910 MHz LTE Band 4: 1710 MHz ~ 1755 MHz LTE Band 5: 824 MHz ~ 849 MHz LTE Band 12: 699 MHz ~ 716 MHz LTE Band 13: 777 MHz ~ 787 MHz LTE Band 17: 704 MHz ~ 716 MHz LTE Band 25: 1850 MHz ~ 1915 MHz LTE Band 26: 814 MHz ~ 849 MHz WLAN 2.4GHz Band: 2412 MHz ~ 2462 MHz WLAN 5.2GHz Band: 5180 MHz ~ 5240 MHz WLAN 5.3GHz Band: 5260 MHz ~ 5320 MHz WLAN 5.5GHz Band: 5500 MHz ~ 5720 MHz WLAN 5.8GHz Band: 5745 MHz ~ 5825 MHz Bluetooth: 2402 MHz ~ 2480 MHz NFC : 13.56 MHz
Mode	<ul style="list-style-type: none"> · GSM/GPRS/EGPRS · RMC/AMR 12.2Kbps · HSDPA · HSUPA · DC-HSDPA · CDMA2000 : 1xRTT/1xEv-Do(Rev.0)/1xEv-Do(Rev.A) · LTE: QPSK, 16QAM · 802.11a/b/g/n/ac HT20/HT40/VHT20/VHT40/VHT80 · Bluetooth BR/EDR/LE · NFC:ASK
HW Version	DV
SW Version	Android version 6.0.1
FW Version	91-10-01-MG-00
MFD	14JUL16
GSM / (E)GPRS Transfer mode	Class B – EUT cannot support Packet Switched and Circuit Switched Network simultaneously but can automatically switch between Packet and Circuit Switched Network.
EUT Stage	Engineering sample
Remark: 1. This device WLAN 2.4GHz / 5.2GHz (U-NII-1) / 5.8GHz (U-NII-3) supports Hotspot operation. 2. When hotspot mode is enabled, power reduction will be activated to limit the maximum power of GSM1900, WCDMA B2 / B4, CDMA BC1 and LTE B2 / B4 / B25.	



Specification of Accessories				
AC Adapter	Brand Name	Zebra	Part Number	PWR-BUA5V16W0WW
Snap-On USB/Charge Cable	Brand Name	Symbol	Part Number	CBL-TC7X-USB1-01
Snap-On Charging Cable Cup	Brand Name	Symbol	Part Number	CHG-TC7X-CBL1-01
Battery	Brand Name	Zebra	Part Number	BT-000318-01
Earphone 1	Brand Name	Zebra	Part Number	HDST-35MM-PTVP-01
Earphone 2	Brand Name	Zebra	Part Number	HS2100-OTH
Earphone 3	Brand Name	Zebra	Part Number	HS3100-OTH
Snap-on 3.5MM Audio Nugget	Brand Name	Symbol	Part Number	ADP-TC7X-AUD35-01
3.5mm Jack 43"(1.1m) Standard Cable	Brand Name	Zebra	Part Number	CBL-HS2100-3MS1-01
Soft Holster	Brand Name	Zebra	Part Number	SG-TC7X-HLSTR1-01
Rigid Holster	Brand Name	Zebra	Part Number	SG-TC7X-RHLSTR1-01
Power Cord	Brand Name	LOROM	Part Number	50-16000-182R
Cable line	Brand Name	Zebra	Part Number	CBL-DC-383A1-01

Note:

Earphone 3 is a wireless Bluetooth Earphone, and it would not attach to the handset, therefore it is not necessary to evaluate body worn accessories SAR testing.



4.2 General LTE SAR Test and Reporting Considerations

Summarized necessary items addressed in KDB 941225 D05 v02r05																																							
FCC ID	UZ7TC75EK																																						
Equipment Name	Touch computer																																						
Operating Frequency Range of each LTE transmission band	LTE Band 02: 1850 MHz ~ 1910 MHz LTE Band 04: 1710 MHz ~ 1755 MHz LTE Band 05: 824 MHz ~ 849 MHz LTE Band 12: 699 MHz ~ 716 MHz LTE Band 13: 777 MHz ~ 787 MHz LTE Band 17: 704 MHz ~ 716 MHz LTE Band 25: 1850 MHz ~ 1915 MHz LTE Band 26: 814 MHz ~ 849 MHz																																						
Channel Bandwidth	LTE Band 02: 1.4MHz, 3MHz, 5MHz, 10MHz, 15MHz, 20MHz LTE Band 04: 1.4MHz, 3MHz, 5MHz, 10MHz, 15MHz, 20MHz LTE Band 05: 1.4MHz, 3MHz, 5MHz, 10MHz LTE Band 12: 1.4MHz, 3MHz, 5MHz, 10MHz LTE Band 13: 5MHz, 10MHz LTE Band 17: 5MHz, 10MHz LTE Band 25: 1.4MHz, 3MHz, 5MHz, 10MHz, 15MHz, 20MHz LTE Band 26: 1.4MHz, 3MHz, 5MHz, 10MHz, 15MHz																																						
uplink modulations used	QPSK, and 16QAM																																						
LTE Voice / Data requirements	Voice and Data																																						
LTE MPR permanently built-in by design	<p align="center">Table 6.2.3-1: Maximum Power Reduction (MPR) for Power Class 3</p> <table border="1"> <thead> <tr> <th rowspan="2">Modulation</th> <th colspan="6">Channel bandwidth / Transmission bandwidth (RB)</th> <th rowspan="2">MPR (dB)</th> </tr> <tr> <th>1.4 MHz</th> <th>3.0 MHz</th> <th>5 MHz</th> <th>10 MHz</th> <th>15 MHz</th> <th>20 MHz</th> </tr> </thead> <tbody> <tr> <td>QPSK</td> <td>>5</td> <td>>4</td> <td>>8</td> <td>>12</td> <td>>16</td> <td>>18</td> <td>≤ 1</td> </tr> <tr> <td>16 QAM</td> <td>≤ 5</td> <td>≤ 4</td> <td>≤ 8</td> <td>≤ 12</td> <td>≤ 16</td> <td>≤ 18</td> <td>≤ 1</td> </tr> <tr> <td>16 QAM</td> <td>>5</td> <td>>4</td> <td>>8</td> <td>>12</td> <td>>16</td> <td>>18</td> <td>≤ 2</td> </tr> </tbody> </table>	Modulation	Channel bandwidth / Transmission bandwidth (RB)						MPR (dB)	1.4 MHz	3.0 MHz	5 MHz	10 MHz	15 MHz	20 MHz	QPSK	>5	>4	>8	>12	>16	>18	≤ 1	16 QAM	≤ 5	≤ 4	≤ 8	≤ 12	≤ 16	≤ 18	≤ 1	16 QAM	>5	>4	>8	>12	>16	>18	≤ 2
Modulation	Channel bandwidth / Transmission bandwidth (RB)						MPR (dB)																																
	1.4 MHz	3.0 MHz	5 MHz	10 MHz	15 MHz	20 MHz																																	
QPSK	>5	>4	>8	>12	>16	>18	≤ 1																																
16 QAM	≤ 5	≤ 4	≤ 8	≤ 12	≤ 16	≤ 18	≤ 1																																
16 QAM	>5	>4	>8	>12	>16	>18	≤ 2																																
LTE A-MPR	In the base station simulator configuration, Network Setting value is set to NS_01 to disable A-MPR during SAR testing and the LTE SAR tests was transmitting on all TTI frames (Maximum TTI)																																						
Spectrum plots for RB configuration	A properly configured base station simulator was used for the SAR and power measurement; therefore, spectrum plots for each RB allocation and offset configuration are not included in the SAR report.																																						
Power reduction applied to satisfy SAR compliance	1. Yes, when operating in hotspot mode that LTE B2 / B4 / B25 power reduction applied to satisfy SAR compliance.																																						



Transmission (H, M, L) channel numbers and frequencies in each LTE band												
LTE Band 2												
	Bandwidth 1.4 MHz		Bandwidth 3 MHz		Bandwidth 5 MHz		Bandwidth 10 MHz		Bandwidth 15 MHz		Bandwidth 20 MHz	
	Ch. #	Freq. (MHz)	Ch. #	Freq. (MHz)	Ch. #	Freq. (MHz)	Ch. #	Freq. (MHz)	Ch. #	Freq. (MHz)	Ch. #	Freq. (MHz)
L	18607	1850.7	18615	1851.5	18625	1852.5	18650	1855	18675	1857.5	18700	1860
M	18900	1880	18900	1880	18900	1880	18900	1880	18900	1880	18900	1880
H	19193	1909.3	19185	1908.5	19175	1907.5	19150	1905	19125	1902.5	19100	1900
LTE Band 4												
	Bandwidth 1.4 MHz		Bandwidth 3 MHz		Bandwidth 5 MHz		Bandwidth 10 MHz		Bandwidth 15 MHz		Bandwidth 20 MHz	
	Ch. #	Freq. (MHz)	Ch. #	Freq. (MHz)	Ch. #	Freq. (MHz)	Ch. #	Freq. (MHz)	Ch. #	Freq. (MHz)	Ch. #	Freq. (MHz)
L	19957	1710.7	19965	1711.5	19975	1712.5	20000	1715	20025	1717.5	20050	1720
M	20175	1732.5	20175	1732.5	20175	1732.5	20175	1732.5	20175	1732.5	20175	1732.5
H	20393	1754.3	20385	1753.5	20375	1752.5	20350	1750	20325	1747.5	20300	1745
LTE Band 5												
	Bandwidth 1.4 MHz		Bandwidth 3 MHz		Bandwidth 5 MHz		Bandwidth 10 MHz					
	Ch. #	Freq. (MHz)	Ch. #	Freq. (MHz)	Ch. #	Freq. (MHz)	Ch. #	Freq. (MHz)	Ch. #	Freq. (MHz)	Ch. #	Freq. (MHz)
L	20407	824.7	20415	825.5	20425	826.5	20450	829				
M	20525	836.5	20525	836.5	20525	836.5	20525	836.5				
H	20643	848.3	20635	847.5	20625	846.5	20600	844				
LTE Band 12												
	Bandwidth 1.4 MHz		Bandwidth 3 MHz		Bandwidth 5 MHz		Bandwidth 10 MHz					
	Ch. #	Freq. (MHz)	Ch. #	Freq. (MHz)	Ch. #	Freq. (MHz)	Ch. #	Freq. (MHz)	Ch. #	Freq. (MHz)	Ch. #	Freq. (MHz)
L	23017	699.7	23025	700.5	23035	701.5	23060	704				
M	23095	707.5	23095	707.5	23095	707.5	23095	707.5				
H	23173	715.3	23165	714.5	23155	713.5	23130	711				
LTE Band 13												
	Bandwidth 5 MHz				Bandwidth 10 MHz							
	Channel #		Freq.(MHz)		Channel #		Freq.(MHz)		Channel #		Freq.(MHz)	
L	23205		779.5		23230		782					
M	23230		782									
H	23255		784.5									
LTE Band 17												
	Bandwidth 5 MHz				Bandwidth 10 MHz							
	Channel #		Freq.(MHz)		Channel #		Freq. (MHz)		Channel #		Freq. (MHz)	
L	23755		706.5		23780		709					
M	23790		710		23790		710					
H	23825		713.5		23800		711					
LTE Band 25												
	Bandwidth 1.4 MHz		Bandwidth 3 MHz		Bandwidth 5 MHz		Bandwidth 10 MHz		Bandwidth 15 MHz		Bandwidth 20 MHz	
	Ch. #	Freq. (MHz)	Ch. #	Freq. (MHz)	Ch. #	Freq. (MHz)	Ch. #	Freq. (MHz)	Ch. #	Freq. (MHz)	Ch. #	Freq. (MHz)
L	26047	1850.7	26055	1851.5	26065	1852.5	26090	1855	26115	1857.5	26140	1860
M	26340	1880	26340	1880	26340	1880	26340	1880	26340	1880	26340	1880
H	26683	1914.3	26675	1913.5	26665	1912.5	26640	1910	26615	1907.5	26590	1905
LTE Band 26												
	Bandwidth 1.4 MHz		Bandwidth 3 MHz		Bandwidth 5 MHz		Bandwidth 10 MHz		Bandwidth 15 MHz			
	Ch. #	Freq. (MHz)	Ch. #	Freq. (MHz)	Ch. #	Freq. (MHz)	Ch. #	Freq. (MHz)	Ch. #	Freq. (MHz)	Ch. #	Freq. (MHz)
L	26697	814.7	26705	815.5	26715	816.5	26740	819	26765	821.5		
M	26865	831.5	26865	831.5	26865	831.5	26865	831.5	26865	831.5		
H	27033	848.3	27025	847.5	27015	846.5	26990	844	26965	841.5		



5. RF Exposure Limits

5.1 Uncontrolled Environment

Uncontrolled Environments are defined as locations where there is the exposure of individuals who have no knowledge or control of their exposure. The general population/uncontrolled exposure limits are applicable to situations in which the general public may be exposed or in which persons who are exposed as a consequence of their employment may not be made fully aware of the potential for exposure or cannot exercise control over their exposure. Members of the general public would come under this category when exposure is not employment-related; for example, in the case of a wireless transmitter that exposes persons in its vicinity.

5.2 Controlled Environment

Controlled Environments are defined as locations where there is exposure that may be incurred by persons who are aware of the potential for exposure, (i.e. as a result of employment or occupation). In general, occupational/controlled exposure limits are applicable to situations in which persons are exposed as a consequence of their employment, who have been made fully aware of the potential for exposure and can exercise control over their exposure. The exposure category is also applicable when the exposure is of a transient nature due to incidental passage through a location where the exposure levels may be higher than the general population/uncontrolled limits, but the exposed person is fully aware of the potential for exposure and can exercise control over his or her exposure by leaving the area or by some other appropriate means.

Limits for Occupational/Controlled Exposure (W/kg)

Whole-Body	Partial-Body	Hands, Wrists, Feet and Ankles
0.4	8.0	20.0

Limits for General Population/Uncontrolled Exposure (W/kg)

Whole-Body	Partial-Body	Hands, Wrists, Feet and Ankles
0.08	1.6	4.0

1. Whole-Body SAR is averaged over the entire body, partial-body SAR is averaged over any 1gram of tissue defined as a tissue volume in the shape of a cube. SAR for hands, wrists, feet and ankles is averaged over any 10 grams of tissue defined as a tissue volume in the shape of a cube.

6. Specific Absorption Rate (SAR)

6.1 Introduction

SAR is related to the rate at which energy is absorbed per unit mass in an object exposed to a radio field. The SAR distribution in a biological body is complicated and is usually carried out by experimental techniques or numerical modeling. The standard recommends limits for two tiers of groups, occupational/controlled and general population/uncontrolled, based on a person's awareness and ability to exercise control over his or her exposure. In general, occupational/controlled exposure limits are higher than the limits for general population/uncontrolled.

6.2 SAR Definition

The SAR definition is the time derivative (rate) of the incremental energy (dW) absorbed by (dissipated in) an incremental mass (dm) contained in a volume element (dv) of a given density (ρ). The equation description is as below:

$$\text{SAR} = \frac{d}{dt} \left(\frac{dW}{dm} \right) = \frac{d}{dt} \left(\frac{dW}{\rho dv} \right)$$

SAR is expressed in units of Watts per kilogram (W/kg)

$$\text{SAR} = \frac{\sigma |E|^2}{\rho}$$

Where: σ is the conductivity of the tissue, ρ is the mass density of the tissue and E is the RMS electrical field strength.

7. System Description and Setup

The DASY system used for performing compliance tests consists of the following items:

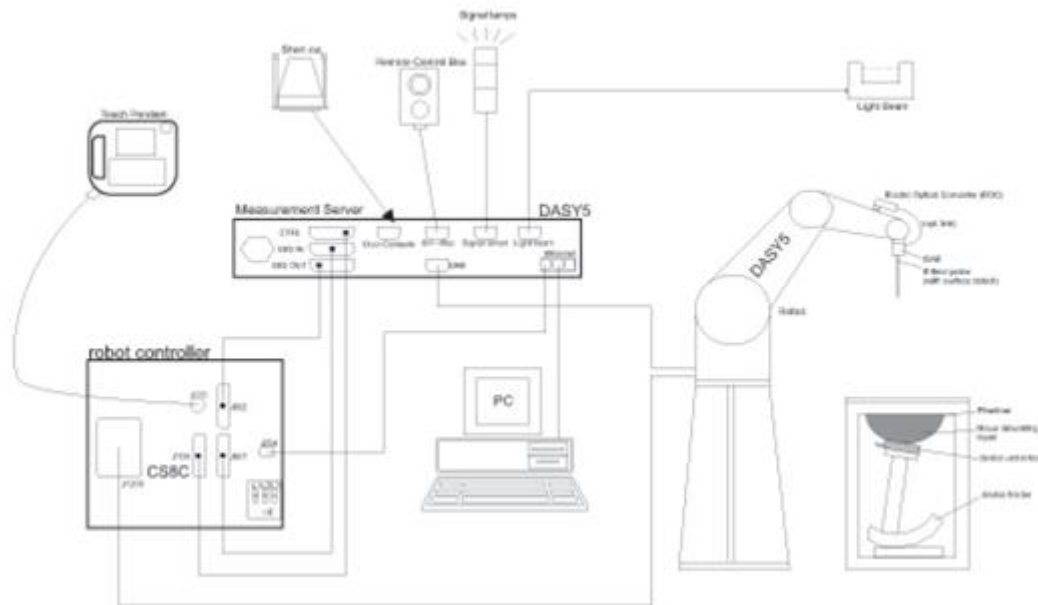

- A standard high precision 6-axis robot with controller, teach pendant and software. An arm extension for accommodating the data acquisition electronics (DAE).
- An isotropic Field probe optimized and calibrated for the targeted measurement.
- A data acquisition electronics (DAE) which performs the signal amplification, signal multiplexing, AD-conversion, offset measurements, mechanical surface detection, collision detection, etc. The unit is battery powered with standard or rechargeable batteries. The signal is optically transmitted to the EOC.
- The Electro-optical converter (EOC) performs the conversion from optical to electrical signals for the digital communication to the DAE. To use optical surface detection, a special version of the EOC is required. The EOC signal is transmitted to the measurement server.
- The function of the measurement server is to perform the time critical tasks such as signal filtering, control of the robot operation and fast movement interrupts.
- The Light Beam used is for probe alignment. This improves the (absolute) accuracy of the probe positioning.
- A computer running WinXP or Win7 and the DASY5 software.
- Remote control and teach pendant as well as additional circuitry for robot safety such as warning lamps, etc.
- The phantom, the device holder and other accessories according to the targeted measurement.

7.1 E-Field Probe

The SAR measurement is conducted with the dosimetric probe (manufactured by SPEAG).The probe is specially designed and calibrated for use in liquid with high permittivity. The dosimetric probe has special calibration in liquid at different frequency. This probe has a built in optical surface detection system to prevent from collision with phantom.

<ES3DV3 Probe>

Construction	Symmetric design with triangular core Interleaved sensors Built-in shielding against static charges PEEK enclosure material (resistant to organic solvents, e.g., DGBE)	
Frequency	10 MHz – 4 GHz; Linearity: ± 0.2 dB (30 MHz – 4 GHz)	
Directivity	± 0.2 dB in TSL (rotation around probe axis) ± 0.3 dB in TSL (rotation normal to probe axis)	
Dynamic Range	5 μ W/g – >100 mW/g; Linearity: ± 0.2 dB	
Dimensions	Overall length: 337 mm (tip: 20 mm) Tip diameter: 3.9 mm (body: 12 mm) Distance from probe tip to dipole centers: 3.0 mm	

<EX3DV4 Probe>

Construction	Symmetric design with triangular core Built-in shielding against static charges PEEK enclosure material (resistant to organic solvents, e.g., DGBE)	
Frequency	10 MHz – >6 GHz Linearity: ± 0.2 dB (30 MHz – 6 GHz)	
Directivity	± 0.3 dB in TSL (rotation around probe axis) ± 0.5 dB in TSL (rotation normal to probe axis)	
Dynamic Range	10 μ W/g – >100 mW/g Linearity: ± 0.2 dB (noise: typically <1 μ W/g)	
Dimensions	Overall length: 337 mm (tip: 20 mm) Tip diameter: 2.5 mm (body: 12 mm) Typical distance from probe tip to dipole centers: 1 mm	

7.2 Data Acquisition Electronics (DAE)

The data acquisition electronics (DAE) consists of a highly sensitive electrometer-grade preamplifier with auto-zeroing, a channel and gain-switching multiplexer, a fast 16 bit AD-converter and a command decoder and control logic unit. Transmission to the measurement server is accomplished through an optical downlink for data and status information as well as an optical uplink for commands and the clock.

The input impedance of the DAE is 200 MOhm; the inputs are symmetrical and floating. Common mode rejection is above 80 dB.



Fig 5.1 Photo of DAE

7.3 Phantom

<SAM Twin Phantom>

Shell Thickness	2 ± 0.2 mm; Center ear point: 6 ± 0.2 mm	
Filling Volume	Approx. 25 liters	
Dimensions	Length: 1000 mm; Width: 500 mm; Height: adjustable feet	
Measurement Areas	Left Hand, Right Hand, Flat Phantom	

The bottom plate contains three pair of bolts for locking the device holder. The device holder positions are adjusted to the standard measurement positions in the three sections. A white cover is provided to tap the phantom during off-periods to prevent water evaporation and changes in the liquid parameters. On the phantom top, three reference markers are provided to identify the phantom position with respect to the robot.

<ELI Phantom>

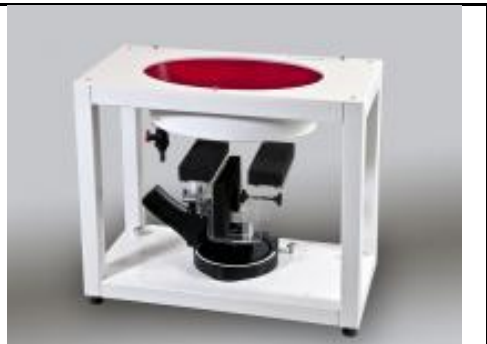
Shell Thickness	2 ± 0.2 mm (sagging: <1%)	
Filling Volume	Approx. 30 liters	
Dimensions	Major ellipse axis: 600 mm Minor axis: 400 mm	

The ELI phantom is intended for compliance testing of handheld and body-mounted wireless devices in the frequency range of 30 MHz to 6 GHz. ELI4 is fully compatible with standard and all known tissue simulating liquids.

7.4 Device Holder

<Mounting Device for Hand-Held Transmitter>

In combination with the Twin SAM V5.0/V5.0c or ELI phantoms, the Mounting Device for Hand-Held Transmitters enables rotation of the mounted transmitter device to specified spherical coordinates. At the heads, the rotation axis is at the ear opening. Transmitter devices can be easily and accurately positioned according to IEC 62209-1, IEEE 1528, FCC, or other specifications. The device holder can be locked for positioning at different phantom sections (left head, right head, flat). And upgrade kit to Mounting Device to enable easy mounting of wider devices like big smart-phones, e-books, small tablets, etc. It holds devices with width up to 140 mm.



Mounting Device for Hand-Held Transmitters



Mounting Device Adaptor for Wide-Phones

<Mounting Device for Laptops and other Body-Worn Transmitters>

The extension is lightweight and made of POM, acrylic glass and foam. It fits easily on the upper part of the mounting device in place of the phone positioned. The extension is fully compatible with the SAM Twin and ELI phantoms.



Mounting Device for Laptops

8. Measurement Procedures

The measurement procedures are as follows:

<Conducted power measurement>

- (a) For WWAN power measurement, use base station simulator to configure EUT WWAN transmission in conducted connection with RF cable, at maximum power in each supported wireless interface and frequency band.
- (b) Read the WWAN RF power level from the base station simulator.
- (c) For WLAN/BT power measurement, use engineering software to configure EUT WLAN/BT continuously transmission, at maximum RF power in each supported wireless interface and frequency band
- (d) Connect EUT RF port through RF cable to the power meter, and measure WLAN/BT output power

<SAR measurement>

- (a) Use base station simulator to configure EUT WWAN transmission in radiated connection, and engineering software to configure EUT WLAN/BT continuously transmission, at maximum RF power, in the highest power channel.
- (b) Place the EUT in the positions as Appendix D demonstrates.
- (c) Set scan area, grid size and other setting on the DASY software.
- (d) Measure SAR results for the highest power channel on each testing position.
- (e) Find out the largest SAR result on these testing positions of each band
- (f) Measure SAR results for other channels in worst SAR testing position if the reported SAR of highest power channel is larger than 0.8 W/kg

According to the test standard, the recommended procedure for assessing the peak spatial-average SAR value consists of the following steps:

- (a) Power reference measurement
- (b) Area scan
- (c) Zoom scan
- (d) Power drift measurement

8.1 Spatial Peak SAR Evaluation

The procedure for spatial peak SAR evaluation has been implemented according to the test standard. It can be conducted for 1g and 10g, as well as for user-specific masses. The DASY software includes all numerical procedures necessary to evaluate the spatial peak SAR value.

The base for the evaluation is a "cube" measurement. The measured volume must include the 1g and 10g cubes with the highest averaged SAR values. For that purpose, the center of the measured volume is aligned to the interpolated peak SAR value of a previously performed area scan.

The entire evaluation of the spatial peak values is performed within the post-processing engine (SEMCAD). The system always gives the maximum values for the 1g and 10g cubes. The algorithm to find the cube with highest averaged SAR is divided into the following stages:

- (a) Extraction of the measured data (grid and values) from the Zoom Scan
- (b) Calculation of the SAR value at every measurement point based on all stored data (A/D values and measurement parameters)
- (c) Generation of a high-resolution mesh within the measured volume
- (d) Interpolation of all measured values from the measurement grid to the high-resolution grid
- (e) Extrapolation of the entire 3-D field distribution to the phantom surface over the distance from sensor to surface
- (f) Calculation of the averaged SAR within masses of 1g and 10g

8.2 Power Reference Measurement

The Power Reference Measurement and Power Drift Measurements are for monitoring the power drift of the device under test in the batch process. The minimum distance of probe sensors to surface determines the closest measurement point to phantom surface. This distance cannot be smaller than the distance of sensor calibration points to probe tip as defined in the probe properties.

8.3 Area Scan

The area scan is used as a fast scan in two dimensions to find the area of high field values, before doing a fine measurement around the hot spot. The sophisticated interpolation routines implemented in DASY software can find the maximum found in the scanned area, within a range of the global maximum. The range (in dB0) is specified in the standards for compliance testing. For example, a 2 dB range is required in IEEE standard 1528 and IEC 62209 standards, whereby 3 dB is a requirement when compliance is assessed in accordance with the ARIB standard (Japan), if only one zoom scan follows the area scan, then only the absolute maximum will be taken as reference. For cases where multiple maximums are detected, the number of zoom scans has to be increased accordingly.

Area scan parameters extracted from FCC KDB 865664 D01v01r04 SAR measurement 100 MHz to 6 GHz.

	≤ 3 GHz	> 3 GHz
Maximum distance from closest measurement point (geometric center of probe sensors) to phantom surface	5 ± 1 mm	$\frac{1}{2} \cdot \delta \cdot \ln(2) \pm 0.5$ mm
Maximum probe angle from probe axis to phantom surface normal at the measurement location	$30^\circ \pm 1^\circ$	$20^\circ \pm 1^\circ$
Maximum area scan spatial resolution: Δx_{Area} , Δy_{Area}	≤ 2 GHz: ≤ 15 mm $2 - 3$ GHz: ≤ 12 mm	$3 - 4$ GHz: ≤ 12 mm $4 - 6$ GHz: ≤ 10 mm
	When the x or y dimension of the test device, in the measurement plane orientation, is smaller than the above, the measurement resolution must be \leq the corresponding x or y dimension of the test device with at least one measurement point on the test device.	

8.4 Zoom Scan

Zoom scans are used assess the peak spatial SAR values within a cubic averaging volume containing 1 gram and 10 gram of simulated tissue. The zoom scan measures points (refer to table below) within a cube shoes base faces are centered on the maxima found in a preceding area scan job within the same procedure. When the measurement is done, the zoom scan evaluates the averaged SAR for 1 gram and 10 gram and displays these values next to the job's label.

Zoom scan parameters extracted from FCC KDB 865664 D01v01r04 SAR measurement 100 MHz to 6 GHz.

		≤ 3 GHz	> 3 GHz	
Maximum zoom scan spatial resolution: $\Delta x_{Zoom}, \Delta y_{Zoom}$		≤ 2 GHz: ≤ 8 mm 2 – 3 GHz: ≤ 5 mm*	3 – 4 GHz: ≤ 5 mm* 4 – 6 GHz: ≤ 4 mm*	
Maximum zoom scan spatial resolution, normal to phantom surface	uniform grid: $\Delta z_{Zoom}(n)$	≤ 5 mm	3 – 4 GHz: ≤ 4 mm 4 – 5 GHz: ≤ 3 mm 5 – 6 GHz: ≤ 2 mm	
	graded grid	$\Delta z_{Zoom}(1)$: between 1 st two points closest to phantom surface	≤ 4 mm	3 – 4 GHz: ≤ 3 mm 4 – 5 GHz: ≤ 2.5 mm 5 – 6 GHz: ≤ 2 mm
		$\Delta z_{Zoom}(n>1)$: between subsequent points	$\leq 1.5 \cdot \Delta z_{Zoom}(n-1)$	
Minimum zoom scan volume	x, y, z	≥ 30 mm	3 – 4 GHz: ≥ 28 mm 4 – 5 GHz: ≥ 25 mm 5 – 6 GHz: ≥ 22 mm	
Note: δ is the penetration depth of a plane-wave at normal incidence to the tissue medium; see draft standard IEEE P1528-2011 for details. * When zoom scan is required and the <i>reported</i> SAR from the <i>area scan based 1-g SAR estimation</i> procedures of KDB 447498 is ≤ 1.4 W/kg, ≤ 8 mm, ≤ 7 mm and ≤ 5 mm zoom scan resolution may be applied, respectively, for 2 GHz to 3 GHz, 3 GHz to 4 GHz and 4 GHz to 6 GHz.				

8.5 Volume Scan Procedures

The volume scan is used for assess overlapping SAR distributions for antennas transmitting in different frequency bands. It is equivalent to an oversized zoom scan used in standalone measurements. The measurement volume will be used to enclose all the simultaneous transmitting antennas. For antennas transmitting simultaneously in different frequency bands, the volume scan is measured separately in each frequency band. In order to sum correctly to compute the 1g aggregate SAR, the EUT remain in the same test position for all measurements and all volume scan use the same spatial resolution and grid spacing. When all volume scan were completed, the software, SEMCAD postprocessor can combine and subsequently superpose these measurement data to calculating the multiband SAR.

8.6 Power Drift Monitoring

All SAR testing is under the EUT install full charged battery and transmit maximum output power. In DASy measurement software, the power reference measurement and power drift measurement procedures are used for monitoring the power drift of EUT during SAR test. Both these procedures measure the field at a specified reference position before and after the SAR testing. The software will calculate the field difference in dB. If the power drifts more than 5%, the SAR will be retested.



9. Test Equipment List

Manufacturer	Name of Equipment	Type/Model	Serial Number	Calibration	
				Last Cal.	Due Date
SPEAG	750MHz System Validation Kit	D750V3	1012	May. 18, 2016	May. 17, 2017
SPEAG	835MHz System Validation Kit	D835V2	499	Mar. 21, 2016	Mar. 20, 2017
SPEAG	1750MHz System Validation Kit	D1750V2	1068	Nov. 23, 2015	Nov. 22, 2016
SPEAG	1900MHz System Validation Kit	D1900V2	50041	Oct. 22, 2015	Oct. 21, 2016
SPEAG	2450MHz System Validation Kit	D2450V2	735	Dec. 10, 2015	Dec. 09, 2016
SPEAG	5GHz System Validation Kit	D5GHzV2	1006	Oct. 06, 2015	Oct. 05, 2016
SPEAG	5GHz System Validation Kit	D5GHzV2	1128	Jul. 27, 2016	Jul. 26, 2017
SPEAG	Data Acquisition Electronics	DAE3	495	May. 27, 2016	May. 26, 2017
SPEAG	Data Acquisition Electronics	DAE4	778	May. 12, 2016	May. 11, 2017
SPEAG	Data Acquisition Electronics	DAE3	577	Sep. 24, 2015	Sep. 23, 2016
SPEAG	Data Acquisition Electronics	DAE4	1399	Nov. 23, 2015	Nov. 22, 2016
SPEAG	Data Acquisition Electronics	DAE4	1388	Sep. 25, 2015	Sep. 24, 2016
SPEAG	Dosimetric E-Field Probe	EX3DV4	3925	May. 26, 2016	May. 25, 2017
SPEAG	Dosimetric E-Field Probe	EX3DV4	3697	Sep. 28, 2015	Sep. 27, 2016
SPEAG	Dosimetric E-Field Probe	ES3DV3	3270	Aug. 26, 2016	Aug. 25, 2017
SPEAG	Dosimetric E-Field Probe	EX3DV4	3931	Oct. 01, 2015	Sep. 30, 2016
SPEAG	Dosimetric E-Field Probe	EX3DV4	3955	Nov. 24, 2015	Nov. 23, 2016
WonDer	Thermometer	WD-5015	TM685	Oct. 16, 2015	Oct. 15, 2016
WonDer	Thermometer	WD-5015	TM642	Oct. 16, 2015	Oct. 15, 2016
WonDer	Thermometer	WD-5015	TM281	Oct. 16, 2015	Oct. 15, 2016
Wisewind	Thermometer	HTC-1	TM560	Oct. 16, 2015	Oct. 15, 2016
Wisewind	Thermometer	HTC-1	TM225	Oct. 16, 2015	Oct. 15, 2016
Anritsu	Radio Communication Analyzer	MT8820C	6201341950	Dec. 18, 2015	Dec. 17, 2016
Agilent	Wireless Communication Test Set	E5515C	MY50266977	May. 17, 2016	May. 16, 2017
R&S	BT Base Station	CBT	101136	Sep. 14, 2016	Sep. 13, 2017
SPEAG	Device Holder	N/A	N/A	N/A	N/A
R&S	Signal Generator	MG3710A	6201502524	Dec. 18, 2015	Dec. 17, 2016
Agilent	ENA Network Analyzer	E5071C	MY46316648	Jan. 12, 2016	Jan. 11, 2017
SPEAG	Dielectric Probe Kit	DAK-3.5	1126	Jul. 19, 2016	Jul. 18, 2017
Anritsu	Power Meter	ML2495A	1419002	May. 10, 2016	May. 09, 2017
LINE SEIKI	Digital Thermometer	LKMelectronic	DTM3000SPEZIAL	Sep. 05, 2016	Sep. 04, 2017
Anritsu	Power Sensor	MA2411B	1339124	May. 10, 2016	May. 09, 2017
Anritsu	Spectrum Analyzer	MS2830A	6201396378	Jun. 21, 2016	Jun. 20, 2017
Mini-Circuits	Power Amplifier	ZVE-8G+	D120604	Mar. 16, 2016	Mar. 15, 2017
Mini-Circuits	Power Amplifier	ZHL-42W+	QA1344002	Mar. 16, 2016	Mar. 15, 2017
ATM	Dual Directional Coupler	C122H-10	P610410z-02	Note 1	
Woken	Attenuator 1	WK0602-XX	N/A	Note 1	
PE	Attenuator 2	PE7005-10	N/A	Note 1	
PE	Attenuator 3	PE7005- 3	N/A	Note 1	

General Note:

1. Prior to system verification and validation, the path loss from the signal generator to the system check source and the power meter, which includes the amplifier, cable, attenuator and directional coupler, was measured by the network analyzer. The reading of the power meter was offset by the path loss difference between the path to the power meter and the path to the system check source to monitor the actual power level fed to the system check source.

10. System Verification

10.1 Tissue Simulating Liquids

For the measurement of the field distribution inside the SAM phantom with DASY, the phantom must be filled with around 25 liters of homogeneous body tissue simulating liquid. For head SAR testing, the liquid height from the ear reference point (ERP) of the phantom to the liquid top surface is larger than 15 cm, which is shown in Fig. 10.1. For body SAR testing, the liquid height from the center of the flat phantom to the liquid top surface is larger than 15 cm, which is shown in Fig. 10.2.

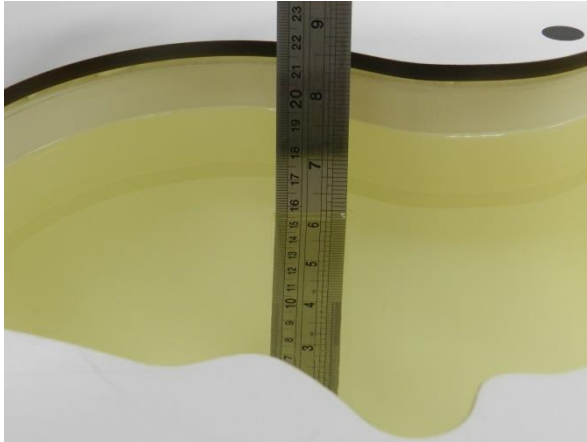

Fig 10.1 Photo of Liquid Height for Head SAR

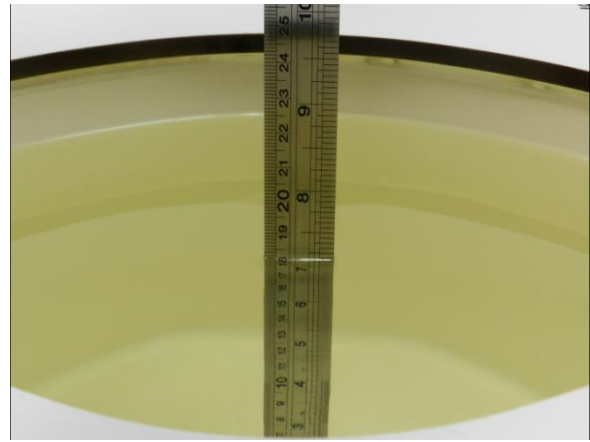

Fig 10.2 Photo of Liquid Height for Body SAR



10.2 Tissue Verification

The following tissue formulations are provided for reference only as some of the parameters have not been thoroughly verified. The composition of ingredients may be modified accordingly to achieve the desired target tissue parameters required for routine SAR evaluation.

Frequency (MHz)	Water (%)	Sugar (%)	Cellulose (%)	Salt (%)	Preventol (%)	DGBE (%)	Conductivity (σ)	Permittivity (εr)
For Head								
750	41.1	57.0	0.2	1.4	0.2	0	0.89	41.9
835	40.3	57.9	0.2	1.4	0.2	0	0.90	41.5
900	40.3	57.9	0.2	1.4	0.2	0	0.97	41.5
1800, 1900, 2000	55.2	0	0	0.3	0	44.5	1.40	40.0
2450	55.0	0	0	0	0	45.0	1.80	39.2
2600	54.8	0	0	0.1	0	45.1	1.96	39.0
For Body								
750	51.7	47.2	0	0.9	0.1	0	0.96	55.5
835	50.8	48.2	0	0.9	0.1	0	0.97	55.2
900	50.8	48.2	0	0.9	0.1	0	1.05	55.0
1800, 1900, 2000	70.2	0	0	0.4	0	29.4	1.52	53.3
2450	68.6	0	0	0	0	31.4	1.95	52.7
2600	68.1	0	0	0.1	0	31.8	2.16	52.5

Simulating Liquid for 5GHz, Manufactured by SPEAG

Ingredients	(% by weight)
Water	64~78%
Mineral oil	11~18%
Emulsifiers	9~15%
Additives and Salt	2~3%

<Tissue Dielectric Parameter Check Results>

Frequency (MHz)	Tissue Type	Liquid Temp. (°C)	Conductivity (σ)	Permittivity (εr)	Conductivity Target (σ)	Permittivity Target (εr)	Delta (σ) (%)	Delta (εr) (%)	Limit (%)	Date
750	HSL	22.5	0.900	43.531	0.89	41.90	1.12	3.89	±5	2016/9/9
750	MSL	22.5	0.953	55.798	0.96	55.50	-0.73	0.54	±5	2016/9/9
750	MSL	22.5	0.953	55.798	0.96	55.50	-0.73	0.54	±5	2016/9/9
835	HSL	22.6	0.896	42.544	0.90	41.50	-0.44	2.52	±5	2016/9/10
835	MSL	22.4	0.968	57.158	0.97	55.20	-0.21	3.55	±5	2016/9/7
835	MSL	22.5	0.962	57.058	0.97	55.20	-0.82	3.37	±5	2016/9/8
835	MSL	22.5	0.962	57.058	0.97	55.20	-0.82	3.37	±5	2016/9/8
1750	HSL	22.2	1.372	40.003	1.37	40.10	0.15	-0.24	±5	2016/9/11
1750	MSL	22.7	1.509	55.934	1.49	53.40	1.28	4.75	±5	2016/9/6
1900	HSL	22.2	1.396	40.551	1.40	40.00	-0.29	1.38	±5	2016/9/11
1900	MSL	22.7	1.553	55.777	1.52	53.30	2.17	4.65	±5	2016/9/5
1900	MSL	22.4	1.546	55.745	1.52	53.30	1.71	4.59	±5	2016/9/7
2450	HSL	22.6	1.763	40.773	1.80	39.20	-2.06	4.01	±5	2016/9/8
2450	MSL	22.6	1.981	52.574	1.95	52.70	1.59	-0.24	±5	2016/9/8
2450	MSL	22.4	1.960	52.299	1.95	52.70	0.51	-0.76	±5	2016/9/21
5250	MSL	22.9	5.472	46.898	5.36	48.95	2.09	-4.19	±5	2016/9/9
5250	MSL	22.5	5.463	46.788	5.36	48.95	1.92	-4.42	±5	2016/9/13
5300	HSL	22.6	4.597	36.154	4.76	35.90	-3.42	0.71	±5	2016/9/8
5600	HSL	22.6	4.892	35.748	5.07	35.50	-3.51	0.70	±5	2016/9/8
5600	MSL	22.9	5.926	46.314	5.77	48.50	2.70	-4.51	±5	2016/9/9
5600	MSL	22.5	5.931	46.232	5.77	48.50	2.79	-4.68	±5	2016/9/12
5750	MSL	22.5	6.129	45.969	5.94	48.28	3.18	-4.79	±5	2016/9/12
5800	HSL	22.5	5.046	34.865	5.27	35.30	-4.25	-1.23	±5	2016/9/11

10.3 System Performance Check Results

Comparing to the original SAR value provided by SPEAG, the verification data should be within its specification of 10 %. Below table shows the target SAR and measured SAR after normalized to 1W input power. The table below indicates the system performance check can meet the variation criterion and the plots can be referred to Appendix A of this report.

Date	Frequency (MHz)	Tissue Type	Input Power (mW)	Dipole S/N	Probe S/N	DAE S/N	Measured 1g SAR (W/kg)	Targeted 1g SAR (W/kg)	Normalized 1g SAR (W/kg)	Deviation (%)
2016/9/9	750	HSL	250	D750V3-1012	ES3DV3 - SN3270	DAE4 Sn1399	2.17	8.21	8.68	5.72
2016/9/9	750	MSL	250	D750V3-1012	ES3DV3 - SN3270	DAE4 Sn1399	2.29	8.72	9.16	5.05
2016/9/9	750	MSL	250	D750V3-1012	EX3DV4 - SN3955	DAE4 Sn778	2.20	8.72	8.80	0.92
2016/9/10	835	HSL	250	D835V2-499	ES3DV3 - SN3270	DAE4 Sn1399	2.41	9.14	9.64	5.47
2016/9/7	835	MSL	250	D835V2-499	EX3DV4 - SN3955	DAE4 Sn778	2.49	9.52	9.96	4.62
2016/9/8	835	MSL	250	D835V2-499	ES3DV3 - SN3270	DAE4 Sn1399	2.41	9.52	9.64	1.26
2016/9/8	835	MSL	250	D835V2-499	EX3DV4 - SN3955	DAE4 Sn778	2.41	9.52	9.64	1.26
2016/9/11	1750	HSL	250	D1750V2-1068	ES3DV3 - SN3270	DAE4 Sn1399	9.27	36.80	37.08	0.76
2016/9/6	1750	MSL	250	D1750V2-1068	EX3DV4 - SN3955	DAE4 Sn778	9.19	35.70	36.76	2.97
2016/9/11	1900	HSL	250	D1900V2-5d041	ES3DV3 - SN3270	DAE4 Sn1399	9.54	39.80	38.16	-4.12
2016/9/5	1900	MSL	250	D1900V2-5d041	EX3DV4 - SN3955	DAE4 Sn778	10.10	40.00	40.40	1.00
2016/9/7	1900	MSL	250	D1900V2-5d041	EX3DV4 - SN3955	DAE4 Sn778	10.20	40.00	40.80	2.00
2016/9/8	2450	HSL	250	D2450V2-735	EX3DV4 - SN3697	DAE4 Sn1388	12.90	52.10	51.60	-0.96
2016/9/8	2450	MSL	250	D2450V2-735	EX3DV4 - SN3697	DAE4 Sn1388	12.90	52.10	51.60	-0.96
2016/9/21	2450	MSL	250	D2450V2-735	EX3DV4 - SN3925	DAE3 Sn495	12.20	52.10	48.8	-6.33
2016/9/9	5250	MSL	100	D5GHzV2-1128	EX3DV4 - SN3931	DAE3 Sn577	7.47	74.50	74.70	0.27
2016/9/13	5250	MSL	100	D5GHzV2-1128	EX3DV4 - SN3931	DAE3 Sn577	7.88	74.50	78.80	5.77
2016/9/8	5300	HSL	100	D5GHzV2-1006	EX3DV4 - SN3925	DAE3 Sn495	8.06	84.50	80.60	-4.62
2016/9/8	5600	HSL	100	D5GHzV2-1006	EX3DV4 - SN3925	DAE3 Sn495	8.95	84.80	89.50	5.54
2016/9/9	5600	MSL	100	D5GHzV2-1128	EX3DV4 - SN3931	DAE3 Sn577	8.28	78.00	82.80	6.15
2016/9/12	5600	MSL	100	D5GHzV2-1128	EX3DV4 - SN3931	DAE3 Sn577	8.29	78.00	82.90	6.28
2016/9/12	5750	MSL	100	D5GHzV2-1128	EX3DV4 - SN3931	DAE3 Sn577	7.37	76.10	73.70	-3.15
2016/9/11	5800	HSL	100	D5GHzV2-1006	EX3DV4 - SN3925	DAE3 Sn495	7.92	82.00	79.20	-3.41

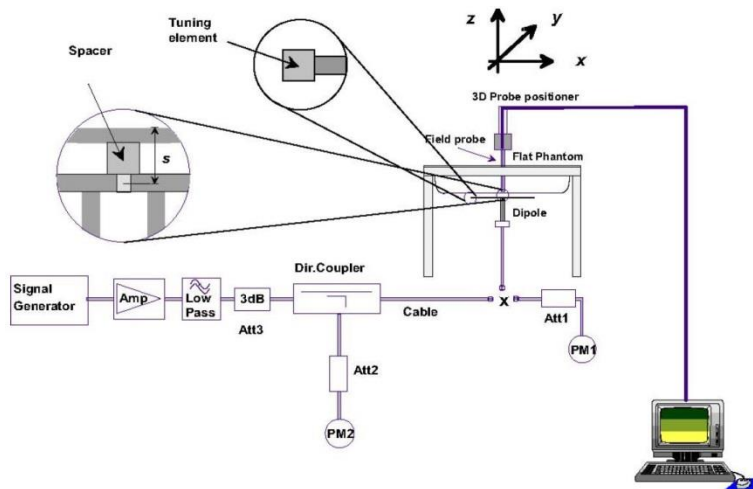

Fig 8.3.1 System Performance Check Setup



Fig 8.3.2 Setup Photo

11. RF Exposure Positions

11.1 Ear and handset reference point

Figure 9.1.1 shows the front, back, and side views of the SAM phantom. The center-of-mouth reference point is labeled “M,” the left ear reference point (ERP) is marked “LE,” and the right ERP is marked “RE.” Each ERP is 15 mm along the B-M (back-mouth) line behind the entrance-to-ear-canal (EEC) point, as shown in Figure 9.1.2 The Reference Plane is defined as passing through the two ear reference points and point M. The line N-F (neck-front), also called the reference pivoting line, is normal to the Reference Plane and perpendicular to both a line passing through RE and LE and the B-M line (see Figure 9.1.3). Both N-F and B-M lines should be marked on the exterior of the phantom shell to facilitate handset positioning. Posterior to the N-F line the ear shape is a flat surface with 6 mm thickness at each ERP, and forward of the N-F line the ear is truncated, as illustrated in Figure 9.1.2. The ear truncation is introduced to preclude the ear lobe from interfering with handset tilt, which could lead to unstable positioning at the cheek.

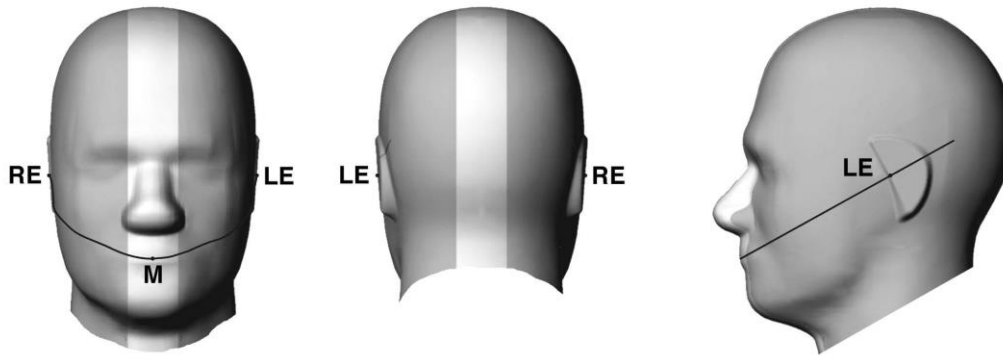

Fig 9.1.1 Front, back, and side views of SAM twin phantom

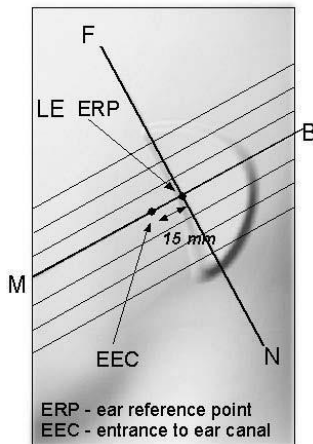

Fig 9.1.2 Close-up side view of phantom showing the ear region.

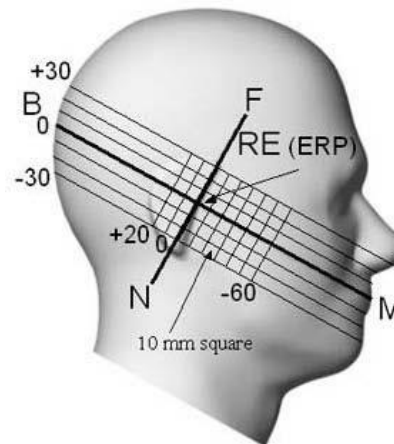

Fig 9.1.3 Side view of the phantom showing relevant markings and seven cross-sectional plane locations

11.2 Definition of the cheek position

1. Ready the handset for talk operation, if necessary. For example, for handsets with a cover piece (flip cover), open the cover. If the handset can transmit with the cover closed, both configurations must be tested.
2. Define two imaginary lines on the handset—the vertical centerline and the horizontal line. The vertical centerline passes through two points on the front side of the handset—the midpoint of the width w_t of the handset at the level of the acoustic output (point A in Figure 9.2.1 and Figure 9.2.2), and the midpoint of the width w_b of the bottom of the handset (point B). The horizontal line is perpendicular to the vertical centerline and passes through the center of the acoustic output (see Figure 9.2.1). The two lines intersect at point A. Note that for many handsets, point A coincides with the center of the acoustic output; however, the acoustic output may be located elsewhere on the horizontal line. Also note that the vertical centerline is not necessarily parallel to the front face of the handset (see Figure 9.2.2), especially for clamshell handsets, handsets with flip covers, and other irregularly-shaped handsets.
3. Position the handset close to the surface of the phantom such that point A is on the (virtual) extension of the line passing through points RE and LE on the phantom (see Figure 9.2.3), such that the plane defined by the vertical centerline and the horizontal line of the handset is approximately parallel to the sagittal plane of the phantom.
4. Translate the handset towards the phantom along the line passing through RE and LE until handset point A touches the pinna at the ERP.
5. While maintaining the handset in this plane, rotate it around the LE-RE line until the vertical centerline is in the plane normal to the plane containing B-M and N-F lines, i.e., the Reference Plane.
6. Rotate the handset around the vertical centerline until the handset (horizontal line) is parallel to the N-F line.
7. While maintaining the vertical centerline in the Reference Plane, keeping point A on the line passing through RE and LE, and maintaining the handset contact with the pinna, rotate the handset about the N-F line until any point on the handset is in contact with a phantom point below the pinna on the cheek. See Figure 9.2.3. The actual rotation angles should be documented in the test report.

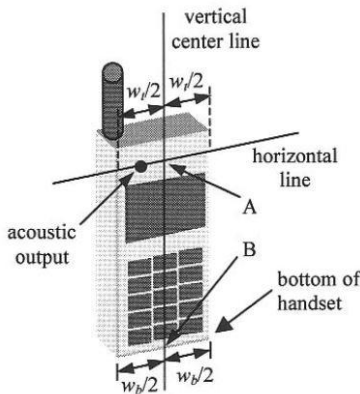

Fig 9.2.1 Handset vertical and horizontal reference lines—“fixed case”

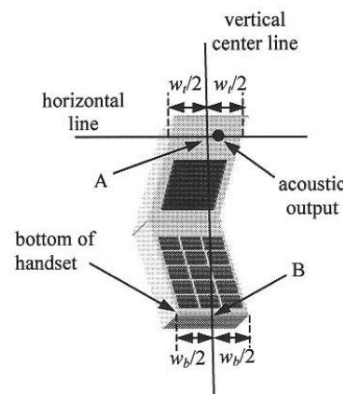

Fig 9.2.2 Handset vertical and horizontal reference lines—“clam-shell case”

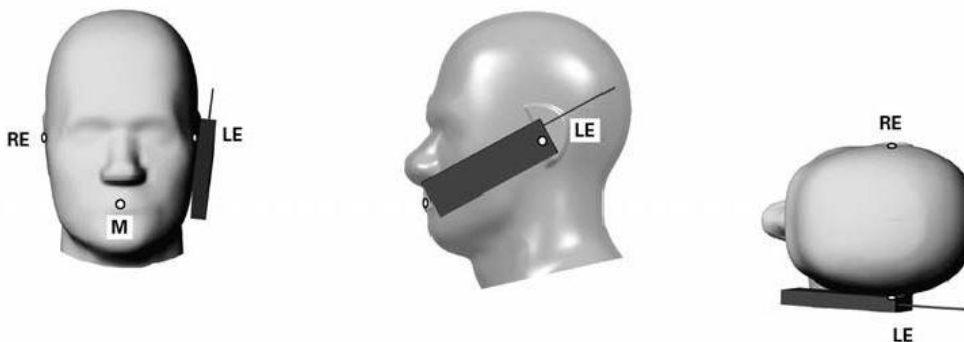

Fig 9.2.3 cheek or touch position. The reference points for the right ear (RE), left ear (LE), and mouth (M), which establish the Reference Plane for handset positioning, are indicated.

11.3 Definition of the tilt position

1. Ready the handset for talk operation, if necessary. For example, for handsets with a cover piece (flip cover), open the cover. If the handset can transmit with the cover closed, both configurations must be tested.
2. While maintaining the orientation of the handset, move the handset away from the pinna along the line passing through RE and LE far enough to allow a rotation of the handset away from the cheek by 15°.
3. Rotate the handset around the horizontal line by 15°.
4. While maintaining the orientation of the handset, move the handset towards the phantom on the line passing through RE and LE until any part of the handset touches the ear. The tilt position is obtained when the contact point is on the pinna. See Figure 9.3.1. If contact occurs at any location other than the pinna, e.g., the antenna at the back of the phantom head, the angle of the handset should be reduced. In this case, the tilt position is obtained if any point on the handset is in contact with the pinna and a second point

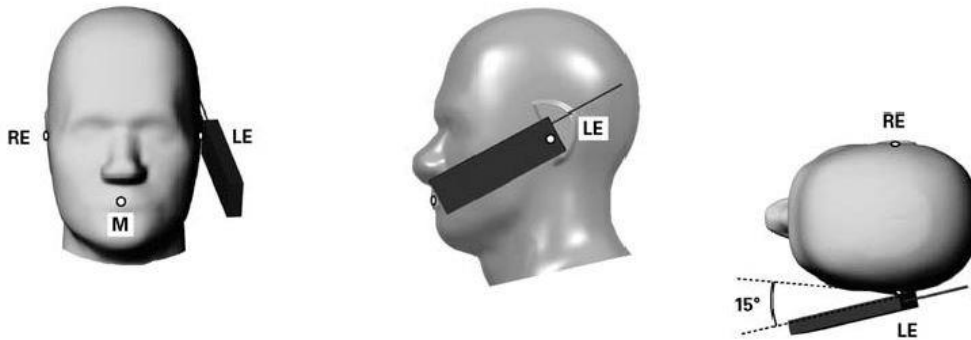

Fig 9.3.1 Tilt position. The reference points for the right ear (RE), left ear (LE), and mouth (M), which define the Reference Plane for handset positioning, are indicated.

11.4 Body Worn Accessory

Body-worn operating configurations are tested with the belt-clips and holsters attached to the device and positioned against a flat phantom in a normal use configuration (see Figure 9.4). Per KDB648474 D04v01r03, body-worn accessory exposure is typically related to voice mode operations when handsets are carried in body-worn accessories. The body-worn accessory procedures in FCC KDB 447498 D01v06 should be used to test for body-worn accessory SAR compliance, without a Earphone connected to it. This enables the test results for such configuration to be compatible with that required for hotspot mode when the body-worn accessory test separation distance is greater than or equal to that required for hotspot mode, when applicable. When the reported SAR for body-worn accessory, measured without a Earphone connected to the handset is < 1.2 W/kg, the highest reported SAR configuration for that wireless mode and frequency band should be repeated for that body-worn accessory with a handset attached to the handset.

Accessories for body-worn operation configurations are divided into two categories: those that do not contain metallic components and those that do contain metallic components. When multiple accessories that do not contain metallic components are supplied with the device, the device is tested with only the accessory that dictates the closest spacing to the body. Then multiple accessories that contain metallic components are test with the device with each accessory. If multiple accessories share an identical metallic component (i.e. the same metallic belt-chip used with different holsters with no other metallic components) only the accessory that dictates the closest spacing to the body is tested.

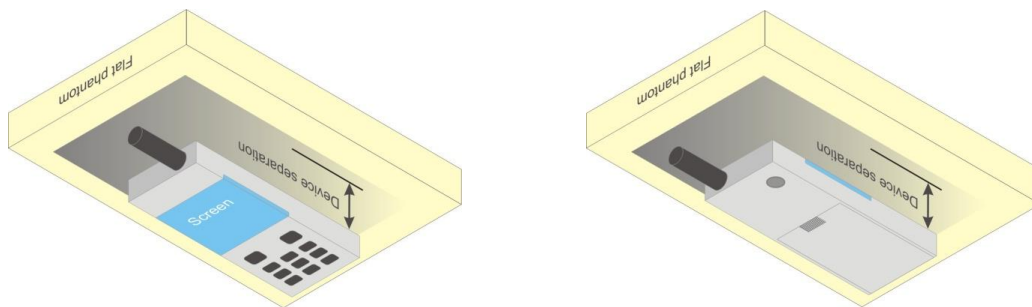

Fig 9.4 Body Worn Position

11.5 Wireless Router

Some battery-operated handsets have the capability to transmit and receive user through simultaneous transmission of WIFI simultaneously with a separate licensed transmitter. The FCC has provided guidance in FCC KDB Publication 941225 D06 v02r01 where SAR test considerations for handsets (L x W ≥ 9 cm x 5 cm) are based on a composite test separation distance of 10mm from the front, back and edges of the device containing transmitting antennas within 2.5cm of their edges, determined from general mixed use conditions for this type of devices. Since the hotspot SAR results may overlap with the body-worn accessory SAR requirements, the more conservative configurations can be considered, thus excluding some body-worn accessory SAR tests.

When the user enables the personal wireless router functions for the handset, actual operations include simultaneous transmission of both the WIFI transmitter and another licensed transmitter. Both transmitters often do not transmit at the same transmitting frequency and thus cannot be evaluated for SAR under actual use conditions due to the limitations of the SAR assessment probes. Therefore, SAR must be evaluated for each frequency transmission and mode separately and spatially summed with the WIFI transmitter according to FCC KDB Publication 447498 D01v06 publication procedures. The “Portable Hotspot” feature on the handset was NOT activated during SAR assessments, to ensure the SAR measurements were evaluated for a single transmission frequency RF signal at a time.



12. Conducted RF Output Power (Unit: dBm)

<GSM Conducted Power>

General Note:

1. Per KDB 447498 D01v06, the maximum output power channel is used for SAR testing and for further SAR test reduction.
2. Per KDB 941225 D01v03r01, for SAR test reduction for GSM / GPRS / EDGE modes is determined by the source-based time-averaged output power including tune-up tolerance. The mode with highest specified time-averaged output power should be tested for SAR compliance in the applicable exposure conditions. For modes with the same specified maximum output power and tolerance, the higher number time-slot configuration should be tested. Therefore, the GPRS (4Tx slots) for GSM850 and GPRS (3Tx slots) for GSM1900 are considered as the primary mode.
3. Other configurations of GSM / GPRS / EDGE are considered as secondary modes. The 3G SAR test reduction procedure is applied, when the maximum output power and tune-up tolerance specified for production units in a secondary mode is $\leq \frac{1}{4}$ dB higher than the primary mode, SAR measurement is not required for the secondary mode
4. Power reduction which is triggered by hotspot mode is implemented in GSM1900 band, for hotspot mode SAR testing EUT was set in reduced power mode and GPRS 4 Tx slot due to its highest frame-average power.

Default Power Mode

GSM850 TX Channel	Burst Average Power (dBm)			Tune-up Limit (dBm)	Frame-Average Power (dBm)			Tune-up Limit (dBm)
	128	189	251		128	189	251	
Frequency (MHz)	824.2	836.4	848.8		824.2	836.4	848.8	
GSM 1 Tx slot	32.03	32.22	32.12	34.00	23.03	23.22	23.12	25.00
GPRS 1 Tx slot	32.20	32.21	32.10	34.00	23.20	23.21	23.10	25.00
GPRS 2 Tx slots	31.84	32.07	32.00	33.00	25.84	26.07	26.00	27.00
GPRS 3 Tx slots	31.67	31.85	31.80	33.00	27.41	27.59	27.54	28.74
GPRS 4 Tx slots	31.79	31.65	31.67	32.00	28.79	28.65	28.67	29.00
EDGE 1 Tx slot	25.96	25.93	25.94	27.50	16.96	16.93	16.94	18.50
EDGE 2 Tx slots	25.96	25.97	25.78	27.50	19.96	19.97	19.78	21.50
EDGE 3 Tx slots	25.81	25.87	25.73	27.50	21.55	21.61	21.47	23.24
EDGE 4 Tx slots	25.72	25.73	25.65	27.50	22.72	22.73	22.65	24.50

GSM1900 TX Channel	Burst Average Power (dBm)			Tune-up Limit (dBm)	Frame-Average Power (dBm)			Tune-up Limit (dBm)
	512	661	810		512	661	810	
Frequency (MHz)	1850.2	1880	1909.8		1850.2	1880	1909.8	
GSM 1 Tx slot	29.45	29.52	29.36	31.00	20.45	20.52	20.36	22.00
GPRS 1 Tx slot	29.39	29.53	29.37	31.00	20.39	20.53	20.37	22.00
GPRS 2 Tx slots	29.42	29.50	29.29	31.00	23.42	23.50	23.29	25.00
GPRS 3 Tx slots	29.34	29.41	29.30	30.00	25.08	25.15	25.04	25.74
GPRS 4 Tx slots	27.60	27.58	27.18	28.50	24.60	24.58	24.18	25.50
EDGE 1 Tx slot	25.53	25.50	25.20	27.00	16.53	16.50	16.20	18.00
EDGE 2 Tx slots	25.47	25.41	25.21	27.00	19.47	19.41	19.21	21.00
EDGE 3 Tx slots	25.38	25.41	25.20	27.00	21.12	21.15	20.94	22.74
EDGE 4 Tx slots	25.44	25.39	25.19	27.00	22.44	22.39	22.19	24.00



Reduced Power Mode

GSM1900 TX Channel	Burst Average Power (dBm)			Tune-up Limit (dBm)	Frame-Average Power (dBm)			Tune-up Limit (dBm)
	512	661	810		512	661	810	
Frequency (MHz)	1850.2	1880	1909.8		1850.2	1880	1909.8	
GSM 1 Tx slot	28.54	28.55	28.37	29.50	19.54	19.55	19.37	20.50
GPRS 1 Tx slot	28.56	28.55	28.38	29.50	19.56	19.55	19.38	20.50
GPRS 2 Tx slots	25.57	25.51	25.31	26.50	19.57	19.51	19.31	20.50
GPRS 3 Tx slots	23.54	23.48	23.25	24.50	19.28	19.22	18.99	20.24
GPRS 4 Tx slots	22.55	22.50	22.45	23.50	19.55	19.50	19.45	20.50
EDGE 1 Tx slot	25.53	25.50	25.20	27.00	16.53	16.50	16.20	18.00
EDGE 2 Tx slots	24.72	24.75	24.51	26.50	18.72	18.75	18.51	20.50
EDGE 3 Tx slots	23.26	23.23	22.96	24.50	19.00	18.97	18.70	20.24
EDGE 4 Tx slots	22.69	22.67	22.38	23.50	19.69	19.67	19.38	20.50

<WCDMA Conducted Power>

1. The following tests were conducted according to the test requirements outlines in 3GPP TS 34.121 specification.
2. The procedures in KDB 941225 D01v03r01 are applied for 3GPP Rel. 6 HSPA to configure the device in the required sub-test mode(s) to determine SAR test exclusion.
3. For DC-HSDPA, the device was configured according to the H-Set 12, Fixed Reference Channel (FRC) configuration in Table C.8.1.12 of 3GPP TS 34.121-1, with the primary and the secondary serving HS-DSCH Cell enabled during the power measurement.

A summary of these settings are illustrated below:

HSDPA Setup Configuration:

- a. The EUT was connected to Base Station Agilent E5515C referred to the Setup Configuration.
- b. The RF path losses were compensated into the measurements.
- c. A call was established between EUT and Base Station with following setting:
 - i. Set Gain Factors (β_c and β_d) and parameters were set according to each
 - ii. Specific sub-test in the following table, C10.1.4, quoted from the TS 34.121
 - iii. Set RMC 12.2Kbps + HSDPA mode.
 - iv. Set Cell Power = -86 dBm
 - v. Set HS-DSCH Configuration Type to FRC (H-set 1, QPSK)
 - vi. Select HSDPA Uplink Parameters
 - vii. Set Delta ACK, Delta NACK and Delta CQI = 8
 - viii. Set Ack-Nack Repetition Factor to 3
 - ix. Set CQI Feedback Cycle (k) to 4 ms
 - x. Set CQI Repetition Factor to 2
 - xi. Power Ctrl Mode = All Up bits
- d. The transmitted maximum output power was recorded.

Table C.10.1.4: β values for transmitter characteristics tests with HS-DPCCH

Sub-test	β_c	β_d	β_d (SF)	β_c/β_d	β_{HS} (Note 1, Note 2)	CM (dB) (Note 3)	MPR (dB) (Note 3)
1	2/15	15/15	64	2/15	4/15	0.0	0.0
2	12/15 (Note 4)	15/15 (Note 4)	64	12/15 (Note 4)	24/15	1.0	0.0
3	15/15	8/15	64	15/8	30/15	1.5	0.5
4	15/15	4/15	64	15/4	30/15	1.5	0.5

Note 1: $\Delta_{ACK}, \Delta_{NACK}$ and $\Delta_{CQI} = 30/15$ with $\beta_{HS} = 30/15 * \beta_c$.

Note 2: For the HS-DPCCH power mask requirement test in clause 5.2C, 5.7A, and the Error Vector Magnitude (EVM) with HS-DPCCH test in clause 5.13.1A, and HSDPA EVM with phase discontinuity in clause 5.13.1AA, Δ_{ACK} and $\Delta_{NACK} = 30/15$ with $\beta_{HS} = 30/15 * \beta_c$, and $\Delta_{CQI} = 24/15$ with $\beta_{HS} = 24/15 * \beta_c$.

Note 3: CM = 1 for $\beta_c/\beta_d = 12/15, \beta_{HS}/\beta_c = 24/15$. For all other combinations of DPCCH, DPDCCH and HS-DPCCH the MPR is based on the relative CM difference. This is applicable for only UEs that support HSDPA in release 6 and later releases.

Note 4: For subtest 2 the β_c/β_d ratio of 12/15 for the TFC during the measurement period (TF1, TF0) is achieved by setting the signalled gain factors for the reference TFC (TF1, TF1) to $\beta_c = 11/15$ and $\beta_d = 15/15$.

Setup Configuration

HSUPA Setup Configuration:

- a. The EUT was connected to Base Station Agilent E5515C referred to the Setup Configuration.
- b. The RF path losses were compensated into the measurements.
- c. A call was established between EUT and Base Station with following setting * :
 - i. Call Configs = 5.2B, 5.9B, 5.10B, and 5.13.2B with QPSK
 - ii. Set the Gain Factors (β_c and β_d) and parameters (AG Index) were set according to each specific sub-test in the following table, C11.1.3, quoted from the TS 34.121
 - iii. Set Cell Power = -86 dBm
 - iv. Set Channel Type = 12.2k + HSPA
 - v. Set UE Target Power
 - vi. Power Ctrl Mode= Alternating bits
 - vii. Set and observe the E-TFCl
 - viii. Confirm that E-TFCl is equal to the target E-TFCl of 75 for sub-test 1, and other subtest's E-TFCl
- d. The transmitted maximum output power was recorded.

Table C.11.1.3: β values for transmitter characteristics tests with HS-DPCCH and E-DCH

Sub-test	β_c	β_d	β_d (SF)	β_c/β_d	β_{HS} (Note 1)	β_{ec}	β_{ed} (Note 5) (Note 6)	β_{ed} (SF)	β_{ed} (Codes)	CM (dB) (Note 2)	MPR (dB) (Note 2)	AG Index (Note 6)	E-TFCl
1	11/15 (Note 3)	15/15 (Note 3)	64	11/15 (Note 3)	22/15	209/25	1309/225	4	1	1.0	0.0	20	75
2	6/15	15/15	64	6/15	12/15	12/15	94/75	4	1	3.0	2.0	12	67
3	15/15	9/15	64	15/9	30/15	30/15	$\beta_{ed1}: 47/15$ $\beta_{ed2}: 47/15$	4 4	2	2.0	1.0	15	92
4	2/15	15/15	64	2/15	4/15	2/15	56/75	4	1	3.0	2.0	17	71
5	15/15 (Note 4)	15/15 (Note 4)	64	15/15 (Note 4)	30/15	24/15	134/15	4	1	1.0	0.0	21	81

Note 1: $\Delta_{ACK}, \Delta_{NACK}$ and $\Delta_{CQI} = 30/15$ with $\beta_{hs} = 30/15 * \beta_c$.

Note 2: CM = 1 for $\beta_c/\beta_d = 12/15$, $\beta_{hs}/\beta_c = 24/15$. For all other combinations of DPDCH, DPCCH, HS- DPCCH, E-DPDCH and E-DPCCH the MPR is based on the relative CM difference.

Note 3: For subtest 1 the β_c/β_d ratio of 11/15 for the TFC during the measurement period (TF1, TF0) is achieved by setting the signalled gain factors for the reference TFC (TF1, TF1) to $\beta_c = 10/15$ and $\beta_d = 15/15$.

Note 4: For subtest 5 the β_c/β_d ratio of 15/15 for the TFC during the measurement period (TF1, TF0) is achieved by setting the signalled gain factors for the reference TFC (TF1, TF1) to $\beta_c = 14/15$ and $\beta_d = 15/15$.

Note 5: In case of testing by UE using E-DPDCH Physical Layer category 1, Sub-test 3 is omitted according to TS25.306 Table 5.1g.

Note 6: β_{ed} can not be set directly, it is set by Absolute Grant Value.

Setup Configuration

DC-HSDPA 3GPP release 8 Setup Configuration:

- a. The EUT was connected to Base Station Agilent E5515C referred to the Setup Configuration below
- b. The RF path losses were compensated into the measurements.
- c. A call was established between EUT and Base Station with following setting:
 - i. Set RMC 12.2Kbps + HSDPA mode.
 - ii. Set Cell Power = -25 dBm
 - iii. Set HS-DSCH Configuration Type to FRC (H-set 12, QPSK)
 - iv. Select HSDPA Uplink Parameters
 - v. Set Gain Factors (β_c and β_d) and parameters were set according to each Specific sub-test in the following table, C10.1.4, quoted from the TS 34.121
 - a). Subtest 1: $\beta_c/\beta_d=2/15$
 - b). Subtest 2: $\beta_c/\beta_d=12/15$
 - c). Subtest 3: $\beta_c/\beta_d=15/8$
 - d). Subtest 4: $\beta_c/\beta_d=15/4$
 - vi. Set Delta ACK, Delta NACK and Delta CQI = 8
 - vii. Set Ack-Nack Repetition Factor to 3
 - viii. Set CQI Feedback Cycle (k) to 4 ms
 - ix. Set CQI Repetition Factor to 2
 - x. Power Ctrl Mode = All Up bits
- d. The transmitted maximum output power was recorded.

The following tests were conducted according to the test requirements outlines in 3GPP TS 34.121 specification. A summary of these settings are illustrated below:

C.8.1.12 Fixed Reference Channel Definition H-Set 12

Table C.8.1.12: Fixed Reference Channel H-Set 12

Parameter	Unit	Value
Nominal Avg. Inf. Bit Rate	kbps	60
Inter-TTI Distance	TTI's	1
Number of HARQ Processes	Processes	6
Information Bit Payload (N_{INF})	Bits	120
Number Code Blocks	Blocks	1
Binary Channel Bits Per TTI	Bits	960
Total Available SML's in UE	SML's	19200
Number of SML's per HARQ Proc.	SML's	3200
Coding Rate		0.15
Number of Physical Channel Codes	Codes	1
Modulation		QPSK
Note 1: The RMC is intended to be used for DC-HSDPA mode and both cells shall transmit with identical parameters as listed in the table. Note 2: Maximum number of transmission is limited to 1, i.e., retransmission is not allowed. The redundancy and constellation version 0 shall be used.		

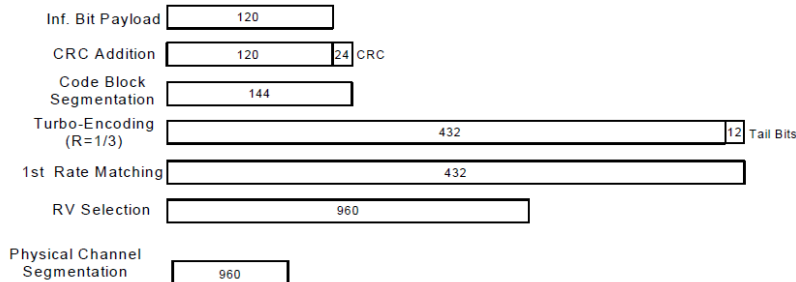

Figure C.8.19: Coding rate for Fixed reference Channel H-Set 12 (QPSK)

Setup Configuration



<WCDMA Conducted Power>

General Note:

1. Per KDB 941225 D01v03r01, for SAR testing is measured using a 12.2 kbps RMC with TPC bits configured to all "1's".
2. Per KDB 941225 D01v03r01, RMC 12.2kbps setting is used to evaluate SAR. If the maximum output power and tune-up tolerance specified for production units in HSDPA / HSUPA / DC-HSDPA is $\leq \frac{1}{4}$ dB higher than RMC 12.2Kbps or when the highest reported SAR of the RMC12.2Kbps is scaled by the ratio of specified maximum output power and tune-up tolerance of HSDPA / HSUPA / DC-HSDPA to RMC12.2Kbps and the adjusted SAR is ≤ 1.2 W/kg, SAR measurement is not required for HSDPA / HSUPA / DC-HSDPA.

Default Power Mode

Band		WCDMA II			Tune-up Limit (dBm)	WCDMA IV			Tune-up Limit (dBm)	WCDMA V			Tune-up Limit (dBm)
TX Channel		9262	9400	9538		1312	1413	1513		4132	4182	4233	
Rx Channel		9662	9800	9938	1537	1638	1738	4357	4407	4458			
Frequency (MHz)		1852.4	1880	1907.6	1712.4	1732.6	1752.6	826.4	836.4	846.6			
3GPP Rel 99	AMR 12.2Kbps	24.20	24.11	24.35	25.50	23.52	23.70	23.86	25.00	23.69	23.80	23.89	25.50
3GPP Rel 99	RMC 12.2Kbps	24.39	24.17	24.39	25.50	23.58	23.72	23.92	25.00	23.73	23.85	23.90	25.50
3GPP Rel 6	HSDPA Subtest-1	23.40	23.25	23.46	24.00	22.52	22.69	22.96	24.00	22.61	22.66	22.85	24.00
3GPP Rel 6	HSDPA Subtest-2	23.42	23.23	23.46	24.00	22.50	22.71	23.00	24.00	22.65	22.69	22.80	24.00
3GPP Rel 6	HSDPA Subtest-3	22.71	22.60	22.82	23.50	22.00	22.23	22.46	23.50	22.12	22.24	22.30	23.50
3GPP Rel 6	HSDPA Subtest-4	22.73	22.65	22.88	23.50	22.01	22.21	22.44	23.50	22.16	22.25	22.38	23.50
3GPP Rel 8	DC-HSDPA Subtest-1	23.30	23.12	23.38	24.00	22.50	22.74	22.84	24.00	22.65	22.68	22.87	24.00
3GPP Rel 8	DC-HSDPA Subtest-2	23.50	23.20	23.40	24.00	22.52	22.63	22.87	24.00	22.62	22.65	22.86	24.00
3GPP Rel 8	DC-HSDPA Subtest-3	22.67	22.56	22.74	23.50	22.02	22.19	22.42	23.50	22.07	22.19	22.31	23.50
3GPP Rel 8	DC-HSDPA Subtest-4	22.68	22.60	22.81	23.50	22.00	22.16	22.36	23.50	22.04	22.15	22.38	23.50
3GPP Rel 6	HSUPA Subtest-1	23.36	23.29	23.42	24.00	22.53	22.56	22.59	24.00	22.50	22.62	22.80	24.00
3GPP Rel 6	HSUPA Subtest-2	21.21	21.22	21.45	22.00	20.51	20.68	20.93	22.00	20.73	20.76	20.92	22.00
3GPP Rel 6	HSUPA Subtest-3	22.20	22.16	22.37	23.00	21.50	21.78	21.94	23.00	21.79	21.75	21.88	23.00
3GPP Rel 6	HSUPA Subtest-4	21.22	21.20	21.27	22.00	20.50	20.77	20.97	22.00	20.79	20.83	20.97	22.00
3GPP Rel 6	HSUPA Subtest-5	23.40	23.27	23.47	24.00	22.55	22.76	22.94	24.00	22.68	22.70	22.82	24.00

Reduced Power Mode

Band		WCDMA II			Tune-up Limit (dBm)	WCDMA IV			Tune-up Limit (dBm)
TX Channel		9262	9400	9538		1312	1413	1513	
Rx Channel		9662	9800	9938	1537	1638	1738		
Frequency (MHz)		1852.4	1880	1907.6	1712.4	1732.6	1752.6		
3GPP Rel 99	AMR 12.2Kbps	19.20	19.16	19.37	20.00	18.58	18.85	19.13	20.00
3GPP Rel 99	RMC 12.2Kbps	19.22	19.18	19.39	20.00	18.59	18.85	19.15	20.00
3GPP Rel 6	HSDPA Subtest-1	18.37	18.13	18.48	19.00	17.51	17.76	18.00	19.00
3GPP Rel 6	HSDPA Subtest-2	18.26	18.15	18.49	19.00	17.60	17.86	18.08	19.00
3GPP Rel 6	HSDPA Subtest-3	17.81	17.70	17.93	18.50	17.12	17.38	17.53	18.50
3GPP Rel 6	HSDPA Subtest-4	17.77	17.70	17.94	18.50	17.12	17.38	17.52	18.50
3GPP Rel 8	DC-HSDPA Subtest-1	18.35	18.12	18.47	19.00	17.50	17.75	18.00	19.00
3GPP Rel 8	DC-HSDPA Subtest-2	18.25	18.13	18.47	19.00	17.59	17.85	18.06	19.00
3GPP Rel 8	DC-HSDPA Subtest-3	17.80	17.69	17.92	18.50	17.12	17.36	17.52	18.50
3GPP Rel 8	DC-HSDPA Subtest-4	17.76	17.69	17.92	18.50	17.12	17.36	17.51	18.50
3GPP Rel 6	HSUPA Subtest-1	18.20	18.17	18.38	19.00	17.51	17.79	18.02	19.00
3GPP Rel 6	HSUPA Subtest-2	16.31	16.19	16.45	17.00	15.61	15.89	16.13	17.00
3GPP Rel 6	HSUPA Subtest-3	17.35	17.20	17.46	18.00	16.59	16.77	17.09	18.00
3GPP Rel 6	HSUPA Subtest-4	16.40	16.17	16.50	17.00	15.66	15.84	16.15	17.00
3GPP Rel 6	HSUPA Subtest-5	18.25	18.11	18.42	19.00	17.53	17.79	18.05	19.00

<CDMA2000 Conducted Power>

1. Per KDB 941225 D01v03r01, SAR for head exposure is measured in RC3 with the handset configured to transmit at full rate in SO55.
2. Per KDB 941225 D01v03r01, in Hotspot mode EUT is treated as data device and SAR is tested with Ev-Do Rev 0 (RTAP 153.6kbps) as the primary mode.
3. Per KDB 941225 D01v03r01, for Body-worn accessory SAR is measured in RC3 with the handset configured in TDSO/SO32 to transmit at full rate on FCH only with all other code channels disabled. The body-worn accessory procedures in KDB Publication 447498 are applied. The 3G SAR test reduction procedure is applied to the multiple code channel configuration (FCH+SCH), with FCH only as the primary mode.

Default Power Mode

Band TX Channel	CDMA2000 BC0			Tune-up Limit (dBm)	CDMA2000 BC1			Tune-up Limit (dBm)	CDMA2000 BC10			Tune-up Limit (dBm)
	1013	384	777		25	600	1175		476	580	684	
Frequency (MHz)	824.7	836.52	848.31		1851.25	1880	1908.75		817.9	820.5	823.1	
RC1 SO55	24.06	23.86	24.12	25.50	24.51	24.50	24.77	25.50	23.91	24.01	24.03	25.50
RC3 SO55	24.12	23.88	24.15	25.50	24.57	24.58	24.83	25.50	23.99	24.08	24.18	25.50
RC3 SO32(F+SCH)	24.05	23.89	24.16	25.50	24.51	24.51	24.81	25.50	23.94	23.98	24.13	25.50
RC3 SO32(+SCH)	24.02	23.91	24.15	25.50	24.52	24.52	24.80	25.50	24.01	24.03	24.11	25.50
RTAP 153.6Kbps	23.96	23.78	24.17	25.50	24.50	24.52	24.71	25.50	24.26	24.48	24.12	25.50
RETAP 4096Bits	23.97	23.75	24.08	25.50	24.46	24.46	24.67	25.50	24.16	24.49	24.05	25.50

Reduced Power Mode

Band TX Channel	CDMA2000 BC1			Tune-up Limit (dBm)
	25	600	1175	
Frequency (MHz)	1851.25	1880	1908.75	
RC1 SO55	19.22	19.48	19.62	20.50
RC3 SO55	19.46	19.52	19.65	20.50
RC3 SO32(F+SCH)	19.45	19.50	19.65	20.50
RC3 SO32(+SCH)	19.37	19.50	19.70	20.50
RTAP 153.6Kbps	19.72	19.79	19.99	20.50
RETAP 4096Bits	19.75	19.81	19.98	20.50

**<LTE Conducted Power>****General Note:**

1. Anritsu MT8820C base station simulator was used to setup the connection with EUT; the frequency band, channel bandwidth, RB allocation configuration, modulation type are set in the base station simulator to configure EUT transmitting at maximum power and at different configurations which are requested to be reported to FCC, for conducted power measurement and SAR testing.
2. Per KDB 941225 D05v02r05, when a properly configured base station simulator is used for the SAR and power measurements, spectrum plots for each RB allocation and offset configuration is not required.
3. Per KDB 941225 D05v02r05, start with the largest channel bandwidth and measure SAR for QPSK with 1 RB allocation, using the RB offset and required test channel combination with the highest maximum output power for RB offsets at the upper edge, middle and lower edge of each required test channel.
4. Per KDB 941225 D05v02r05, 50% RB allocation for QPSK SAR testing follows 1RB QPSK allocation procedure.
5. Per KDB 941225 D05v02r05, For QPSK with 100% RB allocation, SAR is not required when the highest maximum output power for 100 % RB allocation is less than the highest maximum output power in 50% and 1 RB allocations and the highest reported SAR for 1 RB and 50% RB allocation are ≤ 0.8 W/kg. Otherwise, SAR is measured for the highest output power channel; and if the reported SAR is > 1.45 W/kg, the remaining required test channels must also be tested.
6. Per KDB 941225 D05v02r05, 16QAM output power for each RB allocation configuration is $>$ not $\frac{1}{2}$ dB higher than the same configuration in QPSK and the reported SAR for the QPSK configuration is ≤ 1.45 W/kg; Per KDB 941225 D05v02r05, 16QAM SAR testing is not required.
7. Per KDB 941225 D05v02r05, Smaller bandwidth output power for each RB allocation configuration is $>$ not $\frac{1}{2}$ dB higher than the same configuration in the largest supported bandwidth, and the reported SAR for the largest supported bandwidth is ≤ 1.45 W/kg; Per KDB 941225 D05v02r05, smaller bandwidth SAR testing is not required.
8. For LTE B4 / B12 / B26 the maximum bandwidth does not support three non-overlapping channels, per KDB 941225 D05v02r05, when a device supports overlapping channel assignment in a channel bandwidth configuration, the middle channel of the group of overlapping channels should be selected for testing.
9. LTE band 2 / 5 / 17 SAR test was covered by Band 25 / 26 / 12 ; according to April 2015 TCB workshop, SAR test for overlapping LTE bands can be reduced if
 - a. the maximum output power, including tolerance, for the smaller band is \leq the larger band to qualify for the SAR test exclusion
 - b. the channel bandwidth and other operating parameters for the smaller band are fully supported by the larger band



Default Power Mode

<LTE Band 2>

BW [MHz]	Modulation	RB Size	RB Offset	Power Low Ch. / Freq.	Power Middle Ch. / Freq.	Power High Ch. / Freq.	Tune-up limit (dBm)	MPR (dB)
Channel				18700	18900	19100		
Frequency (MHz)				1860	1880	1900		
20	QPSK	1	0	23.41	23.30	23.25	25	0
20	QPSK	1	49	23.42	23.31	23.45		
20	QPSK	1	99	23.16	23.12	23.43		
20	QPSK	50	0	22.40	22.39	22.62	24	1
20	QPSK	50	24	22.23	22.31	22.58		
20	QPSK	50	50	22.36	22.38	22.61		
20	QPSK	100	0	22.46	22.35	22.59	24	1
20	16QAM	1	0	22.27	22.17	22.35		
20	16QAM	1	49	22.25	22.30	22.41		
20	16QAM	1	99	22.07	21.92	22.46	23	2
20	16QAM	50	0	21.35	21.38	21.52		
20	16QAM	50	24	21.38	21.46	21.72		
20	16QAM	50	50	21.31	21.25	21.59	23	2
20	16QAM	100	0	21.50	21.30	21.57		
Channel				18675	18900	19125		
Frequency (MHz)				1857.5	1880	1902.5		
15	QPSK	1	0	23.23	23.33	23.45	25	0
15	QPSK	1	37	23.29	23.42	23.46		
15	QPSK	1	74	23.25	23.25	23.44		
15	QPSK	36	0	22.30	22.27	22.50	24	1
15	QPSK	36	20	22.22	22.35	22.51		
15	QPSK	36	39	22.28	22.32	22.49		
15	QPSK	75	0	22.34	22.25	22.54	24	1
15	16QAM	1	0	22.20	22.16	22.19		
15	16QAM	1	37	21.98	22.18	22.32		
15	16QAM	1	74	22.12	22.00	22.39	23	2
15	16QAM	36	0	21.36	21.28	21.54		
15	16QAM	36	20	21.19	21.27	21.53		
15	16QAM	36	39	21.25	21.22	21.58	23	2
15	16QAM	75	0	21.41	21.24	21.60		
Channel				18650	18900	19150		
Frequency (MHz)				1855	1880	1905		
10	QPSK	1	0	23.27	23.12	23.16	25	0
10	QPSK	1	25	23.17	23.30	23.31		
10	QPSK	1	49	22.88	23.37	23.24		
10	QPSK	25	0	22.25	22.26	22.46	24	1
10	QPSK	25	12	22.31	22.22	22.55		
10	QPSK	25	25	22.15	22.23	22.46		
10	QPSK	50	0	22.25	22.28	22.54	24	1
10	16QAM	1	0	22.18	22.15	22.35		
10	16QAM	1	25	22.00	22.38	22.43		
10	16QAM	1	49	21.93	22.08	22.37	23	2
10	16QAM	25	0	21.24	21.21	21.55		
10	16QAM	25	12	21.31	21.30	21.45		
10	16QAM	25	25	21.08	21.18	21.54	23	2
10	16QAM	50	0	21.15	21.19	21.54		



Channel				18625	18900	19175	Tune-up limit (dBm)	MPR (dB)
Frequency (MHz)				1852.5	1880	1907.5		
5	QPSK	1	0	23.11	23.21	23.44	25	0
5	QPSK	1	12	23.25	23.42	23.52		
5	QPSK	1	24	23.06	23.26	23.52		
5	QPSK	12	0	22.17	22.23	22.35	24	1
5	QPSK	12	7	22.21	22.22	22.38		
5	QPSK	12	13	22.19	22.18	22.50		
5	QPSK	25	0	22.19	22.19	22.44		
5	16QAM	1	0	21.50	22.00	22.23	24	1
5	16QAM	1	12	21.62	21.78	22.26		
5	16QAM	1	24	21.91	21.83	22.04		
5	16QAM	12	0	21.08	21.14	21.25	23	2
5	16QAM	12	7	21.22	21.03	21.27		
5	16QAM	12	13	20.96	21.19	21.22		
5	16QAM	25	0	21.27	21.44	21.47		
Channel				18615	18900	19185	Tune-up limit (dBm)	MPR (dB)
Frequency (MHz)				1851.5	1880	1908.5		
3	QPSK	1	0	23.45	23.35	23.74	25	0
3	QPSK	1	8	23.45	23.25	23.72		
3	QPSK	1	14	23.16	23.34	23.56		
3	QPSK	8	0	22.38	22.35	22.68	24	1
3	QPSK	8	4	22.24	22.31	22.64		
3	QPSK	8	7	22.25	22.35	22.67		
3	QPSK	15	0	22.30	22.30	22.56		
3	16QAM	1	0	21.99	22.22	22.49	24	1
3	16QAM	1	8	22.03	22.10	22.32		
3	16QAM	1	14	21.97	22.13	22.29		
3	16QAM	8	0	21.30	21.33	21.62	23	2
3	16QAM	8	4	21.54	21.25	21.39		
3	16QAM	8	7	21.30	21.28	21.82		
3	16QAM	15	0	21.09	21.25	21.49		
Channel				18607	18900	19193	Tune-up limit (dBm)	MPR (dB)
Frequency (MHz)				1850.7	1880	1909.3		
1.4	QPSK	1	0	23.29	23.33	23.57	25	0
1.4	QPSK	1	3	23.29	23.52	23.76		
1.4	QPSK	1	5	23.11	23.44	23.63		
1.4	QPSK	3	0	23.49	23.49	23.64		
1.4	QPSK	3	1	23.63	23.67	23.83		
1.4	QPSK	3	3	23.50	23.47	23.63		
1.4	QPSK	6	0	22.33	22.33	22.53	24	1
1.4	16QAM	1	0	22.26	22.27	22.47	24	1
1.4	16QAM	1	3	22.42	22.51	22.51		
1.4	16QAM	1	5	21.95	22.31	22.41		
1.4	16QAM	3	0	22.21	22.61	22.76		
1.4	16QAM	3	1	22.15	22.54	22.78		
1.4	16QAM	3	3	22.15	22.68	22.85		
1.4	16QAM	6	0	20.77	21.47	21.55	23	2



<LTE Band 4>

BW [MHz]	Modulation	RB Size	RB Offset	Power Low Ch. / Freq.	Power Middle Ch. / Freq.	Power High Ch. / Freq.	Tune-up limit (dBm)	MPR (dB)
Channel				20050	20175	20300		
Frequency (MHz)				1720	1732.5	1745		
20	QPSK	1	0	23.76	24.12	24.16	25	0
20	QPSK	1	49	23.75	23.93	24.15		
20	QPSK	1	99	23.71	24.10	24.05		
20	QPSK	50	0	22.86	22.84	23.18	24	1
20	QPSK	50	24	22.84	22.91	23.29		
20	QPSK	50	50	22.96	22.95	23.30		
20	QPSK	100	0	22.82	22.83	23.33		
20	16QAM	1	0	22.52	22.77	23.05	24	1
20	16QAM	1	49	22.73	22.71	23.20		
20	16QAM	1	99	22.65	22.87	23.23		
20	16QAM	50	0	21.81	21.87	22.31	23	2
20	16QAM	50	24	21.77	21.93	22.41		
20	16QAM	50	50	22.01	21.91	22.32		
20	16QAM	100	0	21.76	21.85	22.28		
Channel				20025	20175	20325		
Frequency (MHz)				1717.5	1732.5	1747.5		
15	QPSK	1	0	23.80	23.57	24.09	25	0
15	QPSK	1	37	24.18	24.11	24.32		
15	QPSK	1	74	23.82	23.94	24.34		
15	QPSK	36	0	22.78	22.86	23.26	24	1
15	QPSK	36	20	22.80	22.95	23.22		
15	QPSK	36	39	22.79	22.92	23.33		
15	QPSK	75	0	22.83	22.85	23.21		
15	16QAM	1	0	22.40	22.69	23.13	24	1
15	16QAM	1	37	22.65	22.63	23.28		
15	16QAM	1	74	22.73	22.80	23.25		
15	16QAM	36	0	21.73	21.80	22.23	23	2
15	16QAM	36	20	21.66	21.91	22.21		
15	16QAM	36	39	21.76	21.94	22.38		
15	16QAM	75	0	21.68	21.93	22.29		
Channel				20000	20175	20350		
Frequency (MHz)				1715	1732.5	1750		
10	QPSK	1	0	23.71	23.62	24.09	25	0
10	QPSK	1	25	23.97	23.91	24.24		
10	QPSK	1	49	23.52	24.03	24.14		
10	QPSK	25	0	22.75	22.83	23.28	24	1
10	QPSK	25	12	22.78	22.82	23.26		
10	QPSK	25	25	22.77	22.93	23.37		
10	QPSK	50	0	22.82	22.96	23.31		
10	16QAM	1	0	22.58	22.41	23.27	24	1
10	16QAM	1	25	22.86	22.91	23.48		
10	16QAM	1	49	22.56	22.72	23.30		
10	16QAM	25	0	21.79	21.77	22.35	23	2
10	16QAM	25	12	21.82	21.85	22.45		
10	16QAM	25	25	21.72	22.04	22.46		
10	16QAM	50	0	21.68	22.04	22.39		



Channel				19975	20175	20375	Tune-up limit (dBm)	MPR (dB)
Frequency (MHz)				1712.5	1732.5	1752.5		
5	QPSK	1	0	23.63	23.49	24.05	25	0
5	QPSK	1	12	24.16	24.12	24.16		
5	QPSK	1	24	23.60	23.84	24.23		
5	QPSK	12	0	22.73	22.73	23.37	24	1
5	QPSK	12	7	22.81	22.90	23.36		
5	QPSK	12	13	22.79	22.89	23.35		
5	QPSK	25	0	22.71	22.93	23.30		
5	16QAM	1	0	22.47	22.62	23.15	24	1
5	16QAM	1	12	22.38	22.33	23.21		
5	16QAM	1	24	22.51	22.65	23.19		
5	16QAM	12	0	21.64	21.94	22.34	23	2
5	16QAM	12	7	21.86	22.10	22.36		
5	16QAM	12	13	21.66	21.75	22.30		
5	16QAM	25	0	21.56	21.74	22.50		
Channel				19965	20175	20385	Tune-up limit (dBm)	MPR (dB)
Frequency (MHz)				1711.5	1732.5	1753.5		
3	QPSK	1	0	23.64	23.68	24.29	25	0
3	QPSK	1	8	23.63	23.85	24.21		
3	QPSK	1	14	23.42	23.89	24.04		
3	QPSK	8	0	22.68	22.75	23.15	24	1
3	QPSK	8	4	22.65	23.04	23.20		
3	QPSK	8	7	22.75	22.92	23.21		
3	QPSK	15	0	22.76	22.96	23.21		
3	16QAM	1	0	22.62	22.70	23.13	24	1
3	16QAM	1	8	22.56	22.67	23.00		
3	16QAM	1	14	22.59	22.79	23.10		
3	16QAM	8	0	21.62	21.53	22.31	23	2
3	16QAM	8	4	21.63	22.01	22.19		
3	16QAM	8	7	21.72	21.97	22.29		
3	16QAM	15	0	21.53	21.77	22.19		
Channel				19957	20175	20393	Tune-up limit (dBm)	MPR (dB)
Frequency (MHz)				1710.7	1732.5	1754.3		
1.4	QPSK	1	0	23.63	23.69	24.15	25	0
1.4	QPSK	1	3	23.72	23.78	24.11		
1.4	QPSK	1	5	23.61	23.63	24.20		
1.4	QPSK	3	0	23.81	23.88	24.12		
1.4	QPSK	3	1	23.74	24.03	24.25		
1.4	QPSK	3	3	23.79	23.94	24.23		
1.4	QPSK	6	0	22.67	22.89	23.09	24	1
1.4	16QAM	1	0	22.54	22.53	23.05	24	1
1.4	16QAM	1	3	22.68	23.16	23.29		
1.4	16QAM	1	5	22.56	22.73	23.13		
1.4	16QAM	3	0	22.67	22.77	23.04		
1.4	16QAM	3	1	22.64	22.80	23.16		
1.4	16QAM	3	3	22.61	23.05	23.13		
1.4	16QAM	6	0	21.42	21.70	22.02	23	2



<LTE Band 5>

BW [MHz]	Modulation	RB Size	RB Offset	Power Low Ch. / Freq.	Power Middle Ch. / Freq.	Power High Ch. / Freq.	Tune-up limit (dBm)	MPR (dB)
Channel				20450	20525	20600		
Frequency (MHz)				829	836.5	844		
10	QPSK	1	0	23.92	23.86	23.81	25	0
10	QPSK	1	25	23.96	23.91	23.89		
10	QPSK	1	49	23.92	23.90	23.80		
10	QPSK	25	0	22.95	22.96	22.89	24	1
10	QPSK	25	12	22.96	22.97	22.99		
10	QPSK	25	25	22.94	22.92	22.98		
10	QPSK	50	0	22.95	22.94	22.96	24	1
10	16QAM	1	0	22.67	22.68	22.65		
10	16QAM	1	25	22.86	22.99	22.87		
10	16QAM	1	49	22.76	22.67	22.87	23	2
10	16QAM	25	0	21.94	21.98	21.88		
10	16QAM	25	12	21.94	22.00	21.93		
10	16QAM	25	25	21.96	21.90	21.93		
10	16QAM	50	0	21.93	21.96	21.98		
Channel				20425	20525	20625	Tune-up limit (dBm)	MPR (dB)
Frequency (MHz)				826.5	836.5	846.5		
5	QPSK	1	0	23.73	23.87	23.82	25	0
5	QPSK	1	12	23.97	23.95	23.98		
5	QPSK	1	24	23.54	23.57	23.87		
5	QPSK	12	0	22.87	22.90	22.94	24	1
5	QPSK	12	7	22.96	22.96	22.99		
5	QPSK	12	13	22.93	22.88	22.97		
5	QPSK	25	0	22.91	22.92	22.92	24	1
5	16QAM	1	0	22.56	22.68	22.70		
5	16QAM	1	12	22.64	23.00	22.64		
5	16QAM	1	24	22.63	22.73	22.76	23	2
5	16QAM	12	0	21.82	21.98	21.95		
5	16QAM	12	7	21.97	21.94	21.93		
5	16QAM	12	13	21.90	21.81	21.87		
5	16QAM	25	0	21.91	21.96	21.82		
Channel				20415	20525	20635	Tune-up limit (dBm)	MPR (dB)
Frequency (MHz)				825.5	836.5	847.5		
3	QPSK	1	0	23.99	23.88	23.96	25	0
3	QPSK	1	8	23.72	23.90	23.86		
3	QPSK	1	14	23.63	23.60	23.79		
3	QPSK	8	0	22.86	22.96	22.98	24	1
3	QPSK	8	4	22.96	22.94	23.00		
3	QPSK	8	7	22.96	22.95	22.96		
3	QPSK	15	0	22.93	22.98	22.97	24	1
3	16QAM	1	0	22.77	22.85	22.88		
3	16QAM	1	8	22.68	22.69	22.88		
3	16QAM	1	14	22.57	22.68	22.94	23	2
3	16QAM	8	0	21.96	21.72	22.00		
3	16QAM	8	4	21.92	21.94	21.95		
3	16QAM	8	7	21.91	21.95	21.96		
3	16QAM	15	0	22.00	21.78	21.99		



Channel				20407	20525	20643	Tune-up limit (dBm)	MPR (dB)
Frequency (MHz)				824.7	836.5	848.3		
1.4	QPSK	1	0	23.83	23.95	23.93	25	0
1.4	QPSK	1	3	23.68	23.96	24.00		
1.4	QPSK	1	5	23.62	23.92	23.89		
1.4	QPSK	3	0	23.97	23.88	23.95		
1.4	QPSK	3	1	23.98	23.96	23.96		
1.4	QPSK	3	3	23.94	23.94	23.98		
1.4	QPSK	6	0	22.87	22.90	22.90	24	1
1.4	16QAM	1	0	22.59	22.80	22.95	24	1
1.4	16QAM	1	3	22.90	22.94	22.99		
1.4	16QAM	1	5	22.55	22.84	22.73		
1.4	16QAM	3	0	22.81	22.93	22.98		
1.4	16QAM	3	1	22.96	22.98	23.00		
1.4	16QAM	3	3	22.84	22.95	22.96		
1.4	16QAM	6	0	21.70	21.88	21.83	23	2



<LTE Band 12>

BW [MHz]	Modulation	RB Size	RB Offset	Power Low Ch. / Freq.	Power Middle Ch. / Freq.	Power High Ch. / Freq.	Tune-up limit (dBm)	MPR (dB)
Channel				23060	23095	23130		
Frequency (MHz)				704	707.5	711		
10	QPSK	1	0	23.87	24.18	23.96	25	0
10	QPSK	1	25	24.08	23.94	24.11		
10	QPSK	1	49	23.85	23.83	23.87		
10	QPSK	25	0	23.19	23.09	23.08	24	1
10	QPSK	25	12	23.09	23.02	23.12		
10	QPSK	25	25	23.07	23.08	23.03		
10	QPSK	50	0	23.09	23.11	23.12	24	1
10	16QAM	1	0	22.99	22.94	22.79		
10	16QAM	1	25	23.17	23.05	23.05		
10	16QAM	1	49	22.85	22.85	22.81	23	2
10	16QAM	25	0	22.30	22.11	22.20		
10	16QAM	25	12	22.43	22.19	22.34		
10	16QAM	25	25	22.14	22.17	22.02		
10	16QAM	50	0	22.17	22.18	22.13		
Channel				23035	23095	23155	Tune-up limit (dBm)	MPR (dB)
Frequency (MHz)				701.5	707.5	713.5		
5	QPSK	1	0	24.05	23.90	23.86	25	0
5	QPSK	1	12	24.06	24.16	24.14		
5	QPSK	1	24	23.89	23.86	23.70		
5	QPSK	12	0	23.20	23.03	23.06	24	1
5	QPSK	12	7	23.34	23.09	23.04		
5	QPSK	12	13	23.21	23.09	22.91		
5	QPSK	25	0	23.21	23.09	22.95	24	1
5	16QAM	1	0	23.05	23.14	22.74		
5	16QAM	1	12	23.03	23.11	23.04		
5	16QAM	1	24	22.93	22.76	22.59	23	2
5	16QAM	12	0	22.24	22.09	22.08		
5	16QAM	12	7	22.31	22.11	22.05		
5	16QAM	12	13	22.40	22.00	21.97		
5	16QAM	25	0	22.40	22.16	21.96		
Channel				23025	23095	23165	Tune-up limit (dBm)	MPR (dB)
Frequency (MHz)				700.5	707.5	714.5		
3	QPSK	1	0	23.90	23.96	23.90	25	0
3	QPSK	1	8	24.21	23.96	23.97		
3	QPSK	1	14	24.37	23.83	23.85		
3	QPSK	8	0	23.17	23.22	23.04	24	1
3	QPSK	8	4	23.32	23.09	23.02		
3	QPSK	8	7	23.31	23.05	23.05		
3	QPSK	15	0	23.24	23.08	23.02	24	1
3	16QAM	1	0	23.10	22.90	22.87		
3	16QAM	1	8	23.03	22.83	22.83		
3	16QAM	1	14	23.13	22.93	23.00	23	2
3	16QAM	8	0	22.40	22.14	22.10		
3	16QAM	8	4	22.41	22.03	22.07		
3	16QAM	8	7	22.43	22.17	22.18		
3	16QAM	15	0	22.36	21.99	22.15		



Channel				23017	23095	23173	Tune-up limit (dBm)	MPR (dB)
Frequency (MHz)				699.7	707.5	715.3		
1.4	QPSK	1	0	24.11	23.93	24.02	25	0
1.4	QPSK	1	3	24.37	23.93	24.11		
1.4	QPSK	1	5	24.30	23.90	24.11		
1.4	QPSK	3	0	24.22	24.21	24.17		
1.4	QPSK	3	1	24.26	24.19	24.13		
1.4	QPSK	3	3	24.29	24.31	24.19		
1.4	QPSK	6	0	23.19	22.94	22.98	24	1
1.4	16QAM	1	0	23.11	22.85	22.94	24	1
1.4	16QAM	1	3	23.25	22.98	23.07		
1.4	16QAM	1	5	23.16	22.84	22.95		
1.4	16QAM	3	0	23.44	22.94	22.99		
1.4	16QAM	3	1	23.41	23.13	23.03		
1.4	16QAM	3	3	23.50	23.13	23.00		
1.4	16QAM	6	0	22.21	22.18	22.14	23	2



<LTE Band 13>

BW [MHz]	Modulation	RB Size	RB Offset	Power Low Ch. / Freq.	Power Middle Ch. / Freq.	Power High Ch. / Freq.	Tune-up limit (dBm)	MPR (dB)
Channel				23230				
Frequency (MHz)				782				
10	QPSK	1	0	23.72			25	0
10	QPSK	1	25	24.03				
10	QPSK	1	49	23.86				
10	QPSK	25	0	22.84			24	1
10	QPSK	25	12	22.77				
10	QPSK	25	25	22.75				
10	QPSK	50	0	22.78				
10	16QAM	1	0	22.88			24	1
10	16QAM	1	25	22.78				
10	16QAM	1	49	22.64				
10	16QAM	25	0	22.19			23	2
10	16QAM	25	12	22.11				
10	16QAM	25	25	22.08				
10	16QAM	50	0	21.93				
Channel				23205	23230	23255	Tune-up limit (dBm)	MPR (dB)
Frequency (MHz)				779.5	782	784.5		
5	QPSK	1	0	23.92	23.68	23.43	25	0
5	QPSK	1	12	24.01	23.91	24.12		
5	QPSK	1	24	23.71	23.45	23.74		
5	QPSK	12	0	22.79	22.84	22.84	24	1
5	QPSK	12	7	22.89	22.78	22.74		
5	QPSK	12	13	22.78	22.76	22.82		
5	QPSK	25	0	22.86	22.76	22.77	24	1
5	16QAM	1	0	22.68	22.88	22.62		
5	16QAM	1	12	22.63	23.16	22.62		
5	16QAM	1	24	22.66	22.56	22.58	23	2
5	16QAM	12	0	21.78	21.90	21.90		
5	16QAM	12	7	22.05	21.93	21.95		
5	16QAM	12	13	21.85	21.73	21.93		
5	16QAM	25	0	21.93	21.92	21.83		



<LTE Band 17>

BW [MHz]	Modulation	RB Size	RB Offset	Power Low Ch. / Freq.	Power Middle Ch. / Freq.	Power High Ch. / Freq.	Tune-up limit (dBm)	MPR (dB)
Channel				23780	23790	23800		
Frequency (MHz)				709	710	711		
10	QPSK	1	0	23.88	23.86	23.70	25	0
10	QPSK	1	25	24.06	24.11	24.01		
10	QPSK	1	49	23.91	23.82	23.74		
10	QPSK	25	0	22.94	22.75	22.77	24	1
10	QPSK	25	12	22.92	22.83	22.84		
10	QPSK	25	25	22.90	22.85	22.80		
10	QPSK	50	0	22.87	22.82	22.83	24	1
10	16QAM	1	0	22.72	22.58	22.57		
10	16QAM	1	25	22.82	22.73	22.73		
10	16QAM	1	49	22.68	22.44	22.53	23	2
10	16QAM	25	0	22.00	21.83	21.66		
10	16QAM	25	12	22.08	21.80	21.96		
10	16QAM	25	25	21.95	21.96	22.00	23	2
10	16QAM	50	0	21.82	21.89	21.79		
Channel				23755	23790	23825		
Frequency (MHz)				706.5	710	713.5		
5	QPSK	1	0	23.83	23.76	23.66	25	0
5	QPSK	1	12	23.90	23.88	23.76		
5	QPSK	1	24	23.67	23.71	23.65		
5	QPSK	12	0	22.83	22.76	22.70	24	1
5	QPSK	12	7	22.94	22.80	22.79		
5	QPSK	12	13	22.88	22.80	22.68		
5	QPSK	25	0	22.85	22.76	22.70	24	1
5	16QAM	1	0	22.57	22.53	22.41		
5	16QAM	1	12	22.56	22.51	22.54		
5	16QAM	1	24	22.47	22.49	22.52	23	2
5	16QAM	12	0	21.84	21.56	21.90		
5	16QAM	12	7	21.72	21.76	21.73		
5	16QAM	12	13	21.75	21.86	21.62	23	2
5	16QAM	25	0	21.73	22.02	21.81		



<LTE Band 25>

BW [MHz]	Modulation	RB Size	RB Offset	Power Low Ch. / Freq.	Power Middle Ch. / Freq.	Power High Ch. / Freq.	Tune-up limit (dBm)	MPR (dB)
Channel				26140	26340	26590		
Frequency (MHz)				1860	1880	1905		
20	QPSK	1	0	23.40	23.21	23.50	25	0
20	QPSK	1	49	23.54	23.27	23.60		
20	QPSK	1	99	23.53	23.24	23.58		
20	QPSK	50	0	22.52	22.42	22.67	24	1
20	QPSK	50	24	22.52	22.43	22.71		
20	QPSK	50	50	22.53	22.53	22.73		
20	QPSK	100	0	22.50	22.41	22.74		
20	16QAM	1	0	22.28	22.32	22.41	24	1
20	16QAM	1	49	22.25	22.20	22.54		
20	16QAM	1	99	22.17	22.29	22.55		
20	16QAM	50	0	21.58	21.22	21.63	23	2
20	16QAM	50	24	21.47	21.21	21.78		
20	16QAM	50	50	21.58	21.47	21.63		
20	16QAM	100	0	21.44	21.25	21.70		
Channel				26115	26340	26615		
Frequency (MHz)				1857.5	1880	1907.5		
15	QPSK	1	0	23.45	23.25	23.43	25	0
15	QPSK	1	37	23.57	23.38	23.75		
15	QPSK	1	74	23.38	23.55	23.76		
15	QPSK	36	0	22.48	22.32	22.62	24	1
15	QPSK	36	20	22.38	22.41	22.71		
15	QPSK	36	39	22.44	22.41	22.70		
15	QPSK	75	0	22.39	22.35	22.69		
15	16QAM	1	0	22.30	22.21	22.47	24	1
15	16QAM	1	37	22.12	22.10	22.42		
15	16QAM	1	74	22.21	22.21	22.46		
15	16QAM	36	0	21.45	21.26	21.54	23	2
15	16QAM	36	20	21.33	21.30	21.64		
15	16QAM	36	39	21.29	21.20	21.61		
15	16QAM	75	0	21.37	21.23	21.68		
Channel				26090	26340	26640		
Frequency (MHz)				1855	1880	1910		
10	QPSK	1	0	23.49	23.25	23.40	25	0
10	QPSK	1	25	23.38	23.41	23.50		
10	QPSK	1	49	22.96	23.09	23.43		
10	QPSK	25	0	22.36	22.25	22.62	24	1
10	QPSK	25	12	22.41	22.35	22.71		
10	QPSK	25	25	22.29	22.29	22.66		
10	QPSK	50	0	22.32	22.28	22.62		
10	16QAM	1	0	22.18	22.11	22.45	24	1
10	16QAM	1	25	22.31	22.27	22.65		
10	16QAM	1	49	22.06	22.18	22.55		
10	16QAM	25	0	21.30	21.33	21.58	23	2
10	16QAM	25	12	21.40	21.28	21.60		
10	16QAM	25	25	21.24	21.24	21.65		
10	16QAM	50	0	21.28	21.07	21.61		



Channel				26065	26340	26665	Tune-up limit (dBm)	MPR (dB)
Frequency (MHz)				1852.5	1880	1912.5		
5	QPSK	1	0	22.97	23.15	23.36	25	0
5	QPSK	1	12	23.21	23.43	23.69		
5	QPSK	1	24	22.98	22.87	23.50		
5	QPSK	12	0	22.31	22.27	22.61	24	1
5	QPSK	12	7	22.35	22.20	22.61		
5	QPSK	12	13	22.31	22.24	22.67		
5	QPSK	25	0	22.38	22.23	22.68		
5	16QAM	1	0	22.06	21.98	22.38	24	1
5	16QAM	1	12	22.25	21.88	22.41		
5	16QAM	1	24	22.00	21.93	22.38		
5	16QAM	12	0	21.17	21.11	21.44	23	2
5	16QAM	12	7	21.26	21.23	21.61		
5	16QAM	12	13	21.05	21.05	21.45		
5	16QAM	25	0	21.17	21.22	21.57		
Channel				26055	26340	26675	Tune-up limit (dBm)	MPR (dB)
Frequency (MHz)				1851.5	1880	1913.5		
3	QPSK	1	0	23.29	23.08	23.58	25	0
3	QPSK	1	8	23.16	23.21	23.85		
3	QPSK	1	14	22.99	22.94	23.71		
3	QPSK	8	0	22.34	22.26	22.60	24	1
3	QPSK	8	4	22.39	22.43	22.62		
3	QPSK	8	7	22.35	22.43	22.68		
3	QPSK	15	0	22.35	22.34	22.66		
3	16QAM	1	0	22.18	22.17	22.53	24	1
3	16QAM	1	8	22.06	22.05	22.43		
3	16QAM	1	14	21.90	22.17	22.55		
3	16QAM	8	0	21.26	21.24	21.64	23	2
3	16QAM	8	4	21.21	21.17	21.84		
3	16QAM	8	7	21.54	21.31	21.71		
3	16QAM	15	0	21.33	21.15	21.74		
Channel				26047	26340	26683	Tune-up limit (dBm)	MPR (dB)
Frequency (MHz)				1850.7	1880	1914.3		
1.4	QPSK	1	0	23.39	23.18	23.53	25	0
1.4	QPSK	1	3	23.46	23.17	23.60		
1.4	QPSK	1	5	23.39	23.32	23.67		
1.4	QPSK	3	0	23.51	23.48	23.80		
1.4	QPSK	3	1	23.69	23.40	23.81		
1.4	QPSK	3	3	23.53	23.48	23.84		
1.4	QPSK	6	0	22.37	22.46	22.59	24	1
1.4	16QAM	1	0	22.24	22.17	22.47	24	1
1.4	16QAM	1	3	22.38	22.38	22.61		
1.4	16QAM	1	5	22.21	22.20	22.53		
1.4	16QAM	3	0	22.63	22.57	22.53		
1.4	16QAM	3	1	22.64	22.68	22.86		
1.4	16QAM	3	3	22.71	22.26	22.95		
1.4	16QAM	6	0	21.22	21.33	21.61	23	2



<LTE Band 26>

BW [MHz]	Modulation	RB Size	RB Offset	Power Low Ch. / Freq.	Power Middle Ch. / Freq.	Power High Ch. / Freq.	Tune-up limit (dBm)	MPR (dB)
Channel				26765	26865	26965		
Frequency (MHz)				821.5	831.5	841.5		
15	QPSK	1	0	23.65	23.53	23.70	25	0
15	QPSK	1	37	23.83	24.15	24.13		
15	QPSK	1	74	23.65	23.99	23.83		
15	QPSK	36	0	22.75	22.99	22.99	24	1
15	QPSK	36	20	22.74	22.97	22.98		
15	QPSK	36	39	22.71	22.99	22.98		
15	QPSK	75	0	22.82	22.98	22.95	24	1
15	16QAM	1	0	22.48	22.55	22.66		
15	16QAM	1	37	22.85	22.90	22.84		
15	16QAM	1	74	22.67	22.78	22.75	23	2
15	16QAM	36	0	21.72	22.03	22.24		
15	16QAM	36	20	21.85	22.00	22.03		
15	16QAM	36	39	21.85	21.90	22.01		
15	16QAM	75	0	21.64	21.86	22.08		
Channel				26740	26865	26990	Tune-up limit (dBm)	MPR (dB)
Frequency (MHz)				819	831.5	844		
10	QPSK	1	0	23.65	23.53	23.70	25	0
10	QPSK	1	25	23.83	24.15	24.13		
10	QPSK	1	49	23.65	24.24	23.83		
10	QPSK	25	0	22.73	22.99	22.99	24	1
10	QPSK	25	12	22.81	22.97	22.99		
10	QPSK	25	25	22.83	22.99	22.98		
10	QPSK	50	0	22.82	22.98	22.95	24	1
10	16QAM	1	0	22.48	22.55	22.66		
10	16QAM	1	25	22.85	22.90	22.84		
10	16QAM	1	49	22.67	22.78	22.75	23	2
10	16QAM	25	0	21.72	22.03	22.24		
10	16QAM	25	12	21.85	22.00	22.03		
10	16QAM	25	25	21.85	21.90	22.01		
10	16QAM	50	0	21.64	21.86	22.08		
Channel				26715	26865	27015	Tune-up limit (dBm)	MPR (dB)
Frequency (MHz)				816.5	831.5	846.5		
5	QPSK	1	0	23.23	23.59	23.45	25	0
5	QPSK	1	12	23.86	24.28	24.11		
5	QPSK	1	24	23.47	24.06	23.61		
5	QPSK	12	0	22.67	22.84	22.93	24	1
5	QPSK	12	7	22.73	22.88	22.87		
5	QPSK	12	13	22.80	22.97	22.93		
5	QPSK	25	0	22.66	22.93	22.90	24	1
5	16QAM	1	0	22.69	22.55	22.53		
5	16QAM	1	12	22.45	22.58	22.68		
5	16QAM	1	24	22.55	22.65	22.61	23	2
5	16QAM	12	0	21.45	21.86	21.93		
5	16QAM	12	7	21.50	22.12	22.12		
5	16QAM	12	13	21.65	22.00	21.82		
5	16QAM	25	0	21.71	21.95	21.92		



Channel				26705	26865	27025	Tune-up limit (dBm)	MPR (dB)
Frequency (MHz)				815.5	831.5	847.5		
3	QPSK	1	0	23.36	23.70	23.83	25	0
3	QPSK	1	8	23.56	23.80	23.64		
3	QPSK	1	14	23.33	24.11	24.02		
3	QPSK	8	0	22.82	22.97	23.00	24	1
3	QPSK	8	4	22.79	22.94	23.00		
3	QPSK	8	7	22.70	22.95	22.97		
3	QPSK	15	0	22.75	22.93	22.94		
3	16QAM	1	0	22.35	22.99	22.77	24	1
3	16QAM	1	8	22.42	22.62	22.77		
3	16QAM	1	14	22.57	22.73	22.84		
3	16QAM	8	0	21.71	21.60	22.01	23	2
3	16QAM	8	4	21.69	22.12	21.96		
3	16QAM	8	7	21.79	22.04	22.07		
3	16QAM	15	0	21.60	21.95	21.90		
Channel				26697	26865	27033	Tune-up limit (dBm)	MPR (dB)
Frequency (MHz)				814.7	831.5	848.3		
1.4	QPSK	1	0	23.39	23.92	23.94	25	0
1.4	QPSK	1	3	23.44	23.99	23.87		
1.4	QPSK	1	5	23.68	23.94	23.93		
1.4	QPSK	3	0	23.59	23.97	23.92		
1.4	QPSK	3	1	23.89	24.13	24.00		
1.4	QPSK	3	3	23.71	24.11	24.09		
1.4	QPSK	6	0	22.71	22.93	22.91	24	1
1.4	16QAM	1	0	22.52	22.73	22.82	24	1
1.4	16QAM	1	3	22.68	22.84	23.08		
1.4	16QAM	1	5	22.52	22.69	22.88		
1.4	16QAM	3	0	22.76	23.08	23.13		
1.4	16QAM	3	1	22.74	22.97	22.93		
1.4	16QAM	3	3	22.75	22.88	22.81		
1.4	16QAM	6	0	21.59	21.65	22.03	23	2



Reduced Power Mode

<LTE Band 2>

BW [MHz]	Modulation	RB Size	RB Offset	Power Low Ch. / Freq.	Power Middle Ch. / Freq.	Power High Ch. / Freq.	Tune-up limit (dBm)	MPR (dB)
Channel				18700	18900	19100		
Frequency (MHz)				1860	1880	1900		
20	QPSK	1	0	17.91	18.03	18.08	19	0
20	QPSK	1	49	18.29	18.28	18.65		
20	QPSK	1	99	17.78	17.74	18.31		
20	QPSK	50	0	17.31	17.19	17.39	18	1
20	QPSK	50	24	17.12	17.18	17.38		
20	QPSK	50	50	17.12	17.15	17.34		
20	QPSK	100	0	17.21	17.18	17.34	18	1
20	16QAM	1	0	17.04	16.98	17.14		
20	16QAM	1	49	16.98	17.05	17.20		
20	16QAM	1	99	16.77	16.88	17.11	17	2
20	16QAM	50	0	16.06	16.20	16.40		
20	16QAM	50	24	16.17	16.06	16.27		
20	16QAM	50	50	16.16	16.05	16.34	17	2
20	16QAM	100	0	16.24	16.15	16.38		
Channel				18675	18900	19125		
Frequency (MHz)				1857.5	1880	1902.5		
15	QPSK	1	0	18.41	18.06	18.28	19	0
15	QPSK	1	37	18.36	18.36	18.66		
15	QPSK	1	74	17.79	18.13	18.23		
15	QPSK	36	0	17.24	17.21	17.39	18	1
15	QPSK	36	20	17.13	17.19	17.41		
15	QPSK	36	39	17.10	17.32	17.48		
15	QPSK	75	0	17.26	17.18	17.41	18	1
15	16QAM	1	0	17.03	17.01	17.20		
15	16QAM	1	37	16.87	16.92	17.21		
15	16QAM	1	74	16.91	16.97	17.15	17	2
15	16QAM	36	0	16.18	16.17	16.33		
15	16QAM	36	20	16.04	16.26	16.37		
15	16QAM	36	39	16.05	16.11	16.35	17	2
15	16QAM	75	0	16.18	16.03	16.38		
Channel				18650	18900	19150		
Frequency (MHz)				1855	1880	1905		
10	QPSK	1	0	18.22	17.95	18.06	19	0
10	QPSK	1	25	18.19	18.41	18.56		
10	QPSK	1	49	17.82	17.83	18.04		
10	QPSK	25	0	17.24	17.23	17.41	18	1
10	QPSK	25	12	17.23	17.24	17.48		
10	QPSK	25	25	17.13	17.16	17.37		
10	QPSK	50	0	17.22	17.19	17.43	18	1
10	16QAM	1	0	17.02	17.00	17.20		
10	16QAM	1	25	17.21	17.18	17.42		
10	16QAM	1	49	16.92	16.99	17.17	17	2
10	16QAM	25	0	16.34	16.29	16.52		
10	16QAM	25	12	16.28	16.31	16.43		
10	16QAM	25	25	16.13	16.17	16.41	17	2
10	16QAM	50	0	16.06	16.25	16.38		



Channel				18625	18900	19175	Tune-up limit (dBm)	MPR (dB)
Frequency (MHz)				1852.5	1880	1907.5		
5	QPSK	1	0	18.07	17.87	18.09	19	0
5	QPSK	1	12	18.18	18.31	18.29		
5	QPSK	1	24	17.78	17.78	18.04		
5	QPSK	12	0	17.19	17.22	17.38	18	1
5	QPSK	12	7	17.17	17.28	17.42		
5	QPSK	12	13	17.20	17.15	17.39		
5	QPSK	25	0	17.24	17.23	17.40		
5	16QAM	1	0	16.96	17.00	17.17	18	1
5	16QAM	1	12	16.86	16.83	17.09		
5	16QAM	1	24	16.90	16.80	17.17		
5	16QAM	12	0	16.35	16.09	16.52	17	2
5	16QAM	12	7	16.03	16.15	16.37		
5	16QAM	12	13	16.12	16.09	16.26		
5	16QAM	25	0	16.20	16.20	16.36		
Channel				18615	18900	19185	Tune-up limit (dBm)	MPR (dB)
Frequency (MHz)				1851.5	1880	1908.5		
3	QPSK	1	0	18.09	18.07	18.60	19	0
3	QPSK	1	8	17.96	18.06	18.32		
3	QPSK	1	14	17.88	17.85	18.26		
3	QPSK	8	0	17.29	17.40	17.41	18	1
3	QPSK	8	4	17.26	17.21	17.42		
3	QPSK	8	7	17.26	17.26	17.51		
3	QPSK	15	0	17.24	17.24	17.44		
3	16QAM	1	0	17.05	17.10	17.27	18	1
3	16QAM	1	8	16.92	17.03	17.17		
3	16QAM	1	14	16.89	17.07	17.29		
3	16QAM	8	0	16.04	15.92	16.67	17	2
3	16QAM	8	4	16.23	16.14	16.53		
3	16QAM	8	7	16.28	16.19	16.43		
3	16QAM	15	0	16.26	16.08	16.54		
Channel				18607	18900	19193	Tune-up limit (dBm)	MPR (dB)
Frequency (MHz)				1850.7	1880	1909.3		
1.4	QPSK	1	0	17.47	17.46	17.80	19	0
1.4	QPSK	1	3	17.49	17.43	17.85		
1.4	QPSK	1	5	17.59	17.41	17.81		
1.4	QPSK	3	0	17.63	17.67	17.86		
1.4	QPSK	3	1	17.53	17.75	17.87		
1.4	QPSK	3	3	17.67	17.63	17.95		
1.4	QPSK	6	0	17.56	16.56	16.89	18	1
1.4	16QAM	1	0	16.39	16.46	16.64	18	1
1.4	16QAM	1	3	16.51	16.55	16.83		
1.4	16QAM	1	5	16.63	16.19	16.69		
1.4	16QAM	3	0	16.58	16.61	17.03		
1.4	16QAM	3	1	16.58	16.63	17.04		
1.4	16QAM	3	3	16.70	16.59	17.01		
1.4	16QAM	6	0	15.54	15.52	15.83	17	2



<LTE Band 4>

BW [MHz]	Modulation	RB Size	RB Offset	Power Low Ch. / Freq.	Power Middle Ch. / Freq.	Power High Ch. / Freq.	Tune-up limit (dBm)	MPR (dB)
Channel				20050	20175	20300		
Frequency (MHz)				1720	1732.5	1745		
20	QPSK	1	0	20.19	20.64	20.67	21.5	0
20	QPSK	1	49	20.57	20.91	21.29		
20	QPSK	1	99	20.52	20.84	20.66		
20	QPSK	50	0	19.60	19.69	19.95	20.5	1
20	QPSK	50	24	19.56	19.58	20.04		
20	QPSK	50	50	19.61	19.73	20.05		
20	QPSK	100	0	19.59	19.57	20.06	20.5	1
20	16QAM	1	0	19.26	19.47	19.74		
20	16QAM	1	49	19.35	19.37	19.90		
20	16QAM	1	99	19.31	19.51	19.79	19.5	2
20	16QAM	50	0	18.72	18.71	18.97		
20	16QAM	50	24	18.65	18.72	19.18		
20	16QAM	50	50	18.71	18.82	18.98		
20	16QAM	100	0	18.60	18.70	19.13		
Channel				20025	20175	20325		
Frequency (MHz)				1717.5	1732.5	1747.5		
15	QPSK	1	0	20.43	20.60	20.87	21.5	0
15	QPSK	1	37	20.91	20.90	21.15		
15	QPSK	1	74	20.53	20.74	20.96		
15	QPSK	36	0	19.58	19.63	20.08	20.5	1
15	QPSK	36	20	19.55	19.72	20.06		
15	QPSK	36	39	19.62	19.75	20.11		
15	QPSK	75	0	19.52	19.67	20.11	20.5	1
15	16QAM	1	0	19.18	19.37	19.85		
15	16QAM	1	37	19.31	19.35	19.89		
15	16QAM	1	74	19.39	19.46	19.86	19.5	2
15	16QAM	36	0	18.65	18.59	19.11		
15	16QAM	36	20	18.57	18.77	19.12		
15	16QAM	36	39	18.59	18.76	19.06		
15	16QAM	75	0	18.65	18.68	19.06		
Channel				20000	20175	20350		
Frequency (MHz)				1715	1732.5	1750		
10	QPSK	1	0	20.29	20.54	20.79	21.5	0
10	QPSK	1	25	20.70	20.86	21.04		
10	QPSK	1	49	20.25	20.57	20.84		
10	QPSK	25	0	19.57	19.61	20.06	20.5	1
10	QPSK	25	12	19.54	19.67	20.06		
10	QPSK	25	25	19.52	19.70	20.09		
10	QPSK	50	0	19.55	19.72	20.10	20.5	1
10	16QAM	1	0	19.31	19.32	20.21		
10	16QAM	1	25	19.46	19.64	20.03		
10	16QAM	1	49	19.26	19.39	19.85	19.5	2
10	16QAM	25	0	18.60	18.93	19.10		
10	16QAM	25	12	18.61	18.81	19.05		
10	16QAM	25	25	18.54	18.71	19.13		
10	16QAM	50	0	18.52	18.85	18.95		



Channel				19975	20175	20375	Tune-up limit (dBm)	MPR (dB)
Frequency (MHz)				1712.5	1732.5	1752.5		
5	QPSK	1	0	20.13	20.49	20.72	21.5	0
5	QPSK	1	12	20.53	20.85	21.28		
5	QPSK	1	24	20.21	20.49	20.73		
5	QPSK	12	0	19.53	19.66	20.21	20.5	1
5	QPSK	12	7	19.53	19.77	20.20		
5	QPSK	12	13	19.46	19.74	20.13		
5	QPSK	25	0	19.52	19.82	20.19		
5	16QAM	1	0	19.19	19.38	19.81	20.5	1
5	16QAM	1	12	19.22	19.64	20.09		
5	16QAM	1	24	19.21	19.47	19.87		
5	16QAM	12	0	18.48	18.68	19.15	19.5	2
5	16QAM	12	7	18.66	18.89	19.25		
5	16QAM	12	13	18.60	18.86	19.12		
5	16QAM	25	0	18.60	18.79	19.11		
Channel				19965	20175	20385	Tune-up limit (dBm)	MPR (dB)
Frequency (MHz)				1711.5	1732.5	1753.5		
3	QPSK	1	0	20.40	20.53	20.84	21.5	0
3	QPSK	1	8	20.33	20.57	20.80		
3	QPSK	1	14	20.44	20.68	20.62		
3	QPSK	8	0	19.60	19.70	20.06	20.5	1
3	QPSK	8	4	19.58	19.84	20.10		
3	QPSK	8	7	19.57	19.84	20.06		
3	QPSK	15	0	19.53	19.81	20.06		
3	16QAM	1	0	19.37	19.50	19.84	20.5	1
3	16QAM	1	8	19.26	19.45	19.75		
3	16QAM	1	14	19.37	19.56	19.84		
3	16QAM	8	0	18.33	18.89	19.17	19.5	2
3	16QAM	8	4	18.60	18.91	19.12		
3	16QAM	8	7	18.64	18.88	19.04		
3	16QAM	15	0	18.57	18.64	19.15		
Channel				19957	20175	20393	Tune-up limit (dBm)	MPR (dB)
Frequency (MHz)				1710.7	1732.5	1754.3		
1.4	QPSK	1	0	19.69	19.97	20.15	21.5	0
1.4	QPSK	1	3	19.79	20.14	20.29		
1.4	QPSK	1	5	19.59	20.12	20.27		
1.4	QPSK	3	0	19.96	20.03	20.42		
1.4	QPSK	3	1	19.94	20.01	20.41		
1.4	QPSK	3	3	19.92	20.24	20.46		
1.4	QPSK	6	0	18.86	19.25	19.45	20.5	1
1.4	16QAM	1	0	18.66	18.82	19.32	20.5	1
1.4	16QAM	1	3	18.82	19.01	19.29		
1.4	16QAM	1	5	18.68	18.88	19.17		
1.4	16QAM	3	0	18.78	18.87	19.41		
1.4	16QAM	3	1	18.85	18.94	19.37		
1.4	16QAM	3	3	18.89	19.01	19.37		
1.4	16QAM	6	0	17.95	18.08	18.34		



<LTE Band 25>

BW [MHz]	Modulation	RB Size	RB Offset	Power Low Ch. / Freq.	Power Middle Ch. / Freq.	Power High Ch. / Freq.	Tune-up limit (dBm)	MPR (dB)
Channel				26140	26340	26590		
Frequency (MHz)				1860	1880	1905		
20	QPSK	1	0	18.04	18.01	18.01		
20	QPSK	1	49	18.25	18.02	18.48	19	0
20	QPSK	1	99	18.01	17.92	18.15		
20	QPSK	50	0	17.29	17.21	17.44		
20	QPSK	50	24	17.28	17.21	17.54	18	1
20	QPSK	50	50	17.30	17.29	17.55		
20	QPSK	100	0	17.28	17.15	17.51		
20	16QAM	1	0	17.15	17.10	17.17	18	1
20	16QAM	1	49	17.09	16.98	17.33		
20	16QAM	1	99	16.89	17.06	17.26		
20	16QAM	50	0	16.26	16.27	16.41	17	2
20	16QAM	50	24	16.33	16.07	16.51		
20	16QAM	50	50	16.25	16.16	16.48		
20	16QAM	100	0	16.22	16.11	16.45		
Channel				26115	26340	26615	Tune-up limit (dBm)	MPR (dB)
Frequency (MHz)				1857.5	1880	1907.5		
15	QPSK	1	0	18.44	18.14	18.32	19	0
15	QPSK	1	37	18.36	18.10	18.68		
15	QPSK	1	74	17.90	18.32	18.50		
15	QPSK	36	0	17.35	17.24	17.50	18	1
15	QPSK	36	20	17.20	17.25	17.51		
15	QPSK	36	39	17.22	17.22	17.49		
15	QPSK	75	0	17.26	17.19	17.50		
15	16QAM	1	0	17.16	17.07	17.35	18	1
15	16QAM	1	37	16.97	16.94	17.15		
15	16QAM	1	74	17.03	17.07	17.25		
15	16QAM	36	0	16.30	16.14	16.45	17	2
15	16QAM	36	20	16.15	16.10	16.47		
15	16QAM	36	39	16.27	16.09	16.36		
15	16QAM	75	0	16.11	16.14	16.49		
Channel				26090	26340	26640	Tune-up limit (dBm)	MPR (dB)
Frequency (MHz)				1855	1880	1910		
10	QPSK	1	0	18.18	18.20	18.42	19	0
10	QPSK	1	25	18.14	18.18	18.59		
10	QPSK	1	49	17.89	18.20	18.24		
10	QPSK	25	0	17.35	17.25	17.53	18	1
10	QPSK	25	12	17.35	17.23	17.54		
10	QPSK	25	25	17.23	17.23	17.55		
10	QPSK	50	0	17.32	17.22	17.55		
10	16QAM	1	0	17.19	17.26	17.37	18	1
10	16QAM	1	25	17.28	17.22	17.49		
10	16QAM	1	49	17.02	17.09	17.32		
10	16QAM	25	0	16.38	16.31	16.59	17	2
10	16QAM	25	12	16.26	16.38	16.60		
10	16QAM	25	25	16.07	16.10	16.52		
10	16QAM	50	0	16.35	16.10	16.32		



Channel				26065	26340	26665	Tune-up limit (dBm)	MPR (dB)
Frequency (MHz)				1852.5	1880	1912.5		
5	QPSK	1	0	17.98	18.06	18.39	19	0
5	QPSK	1	12	18.31	18.33	18.88		
5	QPSK	1	24	17.93	17.82	18.64		
5	QPSK	12	0	17.32	17.28	17.60	18	1
5	QPSK	12	7	17.30	17.25	17.63		
5	QPSK	12	13	17.30	17.21	17.58		
5	QPSK	25	0	17.35	17.22	17.57		
5	16QAM	1	0	17.03	16.97	17.31	18	1
5	16QAM	1	12	16.96	17.12	17.26		
5	16QAM	1	24	17.05	16.94	17.36		
5	16QAM	12	0	16.17	16.16	16.53	17	2
5	16QAM	12	7	16.36	16.23	16.70		
5	16QAM	12	13	16.19	16.19	16.55		
5	16QAM	25	0	16.24	16.18	16.58		
Channel				26055	26340	26675	Tune-up limit (dBm)	MPR (dB)
Frequency (MHz)				1851.5	1880	1913.5		
3	QPSK	1	0	18.30	18.05	18.39	19	0
3	QPSK	1	8	18.14	18.11	18.54		
3	QPSK	1	14	17.94	17.84	18.46		
3	QPSK	8	0	17.46	17.35	17.66	18	1
3	QPSK	8	4	17.38	17.31	17.60		
3	QPSK	8	7	17.38	17.32	17.64		
3	QPSK	15	0	17.33	17.34	17.61		
3	16QAM	1	0	17.04	17.16	17.49	18	1
3	16QAM	1	8	17.06	17.00	17.32		
3	16QAM	1	14	17.16	17.02	17.49		
3	16QAM	8	0	16.47	16.27	16.65	17	2
3	16QAM	8	4	16.26	16.37	16.63		
3	16QAM	8	7	16.34	16.26	16.72		
3	16QAM	15	0	16.34	16.13	16.59		
Channel				26047	26340	26683	Tune-up limit (dBm)	MPR (dB)
Frequency (MHz)				1850.7	1880	1914.3		
1.4	QPSK	1	0	17.48	17.51	17.63	19	0
1.4	QPSK	1	3	17.71	17.54	17.78		
1.4	QPSK	1	5	17.65	17.51	17.59		
1.4	QPSK	3	0	17.75	17.61	17.89		
1.4	QPSK	3	1	17.95	17.58	17.91		
1.4	QPSK	3	3	17.73	17.70	17.95		
1.4	QPSK	6	0	16.62	16.52	16.75	18	1
1.4	16QAM	1	0	16.49	16.42	16.64	18	1
1.4	16QAM	1	3	16.66	16.55	16.82		
1.4	16QAM	1	5	16.50	16.20	16.63		
1.4	16QAM	3	0	16.91	16.53	16.78		
1.4	16QAM	3	1	17.03	16.43	16.78		
1.4	16QAM	3	3	16.55	16.41	16.62		
1.4	16QAM	6	0	15.73	15.66	15.59	17	2

**<WLAN Conducted Power>****General Note:**

1. For each antenna, transmit power in SISO operation is larger than (or equal to) the power in MIMO operation, RF exposure compliance of MIMO mode can be deduced from the compliance simultaneous transmission of antennas operating in SISO mode.
2. Per KDB 248227 D01v02r02, the simultaneous SAR provisions in KDB publication 447498 should be applied to determine simultaneous transmission SAR test exclusion for WiFi MIMO. If the sum of 1g single transmission chain SAR measurements is $< 1.6\text{W/kg}$ and SAR peak to location ratio ≤ 0.04 , no additional SAR measurements for MIMO.
3. Per KDB 248227 D01v02r02, SAR test reduction is determined according to 802.11 transmission mode configurations and certain exposure conditions with multiple test positions. In the 2.4 GHz band, separate SAR procedures are applied to DSSS and OFDM configurations to simplify DSSS test requirements. For OFDM, in both 2.4 and 5 GHz bands, an initial test configuration must be determined for each standalone and aggregated frequency band, according to the transmission mode configuration with the highest maximum output power specified for production units to perform SAR measurements. If the same highest maximum output power applies to different combinations of channel bandwidths, modulations and data rates, additional procedures are applied to determine which test configurations require SAR measurement. When applicable, an initial test position may be applied to reduce the number of SAR measurements required for next to the ear, UMPC mini-tablet or hotspot mode configurations with multiple test positions.
4. For 2.4 GHz 802.11b DSSS, either the initial test position procedure for multiple exposure test positions or the DSSS procedure for fixed exposure position is applied; these are mutually exclusive. For 2.4 GHz and 5 GHz OFDM configurations, the initial test configuration is applied to measure SAR using either the initial test position procedure for multiple exposure test position configurations or the initial test configuration procedures for fixed exposure test conditions. Based on the reported SAR of the measured configurations and maximum output power of the transmission mode configurations that are not included in the initial test configuration, the subsequent test configuration and initial test position procedures are applied to determine if SAR measurements are required for the remaining OFDM transmission configurations. In general, the number of test channels that require SAR measurement is minimized based on maximum output power measured for the test sample(s).
5. For OFDM transmission configurations in the 2.4 GHz and 5 GHz bands, When the same maximum power is specified for multiple transmission modes in a frequency band, the largest channel bandwidth, lowest order modulation, lowest data rate and lowest order 802.11a/g/n/ac mode is used for SAR measurement, on the highest measured output power channel for each frequency band.
6. DSSS and OFDM configurations are considered separately according to the required SAR procedures. SAR is measured in the initial test position using the 802.11 transmission mode configuration required by the DSSS procedure or initial test configuration and subsequent test configuration(s) according to the OFDM procedures.18 The initial test position procedure is described in the following:
 - a. When the reported SAR of the initial test position is $\leq 0.4\text{ W/kg}$, further SAR measurement is not required for the other test positions in that exposure configuration and 802.11 transmission mode combinations within the frequency band or aggregated band.
 - b. When the reported SAR of the test position is $> 0.4\text{ W/kg}$, SAR is repeated for the 802.11 transmission mode configuration tested in the initial test position to measure the subsequent next closet/smallest test separation distance and maximum coupling test position on the highest maximum output power channel, until the report SAR is $\leq 0.8\text{ W/kg}$ or all required test position are tested.
 - c. For all positions/configurations, when the reported SAR is $> 0.8\text{ W/kg}$, SAR is measured for these test positions/configurations on the subsequent next highest measured output power channel(s) until the reported SAR is $\leq 1.2\text{ W/kg}$ or all required channels are tested.

<2.4GHz WLAN ANT 1>

	Mode	Channel	Frequency (MHz)	Data Rate	Average power (dBm)	Tune-Up Limit	Duty Cycle %
2.4GHz WLAN ANT 1	802.11b	CH 1	2412	1Mbps	17.60	18.30	98.62
		CH 2	2417		17.65	18.30	
		CH 6	2437		18.04	18.30	
		CH 10	2457		18.09	18.30	
		CH 11	2462		18.13	18.30	
	802.11g	CH 1	2412	6Mbps	16.17	16.50	92.21
		CH 2	2417		16.90	17.30	
		CH 6	2437		17.10	17.30	
		CH 10	2457		16.89	17.30	
		CH 11	2462		15.83	16.00	
	802.11n-HT20	CH 1	2412	MCS0	14.10	14.50	93.06
		CH 2	2417		17.01	17.30	
		CH 6	2437		16.99	17.30	
		CH 10	2457		16.47	17.30	
		CH 11	2462		14.65	15.00	
	802.11ac-VHT20	CH 1	2412	MCS0	14.15	14.50	92.21
		CH 2	2417		17.22	17.30	
		CH 6	2437		17.19	17.30	
		CH 10	2457		17.15	17.30	
		CH 11	2462		14.72	15.00	
	802.11n-HT40	CH 3	2422	MCS0	12.59	13.00	97.52
		CH 4	2427		12.55	13.50	
		CH 6	2437		14.52	15.00	
		CH 8	2447		13.01	13.50	
CH 9		2452	12.86		13.00		
802.11ac-VHT40	CH 3	2422	MCS0	12.68	13.00	96.69	
	CH 4	2427		12.66	13.50		
	CH 6	2437		14.57	15.00		
	CH 8	2447		13.25	13.50		
	CH 9	2452		12.99	13.00		



<2.4GHz WLAN ANT 2>

	Mode	Channel	Frequency (MHz)	Data Rate	Average power (dBm)	Tune-Up Limit	Duty Cycle %
2.4GHz WLAN ANT 2	802.11b	CH 1	2412	1Mbps	17.94	19.10	98.62
		CH 2	2417		18.33	19.10	
		CH 6	2437		18.72	19.10	
		CH 10	2457		18.44	19.10	
		CH 11	2462		18.23	19.10	
	802.11g	CH 1	2412	6Mbps	16.71	17.00	92.21
		CH 2	2417		17.89	18.10	
		CH 6	2437		17.90	18.10	
		CH 10	2457		17.88	18.10	
		CH 11	2462		16.50	17.00	
	802.11n-HT20	CH 1	2412	MCS0	14.61	15.00	97.52
		CH 2	2417		17.89	18.10	
		CH 6	2437		17.66	18.10	
		CH 10	2457		17.84	18.10	
		CH 11	2462		14.93	15.00	
	802.11ac-VHT20	CH 1	2412	MCS0	14.65	15.00	93.42
		CH 2	2417		17.88	18.10	
		CH 6	2437		17.67	18.10	
		CH 10	2457		17.95	18.10	
		CH 11	2462		14.94	15.00	
802.11n-HT40	CH 3	2422	MCS0	12.89	13.00	97.52	
	CH 4	2427		14.79	15.00		
	CH 6	2437		14.86	15.00		
	CH 8	2447		14.98	15.00		
	CH 9	2452		13.11	13.50		
802.11ac-VHT40	CH 3	2422	MCS0	12.96	13.00	97.52	
	CH 4	2427		14.79	15.00		
	CH 6	2437		14.88	15.00		
	CH 8	2447		14.83	15.00		
	CH 9	2452		13.13	13.50		

<2.4GHz WLAN ANT 1+2>

	Mode	Channel	Frequency (MHz)	Data Rate	Average power (dBm)	Tune-Up Limit	Duty Cycle %
2.4GHz WLAN ANT 1+2	802.11b	CH 1	2412	1Mbps	20.88	21.70	98.62
		CH 2	2417		20.89	21.70	
		CH 6	2437		21.46	21.70	
		CH 10	2457		21.27	21.70	
		CH 11	2462		21.26	21.70	
	802.11g	CH 1	2412	6Mbps	18.97	19.70	93.42
		CH 2	2417		20.60	20.70	
		CH 6	2437		20.64	20.70	
		CH 10	2457		20.68	20.70	
		CH 11	2462		18.46	19.50	
	802.11n-HT20	CH 1	2412	MCS0	17.54	17.80	97.52
		CH 2	2417		20.63	20.70	
		CH 6	2437		20.63	20.70	
		CH 10	2457		20.17	20.70	
		CH 11	2462		17.90	18.00	
	802.11ac-VHT20	CH 1	2412	MCS0	17.71	17.80	91.03
		CH 2	2417		20.54	20.70	
		CH 6	2437		20.68	20.70	
		CH 10	2457		20.20	20.70	
		CH 11	2462		17.97	18.00	
	802.11n-HT40	CH 3	2422	MCS0	15.97	16.10	97.52
		CH 4	2427		15.96	16.50	
		CH 6	2437		17.90	18.00	
		CH 8	2447		16.38	16.50	
		CH 9	2452		16.15	16.20	
	802.11ac-VHT40	CH 3	2422	MCS0	16.00	16.10	97.52
		CH 4	2427		16.01	16.50	
		CH 6	2437		17.93	18.00	
CH 8		2447	16.46		16.50		
CH 9		2452	16.17		16.20		

<TXBF Mode 2.4GHz WLAN ANT 1+2>

	Mode	Channel	Frequency (MHz)	Data Rate	Average power (dBm)	Tune-Up Limit
2.4GHz WLAN ANT 1+2	802.11n-HT20	CH 1	2412	MCS0	17.57	17.80
		CH 2	2417		20.63	20.70
		CH 6	2437		20.61	20.70
		CH 10	2457		20.17	20.70
		CH 11	2462		17.91	18.00
	802.11ac-VHT20	CH 1	2412	MCS0	17.67	17.80
		CH 2	2417		20.54	20.70
		CH 6	2437		20.66	20.70
		CH 10	2457		20.20	20.70
		CH 11	2462		17.96	18.00
	802.11n-HT40	CH 3	2422	MCS0	15.97	16.10
		CH 4	2427		15.96	16.50
		CH 6	2437		17.80	18.00
		CH 8	2447		16.38	16.50
		CH 9	2452		16.11	16.20
	802.11ac-VHT40	CH 3	2422	MCS0	16.03	16.10
		CH 4	2427		16.01	16.50
		CH 6	2437		17.90	18.00
		CH 8	2447		16.46	16.50
		CH 9	2452		16.16	16.20



<5GHz WLAN ANT1>

	Mode	Channel	Frequency (MHz)	Data Rate	Average power (dBm)	Tune-Up Limit	Duty Cycle %
5.2GHz WLAN ANT 1	802.11a	CH 36	5180	6Mbps	15.81	16.10	92.86
		CH 40	5200		15.90	16.10	
		CH 44	5220		15.91	16.10	
		CH 48	5240		15.98	16.10	
	802.11n-HT20	CH 36	5180	MCS0	14.62	15.00	92.86
		CH 40	5200		14.62	15.00	
		CH 44	5220		15.82	16.10	
		CH 48	5240		15.67	16.10	
	802.11n-HT40	CH 38	5190	MCS0	11.99	12.50	98.01
		CH 46	5230		15.15	15.60	
	802.11ac-VHT20	CH 36	5180	MCS0	14.64	15.00	92.86
		CH 40	5200		14.65	15.00	
		CH 44	5220		15.90	16.10	
CH 48		5240	15.69		16.10		
802.11ac-VHT40	CH 38	5190	MCS0	12.10	12.50	98.02	
	CH 46	5230		15.33	15.60		
802.11ac-VHT80	CH 42	5210	MCS0	12.08	12.50	95.95	

	Mode	Channel	Frequency (MHz)	Data Rate	Average power (dBm)	Tune-Up Limit	Duty Cycle %
5.3GHz WLAN ANT 1	802.11a	CH 52	5260	6Mbps	15.93	16.10	92.86
		CH 56	5280		16.00	16.10	
		CH 60	5300		16.09	16.10	
		CH 64	5320		15.98	16.10	
	802.11n-HT20	CH 52	5260	MCS0	15.65	16.10	92.86
		CH 56	5280		15.64	16.10	
		CH 60	5300		15.80	16.10	
		CH 64	5320		14.70	15.00	
	802.11n-HT40	CH 54	5270	MCS0	15.44	15.60	98.01
		CH 62	5310		11.94	12.00	
	802.11ac-VHT20	CH 52	5260	MCS0	15.70	16.10	92.86
		CH 56	5280		15.69	16.10	
		CH 60	5300		15.83	16.10	
CH 64		5320	14.73		15.00		
802.11ac-VHT40	CH 54	5270	MCS0	15.47	15.60	98.02	
	CH 62	5310		12.00	12.00		
802.11ac-VHT80	CH 58	5290	MCS0	11.69	12.00	95.95	



	Mode	Channel	Frequency (MHz)	Data Rate	Average power (dBm)	Tune-Up Limit	Duty Cycle %
5.5GHz WLAN ANT 1	802.11a	CH 100	5500	6Mbps	15.77	16.10	92.86
		CH 116	5580		15.84	16.10	
		CH 124	5620		15.82	16.10	
		CH 132	5660		15.83	16.10	
		CH 144	5720		15.81	16.10	
	802.11n-HT20	CH 100	5500	MCS0	15.34	16.00	92.86
		CH 116	5580		15.81	16.10	
		CH 124	5620		15.80	16.10	
		CH 132	5660		14.89	15.00	
		CH 144	5720		15.77	16.10	
	802.11n-HT40	CH 102	5510	MCS0	12.76	13.00	98.01
		CH 110	5550		15.30	15.60	
		CH 126	5630		15.21	15.60	
		CH 134	5670		14.89	15.60	
		CH 142	5710		15.18	15.60	
	802.11ac-VHT20	CH 100	5500	MCS0	15.53	16.00	92.86
		CH 116	5580		15.83	16.10	
		CH 124	5620		15.81	16.10	
		CH 132	5660		14.90	15.00	
		CH 144	5720		15.86	16.10	
802.11ac-VHT40	CH 102	5510	MCS0	12.84	13.00	98.02	
	CH 110	5550		15.53	15.60		
	CH 126	5630		15.26	15.60		
	CH 134	5670		15.21	15.60		
	CH 142	5710		15.27	15.60		
802.11ac-VHT80	CH 106	5530	MCS0	11.73	12.00	95.95	
	CH 122	5610		14.16	14.60		
	CH 138	5690		14.04	14.60		

	Mode	Channel	Frequency (MHz)	Data Rate	Average power (dBm)	Tune-Up Limit	Duty Cycle %
5.8GHz WLAN ANT 1	802.11a	CH 149	5745	MCS0	15.84	16.10	92.86
		CH 157	5785		15.93	16.10	
		CH 165	5825		15.88	16.10	
	802.11n-HT20	CH 149	5745	MCS0	15.82	16.10	92.86
		CH 157	5785		15.90	16.10	
		CH 165	5825		15.78	16.10	
	802.11n-HT40	CH 151	5755	MCS0	15.30	15.60	98.01
		CH 159	5795		15.24	15.60	
	802.11ac-VHT20	CH 149	5745	MCS0	15.84	16.10	92.86
		CH 157	5785		15.93	16.10	
		CH 165	5825		15.80	16.10	
	802.11ac-VHT40	CH 151	5755	MCS0	15.37	15.60	98.02
		CH 159	5795		15.34	15.60	
	802.11ac-VHT80	CH 155	5775	MCS0	14.35	14.60	95.95



<5GHz WLAN ANT2>

	Mode	Channel	Frequency (MHz)	Data Rate	Average power (dBm)	Tune-Up Limit	Duty Cycle %
5.2GHz WLAN ANT 2	802.11a	CH 36	5180	6Mbps	16.22	16.50	92.86
		CH 40	5200		17.58	17.80	
		CH 44	5220		17.61	17.80	
		CH 48	5240		17.60	17.80	
	802.11n-HT20	CH 36	5180	MCS0	16.51	17.00	92.86
		CH 40	5200		16.50	17.00	
		CH 44	5220		17.54	17.80	
	802.11n-HT40	CH 38	5190	MCS0	13.70	14.00	98.01
		CH 46	5230		16.86	17.30	
	802.11ac-VHT20	CH 36	5180	MCS0	16.57	17.00	92.28
		CH 40	5200		16.55	17.00	
		CH 44	5220		17.67	17.80	
		CH 48	5240		17.62	17.80	
802.11ac-VHT40	CH 38	5190	MCS0	13.76	14.00	98.21	
	CH 46	5230		16.93	17.30		
802.11ac-VHT80	CH 42	5210	MCS0	14.03	14.50	95.05	

	Mode	Channel	Frequency (MHz)	Data Rate	Average power (dBm)	Tune-Up Limit	Duty Cycle %
5.3GHz WLAN ANT 2	802.11a	CH 52	5260	6Mbps	17.55	17.80	92.86
		CH 56	5280		17.54	17.80	
		CH 60	5300		17.56	17.80	
		CH 64	5320		16.43	16.50	
	802.11n-HT20	CH 52	5260	MCS0	17.33	17.80	92.86
		CH 56	5280		17.42	17.80	
		CH 60	5300		17.58	17.80	
		CH 64	5320		16.40	16.50	
	802.11n-HT40	CH 54	5270	MCS0	17.06	17.30	98.01
		CH 62	5310		13.45	14.00	
	802.11ac-VHT20	CH 52	5260	MCS0	17.46	17.80	92.28
		CH 56	5280		17.50	17.80	
		CH 60	5300		17.63	17.80	
CH 64		5320	16.50		16.50		
802.11ac-VHT40	CH 54	5270	MCS0	17.08	17.30	98.21	
	CH 62	5310		13.61	14.00		
802.11ac-VHT80	CH 58	5290	MCS0	13.14	13.50	95.05	



	Mode	Channel	Frequency (MHz)	Data Rate	Average power (dBm)	Tune-Up Limit	Duty Cycle %
5.5GHz WLAN ANT 2	802.11a	CH 100	5500	6Mbps	17.77	17.80	92.86
		CH 116	5580		17.54	17.80	
		CH 124	5620		17.52	17.80	
		CH 132	5660		17.67	17.80	
		CH 144	5720		17.59	17.80	
	802.11n-HT20	CH 100	5500	MCS0	17.32	17.80	92.86
		CH 116	5580		17.54	17.80	
		CH 124	5620		17.52	17.80	
		CH 132	5660		16.64	17.00	
		CH 144	5720		17.48	17.80	
	802.11n-HT40	CH 102	5510	MCS0	14.96	15.50	98.01
		CH 110	5550		17.11	17.30	
		CH 126	5630		17.02	17.30	
		CH 134	5670		16.74	17.30	
		CH 142	5710		17.05	17.30	
	802.11ac-VHT20	CH 100	5500	MCS0	17.37	17.80	92.28
		CH 116	5580		17.57	17.80	
		CH 124	5620		17.54	17.80	
		CH 132	5660		16.66	17.00	
		CH 144	5720		17.61	17.80	
802.11ac-VHT40	CH 102	5510	MCS0	15.04	15.50	98.21	
	CH 110	5550		17.16	17.30		
	CH 126	5630		17.05	17.30		
	CH 134	5670		16.75	17.30		
	CH 142	5710		17.15	17.30		
802.11ac-VHT80	CH 106	5530	MCS0	13.64	14.00	95.05	
	CH 122	5610		16.11	16.30		
	CH 138	5690		16.18	16.30		

	Mode	Channel	Frequency (MHz)	Data Rate	Average power (dBm)	Tune-Up Limit	Duty Cycle %
5.8GHz WLAN ANT 2	802.11a	CH 149	5745	MCS0	17.53	17.80	92.86
		CH 157	5785		17.60	17.80	
		CH 165	5825		17.57	17.80	
	802.11n-HT20	CH 149	5745	MCS0	17.53	17.80	92.86
		CH 157	5785		17.48	17.80	
		CH 165	5825		17.64	17.80	
	802.11n-HT40	CH 151	5755	MCS0	17.05	17.30	98.01
		CH 159	5795		16.95	17.30	
	802.11ac-VHT20	CH 149	5745	MCS0	17.63	17.80	92.28
		CH 157	5785		17.51	17.80	
		CH 165	5825		17.68	17.80	
	802.11ac-VHT40	CH 151	5755	MCS0	17.07	17.30	98.21
		CH 159	5795		17.03	17.30	
802.11ac-VHT80	CH 155	5775	MCS0	16.10	16.30	95.05	



<5GHz WLAN ANT1+2>

	Mode	Channel	Frequency (MHz)	Data Rate	Average power (dBm)	Tune-Up Limit	Duty Cycle %
5.2GHz WLAN ANT 1+2	802.11a	CH 36	5180	6Mbps	18.46	19.30	92.86
		CH 40	5200		19.86	20.00	
		CH 44	5220		19.89	20.00	
		CH 48	5240		19.86	20.00	
	802.11n-HT20	CH 36	5180	MCS0	18.77	19.10	92.86
		CH 40	5200		18.76	20.00	
		CH 44	5220		19.89	20.00	
		CH 48	5240		19.77	20.00	
	802.11n-HT40	CH 38	5190	MCS0	16.02	16.30	97.91
		CH 46	5230		19.18	19.50	
	802.11ac-VHT20	CH 36	5180	MCS0	18.79	19.10	92.82
		CH 40	5200		18.78	20.00	
		CH 44	5220		19.91	20.00	
CH 48		5240	19.80		20.00		
802.11ac-VHT40	CH 38	5190	MCS0	16.10	16.30	98.02	
	CH 46	5230		19.33	19.50		
802.11ac-VHT80	CH 42	5210	MCS0	16.26	16.60	95.96	

	Mode	Channel	Frequency (MHz)	Data Rate	Average power (dBm)	Tune-Up Limit	Duty Cycle %
5.3GHz WLAN ANT 1+2	802.11a	CH 52	5260	6Mbps	19.90	20.00	92.86
		CH 56	5280		19.88	20.00	
		CH 60	5300		19.91	20.00	
		CH 64	5320		19.21	19.30	
	802.11n-HT20	CH 52	5260	MCS0	19.71	20.00	92.86
		CH 56	5280		19.70	20.00	
		CH 60	5300		19.86	20.00	
		CH 64	5320		18.73	18.80	
	802.11n-HT40	CH 54	5270	MCS0	19.41	19.50	97.91
		CH 62	5310		15.90	16.10	
	802.11ac-VHT20	CH 52	5260	MCS0	19.73	20.00	92.82
		CH 56	5280		19.74	20.00	
		CH 60	5300		19.90	20.00	
CH 64		5320	18.80		18.80		
802.11ac-VHT40	CH 54	5270	MCS0	19.50	19.50	98.02	
	CH 62	5310		15.96	16.10		
802.11ac-VHT80	CH 58	5290	MCS0	15.58	15.80	95.96	



	Mode	Channel	Frequency (MHz)	Data Rate	Average power (dBm)	Tune-Up Limit	Duty Cycle %
5.5GHz WLAN ANT 1+2	802.11a	CH 100	5500	6Mbps	19.58	20.00	92.86
		CH 116	5580		19.97	20.00	
		CH 124	5620		19.89	20.00	
		CH 132	5660		19.40	20.00	
		CH 144	5720		19.92	20.00	
	802.11n-HT20	CH 100	5500	MCS0	19.57	20.00	92.86
		CH 116	5580		19.83	20.00	
		CH 124	5620		19.81	20.00	
		CH 132	5660		19.01	20.00	
		CH 144	5720		19.79	20.00	
	802.11n-HT40	CH 102	5510	MCS0	17.06	17.40	97.91
		CH 110	5550		19.36	19.50	
		CH 126	5630		19.24	19.50	
		CH 134	5670		19.14	19.50	
		CH 142	5710		19.28	19.50	
	802.11ac-VHT20	CH 100	5500	MCS0	19.63	20.00	92.82
		CH 116	5580		19.85	20.00	
		CH 124	5620		19.83	20.00	
		CH 132	5660		19.03	20.00	
		CH 144	5720		19.92	20.00	
802.11ac-VHT40	CH 102	5510	MCS0	17.14	17.40	98.02	
	CH 110	5550		19.50	19.50		
	CH 126	5630		19.27	19.50		
	CH 134	5670		19.17	19.50		
	CH 142	5710		19.42	19.50		
802.11ac-VHT80	CH 106	5530	MCS0	15.91	16.10	95.96	
	CH 122	5610		18.34	18.50		
	CH 138	5690		18.31	18.50		

	Mode	Channel	Frequency (MHz)	Data Rate	Average power (dBm)	Tune-Up Limit	Duty Cycle %
5.8GHz WLAN ANT 1+2	802.11a	CH 149	5745	MCS0	19.93	20.00	92.86
		CH 157	5785		19.95	20.00	
		CH 165	5825		19.87	20.00	
	802.11n-HT20	CH 149	5745	MCS0	19.85	20.00	92.86
		CH 157	5785		19.88	20.00	
		CH 165	5825		19.85	20.00	
	802.11n-HT40	CH 151	5755	MCS0	19.36	19.50	97.91
		CH 159	5795		19.39	19.50	
	802.11ac-VHT20	CH 149	5745	MCS0	19.87	20.00	92.82
		CH 157	5785		19.90	20.00	
		CH 165	5825		19.89	20.00	
	802.11ac-VHT40	CH 151	5755	MCS0	19.45	19.50	98.02
		CH 159	5795		19.41	19.50	
802.11ac-VHT80	CH 155	5775	MCS0	18.37	18.50	95.96	



<TXBF Mode 5GHz WLAN ANT 1+2>

5.2GHz WLAN ANT 1+2	Mode	Channel	Frequency (MHz)	Data Rate	Average power (dBm)	Tune-Up Limit	
	802.11n-HT20		CH 36	5180	MCS0	18.42	20.00
			CH 40	5200		19.71	20.00
			CH 44	5220		19.66	20.00
			CH 48	5240		19.58	20.00
	802.11n-HT40		CH 38	5190	MCS0	15.92	16.30
			CH 46	5230		19.30	19.50
	802.11ac-VHT20		CH 36	5180	MCS0	18.68	20.00
			CH 40	5200		19.85	20.00
			CH 44	5220		19.82	20.00
CH 48			5240	19.74		20.00	
802.11ac-VHT40		CH 38	5190	MCS0	16.07	16.30	
		CH 46	5230		19.30	19.50	
802.11ac-VHT80		CH 42	5210	MCS0	16.25	16.60	

5.3GHz WLAN ANT 1+2	Mode	Channel	Frequency (MHz)	Data Rate	Average power (dBm)	Tune-Up Limit	
	802.11n-HT20		CH 52	5260	MCS0	19.60	20.00
			CH 56	5280		19.63	20.00
			CH 60	5300		19.56	20.00
			CH 64	5320		18.66	18.80
	802.11n-HT40		CH 54	5270	MCS0	19.20	19.50
			CH 62	5310		15.82	16.10
	802.11ac-VHT20		CH 52	5260	MCS0	19.70	20.00
			CH 56	5280		19.78	20.00
			CH 60	5300		19.66	20.00
CH 64			5320	18.76		18.80	
802.11ac-VHT40		CH 54	5270	MCS0	19.30	19.50	
		CH 62	5310		15.92	16.10	
802.11ac-VHT80		CH 58	5290	MCS0	15.32	15.80	



5.5GHz WLAN ANT 1+2	Mode	Channel	Frequency (MHz)	Data Rate	Average power (dBm)	Tune-Up Limit	
	802.11n-HT20		CH 100	5500	MCS0	19.48	20.00
			CH 116	5580		19.55	20.00
			CH 124	5620		19.44	20.00
			CH 132	5660		19.27	20.00
			CH 144	5720		19.66	20.00
	802.11n-HT40		CH 102	5510	MCS0	17.00	17.40
			CH 110	5550		19.32	19.50
			CH 126	5630		19.14	19.50
			CH 134	5670		18.99	19.50
			CH 142	5710		19.33	19.50
	802.11ac-VHT20		CH 100	5500	MCS0	19.62	20.00
			CH 116	5580		19.72	20.00
			CH 124	5620		19.61	20.00
			CH 132	5660		19.55	20.00
			CH 144	5720		19.76	20.00
	802.11ac-VHT40		CH 102	5510	MCS0	17.10	17.40
			CH 110	5550		19.46	19.50
CH 126			5630	19.44		19.50	
CH 134			5670	19.09		19.50	
CH 142			5710	19.46		19.50	
802.11ac-VHT80		CH 106	5530	MCS0	15.79	16.10	
		CH 122	5610		18.30	18.50	
		CH 138	5690		18.23	18.50	

5.8GHz WLAN ANT 1+2	Mode	Channel	Frequency (MHz)	Data Rate	Average power (dBm)	Tune-Up Limit	
	802.11n-HT20		CH 149	5745	MCS0	19.52	20.00
			CH 157	5785		19.52	20.00
			CH 165	5825		19.59	20.00
	802.11n-HT40		CH 151	5755	MCS0	19.04	19.50
			CH 159	5795		19.02	19.50
	802.11ac-VHT20		CH 149	5745	MCS0	19.62	20.00
			CH 157	5785		19.69	20.00
			CH 165	5825		19.75	20.00
	802.11ac-VHT40		CH 151	5755	MCS0	19.14	19.50
			CH 159	5795		19.19	19.50
	802.11ac-VHT80		CH 155	5775	MCS0	17.85	18.50



13. Bluetooth Exclusions Applied

Mode	Channel	Frequency (MHz)	Average power (dBm)		
			1Mbps	2Mbps	3Mbps
BR/EDR	CH 00	2402	1.02	-2.65	-2.71
	CH 39	2441	3.28	-0.40	-0.37
	CH 78	2480	3.21	-0.55	-0.61
Tune-up Limit			4.00	4.00	4.00

Mode	Channel	Frequency (MHz)	Average power (dBm)
			GFSK
LE	CH 00	2402	1.60
	CH 19	2440	3.20
	CH 39	2480	3.48
Tune-up Limit			4.00

Note:

- Per KDB 447498 D01v06, the 1-g and 10-g SAR test exclusion thresholds for 100 MHz to 6 GHz at *test separation distances* ≤ 50 mm are determined by:

$$[(\text{max. power of channel, including tune-up tolerance, mW}) / (\text{min. test separation distance, mm})] \cdot \sqrt{f(\text{GHz})} \leq 3.0$$
 for 1-g SAR and ≤ 7.5 for 10-g extremity SAR
 - f(GHz) is the RF channel transmit frequency in GHz
 - Power and distance are rounded to the nearest mW and mm before calculation
 - The result is rounded to one decimal place for comparison

<Body worn (with holster)>

Bluetooth Max Power (dBm)	Separation Distance (mm)	Frequency (GHz)	exclusion thresholds
4	< 5	2.48	0.94

Note:

Per KDB 447498 D01v06, when the minimum test separation distance is < 5 mm, a distance of 5 mm is applied to determine SAR test exclusion. The test exclusion threshold is 0.94 which is ≤ 3, SAR testing is not required.

<Body worn (without holster)>

Bluetooth Max Power (dBm)	Separation Distance (mm)	Frequency (GHz)	exclusion thresholds
4	15	2.48	0.31

Note:

Per KDB 447498 D01v06, when the minimum test separation distance is 15 mm, the test exclusion threshold is 0.31 which is ≤ 3, SAR testing is not required.

14. Antenna Location

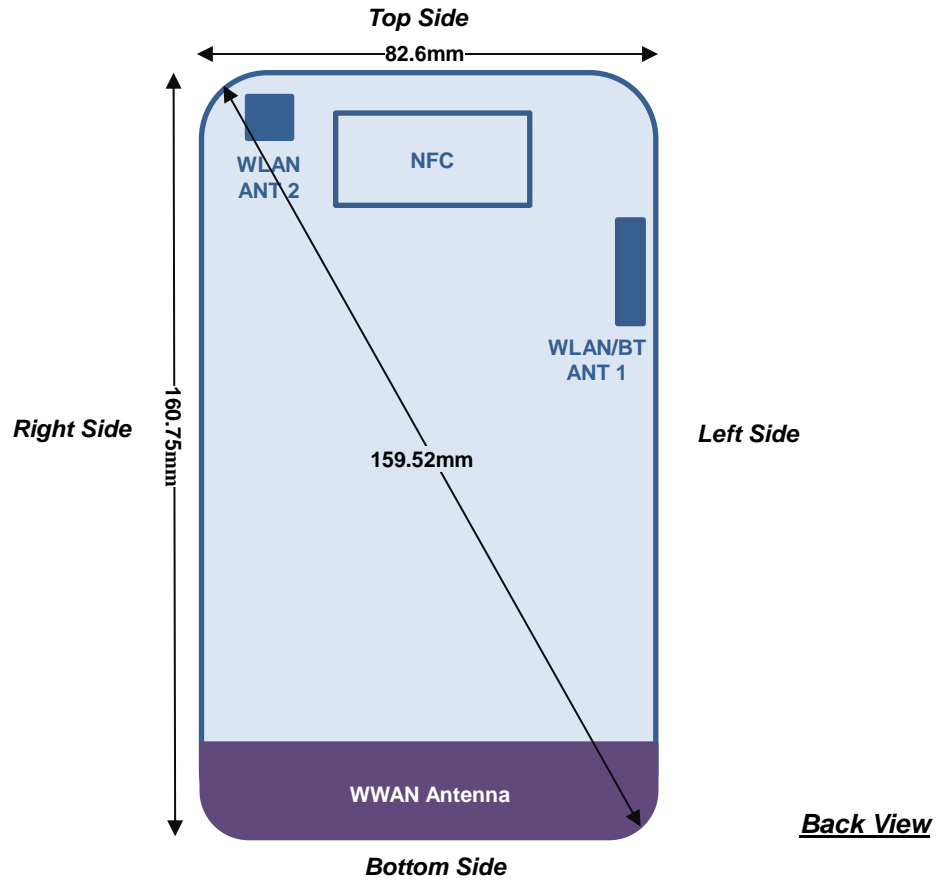

Distance of the Antenna to the EUT surface/edge						
Antennas	Back	Front	Top Side	Bottom Side	Right Side	Left Side
WWAN	≤ 25mm	≤ 25mm	> 25mm	≤ 25mm	≤ 25mm	≤ 25mm
BT&WLAN ANT 1	≤ 25mm	≤ 25mm	≤ 25mm	> 25mm	> 25mm	≤ 25mm
WLAN ANT 2	≤ 25mm	≤ 25mm	≤ 25mm	> 25mm	≤ 25mm	> 25mm

Positions for SAR tests; Hotspot mode						
Antennas	Back	Front	Top Side	Bottom Side	Right Side	Left Side
WWAN	Yes	Yes	No	Yes	Yes	Yes
BT&WLAN ANT 1	Yes	Yes	Yes	No	No	Yes
WLAN ANT 2	Yes	Yes	Yes	No	Yes	No

General Note:

- Referring to KDB 941225 D06 v02r01, when the overall device length and width are ≥ 9cm*5cm, the test distance is 10 mm. SAR must be measured for all sides and surfaces with a transmitting antenna located within 25mm from that surface or edge



15. SAR Test Results

General Note:

1. Per KDB 447498 D01v06, the reported SAR is the measured SAR value adjusted for maximum tune-up tolerance.
 - a. Tune-up scaling Factor = tune-up limit power (mW) / EUT RF power (mW), where tune-up limit is the maximum rated power among all production units.
 - b. For SAR testing of WLAN signal with non-100% duty cycle, the measured SAR is scaled-up by the duty cycle scaling factor which is equal to "1/(duty cycle)"
 - c. For WWAN/Bluetooth: Reported SAR(W/kg)= Measured SAR(W/kg)*Tune-up Scaling Factor
 - d. For WLAN: Reported SAR(W/kg)= Measured SAR(W/kg)* Duty Cycle scaling factor * Tune-up scaling factor
2. Per KDB 447498 D01v06, for each exposure position, testing of other required channels within the operating mode of a frequency band is not required when the *reported* 1-g or 10-g SAR for the mid-band or highest output power channel is:
 - ≤ 0.8 W/kg or 2.0 W/kg, for 1-g or 10-g respectively, when the transmission band is ≤ 100 MHz
 - ≤ 0.6 W/kg or 1.5 W/kg, for 1-g or 10-g respectively, when the transmission band is between 100 MHz and 200 MHz
 - ≤ 0.4 W/kg or 1.0 W/kg, for 1-g or 10-g respectively, when the transmission band is ≥ 200 MHz
3. Per KDB 865664 D01v01r04, for each frequency band, repeated SAR measurement is required only when the measured SAR is ≥ 0.8 W/kg.
4. When hotspot mode is enabled, power reduction will be activated to limit the maximum power of GSM1900, WCDMA B2 / B4, CDMA BC1 and LTE B2 / B4 / B25.
5. Pre KDB648474 D04v01r03, when the reported SAR for a body-worn accessory, measured without a headset connected to the handset, is > 1.2 W/kg, the highest reported SAR configuration for that wireless mode and frequency band should be repeated for that body-worn accessory with a headset attached to the handset.
6. When EUT is placed into the holster, only front face of EUT will toward to the human body.

GSM Note:

1. Per KDB 941225 D01v03r01, for SAR test reduction for GSM / GPRS / EDGE modes is determined by the source-based time-averaged output power including tune-up tolerance. The mode with highest specified time-averaged output power should be tested for SAR compliance in the applicable exposure conditions. For modes with the same specified maximum output power and tolerance, the higher number time-slot configuration should be tested. Therefore, the GPRS (4Tx slots) for GSM850 and GPRS (3Tx slots) for GSM1900 is considered as the primary mode.
2. Other configurations of GSM / GPRS / EDGE are considered as secondary modes. The 3G SAR test reduction procedure is applied, when the maximum output power and tune-up tolerance specified for production units in a secondary mode is $\leq 1/4$ dB higher than the primary mode, SAR measurement is not required for the secondary mode.
3. Power reduction which is triggered by hotspot mode is implemented in GSM1900 band, for hotspot mode SAR testing EUT was set in reduced power mode and GPRS 4 Tx slot due to its highest frame-average power.

UMTS Note:

1. Per KDB 941225 D01v03r01, for SAR testing is measured using a 12.2 kbps RMC with TPC bits configured to all "1's".
2. Per KDB 941225 D01v03r01, RMC 12.2kbps setting is used to evaluate SAR. If the maximum output power and tune-up tolerance specified for production units in HSDPA / HSUPA / DC-HSDPA is $\leq 1/4$ dB higher than RMC 12.2Kbps or when the highest reported SAR of the RMC12.2Kbps is scaled by the ratio of specified maximum output power and tune-up tolerance of HSDPA / HSUPA / DC-HSDPA to RMC12.2Kbps and the adjusted SAR is ≤ 1.2 W/kg, SAR measurement is not required for HSDPA / HSUPA / DC-HSDPA.

CMDA Note:

1. Per KDB 941225 D01v03r01, SAR for next to the ear head exposure is measured in RC3 with the handset configured to transmit at full rate in SO55.
2. Per KDB 941225 D01v03r01, in Hotspot mode EUT is treated as data device and SAR is tested with Ev-Do Rev 0 (RTAP 153.6kbps) as the primary mode.
3. Per KDB 941225 D01v03r01, for Body-worn accessory SAR is measured in RC3 with the handset configured in TDSO/SO32 to transmit at full rate on FCH only with all other code channels disabled. The body-worn accessory procedures in KDB Publication 447498 are applied. The 3G SAR test reduction procedure is applied to the multiple code channel configuration (FCH+SCH), with FCH only as the primary mode.

**LTE Note:**

1. Per KDB 941225 D05v02r05, start with the largest channel bandwidth and measure SAR for QPSK with 1 RB allocation, using the RB offset and required test channel combination with the highest maximum output power for RB offsets at the upper edge, middle and lower edge of each required test channel.
2. Per KDB 941225 D05v02r05, 50% RB allocation for QPSK SAR testing follows 1RB QPSK allocation procedure.
3. Per KDB 941225 D05v02r05, For QPSK with 100% RB allocation, SAR is not required when the highest maximum output power for 100 % RB allocation is less than the highest maximum output power in 50% and 1 RB allocations and the highest reported SAR for 1 RB and 50% RB allocation are ≤ 0.8 W/kg. Otherwise, SAR is measured for the highest output power channel; and if the reported SAR is > 1.45 W/kg, the remaining required test channels must also be tested.
4. Per KDB 941225 D05v02r05, 16QAM output power for each RB allocation configuration is $>$ not $\frac{1}{2}$ dB higher than the same configuration in QPSK and the reported SAR for the QPSK configuration is ≤ 1.45 W/kg; Per KDB 941225 D05v02r05, 16QAM SAR testing is not required.
5. Per KDB 941225 D05v02r05, Smaller bandwidth output power for each RB allocation configuration is $>$ not $\frac{1}{2}$ dB higher than the same configuration in the largest supported bandwidth, and the reported SAR for the largest supported bandwidth is ≤ 1.45 W/kg; Per KDB 941225 D05v02r05, smaller bandwidth SAR testing is not required.
6. For LTE B4 / B12 / B26 the maximum bandwidth does not support three non-overlapping channels, per KDB 941225 D05v02r05, when a device supports overlapping channel assignment in a channel bandwidth configuration, the middle channel of the group of overlapping channels should be selected for testing.
7. LTE band 2 / 5 / 17 SAR test was covered by Band 25 / 26 / 12; according to TCB workshop, SAR test for overlapping LTE bands can be reduced if
 - a. The maximum output power, including tolerance, for the smaller band is \leq the larger band to qualify for the SAR test exclusion.
 - b. The channel bandwidth and other operating parameters for the smaller band are fully supported by the larger band.

WLAN Note:

1. Per KDB 248227 D01v02r02, for 2.4GHz 802.11g/n SAR testing is not required when the highest reported SAR for DSSS is adjusted by the ratio of OFDM to DSSS specified maximum output power and the adjusted SAR is ≤ 1.2 W/kg.
2. Per KDB 248227 D01v02r02, for U-NII-1 Head and Body-worn SAR testing is not required when the U-NII-2A band highest reported SAR for a test configuration is ≤ 1.2 W/kg, SAR is not required for U-NII-1 band.
3. When the reported SAR of the test position is > 0.4 W/kg, SAR is repeated for the 802.11 transmission mode configuration tested in the initial test position to measure the subsequent next closet/smallest test separation distance and maximum coupling test position on the highest maximum output power channel, until the report SAR is ≤ 0.8 W/kg or all required test position are tested.
4. For all positions / configurations, when the reported SAR is > 0.8 W/kg, SAR is measured for these test positions / configurations on the subsequent next highest measured output power channel(s) until the reported SAR is ≤ 1.2 W/kg or all required channels are tested.
5. For WLAN SAR testing was performed on single antenna RF power in SISO mode is larger or equal to the single antenna RF power in MIMO mode, and for RF exposure assessment of MIMO mode simultaneous transmission exclusion analysis was performed with SAR test results of each antenna in SISO mode.
6. Per KDB 248227 D01v02r02, the simultaneous SAR provisions in KDB publication 447498 should be applied to determine simultaneous transmission SAR test exclusion for WiFi MIMO. If the sum of 1g single transmission chain SAR measurements is < 1.6 W/kg and SAR peak to location ratio ≤ 0.04 , no additional SAR measurements for MIMO.
7. During SAR testing the WLAN transmission was verified using a spectrum analyzer.



15.1 Head SAR

<GSM SAR>

Plot No.	Band	Mode	Test Position	Gap (mm)	Ch.	Freq. (MHz)	Average Power (dBm)	Tune-Up Limit (dBm)	Tune-up Scaling Factor	Power Drift (dB)	Measured 1g SAR (W/kg)	Reported 1g SAR (W/kg)
	GSM850	GPRS (4 Tx slots)	Right Cheek	0mm	128	824.2	31.79	32.00	1.050	-0.12	0.606	0.636
	GSM850	GPRS (4 Tx slots)	Right Cheek	0mm	189	836.4	31.65	32.00	1.084	-0.03	0.638	0.692
01	GSM850	GPRS (4 Tx slots)	Right Cheek	0mm	251	848.8	31.67	32.00	1.079	0.12	0.785	0.847
	GSM850	GPRS (4 Tx slots)	Right Tilted	0mm	128	824.2	31.79	32.00	1.050	-0.03	0.316	0.332
	GSM850	GPRS (4 Tx slots)	Left Cheek	0mm	128	824.2	31.79	32.00	1.050	-0.03	0.334	0.351
	GSM850	GPRS (4 Tx slots)	Left Tilted	0mm	128	824.2	31.79	32.00	1.050	-0.02	0.307	0.322
	GSM1900	GPRS (3 Tx slots)	Right Cheek	0mm	661	1880	29.41	30.00	1.146	-0.11	0.145	0.166
	GSM1900	GPRS (3 Tx slots)	Right Tilted	0mm	661	1880	29.41	30.00	1.146	0.09	0.073	0.084
	GSM1900	GPRS (3 Tx slots)	Left Cheek	0mm	661	1880	29.41	30.00	1.146	0.02	0.196	0.225
	GSM1900	GPRS (3 Tx slots)	Left Cheek	0mm	512	1850.2	29.34	30.00	1.164	0	0.187	0.218
02	GSM1900	GPRS (3 Tx slots)	Left Cheek	0mm	810	1909.8	29.30	30.00	1.175	-0.01	0.206	0.242
	GSM1900	GPRS (3 Tx slots)	Left Tilted	0mm	661	1880	29.41	30.00	1.146	0.17	0.044	0.050

<WCDMA SAR>

Plot No.	Band	Mode	Test Position	Gap (mm)	Ch.	Freq. (MHz)	Average Power (dBm)	Tune-Up Limit (dBm)	Tune-up Scaling Factor	Power Drift (dB)	Measured 1g SAR (W/kg)	Reported 1g SAR (W/kg)
	WCDMA II	RMC 12.2Kbps	Right Cheek	0mm	9262	1852.4	24.39	25.50	1.291	-0.11	0.109	0.141
	WCDMA II	RMC 12.2Kbps	Right Tilted	0mm	9262	1852.4	24.39	25.50	1.291	0.1	0.063	0.081
	WCDMA II	RMC 12.2Kbps	Left Cheek	0mm	9262	1852.4	24.39	25.50	1.291	-0.16	0.182	0.235
	WCDMA II	RMC 12.2Kbps	Left Cheek	0mm	9400	1880	24.17	25.50	1.358	-0.03	0.177	0.240
03	WCDMA II	RMC 12.2Kbps	Left Cheek	0mm	9538	1907.6	24.39	25.50	1.291	0.1	0.191	0.247
	WCDMA II	RMC 12.2Kbps	Left Tilted	0mm	9262	1852.4	24.39	25.50	1.291	0.12	0.032	0.041
	WCDMA IV	RMC 12.2Kbps	Right Cheek	0mm	1513	1752.6	23.92	25.00	1.282	-0.01	0.109	0.140
	WCDMA IV	RMC 12.2Kbps	Right Tilted	0mm	1513	1752.6	23.92	25.00	1.282	0.16	0.073	0.094
04	WCDMA IV	RMC 12.2Kbps	Left Cheek	0mm	1513	1752.6	23.92	25.00	1.282	0.06	0.203	0.260
	WCDMA IV	RMC 12.2Kbps	Left Cheek	0mm	1312	1712.4	23.58	25.00	1.387	0.02	0.175	0.243
	WCDMA IV	RMC 12.2Kbps	Left Cheek	0mm	1413	1732.6	23.72	25.00	1.343	0.09	0.185	0.248
	WCDMA IV	RMC 12.2Kbps	Left Tilted	0mm	1513	1752.6	23.92	25.00	1.282	-0.06	0.041	0.053
05	WCDMA V	RMC 12.2Kbps	Right Cheek	0mm	4233	846.6	23.90	25.50	1.445	-0.1	0.303	0.438
	WCDMA V	RMC 12.2Kbps	Right Cheek	0mm	4132	826.4	23.73	25.50	1.503	0.09	0.289	0.434
	WCDMA V	RMC 12.2Kbps	Right Cheek	0mm	4182	836.4	23.85	25.50	1.462	0.11	0.283	0.414
	WCDMA V	RMC 12.2Kbps	Right Tilted	0mm	4233	846.6	23.90	25.50	1.445	0.1	0.163	0.236
	WCDMA V	RMC 12.2Kbps	Left Cheek	0mm	4233	846.6	23.90	25.50	1.445	-0.02	0.183	0.265
	WCDMA V	RMC 12.2Kbps	Left Tilted	0mm	4233	846.6	23.90	25.50	1.445	0.11	0.150	0.217

<CDMA SAR>

Plot No.	Band	Mode	Test Position	Gap (mm)	Ch.	Freq. (MHz)	Average Power (dBm)	Tune-Up Limit (dBm)	Tune-up Scaling Factor	Power Drift (dB)	Measured 1g SAR (W/kg)	Reported 1g SAR (W/kg)
06	CDMA BC0	1xRTT RC1 SO55	Right Cheek	0mm	777	848.31	24.15	25.50	1.365	0.08	0.333	0.454
	CDMA BC0	1xRTT RC1 SO55	Right Tilted	0mm	777	848.31	24.15	25.50	1.365	-0.06	0.181	0.247
	CDMA BC0	1xRTT RC1 SO55	Left Cheek	0mm	777	848.31	24.15	25.50	1.365	-0.02	0.200	0.273
	CDMA BC0	1xRTT RC1 SO55	Left Tilted	0mm	777	848.31	24.15	25.50	1.365	-0.04	0.173	0.236
	CDMA BC1	1xRTT RC1 SO55	Right Cheek	0mm	1175	1908.75	24.83	25.50	1.167	-0.02	0.086	0.100
	CDMA BC1	1xRTT RC1 SO55	Right Tilted	0mm	1175	1908.75	24.83	25.50	1.167	0.08	0.065	0.076
07	CDMA BC1	1xRTT RC1 SO55	Left Cheek	0mm	1175	1908.75	24.83	25.50	1.167	0.15	0.190	0.222
	CDMA BC1	1xRTT RC1 SO55	Left Tilted	0mm	1175	1908.75	24.83	25.50	1.167	0.05	0.031	0.036
08	CDMA BC10	1xRTT RC1 SO55	Right Cheek	0mm	684	823.1	24.18	25.50	1.355	0.1	0.269	0.365
	CDMA BC10	1xRTT RC1 SO55	Right Tilted	0mm	684	823.1	24.18	25.50	1.355	0.14	0.146	0.198
	CDMA BC10	1xRTT RC1 SO55	Left Cheek	0mm	684	823.1	24.18	25.50	1.355	-0.03	0.161	0.218
	CDMA BC10	1xRTT RC1 SO55	Left Tilted	0mm	684	823.1	24.18	25.50	1.355	0.04	0.140	0.190



<LTE SAR>

Plot No.	Band	BW (MHz)	Modulation	RB Size	RB offset	Test Position	Gap (mm)	Ch.	Freq. (MHz)	Average Power (dBm)	Tune-Up Limit (dBm)	Tune-up Scaling Factor	Power Drift (dB)	Measured 1g SAR (W/kg)	Reported 1g SAR (W/kg)
	LTE Band 4	20M	QPSK	1	0	Right Cheek	0mm	20175	1732.5	24.12	25.00	1.225	0.09	0.082	0.100
	LTE Band 4	20M	QPSK	50	50	Right Cheek	0mm	20175	1732.5	22.95	24.00	1.274	0.1	0.067	0.085
	LTE Band 4	20M	QPSK	1	0	Right Tilted	0mm	20175	1732.5	24.12	25.00	1.225	-0.01	0.051	0.062
	LTE Band 4	20M	QPSK	50	50	Right Tilted	0mm	20175	1732.5	22.95	24.00	1.274	0.12	0.041	0.052
09	LTE Band 4	20M	QPSK	1	0	Left Cheek	0mm	20175	1732.5	24.12	25.00	1.225	-0.05	0.173	0.212
	LTE Band 4	20M	QPSK	50	50	Left Cheek	0mm	20175	1732.5	22.95	24.00	1.274	0.04	0.136	0.173
	LTE Band 4	20M	QPSK	1	0	Left Tilted	0mm	20175	1732.5	24.12	25.00	1.225	-0.18	0.043	0.053
	LTE Band 4	20M	QPSK	50	50	Left Tilted	0mm	20175	1732.5	22.95	24.00	1.274	0.02	0.032	0.041
10	LTE Band 12	10M	QPSK	1	0	Right Cheek	0mm	23095	707.5	24.18	25.00	1.208	-0.05	0.235	0.284
	LTE Band 12	10M	QPSK	25	0	Right Cheek	0mm	23095	707.5	23.09	24.00	1.233	0.05	0.191	0.236
	LTE Band 12	10M	QPSK	1	0	Right Tilted	0mm	23095	707.5	24.18	25.00	1.208	0.04	0.141	0.170
	LTE Band 12	10M	QPSK	25	0	Right Tilted	0mm	23095	707.5	23.09	24.00	1.233	0.07	0.116	0.143
	LTE Band 12	10M	QPSK	1	0	Left Cheek	0mm	23095	707.5	24.18	25.00	1.208	0.09	0.185	0.223
	LTE Band 12	10M	QPSK	25	0	Left Cheek	0mm	23095	707.5	23.09	24.00	1.233	-0.01	0.149	0.184
	LTE Band 12	10M	QPSK	1	0	Left Tilted	0mm	23095	707.5	24.18	25.00	1.208	0.05	0.131	0.158
	LTE Band 12	10M	QPSK	25	0	Left Tilted	0mm	23095	707.5	23.09	24.00	1.233	-0.03	0.105	0.129
11	LTE Band 13	10M	QPSK	1	25	Right Cheek	0mm	23230	782	24.03	25.00	1.250	0.01	0.225	0.281
	LTE Band 13	10M	QPSK	25	0	Right Cheek	0mm	23230	782	22.84	24.00	1.306	0.09	0.174	0.227
	LTE Band 13	10M	QPSK	1	25	Right Tilted	0mm	23230	782	24.03	25.00	1.250	0.01	0.127	0.159
	LTE Band 13	10M	QPSK	25	0	Right Tilted	0mm	23230	782	22.84	24.00	1.306	0.03	0.098	0.128
	LTE Band 13	10M	QPSK	1	25	Left Cheek	0mm	23230	782	24.03	25.00	1.250	0.02	0.147	0.184
	LTE Band 13	10M	QPSK	25	0	Left Cheek	0mm	23230	782	22.84	24.00	1.306	0.07	0.113	0.148
	LTE Band 13	10M	QPSK	1	25	Left Tilted	0mm	23230	782	24.03	25.00	1.250	0.08	0.123	0.154
	LTE Band 13	10M	QPSK	25	0	Left Tilted	0mm	23230	782	22.84	24.00	1.306	0.07	0.095	0.124
	LTE Band 25	20M	QPSK	1	49	Right Cheek	0mm	26590	1905	23.60	25.00	1.380	0.11	0.087	0.120
	LTE Band 25	20M	QPSK	50	50	Right Cheek	0mm	26590	1905	22.73	24.00	1.340	0.05	0.069	0.092
	LTE Band 25	20M	QPSK	1	49	Right Tilted	0mm	26590	1905	23.60	25.00	1.380	0.03	0.059	0.081
	LTE Band 25	20M	QPSK	50	50	Right Tilted	0mm	26590	1905	22.73	24.00	1.340	0.16	0.047	0.063
	LTE Band 25	20M	QPSK	1	49	Left Cheek	0mm	26590	1905	23.60	25.00	1.380	-0.12	0.182	0.251
12	LTE Band 25	20M	QPSK	1	49	Left Cheek	0mm	26140	1860	23.54	25.00	1.400	-0.04	0.184	0.258
	LTE Band 25	20M	QPSK	1	49	Left Cheek	0mm	26340	1880	23.27	25.00	1.489	0.01	0.169	0.252
	LTE Band 25	20M	QPSK	50	50	Left Cheek	0mm	26590	1905	22.73	24.00	1.340	-0.05	0.144	0.193
	LTE Band 25	20M	QPSK	1	49	Left Tilted	0mm	26590	1905	23.60	25.00	1.380	-0.01	0.027	0.037
	LTE Band 25	20M	QPSK	50	50	Left Tilted	0mm	26590	1905	22.73	24.00	1.340	0.15	0.020	0.027
13	LTE Band 26	15M	QPSK	1	37	Right Cheek	0mm	26865	831.5	24.15	25.00	1.216	-0.11	0.264	0.321
	LTE Band 26	15M	QPSK	36	0	Right Cheek	0mm	26865	831.5	22.99	24.00	1.262	0.11	0.221	0.279
	LTE Band 26	15M	QPSK	1	37	Right Tilted	0mm	26865	831.5	24.15	25.00	1.216	0.08	0.139	0.169
	LTE Band 26	15M	QPSK	36	0	Right Tilted	0mm	26865	831.5	22.99	24.00	1.262	0.12	0.108	0.136
	LTE Band 26	15M	QPSK	1	37	Left Cheek	0mm	26865	831.5	24.15	25.00	1.216	0.02	0.167	0.203
	LTE Band 26	15M	QPSK	36	0	Left Cheek	0mm	26865	831.5	22.99	24.00	1.262	-0.01	0.128	0.162
	LTE Band 26	15M	QPSK	1	37	Left Tilted	0mm	26865	831.5	24.15	25.00	1.216	-0.09	0.142	0.173
	LTE Band 26	15M	QPSK	36	0	Left Tilted	0mm	26865	831.5	22.99	24.00	1.262	-0.07	0.114	0.144



<WLAN SAR>

Plot No.	Band	Mode	Test Position	Gap (mm)	Antenna	Ch.	Freq. (MHz)	Average Power (dBm)	Tune-Up Limit (dBm)	Tune-up Scaling Factor	Duty Cycle %	Duty Cycle Scaling Factor	Power Drift (dB)	Measured 1g SAR (W/kg)	Reported 1g SAR (W/kg)
	WLAN2.4GHz	802.11b 1Mbps	Right Cheek	0mm	Ant 1	11	2462	18.13	18.30	1.040	98.62	1.014	0.17	0.049	0.052
	WLAN2.4GHz	802.11b 1Mbps	Right Tilted	0mm	Ant 1	11	2462	18.13	18.30	1.040	98.62	1.014	-0.15	0.020	0.021
	WLAN2.4GHz	802.11b 1Mbps	Left Cheek	0mm	Ant 1	11	2462	18.13	18.30	1.040	98.62	1.014	-0.18	0.019	0.020
	WLAN2.4GHz	802.11b 1Mbps	Left Tilted	0mm	Ant 1	11	2462	18.13	18.30	1.040	98.62	1.014	0.1	0.025	0.026
	WLAN2.4GHz	802.11b 1Mbps	Right Cheek	0mm	Ant 2	6	2437	18.72	19.10	1.091	98.62	1.014	-0.02	0.141	0.156
	WLAN2.4GHz	802.11b 1Mbps	Right Tilted	0mm	Ant 2	6	2437	18.72	19.10	1.091	98.62	1.014	-0.11	0.126	0.139
	WLAN2.4GHz	802.11b 1Mbps	Left Cheek	0mm	Ant 2	6	2437	18.72	19.10	1.091	98.62	1.014	0.18	0.241	0.267
	WLAN2.4GHz	802.11b 1Mbps	Left Cheek	0mm	Ant 2	1	2412	17.94	19.10	1.306	98.62	1.014	0.02	0.176	0.233
14	WLAN2.4GHz	802.11b 1Mbps	Left Cheek	0mm	Ant 2	11	2462	18.23	19.10	1.222	98.62	1.014	0.14	0.246	0.305
	WLAN2.4GHz	802.11b 1Mbps	Left Tilted	0mm	Ant 2	6	2437	18.72	19.10	1.091	98.62	1.014	0.11	0.223	0.247
	WLAN5GHz	802.11a 6Mbps	Right Cheek	0mm	Ant 1	60	5300	16.09	16.10	1.002	92.86	1.077	-0.02	0.007	0.008
	WLAN5GHz	802.11a 6Mbps	Right Tilted	0mm	Ant 1	60	5300	16.09	16.10	1.002	92.86	1.077	-0.08	0.011	0.012
	WLAN5GHz	802.11a 6Mbps	Left Cheek	0mm	Ant 1	60	5300	16.09	16.10	1.002	92.86	1.077	-0.02	0.009	0.010
	WLAN5GHz	802.11a 6Mbps	Left Tilted	0mm	Ant 1	60	5300	16.09	16.10	1.002	92.86	1.077	-0.02	0.010	0.011
	WLAN5GHz	802.11a 6Mbps	Right Cheek	0mm	Ant 2	60	5300	17.56	17.80	1.056	92.86	1.077	-0.12	0.025	0.028
	WLAN5GHz	802.11a 6Mbps	Right Tilted	0mm	Ant 2	60	5300	17.56	17.80	1.056	92.86	1.077	0.17	0.032	0.036
15	WLAN5GHz	802.11a 6Mbps	Left Cheek	0mm	Ant 2	60	5300	17.56	17.80	1.056	92.86	1.077	-0.12	0.095	0.108
	WLAN5GHz	802.11a 6Mbps	Left Cheek	0mm	Ant 2	52	5260	17.55	17.80	1.059	92.86	1.077	0.08	0.075	0.086
	WLAN5GHz	802.11a 6Mbps	Left Tilted	0mm	Ant 2	60	5300	17.56	17.80	1.056	92.86	1.077	0.11	0.078	0.089
	WLAN5GHz	802.11a 6Mbps	Right Cheek	0mm	Ant 1	116	5580	15.84	16.10	1.061	92.86	1.077	0.1	0.065	0.074
	WLAN5GHz	802.11a 6Mbps	Right Tilted	0mm	Ant 1	116	5580	15.84	16.10	1.061	92.86	1.077	0.15	0.031	0.035
	WLAN5GHz	802.11a 6Mbps	Left Cheek	0mm	Ant 1	116	5580	15.84	16.10	1.061	92.86	1.077	0.11	0.016	0.018
	WLAN5GHz	802.11a 6Mbps	Left Tilted	0mm	Ant 1	116	5580	15.84	16.10	1.061	92.86	1.077	-0.11	0.012	0.014
	WLAN5GHz	802.11a 6Mbps	Right Cheek	0mm	Ant 2	100	5500	17.77	17.80	1.007	92.86	1.077	-0.01	0.026	0.028
	WLAN5GHz	802.11a 6Mbps	Right Tilted	0mm	Ant 2	100	5500	17.77	17.80	1.007	92.86	1.077	0.1	0.033	0.036
	WLAN5GHz	802.11a 6Mbps	Left Cheek	0mm	Ant 2	100	5500	17.77	17.80	1.007	92.86	1.077	-0.13	0.084	0.091
	WLAN5GHz	802.11a 6Mbps	Left Cheek	0mm	Ant 2	116	5580	17.54	17.80	1.061	92.86	1.077	-0.13	0.077	0.088
	WLAN5GHz	802.11a 6Mbps	Left Cheek	0mm	Ant 2	132	5660	17.67	17.80	1.030	92.86	1.077	0.16	0.062	0.069
16	WLAN5GHz	802.11a 6Mbps	Left Cheek	0mm	Ant 2	144	5720	17.59	17.80	1.049	92.86	1.077	-0.13	0.087	0.098
	WLAN5GHz	802.11a 6Mbps	Left Tilted	0mm	Ant 2	100	5500	17.77	17.80	1.007	92.86	1.077	0.16	0.080	0.087
	WLAN5GHz	802.11a 6Mbps	Right Cheek	0mm	Ant 1	157	5785	15.93	16.10	1.040	92.86	1.077	0.04	0.062	0.069
	WLAN5GHz	802.11a 6Mbps	Right Cheek	0mm	Ant 1	149	5745	15.84	16.10	1.061	92.86	1.077	0.11	0.092	0.105
17	WLAN5GHz	802.11a 6Mbps	Right Cheek	0mm	Ant 1	165	5825	15.88	16.10	1.052	92.86	1.077	0.09	0.103	0.117
	WLAN5GHz	802.11a 6Mbps	Right Tilted	0mm	Ant 1	157	5785	15.93	16.10	1.040	92.86	1.077	0.15	0.024	0.027
	WLAN5GHz	802.11a 6Mbps	Left Cheek	0mm	Ant 1	157	5785	15.93	16.10	1.040	92.86	1.077	0.05	0.015	0.017
	WLAN5GHz	802.11a 6Mbps	Left Tilted	0mm	Ant 1	157	5785	15.93	16.10	1.040	92.86	1.077	-0.12	0.023	0.026
	WLAN5GHz	802.11a 6Mbps	Right Cheek	0mm	Ant 2	157	5785	17.60	17.80	1.047	92.86	1.077	-0.11	0.014	0.016
	WLAN5GHz	802.11a 6Mbps	Right Tilted	0mm	Ant 2	157	5785	17.60	17.80	1.047	92.86	1.077	-0.09	0.015	0.017
	WLAN5GHz	802.11a 6Mbps	Left Cheek	0mm	Ant 2	157	5785	17.60	17.80	1.047	92.86	1.077	0.19	0.045	0.051
	WLAN5GHz	802.11a 6Mbps	Left Tilted	0mm	Ant 2	157	5785	17.60	17.80	1.047	92.86	1.077	0.09	0.053	0.060



15.2 Hotspot SAR

<GSM SAR>

Plot No.	Band	Mode	Test Position	Gap (mm)	Power Reduction	Ch.	Freq. (MHz)	Average Power (dBm)	Tune-Up Limit (dBm)	Tune-up Scaling Factor	Power Drift (dB)	Measured 1g SAR (W/kg)	Reported 1g SAR (W/kg)
	GSM850	GPRS (4 Tx slots)	Front	10mm	-	128	824.2	31.79	32.00	1.050	-0.15	0.510	0.535
	GSM850	GPRS (4 Tx slots)	Back	10mm	-	128	824.2	31.79	32.00	1.050	-0.14	0.981	1.030
	GSM850	GPRS (4 Tx slots)	Back	10mm	-	189	836.4	31.65	32.00	1.084	-0.11	1.020	1.106
	GSM850	GPRS (4 Tx slots)	Back	10mm	-	251	848.8	31.67	32.00	1.079	-0.14	1.030	1.111
	GSM850	GPRS (4 Tx slots)	Left Side	10mm	-	128	824.2	31.79	32.00	1.050	-0.04	0.528	0.554
	GSM850	GPRS (4 Tx slots)	Right Side	10mm	-	128	824.2	31.79	32.00	1.050	-0.08	0.994	1.043
	GSM850	GPRS (4 Tx slots)	Right Side	10mm	-	189	836.4	31.65	32.00	1.084	-0.08	0.983	1.066
18	GSM850	GPRS (4 Tx slots)	Right Side	10mm	-	251	848.8	31.67	32.00	1.079	-0.05	1.060	1.144
	GSM850	GPRS (4 Tx slots)	Bottom Side	10mm	-	128	824.2	31.79	32.00	1.050	0	0.555	0.582
	GSM1900	GPRS (4 Tx slots)	Front	10mm	ON	512	1850.2	22.55	23.50	1.245	-0.07	0.129	0.161
	GSM1900	GPRS (4 Tx slots)	Back	10mm	ON	512	1850.2	22.55	23.50	1.245	0.07	0.477	0.594
	GSM1900	GPRS (4 Tx slots)	Left Side	10mm	ON	512	1850.2	22.55	23.50	1.245	0.08	0.051	0.063
	GSM1900	GPRS (4 Tx slots)	Right Side	10mm	ON	512	1850.2	22.55	23.50	1.245	-0.1	0.029	0.036
	GSM1900	GPRS (4 Tx slots)	Bottom Side	10mm	ON	512	1850.2	22.50	23.50	1.259	-0.03	0.846	1.065
	GSM1900	GPRS (4 Tx slots)	Bottom Side	10mm	ON	661	1880	22.50	23.50	1.259	-0.14	0.958	1.206
19	GSM1900	GPRS (4 Tx slots)	Bottom Side	10mm	ON	810	1909.8	22.45	23.50	1.274	-0.06	1.020	1.299

<WCDMA SAR>

Plot No.	Band	Mode	Test Position	Gap (mm)	Power Reduction	Ch.	Freq. (MHz)	Average Power (dBm)	Tune-Up Limit (dBm)	Tune-up Scaling Factor	Power Drift (dB)	Measured 1g SAR (W/kg)	Reported 1g SAR (W/kg)
	WCDMA II	RMC 12.2Kbps	Front	10mm	ON	9538	1907.6	19.39	20.00	1.151	-0.01	0.139	0.160
	WCDMA II	RMC 12.2Kbps	Back	10mm	ON	9538	1907.6	19.39	20.00	1.151	-0.01	0.484	0.557
	WCDMA II	RMC 12.2Kbps	Left Side	10mm	ON	9538	1907.6	19.39	20.00	1.151	0.04	0.035	0.040
	WCDMA II	RMC 12.2Kbps	Right Side	10mm	ON	9538	1907.6	19.39	20.00	1.151	0	0.023	0.026
	WCDMA II	RMC 12.2Kbps	Bottom Side	10mm	ON	9538	1907.6	19.39	20.00	1.151	0	0.935	1.076
	WCDMA II	RMC 12.2Kbps	Bottom Side	10mm	ON	9400	1880	19.18	20.00	1.208	-0.04	0.952	1.150
20	WCDMA II	RMC 12.2Kbps	Bottom Side	10mm	ON	9262	1852.4	19.22	20.00	1.197	0.07	0.965	1.155
	WCDMA IV	RMC 12.2Kbps	Front	10mm	ON	1513	1752.6	19.15	20.00	1.216	-0.09	0.137	0.167
	WCDMA IV	RMC 12.2Kbps	Back	10mm	ON	1513	1752.6	19.15	20.00	1.216	-0.01	0.535	0.651
	WCDMA IV	RMC 12.2Kbps	Left Side	10mm	ON	1513	1752.6	19.15	20.00	1.216	0.07	0.067	0.081
	WCDMA IV	RMC 12.2Kbps	Right Side	10mm	ON	1513	1752.6	19.15	20.00	1.216	-0.11	0.029	0.035
21	WCDMA IV	RMC 12.2Kbps	Bottom Side	10mm	ON	1312	1752.6	18.59	20.00	1.384	-0.13	0.770	1.065
	WCDMA IV	RMC 12.2Kbps	Bottom Side	10mm	ON	1413	1732.6	18.85	20.00	1.303	-0.06	0.719	0.937
	WCDMA IV	RMC 12.2Kbps	Bottom Side	10mm	ON	1513	1752.6	19.15	20.00	1.216	-0.08	0.778	0.946
	WCDMA V	RMC 12.2Kbps	Front	10mm	-	4233	846.6	23.90	25.50	1.445	-0.04	0.207	0.299
	WCDMA V	RMC 12.2Kbps	Back	10mm	-	4233	846.6	23.90	25.50	1.445	0.01	0.355	0.513
	WCDMA V	RMC 12.2Kbps	Left Side	10mm	-	4233	846.6	23.90	25.50	1.445	0.06	0.205	0.296
	WCDMA V	RMC 12.2Kbps	Right Side	10mm	-	4233	846.6	23.90	25.50	1.445	0.03	0.418	0.604
22	WCDMA V	RMC 12.2Kbps	Right Side	10mm	-	4132	826.4	23.73	25.50	1.503	-0.01	0.440	0.661
	WCDMA V	RMC 12.2Kbps	Right Side	10mm	-	4182	836.4	23.85	25.50	1.462	0.1	0.424	0.620
	WCDMA V	RMC 12.2Kbps	Bottom Side	10mm	-	4233	846.6	23.90	25.50	1.445	-0.05	0.304	0.439



<CDMA SAR>

Plot No.	Band	Mode	Test Position	Gap (mm)	Power Reduction	Ch.	Freq. (MHz)	Average Power (dBm)	Tune-Up Limit (dBm)	Tune-up Scaling Factor	Power Drift (dB)	Measured 1g SAR (W/kg)	Reported 1g SAR (W/kg)
	CDMA BC0	RTAP 153.6Kbps	Front	10mm	-	777	848.31	24.17	25.50	1.358	-0.03	0.243	0.330
	CDMA BC0	RTAP 153.6Kbps	Back	10mm	-	777	848.31	24.17	25.50	1.358	-0.07	0.409	0.556
	CDMA BC0	RTAP 153.6Kbps	Left Side	10mm	-	777	848.31	24.17	25.50	1.358	-0.07	0.249	0.338
23	CDMA BC0	RTAP 153.6Kbps	Right Side	10mm	-	777	848.31	24.17	25.50	1.358	0.07	0.477	0.648
	CDMA BC0	RTAP 153.6Kbps	Bottom Side	10mm	-	777	848.31	24.17	25.50	1.358	-0.07	0.333	0.452
	CDMA BC1	RTAP 153.6Kbps	Front	10mm	ON	1175	1908.75	19.99	20.50	1.125	-0.11	0.129	0.145
	CDMA BC1	RTAP 153.6Kbps	Back	10mm	ON	1175	1908.75	19.99	20.50	1.125	-0.05	0.446	0.502
	CDMA BC1	RTAP 153.6Kbps	Left Side	10mm	ON	1175	1908.75	19.99	20.50	1.125	-0.14	0.034	0.038
	CDMA BC1	RTAP 153.6Kbps	Right Side	10mm	ON	1175	1908.75	19.99	20.50	1.125	0.15	0.031	0.035
	CDMA BC1	RTAP 153.6Kbps	Bottom Side	10mm	ON	1175	1908.75	19.99	20.50	1.125	-0.01	0.871	0.980
	CDMA BC1	RTAP 153.6Kbps	Bottom Side	10mm	ON	25	1851.25	19.72	20.50	1.197	-0.01	0.902	1.079
24	CDMA BC1	RTAP 153.6Kbps	Bottom Side	10mm	ON	600	1880	19.79	20.50	1.178	0.01	0.966	1.138
	CDMA BC10	RTAP 153.6Kbps	Front	10mm	-	580	820.5	24.48	25.50	1.265	-0.06	0.226	0.286
	CDMA BC10	RTAP 153.6Kbps	Back	10mm	-	580	820.5	24.48	25.50	1.265	-0.03	0.393	0.497
	CDMA BC10	RTAP 153.6Kbps	Left Side	10mm	-	580	820.5	24.48	25.50	1.265	-0.01	0.243	0.307
25	CDMA BC10	RTAP 153.6Kbps	Right Side	10mm	-	580	820.5	24.48	25.50	1.265	-0.02	0.418	0.529
	CDMA BC10	RTAP 153.6Kbps	Bottom Side	10mm	-	580	820.5	24.48	25.50	1.265	-0.15	0.220	0.278



<LTE SAR>

Plot No.	Band	BW (MHz)	Modulation	RB Size	RB offset	Test Position	Gap (mm)	Power Reduction	Ch.	Freq. (MHz)	Average Power (dBm)	Tune-Up Limit (dBm)	Tune-up Scaling Factor	Power Drift (dB)	Measured 1g SAR (W/kg)	Reported 1g SAR (W/kg)
	LTE Band 4	20M	QPSK	1	49	Front	10mm	ON	20175	1732.5	20.91	21.50	1.146	-0.13	0.185	0.212
	LTE Band 4	20M	QPSK	50	50	Front	10mm	ON	20175	1732.5	19.73	20.50	1.194	-0.04	0.149	0.178
	LTE Band 4	20M	QPSK	1	49	Back	10mm	ON	20175	1732.5	20.91	21.50	1.146	0.13	0.632	0.724
	LTE Band 4	20M	QPSK	50	50	Back	10mm	ON	20175	1732.5	19.73	20.50	1.194	-0.01	0.509	0.608
	LTE Band 4	20M	QPSK	1	49	Left Side	10mm	ON	20175	1732.5	20.91	21.50	1.146	-0.05	0.091	0.104
	LTE Band 4	20M	QPSK	50	50	Left Side	10mm	ON	20175	1732.5	19.73	20.50	1.194	-0.11	0.071	0.085
	LTE Band 4	20M	QPSK	1	49	Right Side	10mm	ON	20175	1732.5	20.91	21.50	1.146	-0.14	0.038	0.044
	LTE Band 4	20M	QPSK	50	50	Right Side	10mm	ON	20175	1732.5	19.73	20.50	1.194	-0.03	0.029	0.035
26	LTE Band 4	20M	QPSK	1	49	Bottom Side	10mm	ON	20175	1732.5	20.91	21.50	1.146	0.09	1.040	1.191
	LTE Band 4	20M	QPSK	50	50	Bottom Side	10mm	ON	20175	1732.5	19.73	20.50	1.194	-0.02	0.843	1.007
	LTE Band 4	20M	QPSK	100	0	Bottom Side	10mm	ON	20175	1732.5	19.57	20.50	1.239	-0.05	0.810	1.003
	LTE Band 12	10M	QPSK	1	0	Front	10mm	-	23095	707.5	24.18	25.00	1.208	-0.1	0.221	0.267
	LTE Band 12	10M	QPSK	25	0	Front	10mm	-	23095	707.5	23.09	24.00	1.233	-0.02	0.175	0.216
	LTE Band 12	10M	QPSK	1	0	Back	10mm	-	23095	707.5	24.18	25.00	1.208	-0.13	0.355	0.429
	LTE Band 12	10M	QPSK	25	0	Back	10mm	-	23095	707.5	23.09	24.00	1.233	-0.17	0.284	0.350
	LTE Band 12	10M	QPSK	1	0	Left Side	10mm	-	23095	707.5	24.18	25.00	1.208	-0.1	0.250	0.302
	LTE Band 12	10M	QPSK	25	0	Left Side	10mm	-	23095	707.5	23.09	24.00	1.233	0	0.192	0.237
27	LTE Band 12	10M	QPSK	1	0	Right Side	10mm	-	23095	707.5	24.18	25.00	1.208	-0.02	0.381	0.460
	LTE Band 12	10M	QPSK	25	0	Right Side	10mm	-	23095	707.5	23.09	24.00	1.233	0	0.305	0.376
	LTE Band 12	10M	QPSK	1	0	Bottom Side	10mm	-	23095	707.5	24.18	25.00	1.208	0.04	0.124	0.150
	LTE Band 12	10M	QPSK	25	0	Bottom Side	10mm	-	23095	707.5	23.09	24.00	1.233	0.01	0.101	0.125
	LTE Band 13	10M	QPSK	1	25	Front	10mm	-	23230	782	24.03	25.00	1.250	0.08	0.234	0.293
	LTE Band 13	10M	QPSK	25	0	Front	10mm	-	23230	782	22.84	24.00	1.306	0.07	0.179	0.234
	LTE Band 13	10M	QPSK	1	25	Back	10mm	-	23230	782	24.03	25.00	1.250	0.06	0.343	0.429
	LTE Band 13	10M	QPSK	25	0	Back	10mm	-	23230	782	22.84	24.00	1.306	0.02	0.267	0.349
	LTE Band 13	10M	QPSK	1	25	Left Side	10mm	-	23230	782	24.03	25.00	1.250	-0.02	0.226	0.283
	LTE Band 13	10M	QPSK	25	0	Left Side	10mm	-	23230	782	22.84	24.00	1.306	0	0.179	0.234
28	LTE Band 13	10M	QPSK	1	25	Right Side	10mm	-	23230	782	24.03	25.00	1.250	-0.13	0.387	0.484
	LTE Band 13	10M	QPSK	25	0	Right Side	10mm	-	23230	782	22.84	24.00	1.306	-0.09	0.301	0.393
	LTE Band 13	10M	QPSK	1	25	Bottom Side	10mm	-	23230	782	24.03	25.00	1.250	0.01	0.147	0.184
	LTE Band 13	10M	QPSK	25	0	Bottom Side	10mm	-	23230	782	22.84	24.00	1.306	0.03	0.103	0.135
	LTE Band 25	20M	QPSK	1	49	Front	10mm	ON	26590	1905	18.48	19.00	1.127	0.02	0.121	0.136
	LTE Band 25	20M	QPSK	50	50	Front	10mm	ON	26590	1905	17.55	18.00	1.109	-0.05	0.096	0.106
	LTE Band 25	20M	QPSK	1	49	Back	10mm	ON	26590	1905	18.48	19.00	1.127	-0.17	0.432	0.487
	LTE Band 25	20M	QPSK	50	50	Back	10mm	ON	26590	1905	17.55	18.00	1.109	-0.06	0.335	0.372
	LTE Band 25	20M	QPSK	1	49	Left Side	10mm	ON	26590	1905	18.48	19.00	1.127	-0.11	0.030	0.034
	LTE Band 25	20M	QPSK	50	50	Left Side	10mm	ON	26590	1905	17.55	18.00	1.109	-0.17	0.023	0.026
	LTE Band 25	20M	QPSK	1	49	Right Side	10mm	ON	26590	1905	18.48	19.00	1.127	-0.18	0.026	0.029
	LTE Band 25	20M	QPSK	50	50	Right Side	10mm	ON	26590	1905	17.55	18.00	1.109	-0.06	0.021	0.023
	LTE Band 25	20M	QPSK	1	49	Bottom Side	10mm	ON	26590	1905	18.48	19.00	1.127	-0.05	0.841	0.948
29	LTE Band 25	20M	QPSK	1	49	Bottom Side	10mm	ON	26340	1880	18.02	19.00	1.253	-0.02	0.867	1.086
	LTE Band 25	20M	QPSK	1	49	Bottom Side	10mm	ON	26140	1860	18.25	19.00	1.189	-0.06	0.889	1.057
	LTE Band 25	20M	QPSK	50	50	Bottom Side	10mm	ON	26590	1905	17.55	18.00	1.109	-0.01	0.681	0.755
	LTE Band 25	20M	QPSK	100	0	Bottom Side	10mm	ON	26590	1905	17.51	18.00	1.119	0.04	0.653	0.731
	LTE Band 26	15M	QPSK	1	37	Front	10mm	-	26865	831.5	24.15	25.00	1.216	-0.16	0.199	0.242
	LTE Band 26	15M	QPSK	36	0	Front	10mm	-	26865	831.5	22.99	24.00	1.262	0	0.163	0.206
	LTE Band 26	15M	QPSK	1	37	Back	10mm	-	26865	831.5	24.15	25.00	1.216	0.13	0.294	0.358
	LTE Band 26	15M	QPSK	36	0	Back	10mm	-	26865	831.5	22.99	24.00	1.262	-0.02	0.238	0.300
	LTE Band 26	15M	QPSK	1	37	Left Side	10mm	-	26865	831.5	24.15	25.00	1.216	0.16	0.200	0.243
	LTE Band 26	15M	QPSK	36	0	Left Side	10mm	-	26865	831.5	22.99	24.00	1.262	0	0.152	0.192
30	LTE Band 26	15M	QPSK	1	37	Right Side	10mm	-	26865	831.5	24.15	25.00	1.216	-0.09	0.382	0.465
	LTE Band 26	15M	QPSK	36	0	Right Side	10mm	-	26865	831.5	22.99	24.00	1.262	-0.06	0.309	0.390
	LTE Band 26	15M	QPSK	1	37	Bottom Side	10mm	-	26865	831.5	24.15	25.00	1.216	-0.1	0.227	0.276
	LTE Band 26	15M	QPSK	36	0	Bottom Side	10mm	-	26865	831.5	22.99	24.00	1.262	0.01	0.181	0.228



<WLAN SAR>

Plot No.	Band	Mode	Test Position	Gap (mm)	Antenna	Ch.	Freq. (MHz)	Average Power (dBm)	Tune-Up Limit (dBm)	Tune-up Scaling Factor	Duty Cycle %	Duty Cycle Scaling Factor	Power Drift (dB)	Measured 1g SAR (W/kg)	Reported 1g SAR (W/kg)
	WLAN2.4GHz	802.11b 1Mbps	Front	10mm	Ant 1	11	2462	18.13	18.30	1.040	98.62	1.014	-0.1	0.018	0.019
	WLAN2.4GHz	802.11b 1Mbps	Back	10mm	Ant 1	11	2462	18.13	18.30	1.040	98.62	1.014	0.13	0.201	0.212
	WLAN2.4GHz	802.11b 1Mbps	Left Side	10mm	Ant 1	11	2462	18.13	18.30	1.040	98.62	1.014	-0.07	0.113	0.119
	WLAN2.4GHz	802.11b 1Mbps	Right Side	10mm	Ant 1	11	2462	18.13	18.30	1.040	98.62	1.014	0.01	0.019	0.020
	WLAN2.4GHz	802.11b 1Mbps	Top Side	10mm	Ant 1	11	2462	18.13	18.30	1.040	98.62	1.014	-0.12	0.017	0.018
	WLAN2.4GHz	802.11b 1Mbps	Front	10mm	Ant 2	6	2437	18.72	19.10	1.091	98.62	1.014	-0.14	0.080	0.089
	WLAN2.4GHz	802.11b 1Mbps	Back	10mm	Ant 2	6	2437	18.72	19.10	1.091	98.62	1.014	-0.01	0.145	0.160
	WLAN2.4GHz	802.11b 1Mbps	Left Side	10mm	Ant 2	6	2437	18.72	19.10	1.091	98.62	1.014	-0.19	0.016	0.018
31	WLAN2.4GHz	802.11b 1Mbps	Right Side	10mm	Ant 2	6	2437	18.72	19.10	1.091	98.62	1.014	-0.11	0.297	0.329
	WLAN2.4GHz	802.11b 1Mbps	Right Side	10mm	Ant 2	1	2412	17.94	19.10	1.306	98.62	1.014	-0.18	0.232	0.307
	WLAN2.4GHz	802.11b 1Mbps	Right Side	10mm	Ant 2	11	2462	18.23	19.10	1.222	98.62	1.014	-0.13	0.263	0.326
	WLAN2.4GHz	802.11b 1Mbps	Top Side	10mm	Ant 2	6	2437	18.72	19.10	1.091	98.62	1.014	-0.11	0.182	0.201
	WLAN5GHz	802.11a 6Mbps	Front	10mm	Ant 1	48	5240	15.98	16.10	1.028	92.86	1.077	0.08	0.006	0.007
	WLAN5GHz	802.11a 6Mbps	Back	10mm	Ant 1	48	5240	15.98	16.10	1.028	92.86	1.077	-0.16	0.181	0.200
	WLAN5GHz	802.11a 6Mbps	Left Side	10mm	Ant 1	48	5240	15.98	16.10	1.028	92.86	1.077	0.15	0.158	0.175
	WLAN5GHz	802.11a 6Mbps	Right Side	10mm	Ant 1	48	5240	15.98	16.10	1.028	92.86	1.077	-0.15	0.009	0.010
	WLAN5GHz	802.11a 6Mbps	Top Side	10mm	Ant 1	48	5240	15.98	16.10	1.028	92.86	1.077	0.117	0.044	0.049
	WLAN5GHz	802.11a 6Mbps	Front	10mm	Ant 2	44	5220	17.61	17.80	1.044	92.86	1.077	-0.17	0.030	0.034
32	WLAN5GHz	802.11a 6Mbps	Back	10mm	Ant 2	44	5220	17.61	17.80	1.044	92.86	1.077	-0.031	0.429	0.482
	WLAN5GHz	802.11a 6Mbps	Back	10mm	Ant 2	48	5240	17.60	17.80	1.047	92.86	1.077	-0.012	0.410	0.462
	WLAN5GHz	802.11a 6Mbps	Left Side	10mm	Ant 2	44	5220	17.61	17.80	1.044	92.86	1.077	-0.12	0.014	0.016
	WLAN5GHz	802.11a 6Mbps	Right Side	10mm	Ant 2	44	5220	17.61	17.80	1.044	92.86	1.077	-0.081	0.395	0.444
	WLAN5GHz	802.11a 6Mbps	Top Side	10mm	Ant 2	44	5220	17.61	17.80	1.044	92.86	1.077	-0.123	0.276	0.310
	WLAN5GHz	802.11a 6Mbps	Front	10mm	Ant 1	157	5785	15.93	16.10	1.040	92.86	1.077	-0.19	0.021	0.024
	WLAN5GHz	802.11a 6Mbps	Back	10mm	Ant 1	157	5785	15.93	16.10	1.040	92.86	1.077	-0.12	0.145	0.162
	WLAN5GHz	802.11a 6Mbps	Left Side	10mm	Ant 1	157	5785	15.93	16.10	1.040	92.86	1.077	-0.05	0.239	0.268
	WLAN5GHz	802.11a 6Mbps	Right Side	10mm	Ant 1	157	5785	15.93	16.10	1.040	92.86	1.077	0	0.008	0.009
	WLAN5GHz	802.11a 6Mbps	Top Side	10mm	Ant 1	157	5785	15.93	16.10	1.040	92.86	1.077	-0.06	0.031	0.035
	WLAN5GHz	802.11a 6Mbps	Front	10mm	Ant 2	157	5785	17.60	17.80	1.047	92.86	1.077	0.17	0.033	0.037
	WLAN5GHz	802.11a 6Mbps	Back	10mm	Ant 2	157	5785	17.60	17.80	1.047	92.86	1.077	-0.11	0.452	0.510
	WLAN5GHz	802.11a 6Mbps	Back	10mm	Ant 2	149	5745	17.53	17.80	1.064	92.86	1.077	-0.09	0.447	0.512
33	WLAN5GHz	802.11a 6Mbps	Back	10mm	Ant 2	165	5825	17.57	17.80	1.054	92.86	1.077	-0.12	0.485	0.551
	WLAN5GHz	802.11a 6Mbps	Left Side	10mm	Ant 2	157	5785	17.60	17.80	1.047	92.86	1.077	-0.1	0.009	0.011
	WLAN5GHz	802.11a 6Mbps	Right Side	10mm	Ant 2	157	5785	17.60	17.80	1.047	92.86	1.077	-0.14	0.446	0.503
	WLAN5GHz	802.11a 6Mbps	Top Side	10mm	Ant 2	157	5785	17.60	17.80	1.047	92.86	1.077	-0.07	0.371	0.418



15.3 Body Worn Accessory SAR

<GSM SAR>

Plot No.	Band	Mode	Test Position	Gap (mm)	Accessories	Ch.	Freq. (MHz)	Average Power (dBm)	Tune-Up Limit (dBm)	Tune-up Scaling Factor	Power Drift (dB)	Measured 1g SAR (W/kg)	Reported 1g SAR (W/kg)
	GSM850	GPRS (4 Tx slots)	Front	15mm	-	128	824.2	31.79	32.00	1.050	0.02	0.464	0.487
	GSM850	GPRS (4 Tx slots)	Front	0mm	Rigid Holster	128	824.2	31.79	32.00	1.050	-0.15	0.414	0.435
	GSM850	GPRS (4 Tx slots)	Front	0mm	Soft Holster	128	824.2	31.79	32.00	1.050	0.04	0.856	0.898
34	GSM850	GPRS (4 Tx slots)	Front	0mm	Soft Holster	189	836.4	31.65	32.00	1.084	-0.1	1.020	1.106
	GSM850	GPRS (4 Tx slots)	Front	0mm	Soft Holster	251	848.8	31.67	32.00	1.079	0.16	1.020	1.101
	GSM850	GPRS (4 Tx slots)	Back	15mm	-	128	824.2	31.79	32.00	1.050	-0.07	0.701	0.736
	GSM1900	GPRS (3 Tx slots)	Front	15mm	-	661	1880	29.41	30.00	1.146	0.01	0.286	0.328
	GSM1900	GPRS (3 Tx slots)	Front	0mm	Rigid Holster	661	1880	29.41	30.00	1.146	-0.06	0.627	0.718
	GSM1900	GPRS (3 Tx slots)	Front	0mm	Soft Holster	661	1880	29.41	30.00	1.146	-0.05	0.983	1.126
	GSM1900	GPRS (3 Tx slots)	Front	0mm	Soft Holster	512	1850.2	29.34	30.00	1.164	-0.02	1.010	1.176
	GSM1900	GPRS (3 Tx slots)	Front	0mm	Soft Holster	810	1909.8	29.30	30.00	1.175	-0.08	0.966	1.135
	GSM1900	GPRS (3 Tx slots)	Back	15mm	-	661	1880	29.41	30.00	1.146	-0.02	1.110	1.272
35	GSM1900	GPRS (3 Tx slots)	Back	15mm	-	512	1850.2	29.34	30.00	1.164	-0.04	1.100	1.281
	GSM1900	GPRS (3 Tx slots)	Back	15mm	-	810	1909.8	29.30	30.00	1.175	-0.05	1.060	1.245
	GSM1900	GPRS (3 Tx slots)	Back	15mm	Earphone 1	512	1850.2	29.34	30.00	1.164	0.08	0.273	0.318
	GSM1900	GPRS (3 Tx slots)	Back	15mm	Earphone 2	512	1850.2	29.34	30.00	1.164	-0.07	0.262	0.305

<WCDMA SAR>

Plot No.	Band	Mode	Test Position	Gap (mm)	Accessories	Ch.	Freq. (MHz)	Average Power (dBm)	Tune-Up Limit (dBm)	Tune-up Scaling Factor	Power Drift (dB)	Measured 1g SAR (W/kg)	Reported 1g SAR (W/kg)
	WCDMA II	RMC 12.2Kbps	Front	15mm	-	9262	1852.4	24.39	25.50	1.291	-0.05	0.236	0.305
	WCDMA II	RMC 12.2Kbps	Front	0mm	Rigid Holster	9262	1852.4	24.39	25.50	1.291	-0.01	0.566	0.731
	WCDMA II	RMC 12.2Kbps	Front	0mm	Soft Holster	9262	1852.4	24.39	25.50	1.291	0.14	0.867	1.119
	WCDMA II	RMC 12.2Kbps	Front	0mm	Soft Holster	9400	1880	24.17	25.50	1.358	-0.06	0.835	1.134
	WCDMA II	RMC 12.2Kbps	Front	0mm	Soft Holster	9538	1907.6	24.39	25.50	1.291	-0.06	0.817	1.055
	WCDMA II	RMC 12.2Kbps	Back	15mm	-	9262	1852.4	24.39	25.50	1.291	-0.04	0.917	1.184
36	WCDMA II	RMC 12.2Kbps	Back	15mm	-	9400	1880	24.17	25.50	1.358	-0.03	0.895	1.216
	WCDMA II	RMC 12.2Kbps	Back	15mm	-	9538	1907.6	24.39	25.50	1.291	-0.09	0.852	1.100
	WCDMA II	RMC 12.2Kbps	Back	15mm	Earphone 1	9400	1880	24.17	25.50	1.358	0	0.198	0.269
	WCDMA II	RMC 12.2Kbps	Back	15mm	Earphone 2	9400	1880	24.17	25.50	1.358	-0.03	0.200	0.272
	WCDMA IV	RMC 12.2Kbps	Front	15mm	-	1513	1752.6	23.92	25.00	1.282	0.01	0.254	0.326
	WCDMA IV	RMC 12.2Kbps	Front	0mm	Rigid Holster	1513	1752.6	23.92	25.00	1.282	0.07	0.587	0.753
	WCDMA IV	RMC 12.2Kbps	Front	0mm	Soft Holster	1513	1752.6	23.92	25.00	1.282	-0.04	0.856	1.098
	WCDMA IV	RMC 12.2Kbps	Front	0mm	Soft Holster	1312	1712.4	23.58	25.00	1.387	-0.02	0.782	1.084
	WCDMA IV	RMC 12.2Kbps	Front	0mm	Soft Holster	1413	1732.6	23.72	25.00	1.343	0.05	0.827	1.110
	WCDMA IV	RMC 12.2Kbps	Back	15mm	-	1513	1752.6	23.92	25.00	1.282	0.02	0.959	1.230
	WCDMA IV	RMC 12.2Kbps	Back	15mm	-	1312	1712.4	23.58	25.00	1.387	0	0.868	1.204
37	WCDMA IV	RMC 12.2Kbps	Back	15mm	-	1413	1732.6	23.72	25.00	1.343	-0.06	0.926	1.243
	WCDMA IV	RMC 12.2Kbps	Back	15mm	Earphone 1	1413	1732.6	23.72	25.00	1.343	-0.03	0.188	0.252
	WCDMA IV	RMC 12.2Kbps	Back	15mm	Earphone 2	1413	1732.6	23.72	25.00	1.343	0.07	0.201	0.270
	WCDMA V	RMC 12.2Kbps	Front	15mm	-	4233	846.6	23.90	25.50	1.445	-0.03	0.184	0.266
	WCDMA V	RMC 12.2Kbps	Front	0mm	Rigid Holster	4233	846.6	23.90	25.50	1.445	-0.07	0.214	0.309
38	WCDMA V	RMC 12.2Kbps	Front	0mm	Soft Holster	4233	846.6	23.90	25.50	1.445	-0.11	0.335	0.484
	WCDMA V	RMC 12.2Kbps	Back	15mm	-	4233	846.6	23.90	25.50	1.445	0.01	0.268	0.387
	WCDMA V	RMC 12.2Kbps	Back	15mm	-	4132	826.4	23.73	25.50	1.503	-0.07	0.285	0.428
	WCDMA V	RMC 12.2Kbps	Back	15mm	-	4182	836.4	23.85	25.50	1.462	0.17	0.282	0.412



<CDMA SAR>

Plot No.	Band	Mode	Test Position	Gap (mm)	Accessories	Ch.	Freq. (MHz)	Average Power (dBm)	Tune-Up Limit (dBm)	Tune-up Scaling Factor	Power Drift (dB)	Measured 1g SAR (W/kg)	Reported 1g SAR (W/kg)
	CDMA BC0	1xRTT RC3 SO32	Front	15mm	-	777	848.31	24.16	25.50	1.361	0.03	0.234	0.319
	CDMA BC0	1xRTT RC3 SO32	Front	0mm	Rigid Holster	777	848.31	24.16	25.50	1.361	-0.04	0.272	0.370
39	CDMA BC0	1xRTT RC3 SO32	Front	0mm	Soft Holster	777	848.31	24.16	25.50	1.361	-0.15	0.436	0.594
	CDMA BC0	1xRTT RC3 SO32	Back	15mm	-	777	848.31	24.16	25.50	1.361	-0.06	0.349	0.475
	CDMA BC1	1xRTT RC3 SO32	Front	15mm	-	1175	1908.75	24.81	25.50	1.172	-0.12	0.233	0.273
	CDMA BC1	1xRTT RC3 SO32	Front	0mm	Rigid Holster	1175	1908.75	24.81	25.50	1.172	-0.05	0.434	0.509
	CDMA BC1	1xRTT RC3 SO32	Front	0mm	Soft Holster	1175	1908.75	24.81	25.50	1.172	-0.03	0.579	0.679
	CDMA BC1	1xRTT RC3 SO32	Back	15mm	-	1175	1908.75	24.81	25.50	1.172	0	0.749	0.878
	CDMA BC1	1xRTT RC3 SO32	Back	15mm	-	25	1851.25	24.51	25.50	1.256	-0.05	0.765	0.961
40	CDMA BC1	1xRTT RC3 SO32	Back	15mm	-	600	1880	24.51	25.50	1.256	-0.13	0.797	1.001
	CDMA BC10	1xRTT RC3 SO32	Front	15mm	-	684	823.1	24.13	25.50	1.371	0.14	0.210	0.288
	CDMA BC10	1xRTT RC3 SO32	Front	0mm	Rigid Holster	684	823.1	24.13	25.50	1.371	0.01	0.186	0.255
41	CDMA BC10	1xRTT RC3 SO32	Front	0mm	Soft Holster	684	823.1	24.13	25.50	1.371	0.01	0.340	0.466
	CDMA BC10	1xRTT RC3 SO32	Back	15mm	-	684	823.1	24.13	25.50	1.371	-0.05	0.281	0.385



<LTE SAR>

Plot No.	Band	BW (MHz)	Modulation	RB Size	RB offset	Test Position	Gap (mm)	Accessories	Ch.	Freq. (MHz)	Average Power (dBm)	Tune-Up Limit (dBm)	Tune-up Scaling Factor	Power Drift (dB)	Measured 1g SAR (W/kg)	Reported 1g SAR (W/kg)
	LTE Band 4	20M	QPSK	1	0	Front	15mm	-	20175	1732.5	24.12	25.00	1.225	-0.13	0.207	0.253
	LTE Band 4	20M	QPSK	50	50	Front	15mm	-	20175	1732.5	22.95	24.00	1.274	-0.02	0.171	0.218
	LTE Band 4	20M	QPSK	1	0	Front	0mm	Rigid Holster	20175	1732.5	24.12	25.00	1.225	-0.14	0.477	0.584
	LTE Band 4	20M	QPSK	50	50	Front	0mm	Rigid Holster	20175	1732.5	22.95	24.00	1.274	0.02	0.394	0.502
	LTE Band 4	20M	QPSK	1	0	Front	0mm	Soft Holster	20175	1732.5	24.12	25.00	1.225	-0.1	0.715	0.876
	LTE Band 4	20M	QPSK	50	50	Front	0mm	Soft Holster	20175	1732.5	22.95	24.00	1.274	-0.02	0.565	0.720
	LTE Band 4	20M	QPSK	100	0	Front	0mm	Soft Holster	20175	1732.5	22.83	24.00	1.309	-0.12	0.556	0.728
42	LTE Band 4	20M	QPSK	1	0	Back	15mm	-	20175	1732.5	24.12	25.00	1.225	-0.09	0.739	0.905
	LTE Band 4	20M	QPSK	50	50	Back	15mm	-	20175	1732.5	22.95	24.00	1.274	0.12	0.595	0.758
	LTE Band 4	20M	QPSK	100	0	Back	15mm	-	20175	1732.5	22.83	24.00	1.309	-0.04	0.581	0.761
	LTE Band 12	10M	QPSK	1	0	Front	15mm	-	23095	707.5	24.18	25.00	1.208	-0.02	0.218	0.263
	LTE Band 12	10M	QPSK	25	0	Front	15mm	-	23095	707.5	23.09	24.00	1.233	-0.05	0.174	0.215
	LTE Band 12	10M	QPSK	1	0	Front	0mm	Rigid Holster	23095	707.5	24.18	25.00	1.208	0.03	0.209	0.252
	LTE Band 12	10M	QPSK	25	0	Front	0mm	Rigid Holster	23095	707.5	23.09	24.00	1.233	0.03	0.160	0.197
	LTE Band 12	10M	QPSK	1	0	Front	0mm	Soft Holster	23095	707.5	24.18	25.00	1.208	-0.01	0.207	0.250
	LTE Band 12	10M	QPSK	25	0	Front	0mm	Soft Holster	23095	707.5	23.09	24.00	1.233	0.01	0.164	0.202
43	LTE Band 12	10M	QPSK	1	0	Back	15mm	-	23095	707.5	24.18	25.00	1.208	-0.01	0.299	0.361
	LTE Band 12	10M	QPSK	25	0	Back	15mm	-	23095	707.5	23.09	24.00	1.233	-0.01	0.233	0.287
	LTE Band 13	10M	QPSK	1	25	Front	15mm	-	23230	782	24.03	25.00	1.250	0.02	0.222	0.278
	LTE Band 13	10M	QPSK	25	0	Front	15mm	-	23230	782	22.84	24.00	1.306	-0.02	0.176	0.230
	LTE Band 13	10M	QPSK	1	25	Front	0mm	Rigid Holster	23230	782	24.03	25.00	1.250	0.12	0.178	0.223
	LTE Band 13	10M	QPSK	25	0	Front	0mm	Rigid Holster	23230	782	22.84	24.00	1.306	-0.15	0.138	0.180
	LTE Band 13	10M	QPSK	1	25	Front	0mm	Soft Holster	23230	782	24.03	25.00	1.250	-0.16	0.236	0.295
	LTE Band 13	10M	QPSK	25	0	Front	0mm	Soft Holster	23230	782	22.84	24.00	1.306	0.1	0.188	0.246
44	LTE Band 13	10M	QPSK	1	25	Back	15mm	-	23230	782	24.03	25.00	1.250	0.04	0.268	0.335
	LTE Band 13	10M	QPSK	25	0	Back	15mm	-	23230	782	22.84	24.00	1.306	-0.04	0.208	0.272
	LTE Band 25	20M	QPSK	1	49	Front	15mm	-	26590	1905	23.60	25.00	1.380	-0.02	0.220	0.304
	LTE Band 25	20M	QPSK	50	50	Front	15mm	-	26590	1905	22.73	24.00	1.340	0	0.176	0.236
	LTE Band 25	20M	QPSK	1	49	Front	0mm	Rigid Holster	26590	1905	23.60	25.00	1.380	-0.01	0.495	0.683
	LTE Band 25	20M	QPSK	50	50	Front	0mm	Rigid Holster	26590	1905	22.73	24.00	1.340	-0.12	0.380	0.509
	LTE Band 25	20M	QPSK	1	49	Front	0mm	Soft Holster	26590	1905	23.60	25.00	1.380	0.03	0.673	0.929
	LTE Band 25	20M	QPSK	1	49	Front	0mm	Soft Holster	26340	1880	23.27	25.00	1.489	-0.04	0.713	1.062
	LTE Band 25	20M	QPSK	1	49	Front	0mm	Soft Holster	26140	1860	23.54	25.00	1.400	0.04	0.766	1.072
	LTE Band 25	20M	QPSK	50	50	Front	0mm	Soft Holster	26590	1860	22.73	24.00	1.340	-0.08	0.512	0.686
	LTE Band 25	20M	QPSK	100	0	Front	0mm	Soft Holster	26590	1860	22.74	24.00	1.337	-0.03	0.509	0.680
	LTE Band 25	20M	QPSK	1	49	Back	15mm	-	26590	1905	23.60	25.00	1.380	0	0.694	0.958
	LTE Band 25	20M	QPSK	1	49	Back	15mm	-	26140	1860	23.54	25.00	1.400	-0.04	0.736	1.030
45	LTE Band 25	20M	QPSK	1	49	Back	15mm	-	26340	1880	23.27	25.00	1.489	0.06	0.729	1.086
	LTE Band 25	20M	QPSK	50	50	Back	15mm	-	26590	1905	22.73	24.00	1.340	-0.01	0.553	0.741
	LTE Band 25	20M	QPSK	100	0	Back	15mm	-	26590	1905	22.74	24.00	1.337	-0.05	0.557	0.744
	LTE Band 26	15M	QPSK	1	37	Front	15mm	-	26865	831.5	24.15	25.00	1.216	-0.02	0.182	0.221
	LTE Band 26	15M	QPSK	36	0	Front	15mm	-	26865	831.5	22.99	24.00	1.262	-0.09	0.147	0.185
	LTE Band 26	15M	QPSK	1	37	Front	0mm	Rigid Holster	26865	831.5	24.15	25.00	1.216	-0.18	0.177	0.215
	LTE Band 26	15M	QPSK	36	0	Front	0mm	Rigid Holster	26865	831.5	22.99	24.00	1.262	-0.03	0.139	0.175
46	LTE Band 26	15M	QPSK	1	37	Front	0mm	Soft Holster	26865	831.5	24.15	25.00	1.216	0.15	0.364	0.443
	LTE Band 26	15M	QPSK	36	0	Front	0mm	Soft Holster	26865	831.5	22.99	24.00	1.262	-0.08	0.278	0.351
	LTE Band 26	15M	QPSK	1	37	Back	15mm	-	26865	831.5	24.15	25.00	1.216	-0.12	0.251	0.305
	LTE Band 26	15M	QPSK	36	0	Back	15mm	-	26865	831.5	22.99	24.00	1.262	-0.1	0.202	0.255



<WLAN SAR>

Plot No.	Band	Mode	Test Position	Gap (mm)	Antenna	Accessories	Ch.	Freq. (MHz)	Average Power (dBm)	Tune-Up Limit (dBm)	Tune-up Scaling Factor	Duty Cycle %	Duty Cycle Scaling Factor	Power Drift (dB)	Measured 1g SAR (W/kg)	Reported 1g SAR (W/kg)
	WLAN2.4GHz	802.11b 1Mbps	Front	15mm	Ant 1	-	11	2462	18.13	18.30	1.040	98.62	1.014	0.14	0.011	0.012
	WLAN2.4GHz	802.11b 1Mbps	Front	0mm	Ant 1	Rigid Holster	11	2462	18.13	18.30	1.040	98.62	1.014	-0.16	0.011	0.012
	WLAN2.4GHz	802.11b 1Mbps	Front	0mm	Ant 1	Soft Holster	11	2462	18.13	18.30	1.040	98.62	1.014	-0.16	0.010	0.011
	WLAN2.4GHz	802.11b 1Mbps	Back	15mm	Ant 1	-	11	2462	18.13	18.30	1.040	98.62	1.014	-0.09	0.134	0.141
	WLAN2.4GHz	802.11b 1Mbps	Back	15mm	Ant 1	-	1	2412	17.60	18.30	1.175	98.62	1.014	-0.03	0.127	0.151
47	WLAN2.4GHz	802.11b 1Mbps	Back	15mm	Ant 1	-	6	2437	18.04	18.30	1.062	98.62	1.014	-0.18	0.143	0.154
	WLAN2.4GHz	802.11b 1Mbps	Front	15mm	Ant 2	-	6	2437	18.72	19.10	1.091	98.62	1.014	-0.03	0.060	0.066
	WLAN2.4GHz	802.11b 1Mbps	Front	0mm	Ant 2	Rigid Holster	6	2437	18.72	19.10	1.091	98.62	1.014	-0.13	0.047	0.052
	WLAN2.4GHz	802.11b 1Mbps	Front	0mm	Ant 2	Soft Holster	6	2437	18.72	19.10	1.091	98.62	1.014	-0.14	0.075	0.083
	WLAN2.4GHz	802.11b 1Mbps	Back	15mm	Ant 2	-	6	2437	18.72	19.10	1.091	98.62	1.014	0.17	0.094	0.104
	WLAN5GHz	802.11a 6Mbps	Front	15mm	Ant 1	-	60	5300	16.09	16.10	1.002	92.86	1.077	0.11	0.001	0.001
	WLAN5GHz	802.11a 6Mbps	Front	0mm	Ant 1	Rigid Holster	60	5300	16.09	16.10	1.002	92.86	1.077	0.06	0.002	0.002
	WLAN5GHz	802.11a 6Mbps	Front	0mm	Ant 1	Soft Holster	60	5300	16.09	16.10	1.002	92.86	1.077	0	0.001	0.001
	WLAN5GHz	802.11a 6Mbps	Back	15mm	Ant 1	-	60	5300	16.09	16.10	1.002	92.86	1.077	-0.11	0.130	0.140
	WLAN5GHz	802.11a 6Mbps	Front	15mm	Ant 2	-	60	5300	17.56	17.80	1.056	92.86	1.077	-0.04	0.026	0.030
	WLAN5GHz	802.11a 6Mbps	Front	0mm	Ant 2	Rigid Holster	60	5300	17.56	17.80	1.056	92.86	1.077	-0.01	0.025	0.028
	WLAN5GHz	802.11a 6Mbps	Front	0mm	Ant 2	Soft Holster	60	5300	17.56	17.80	1.056	92.86	1.077	0.05	0.023	0.026
	WLAN5GHz	802.11a 6Mbps	Back	15mm	Ant 2	-	60	5300	17.56	17.80	1.056	92.86	1.077	0	0.306	0.348
48	WLAN5GHz	802.11a 6Mbps	Back	15mm	Ant 2	-	52	5260	17.55	17.80	1.059	92.86	1.077	0.17	0.317	0.361
	WLAN5GHz	802.11a 6Mbps	Front	15mm	Ant 1	-	116	5580	15.84	16.10	1.061	92.86	1.077	0	0.016	0.018
	WLAN5GHz	802.11a 6Mbps	Front	0mm	Ant 1	Rigid Holster	116	5580	15.84	16.10	1.061	92.86	1.077	-0.18	0.014	0.016
	WLAN5GHz	802.11a 6Mbps	Front	0mm	Ant 1	Soft Holster	116	5580	15.84	16.10	1.061	92.86	1.077	0.09	0.011	0.013
	WLAN5GHz	802.11a 6Mbps	Back	15mm	Ant 1	-	116	5580	15.84	16.10	1.061	92.86	1.077	0.02	0.093	0.106
	WLAN5GHz	802.11a 6Mbps	Front	15mm	Ant 2	-	100	5500	17.77	17.80	1.007	92.86	1.077	-0.13	0.037	0.040
	WLAN5GHz	802.11a 6Mbps	Front	0mm	Ant 2	Rigid Holster	100	5500	17.77	17.80	1.007	92.86	1.077	-0.14	0.041	0.044
	WLAN5GHz	802.11a 6Mbps	Front	0mm	Ant 2	Soft Holster	100	5500	17.77	17.80	1.007	92.86	1.077	0.06	0.037	0.040
	WLAN5GHz	802.11a 6Mbps	Back	15mm	Ant 2	-	100	5500	17.77	17.80	1.007	92.86	1.077	-0.09	0.323	0.350
49	WLAN5GHz	802.11a 6Mbps	Back	15mm	Ant 2	-	116	5580	17.54	17.80	1.061	92.86	1.077	-0.08	0.321	0.367
	WLAN5GHz	802.11a 6Mbps	Back	15mm	Ant 2	-	132	5660	17.67	17.80	1.030	92.86	1.077	-0.15	0.301	0.334
	WLAN5GHz	802.11a 6Mbps	Back	15mm	Ant 2	-	144	5720	17.59	17.80	1.049	92.86	1.077	-0.1	0.283	0.320
	WLAN5GHz	802.11a 6Mbps	Front	15mm	Ant 1	-	157	5785	15.93	16.10	1.040	92.86	1.077	0.06	0.016	0.018
	WLAN5GHz	802.11a 6Mbps	Front	0mm	Ant 1	Rigid Holster	157	5785	15.93	16.10	1.040	92.86	1.077	-0.07	0.014	0.016
	WLAN5GHz	802.11a 6Mbps	Front	0mm	Ant 1	Soft Holster	157	5785	15.93	16.10	1.040	92.86	1.077	-0.16	0.014	0.016
	WLAN5GHz	802.11a 6Mbps	Back	15mm	Ant 1	-	157	5785	15.93	16.10	1.040	92.86	1.077	-0.12	0.090	0.101
	WLAN5GHz	802.11a 6Mbps	Front	15mm	Ant 2	-	157	5785	17.60	17.80	1.047	92.86	1.077	-0.17	0.022	0.025
	WLAN5GHz	802.11a 6Mbps	Front	0mm	Ant 2	Rigid Holster	157	5785	17.60	17.80	1.047	92.86	1.077	0.03	0.025	0.028
	WLAN5GHz	802.11a 6Mbps	Front	0mm	Ant 2	Soft Holster	157	5785	17.60	17.80	1.047	92.86	1.077	-0.15	0.012	0.014
	WLAN5GHz	802.11a 6Mbps	Back	15mm	Ant 2	-	157	5785	17.60	17.80	1.047	92.86	1.077	-0.13	0.301	0.339
	WLAN5GHz	802.11a 6Mbps	Back	15mm	Ant 2	-	149	5745	17.53	17.80	1.064	92.86	1.077	-0.12	0.293	0.336
50	WLAN5GHz	802.11a 6Mbps	Back	15mm	Ant 2	-	165	5825	17.57	17.80	1.054	92.86	1.077	-0.16	0.313	0.355

<Bluetooth SAR>

Plot No.	Band	Mode	Test Position	Gap (mm)	Ch.	Freq. (MHz)	Average Power (dBm)	Tune-Up Limit (dBm)	Tune-up Scaling Factor	Power Drift (dB)	Measured 1g SAR (W/kg)	Reported 1g SAR (W/kg)
51	Bluetooth	GFSK	Back	15mm	39	2480	3.48	4	1.127	0.1	0.001	0.001

Note:

- In the above table, the Bluetooth SAR test is in order to evaluate for simultaneous transmission and SPLSR analysis.



15.4 Repeated SAR Measurement

No.	Band	BW (MHz)	Modulation	RB Size	RB offset	Mode	Test Position	Gap (mm)	Power Reduction	Ch.	Freq. (MHz)	Average Power (dBm)	Tune-Up Limit (dBm)	Tune-up Scaling Factor	Power Drift (dB)	Measured 1g SAR (W/kg)	Ratio	Reported 1g SAR (W/kg)
1st	GSM850	-	-	-	-	GPRS (4 Tx slots)	Right Side	10mm	-	251	848.8	31.67	32.00	1.079	-0.05	1.060	-	1.144
2nd	GSM850	-	-	-	-	GPRS (4 Tx slots)	Right Side	10mm	-	251	848.8	31.67	32.00	1.079	0.02	1.060	1.00	1.144
1st	LTE Band 4	20M	QPSK	1	49	-	Bottom Side	10mm	ON	20175	1732.5	20.91	21.50	1.146	0.09	1.040	-	1.191
2nd	LTE Band 4	20M	QPSK	1	49	-	Bottom Side	10mm	ON	20175	1732.5	20.91	21.50	1.146	0.05	1.000	1.04	1.146
1st	GSM1900	-	-	-	-	GPRS (3 Tx slots)	Back	15mm	-	661	1880	29.41	30.00	1.146	-0.02	1.110	-	1.272
2nd	GSM1900	-	-	-	-	GPRS (3 Tx slots)	Back	15mm	-	661	1880	29.41	30.00	1.146	-0.17	1.040	1.04	1.191

General Note:

1. Per KDB 865664 D01v01r04, for each frequency band, repeated SAR measurement is required only when the measured SAR is $\geq 0.8W/kg$.
2. Per KDB 865664 D01v01r04, if the ratio among the repeated measurement is ≤ 1.2 and the measured SAR $< 1.45W/kg$, only one repeated measurement is required.
3. The ratio is the difference in percentage between original and repeated *measured SAR*.
4. All measurement SAR result is scaled-up to account for tune-up tolerance and is compliant.

16. Simultaneous Transmission Analysis

NO.	Simultaneous Transmission Configurations	Head	Body-worn	Hotspot
1.	WWAN (Voice) + WLAN Ant 1 + WLAN Ant 2	Yes	Yes	
2.	WWAN (Data) + WLAN Ant 1 + WLAN Ant 2	Yes	Yes	Yes
3.	WWAN (Voice) + Bluetooth + WLAN Ant 2		Yes	
4.	WWAN (Data) + Bluetooth + WLAN Ant 2		Yes	

General Note:

1. This device WLAN 2.4GHz / 5.2GHz (U-NII-1) / 5.8GHz (U-NII-3) supports Hotspot operation.
2. For SAR testing was performed on single antenna RF power in SISO mode is larger or equal to the single antenna RF power in MIMO mode, and for RF exposure assessment of MIMO mode simultaneous transmission exclusion analysis was performed with SAR test results of each antenna in SISO mode.
3. WLAN and Bluetooth share the same antenna 1, and cannot transmit simultaneously.
4. EUT will choose either WLAN 2.4GHz or WLAN 5GHz according to the network signal condition; therefore, 2.4GHz WLAN and 5GHz WLAN will not operate simultaneously at any moment.
5. The worst case WLAN reported SAR for each configuration was used for SAR summation. Therefore, the following summations represent the absolute worst cases for simultaneous transmission with WLAN.
6. The Scaled SAR summation is calculated based on the same configuration and test position.
7. Per KDB 447498 D01v06, simultaneous transmission SAR is compliant if,
 - i) Scalar SAR summation < 1.6W/kg.
 - ii) $SPLSR = (SAR1 + SAR2)^{1.5} / (\text{min. separation distance, mm})$, and the peak separation distance is determined from the square root of $[(x1-x2)^2 + (y1-y2)^2 + (z1-z2)^2]$, where (x1, y1, z1) and (x2, y2, z2) are the coordinates of the extrapolated peak SAR locations in the zoom scan.
 - iii) If $SPLSR \leq 0.04$, simultaneously transmission SAR measurement is not necessary.
 - iv) Simultaneously transmission SAR measurement, and the reported multi-band SAR < 1.6W/kg.
 - v) The SPLSR calculated results please refer to section 16.4.
8. For simultaneous transmission analysis, Bluetooth SAR is estimated per KDB 447498 D01v06 based on the formula below.
 - i) $(\text{max. power of channel, including tune-up tolerance, mW}) / (\text{min. test separation distance, mm}) \cdot [\sqrt{f(\text{GHz})} / x] \text{ W/kg}$ for test separation distances $\leq 50 \text{ mm}$; where $x = 7.5$ for 1-g SAR, and $x = 18.75$ for 10-g SAR.
 - ii) When the minimum separation distance is < 5mm, the distance is used 5mm to determine SAR test exclusion.
 - iii) 0.4 W/kg for 1-g SAR and 1.0 W/kg for 10-g SAR, when the test separation distances is > 50 mm.

Bluetooth Max Power	Exposure Position	Body worn (Front with holster)	Body worn (Front)
	Test separation	5 mm	15 mm
4 dBm	Estimated SAR (W/kg)	0.126 W/kg	0.042 W/kg



16.1 Head Exposure Conditions

WWAN Band		Exposure Position	1	2	3	4	5	1+2+3 Summed 1g SAR (W/kg)	1+4+5 Summed 1g SAR (W/kg)
			WWAN 1g SAR (W/kg)	2.4GHz WLAN Ant 1 1g SAR (W/kg)	2.4GHz WLAN Ant 2 1g SAR (W/kg)	5GHz WLAN Ant 1 1g SAR (W/kg)	5GHz WLAN Ant 2 1g SAR (W/kg)		
GSM	GSM850	Right Cheek	0.847	0.052	0.156	0.117	0.028	1.055	0.992
		Right Tilted	0.332	0.021	0.139	0.035	0.036	0.492	0.403
		Left Cheek	0.351	0.020	0.305	0.018	0.108	0.676	0.477
		Left Tilted	0.322	0.026	0.247	0.026	0.089	0.595	0.437
	GSM1900	Right Cheek	0.166	0.052	0.156	0.117	0.028	0.374	0.311
		Right Tilted	0.084	0.021	0.139	0.035	0.036	0.244	0.155
		Left Cheek	0.242	0.020	0.305	0.018	0.108	0.567	0.368
		Left Tilted	0.050	0.026	0.247	0.026	0.089	0.323	0.165
WCDMA	WCDMA II	Right Cheek	0.141	0.052	0.156	0.117	0.028	0.349	0.286
		Right Tilted	0.081	0.021	0.139	0.035	0.036	0.241	0.152
		Left Cheek	0.247	0.020	0.305	0.018	0.108	0.572	0.373
		Left Tilted	0.041	0.026	0.247	0.026	0.089	0.314	0.156
	WCDMA IV	Right Cheek	0.140	0.052	0.156	0.117	0.028	0.348	0.285
		Right Tilted	0.094	0.021	0.139	0.035	0.036	0.254	0.165
		Left Cheek	0.260	0.020	0.305	0.018	0.108	0.585	0.386
		Left Tilted	0.053	0.026	0.247	0.026	0.089	0.326	0.168
	WCDMA V	Right Cheek	0.438	0.052	0.156	0.117	0.028	0.646	0.583
		Right Tilted	0.236	0.021	0.139	0.035	0.036	0.396	0.307
		Left Cheek	0.265	0.020	0.305	0.018	0.108	0.590	0.391
		Left Tilted	0.217	0.026	0.247	0.026	0.089	0.490	0.332
CDMA	CDMA BC0	Right Cheek	0.454	0.052	0.156	0.117	0.028	0.662	0.599
		Right Tilted	0.247	0.021	0.139	0.035	0.036	0.407	0.318
		Left Cheek	0.273	0.020	0.305	0.018	0.108	0.598	0.399
		Left Tilted	0.236	0.026	0.247	0.026	0.089	0.509	0.351
	CDMA BC1	Right Cheek	0.100	0.052	0.156	0.117	0.028	0.308	0.245
		Right Tilted	0.076	0.021	0.139	0.035	0.036	0.236	0.147
		Left Cheek	0.222	0.020	0.305	0.018	0.108	0.547	0.348
		Left Tilted	0.036	0.026	0.247	0.026	0.089	0.309	0.151
	CDMA BC10	Right Cheek	0.365	0.052	0.156	0.117	0.028	0.573	0.510
		Right Tilted	0.198	0.021	0.139	0.035	0.036	0.358	0.269
		Left Cheek	0.218	0.020	0.305	0.018	0.108	0.543	0.344
		Left Tilted	0.190	0.026	0.247	0.026	0.089	0.463	0.305
LTE	LTE Band 4	Right Cheek	0.100	0.052	0.156	0.117	0.028	0.308	0.245
		Right Tilted	0.062	0.021	0.139	0.035	0.036	0.222	0.133
		Left Cheek	0.212	0.020	0.305	0.018	0.108	0.537	0.338
		Left Tilted	0.053	0.026	0.247	0.026	0.089	0.326	0.168
	LTE Band 12	Right Cheek	0.284	0.052	0.156	0.117	0.028	0.492	0.429
		Right Tilted	0.170	0.021	0.139	0.035	0.036	0.330	0.241
		Left Cheek	0.223	0.020	0.305	0.018	0.108	0.548	0.349
		Left Tilted	0.158	0.026	0.247	0.026	0.089	0.431	0.273
	LTE Band 13	Right Cheek	0.281	0.052	0.156	0.117	0.028	0.489	0.426
		Right Tilted	0.159	0.021	0.139	0.035	0.036	0.319	0.230
		Left Cheek	0.184	0.020	0.305	0.018	0.108	0.509	0.310
		Left Tilted	0.154	0.026	0.247	0.026	0.089	0.427	0.269
	LTE Band 25	Right Cheek	0.120	0.052	0.156	0.117	0.028	0.328	0.265
		Right Tilted	0.081	0.021	0.139	0.035	0.036	0.241	0.152
		Left Cheek	0.258	0.020	0.305	0.018	0.108	0.583	0.384
		Left Tilted	0.037	0.026	0.247	0.026	0.089	0.310	0.152
	LTE Band 26	Right Cheek	0.321	0.052	0.156	0.117	0.028	0.529	0.466
		Right Tilted	0.169	0.021	0.139	0.035	0.036	0.329	0.240
		Left Cheek	0.203	0.020	0.305	0.018	0.108	0.528	0.329
		Left Tilted	0.173	0.026	0.247	0.026	0.089	0.446	0.288



16.2 Hotspot Exposure Conditions

WWAN Band	Exposure Position	1	2	3	4	5	1+2+3 Summed 1g SAR (W/kg)	1+4+5 Summed 1g SAR (W/kg)	SPLSR	Case No	
		WWAN	2.4GHz WLAN Ant 1	2.4GHz WLAN Ant 2	5GHz WLAN Ant 1	5GHz WLAN Ant 2					
		1g SAR (W/kg)	1g SAR (W/kg)	1g SAR (W/kg)	1g SAR (W/kg)	1g SAR (W/kg)					
GSM	GSM850	Front	0.535	0.019	0.089	0.024	0.037	0.643	0.596		
		Back	1.111	0.212	0.160	0.200	0.551	1.483	1.862	0.04	Case 1
		Left side	0.554	0.119	0.018	0.268	0.016	0.691	0.838		
		Right side	1.144	0.020	0.329	0.010	0.503	1.493	1.657	0.04	Case 2
		Top side		0.018	0.201	0.049	0.418	0.219	0.467		
		Bottom side	0.582					0.582	0.582		
	GSM1900	Front	0.161	0.019	0.089	0.024	0.037	0.269	0.222		
		Back	0.594	0.212	0.160	0.200	0.551	0.966	1.345		
		Left side	0.063	0.119	0.018	0.268	0.016	0.200	0.347		
		Right side	0.036	0.020	0.329	0.010	0.503	0.385	0.549		
		Top side		0.018	0.201	0.049	0.418	0.219	0.467		
		Bottom side	1.299					1.299	1.299		
WCDMA	WCDMA II	Front	0.160	0.019	0.089	0.024	0.037	0.268	0.221		
		Back	0.557	0.212	0.160	0.200	0.551	0.929	1.308		
		Left side	0.040	0.119	0.018	0.268	0.016	0.177	0.324		
		Right side	0.026	0.020	0.329	0.010	0.503	0.375	0.539		
		Top side		0.018	0.201	0.049	0.418	0.219	0.467		
		Bottom side	1.155					1.155	1.155		
	WCDMA IV	Front	0.167	0.019	0.089	0.024	0.037	0.275	0.228		
		Back	0.651	0.212	0.160	0.200	0.551	1.023	1.402		
		Left side	0.081	0.119	0.018	0.268	0.016	0.218	0.365		
		Right side	0.035	0.020	0.329	0.010	0.503	0.384	0.548		
		Top side		0.018	0.201	0.049	0.418	0.219	0.467		
		Bottom side	1.065					1.065	1.065		
	WCDMA V	Front	0.299	0.019	0.089	0.024	0.037	0.407	0.360		
		Back	0.513	0.212	0.160	0.200	0.551	0.885	1.264		
		Left side	0.296	0.119	0.018	0.268	0.016	0.433	0.580		
		Right side	0.661	0.020	0.329	0.010	0.503	1.010	1.174		
		Top side		0.018	0.201	0.049	0.418	0.219	0.467		
		Bottom side	0.439					0.439	0.439		
CDMA	CDMA BC0	Front	0.330	0.019	0.089	0.024	0.037	0.438	0.391		
		Back	0.556	0.212	0.160	0.200	0.551	0.928	1.307		
		Left side	0.338	0.119	0.018	0.268	0.016	0.475	0.622		
		Right side	0.648	0.020	0.329	0.010	0.503	0.997	1.161		
		Top side		0.018	0.201	0.049	0.418	0.219	0.467		
		Bottom side	0.452					0.452	0.452		
	CDMA BC1	Front	0.145	0.019	0.089	0.024	0.037	0.253	0.206		
		Back	0.502	0.212	0.160	0.200	0.551	0.874	1.253		
		Left side	0.038	0.119	0.018	0.268	0.016	0.175	0.322		
		Right side	0.035	0.020	0.329	0.010	0.503	0.384	0.548		
		Top side		0.018	0.201	0.049	0.418	0.219	0.467		
		Bottom side	1.138					1.138	1.138		
	CDMA BC10	Front	0.286	0.019	0.089	0.024	0.037	0.394	0.347		
		Back	0.497	0.212	0.160	0.200	0.551	0.869	1.248		
		Left side	0.307	0.119	0.018	0.268	0.016	0.444	0.591		
		Right side	0.529	0.020	0.329	0.010	0.503	0.878	1.042		
		Top side		0.018	0.201	0.049	0.418	0.219	0.467		
		Bottom side	0.278					0.278	0.278		



WWAN Band	Exposure Position	1	2	3	4	5	1+2+3 Summed 1g SAR (W/kg)	1+4+5 Summed 1g SAR (W/kg)	SPLSR	Case No	
		WWAN	2.4GHz WLAN Ant 1	2.4GHz WLAN Ant 2	5GHz WLAN Ant 1	5GHz WLAN Ant 2					
		1g SAR (W/kg)	1g SAR (W/kg)	1g SAR (W/kg)	1g SAR (W/kg)	1g SAR (W/kg)					
LTE	LTE Band 4	Front	0.212	0.019	0.089	0.024	0.037	0.320	0.273		
		Back	0.724	0.212	0.160	0.200	0.551	1.096	1.475		
		Left side	0.104	0.119	0.018	0.268	0.016	0.241	0.388		
		Right side	0.044	0.020	0.329	0.010	0.503	0.393	0.557		
		Top side		0.018	0.201	0.049	0.418	0.219	0.467		
		Bottom side	1.191					1.191	1.191		
	LTE Band 12	Front	0.267	0.019	0.089	0.024	0.037	0.375	0.328		
		Back	0.429	0.212	0.160	0.200	0.551	0.801	1.180		
		Left side	0.302	0.119	0.018	0.268	0.016	0.439	0.586		
		Right side	0.460	0.020	0.329	0.010	0.503	0.809	0.973		
		Top side		0.018	0.201	0.049	0.418	0.219	0.467		
		Bottom side	0.150					0.150	0.150		
	LTE Band 13	Front	0.293	0.019	0.089	0.024	0.037	0.401	0.354		
		Back	0.429	0.212	0.160	0.200	0.551	0.801	1.180		
		Left side	0.283	0.119	0.018	0.268	0.016	0.420	0.567		
		Right side	0.484	0.020	0.329	0.010	0.503	0.833	0.997		
		Top side		0.018	0.201	0.049	0.418	0.219	0.467		
		Bottom side	0.184					0.184	0.184		
	LTE Band 25	Front	0.136	0.019	0.089	0.024	0.037	0.244	0.197		
		Back	0.487	0.212	0.160	0.200	0.551	0.859	1.238		
		Left side	0.034	0.119	0.018	0.268	0.016	0.171	0.318		
		Right side	0.029	0.020	0.329	0.010	0.503	0.378	0.542		
		Top side		0.018	0.201	0.049	0.418	0.219	0.467		
		Bottom side	1.086					1.086	1.086		
LTE Band 26	Front	0.242	0.019	0.089	0.024	0.037	0.350	0.303			
	Back	0.358	0.212	0.160	0.200	0.551	0.730	1.109			
	Left side	0.243	0.119	0.018	0.268	0.016	0.380	0.527			
	Right side	0.465	0.020	0.329	0.010	0.503	0.814	0.978			
	Top side		0.018	0.201	0.049	0.418	0.219	0.467			
	Bottom side	0.276					0.276	0.276			



16.3 Body-Worn Accessory Exposure Conditions

WWAN Band	Exposure Position	1	2	3	4	5	1+2+3 Summed 1g SAR (W/kg)	1+4+5 Summed 1g SAR (W/kg)	SPLSR	Case No		
		WWAN	2.4GHz WLAN Ant 1	2.4GHz WLAN Ant 2	5GHz WLAN Ant 1	5GHz WLAN Ant 2						
		1g SAR (W/kg)	1g SAR (W/kg)	1g SAR (W/kg)	1g SAR (W/kg)	1g SAR (W/kg)						
GSM	GSM850	Front	0.487	0.012	0.066	0.018	0.040	0.565	0.545			
		Front with Holster	1.106	0.012	0.083	0.016	0.044	1.201	1.166			
		Back	0.736	0.154	0.104	0.140	0.367	0.994	1.243			
	GSM1900	Front	0.328	0.012	0.066	0.018	0.040	0.406	0.386			
		Front with Holster	1.176	0.012	0.083	0.016	0.044	1.271	1.236			
		Back	1.281	0.154	0.104	0.140	0.367	1.539	1.788	0.02	Case 3	
WCDMA	WCDMA II	Back with Earphone	0.318	0.154	0.104	0.140	0.367	0.576	0.825			
		Front	0.305	0.012	0.066	0.018	0.040	0.383	0.363			
		Front with Holster	1.134	0.012	0.083	0.016	0.044	1.229	1.194			
		Back	1.216	0.154	0.104	0.140	0.367	1.474	1.723	0.01	Case 4	
	WCDMA IV	Back with Earphone	0.272	0.154	0.104	0.140	0.367	0.530	0.779			
		Front	0.326	0.012	0.066	0.018	0.040	0.404	0.384			
		Front with Holster	1.110	0.012	0.083	0.016	0.044	1.205	1.170			
	WCDMA V	Back	1.243	0.154	0.104	0.140	0.367	1.501	1.750	0.01	Case 5	
		Back with Earphone	0.270	0.154	0.104	0.140	0.367	0.528	0.777			
CDMA	CDMA BC0	Front	0.266	0.012	0.066	0.018	0.040	0.344	0.324			
		Front with Holster	0.484	0.012	0.083	0.016	0.044	0.579	0.544			
		Back	0.428	0.154	0.104	0.140	0.367	0.686	0.935			
	CDMA BC1	Front	0.319	0.012	0.066	0.018	0.040	0.397	0.377			
		Front with Holster	0.594	0.012	0.083	0.016	0.044	0.689	0.654			
		Back	0.475	0.154	0.104	0.140	0.367	0.733	0.982			
	CDMA BC10	Front	0.273	0.012	0.066	0.018	0.040	0.351	0.331			
		Front with Holster	0.679	0.012	0.083	0.016	0.044	0.774	0.739			
		Back	1.001	0.154	0.104	0.140	0.367	1.259	1.508			
	LTE	LTE Band 4	Front	0.288	0.012	0.066	0.018	0.040	0.366	0.346		
			Front with Holster	0.466	0.012	0.083	0.016	0.044	0.561	0.526		
			Back	0.385	0.154	0.104	0.140	0.367	0.643	0.892		
LTE Band 12		Front	0.253	0.012	0.066	0.018	0.040	0.331	0.311			
		Front with Holster	0.876	0.012	0.083	0.016	0.044	0.971	0.936			
		Back	0.905	0.154	0.104	0.140	0.367	1.163	1.412			
LTE Band 13		Front	0.263	0.012	0.066	0.018	0.040	0.341	0.321			
		Front with Holster	0.252	0.012	0.083	0.016	0.044	0.347	0.312			
		Back	0.361	0.154	0.104	0.140	0.367	0.619	0.868			
LTE Band 25		Front	0.278	0.012	0.066	0.018	0.040	0.356	0.336			
		Front with Holster	0.295	0.012	0.083	0.016	0.044	0.390	0.355			
		Back	0.335	0.154	0.104	0.140	0.367	0.593	0.842			
LTE Band 26	Front	0.304	0.012	0.066	0.018	0.040	0.382	0.362				
	Front with Holster	1.072	0.012	0.083	0.016	0.044	1.167	1.132				
	Back	1.086	0.154	0.104	0.140	0.367	1.344	1.593				
LTE Band 26	Front	0.221	0.012	0.066	0.018	0.040	0.299	0.279				
	Front with Holster	0.443	0.012	0.083	0.016	0.044	0.538	0.503				
		Back	0.305	0.154	0.104	0.140	0.563	0.812				



WWAN Band	Exposure Position	1	2	3	4	5	6	1+3+6 Summed 1g SAR (W/kg)	1+5+6 Summed 1g SAR (W/kg)	SPLSR	Case No		
		WWAN	2.4GHz WLAN Ant 1	2.4GHz WLAN Ant 2	5GHz WLAN Ant 1	5GHz WLAN Ant 2	Bluetooth						
		1g SAR (W/kg)	1g SAR (W/kg)	1g SAR (W/kg)	1g SAR (W/kg)	1g SAR (W/kg)	1g SAR (W/kg)						
GSM	GSM850	Front	0.487	0.012	0.066	0.018	0.040	0.042	0.595	0.569			
		Front with Holster	1.106	0.012	0.083	0.016	0.044	0.126	1.315	1.276			
		Back	0.736	0.154	0.104	0.140	0.367	0.001	0.841	1.104			
	GSM1900	Front	0.328	0.012	0.066	0.018	0.040	0.042	0.436	0.410			
		Front with Holster	1.176	0.012	0.083	0.016	0.044	0.126	1.385	1.346			
		Back	1.281	0.154	0.104	0.140	0.367	0.001	1.386	1.649	0.02	Case 6	
WCDMA	WCDMA II	Back with Earphone	0.318	0.154	0.104	0.140	0.367	0.001	0.423	0.686			
		Front	0.305	0.012	0.066	0.018	0.040	0.042	0.413	0.387			
		Front with Holster	1.134	0.012	0.083	0.016	0.044	0.126	1.343	1.304			
	WCDMA IV	Back	1.216	0.154	0.104	0.140	0.367	0.001	1.321	1.584			
		Back with Earphone	0.272	0.154	0.104	0.140	0.367	0.001	0.377	0.640			
		Front	0.326	0.012	0.066	0.018	0.040	0.042	0.434	0.408			
	WCDMA V	Front with Holster	1.110	0.012	0.083	0.016	0.044	0.126	1.319	1.280			
		Back	1.243	0.154	0.104	0.140	0.367	0.001	1.348	1.611	0.02	Case 7	
		Back with Earphone	0.270	0.154	0.104	0.140	0.367	0.001	0.375	0.638			
CDMA	CDMA BC0	Front	0.266	0.012	0.066	0.018	0.040	0.042	0.374	0.348			
		Front with Holster	0.484	0.012	0.083	0.016	0.044	0.126	0.693	0.654			
		Back	0.428	0.154	0.104	0.140	0.367	0.001	0.533	0.796			
	CDMA BC1	Front	0.319	0.012	0.066	0.018	0.040	0.042	0.427	0.401			
		Front with Holster	0.594	0.012	0.083	0.016	0.044	0.126	0.803	0.764			
		Back	0.475	0.154	0.104	0.140	0.367	0.001	0.580	0.843			
	CDMA BC10	Front	0.273	0.012	0.066	0.018	0.040	0.042	0.381	0.355			
		Front with Holster	0.679	0.012	0.083	0.016	0.044	0.126	0.888	0.849			
		Back	1.001	0.154	0.104	0.140	0.367	0.001	1.106	1.369			
	LTE	LTE Band 4	Front	0.288	0.012	0.066	0.018	0.040	0.042	0.396	0.370		
			Front with Holster	0.466	0.012	0.083	0.016	0.044	0.126	0.675	0.636		
			Back	0.385	0.154	0.104	0.140	0.367	0.001	0.490	0.753		
LTE Band 12		Front	0.253	0.012	0.066	0.018	0.040	0.042	0.361	0.335			
		Front with Holster	0.876	0.012	0.083	0.016	0.044	0.126	1.085	1.046			
		Back	0.905	0.154	0.104	0.140	0.367	0.001	1.010	1.273			
LTE Band 13		Front	0.263	0.012	0.066	0.018	0.040	0.042	0.371	0.345			
		Front with Holster	0.252	0.012	0.083	0.016	0.044	0.126	0.461	0.422			
		Back	0.361	0.154	0.104	0.140	0.367	0.001	0.466	0.729			
LTE Band 25		Front	0.278	0.012	0.066	0.018	0.040	0.042	0.386	0.360			
		Front with Holster	0.295	0.012	0.083	0.016	0.044	0.126	0.504	0.465			
		Back	0.335	0.154	0.104	0.140	0.367	0.001	0.440	0.703			
LTE Band 26		Front	0.304	0.012	0.066	0.018	0.040	0.042	0.412	0.386			
		Front with Holster	1.072	0.012	0.083	0.016	0.044	0.126	1.281	1.242			
		Back	1.086	0.154	0.104	0.140	0.367	0.001	1.191	1.454			
LTE Band 26	Front	0.221	0.012	0.066	0.018	0.040	0.042	0.329	0.303				
	Front with Holster	0.443	0.012	0.083	0.016	0.044	0.126	0.652	0.613				
		Back	0.305	0.154	0.104	0.140	0.367	0.001	0.410	0.673			

16.4 SPLSR Evaluation and Analysis

General Note:

- SPLSR = $(SAR_1 + SAR_2)^{1.5} / (min. \text{ separation distance, mm})$. If $SPLSR \leq 0.04$, simultaneously transmission SAR measurement is not necessary

	Band	Position	SAR (W/kg)	Gap (mm)	SAR peak location (mm)			3D distance (mm)	Summed SAR (W/kg)	SPLSR Results	Simultaneous SAR
					X	Y	Z				
Case 1	GSM850	Back	1.111	10	-1.87	15.99	-2.16	42.5	1.31	0.04	Not required
	5GHzWLAN ANT1		0.200	10	37.81	31.2	-1.78				
	GSM850		1.111	10	-1.87	15.99	-2.16	62.4	1.66	0.03	Not required
	5GHzWLAN ANT2		0.551	10	-28.96	72.21	-1.98				
	5GHzWLAN ANT1		0.200	10	37.81	31.2	-1.78	78.4	0.75	0.01	Not required
	5GHzWLAN ANT2		0.551	10	-28.96	72.21	-1.98				

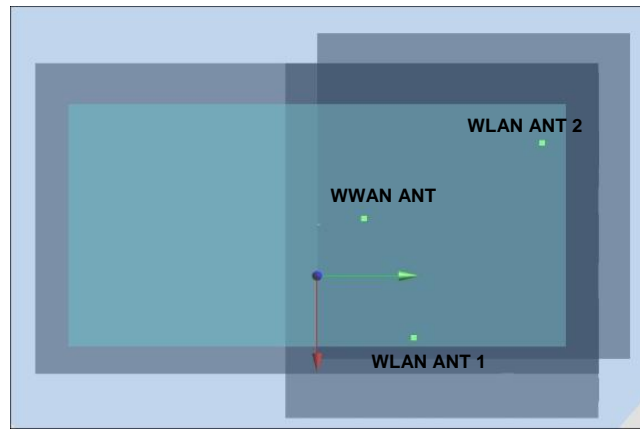

	Band	Position	SAR (W/kg)	Gap (mm)	SAR peak location (mm)			3D distance (mm)	Summed SAR (W/kg)	SPLSR Results	Simultaneous SAR
					X	Y	Z				
Case 2	GSM850	Right Side	1.144	10	8.1	-15.79	-2.09	39.0	1.15	0.03	Not required
	5GHzWLAN ANT1		0.010	10	-19	-43.8	-1.96				
	GSM850		1.144	10	8.1	-15.79	-2.09	53.4	1.65	0.04	Not required
	5GHzWLAN ANT2		0.503	10	-8.37	-66.61	-1.78				
	5GHzWLAN ANT1		0.010	10	-19	-43.8	-1.96	25.2	0.51	0.01	Not required
	5GHzWLAN ANT2		0.503	10	-8.37	-66.61	-1.78				

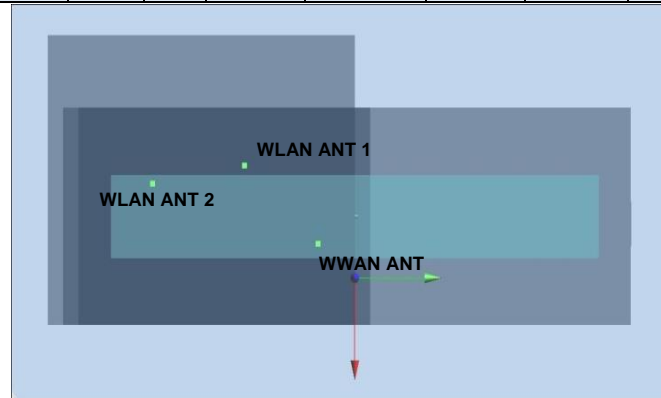

Case 3	Band	Position	SAR (W/kg)	Gap (mm)	SAR peak location (mm)			3D distance (mm)	Summed SAR (W/kg)	SPLSR Results	Simultaneous SAR
					X	Y	Z				
Case 3	GSM1900	Back	1.281	15	0.61	-72.6	-1.7	112.0	1.42	0.02	Not required
	5GHzWLAN ANT1		0.14	15	30.8	35.2	0.16				
	GSM1900		1.281	15	0.61	-72.6	-1.7	143.7	1.65	0.01	Not required
	5GHzWLAN ANT2		0.367	15	-29.96	67.81	-2				
	5GHzWLAN ANT1		0.14	15	30.8	35.2	0.16	69.0	0.51	0.01	Not required
	5GHzWLAN ANT2		0.367	15	-29.96	67.81	-2				

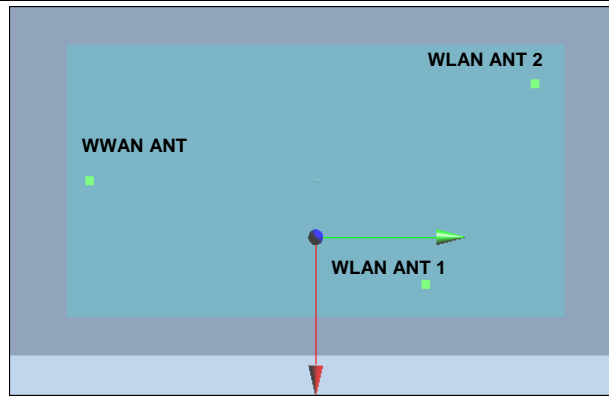

Case 4	Band	Position	SAR (W/kg)	Gap (mm)	SAR peak location (mm)			3D distance (mm)	Summed SAR (W/kg)	SPLSR Results	Simultaneous SAR
					X	Y	Z				
Case 4	WCDMA II	Back	1.216	15	2.02	-75.59	-1.71	114.5	1.36	0.01	Not required
	5GHzWLAN ANT1		0.14	15	30.8	35.2	0.16				
	WCDMA II		1.216	15	2.02	-75.59	-1.71	146.9	1.58	0.01	Not required
	5GHzWLAN ANT2		0.367	15	-29.96	67.81	-2				
	5GHzWLAN ANT1		0.14	15	30.8	35.2	0.16	69.0	0.51	0.01	Not required
	5GHzWLAN ANT2		0.367	15	-29.96	67.81	-2				

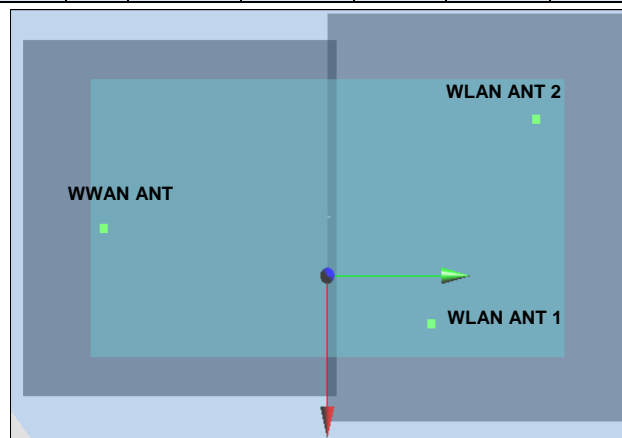

Case 5	Band	Position	SAR (W/kg)	Gap (mm)	SAR peak location (mm)			3D distance (mm)	Summed SAR (W/kg)	SPLSR Results	Simultaneous SAR
					X	Y	Z				
Case 5	WCMDA IV	Back	1.243	15	0.54	-75.6	-1.68	114.9	1.38	0.01	Not required
	5GHzWLAN ANT1		0.14	15	30.8	35.2	0.16				
	WCMDA IV		1.243	15	0.54	-75.6	-1.68	146.6	1.61	0.01	Not required
	5GHzWLAN ANT2		0.367	15	-29.96	67.81	-2				
	5GHzWLAN ANT1		0.14	15	30.8	35.2	0.16	69.0	0.51	0.01	Not required
	5GHzWLAN ANT2		0.367	15	-29.96	67.81	-2				

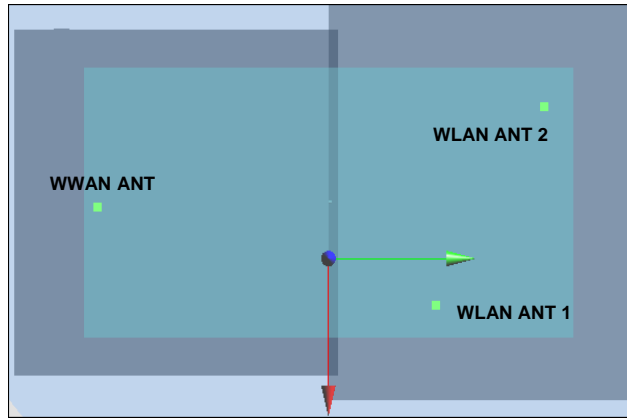

Case 6	Band	Position	SAR (W/kg)	Gap (mm)	SAR peak location (mm)			3D distance (mm)	Summed SAR (W/kg)	SPLSR Results	Simultaneous SAR
					X	Y	Z				
Case 6	GSM1900	Back	1.281	15	0.61	-72.6	-1.7	143.7	1.65	0.01	Not required
	5GHzWLAN ANT2		0.367	15	-29.96	67.81	-2				
	GSM1900		1.281	15	0.61	-72.6	-1.7	78.1	1.28	0.02	Not required
	Bluetooth		0.001	15	44.06	-8.01	5.01				
	5GHzWLAN ANT2		0.367	15	-29.96	67.81	-2	106.2	0.37	0.00	Not required
	Bluetooth		0.001	15	44.06	-8.01	5.01				

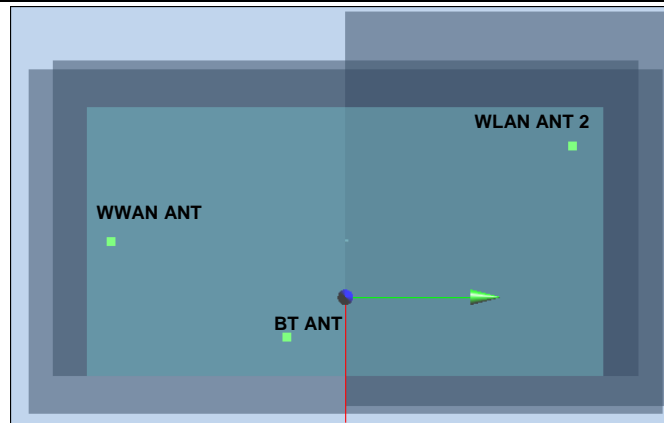

Case 7	Band	Position	SAR (W/kg)	Gap (mm)	SAR peak location (mm)			3D distance (mm)	Summed SAR (W/kg)	SPLSR Results	Simultaneous SAR
					X	Y	Z				
Case 7	WCMDA IV	Back	1.243	15	0.54	-75.6	-1.68	146.6	1.61	0.01	Not required
	5GHzWLAN ANT2		0.367	15	-29.96	67.81	-2				
	WCMDA IV		1.243	15	0.54	-75.6	-1.68	80.7	1.24	0.02	Not required
	Bluetooth		0.001	15	44.06	-8.01	5.01				
	5GHzWLAN ANT2		0.367	15	-29.96	67.81	-2	106.2	0.37	0.00	Not required
	Bluetooth		0.001	15	44.06	-8.01	5.01				

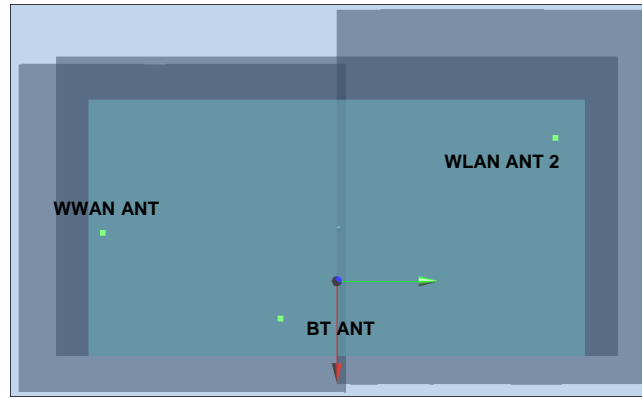

Test Engineer : Iran Wang, Jeff Lee, Tommy Chen, Ken Li, San Lin and Thomas Wang

17. Uncertainty Assessment

The component of uncertainty may generally be categorized according to the methods used to evaluate them. The evaluation of uncertainty by the statistical analysis of a series of observations is termed a Type A evaluation of uncertainty. The evaluation of uncertainty by means other than the statistical analysis of a series of observation is termed a Type B evaluation of uncertainty. Each component of uncertainty, however evaluated, is represented by an estimated standard deviation, termed standard uncertainty, which is determined by the positive square root of the estimated variance.

A Type A evaluation of standard uncertainty may be based on any valid statistical method for treating data. This includes calculating the standard deviation of the mean of a series of independent observations; using the method of least squares to fit a curve to the data in order to estimate the parameter of the curve and their standard deviations; or carrying out an analysis of variance in order to identify and quantify random effects in certain kinds of measurement.

A type B evaluation of standard uncertainty is typically based on scientific judgment using all of the relevant information available. These may include previous measurement data, experience, and knowledge of the behavior and properties of relevant materials and instruments, manufacture’s specification, data provided in calibration reports and uncertainties assigned to reference data taken from handbooks. Broadly speaking, the uncertainty is either obtained from an outdoor source or obtained from an assumed distribution, such as the normal distribution, rectangular or triangular distributions indicated in table below.

Uncertainty Distributions	Normal	Rectangular	Triangular	U-Shape
Multi-plying Factor ^(a)	1/k ^(b)	1/√3	1/√6	1/√2

(a) standard uncertainty is determined as the product of the multiplying factor and the estimated range of variations in the measured quantity

(b) κ is the coverage factor

Table 17.1. Standard Uncertainty for Assumed Distribution

The combined standard uncertainty of the measurement result represents the estimated standard deviation of the result. It is obtained by combining the individual standard uncertainties of both Type A and Type B evaluation using the usual “root-sum-squares” (RSS) methods of combining standard deviations by taking the positive square root of the estimated variances.

Expanded uncertainty is a measure of uncertainty that defines an interval about the measurement result within which the measured value is confidently believed to lie. It is obtained by multiplying the combined standard uncertainty by a coverage factor. Typically, the coverage factor ranges from 2 to 3. Using a coverage factor allows the true value of a measured quantity to be specified with a defined probability within the specified uncertainty range. For purpose of this document, a coverage factor two is used, which corresponds to confidence interval of about 95 %. The DASY uncertainty Budget is shown in the following tables.



Error Description	Uncertainty Value (±%)	Probability	Divisor	(Ci) 1g	(Ci) 10g	Standard Uncertainty (1g) (±%)	Standard Uncertainty (10g) (±%)
Measurement System							
Probe Calibration	6.0	N	1	1	1	6.0	6.0
Axial Isotropy	4.7	R	1.732	0.7	0.7	1.9	1.9
Hemispherical Isotropy	9.6	R	1.732	0.7	0.7	3.9	3.9
Boundary Effects	1.0	R	1.732	1	1	0.6	0.6
Linearity	4.7	R	1.732	1	1	2.7	2.7
System Detection Limits	1.0	R	1.732	1	1	0.6	0.6
Modulation Response	3.2	R	1.732	1	1	1.8	1.8
Readout Electronics	0.3	N	1	1	1	0.3	0.3
Response Time	0.0	R	1.732	1	1	0.0	0.0
Integration Time	2.6	R	1.732	1	1	1.5	1.5
RF Ambient Noise	3.0	R	1.732	1	1	1.7	1.7
RF Ambient Reflections	3.0	R	1.732	1	1	1.7	1.7
Probe Positioner	0.4	R	1.732	1	1	0.2	0.2
Probe Positioning	2.9	R	1.732	1	1	1.7	1.7
Max. SAR Eval.	2.0	R	1.732	1	1	1.2	1.2
Test Sample Related							
Device Positioning	3.0	N	1	1	1	3.0	3.0
Device Holder	3.6	N	1	1	1	3.6	3.6
Power Drift	5.0	R	1.732	1	1	2.9	2.9
Power Scaling	0.0	R	1.732	1	1	0.0	0.0
Phantom and Setup							
Phantom Uncertainty	6.1	R	1.732	1	1	3.5	3.5
SAR correction	0.0	R	1.732	1	0.84	0.0	0.0
Liquid Conductivity Repeatability	0.2	N	1	0.78	0.71	0.1	0.1
Liquid Conductivity (target)	5.0	R	1.732	0.78	0.71	2.3	2.0
Liquid Conductivity (mea.)	2.5	R	1.732	0.78	0.71	1.1	1.0
Temp. unc. - Conductivity	3.4	R	1.732	0.78	0.71	1.5	1.4
Liquid Permittivity Repeatability	0.15	N	1	0.23	0.26	0.0	0.0
Liquid Permittivity (target)	5.0	R	1.732	0.23	0.26	0.7	0.8
Liquid Permittivity (mea.)	2.5	R	1.732	0.23	0.26	0.3	0.4
Temp. unc. - Permittivity	0.83	R	1.732	0.23	0.26	0.1	0.1
Combined Std. Uncertainty						11.4%	11.4%
Coverage Factor for 95 %						K=2	K=2
Expanded STD Uncertainty						22.9%	22.7%

Table 17.2. Uncertainty Budget for frequency range 300 MHz to 3 GHz



Error Description	Uncertainty Value (±%)	Probability	Divisor	(Ci) 1g	(Ci) 10g	Standard Uncertainty (1g) (±%)	Standard Uncertainty (10g) (±%)
Measurement System							
Probe Calibration	7.0	N	1	1	1	7.0	7.0
Axial Isotropy	4.7	R	1.732	0.7	0.7	1.9	1.9
Hemispherical Isotropy	9.6	R	1.732	0.7	0.7	3.9	3.9
Boundary Effects	2.0	R	1.732	1	1	1.2	1.2
Linearity	4.7	R	1.732	1	1	2.7	2.7
System Detection Limits	1.0	R	1.732	1	1	0.6	0.6
Modulation Response	3.2	R	1.732	1	1	1.8	1.8
Readout Electronics	0.3	N	1	1	1	0.3	0.3
Response Time	0.0	R	1.732	1	1	0.0	0.0
Integration Time	2.6	R	1.732	1	1	1.5	1.5
RF Ambient Noise	3.0	R	1.732	1	1	1.7	1.7
RF Ambient Reflections	3.0	R	1.732	1	1	1.7	1.7
Probe Positioner	0.4	R	1.732	1	1	0.2	0.2
Probe Positioning	6.7	R	1.732	1	1	3.9	3.9
Max. SAR Eval.	4.0	R	1.732	1	1	2.3	2.3
Test Sample Related							
Device Positioning	3.0	N	1	1	1	3.0	3.0
Device Holder	3.6	N	1	1	1	3.6	3.6
Power Drift	5.0	R	1.732	1	1	2.9	2.9
Power Scaling	0.0	R	1.732	1	1	0.0	0.0
Phantom and Setup							
Phantom Uncertainty	6.6	R	1.732	1	1	3.8	3.8
SAR correction	0.0	R	1.732	1	0.84	0.0	0.0
Liquid Conductivity Repeatability	0.2	N	1	0.78	0.71	0.1	0.1
Liquid Conductivity (target)	5.0	R	1.732	0.78	0.71	2.3	2.0
Liquid Conductivity (mea.)	2.5	R	1.732	0.78	0.71	1.1	1.0
Temp. unc. - Conductivity	3.4	R	1.732	0.78	0.71	1.5	1.4
Liquid Permittivity Repeatability	0.15	N	1	0.23	0.26	0.0	0.0
Liquid Permittivity (target)	5.0	R	1.732	0.23	0.26	0.7	0.8
Liquid Permittivity (mea.)	2.5	R	1.732	0.23	0.26	0.3	0.4
Temp. unc. - Permittivity	0.83	R	1.732	0.23	0.26	0.1	0.1
Combined Std. Uncertainty						12.8%	12.7%
Coverage Factor for 95 %						K=2	K=2
Expanded STD Uncertainty						25.5%	25.4%

Table 17.3. Uncertainty Budget for frequency range 3 GHz to 6 GHz



18. References

- [1] FCC 47 CFR Part 2 "Frequency Allocations and Radio Treaty Matters; General Rules and Regulations"
- [2] ANSI/IEEE Std. C95.1-1992, "IEEE Standard for Safety Levels with Respect to Human Exposure to Radio Frequency Electromagnetic Fields, 3 kHz to 300 GHz", September 1992
- [3] IEEE Std. 1528-2013, "IEEE Recommended Practice for Determining the Peak Spatial-Average Specific Absorption Rate (SAR) in the Human Head from Wireless Communications Devices: Measurement Techniques", Sep 2013
- [4] SPEAG DASY System Handbook
- [5] FCC KDB 248227 D01 v02r02, "SAR Guidance for IEEE 802.11 (WiFi) Transmitters", Oct 2015.
- [6] FCC KDB 447498 D01 v06, "Mobile and Portable Device RF Exposure Procedures and Equipment Authorization Policies", Oct 2015
- [7] FCC KDB 648474 D04 v01r03, "SAR Evaluation Considerations for Wireless Handsets", Oct 2015.
- [8] FCC KDB 941225 D01 v03r01, "3G SAR MEAUREMENT PROCEDURES", Oct 2015
- [9] FCC KDB 941225 D05 v02r05, "SAR Evaluation Considerations for LTE Devices", Dec 2015
- [10] FCC KDB 941225 D06 v02r01, "SAR Evaluation Procedures for Portable Devices with Wireless Router Capabilities", Oct 2015.
- [11] FCC KDB 865664 D01 v01r04, "SAR Measurement Requirements for 100 MHz to 6 GHz", Aug 2015.
- [12] FCC KDB 865664 D02 v01r02, "RF Exposure Compliance Reporting and Documentation Considerations" Oct 2015.



Appendix A. Plots of System Performance Check

The plots are shown as follows.

System Check_Head_750MHz

DUT: D750V3-1012

Communication System: CW; Frequency: 750 MHz; Duty Cycle: 1:1

Medium: HSL_750_160909 Medium parameters used: $f = 750 \text{ MHz}$; $\sigma = 0.9 \text{ S/m}$; $\epsilon_r = 43.531$; $\rho = 1000 \text{ kg/m}^3$

Ambient Temperature : $23.5 \text{ }^\circ\text{C}$; Liquid Temperature : $22.5 \text{ }^\circ\text{C}$

DASY5 Configuration:

- Probe: ES3DV3 - SN3270; ConvF(6.19, 6.19, 6.19); Calibrated: 2016/8/26;
- Sensor-Surface: 3mm (Mechanical Surface Detection)
- Electronics: DAE4 Sn1399; Calibrated: 2015/11/23
- Phantom: SAM-Right; Type: SAM; Serial: 1795
- Measurement SW: DASY52, Version 52.8 (8); SEMCAD X Version 14.6.10 (7373)

Pin=250mW/Area Scan (61x61x1): Interpolated grid: $dx=1.500 \text{ mm}$, $dy=1.500 \text{ mm}$

Maximum value of SAR (interpolated) = 2.68 W/kg

Pin=250mW/Zoom Scan (5x5x7)/Cube 0: Measurement grid: $dx=8\text{mm}$, $dy=8\text{mm}$, $dz=5\text{mm}$

Reference Value = 56.28 V/m ; Power Drift = -0.18 dB

Peak SAR (extrapolated) = 3.17 W/kg

SAR(1 g) = 2.17 W/kg ; SAR(10 g) = 1.45 W/kg

Maximum value of SAR (measured) = 2.52 W/kg

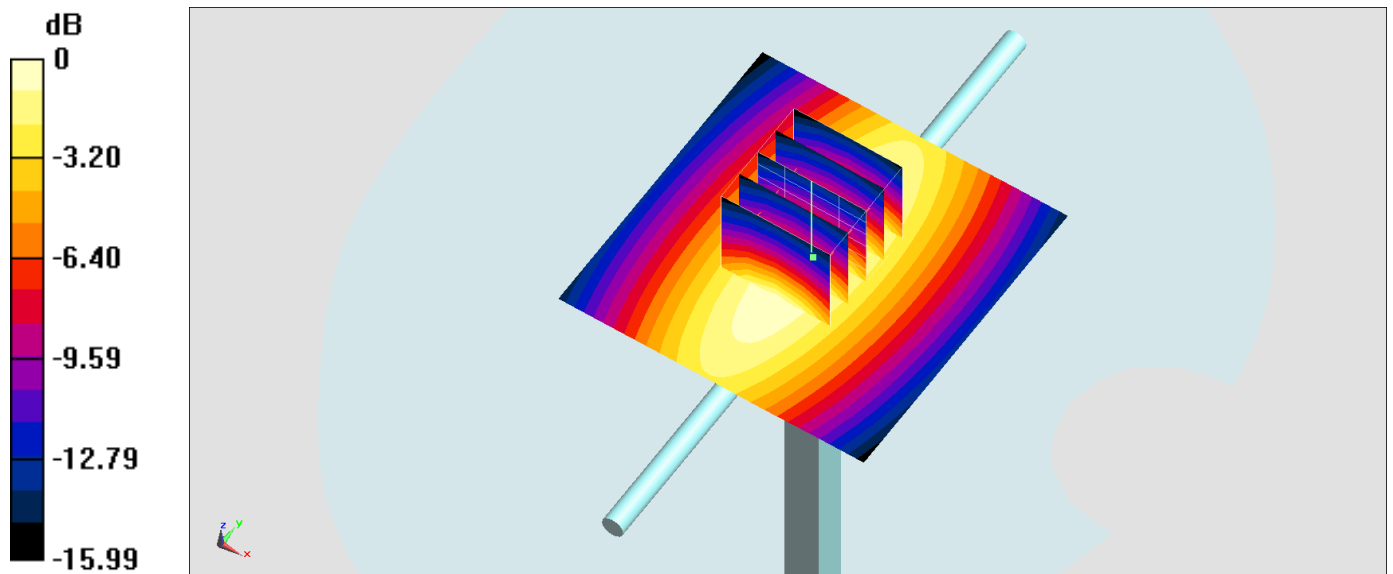

0 dB = $2.68 \text{ W/kg} = 4.28 \text{ dBW/kg}$

System Check_Body_750MHz

DUT: D750V3-1012

Communication System: CW; Frequency: 750 MHz; Duty Cycle: 1:1

Medium: MSL_750_160909 Medium parameters used: $f = 750$ MHz; $\sigma = 0.953$ S/m; $\epsilon_r = 55.798$; $\rho = 1000$ kg/m³

Ambient Temperature : 23.5 °C; Liquid Temperature : 22.5 °C

DASY5 Configuration:

- Probe: ES3DV3 - SN3270; ConvF(6.09, 6.09, 6.09); Calibrated: 2016/8/26;
- Sensor-Surface: 3mm (Mechanical Surface Detection)
- Electronics: DAE4 Sn1399; Calibrated: 2015/11/23
- Phantom: SAM_Left; Type: QD000P40CD; Serial: TP:1644
- Measurement SW: DASY52, Version 52.8 (8); SEMCAD X Version 14.6.10 (7373)

Pin=250mW/Area Scan (61x61x1): Interpolated grid: dx=1.500 mm, dy=1.500 mm

Maximum value of SAR (interpolated) = 2.65 W/kg

Pin=250mW/Zoom Scan (5x5x7)/Cube 0: Measurement grid: dx=8mm, dy=8mm, dz=5mm

Reference Value = 54.17 V/m; Power Drift = -0.02 dB

Peak SAR (extrapolated) = 3.31 W/kg

SAR(1 g) = 2.29 W/kg; SAR(10 g) = 1.54 W/kg

Maximum value of SAR (measured) = 2.66 W/kg

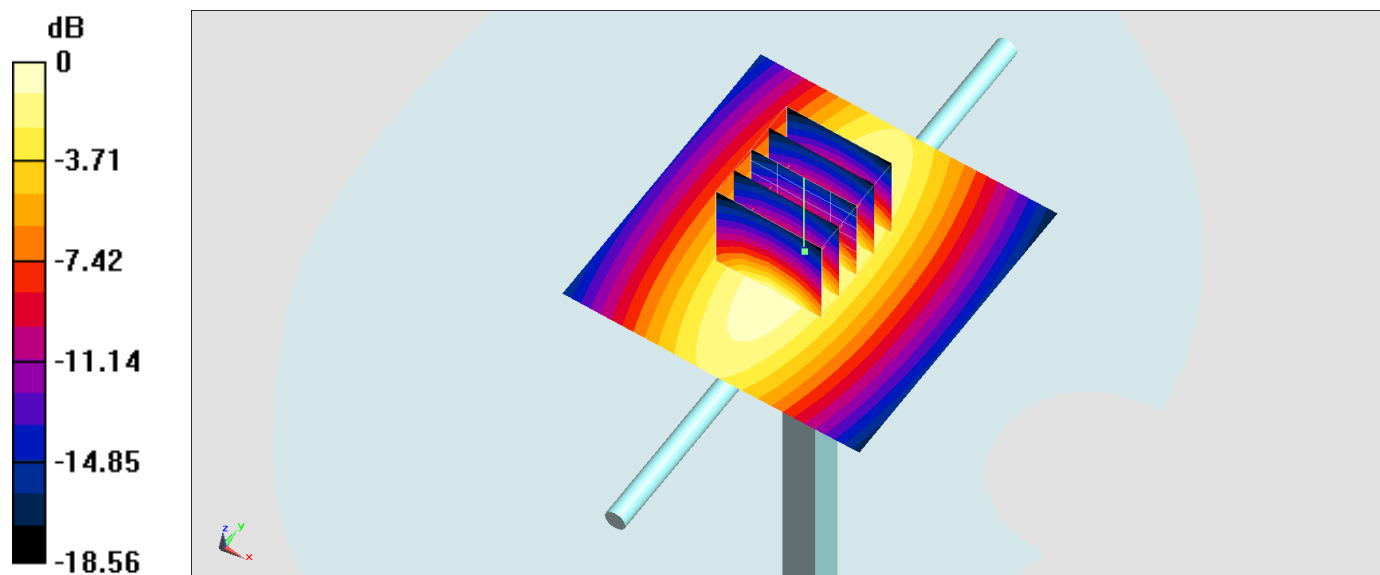

0 dB = 2.65 W/kg = 4.23 dBW/kg

System Check_Body_750MHz

DUT: D750V3-1012

Communication System: CW; Frequency: 750 MHz; Duty Cycle: 1:1

Medium: MSL_750_160909 Medium parameters used: $f = 750$ MHz; $\sigma = 0.953$ S/m; $\epsilon_r = 55.798$; $\rho = 1000$ kg/m³

Ambient Temperature : 23.5 °C; Liquid Temperature : 22.5 °C

DASY5 Configuration:

- Probe: EX3DV4 - SN3955; ConvF(10.36, 10.36, 10.36); Calibrated: 2015/11/24;
- Sensor-Surface: 1.4mm (Mechanical Surface Detection)
- Electronics: DAE4 Sn778; Calibrated: 2016/5/12
- Phantom: SAM_Left; Type: QD000P40CD; Serial: TP:1644
- Measurement SW: DASY52, Version 52.8 (8); SEMCAD X Version 14.6.10 (7373)

Pin=250mW/Area Scan (61x61x1): Interpolated grid: dx=1.500 mm, dy=1.500 mm

Maximum value of SAR (interpolated) = 2.88 W/kg

Pin=250mW/Zoom Scan (5x5x7)/Cube 0: Measurement grid: dx=8mm, dy=8mm, dz=5mm

Reference Value = 58.73 V/m; Power Drift = -0.12 dB

Peak SAR (extrapolated) = 3.21 W/kg

SAR(1 g) = 2.2 W/kg; SAR(10 g) = 1.5 W/kg

Maximum value of SAR (measured) = 2.88 W/kg

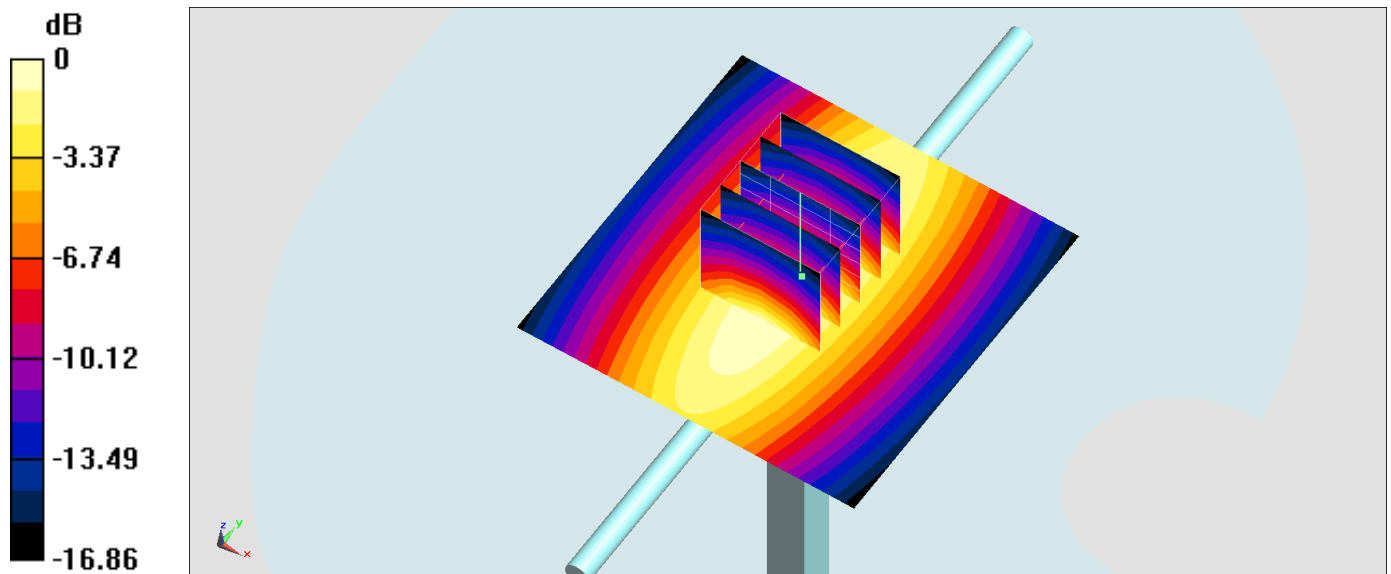

0 dB = 2.88 W/kg = 4.59 dBW/kg

System Check_Head_835MHz

DUT: D835V2-499

Communication System: CW; Frequency: 835 MHz; Duty Cycle: 1:1

Medium: HSL_850_160910 Medium parameters used: $f = 835$ MHz; $\sigma = 0.896$ S/m; $\epsilon_r = 42.544$; $\rho = 1000$ kg/m³

Ambient Temperature : 23.6 °C; Liquid Temperature : 22.6 °C

DASY5 Configuration:

- Probe: ES3DV3 - SN3270; ConvF(6.03, 6.03, 6.03); Calibrated: 2016/8/26;
- Sensor-Surface: 3mm (Mechanical Surface Detection)
- Electronics: DAE4 Sn1399; Calibrated: 2015/11/23
- Phantom: SAM-Right; Type: SAM; Serial: 1795
- Measurement SW: DASY52, Version 52.8 (8); SEMCAD X Version 14.6.10 (7373)

Pin=250mW/Area Scan (61x61x1): Interpolated grid: dx=1.500 mm, dy=1.500 mm

Maximum value of SAR (interpolated) = 3.15 W/kg

Pin=250mW/Zoom Scan (5x5x7)/Cube 0: Measurement grid: dx=8mm, dy=8mm, dz=5mm

Reference Value = 62.92 V/m; Power Drift = -0.02 dB

Peak SAR (extrapolated) = 3.97 W/kg

SAR(1 g) = 2.41 W/kg; SAR(10 g) = 1.55 W/kg

Maximum value of SAR (measured) = 3.14 W/kg

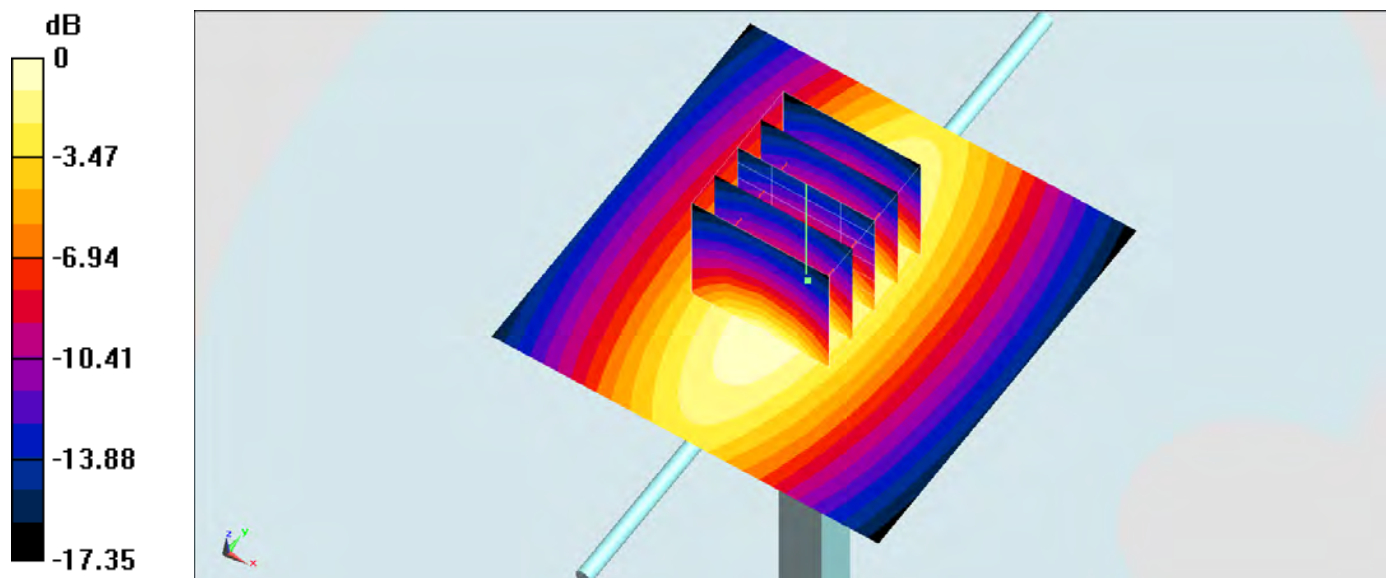

0 dB = 3.15 W/kg = 4.98 dBW/kg

System Check_Body_835MHz

DUT: D835V2-499

Communication System: CW; Frequency: 835 MHz; Duty Cycle: 1:1

Medium: MSL_850_160907 Medium parameters used: $f = 835$ MHz; $\sigma = 0.968$ S/m; $\epsilon_r = 57.158$; $\rho = 1000$ kg/m³

Ambient Temperature : 23.4 °C; Liquid Temperature : 22.4 °C

DASY5 Configuration:

- Probe: EX3DV4 - SN3955; ConvF(10.08, 10.08, 10.08); Calibrated: 2015/11/24;
- Sensor-Surface: 1.4mm (Mechanical Surface Detection)
- Electronics: DAE4 Sn778; Calibrated: 2016/5/12
- Phantom: SAM_Left; Type: QD000P40CD; Serial: TP:1644
- Measurement SW: DASY52, Version 52.8 (8); SEMCAD X Version 14.6.10 (7373)

Pin=250mW/Area Scan (61x61x1): Interpolated grid: dx=1.500 mm, dy=1.500 mm

Maximum value of SAR (interpolated) = 3.29 W/kg

Pin=250mW/Zoom Scan (5x5x7)/Cube 0: Measurement grid: dx=8mm, dy=8mm, dz=5mm

Reference Value = 60.75 V/m; Power Drift = 0.00 dB

Peak SAR (extrapolated) = 3.72 W/kg

SAR(1 g) = 2.49 W/kg; SAR(10 g) = 1.64 W/kg

Maximum value of SAR (measured) = 3.28 W/kg

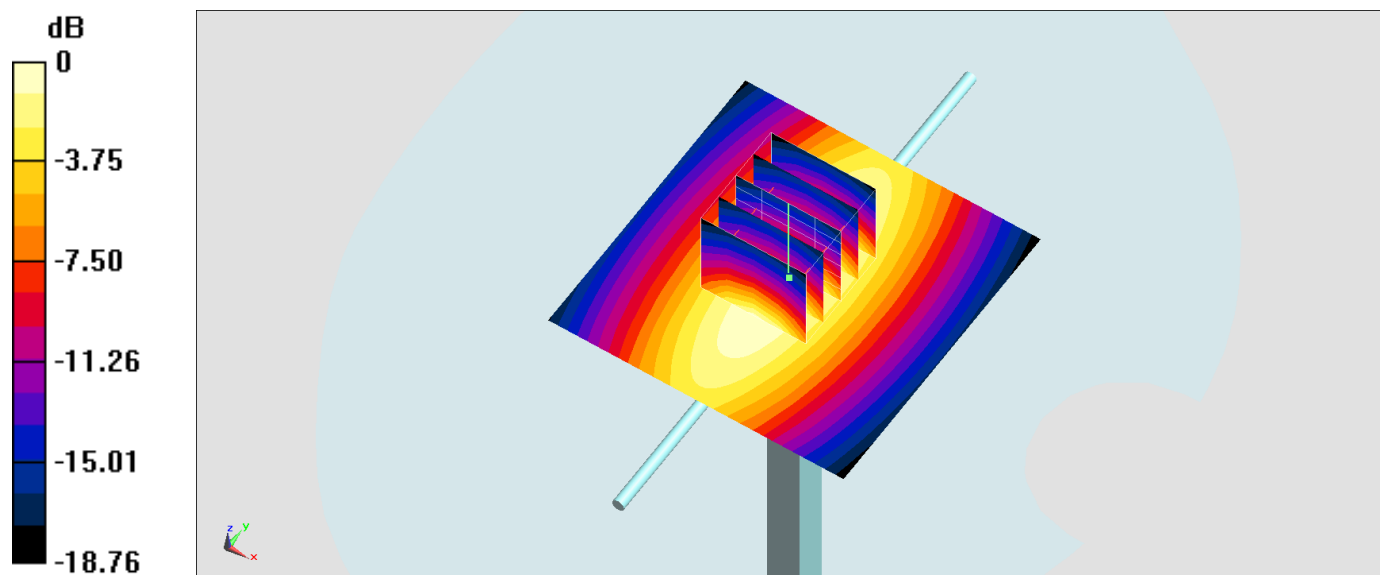

0 dB = 3.29 W/kg = 5.17 dBW/kg

System Check_Body_835MHz

DUT: D835V2-499

Communication System: CW; Frequency: 835 MHz; Duty Cycle: 1:1

Medium: MSL_850_160908 Medium parameters used: $f = 835$ MHz; $\sigma = 0.962$ S/m; $\epsilon_r = 57.058$; $\rho = 1000$ kg/m³

Ambient Temperature : 23.5 °C; Liquid Temperature : 22.5 °C

DASY5 Configuration:

- Probe: ES3DV3 - SN3270; ConvF(6.01, 6.01, 6.01); Calibrated: 2016/8/26;
- Sensor-Surface: 3mm (Mechanical Surface Detection)
- Electronics: DAE4 Sn1399; Calibrated: 2015/11/23
- Phantom: SAM_Left; Type: QD000P40CD; Serial: TP:1644
- Measurement SW: DASY52, Version 52.8 (8); SEMCAD X Version 14.6.10 (7373)

Pin=250mW/Area Scan (61x61x1): Interpolated grid: dx=1.500 mm, dy=1.500 mm

Maximum value of SAR (interpolated) = 2.85 W/kg

Pin=250mW/Zoom Scan (5x5x7)/Cube 0: Measurement grid: dx=8mm, dy=8mm, dz=5mm

Reference Value = 55.64 V/m; Power Drift = -0.01 dB

Peak SAR (extrapolated) = 3.45 W/kg

SAR(1 g) = 2.41 W/kg; SAR(10 g) = 1.6 W/kg

Maximum value of SAR (measured) = 2.79 W/kg

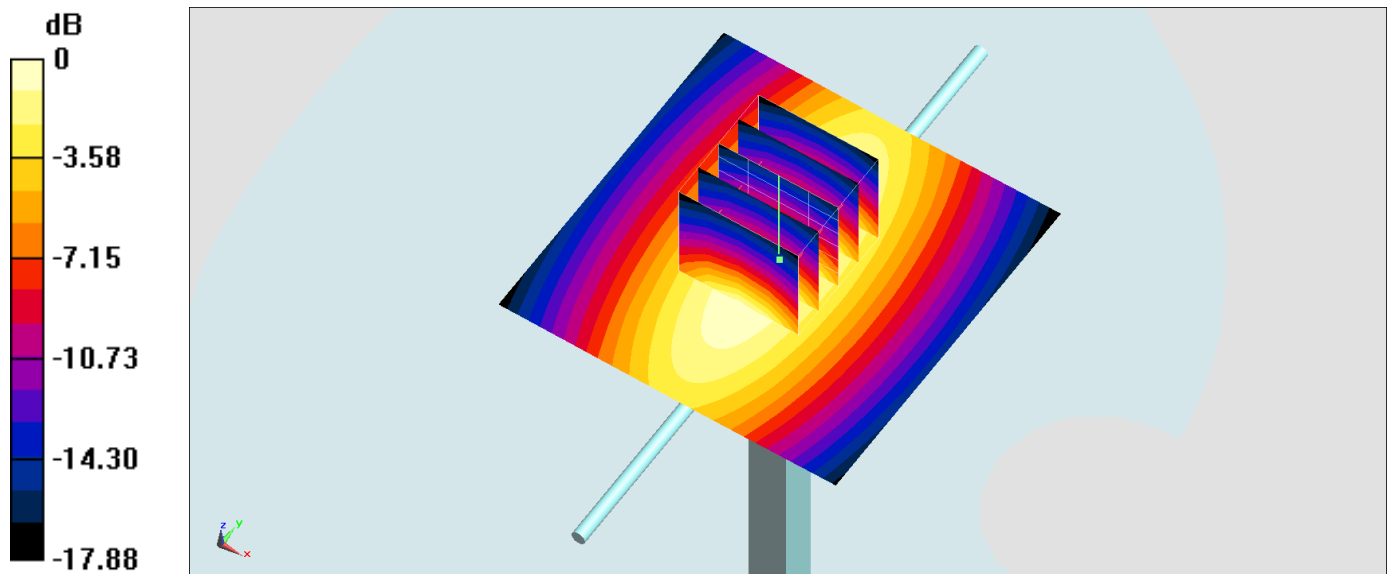

0 dB = 2.85 W/kg = 4.55 dBW/kg

System Check_Body_835MHz

DUT: D835V2-499

Communication System: CW; Frequency: 835 MHz; Duty Cycle: 1:1

Medium: MSL_850_160908 Medium parameters used: $f = 835 \text{ MHz}$; $\sigma = 0.962 \text{ S/m}$; $\epsilon_r = 57.058$; $\rho = 1000 \text{ kg/m}^3$

Ambient Temperature : $23.5 \text{ }^\circ\text{C}$; Liquid Temperature : $22.5 \text{ }^\circ\text{C}$

DASY5 Configuration:

- Probe: EX3DV4 - SN3955; ConvF(10.08, 10.08, 10.08); Calibrated: 2015/11/24;
- Sensor-Surface: 1.4mm (Mechanical Surface Detection)
- Electronics: DAE4 Sn778; Calibrated: 2016/5/12
- Phantom: SAM_Left; Type: QD000P40CD; Serial: TP:1644
- Measurement SW: DASY52, Version 52.8 (8); SEMCAD X Version 14.6.10 (7373)

Pin=250mW/Area Scan (61x61x1): Interpolated grid: $dx=1.500 \text{ mm}$, $dy=1.500 \text{ mm}$

Maximum value of SAR (interpolated) = 3.23 W/kg

Pin=250mW/Zoom Scan (5x5x7)/Cube 0: Measurement grid: $dx=8\text{mm}$, $dy=8\text{mm}$, $dz=5\text{mm}$

Reference Value = 60.79 V/m ; Power Drift = -0.12 dB

Peak SAR (extrapolated) = 3.48 W/kg

SAR(1 g) = 2.41 W/kg ; SAR(10 g) = 1.62 W/kg

Maximum value of SAR (measured) = 3.13 W/kg

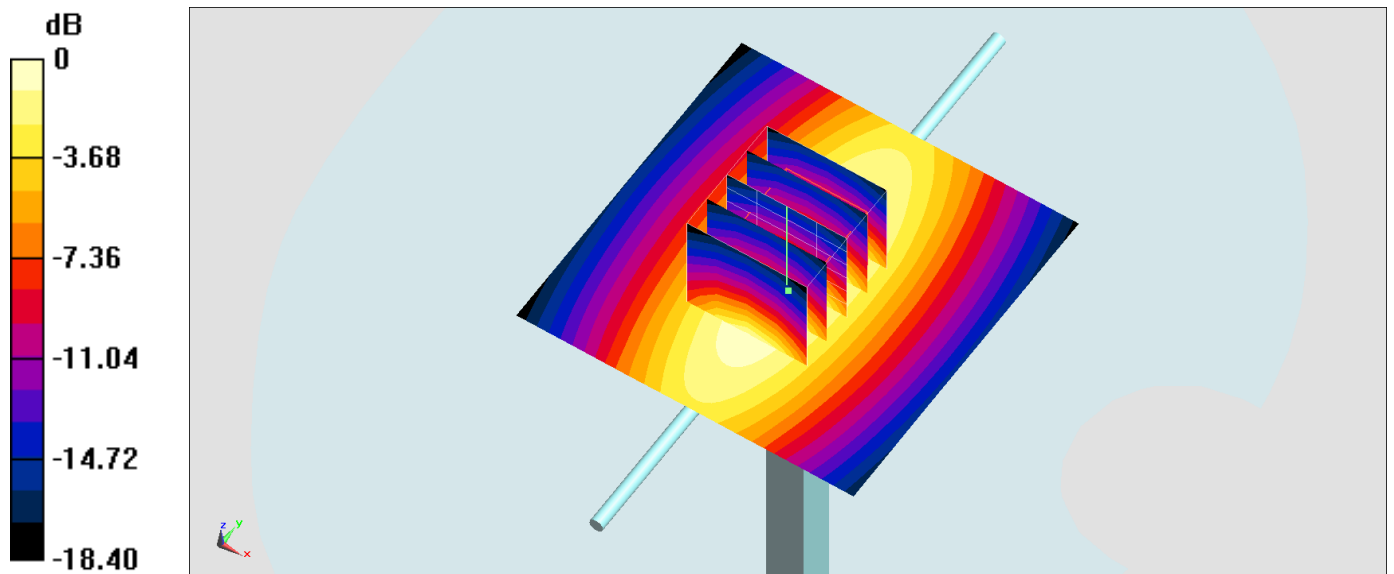

0 dB = $3.23 \text{ W/kg} = 5.09 \text{ dBW/kg}$

System Check_Head_1750MHz

DUT: D1750V2-1068

Communication System: CW; Frequency: 1750 MHz; Duty Cycle: 1:1

Medium: HSL_1750_160911 Medium parameters used: $f = 1750$ MHz; $\sigma = 1.372$ S/m; $\epsilon_r = 40.003$; $\rho = 1000$ kg/m³

Ambient Temperature : 23.2 °C; Liquid Temperature : 22.2 °C

DASY5 Configuration:

- Probe: ES3DV3 - SN3270; ConvF(5.21, 5.21, 5.21); Calibrated: 2016/8/26;
- Sensor-Surface: 3mm (Mechanical Surface Detection)
- Electronics: DAE4 Sn1399; Calibrated: 2015/11/23
- Phantom: SAM_Left; Type: QD000P40CD; Serial: TP:1644
- Measurement SW: DASY52, Version 52.8 (8); SEMCAD X Version 14.6.10 (7373)

Pin=250mW/Area Scan (61x61x1): Interpolated grid: dx=1.500 mm, dy=1.500 mm

Maximum value of SAR (interpolated) = 11.9 W/kg

Pin=250mW/Zoom Scan (5x5x7)/Cube 0: Measurement grid: dx=8mm, dy=8mm, dz=5mm

Reference Value = 95.39 V/m; Power Drift = -0.11 dB

Peak SAR (extrapolated) = 15.7 W/kg

SAR(1 g) = 9.27 W/kg; SAR(10 g) = 5.08 W/kg

Maximum value of SAR (measured) = 11.3 W/kg

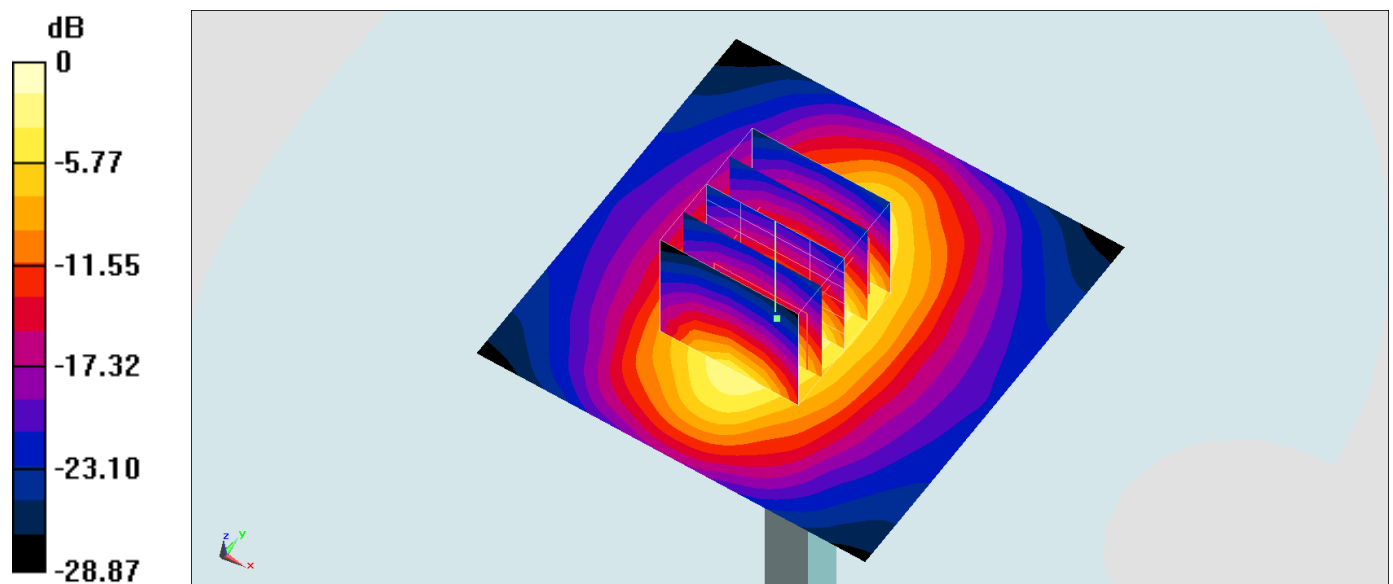

0 dB = 11.9 W/kg = 10.76 dBW/kg

System Check_Body_1750MHz

DUT: D1750V2-1068

Communication System: CW; Frequency: 1750 MHz; Duty Cycle: 1:1

Medium: MSL_1750_160906 Medium parameters used: $f = 1750$ MHz; $\sigma = 1.509$ S/m; $\epsilon_r = 55.934$; $\rho = 1000$ kg/m³

Ambient Temperature : 23.7 °C; Liquid Temperature : 22.7 °C

DASY5 Configuration:

- Probe: EX3DV4 - SN3955; ConvF(8.25, 8.25, 8.25); Calibrated: 2015/11/24;
- Sensor-Surface: 1.4mm (Mechanical Surface Detection)
- Electronics: DAE4 Sn778; Calibrated: 2016/5/12
- Phantom: SAM_Left; Type: QD000P40CD; Serial: TP:1644
- Measurement SW: DASY52, Version 52.8 (8); SEMCAD X Version 14.6.10 (7373)

Pin=250mW/Area Scan (61x61x1): Interpolated grid: dx=1.500 mm, dy=1.500 mm
 Maximum value of SAR (interpolated) = 14.5 W/kg

Pin=250mW/Zoom Scan (5x5x7)/Cube 0: Measurement grid: dx=8mm,y=8mm, dz=5mm
 Reference Value = 94.80 V/m; Power Drift = -0.13 dB
 Peak SAR (extrapolated) = 15.6 W/kg
SAR(1 g) = 9.19 W/kg; SAR(10 g) = 5.09 W/kg
 Maximum value of SAR (measured) = 12.9 W/kg

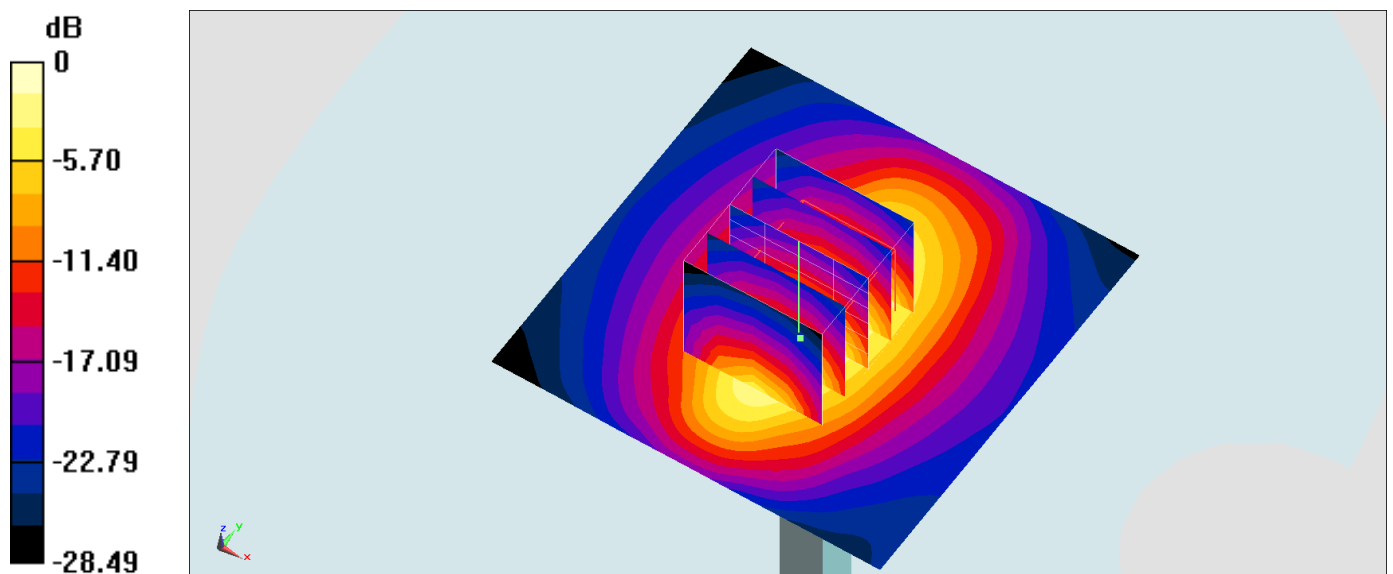

0 dB = 14.5 W/kg = 11.61 dBW/kg

System Check_Head_1900MHz

DUT: D1900V2-5d041

Communication System: CW; Frequency: 1900 MHz; Duty Cycle: 1:1

Medium: HSL_1900_160911 Medium parameters used: $f = 1900$ MHz; $\sigma = 1.396$ S/m; $\epsilon_r = 40.551$; $\rho = 1000$ kg/m³

Ambient Temperature : 23.2 °C; Liquid Temperature : 22.2 °C

DASY5 Configuration:

- Probe: ES3DV3 - SN3270; ConvF(5.08, 5.08, 5.08); Calibrated: 2016/8/26;
- Sensor-Surface: 3mm (Mechanical Surface Detection)
- Electronics: DAE4 Sn1399; Calibrated: 2015/11/23
- Phantom: SAM_Left; Type: QD000P40CD; Serial: TP:1644
- Measurement SW: DASY52, Version 52.8 (8); SEMCAD X Version 14.6.10 (7373)

Pin=250mW/Area Scan (61x61x1): Interpolated grid: dx=1.500 mm, dy=1.500 mm

Maximum value of SAR (interpolated) = 12.6 W/kg

Pin=250mW/Zoom Scan (5x5x7)/Cube 0: Measurement grid: dx=8mm, dy=8mm, dz=5mm

Reference Value = 97.24 V/m; Power Drift = -0.07 dB

Peak SAR (extrapolated) = 17.1 W/kg

SAR(1 g) = 9.54 W/kg; SAR(10 g) = 4.99 W/kg

Maximum value of SAR (measured) = 12.1 W/kg

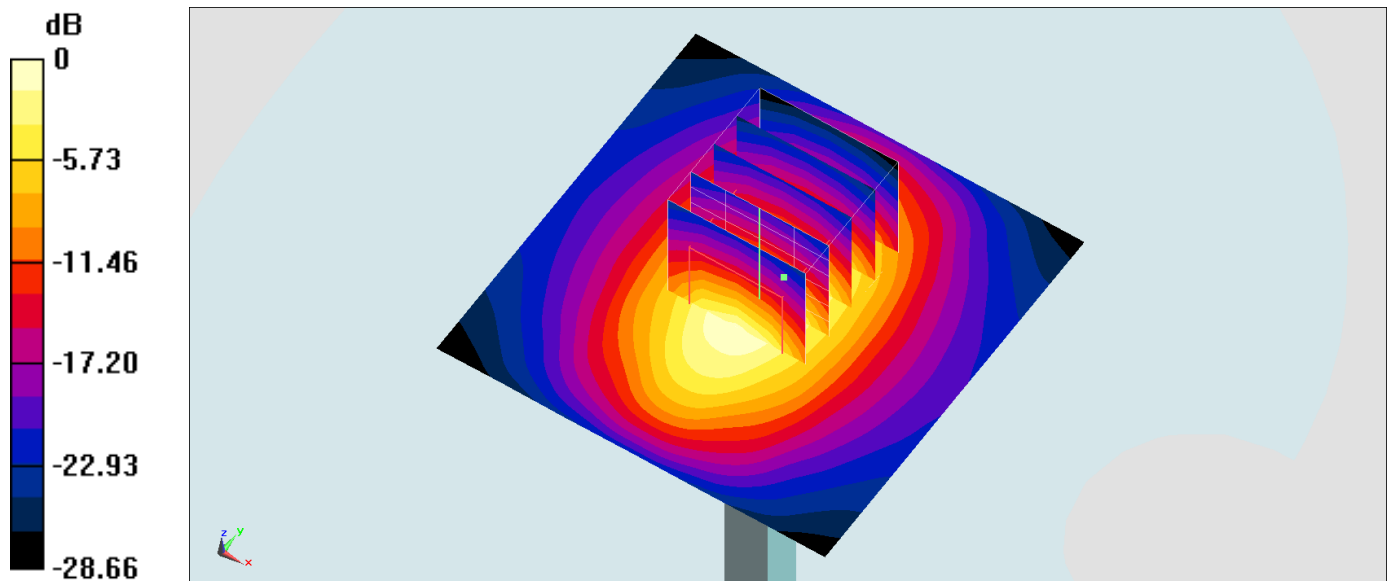

0 dB = 12.6 W/kg = 11.00 dBW/kg

System Check_Body_1900MHz

DUT: D1900V2-5d041

Communication System: CW; Frequency: 1900 MHz; Duty Cycle: 1:1

Medium: MSL_1900_160905 Medium parameters used: $f = 1900$ MHz; $\sigma = 1.553$ S/m; $\epsilon_r = 55.777$; $\rho = 1000$ kg/m³

Ambient Temperature : 23.7 °C; Liquid Temperature : 22.7 °C

DASY5 Configuration:

- Probe: EX3DV4 - SN3955; ConvF(7.89, 7.89, 7.89); Calibrated: 2015/11/24;
- Sensor-Surface: 1.4mm (Mechanical Surface Detection)
- Electronics: DAE4 Sn778; Calibrated: 2016/5/12
- Phantom: SAM_Left; Type: QD000P40CD; Serial: TP:1644
- Measurement SW: DASY52, Version 52.8 (8); SEMCAD X Version 14.6.10 (7373)

Pin=250mW/Area Scan (61x61x1): Interpolated grid: dx=1.500 mm, dy=1.500 mm
Maximum value of SAR (interpolated) = 15.3 W/kg

Pin=250mW/Zoom Scan (5x5x7)/Cube 0: Measurement grid: dx=8mm,y=8mm, dz=5mm
Reference Value = 100.5 V/m; Power Drift = -0.07 dB
Peak SAR (extrapolated) = 17.5 W/kg
SAR(1 g) = 10.1 W/kg; SAR(10 g) = 5.4 W/kg
Maximum value of SAR (measured) = 14.8 W/kg

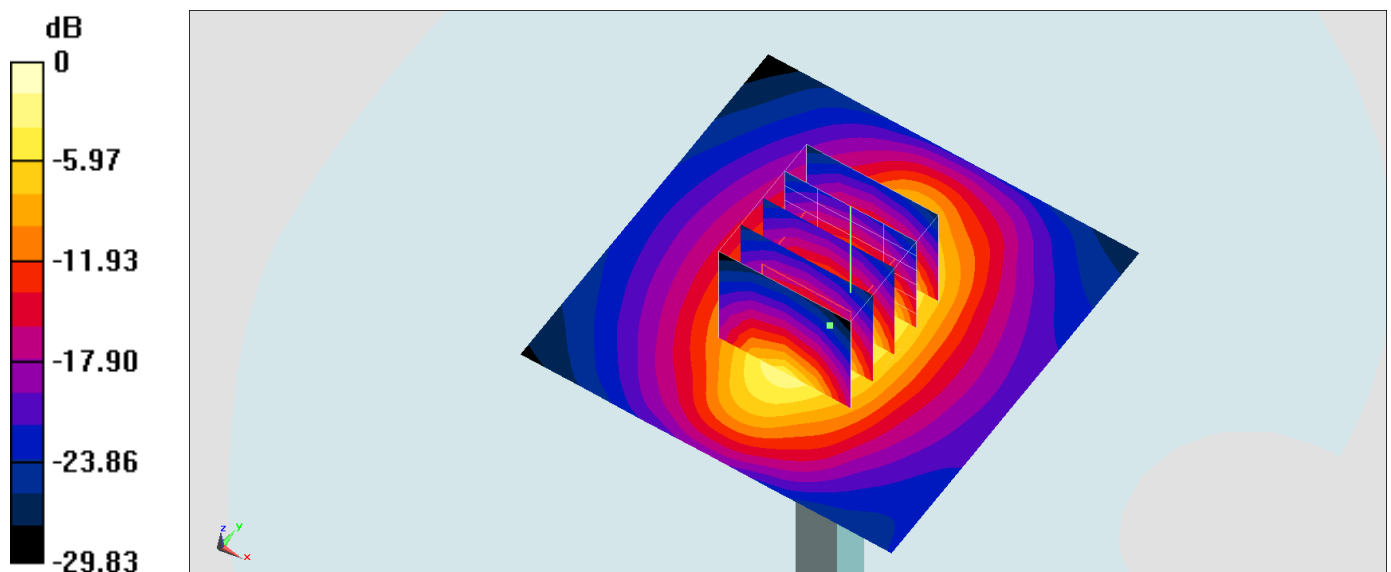

0 dB = 15.3 W/kg = 11.85 dBW/kg

System Check_Body_1900MHz

DUT: D1900V2-5d041

Communication System: CW; Frequency: 1900 MHz; Duty Cycle: 1:1

Medium: MSL_1900_160907 Medium parameters used: $f = 1900$ MHz; $\sigma = 1.546$ S/m; $\epsilon_r = 55.745$; $\rho = 1000$ kg/m³

Ambient Temperature : 23.4 °C; Liquid Temperature : 22.4 °C

DASY5 Configuration:

- Probe: EX3DV4 - SN3955; ConvF(7.89, 7.89, 7.89); Calibrated: 2015/11/24;
- Sensor-Surface: 1.4mm (Mechanical Surface Detection)
- Electronics: DAE4 Sn778; Calibrated: 2016/5/12
- Phantom: SAM_Left; Type: QD000P40CD; Serial: TP:1644
- Measurement SW: DASY52, Version 52.8 (8); SEMCAD X Version 14.6.10 (7373)

Pin=250mW/Area Scan (61x61x1): Interpolated grid: dx=1.500 mm, dy=1.500 mm

Maximum value of SAR (interpolated) = 15.7 W/kg

Pin=250mW/Zoom Scan (5x5x7)/Cube 0: Measurement grid: dx=8mm, dy=8mm, dz=5mm

Reference Value = 101.8 V/m; Power Drift = -0.08 dB

Peak SAR (extrapolated) = 17.6 W/kg

SAR(1 g) = 10.2 W/kg; SAR(10 g) = 5.42 W/kg

Maximum value of SAR (measured) = 14.8 W/kg

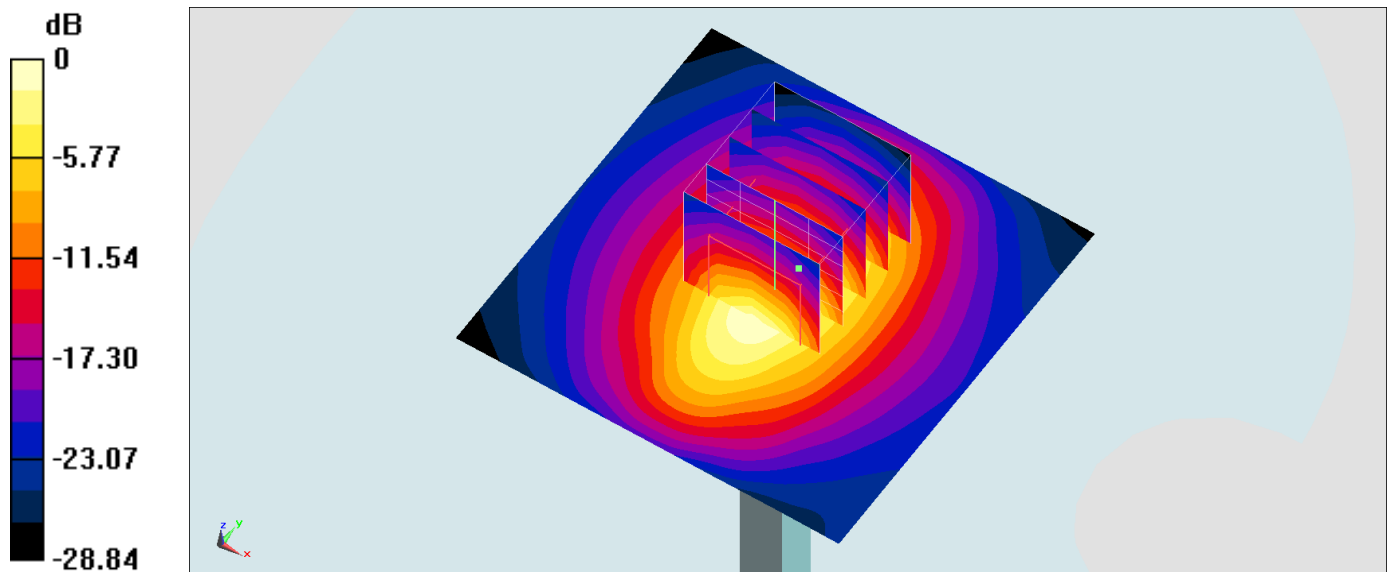

System Check_Head_2450MHz

DUT: D2450V2-735

Communication System: CW; Frequency: 2450 MHz; Duty Cycle: 1:1

Medium: HSL_2450_160908 Medium parameters used: $f = 2450$ MHz; $\sigma = 1.763$ S/m; $\epsilon_r = 40.773$; $\rho = 1000$ kg/m³

Ambient Temperature : 23.6 °C ; Liquid Temperature : 22.6 °C

DASY5 Configuration:

- Probe: EX3DV4 - SN3697; ConvF(6.75, 6.75, 6.75); Calibrated: 2015/9/28;
- Sensor-Surface: 1.4mm (Mechanical Surface Detection)
- Electronics: DAE4 Sn1388; Calibrated: 2015/9/25
- Phantom: SAM_Right; Type: QD000P40CD; Serial: TP:1383
- Measurement SW: DASY52, Version 52.8 (8); SEMCAD X Version 14.6.10 (7331)

Pin=250mW/Area Scan (71x71x1): Interpolated grid: dx=1.200 mm, dy=1.200 mm

Maximum value of SAR (interpolated) = 22.6 W/kg

Pin=250mW/Zoom Scan (7x7x7)/Cube 0: Measurement grid: dx=5mm, dy=5mm, dz=5mm

Reference Value = 115.4 V/m; Power Drift = -0.15 dB

Peak SAR (extrapolated) = 26.8 W/kg

SAR(1 g) = 12.9 W/kg; SAR(10 g) = 6 W/kg

Maximum value of SAR (measured) = 21.5 W/kg

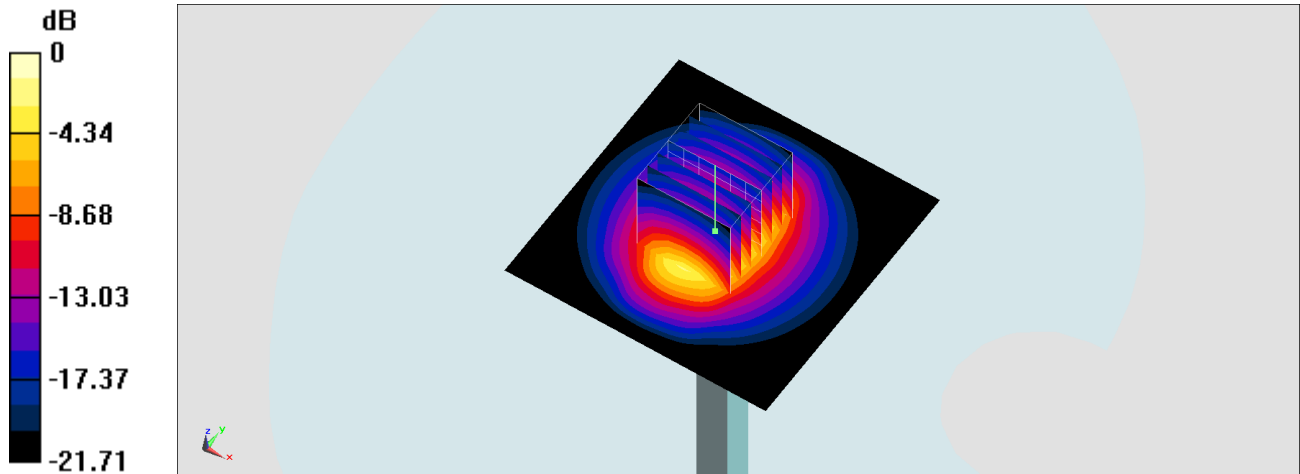

0 dB = 21.5 W/kg = 13.32 dBW/kg

System Check_Body_2450MHz

DUT: D2450V2-735

Communication System: CW; Frequency: 2450 MHz; Duty Cycle: 1:1

Medium: MSL_2450_160908 Medium parameters used: $f = 2450$ MHz; $\sigma = 1.981$ S/m; $\epsilon_r = 52.574$; $\rho = 1000$ kg/m³

Ambient Temperature : 23.6 °C ; Liquid Temperature : 22.6 °C

DASY5 Configuration:

- Probe: EX3DV4 - SN3697; ConvF(6.9, 6.9, 6.9); Calibrated: 2015/9/28;
- Sensor-Surface: 1.4mm (Mechanical Surface Detection)
- Electronics: DAE4 Sn1388; Calibrated: 2015/9/25
- Phantom: SAM_Right; Type: QD000P40CD; Serial: TP:1383
- Measurement SW: DASY52, Version 52.8 (8); SEMCAD X Version 14.6.10 (7331)

Pin=250mW/Area Scan (61x61x1): Interpolated grid: dx=1.200 mm, dy=1.200 mm

Maximum value of SAR (interpolated) = 21.4 W/kg

Pin=250mW/Zoom Scan (7x7x7)/Cube 0: Measurement grid: dx=5mm, dy=5mm, dz=5mm

Reference Value = 104.8 V/m; Power Drift = 0.10 dB

Peak SAR (extrapolated) = 26.3 W/kg

SAR(1 g) = 12.9 W/kg; SAR(10 g) = 5.99 W/kg

Maximum value of SAR (measured) = 21.3 W/kg

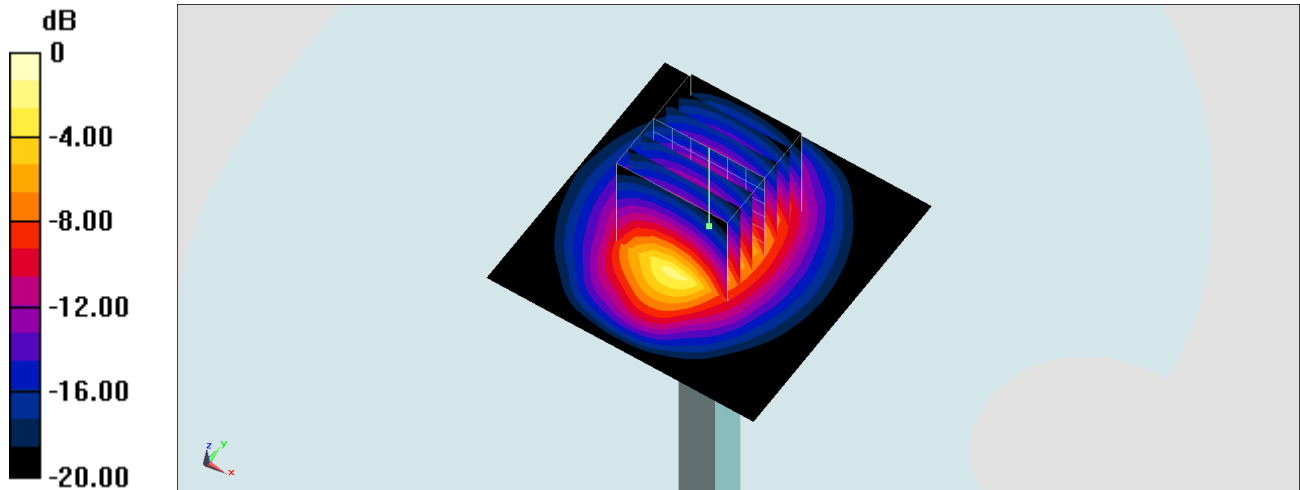

0 dB = 21.3 W/kg = 13.28 dBW/kg

System Check_Body_2450MHz

DUT: D2450V2-735

Communication System: CW; Frequency: 2450 MHz; Duty Cycle: 1:1

Medium: MSL_2450_160921 Medium parameters used: $f = 2450$ MHz; $\sigma = 1.96$ S/m; $\epsilon_r = 52.299$; $\rho = 1000$ kg/m³

Ambient Temperature : 23.4 °C; Liquid Temperature : 22.4 °C

DASY5 Configuration:

- Probe: EX3DV4 - SN3925; ConvF(7.64, 7.64, 7.64); Calibrated: 2016/5/26;
- Sensor-Surface: 1.4mm (Mechanical Surface Detection)
- Electronics: DAE3 Sn495; Calibrated: 2016/5/27
- Phantom: SAM-Right; Type: SAM; Serial: 1795
- Measurement SW: DASY52, Version 52.8 (8); SEMCAD X Version 14.6.10 (7331)

Pin=250mW/Area Scan (61x61x1): Interpolated grid: dx=1.200 mm, dy=1.200 mm
Maximum value of SAR (interpolated) = 20.0 W/kg

Pin=250mW/Zoom Scan (7x7x7)/Cube 0: Measurement grid: dx=5mm, dy=5mm, dz=5mm
Reference Value = 104.0 V/m; Power Drift = -0.02 dB
Peak SAR (extrapolated) = 24.4 W/kg
SAR(1 g) = 12.2 W/kg; SAR(10 g) = 5.74 W/kg
Maximum value of SAR (measured) = 20.0 W/kg

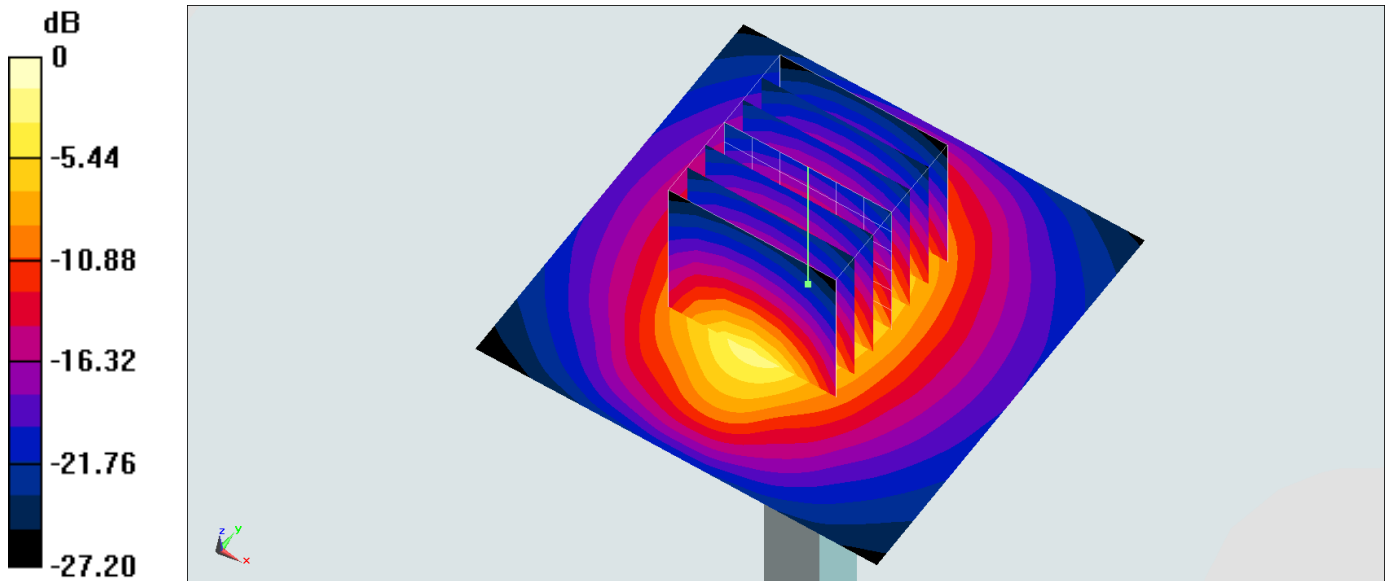

0 dB = 20.0 W/kg = 13.01 dBW/kg

System Check_Body_5250MHz

DUT: D5GHzV2-1128

Communication System: CW; Frequency: 5250 MHz; Duty Cycle: 1:1

Medium: MSL_5G_160909 Medium parameters used: $f = 5250$ MHz; $\sigma = 5.472$ S/m; $\epsilon_r = 46.898$; $\rho = 1000$ kg/m³

Ambient Temperature : 23.9 °C ; Liquid Temperature : 22.9 °C

DASY5 Configuration:

- Probe: EX3DV4 - SN3931; ConvF(4.48, 4.48, 4.48); Calibrated: 2015/10/1;
- Sensor-Surface: 1.4mm (Mechanical Surface Detection)
- Electronics: DAE3 Sn577; Calibrated: 2015/9/24
- Phantom: SAM_Right; Type: QD000P40CD; Serial: TP:1383
- Measurement SW: DASY52, Version 52.8 (8); SEMCAD X Version 14.6.10 (7331)

Pin=100mW/Area Scan (71x71x1): Interpolated grid: dx=1.000 mm, dy=1.000 mm

Maximum value of SAR (interpolated) = 18.2 W/kg

Pin=100mW/Zoom Scan (7x7x7)/Cube 0: Measurement grid: dx=4mm, dy=4mm, dz=1.4mm

Reference Value = 63.93 V/m; Power Drift = 0.09 dB

Peak SAR (extrapolated) = 28.9 W/kg

SAR(1 g) = 7.47 W/kg; SAR(10 g) = 2.09 W/kg

Maximum value of SAR (measured) = 18.0 W/kg

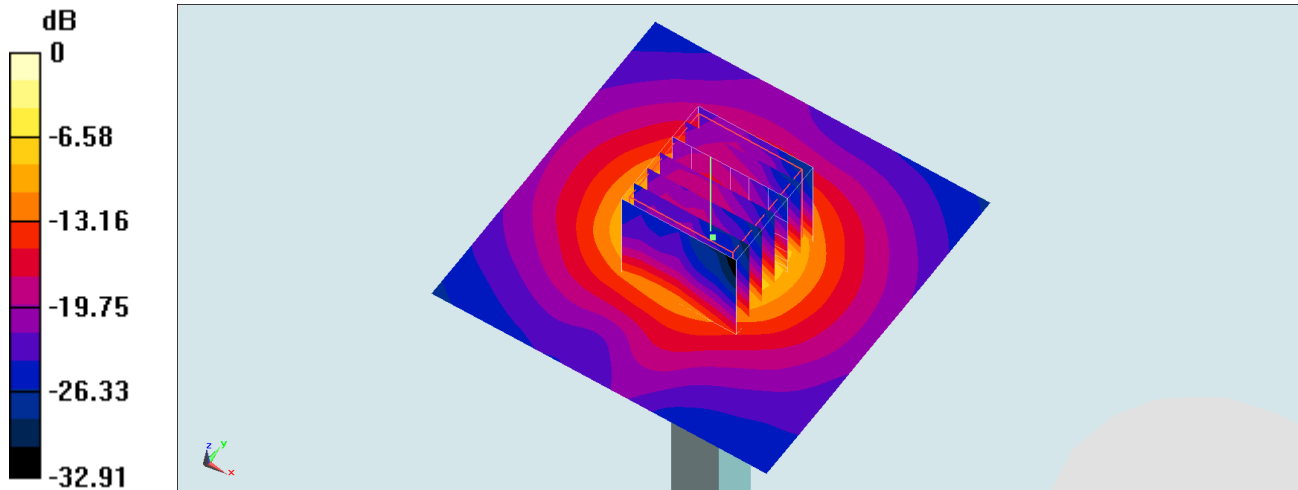

0 dB = 18.0 W/kg = 12.55 dBW/kg

System Check_Body_5250MHz

DUT: D5GHzV2-1128

Communication System: CW; Frequency: 5250 MHz; Duty Cycle: 1:1

Medium: MSL_5G_160913 Medium parameters used: $f = 5250$ MHz; $\sigma = 5.463$ S/m; $\epsilon_r = 46.788$; $\rho = 1000$ kg/m³

Ambient Temperature : 23.5 °C; Liquid Temperature : 22.5 °C

DASY5 Configuration:

- Probe: EX3DV4 - SN3931; ConvF(4.48, 4.48, 4.48); Calibrated: 2015/10/1;
- Sensor-Surface: 1.4mm (Mechanical Surface Detection)
- Electronics: DAE3 Sn577; Calibrated: 2015/9/24
- Phantom: SAM-Right; Type: SAM; Serial: 1795
- Measurement SW: DASY52, Version 52.8 (8); SEMCAD X Version 14.6.10 (7373)

Pin=100mW/Area Scan (71x71x1): Interpolated grid: dx=1.000 mm, dy=1.000 mm

Maximum value of SAR (interpolated) = 18.8 W/kg

Pin=100mW/Zoom Scan (7x7x7)/Cube 0: Measurement grid: dx=4mm, dy=4mm, dz=1.4mm

Reference Value = 65.41 V/m; Power Drift = 0.11 dB

Peak SAR (extrapolated) = 32.0 W/kg

SAR(1 g) = 7.88 W/kg; SAR(10 g) = 2.18 W/kg

Maximum value of SAR (measured) = 19.5 W/kg

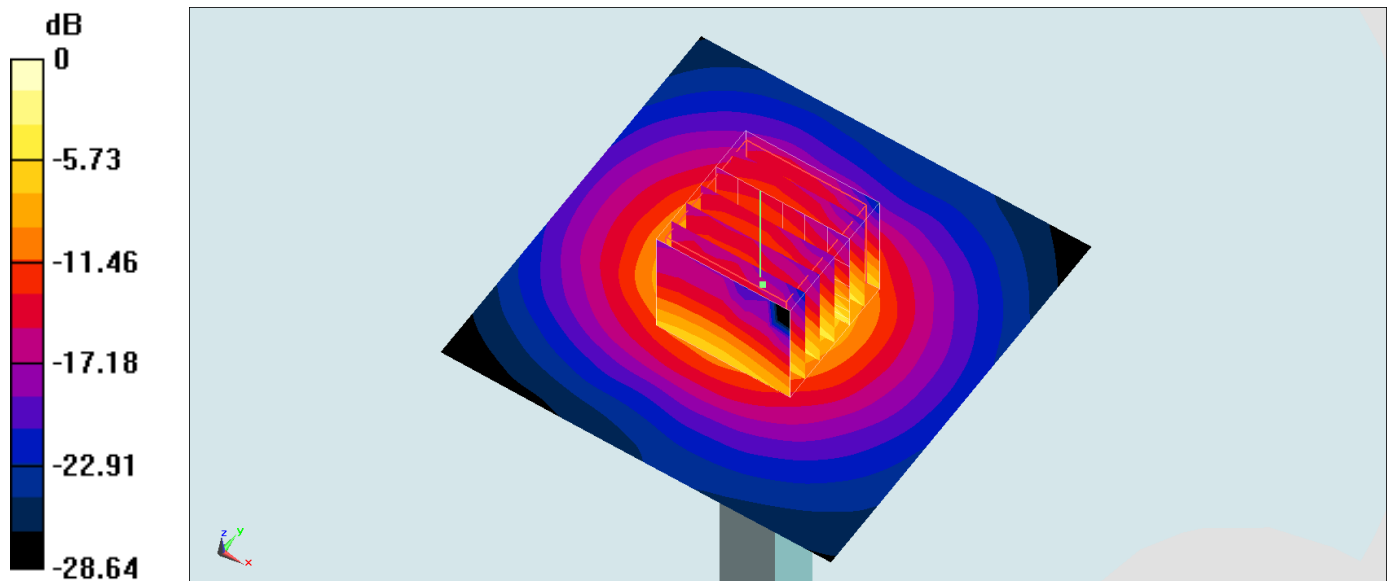

0 dB = 18.8 W/kg = 12.74 dBW/kg

System Check_Head_5300MHz

DUT: D5GHzV2-1006

Communication System: CW ; Frequency: 5300 MHz;Duty Cycle: 1:1

Medium: HSL_5G_160908 Medium parameters used: $f = 5300$ MHz; $\sigma = 4.597$ S/m; $\epsilon_r = 36.154$; $\rho = 1000$ kg/m³

Ambient Temperature : 23.6 °C ; Liquid Temperature : 22.6 °C

DASY5 Configuration:

- Probe: EX3DV4 - SN3925; ConvF(5.15, 5.15, 5.15); Calibrated: 2016/5/26;
- Sensor-Surface: 1.4mm (Mechanical Surface Detection)
- Electronics: DAE3 Sn495; Calibrated: 2016/5/27
- Phantom: SAM_Left; Type: QD 000 P40 CB; Serial: TP-1478
- Measurement SW: DASY52, Version 52.8 (8);SEMCAD X Version 14.6.10 (7331)

Pin=100mW/Area Scan (71x71x1): Interpolated grid: dx=1.000 mm, dy=1.000 mm

Maximum value of SAR (interpolated) = 19.0 W/kg

Pin=100mW/Zoom Scan (7x7x7)/Cube 0: Measurement grid: dx=4mm, dy=4mm, dz=1.4mm

Reference Value = 71.02 V/m; Power Drift = 0.05 dB

Peak SAR (extrapolated) = 33.9 W/kg

SAR(1 g) = 8.06 W/kg; SAR(10 g) = 2.2 W/kg

Maximum value of SAR (measured) = 20.1 W/kg

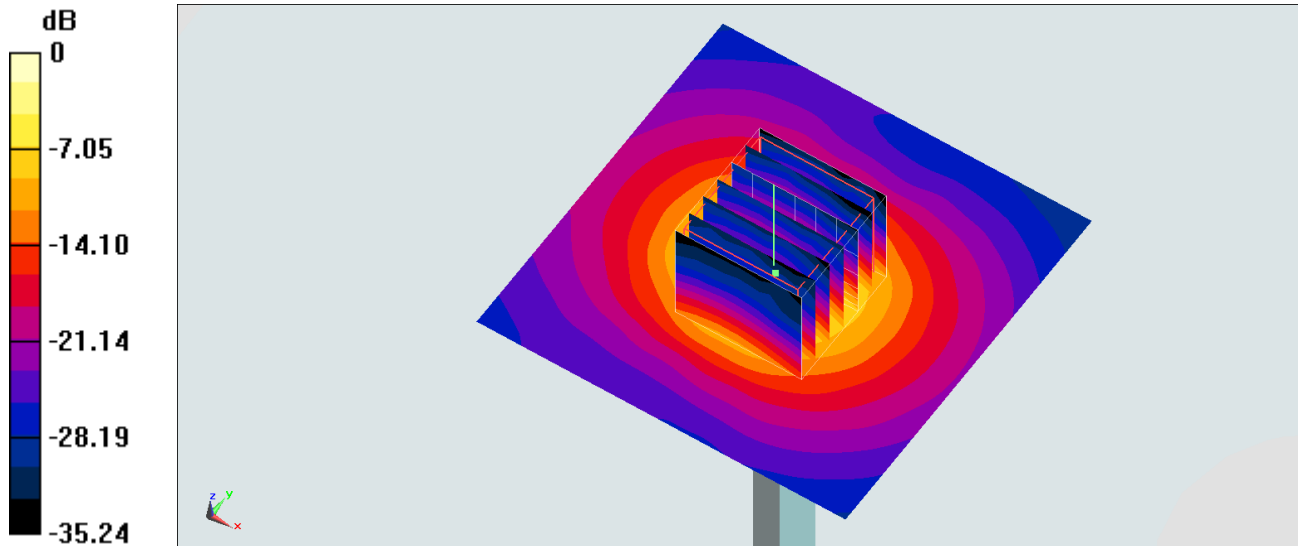

0 dB = 20.1 W/kg = 13.03 dBW/kg

System Check_Head_5600MHz

DUT: D5GHzV2-1006

Communication System: CW; Frequency: 5600 MHz; Duty Cycle: 1:1

Medium: HSL_5G_160908 Medium parameters used: $f = 5600$ MHz; $\sigma = 4.892$ S/m; $\epsilon_r = 35.748$; $\rho = 1000$ kg/m³

Ambient Temperature : 23.6 °C ; Liquid Temperature : 22.6 °C

DASY5 Configuration:

- Probe: EX3DV4 - SN3925; ConvF(4.47, 4.47, 4.47); Calibrated: 2016/5/26;
- Sensor-Surface: 1.4mm (Mechanical Surface Detection)
- Electronics: DAE3 Sn495; Calibrated: 2016/5/27
- Phantom: SAM_Right; Type: QD000P40CD; Serial: TP:1383
- Measurement SW: DASY52, Version 52.8 (8); SEMCAD X Version 14.6.10 (7331)

Pin=100mW/Area Scan (71x71x1): Interpolated grid: dx=1.000 mm, dy=1.000 mm
Maximum value of SAR (interpolated) = 21.3 W/kg

Pin=100mW/Zoom Scan (7x7x7)/Cube 0: Measurement grid: dx=4mm, dy=4mm, dz=1.4mm
Reference Value = 65.38 V/m; Power Drift = 0.01 dB
Peak SAR (extrapolated) = 35.6 W/kg
SAR(1 g) = 8.95 W/kg; SAR(10 g) = 2.45 W/kg
Maximum value of SAR (measured) = 22.1 W/kg

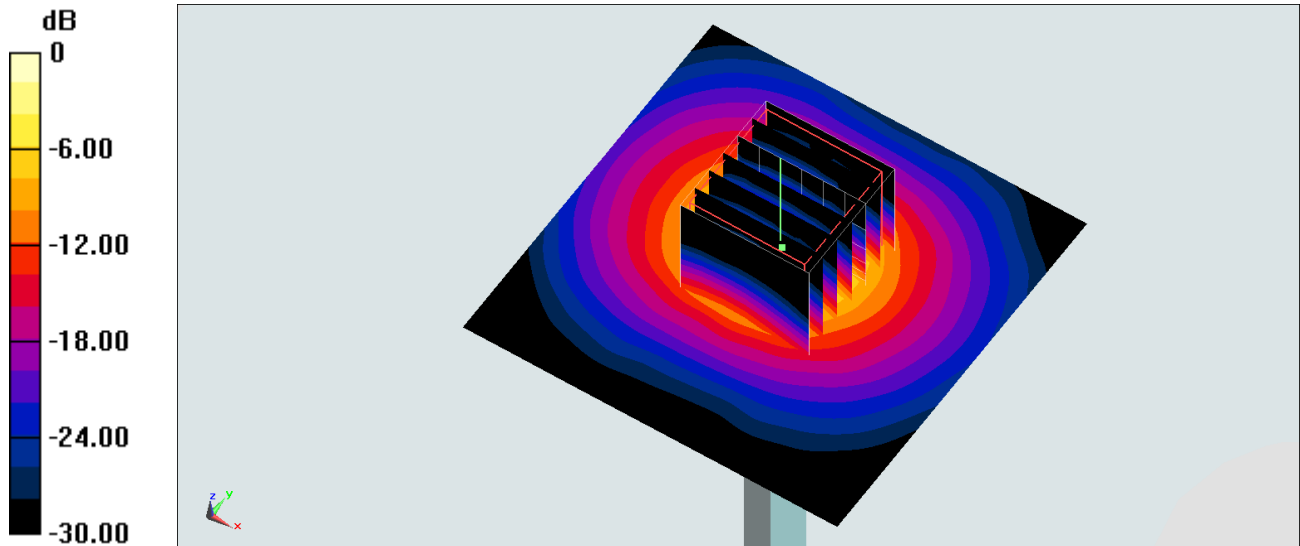

System Check_Body_5600MHz

DUT: D5GHzV2-1128

Communication System: CW; Frequency: 5600 MHz; Duty Cycle: 1:1

Medium: MSL_5G_160909 Medium parameters used: $f = 5600$ MHz; $\sigma = 5.926$ S/m; $\epsilon_r = 46.314$; $\rho = 1000$ kg/m³

Ambient Temperature : 23.9 °C ; Liquid Temperature : 22.9 °C

DASY5 Configuration:

- Probe: EX3DV4 - SN3931; ConvF(3.84, 3.84, 3.84); Calibrated: 2015/10/1;
- Sensor-Surface: 1.4mm (Mechanical Surface Detection)
- Electronics: DAE3 Sn577; Calibrated: 2015/9/24
- Phantom: SAM_Right; Type: QD000P40CD; Serial: TP:1383
- Measurement SW: DASY52, Version 52.8 (8); SEMCAD X Version 14.6.10 (7331)

Pin=100mW/Area Scan (71x71x1): Interpolated grid: dx=1.000 mm, dy=1.000 mm

Maximum value of SAR (interpolated) = 23.4 W/kg

Pin=100mW/Zoom Scan (7x7x7)/Cube 0: Measurement grid: dx=4mm, dy=4mm, dz=1.4mm

Reference Value = 71.92 V/m; Power Drift = -0.18 dB

Peak SAR (extrapolated) = 36.1 W/kg

SAR(1 g) = 8.28 W/kg; SAR(10 g) = 2.25 W/kg

Maximum value of SAR (measured) = 21.0 W/kg

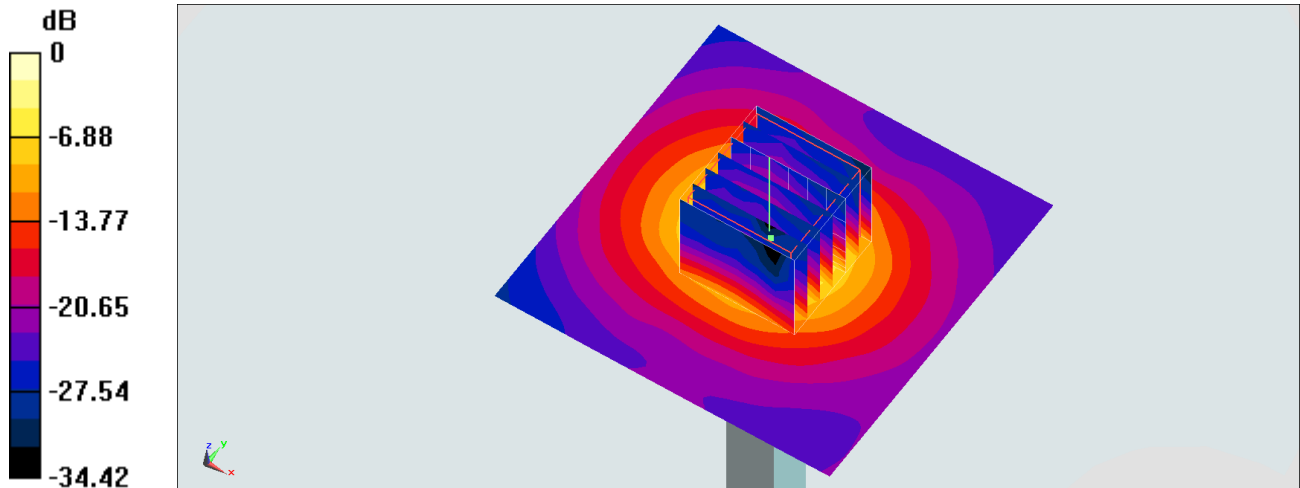

0 dB = 21.0 W/kg = 13.22 dBW/kg

System Check_Body_5600MHz

DUT: D5GHzV2-1128

Communication System: CW; Frequency: 5600 MHz; Duty Cycle: 1:1

Medium: MSL_5G_160912 Medium parameters used: $f = 5600$ MHz; $\sigma = 5.931$ S/m; $\epsilon_r = 46.232$; $\rho = 1000$ kg/m³

Ambient Temperature : 23.5 °C; Liquid Temperature : 22.5 °C

DASY5 Configuration:

- Probe: EX3DV4 - SN3931; ConvF(3.84, 3.84, 3.84); Calibrated: 2015/10/1;
- Sensor-Surface: 1.4mm (Mechanical Surface Detection)
- Electronics: DAE3 Sn577; Calibrated: 2015/9/24
- Phantom: SAM-Right; Type: SAM; Serial: 1795
- Measurement SW: DASY52, Version 52.8 (8); SEMCAD X Version 14.6.10 (7373)

Pin=100mW/Area Scan (71x71x1): Interpolated grid: dx=1.000 mm, dy=1.000 mm

Maximum value of SAR (interpolated) = 23.4 W/kg

Pin=100mW/Zoom Scan (7x7x7)/Cube 0: Measurement grid: dx=4mm, dy=4mm, dz=1.4mm

Reference Value = 71.92 V/m; Power Drift = -0.18 dB

Peak SAR (extrapolated) = 36.1 W/kg

SAR(1 g) = 8.29 W/kg; SAR(10 g) = 2.26 W/kg

Maximum value of SAR (measured) = 21.0 W/kg

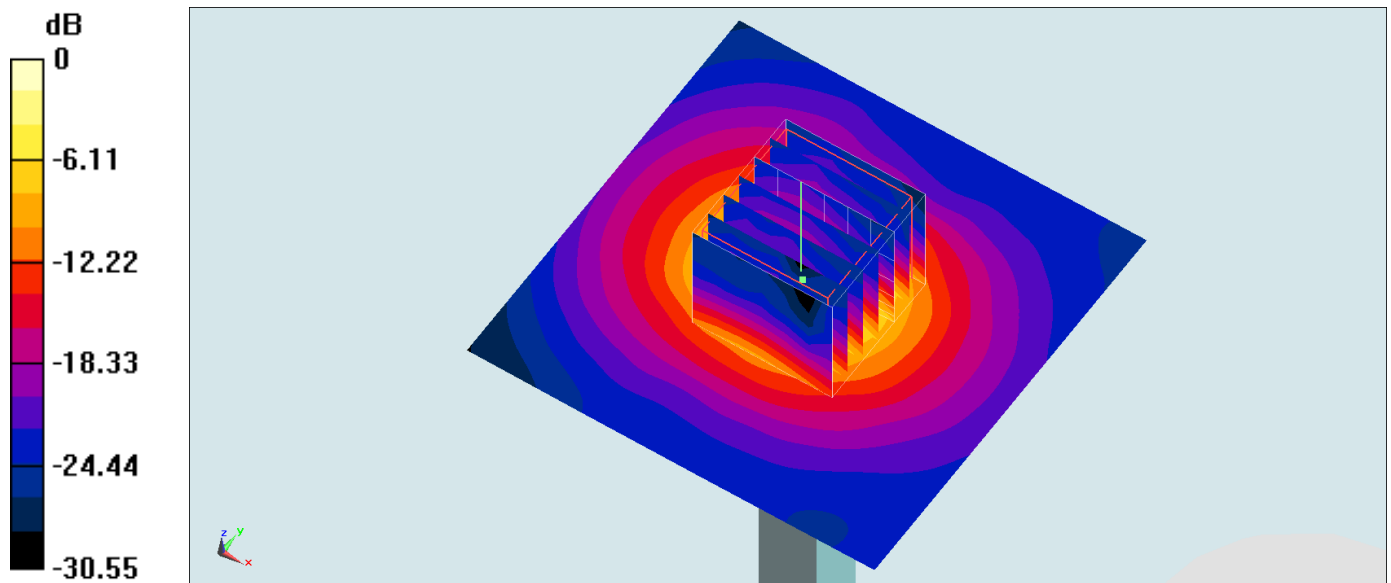

0 dB = 23.4 W/kg = 13.69 dBW/kg

System Check_Body_5750MHz

DUT: D5GHzV2-1128

Communication System: CW; Frequency: 5750 MHz; Duty Cycle: 1:1

Medium: MSL_5G_160912 Medium parameters used: $f = 5750$ MHz; $\sigma = 6.129$ S/m; $\epsilon_r = 45.969$; $\rho = 1000$ kg/m³

Ambient Temperature : 23.5 °C; Liquid Temperature : 22.5 °C

DASY5 Configuration:

- Probe: EX3DV4 - SN3931; ConvF(3.98, 3.98, 3.98); Calibrated: 2015/10/1;
- Sensor-Surface: 1.4mm (Mechanical Surface Detection)
- Electronics: DAE3 Sn577; Calibrated: 2015/9/24
- Phantom: SAM-Right; Type: SAM; Serial: 1795
- Measurement SW: DASY52, Version 52.8 (8); SEMCAD X Version 14.6.10 (7373)

Pin=100mW/Area Scan (71x71x1): Interpolated grid: dx=1.000 mm, dy=1.000 mm

Maximum value of SAR (interpolated) = 18.3 W/kg

Pin=100mW/Zoom Scan (7x7x7)/Cube 0: Measurement grid: dx=4mm, dy=4mm, dz=1.4mm

Reference Value = 64.76 V/m; Power Drift = -0.04 dB

Peak SAR (extrapolated) = 32.6 W/kg

SAR(1 g) = 7.37 W/kg; SAR(10 g) = 2.05 W/kg

Maximum value of SAR (measured) = 18.9 W/kg

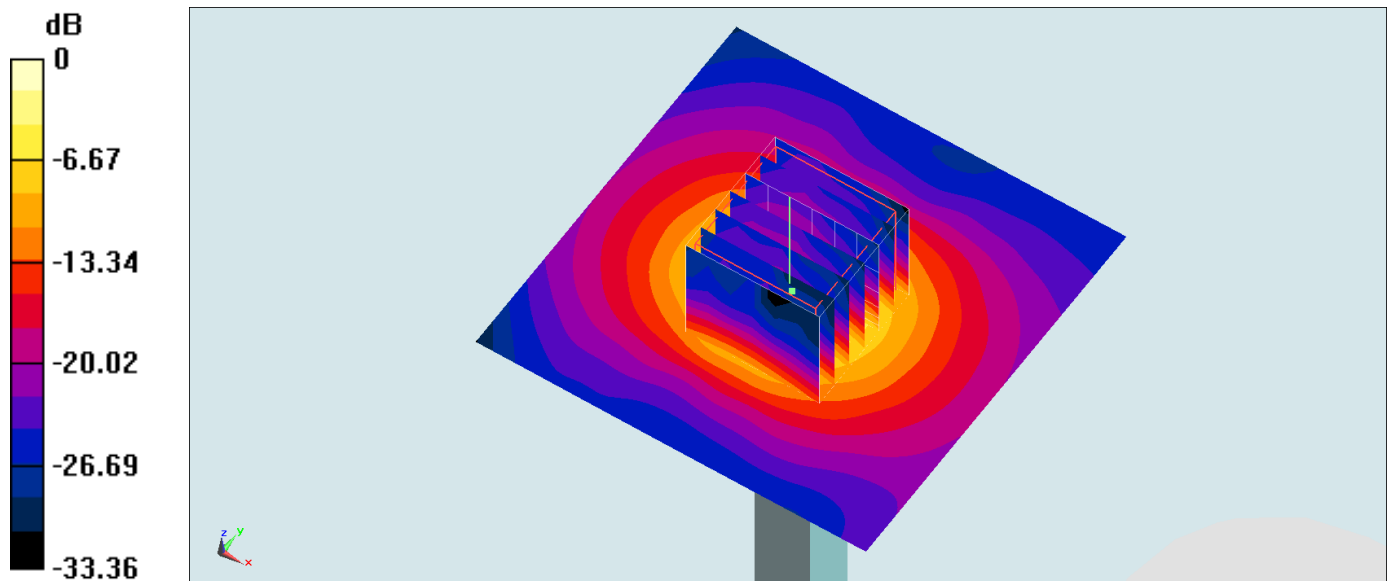

0 dB = 18.3 W/kg = 12.62 dBW/kg

System Check_Head_5800MHz

DUT: D5GHzV2-1006

Communication System: CW; Frequency: 5800 MHz; Duty Cycle: 1:1

Medium: HSL_5G_160911 Medium parameters used: $f = 5800$ MHz; $\sigma = 5.046$ S/m; $\epsilon_r = 34.865$; $\rho = 1000$ kg/m³

Ambient Temperature : 23.5 °C; Liquid Temperature : 22.5 °C

DASY5 Configuration:

- Probe: EX3DV4 - SN3925; ConvF(4.51, 4.51, 4.51); Calibrated: 2016/5/26;
- Sensor-Surface: 1.4mm (Mechanical Surface Detection)
- Electronics: DAE3 Sn495; Calibrated: 2016/5/27
- Phantom: SAM-Right; Type: SAM; Serial: 1795
- Measurement SW: DASY52, Version 52.8 (8); SEMCAD X Version 14.6.10 (7373)

Pin=100mW/Area Scan (71x71x1): Interpolated grid: dx=1.000 mm, dy=1.000 mm

Maximum value of SAR (interpolated) = 16.1 W/kg

Pin=100mW/Zoom Scan (7x7x7)/Cube 0: Measurement grid: dx=4mm, dy=4mm, dz=1.4mm

Reference Value = 65.88 V/m; Power Drift = 0.14 dB

Peak SAR (extrapolated) = 33.0 W/kg

SAR(1 g) = 7.92 W/kg; SAR(10 g) = 2.19 W/kg

Maximum value of SAR (measured) = 20.2 W/kg

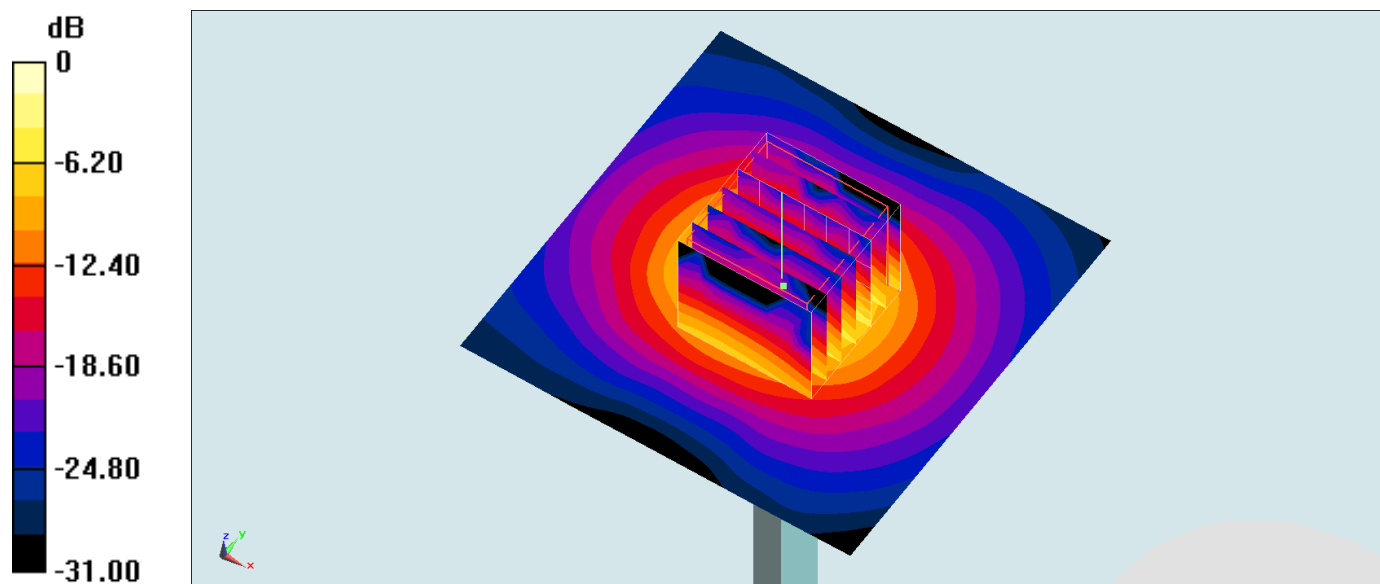

0 dB = 16.1 W/kg = 12.07 dBW/kg



Appendix B. Plots of SAR Measurement

The plots are shown as follows.

#01_GSM850_GPRS (4 Tx slots)_Right Cheek_Ch251

Communication System: GSM850; Frequency: 848.8 MHz; Duty Cycle: 1:2.08

Medium: HSL_850_160910 Medium parameters used: $f = 849$ MHz; $\sigma = 0.91$ S/m; $\epsilon_r = 42.362$; $\rho = 1000$ kg/m³

Ambient Temperature : 23.6 °C ; Liquid Temperature : 22.6 °C

DASY5 Configuration:

- Probe: ES3DV3 - SN3270; ConvF(6.03, 6.03, 6.03); Calibrated: 2016/8/26;
- Sensor-Surface: 3mm (Mechanical Surface Detection)
- Electronics: DAE4 Sn1399; Calibrated: 2015/11/23
- Phantom: SAM-Right; Type: SAM; Serial: 1795
- Measurement SW: DASY52, Version 52.8 (8); SEMCAD X Version 14.6.10 (7373)

Area Scan (71x131x1): Interpolated grid: dx=1.500 mm, dy=1.500 mm

Maximum value of SAR (interpolated) = 0.900 W/kg

Zoom Scan (5x5x7)/Cube 0: Measurement grid: dx=8mm, dy=8mm, dz=5mm

Reference Value = 29.05 V/m; Power Drift = 0.12 dB

Peak SAR (extrapolated) = 1.62 W/kg

SAR(1 g) = 0.785 W/kg; SAR(10 g) = 0.599 W/kg

Maximum value of SAR (measured) = 0.980 W/kg

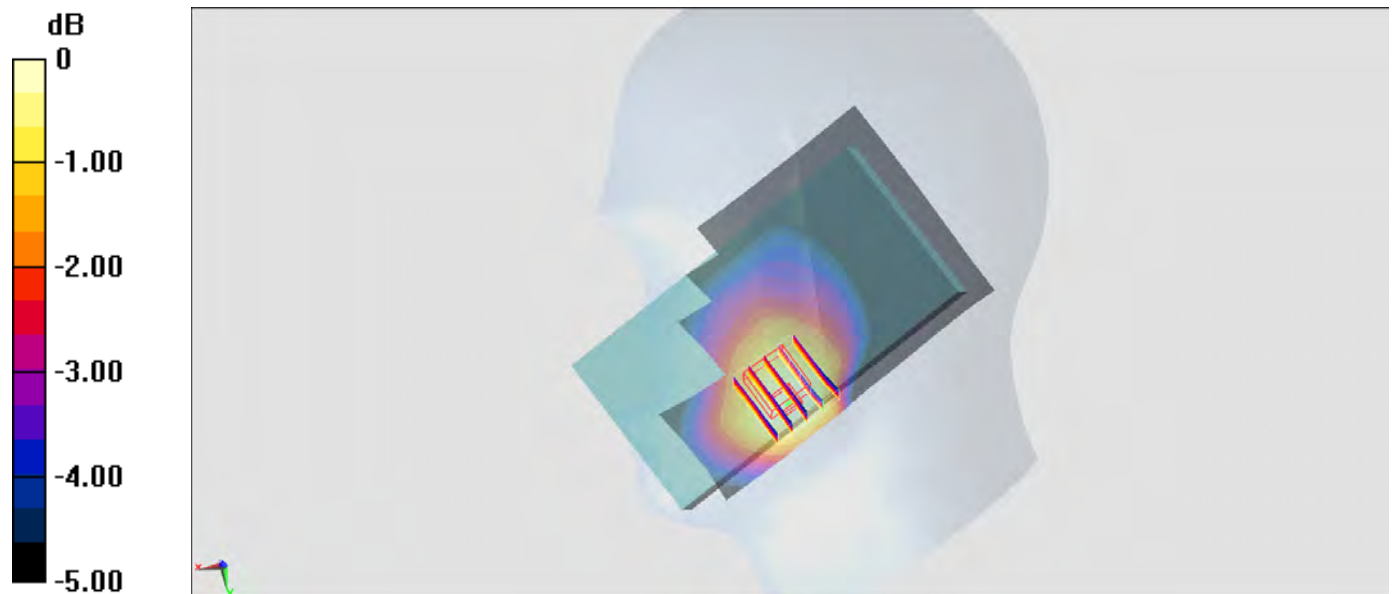

0 dB = 0.900 W/kg = -0.46 dBW/kg

#02_GSM1900_GPRS (3 Tx slots)_Left Cheek_Ch810

Communication System: PCS; Frequency: 1909.8 MHz; Duty Cycle: 1:2.77

Medium: HSL_1900_160911 Medium parameters used: $f = 1910$ MHz; $\sigma = 1.406$ S/m; $\epsilon_r = 40.513$; $\rho = 1000$ kg/m³

Ambient Temperature : 23.2 °C; Liquid Temperature : 22.2 °C

DASY5 Configuration:

- Probe: ES3DV3 - SN3270; ConvF(5.08, 5.08, 5.08); Calibrated: 2016/8/26;
- Sensor-Surface: 3mm (Mechanical Surface Detection)
- Electronics: DAE4 Sn1399; Calibrated: 2015/11/23
- Phantom: SAM_Left; Type: QD000P40CD; Serial: TP:1644
- Measurement SW: DASY52, Version 52.8 (8); SEMCAD X Version 14.6.10 (7373)

Area Scan (71x121x1): Interpolated grid: dx=1.500 mm, dy=1.500 mm

Maximum value of SAR (interpolated) = 0.246 W/kg

Zoom Scan (5x5x7)/Cube 0: Measurement grid: dx=8mm, dy=8mm, dz=5mm

Reference Value = 13.00 V/m; Power Drift = -0.01 dB

Peak SAR (extrapolated) = 0.319 W/kg

SAR(1 g) = 0.206 W/kg; SAR(10 g) = 0.131 W/kg

Maximum value of SAR (measured) = 0.246 W/kg

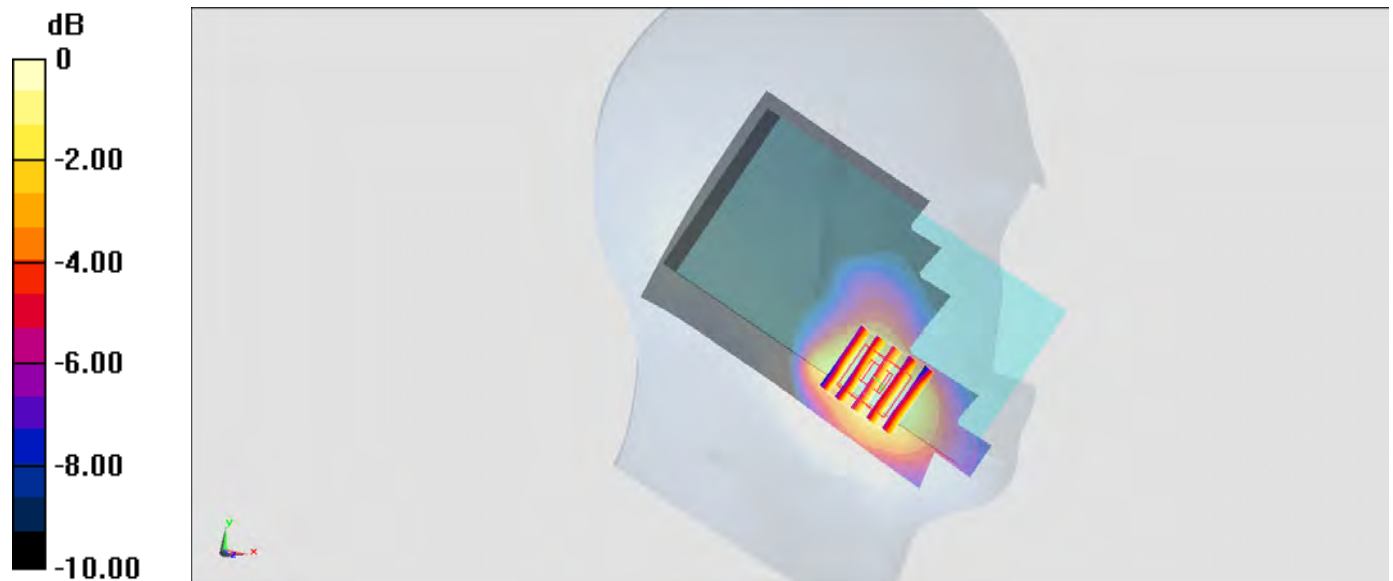

0 dB = 0.246 W/kg = -6.09 dBW/kg

#03_WCDMA II_RMC 12.2Kbps_Left Cheek_Ch9538

Communication System: WCDMA ; Frequency: 1907.6 MHz; Duty Cycle: 1:1

Medium: HSL_1900_160911 Medium parameters used: $f = 1908$ MHz; $\sigma = 1.404$ S/m; $\epsilon_r = 40.52$; $\rho = 1000$ kg/m³

Ambient Temperature : 23.2 °C; Liquid Temperature : 22.2 °C

DASY5 Configuration:

- Probe: ES3DV3 - SN3270; ConvF(5.08, 5.08, 5.08); Calibrated: 2016/8/26;
- Sensor-Surface: 3mm (Mechanical Surface Detection)
- Electronics: DAE4 Sn1399; Calibrated: 2015/11/23
- Phantom: SAM_Left; Type: QD000P40CD; Serial: TP:1644
- Measurement SW: DASY52, Version 52.8 (8); SEMCAD X Version 14.6.10 (7373)

Area Scan (71x121x1): Interpolated grid: dx=1.500 mm, dy=1.500 mm

Maximum value of SAR (interpolated) = 0.211 W/kg

Zoom Scan (5x5x7)/Cube 0: Measurement grid: dx=8mm, dy=8mm, dz=5mm

Reference Value = 11.70 V/m; Power Drift = 0.10 dB

Peak SAR (extrapolated) = 0.304 W/kg

SAR(1 g) = 0.191 W/kg; SAR(10 g) = 0.117 W/kg

Maximum value of SAR (measured) = 0.218 W/kg

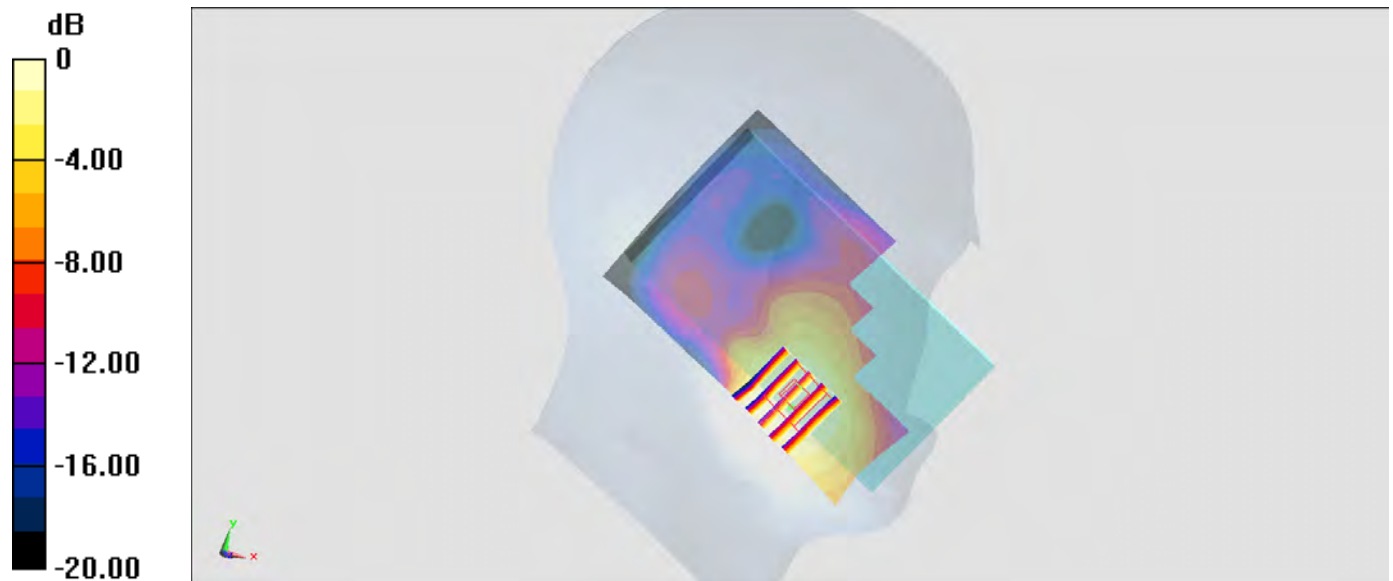

0 dB = 0.211 W/kg = -6.76 dBW/kg

#04_WCDMA IV_RMC 12.2Kbps_Left Cheek_Ch1513

Communication System: WCDMA ; Frequency: 1752.6 MHz; Duty Cycle: 1:1

Medium: HSL_1750_160911 Medium parameters used: $f = 1753$ MHz; $\sigma = 1.374$ S/m; $\epsilon_r = 39.993$; $\rho = 1000$ kg/m³

Ambient Temperature : 23.2 °C ; Liquid Temperature : 22.2 °C

DASY5 Configuration:

- Probe: ES3DV3 - SN3270; ConvF(5.21, 5.21, 5.21); Calibrated: 2016/8/26;
- Sensor-Surface: 3mm (Mechanical Surface Detection)
- Electronics: DAE4 Sn1399; Calibrated: 2015/11/23
- Phantom: SAM_Left; Type: QD000P40CD; Serial: TP:1644
- Measurement SW: DASY52, Version 52.8 (8); SEMCAD X Version 14.6.10 (7373)

Area Scan (71x121x1): Interpolated grid: dx=1.500 mm, dy=1.500 mm

Maximum value of SAR (interpolated) = 0.212 W/kg

Zoom Scan (5x5x7)/Cube 0: Measurement grid: dx=8mm, dy=8mm, dz=5mm

Reference Value = 11.95 V/m; Power Drift = 0.06 dB

Peak SAR (extrapolated) = 0.342 W/kg

SAR(1 g) = 0.203 W/kg; SAR(10 g) = 0.130 W/kg

Maximum value of SAR (measured) = 0.241 W/kg

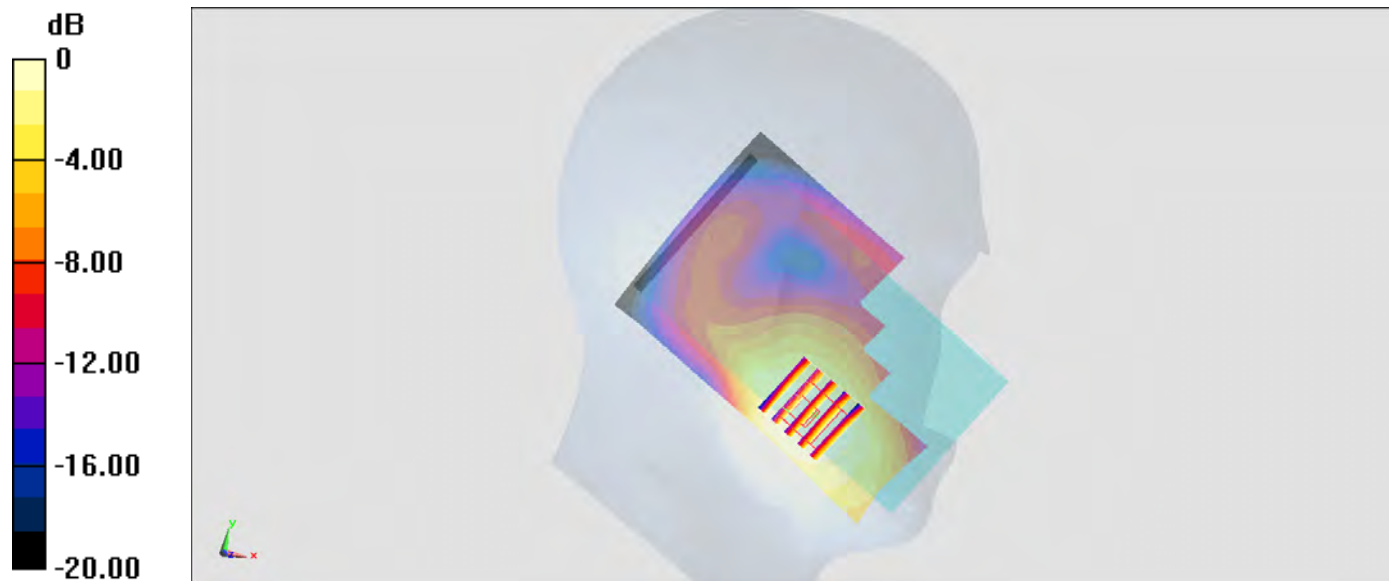

0 dB = 0.212 W/kg = -6.74 dBW/kg

#05_WCDMA V_RMC 12.2Kbps_Right Cheek_Ch4233

Communication System: WCDMA ; Frequency: 846.6 MHz; Duty Cycle: 1:1

Medium: HSL_850_160910 Medium parameters used: $f = 847$ MHz; $\sigma = 0.908$ S/m; $\epsilon_r = 42.387$; $\rho = 1000$ kg/m³

Ambient Temperature : 23.6 °C ; Liquid Temperature : 22.6 °C

DASY5 Configuration:

- Probe: ES3DV3 - SN3270; ConvF(6.03, 6.03, 6.03); Calibrated: 2016/8/26;
- Sensor-Surface: 3mm (Mechanical Surface Detection)
- Electronics: DAE4 Sn1399; Calibrated: 2015/11/23
- Phantom: SAM-Right; Type: SAM; Serial: 1795
- Measurement SW: DASY52, Version 52.8 (8); SEMCAD X Version 14.6.10 (7373)

Area Scan (71x121x1): Interpolated grid: dx=1.500 mm, dy=1.500 mm

Maximum value of SAR (interpolated) = 0.366 W/kg

Zoom Scan (5x5x7)/Cube 0: Measurement grid: dx=8mm, dy=8mm, dz=5mm

Reference Value = 18.93 V/m; Power Drift = -0.10 dB

Peak SAR (extrapolated) = 0.624 W/kg

SAR(1 g) = 0.303 W/kg; SAR(10 g) = 0.228 W/kg

Maximum value of SAR (measured) = 0.360 W/kg

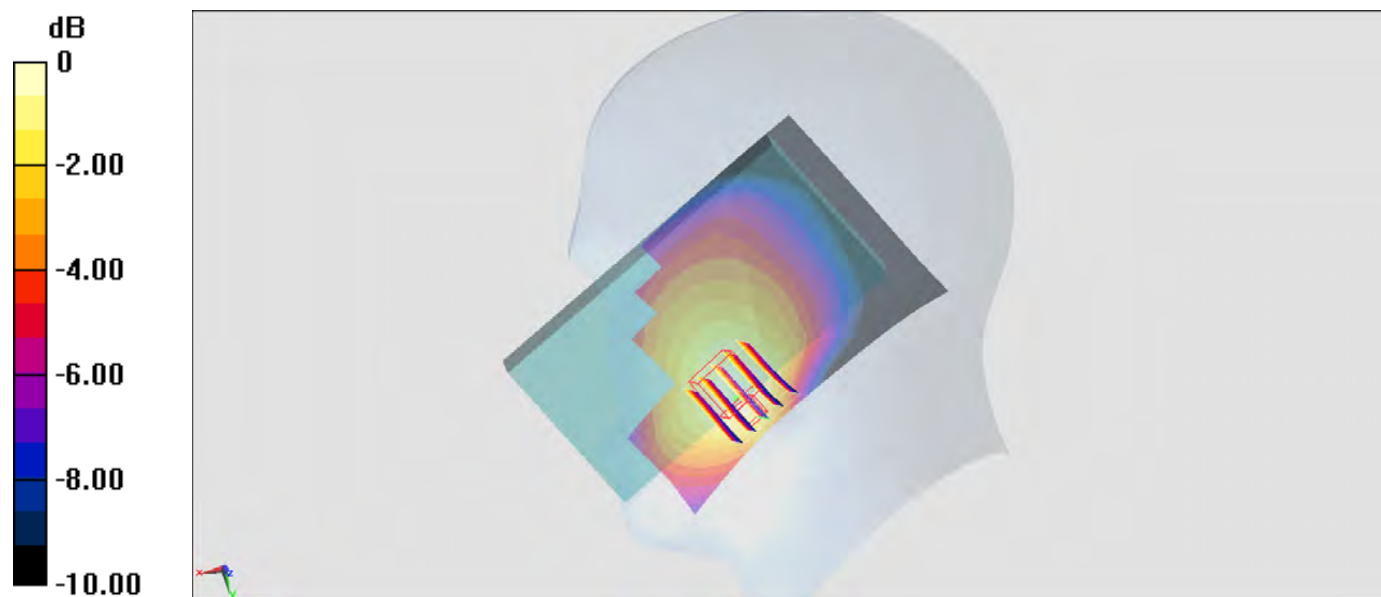

0 dB = 0.366 W/kg = -4.37 dBW/kg

#06_CDMA BC0_1xRTT RC1 SO55_Right Cheek_Ch777

Communication System: CDMA ; Frequency: 848.31 MHz; Duty Cycle: 1:1

Medium: HSL_850_160910 Medium parameters used: $f = 848.31$ MHz; $\sigma = 0.909$ S/m; $\epsilon_r = 42.37$; $\rho = 1000$ kg/m³

Ambient Temperature : 23.6 °C ; Liquid Temperature : 22.6 °C

DASY5 Configuration:

- Probe: ES3DV3 - SN3270; ConvF(6.03, 6.03, 6.03); Calibrated: 2016/8/26;
- Sensor-Surface: 3mm (Mechanical Surface Detection)
- Electronics: DAE4 Sn1399; Calibrated: 2015/11/23
- Phantom: SAM-Right; Type: SAM; Serial: 1795
- Measurement SW: DASY52, Version 52.8 (8); SEMCAD X Version 14.6.10 (7373)

Area Scan (71x121x1): Interpolated grid: dx=1.500 mm, dy=1.500 mm

Maximum value of SAR (interpolated) = 0.392 W/kg

Zoom Scan (6x6x7)/Cube 0: Measurement grid: dx=8mm, dy=8mm, dz=5mm

Reference Value = 19.35 V/m; Power Drift = 0.08 dB

Peak SAR (extrapolated) = 0.600 W/kg

SAR(1 g) = 0.333 W/kg; SAR(10 g) = 0.252 W/kg

Maximum value of SAR (measured) = 0.403 W/kg

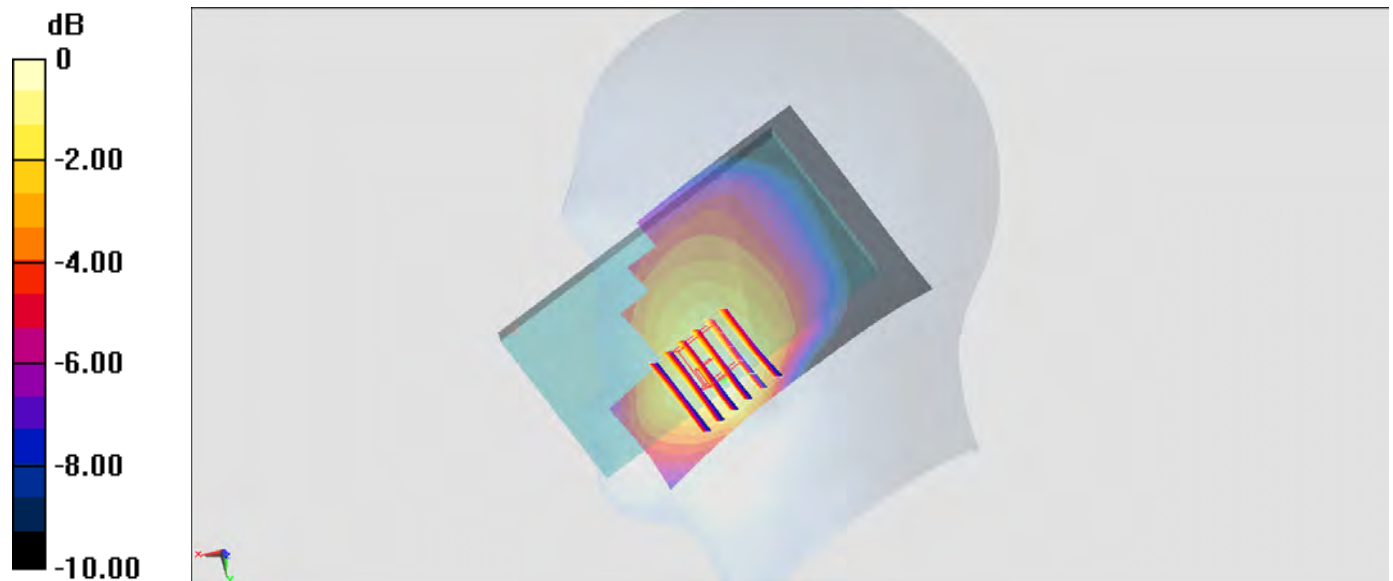

0 dB = 0.392 W/kg = -4.07 dBW/kg

#07_CDMA BC1_1xRTT RC1 SO55_Left Cheek_Ch1175

Communication System: CDMA ; Frequency: 1908.75 MHz;Duty Cycle: 1:1

Medium: HSL_1900_160911 Medium parameters used: $f = 1909$ MHz; $\sigma = 1.405$ S/m; $\epsilon_r = 40.516$; $\rho = 1000$ kg/m³

Ambient Temperature : 23.2 °C; Liquid Temperature : 22.2 °C

DASY5 Configuration:

- Probe: ES3DV3 - SN3270; ConvF(5.08, 5.08, 5.08); Calibrated: 2016/8/26;
- Sensor-Surface: 3mm (Mechanical Surface Detection)
- Electronics: DAE4 Sn1399; Calibrated: 2015/11/23
- Phantom: SAM_Left; Type: QD000P40CD; Serial: TP:1644
- Measurement SW: DASY52, Version 52.8 (8);SEMCAD X Version 14.6.10 (7373)

Area Scan (71x121x1): Interpolated grid: dx=1.500 mm, dy=1.500 mm

Maximum value of SAR (interpolated) = 0.211 W/kg

Zoom Scan (6x5x7)/Cube 0: Measurement grid: dx=8mm, dy=8mm, dz=5mm

Reference Value = 11.72 V/m; Power Drift = 0.15 dB

Peak SAR (extrapolated) = 0.299 W/kg

SAR(1 g) = 0.190 W/kg; SAR(10 g) = 0.115 W/kg

Maximum value of SAR (measured) = 0.223 W/kg

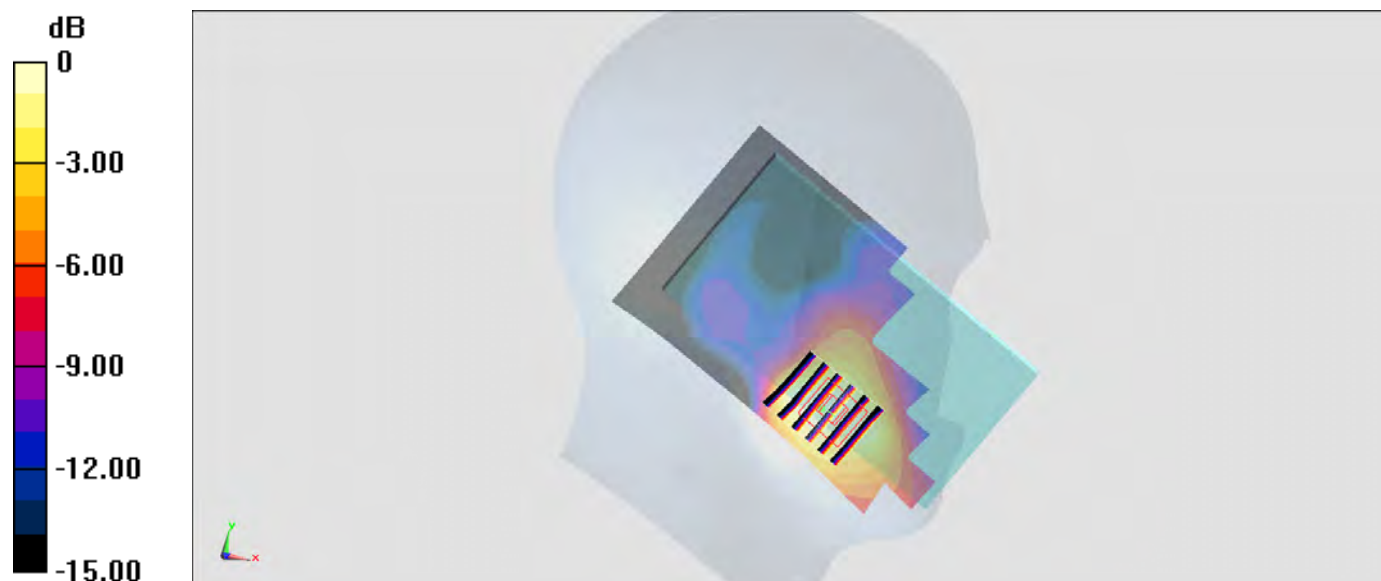

0 dB = 0.211 W/kg = -6.76 dBW/kg

#08_CDMA BC10_1xRTT RC1 SO55_Right Cheek_Ch684

Communication System: CDMA ; Frequency: 823.1 MHz; Duty Cycle: 1:1

Medium: HSL_850_160910 Medium parameters used: $f = 823.1$ MHz; $\sigma = 0.884$ S/m; $\epsilon_r = 42.699$; $\rho = 1000$ kg/m³

Ambient Temperature : 23.6 °C ; Liquid Temperature : 22.6 °C

DASY5 Configuration:

- Probe: ES3DV3 - SN3270; ConvF(6.03, 6.03, 6.03); Calibrated: 2016/8/26;
- Sensor-Surface: 3mm (Mechanical Surface Detection)
- Electronics: DAE4 Sn1399; Calibrated: 2015/11/23
- Phantom: SAM-Right; Type: SAM; Serial: 1795
- Measurement SW: DASY52, Version 52.8 (8); SEMCAD X Version 14.6.10 (7373)

Area Scan (71x121x1): Interpolated grid: dx=1.500 mm, dy=1.500 mm

Maximum value of SAR (interpolated) = 0.310 W/kg

Zoom Scan (6x6x7)/Cube 0: Measurement grid: dx=8mm, dy=8mm, dz=5mm

Reference Value = 17.18 V/m; Power Drift = 0.10 dB

Peak SAR (extrapolated) = 0.424 W/kg

SAR(1 g) = 0.269 W/kg; SAR(10 g) = 0.208 W/kg

Maximum value of SAR (measured) = 0.301 W/kg

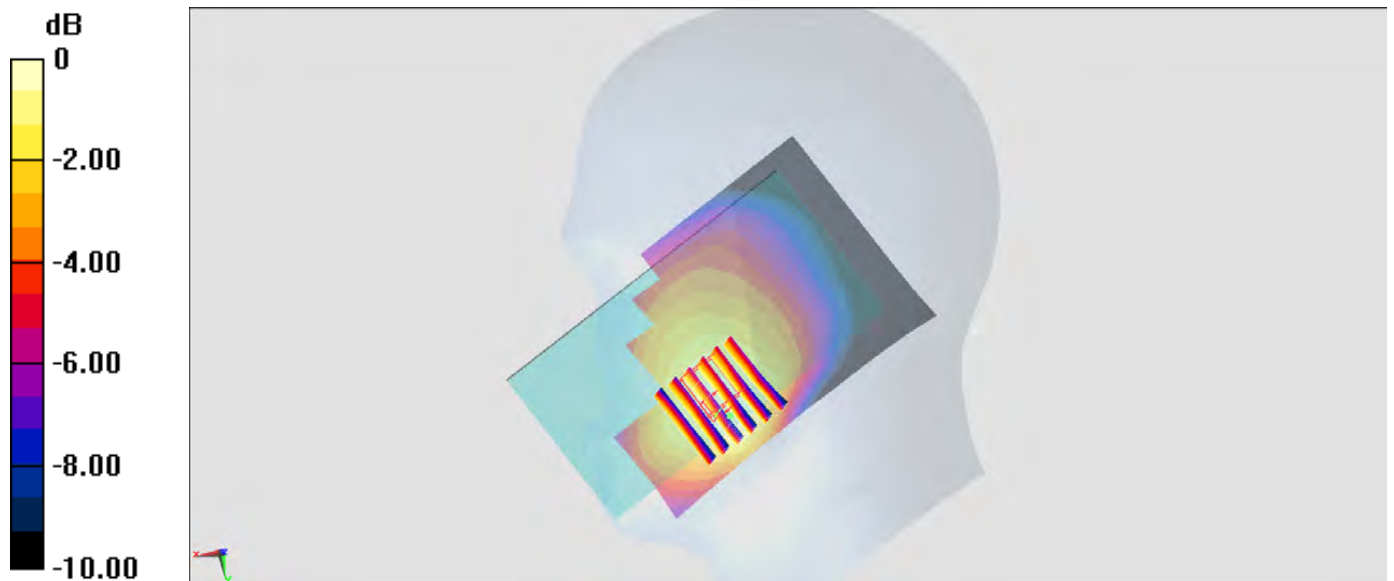

0 dB = 0.310 W/kg = -5.09 dBW/kg

#09_LTE Band 4_20M_QPSK_1_0_Left Cheek_Ch20175

Communication System: LTE; Frequency: 1732.5 MHz; Duty Cycle: 1:1

Medium: HSL_1750_160911 Medium parameters used : $f = 1732.5$ MHz; $\sigma = 1.355$ S/m; $\epsilon_r = 40.077$;

$\rho = 1000$ kg/m³

Ambient Temperature : 23.2 °C; Liquid Temperature : 22.2 °C

DASY5 Configuration:

- Probe: ES3DV3 - SN3270; ConvF(5.21, 5.21, 5.21); Calibrated: 2016/8/26;
- Sensor-Surface: 3mm (Mechanical Surface Detection)
- Electronics: DAE4 Sn1399; Calibrated: 2015/11/23
- Phantom: SAM_Left; Type: QD000P40CD; Serial: TP:1644
- Measurement SW: DASY52, Version 52.8 (8); SEMCAD X Version 14.6.10 (7373)

Area Scan (71x121x1): Interpolated grid: dx=1.500 mm, dy=1.500 mm

Maximum value of SAR (interpolated) = 0.188 W/kg

Zoom Scan (5x5x7)/Cube 0: Measurement grid: dx=8mm, dy=8mm, dz=5mm

Reference Value = 12.29 V/m; Power Drift = -0.05 dB

Peak SAR (extrapolated) = 0.267 W/kg

SAR(1 g) = 0.173 W/kg; SAR(10 g) = 0.114 W/kg

Maximum value of SAR (measured) = 0.204 W/kg

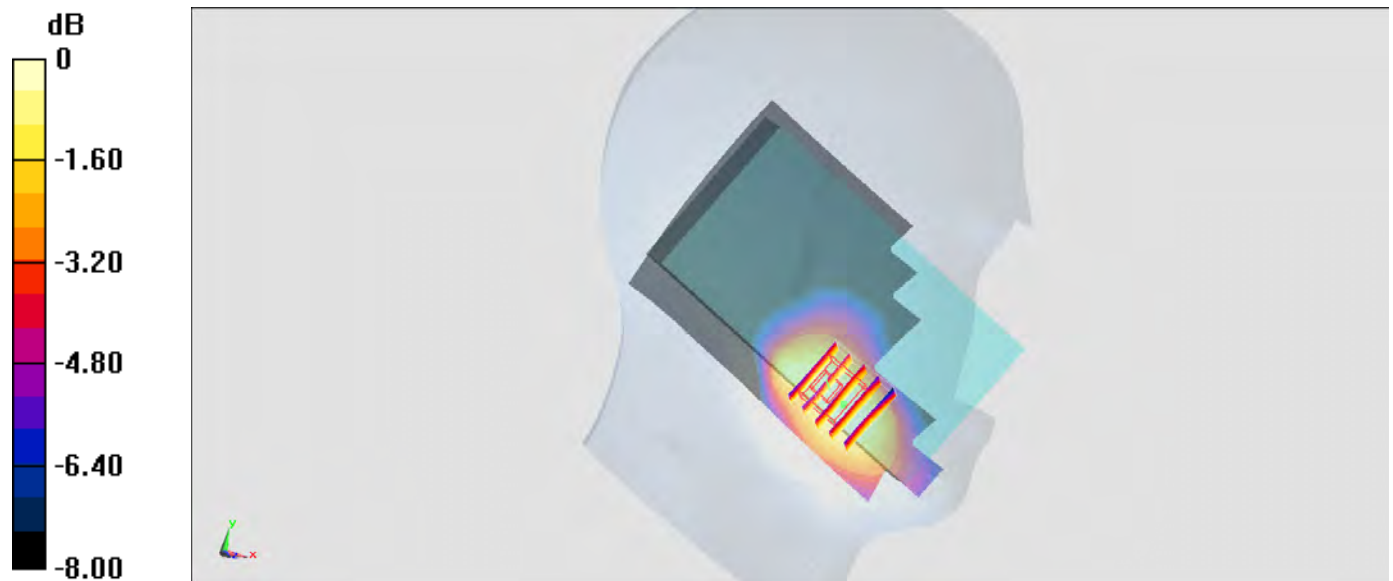

0 dB = 0.188 W/kg = -7.26 dBW/kg

#10_LTE Band 12_10M_QPSK_1_0_Right Cheek_Ch23095

Communication System: LTE; Frequency: 707.5 MHz; Duty Cycle: 1:1

Medium: HSL_750_160909 Medium parameters used : $f = 707.5$ MHz; $\sigma = 0.86$ S/m; $\epsilon_r = 44.111$; $\rho = 1000$ kg/m³

Ambient Temperature : 23.5 °C; Liquid Temperature : 22.5 °C

DASY5 Configuration:

- Probe: ES3DV3 - SN3270; ConvF(6.19, 6.19, 6.19); Calibrated: 2016/8/26;
- Sensor-Surface: 3mm (Mechanical Surface Detection)
- Electronics: DAE4 Sn1399; Calibrated: 2015/11/23
- Phantom: SAM-Right; Type: SAM; Serial: 1795
- Measurement SW: DASY52, Version 52.8 (8); SEMCAD X Version 14.6.10 (7373)

Area Scan (71x131x1): Interpolated grid: dx=1.500 mm, dy=1.500 mm

Maximum value of SAR (interpolated) = 0.262 W/kg

Zoom Scan (5x5x7)/Cube 0: Measurement grid: dx=8mm, dy=8mm, dz=5mm

Reference Value = 16.74 V/m; Power Drift = -0.05 dB

Peak SAR (extrapolated) = 0.322 W/kg

SAR(1 g) = 0.235 W/kg; SAR(10 g) = 0.187 W/kg

Maximum value of SAR (measured) = 0.252 W/kg

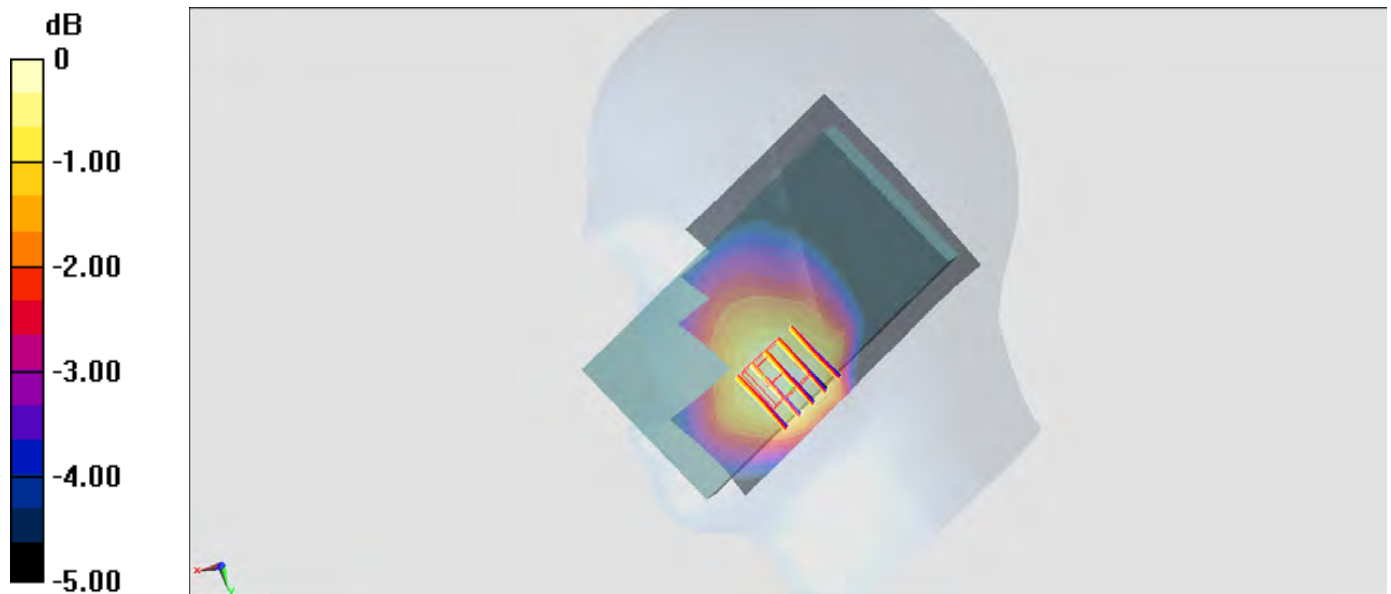

0 dB = 0.262 W/kg = -5.82 dBW/kg

#11_LTE Band 13_10M_QPSK_1_25_Right Cheek_Ch23230

Communication System: LTE; Frequency: 782 MHz; Duty Cycle: 1:1

Medium: HSL_750_160909 Medium parameters used: $f = 782$ MHz; $\sigma = 0.931$ S/m; $\epsilon_r = 43.103$; $\rho = 1000$ kg/m³

Ambient Temperature : 23.5 °C; Liquid Temperature : 22.5 °C

DASY5 Configuration:

- Probe: ES3DV3 - SN3270; ConvF(6.19, 6.19, 6.19); Calibrated: 2016/8/26;
- Sensor-Surface: 3mm (Mechanical Surface Detection)
- Electronics: DAE4 Sn1399; Calibrated: 2015/11/23
- Phantom: SAM-Right; Type: SAM; Serial: 1795
- Measurement SW: DASY52, Version 52.8 (8); SEMCAD X Version 14.6.10 (7373)

Area Scan (71x131x1): Interpolated grid: dx=1.500 mm, dy=1.500 mm

Maximum value of SAR (interpolated) = 0.267 W/kg

Zoom Scan (5x5x7)/Cube 0: Measurement grid: dx=8mm, dy=8mm, dz=5mm

Reference Value = 15.13 V/m; Power Drift = 0.01 dB

Peak SAR (extrapolated) = 0.320 W/kg

SAR(1 g) = 0.225 W/kg; SAR(10 g) = 0.171 W/kg

Maximum value of SAR (measured) = 0.250 W/kg

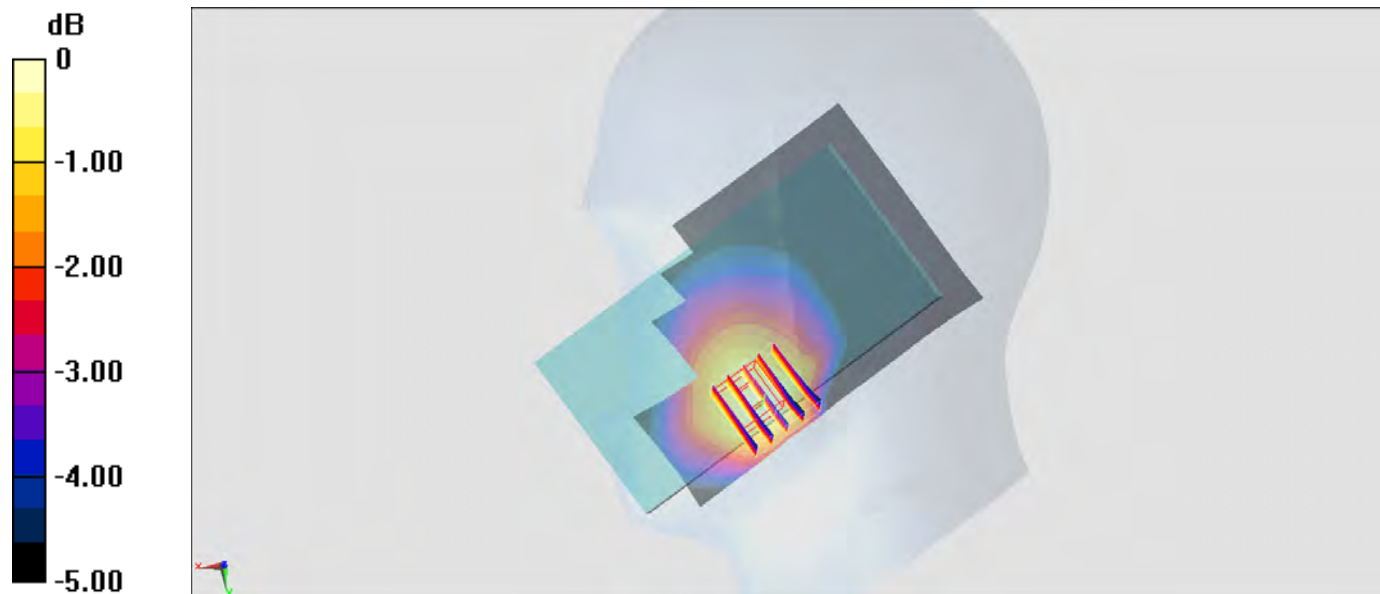

0 dB = 0.267 W/kg = -5.73 dBW/kg

#12_LTE Band 25_20M_QPSK_1_49_Left Cheek_Ch26140

Communication System: LTE; Frequency: 1860 MHz; Duty Cycle: 1:1

Medium: HSL_1900_160911 Medium parameters used: $f = 1860$ MHz; $\sigma = 1.355$ S/m; $\epsilon_r = 40.708$; $\rho = 1000$ kg/m³

Ambient Temperature : 23.2 °C; Liquid Temperature : 22.2 °C

DASY5 Configuration:

- Probe: ES3DV3 - SN3270; ConvF(5.08, 5.08, 5.08); Calibrated: 2016/8/26;
- Sensor-Surface: 3mm (Mechanical Surface Detection)
- Electronics: DAE4 Sn1399; Calibrated: 2015/11/23
- Phantom: SAM_Left; Type: QD000P40CD; Serial: TP:1644
- Measurement SW: DASY52, Version 52.8 (8); SEMCAD X Version 14.6.10 (7373)

Area Scan (71x121x1): Interpolated grid: dx=1.500 mm, dy=1.500 mm

Maximum value of SAR (interpolated) = 0.225 W/kg

Zoom Scan (5x5x7)/Cube 0: Measurement grid: dx=8mm, dy=8mm, dz=5mm

Reference Value = 12.76 V/m; Power Drift = -0.04 dB

Peak SAR (extrapolated) = 0.284 W/kg

SAR(1 g) = 0.184 W/kg; SAR(10 g) = 0.117 W/kg

Maximum value of SAR (measured) = 0.221 W/kg

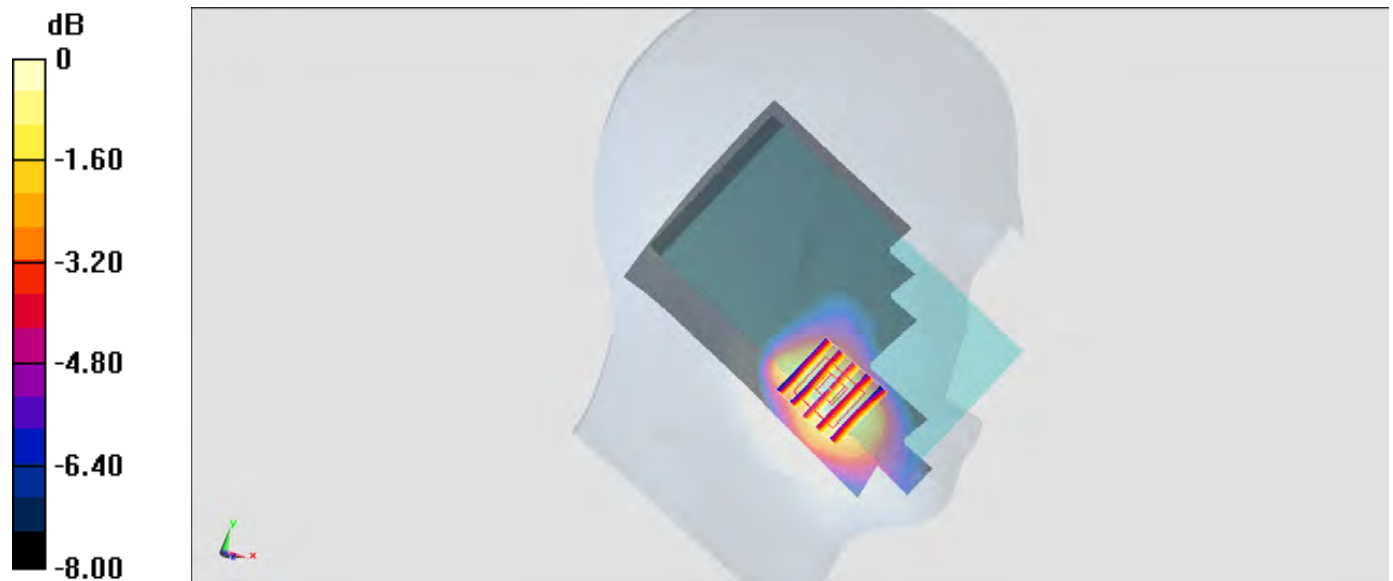

0 dB = 0.225 W/kg = -6.48 dBW/kg

#13_LTE Band 26_15M_QPSK_1_37_Right Cheek_Ch26865

Communication System: LTE ; Frequency: 831.5 MHz;Duty Cycle: 1:1

Medium: HSL_850_160910 Medium parameters used: $f = 831.5$ MHz; $\sigma = 0.892$ S/m; $\epsilon_r = 42.593$; $\rho = 1000$ kg/m³

Ambient Temperature : 23.6 °C ; Liquid Temperature : 22.6 °C

DASY5 Configuration:

- Probe: ES3DV3 - SN3270; ConvF(6.03, 6.03, 6.03); Calibrated: 2016/8/26;
- Sensor-Surface: 3mm (Mechanical Surface Detection)
- Electronics: DAE4 Sn1399; Calibrated: 2015/11/23
- Phantom: SAM-Right; Type: SAM; Serial: 1795
- Measurement SW: DASY52, Version 52.8 (8);SEMCAD X Version 14.6.10 (7373)

Area Scan (71x121x1): Interpolated grid: dx=1.500 mm, dy=1.500 mm

Maximum value of SAR (interpolated) = 0.324 W/kg

Zoom Scan (6x6x7)/Cube 0: Measurement grid: dx=8mm, dy=8mm, dz=5mm

Reference Value = 17.89 V/m; Power Drift = -0.11 dB

Peak SAR (extrapolated) = 0.447 W/kg

SAR(1 g) = 0.264 W/kg; SAR(10 g) = 0.201 W/kg

Maximum value of SAR (measured) = 0.314 W/kg

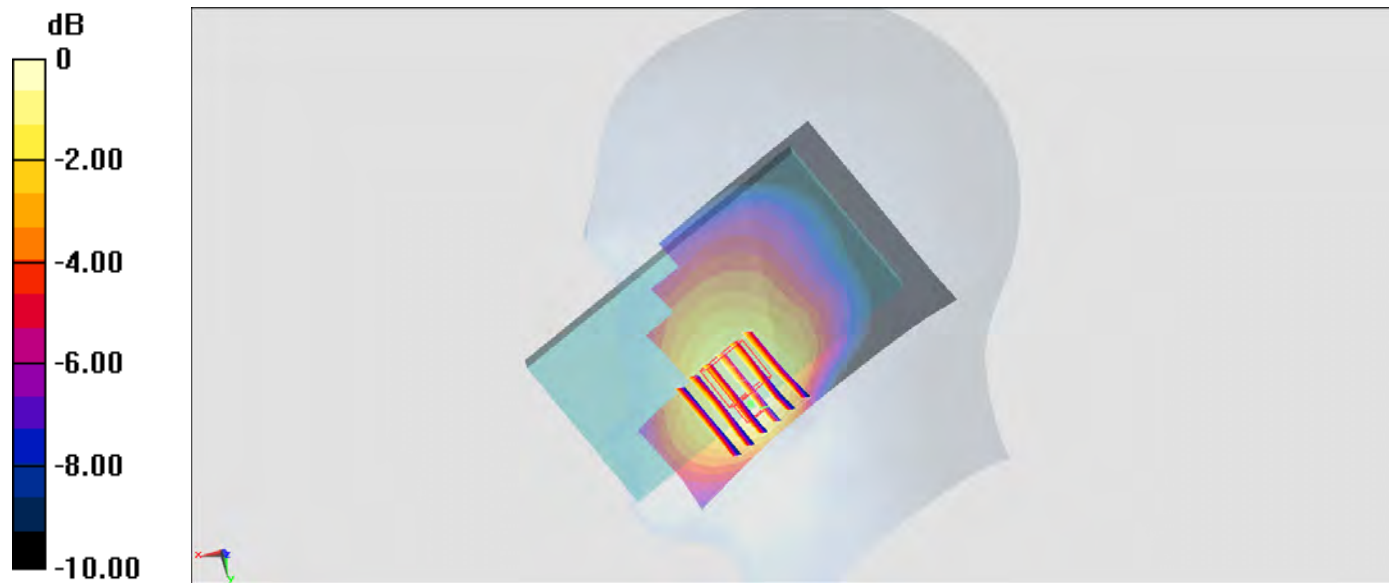

0 dB = 0.324 W/kg = -4.89 dBW/kg

#14_WLAN2.4GHz_802.11b 1Mbps_Left Cheek_Ch11;Ant 2

Communication System: 802.11b ; Frequency: 2462 MHz;Duty Cycle: 1:1.014

Medium: HSL_2450_160908 Medium parameters used: $f = 2462$ MHz; $\sigma = 1.776$ S/m; $\epsilon_r = 40.724$; $\rho = 1000$ kg/m³

Ambient Temperature : 23.6 °C ; Liquid Temperature : 22.6 °C

DASY5 Configuration:

- Probe: EX3DV4 - SN3697; ConvF(6.75, 6.75, 6.75); Calibrated: 2015/9/28;
- Sensor-Surface: 1.4mm (Mechanical Surface Detection)
- Electronics: DAE4 Sn1388; Calibrated: 2015/9/25
- Phantom: SAM_Right; Type: QD000P40CD; Serial: TP:1383
- Measurement SW: DASY52, Version 52.8 (8);SEMCAD X Version 14.6.10 (7331)

Area Scan (81x151x1): Interpolated grid: dx=1.200 mm, dy=1.200 mm

Maximum value of SAR (interpolated) = 0.380 W/kg

Zoom Scan (7x7x7)/Cube 0: Measurement grid: dx=5mm, dy=5mm, dz=5mm

Reference Value = 7.415 V/m; Power Drift = 0.14 dB

Peak SAR (extrapolated) = 0.458 W/kg

SAR(1 g) = 0.246 W/kg; SAR(10 g) = 0.136 W/kg

Maximum value of SAR (measured) = 0.380 W/kg

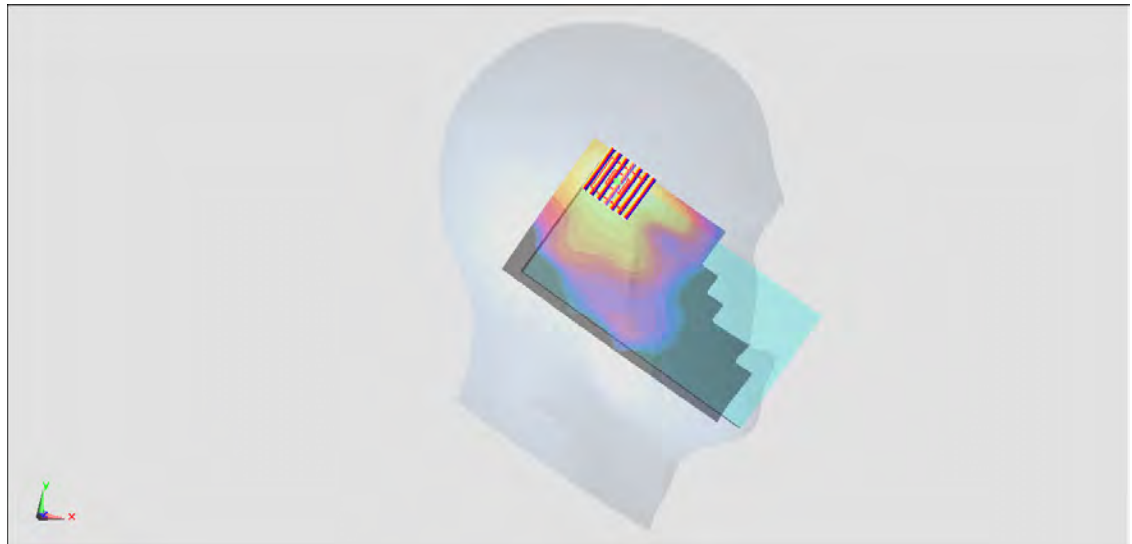
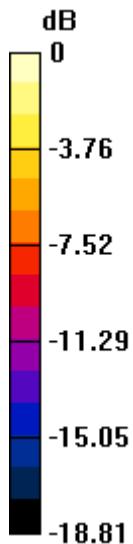

0 dB = 0.380 W/kg = -4.20 dBW/kg

#15_WLAN5GHz_802.11a 6Mbps_Left Cheek_Ch60;Ant 2

Communication System: 802.11a ; Frequency: 5300 MHz;Duty Cycle: 1:1.077

Medium: HSL_5G_160908 Medium parameters used: $f = 5300$ MHz; $\sigma = 4.597$ S/m; $\epsilon_r = 36.154$; $\rho = 1000$ kg/m³

Ambient Temperature : 23.6 °C ; Liquid Temperature : 22.6 °C

DASY5 Configuration:

- Probe: EX3DV4 - SN3925; ConvF(5.15, 5.15, 5.15); Calibrated: 2016/5/26;
- Sensor-Surface: 1.4mm (Mechanical Surface Detection)
- Electronics: DAE3 Sn495; Calibrated: 2016/5/27
- Phantom: SAM_Left; Type: QD 000 P40 CB; Serial: TP-1478
- Measurement SW: DASY52, Version 52.8 (8);SEMCAD X Version 14.6.10 (7331)

Area Scan (101x191x1): Interpolated grid: dx=1.000 mm, dy=1.000 mm

Maximum value of SAR (interpolated) = 0.213 W/kg

Zoom Scan (8x8x7)/Cube 0: Measurement grid: dx=4mm, dy=4mm, dz=1.4mm

Reference Value = 2.004 V/m; Power Drift = -0.12 dB

Peak SAR (extrapolated) = 0.394 W/kg

SAR(1 g) = 0.095 W/kg; SAR(10 g) = 0.039 W/kg

Maximum value of SAR (measured) = 0.214 W/kg

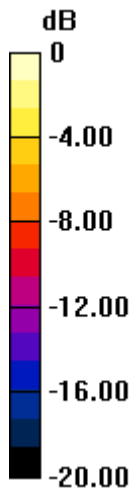

0 dB = 0.214 W/kg = -6.70 dBW/kg

#16_WLAN5GHz_802.11a 6Mbps_Left Cheek_Ch144;Ant 2

Communication System: 802.11a ; Frequency: 5720 MHz;Duty Cycle: 1:1.077

Medium: HSL_5G_160908 Medium parameters used: $f = 5720$ MHz; $\sigma = 5.012$ S/m; $\epsilon_r = 35.599$; $\rho = 1000$ kg/m³

Ambient Temperature : 23.6 °C ; Liquid Temperature : 22.6 °C

DASY5 Configuration:

- Probe: EX3DV4 - SN3925; ConvF(4.51, 4.51, 4.51); Calibrated: 2016/5/26;
- Sensor-Surface: 1.4mm (Mechanical Surface Detection)
- Electronics: DAE3 Sn495; Calibrated: 2016/5/27
- Phantom: SAM_Left; Type: QD 000 P40 CB; Serial: TP-1478
- Measurement SW: DASY52, Version 52.8 (8);SEMCAD X Version 14.6.10 (7331)

Area Scan (111x201x1): Interpolated grid: dx=1.000 mm, dy=1.000 mm

Maximum value of SAR (interpolated) = 0.202 W/kg

Zoom Scan (8x8x7)/Cube 0: Measurement grid: dx=4mm, dy=4mm, dz=1.4mm

Reference Value = 7.238 V/m; Power Drift = -0.13 dB

Peak SAR (extrapolated) = 0.309 W/kg

SAR(1 g) = 0.087 W/kg; SAR(10 g) = 0.036 W/kg

Maximum value of SAR (measured) = 0.198 W/kg

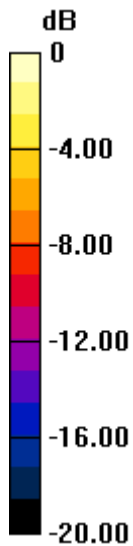

0 dB = 0.198 W/kg = -7.03 dBW/kg

#17_WLAN5GHz_802.11a 6Mbps_Right Cheek_Ch165;Ant 1

Communication System: 802.11a; Frequency: 5825 MHz; Duty Cycle: 1:1.077

Medium: HSL_5G_160911 Medium parameters used: $f = 5825$ MHz; $\sigma = 5.069$ S/m; $\epsilon_r = 34.838$; $\rho = 1000$ kg/m³

Ambient Temperature : 23.5 °C; Liquid Temperature : 22.5 °C

DASY5 Configuration:

- Probe: EX3DV4 - SN3925; ConvF(4.51, 4.51, 4.51); Calibrated: 2016/5/26;
- Sensor-Surface: 1.4mm (Mechanical Surface Detection)
- Electronics: DAE3 Sn495; Calibrated: 2016/5/27
- Phantom: SAM-Right; Type: SAM; Serial: 1795
- Measurement SW: DASY52, Version 52.8 (8); SEMCAD X Version 14.6.10 (7373)

Area Scan (121x201x1): Interpolated grid: dx=1.000 mm, dy=1.000 mm

Maximum value of SAR (interpolated) = 0.430 W/kg

Zoom Scan (8x8x7)/Cube 0: Measurement grid: dx=4mm, dy=4mm, dz=1.4mm

Reference Value = 7.250 V/m; Power Drift = 0.09 dB

Peak SAR (extrapolated) = 0.414 W/kg

SAR(1 g) = 0.103 W/kg; SAR(10 g) = 0.036 W/kg

Maximum value of SAR (measured) = 0.266 W/kg

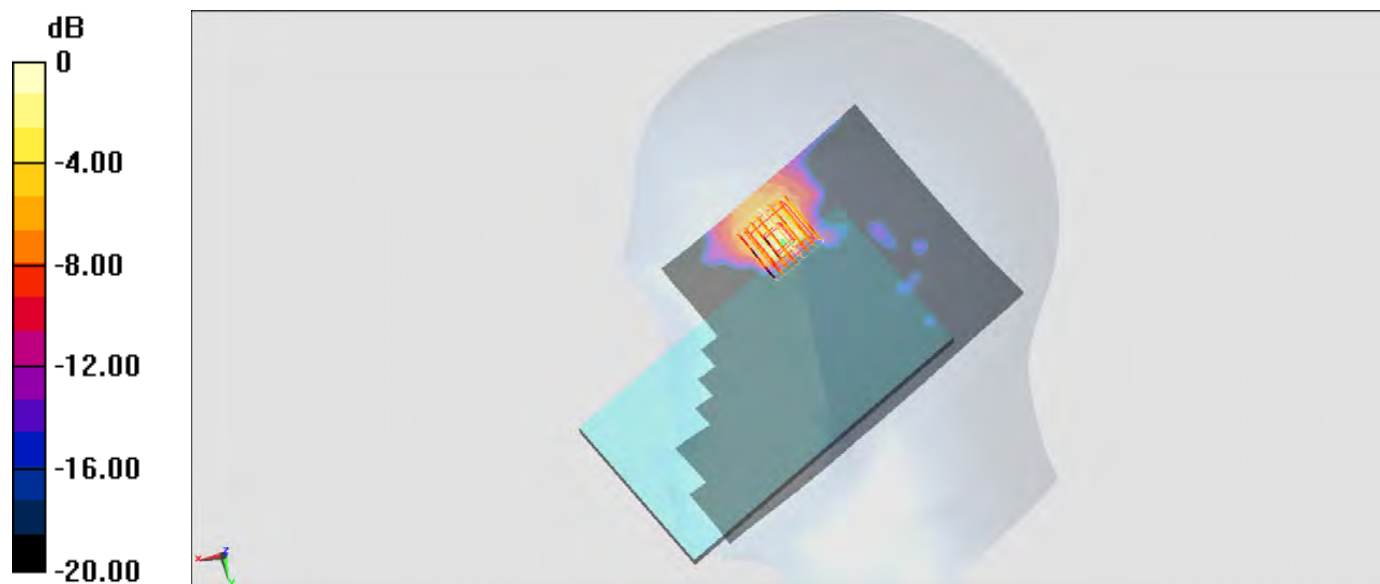

0 dB = 0.430 W/kg = -3.67 dBW/kg

#18_GSM850_GPRS (4 Tx slots)_Right Side_10mm_Ch251

Communication System: GSM850 ; Frequency: 848.8 MHz;Duty Cycle: 1:2.08

Medium: MSL_850_160908 Medium parameters used: $f = 849$ MHz; $\sigma = 0.976$ S/m; $\epsilon_r = 56.929$; $\rho = 1000$ kg/m³

Ambient Temperature : 23.5 °C ; Liquid Temperature : 22.5 °C

DASY5 Configuration:

- Probe: EX3DV4 - SN3955; ConvF(10.08, 10.08, 10.08); Calibrated: 2015/11/24;
- Sensor-Surface: 1.4mm (Mechanical Surface Detection)
- Electronics: DAE4 Sn778; Calibrated: 2016/5/12
- Phantom: SAM_Left; Type: QD000P40CD; Serial: TP:1644
- Measurement SW: DASY52, Version 52.8 (8);SEMCAD X Version 14.6.10 (7373)

Area Scan (41x121x1): Interpolated grid: dx=1.500 mm, dy=1.500 mm

Maximum value of SAR (interpolated) = 1.38 W/kg

Zoom Scan (5x5x7)/Cube 0: Measurement grid: dx=8mm, dy=8mm, dz=5mm

Reference Value = 36.99 V/m; Power Drift = -0.05 dB

Peak SAR (extrapolated) = 1.47 W/kg

SAR(1 g) = 1.06 W/kg; SAR(10 g) = 0.750 W/kg

Maximum value of SAR (measured) = 1.33 W/kg

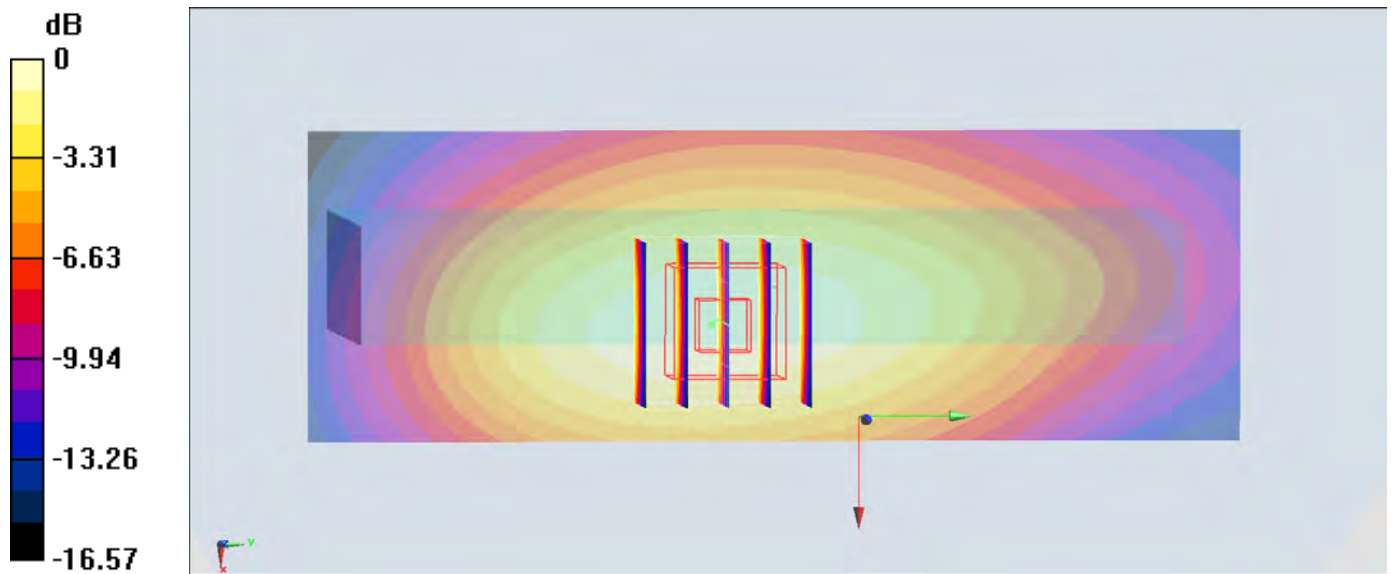

0 dB = 1.38 W/kg = 1.40 dBW/kg

#19_GSM1900_GPRS (4 Tx slots)_Bottom Side_10mm_Ch810

Communication System: PCS; Frequency: 1909.8 MHz; Duty Cycle: 1:2.08

Medium: MSL_1900_160905 Medium parameters used: $f = 1910$ MHz; $\sigma = 1.565$ S/m; $\epsilon_r = 55.731$; $\rho = 1000$ kg/m³

Ambient Temperature : 23.7 °C ; Liquid Temperature : 22.7 °C

DASY5 Configuration:

- Probe: EX3DV4 - SN3955; ConvF(7.89, 7.89, 7.89); Calibrated: 2015/11/24;
- Sensor-Surface: 1.4mm (Mechanical Surface Detection)
- Electronics: DAE4 Sn778; Calibrated: 2016/5/12
- Phantom: SAM_Left; Type: QD000P40CD; Serial: TP:1644
- Measurement SW: DASY52, Version 52.8 (8); SEMCAD X Version 14.6.10 (7373)

Area Scan (41x71x1): Interpolated grid: dx=1.500 mm, dy=1.500 mm

Maximum value of SAR (interpolated) = 1.65 W/kg

Zoom Scan (5x5x7)/Cube 0: Measurement grid: dx=8mm, dy=8mm, dz=5mm

Reference Value = 24.57 V/m; Power Drift = -0.06 dB

Peak SAR (extrapolated) = 1.68 W/kg

SAR(1 g) = 1.02 W/kg; SAR(10 g) = 0.573 W/kg

Maximum value of SAR (measured) = 1.42 W/kg

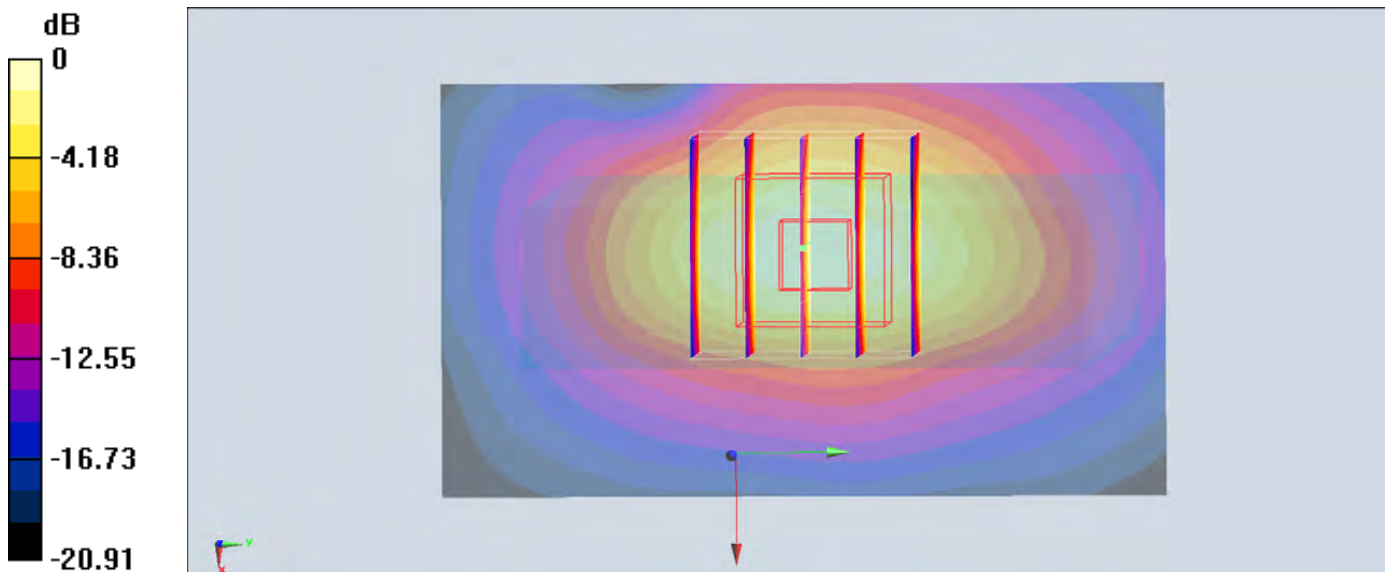

0 dB = 1.65 W/kg = 2.17 dBW/kg

#20_WCDMA II_RMC 12.2Kbps_Bottom Side_10mm_Ch9262

Communication System: WCDMA; Frequency: 1852.4 MHz; Duty Cycle: 1:1

Medium: MSL_1900_160905 Medium parameters used: $f = 1852.4$ MHz; $\sigma = 1.495$ S/m; $\epsilon_r = 55.904$;

$\rho = 1000$ kg/m³

Ambient Temperature : 23.7 °C ; Liquid Temperature : 22.7 °C

DASY5 Configuration:

- Probe: EX3DV4 - SN3955; ConvF(7.89, 7.89, 7.89); Calibrated: 2015/11/24;
- Sensor-Surface: 1.4mm (Mechanical Surface Detection)
- Electronics: DAE4 Sn778; Calibrated: 2016/5/12
- Phantom: SAM_Left; Type: QD000P40CD; Serial: TP:1644
- Measurement SW: DASY52, Version 52.8 (8); SEMCAD X Version 14.6.10 (7373)

Area Scan (41x71x1): Interpolated grid: dx=1.500 mm, dy=1.500 mm

Maximum value of SAR (interpolated) = 1.52 W/kg

Zoom Scan (5x5x7)/Cube 0: Measurement grid: dx=8mm, dy=8mm, dz=5mm

Reference Value = 22.69 V/m; Power Drift = 0.07 dB

Peak SAR (extrapolated) = 1.58 W/kg

SAR(1 g) = 0.965 W/kg; SAR(10 g) = 0.543 W/kg

Maximum value of SAR (measured) = 1.36 W/kg

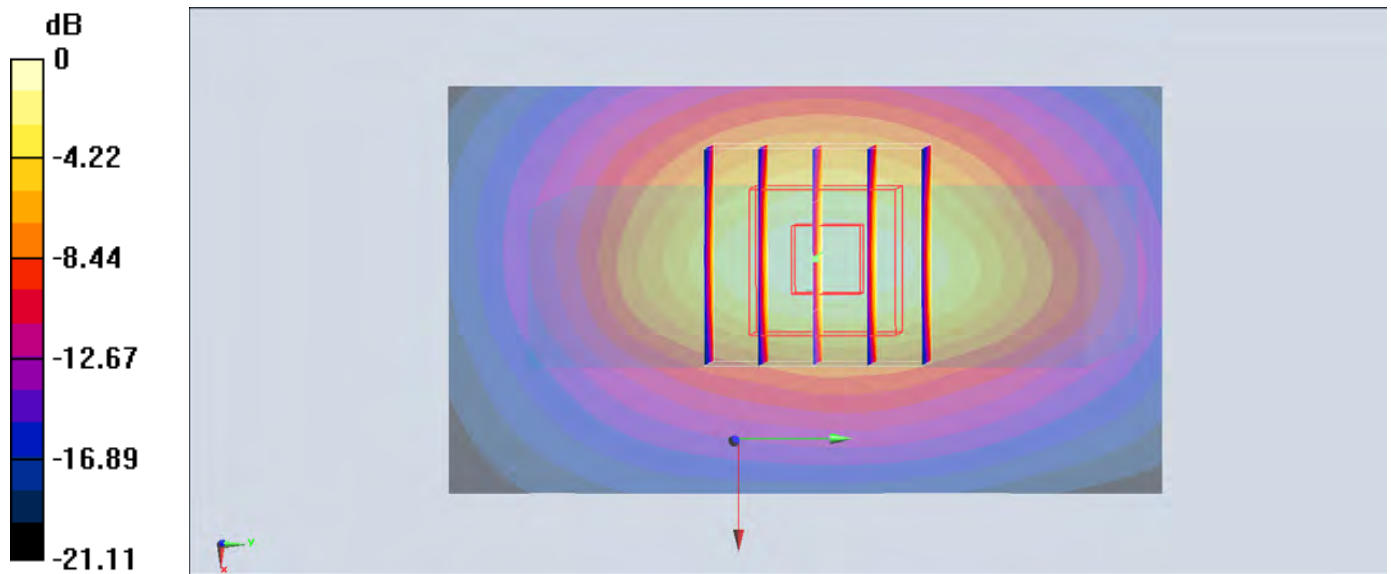

0 dB = 1.52 W/kg = 1.82 dBW/kg

#21_WCDMA IV_RMC 12.2Kbps_Bottom Side_10mm_Ch1312

Communication System: WCDMA ; Frequency: 1752.6 MHz; Duty Cycle: 1:1

Medium: MSL_1750_160906 Medium parameters used: $f = 1753 \text{ MHz}$; $\sigma = 1.512 \text{ S/m}$; $\epsilon_r = 55.926$; $\rho = 1000 \text{ kg/m}^3$

Ambient Temperature : $23.7 \text{ }^\circ\text{C}$; Liquid Temperature : $22.7 \text{ }^\circ\text{C}$

DASY5 Configuration:

- Probe: EX3DV4 - SN3955; ConvF(8.25, 8.25, 8.25); Calibrated: 2015/11/24;
- Sensor-Surface: 1.4mm (Mechanical Surface Detection)
- Electronics: DAE4 Sn778; Calibrated: 2016/5/12
- Phantom: SAM_Left; Type: QD000P40CD; Serial: TP:1644
- Measurement SW: DASY52, Version 52.8 (8); SEMCAD X Version 14.6.10 (7373)

Area Scan (41x71x1): Interpolated grid: $dx=1.500 \text{ mm}$, $dy=1.500 \text{ mm}$

Maximum value of SAR (interpolated) = 1.28 W/kg

Zoom Scan (5x5x7)/Cube 0: Measurement grid: $dx=8\text{mm}$, $dy=8\text{mm}$, $dz=5\text{mm}$

Reference Value = 21.08 V/m ; Power Drift = -0.13 dB

Peak SAR (extrapolated) = 1.23 W/kg

SAR(1 g) = 0.770 W/kg ; SAR(10 g) = 0.443 W/kg

Maximum value of SAR (measured) = 1.07 W/kg

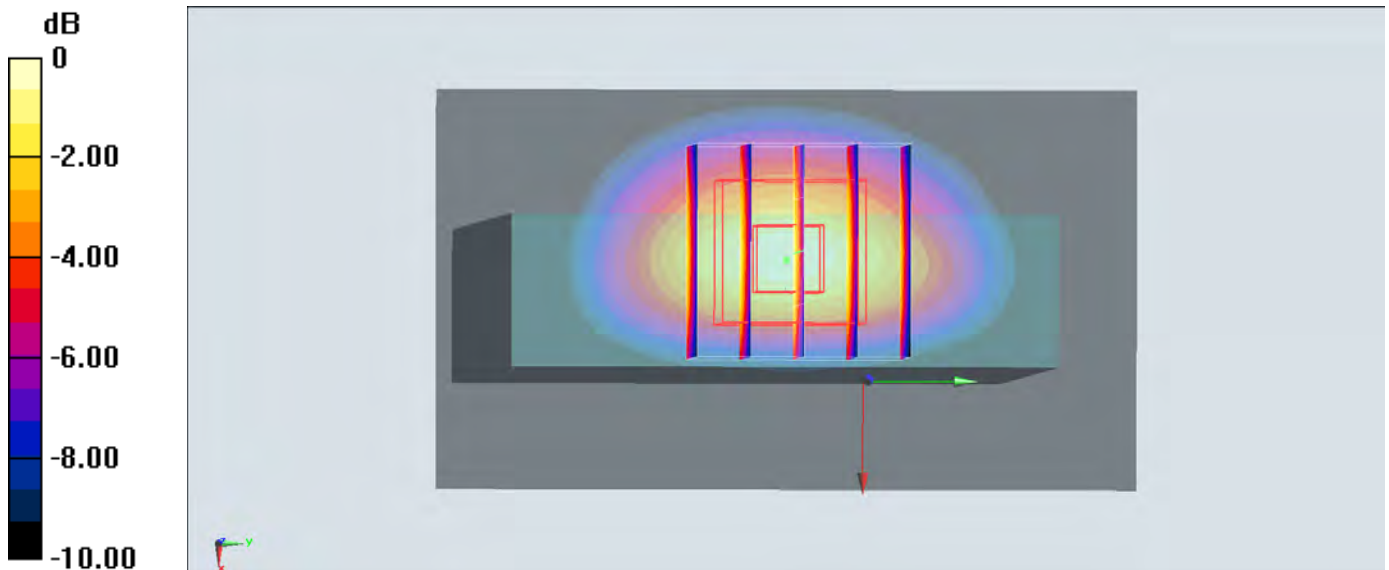

0 dB = $1.28 \text{ W/kg} = 1.07 \text{ dBW/kg}$

#22_WCDMA V_RMC 12.2Kbps_Right Side_10mm_Ch4132

Communication System: WCDMA; Frequency: 826.4 MHz; Duty Cycle: 1:1

Medium: MSL_850_160908 Medium parameters used : $f = 826.4$ MHz; $\sigma = 0.955$ S/m; $\epsilon_r = 57.118$; $\rho = 1000$ kg/m³

Ambient Temperature : 23.5 °C ; Liquid Temperature : 22.5 °C

DASY5 Configuration:

- Probe: EX3DV4 - SN3955; ConvF(10.08, 10.08, 10.08); Calibrated: 2015/11/24;
- Sensor-Surface: 1.4mm (Mechanical Surface Detection)
- Electronics: DAE4 Sn778; Calibrated: 2016/5/12
- Phantom: SAM_Left; Type: QD000P40CD; Serial: TP:1644
- Measurement SW: DASY52, Version 52.8 (8); SEMCAD X Version 14.6.10 (7373)

Area Scan (41x131x1): Interpolated grid: dx=1.500 mm, dy=1.500 mm

Maximum value of SAR (interpolated) = 0.551 W/kg

Zoom Scan (5x5x7)/Cube 0: Measurement grid: dx=8mm, dy=8mm, dz=5mm

Reference Value = 23.21 V/m; Power Drift = -0.01 dB

Peak SAR (extrapolated) = 0.621 W/kg

SAR(1 g) = 0.440 W/kg; SAR(10 g) = 0.313 W/kg

Maximum value of SAR (measured) = 0.559 W/kg

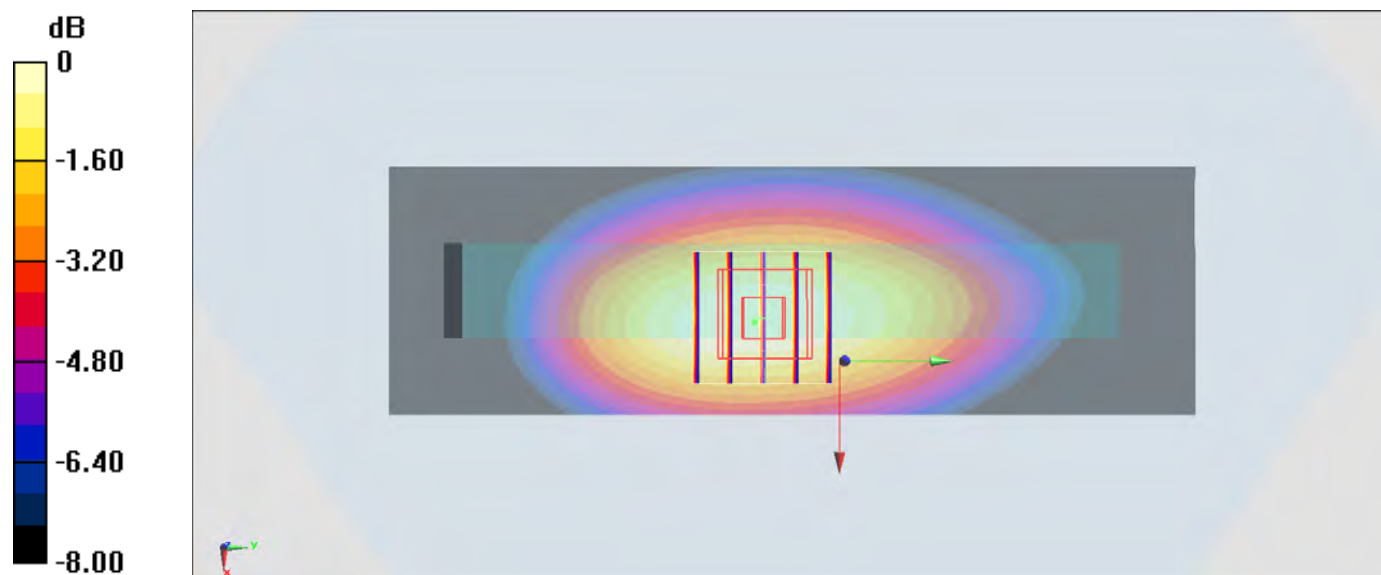

0 dB = 0.551 W/kg = -2.59 dBW/kg

#23_CDMA BC0_RTAP 153.6Kbps_Right Side_10mm_Ch777

Communication System: CDMA; Frequency: 848.31 MHz; Duty Cycle: 1:1

Medium: MSL_850_160908 Medium parameters used: $f = 848.31$ MHz; $\sigma = 0.975$ S/m; $\epsilon_r = 56.935$;

$\rho = 1000$ kg/m³

Ambient Temperature : 23.5 °C ; Liquid Temperature : 22.5 °C

DASY5 Configuration:

- Probe: ES3DV3 - SN3270; ConvF(6.01, 6.01, 6.01); Calibrated: 2016/8/26;
- Sensor-Surface: 3mm (Mechanical Surface Detection)
- Electronics: DAE4 Sn1399; Calibrated: 2015/11/23
- Phantom: SAM_Left; Type: QD000P40CD; Serial: TP:1644
- Measurement SW: DASY52, Version 52.8 (8); SEMCAD X Version 14.6.10 (7373)

Area Scan (51x121x1): Interpolated grid: dx=1.500 mm, dy=1.500 mm

Maximum value of SAR (interpolated) = 0.539 W/kg

Zoom Scan (5x5x7)/Cube 0: Measurement grid: dx=8mm, dy=8mm, dz=5mm

Reference Value = 23.61 V/m; Power Drift = 0.07 dB

Peak SAR (extrapolated) = 0.658 W/kg

SAR(1 g) = 0.477 W/kg; SAR(10 g) = 0.336 W/kg

Maximum value of SAR (measured) = 0.544 W/kg

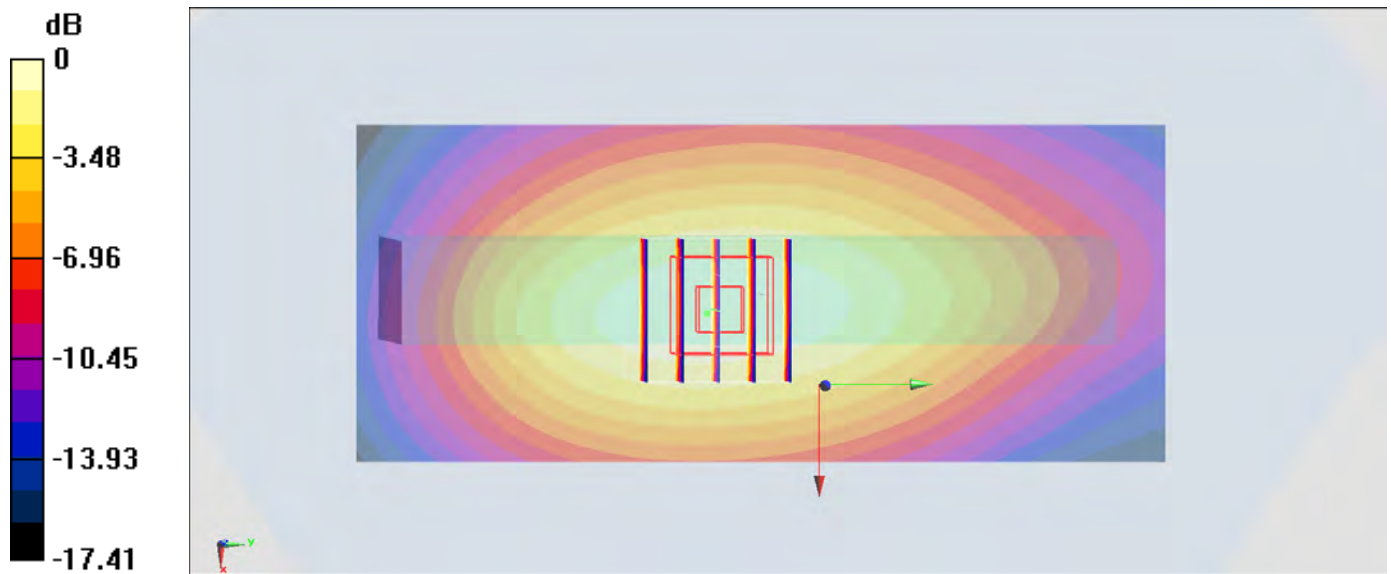

0 dB = 0.539 W/kg = -2.68 dBW/kg

#24_CDMA BC1_RTAP 153.6Kbps_Bottom Side_10mm_Ch600

Communication System: CDMA; Frequency: 1880 MHz; Duty Cycle: 1:1

Medium: MSL_1900_160905 Medium parameters used: $f = 1880$ MHz; $\sigma = 1.527$ S/m; $\epsilon_r = 55.846$; $\rho = 1000$ kg/m³

Ambient Temperature : 23.7 °C ; Liquid Temperature : 22.7 °C

DASY5 Configuration:

- Probe: EX3DV4 - SN3955; ConvF(7.89, 7.89, 7.89); Calibrated: 2015/11/24;
- Sensor-Surface: 1.4mm (Mechanical Surface Detection)
- Electronics: DAE4 Sn778; Calibrated: 2016/5/12
- Phantom: SAM_Left; Type: QD000P40CD; Serial: TP:1644
- Measurement SW: DASY52, Version 52.8 (8); SEMCAD X Version 14.6.10 (7373)

Area Scan (41x71x1): Interpolated grid: dx=1.500 mm, dy=1.500 mm

Maximum value of SAR (interpolated) = 1.56 W/kg

Zoom Scan (5x5x7)/Cube 0: Measurement grid: dx=8mm, dy=8mm, dz=5mm

Reference Value = 23.81 V/m; Power Drift = 0.01 dB

Peak SAR (extrapolated) = 1.59 W/kg

SAR(1 g) = 0.966 W/kg; SAR(10 g) = 0.543 W/kg

Maximum value of SAR (measured) = 1.38 W/kg

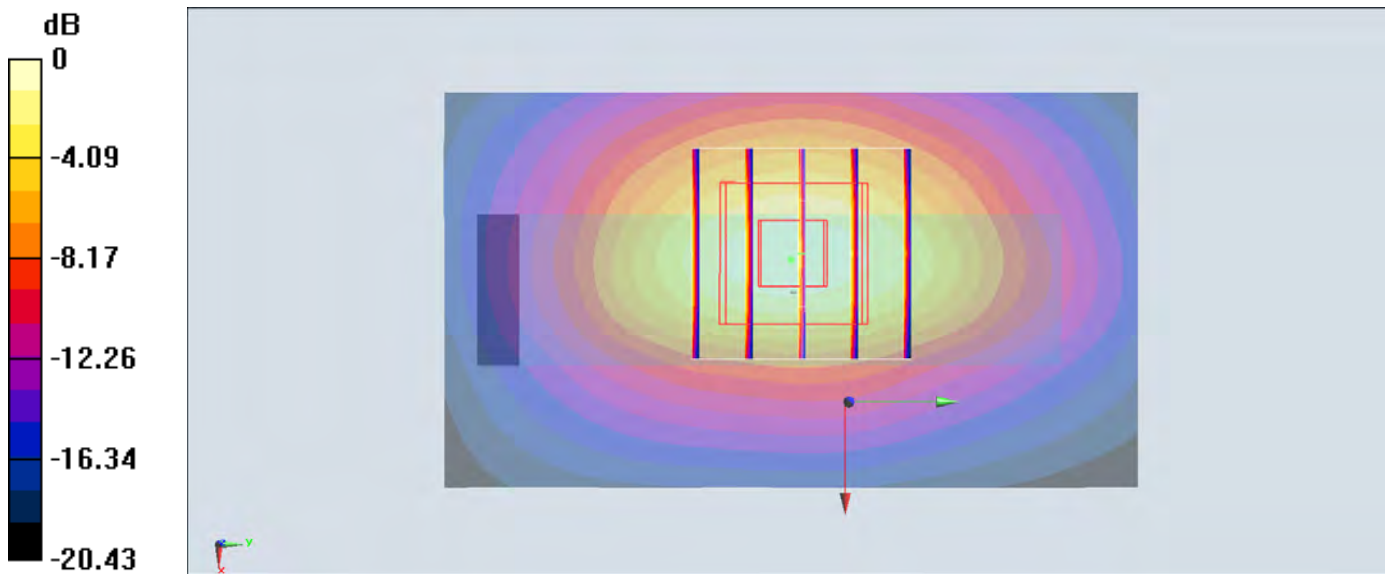

0 dB = 1.56 W/kg = 1.93 dBW/kg

#25_CDMA BC10_RTAP 153.6Kbps_Right Side_10mm_Ch580

Communication System: CDMA; Frequency: 820.5 MHz; Duty Cycle: 1:1

Medium: MSL_850_160908 Medium parameters used: $f = 820.5$ MHz; $\sigma = 0.949$ S/m; $\epsilon_r = 57.168$; $\rho = 1000$ kg/m³

Ambient Temperature : 23.5 °C ; Liquid Temperature : 22.5 °C

DASY5 Configuration:

- Probe: ES3DV3 - SN3270; ConvF(6.01, 6.01, 6.01); Calibrated: 2016/8/26;
- Sensor-Surface: 3mm (Mechanical Surface Detection)
- Electronics: DAE4 Sn1399; Calibrated: 2015/11/23
- Phantom: SAM_Left; Type: QD000P40CD; Serial: TP:1644
- Measurement SW: DASY52, Version 52.8 (8); SEMCAD X Version 14.6.10 (7373)

Area Scan (51x121x1): Interpolated grid: dx=1.500 mm, dy=1.500 mm

Maximum value of SAR (interpolated) = 0.477 W/kg

Zoom Scan (5x5x7)/Cube 0: Measurement grid: dx=8mm, dy=8mm, dz=5mm

Reference Value = 22.38 V/m; Power Drift = -0.02 dB

Peak SAR (extrapolated) = 0.573 W/kg

SAR(1 g) = 0.418 W/kg; SAR(10 g) = 0.297 W/kg

Maximum value of SAR (measured) = 0.473 W/kg

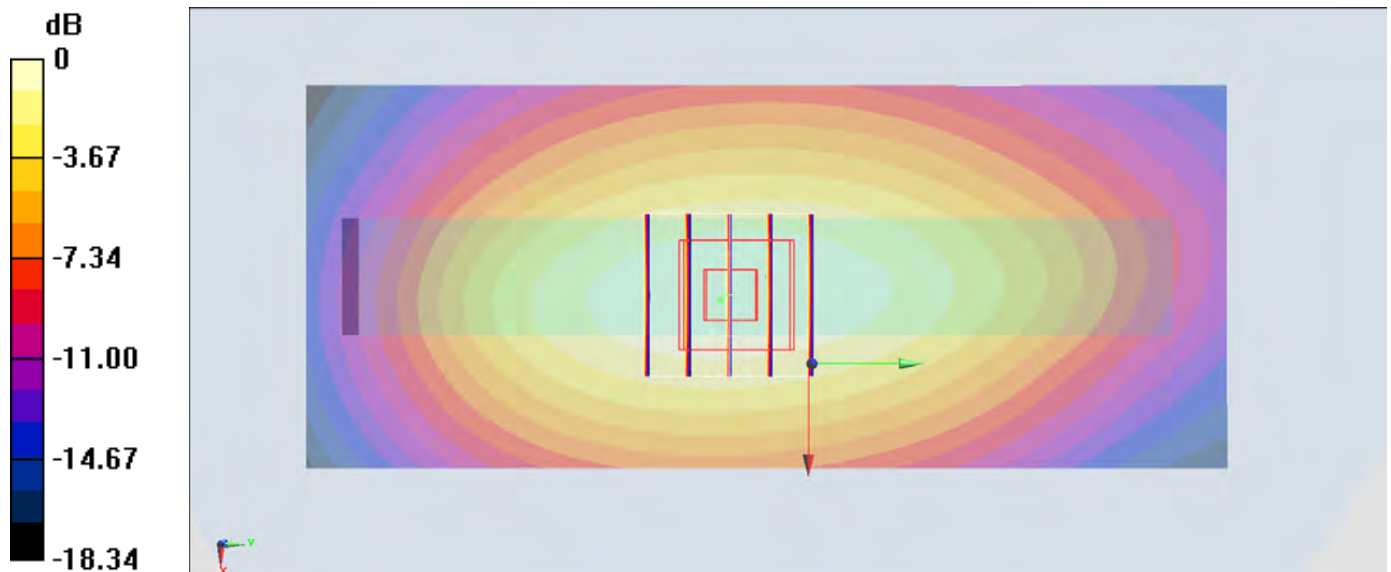

0 dB = 0.477 W/kg = -3.21 dBW/kg

#26_LTE Band 4_20M_QPSK_1_49_Bottom Side_10mm_Ch20175

Communication System: LTE; Frequency: 1732.5 MHz; Duty Cycle: 1:1

Medium: MSL_1750_160906 Medium parameters used: $f = 1732.5$ MHz; $\sigma = 1.491$ S/m; $\epsilon_r = 55.989$;

$\rho = 1000$ kg/m³

Ambient Temperature : 23.7 °C ; Liquid Temperature : 22.7 °C

DASY5 Configuration:

- Probe: EX3DV4 - SN3955; ConvF(8.25, 8.25, 8.25); Calibrated: 2015/11/24;
- Sensor-Surface: 1.4mm (Mechanical Surface Detection)
- Electronics: DAE4 Sn778; Calibrated: 2016/5/12
- Phantom: SAM_Left; Type: QD000P40CD; Serial: TP:1644
- Measurement SW: DASY52, Version 52.8 (8); SEMCAD X Version 14.6.10 (7373)

Area Scan (41x71x1): Interpolated grid: dx=1.500 mm, dy=1.500 mm

Maximum value of SAR (interpolated) = 1.67 W/kg

Zoom Scan (5x5x7)/Cube 0: Measurement grid: dx=8mm, dy=8mm, dz=5mm

Reference Value = 25.59 V/m; Power Drift = 0.09 dB

Peak SAR (extrapolated) = 1.65 W/kg

SAR(1 g) = 1.04 W/kg; SAR(10 g) = 0.602 W/kg

Maximum value of SAR (measured) = 1.44 W/kg

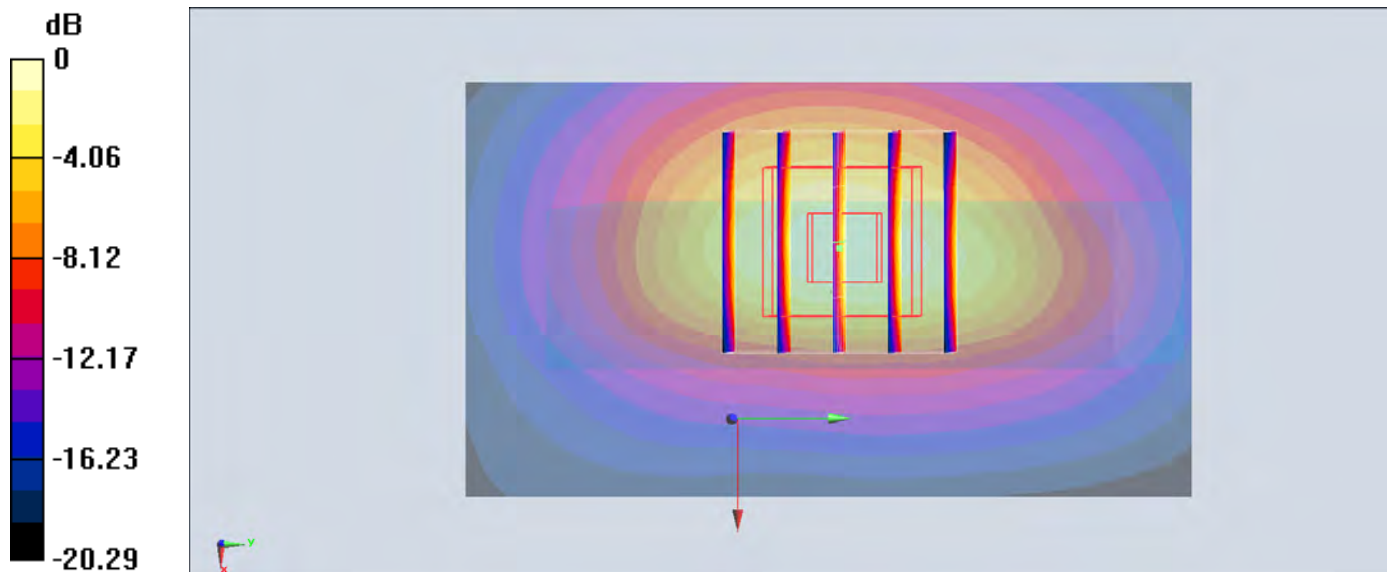

0 dB = 1.67 W/kg = 2.23 dBW/kg

#27_LTE Band 12_10M_QPSK_1_0_Right Side_10mm_Ch23095

Communication System: LTE; Frequency: 707.5 MHz; Duty Cycle: 1:1

Medium: MSL_750_160909 Medium parameters used: $f = 707.5$ MHz; $\sigma = 0.914$ S/m; $\epsilon_r = 56.151$; $\rho = 1000$ kg/m³

Ambient Temperature : 23.5 °C ; Liquid Temperature : 22.5 °C

DASY5 Configuration:

- Probe: ES3DV3 - SN3270; ConvF(6.09, 6.09, 6.09); Calibrated: 2016/8/26;
- Sensor-Surface: 3mm (Mechanical Surface Detection)
- Electronics: DAE4 Sn1399; Calibrated: 2015/11/23
- Phantom: SAM_Left; Type: QD000P40CD; Serial: TP:1644
- Measurement SW: DASY52, Version 52.8 (8); SEMCAD X Version 14.6.10 (7373)

Area Scan (51x131x1): Interpolated grid: dx=1.500 mm, dy=1.500 mm

Maximum value of SAR (interpolated) = 0.444 W/kg

Zoom Scan (5x5x7)/Cube 0: Measurement grid: dx=8mm, dy=8mm, dz=5mm

Reference Value = 22.04 V/m; Power Drift = -0.02 dB

Peak SAR (extrapolated) = 0.526 W/kg

SAR(1 g) = 0.381 W/kg; SAR(10 g) = 0.273 W/kg

Maximum value of SAR (measured) = 0.430 W/kg

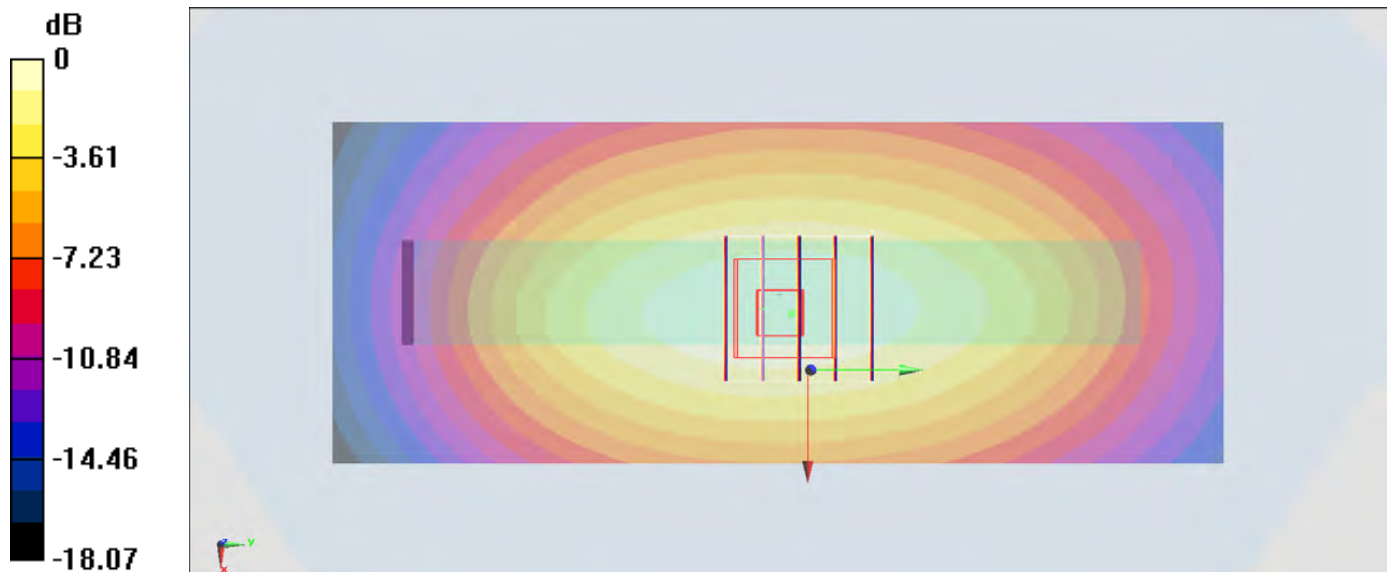

0 dB = 0.444 W/kg = -3.53 dBW/kg

#28_LTE Band 13_10M_QPSK_1_25_Right Side_10mm_Ch23230

Communication System: LTE; Frequency: 782 MHz; Duty Cycle: 1:1

Medium: MSL_750_160909 Medium parameters used: $f = 782 \text{ MHz}$; $\sigma = 0.983 \text{ S/m}$; $\epsilon_r = 55.502$; $\rho = 1000 \text{ kg/m}^3$

Ambient Temperature : $23.5 \text{ }^\circ\text{C}$; Liquid Temperature : $22.5 \text{ }^\circ\text{C}$

DASY5 Configuration:

- Probe: EX3DV4 - SN3955; ConvF(10.36, 10.36, 10.36); Calibrated: 2015/11/24;
- Sensor-Surface: 1.4mm (Mechanical Surface Detection)
- Electronics: DAE4 Sn778; Calibrated: 2016/5/12
- Phantom: SAM_Left; Type: QD000P40CD; Serial: TP:1644
- Measurement SW: DASY52, Version 52.8 (8); SEMCAD X Version 14.6.10 (7373)

Area Scan (51x131x1): Interpolated grid: $dx=1.500 \text{ mm}$, $dy=1.500 \text{ mm}$

Maximum value of SAR (interpolated) = 0.500 W/kg

Zoom Scan (5x5x7)/Cube 0: Measurement grid: $dx=8\text{mm}$, $dy=8\text{mm}$, $dz=5\text{mm}$

Reference Value = 22.72 V/m ; Power Drift = -0.13 dB

Peak SAR (extrapolated) = 0.558 W/kg

SAR(1 g) = 0.387 W/kg ; SAR(10 g) = 0.272 W/kg

Maximum value of SAR (measured) = 0.497 W/kg

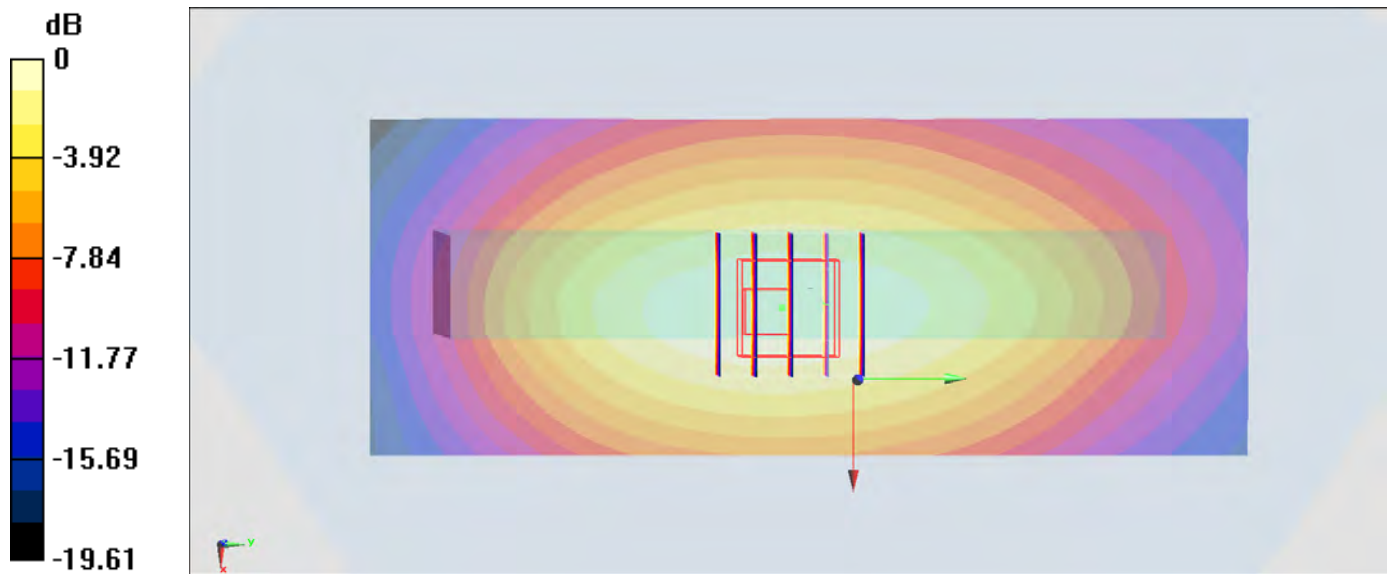

0 dB = 0.500 W/kg = -3.01 dBW/kg

#29_LTE Band 25_20M_QPSK_1_49_Bottom Side_10mm_Ch26340

Communication System: LTE; Frequency: 1880 MHz; Duty Cycle: 1:1

Medium: MSL_1900_160905 Medium parameters used: $f = 1880$ MHz; $\sigma = 1.527$ S/m; $\epsilon_r = 55.846$; $\rho = 1000$ kg/m³

Ambient Temperature : 23.7 °C ; Liquid Temperature : 22.7 °C

DASY5 Configuration:

- Probe: EX3DV4 - SN3955; ConvF(7.89, 7.89, 7.89); Calibrated: 2015/11/24;
- Sensor-Surface: 1.4mm (Mechanical Surface Detection)
- Electronics: DAE4 Sn778; Calibrated: 2016/5/12
- Phantom: SAM_Left; Type: QD000P40CD; Serial: TP:1644
- Measurement SW: DASY52, Version 52.8 (8); SEMCAD X Version 14.6.10 (7373)

Area Scan (41x71x1): Interpolated grid: dx=1.500 mm, dy=1.500 mm

Maximum value of SAR (interpolated) = 1.40 W/kg

Zoom Scan (5x5x7)/Cube 0: Measurement grid: dx=8mm, dy=8mm, dz=5mm

Reference Value = 22.83 V/m; Power Drift = -0.02 dB

Peak SAR (extrapolated) = 1.43 W/kg

SAR(1 g) = 0.867 W/kg; SAR(10 g) = 0.488 W/kg

Maximum value of SAR (measured) = 1.23 W/kg

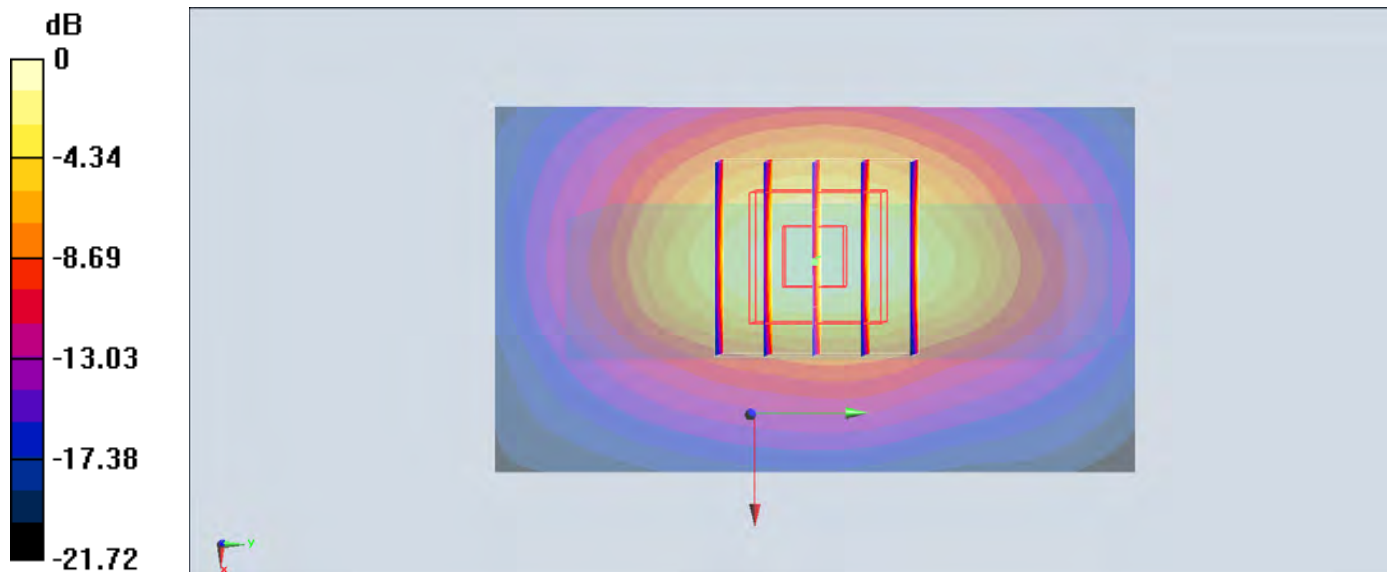

0 dB = 1.40 W/kg = 1.46 dBW/kg

#30_LTE Band 26_15M_QPSK_1_37_Right Side_10mm_Ch26865

Communication System: LTE ; Frequency: 831.5 MHz;Duty Cycle: 1:1

Medium: MSL_850_160907 Medium parameters used : $f = 831.5$ MHz; $\sigma = 0.965$ S/m; $\epsilon_r = 57.187$; $\rho = 1000$ kg/m³

Ambient Temperature : 23.4 °C ; Liquid Temperature : 22.4 °C

DASY5 Configuration:

- Probe: EX3DV4 - SN3955; ConvF(10.08, 10.08, 10.08); Calibrated: 2015/11/24;
- Sensor-Surface: 1.4mm (Mechanical Surface Detection)
- Electronics: DAE4 Sn778; Calibrated: 2016/5/12
- Phantom: SAM_Left; Type: QD000P40CD; Serial: TP:1644
- Measurement SW: DASY52, Version 52.8 (8);SEMCAD X Version 14.6.10 (7373)

Area Scan (41x131x1): Interpolated grid: dx=1.500 mm, dy=1.500 mm

Maximum value of SAR (interpolated) = 0.482 W/kg

Zoom Scan (5x5x7)/Cube 0: Measurement grid: dx=8mm, dy=8mm, dz=5mm

Reference Value = 23.07 V/m; Power Drift = -0.09 dB

Peak SAR (extrapolated) = 0.542 W/kg

SAR(1 g) = 0.382 W/kg; SAR(10 g) = 0.274 W/kg

Maximum value of SAR (measured) = 0.484 W/kg

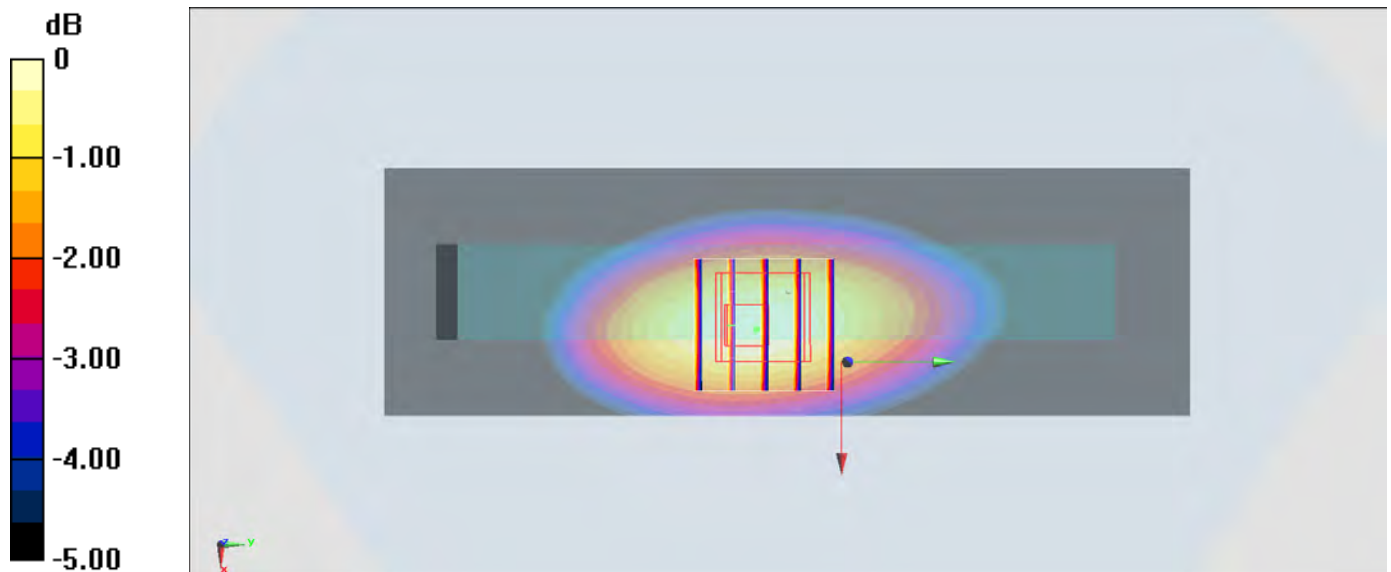

#31_WLAN2.4GHz_802.11b 1Mbps_Right Side_10mm_Ch6;Ant 2

Communication System: 802.11b ; Frequency: 2437 MHz;Duty Cycle: 1:1.014

Medium: MSL_2450_160908 Medium parameters used: $f = 2437$ MHz; $\sigma = 1.965$ S/m; $\epsilon_r = 52.622$; $\rho = 1000$ kg/m³

Ambient Temperature : 23.6 °C ; Liquid Temperature : 22.6 °C

DASY5 Configuration:

- Probe: EX3DV4 - SN3697; ConvF(6.9, 6.9, 6.9); Calibrated: 2015/9/28;
- Sensor-Surface: 1.4mm (Mechanical Surface Detection)
- Electronics: DAE4 Sn1388; Calibrated: 2015/9/25
- Phantom: SAM_Right; Type: QD000P40CD; Serial: TP:1383
- Measurement SW: DASY52, Version 52.8 (8);SEMCAD X Version 14.6.10 (7331)

Area Scan (51x151x1): Interpolated grid: dx=1.200 mm, dy=1.200 mm

Maximum value of SAR (interpolated) = 0.434 W/kg

Zoom Scan (7x7x7)/Cube 0: Measurement grid: dx=5mm, dy=5mm, dz=5mm

Reference Value = 6.590 V/m; Power Drift = -0.11 dB

Peak SAR (extrapolated) = 0.547 W/kg

SAR(1 g) = 0.297 W/kg; SAR(10 g) = 0.162 W/kg

Maximum value of SAR (measured) = 0.453 W/kg

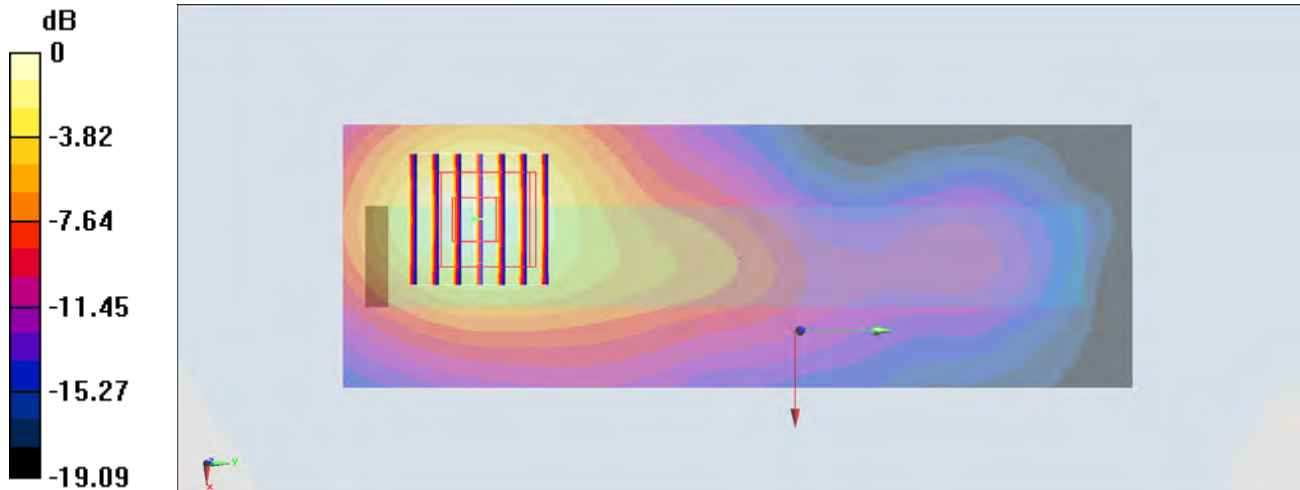

0 dB = 0.453 W/kg = -3.44 dBW/kg

#32_WLAN5GHz_802.11a 6Mbps_Back_10mm_Ch44;Ant 2

Communication System: 802.11a; Frequency: 5220 MHz; Duty Cycle: 1:1.077

Medium: MSL_5G_160913 Medium parameters used: $f = 5220 \text{ MHz}$; $\sigma = 5.43 \text{ mho/m}$; $\epsilon_r = 46.8$; $\rho = 1000 \text{ kg/m}^3$

Ambient Temperature : $23.5 \text{ }^\circ\text{C}$; Liquid Temperature : $22.5 \text{ }^\circ\text{C}$

DASY4 Configuration:

- Probe: EX3DV4 - SN3931; ConvF(4.48, 4.48, 4.48); Calibrated: 2015/10/1
- Sensor-Surface: 1.4mm (Mechanical Surface Detection)
- Electronics: DAE3 Sn577; Calibrated: 2015/9/24
- Phantom: SAM_Right; Type: QD000P40CD; Serial: TP:1383
- ;Postprocessing SW: SEMCAD, V1.8 Build 159

Area Scan (121x101x1): Measurement grid: $dx=10\text{mm}$, $dy=10\text{mm}$

Maximum value of SAR (interpolated) = 0.900 mW/g

Zoom Scan (7x7x7)/Cube 0: Measurement grid: $dx=4\text{mm}$, $dy=4\text{mm}$, $dz=1.4\text{mm}$

Reference Value = 7.96 V/m ; Power Drift = -0.031 dB

Peak SAR (extrapolated) = 1.37 W/kg

SAR(1 g) = 0.429 mW/g ; SAR(10 g) = 0.178 mW/g

Maximum value of SAR (measured) = 0.895 mW/g

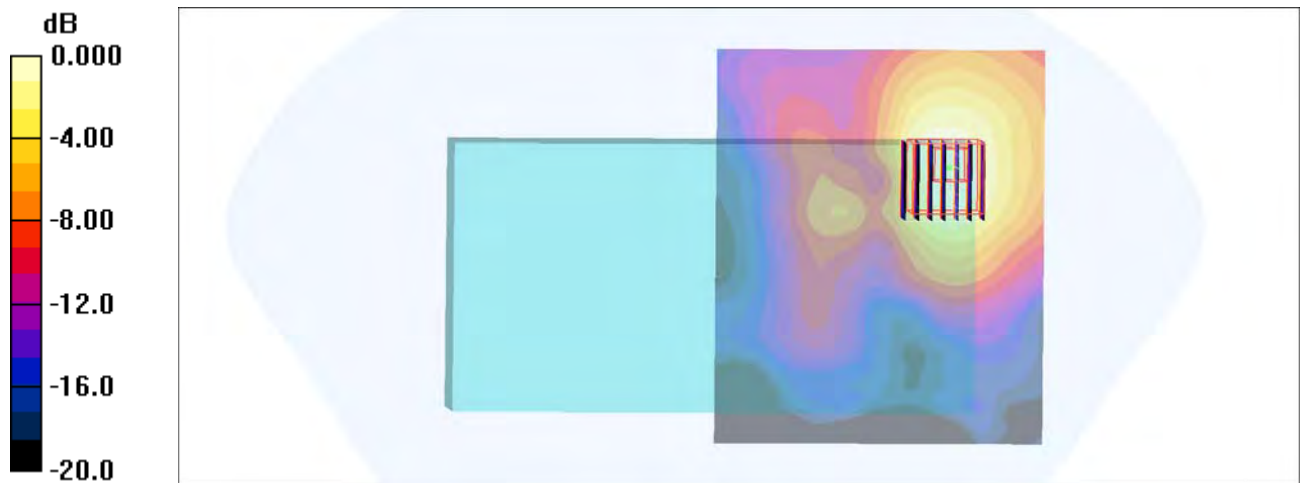

0 dB = 0.895mW/g

#33_WLAN5GHz_802.11a 6Mbps_Back_10mm_Ch165;Ant 2

Communication System: 802.11a; Frequency: 5825 MHz; Duty Cycle: 1:1.077

Medium: MSL_5G_160912 Medium parameters used: $f = 5825$ MHz; $\sigma = 6.23$ S/m; $\epsilon_r = 45.864$; $\rho = 1000$ kg/m³

Ambient Temperature : 23.5 °C ; Liquid Temperature : 22.5 °C

DASY5 Configuration:

- Probe: EX3DV4 - SN3931; ConvF(3.98, 3.98, 3.98); Calibrated: 2015/10/1;
- Sensor-Surface: 1.4mm (Mechanical Surface Detection)
- Electronics: DAE3 Sn577; Calibrated: 2015/9/24
- Phantom: SAM-Right; Type: SAM; Serial: 1795
- Measurement SW: DASY52, Version 52.8 (8); SEMCAD X Version 14.6.10 (7373)

Area Scan (111x101x1): Interpolated grid: dx=1.000 mm, dy=1.000 mm

Maximum value of SAR (interpolated) = 1.10 W/kg

Zoom Scan (7x7x7)/Cube 0: Measurement grid: dx=4mm, dy=4mm, dz=1.4mm

Reference Value = 13.68 V/m; Power Drift = -0.12 dB

Peak SAR (extrapolated) = 1.82 W/kg

SAR(1 g) = 0.485 W/kg; SAR(10 g) = 0.191 W/kg

Maximum value of SAR (measured) = 1.11 W/kg

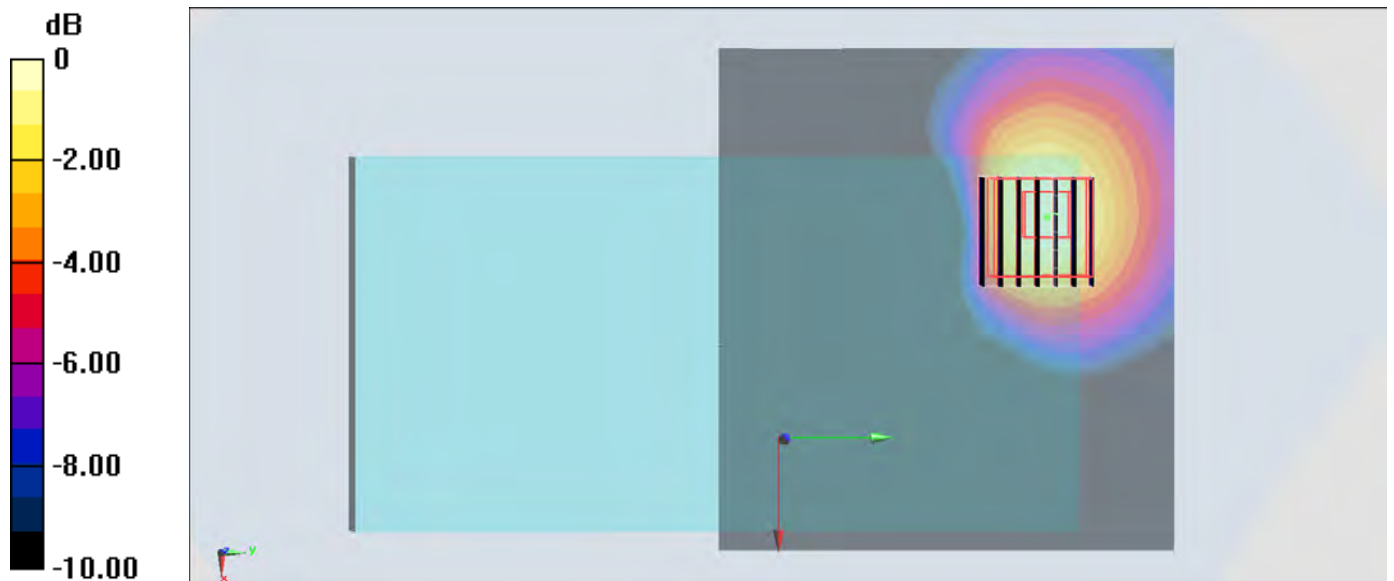

0 dB = 1.10 W/kg = 0.41 dBW/kg

#34_GSM850_GPRS (4 Tx slots)_Front_0mm_Ch189;Soft Holster

Communication System: GSM850; Frequency: 836.4 MHz; Duty Cycle: 1:2.08

Medium: MSL_850_160908 Medium parameters used: $f = 836.4$ MHz; $\sigma = 0.963$ S/m; $\epsilon_r = 57.048$; $\rho = 1000$ kg/m³

Ambient Temperature : 23.5 °C ; Liquid Temperature : 22.5 °C

DASY5 Configuration:

- Probe: EX3DV4 - SN3955; ConvF(10.08, 10.08, 10.08); Calibrated: 2015/11/24;
- Sensor-Surface: 1.4mm (Mechanical Surface Detection)
- Electronics: DAE4 Sn778; Calibrated: 2016/5/12
- Phantom: SAM_Left; Type: QD000P40CD; Serial: TP:1644
- Measurement SW: DASY52, Version 52.8 (8); SEMCAD X Version 14.6.10 (7373)

Area Scan (71x71x1): Interpolated grid: dx=1.500 mm, dy=1.500 mm

Maximum value of SAR (interpolated) = 1.36 W/kg

Zoom Scan (5x5x7)/Cube 0: Measurement grid: dx=8mm, dy=8mm, dz=5mm

Reference Value = 39.25 V/m; Power Drift = -0.10 dB

Peak SAR (extrapolated) = 1.70 W/kg

SAR(1 g) = 1.02 W/kg; SAR(10 g) = 0.619 W/kg

Maximum value of SAR (measured) = 1.34 W/kg

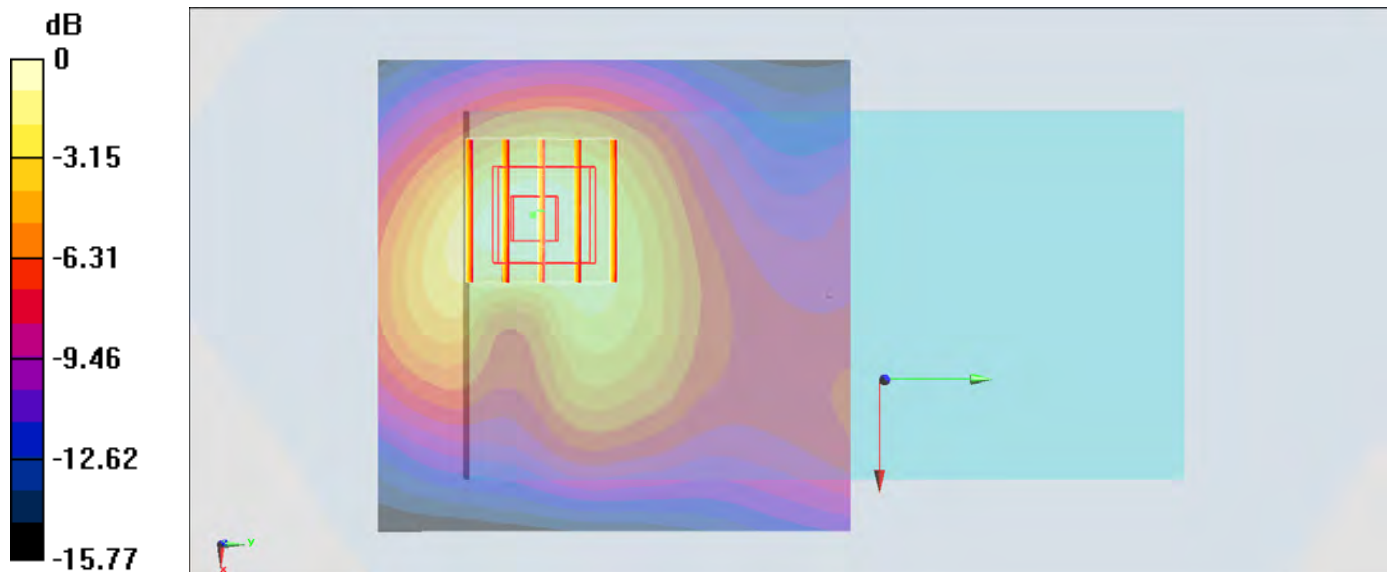

0 dB = 1.36 W/kg = 1.34 dBW/kg

#35_GSM1900_GPRS (3 Tx slots)_Back_15mm_Ch512

Communication System: PCS; Frequency: 1850.2 MHz; Duty Cycle: 1:2.77

Medium: MSL_1900_160905 Medium parameters used : $f = 1850.2$ MHz; $\sigma = 1.492$ S/m; $\epsilon_r = 55.907$; $\rho = 1000$ kg/m³

Ambient Temperature : 23.7 °C; Liquid Temperature : 22.7 °C

DASY5 Configuration:

- Probe: EX3DV4 - SN3955; ConvF(7.89, 7.89, 7.89); Calibrated: 2015/11/24;
- Sensor-Surface: 1.4mm (Mechanical Surface Detection)
- Electronics: DAE4 Sn778; Calibrated: 2016/5/12
- Phantom: SAM_Left; Type: QD000P40CD; Serial: TP:1644
- Measurement SW: DASY52, Version 52.8 (8); SEMCAD X Version 14.6.10 (7373)

Area Scan (71x131x1): Interpolated grid: dx=1.500 mm, dy=1.500 mm

Maximum value of SAR (interpolated) = 1.56 W/kg

Zoom Scan (5x5x7)/Cube 0: Measurement grid: dx=8mm, dy=8mm, dz=5mm

Reference Value = 21.40 V/m; Power Drift = -0.04 dB

Peak SAR (extrapolated) = 1.70 W/kg

SAR(1 g) = 1.1 W/kg; SAR(10 g) = 0.668 W/kg

Maximum value of SAR (measured) = 1.48 W/kg

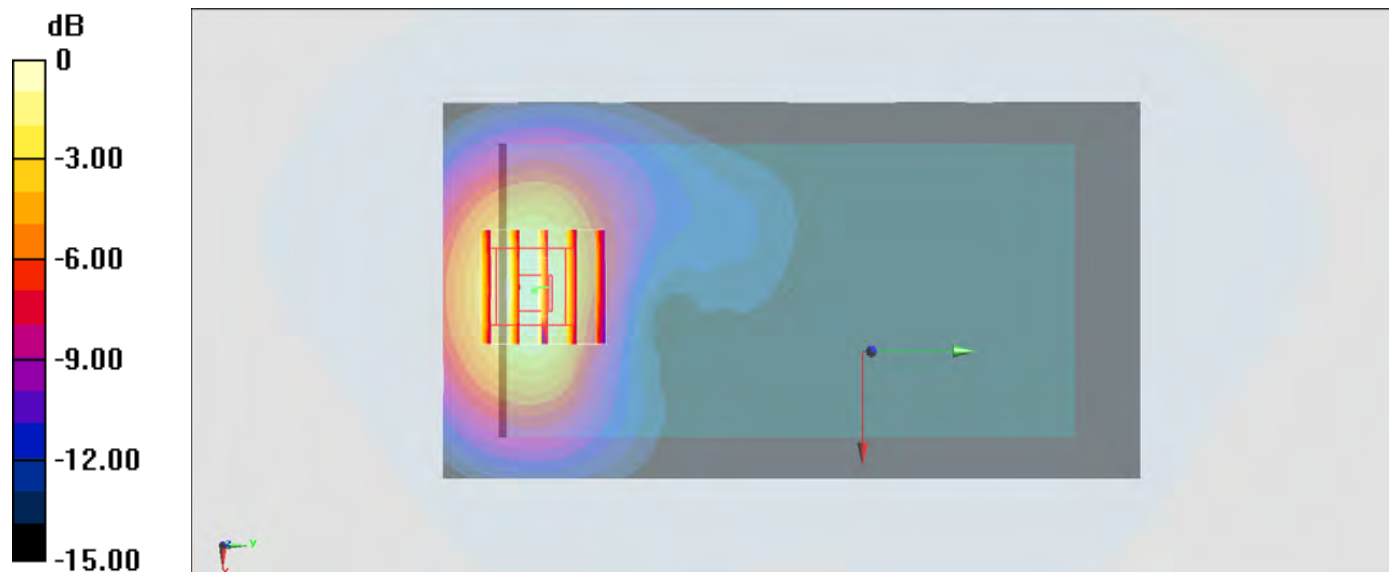

0 dB = 1.56 W/kg = 1.93 dBW/kg

#36_WCDMA II_RMC 12.2Kbps_Back_15mm_Ch9400

Communication System: WCDMA ; Frequency: 1880 MHz;Duty Cycle: 1:1

Medium: MSL_1900_160907 Medium parameters used: $f = 1880$ MHz; $\sigma = 1.52$ S/m; $\epsilon_r = 55.812$; $\rho = 1000$ kg/m³

Ambient Temperature : 23.4 °C ; Liquid Temperature : 22.4 °C

DASY5 Configuration:

- Probe: EX3DV4 - SN3955; ConvF(7.89, 7.89, 7.89); Calibrated: 2015/11/24;
- Sensor-Surface: 1.4mm (Mechanical Surface Detection)
- Electronics: DAE4 Sn778; Calibrated: 2016/5/12
- Phantom: SAM_Left; Type: QD000P40CD; Serial: TP:1644
- Measurement SW: DASY52, Version 52.8 (8);SEMCAD X Version 14.6.10 (7373)

Area Scan (71x71x1): Interpolated grid: dx=1.500 mm, dy=1.500 mm

Maximum value of SAR (interpolated) = 1.29 W/kg

Zoom Scan (5x5x7)/Cube 0: Measurement grid: dx=8mm, dy=8mm, dz=5mm

Reference Value = 24.44 V/m; Power Drift = -0.03 dB

Peak SAR (extrapolated) = 1.41 W/kg

SAR(1 g) = **0.895 W/kg**; SAR(10 g) = **0.539 W/kg**

Maximum value of SAR (measured) = 1.23 W/kg

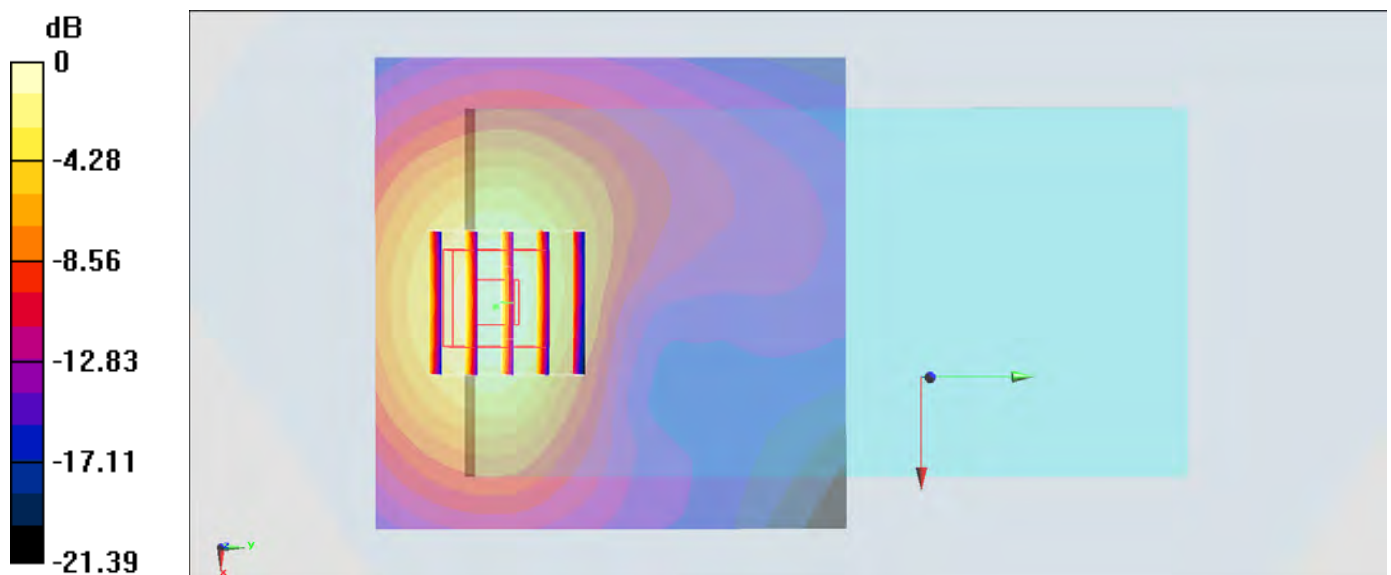

0 dB = 1.29 W/kg = 1.11 dBW/kg

#37_WCDMA IV_RMC 12.2Kbps_Back_15mm_Ch1413

Communication System: WCDMA ; Frequency: 1732.6 MHz; Duty Cycle: 1:1

Medium: MSL_1750_160906 Medium parameters used: $f = 1733 \text{ MHz}$; $\sigma = 1.492 \text{ S/m}$; $\epsilon_r = 55.987$; $\rho = 1000 \text{ kg/m}^3$

Ambient Temperature : $23.7 \text{ }^\circ\text{C}$; Liquid Temperature : $22.7 \text{ }^\circ\text{C}$

DASY5 Configuration:

- Probe: EX3DV4 - SN3955; ConvF(8.25, 8.25, 8.25); Calibrated: 2015/11/24;
- Sensor-Surface: 1.4mm (Mechanical Surface Detection)
- Electronics: DAE4 Sn778; Calibrated: 2016/5/12
- Phantom: SAM_Left; Type: QD000P40CD; Serial: TP:1644
- Measurement SW: DASY52, Version 52.8 (8); SEMCAD X Version 14.6.10 (7373)

Area Scan (71x71x1): Interpolated grid: $dx=1.500 \text{ mm}$, $dy=1.500 \text{ mm}$

Maximum value of SAR (interpolated) = 1.31 W/kg

Zoom Scan (5x5x7)/Cube 0: Measurement grid: $dx=8\text{mm}$, $dy=8\text{mm}$, $dz=5\text{mm}$

Reference Value = 24.59 V/m ; Power Drift = -0.06 dB

Peak SAR (extrapolated) = 1.39 W/kg

SAR(1 g) = 0.926 W/kg ; SAR(10 g) = 0.568 W/kg

Maximum value of SAR (measured) = 1.23 W/kg

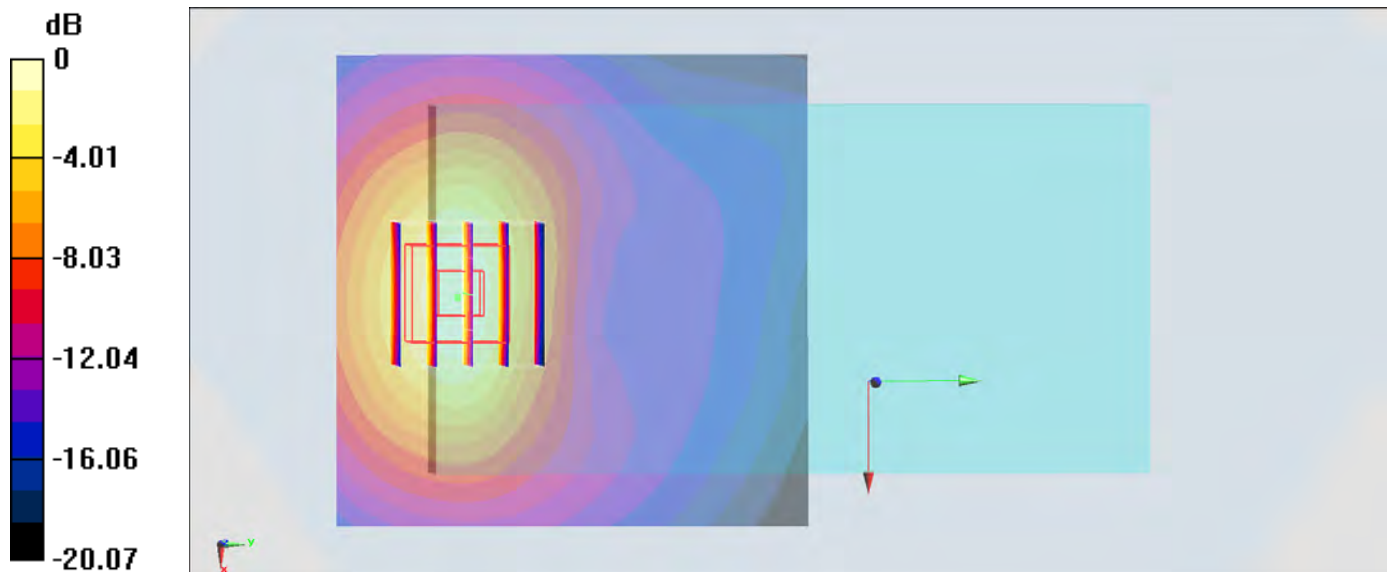

0 dB = $1.31 \text{ W/kg} = 1.17 \text{ dBW/kg}$

#38_WCDMA V_RMC 12.2Kbps_Front_0mm_Ch4233;Soft Holster

Communication System: WCDMA; Frequency: 846.6 MHz; Duty Cycle: 1:1

Medium: MSL_850_160908 Medium parameters used: $f = 847$ MHz; $\sigma = 0.974$ S/m; $\epsilon_r = 56.946$; $\rho = 1000$ kg/m³

Ambient Temperature : 23.5 °C; Liquid Temperature : 22.5 °C

DASY5 Configuration:

- Probe: EX3DV4 - SN3955; ConvF(10.08, 10.08, 10.08); Calibrated: 2015/11/24;
- Sensor-Surface: 1.4mm (Mechanical Surface Detection)
- Electronics: DAE4 Sn778; Calibrated: 2016/5/12
- Phantom: SAM_Left; Type: QD000P40CD; Serial: TP:1644
- Measurement SW: DASY52, Version 52.8 (8); SEMCAD X Version 14.6.10 (7373)

Area Scan (71x121x1): Interpolated grid: dx=1.500 mm, dy=1.500 mm

Maximum value of SAR (interpolated) = 0.465 W/kg

Zoom Scan (5x5x7)/Cube 0: Measurement grid: dx=8mm, dy=8mm, dz=5mm

Reference Value = 19.97 V/m; Power Drift = -0.11 dB

Peak SAR (extrapolated) = 0.530 W/kg

SAR(1 g) = 0.335 W/kg; SAR(10 g) = 0.214 W/kg

Maximum value of SAR (measured) = 0.460 W/kg

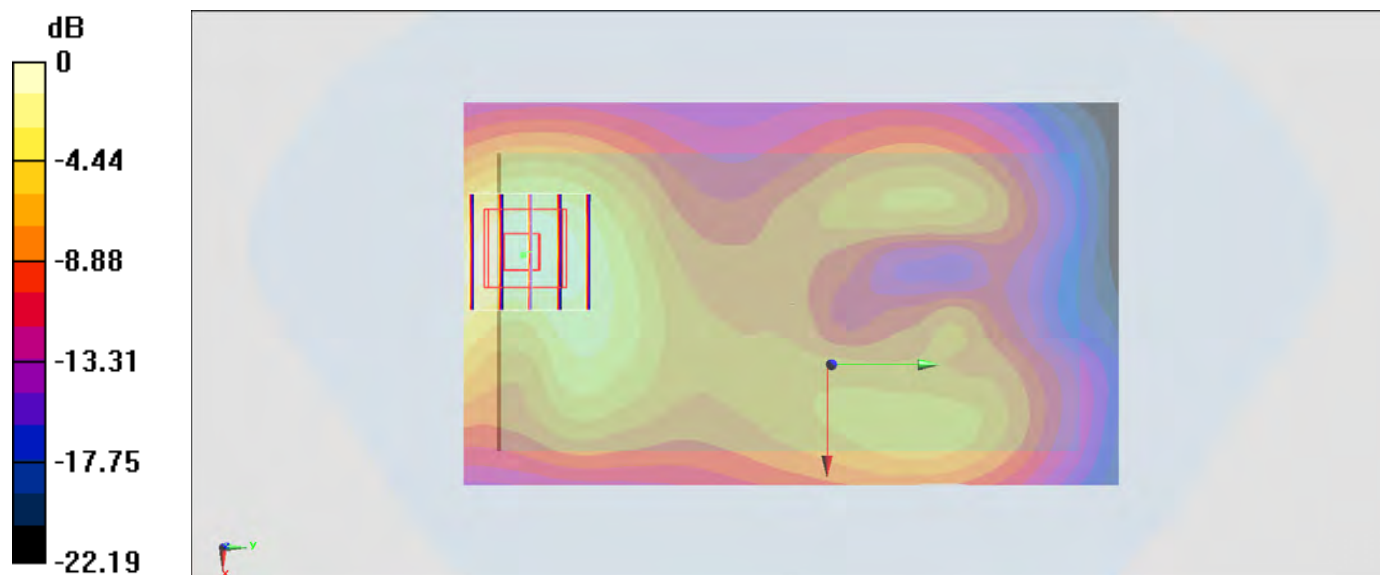

0 dB = 0.465 W/kg = -3.33 dBW/kg

#39_CDMA BC0_1xRTT RC3 SO32_Front_0mm_Ch777;Soft Holster

Communication System: CDMA ; Frequency: 848.31 MHz;Duty Cycle: 1:1

Medium: MSL_850_160908 Medium parameters used : $f = 848.31$ MHz; $\sigma = 0.975$ S/m; $\epsilon_r = 56.935$;

$\rho = 1000$ kg/m³

Ambient Temperature : 23.5 °C ; Liquid Temperature : 22.5 °C

DASY5 Configuration:

- Probe: ES3DV3 - SN3270; ConvF(6.01, 6.01, 6.01); Calibrated: 2016/8/26;
- Sensor-Surface: 3mm (Mechanical Surface Detection)
- Electronics: DAE4 Sn1399; Calibrated: 2015/11/23
- Phantom: SAM_Left; Type: QD000P40CD; Serial: TP:1644
- Measurement SW: DASY52, Version 52.8 (8);SEMCAD X Version 14.6.10 (7373)

Area Scan (71x121x1): Interpolated grid: dx=1.500 mm, dy=1.500 mm

Maximum value of SAR (interpolated) = 0.529 W/kg

Zoom Scan (5x5x7)/Cube 0: Measurement grid: dx=8mm, dy=8mm, dz=5mm

Reference Value = 24.20 V/m; Power Drift = -0.15 dB

Peak SAR (extrapolated) = 0.682 W/kg

SAR(1 g) = 0.436 W/kg; SAR(10 g) = 0.275 W/kg

Maximum value of SAR (measured) = 0.511 W/kg

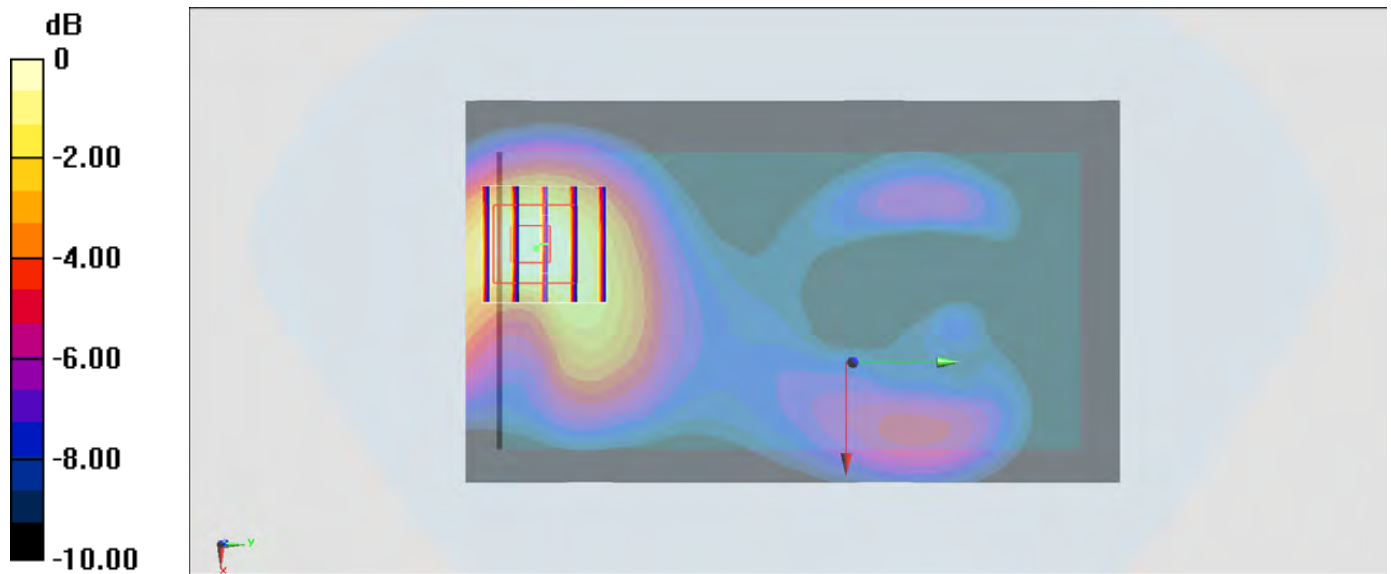

0 dB = 0.529 W/kg = -2.77 dBW/kg

#40_CDMA BC1_1xRTT RC3 SO32_Back_15mm_Ch600

Communication System: CDMA; Frequency: 1880 MHz; Duty Cycle: 1:1

Medium: MSL_1900_160905 Medium parameters used: $f = 1880$ MHz; $\sigma = 1.527$ S/m; $\epsilon_r = 55.846$; $\rho = 1000$ kg/m³

Ambient Temperature : 23.7 °C; Liquid Temperature : 22.7 °C

DASY5 Configuration:

- Probe: EX3DV4 - SN3955; ConvF(7.89, 7.89, 7.89); Calibrated: 2015/11/24;
- Sensor-Surface: 1.4mm (Mechanical Surface Detection)
- Electronics: DAE4 Sn778; Calibrated: 2016/5/12
- Phantom: SAM_Left; Type: QD000P40CD; Serial: TP:1644
- Measurement SW: DASY52, Version 52.8 (8); SEMCAD X Version 14.6.10 (7373)

Area Scan (71x71x1): Interpolated grid: dx=1.500 mm, dy=1.500 mm

Maximum value of SAR (interpolated) = 1.16 W/kg

Zoom Scan (5x5x7)/Cube 0: Measurement grid: dx=8mm, dy=8mm, dz=5mm

Reference Value = 22.15 V/m; Power Drift = -0.13 dB

Peak SAR (extrapolated) = 1.23 W/kg

SAR(1 g) = 0.797 W/kg; SAR(10 g) = 0.485 W/kg

Maximum value of SAR (measured) = 1.07 W/kg

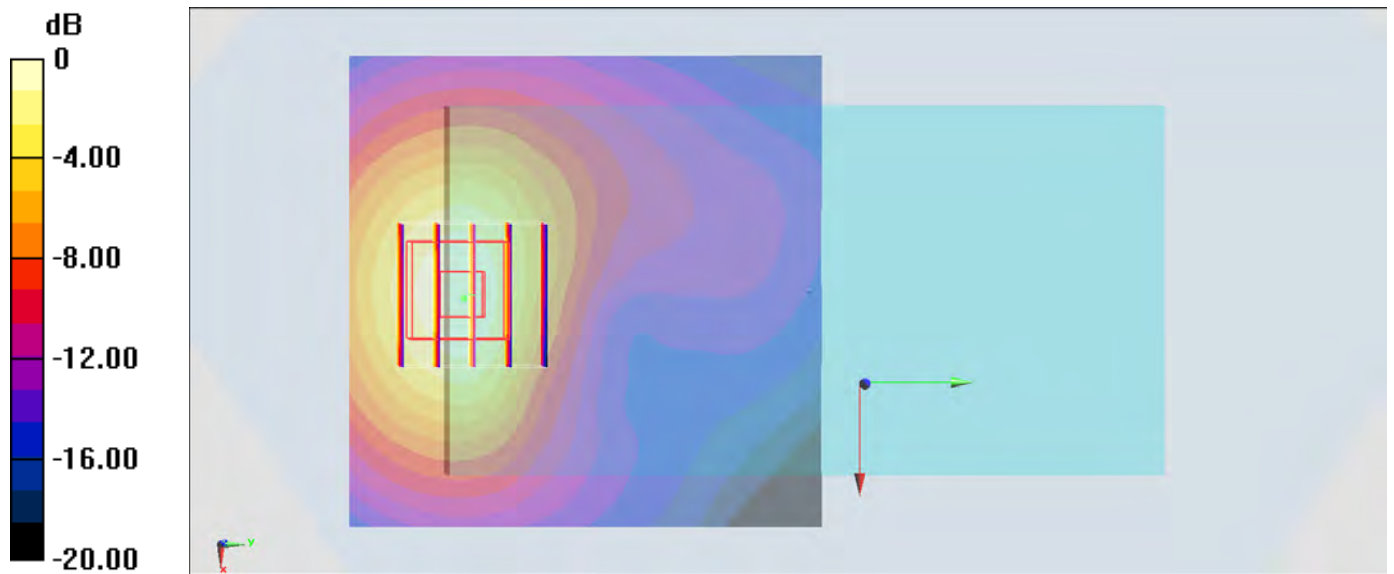

0 dB = 1.16 W/kg = 0.64 dBW/kg

#41_CDMA BC10_1xRTT RC3 SO32_Front_0mm_Ch684;Soft Holster

Communication System: CDMA; Frequency: 823.1 MHz; Duty Cycle: 1:1

Medium: MSL_850_160908 Medium parameters used : $f = 823.1$ MHz; $\sigma = 0.952$ S/m; $\epsilon_r = 57.144$; $\rho = 1000$ kg/m³

Ambient Temperature : 23.5 °C; Liquid Temperature : 22.5 °C

DASY5 Configuration:

- Probe: ES3DV3 - SN3270; ConvF(6.01, 6.01, 6.01); Calibrated: 2016/8/26;
- Sensor-Surface: 3mm (Mechanical Surface Detection)
- Electronics: DAE4 Sn1399; Calibrated: 2015/11/23
- Phantom: SAM_Left; Type: QD000P40CD; Serial: TP:1644
- Measurement SW: DASY52, Version 52.8 (8); SEMCAD X Version 14.6.10 (7373)

Area Scan (71x121x1): Interpolated grid: dx=1.500 mm, dy=1.500 mm

Maximum value of SAR (interpolated) = 0.394 W/kg

Zoom Scan (5x5x7)/Cube 0: Measurement grid: dx=8mm, dy=8mm, dz=5mm

Reference Value = 21.23 V/m; Power Drift = 0.01 dB

Peak SAR (extrapolated) = 0.539 W/kg

SAR(1 g) = 0.340 W/kg; SAR(10 g) = 0.213 W/kg

Maximum value of SAR (measured) = 0.394 W/kg

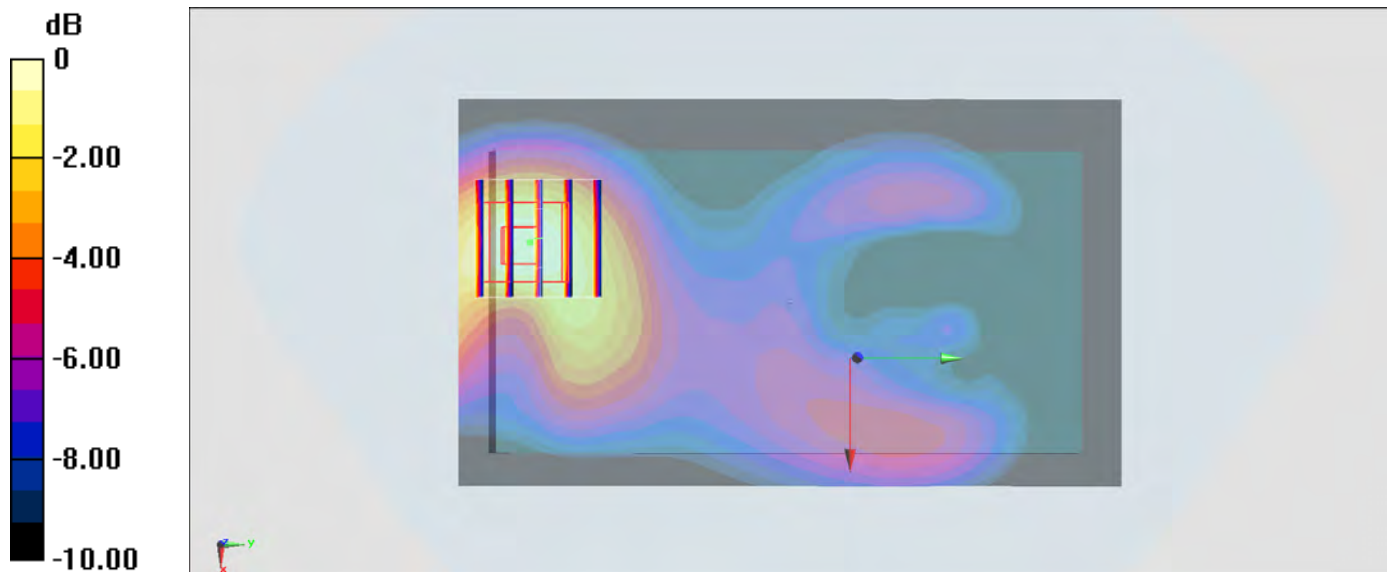

0 dB = 0.394 W/kg = -4.05 dBW/kg

#42_LTE Band 4_20M_QPSK_1_0_Back_15mm_Ch20175

Communication System: LTE; Frequency: 1732.5 MHz; Duty Cycle: 1:1

Medium: MSL_1750_160906 Medium parameters used: $f = 1732.5$ MHz; $\sigma = 1.491$ S/m; $\epsilon_r = 55.989$;

$\rho = 1000$ kg/m³

Ambient Temperature : 23.7 °C; Liquid Temperature : 22.7 °C

DASY5 Configuration:

- Probe: EX3DV4 - SN3955; ConvF(8.25, 8.25, 8.25); Calibrated: 2015/11/24;
- Sensor-Surface: 1.4mm (Mechanical Surface Detection)
- Electronics: DAE4 Sn778; Calibrated: 2016/5/12
- Phantom: SAM_Left; Type: QD000P40CD; Serial: TP:1644
- Measurement SW: DASY52, Version 52.8 (8); SEMCAD X Version 14.6.10 (7373)

Area Scan (71x71x1): Interpolated grid: dx=1.500 mm, dy=1.500 mm

Maximum value of SAR (interpolated) = 1.00 W/kg

Zoom Scan (5x5x7)/Cube 0: Measurement grid: dx=8mm, dy=8mm, dz=5mm

Reference Value = 24.45 V/m; Power Drift = -0.09 dB

Peak SAR (extrapolated) = 1.13 W/kg

SAR(1 g) = 0.739 W/kg; SAR(10 g) = 0.453 W/kg

Maximum value of SAR (measured) = 1.00 W/kg

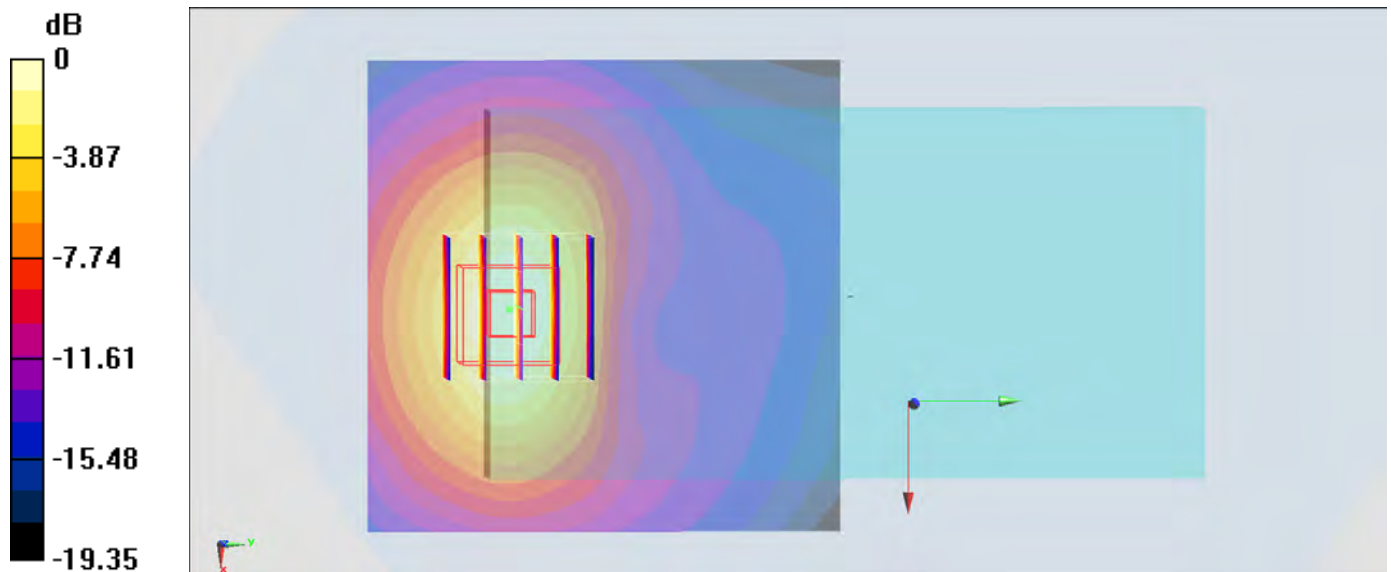

0 dB = 1.00 W/kg = 0.00 dBW/kg

#43_LTE Band 12_10M_QPSK_1_0_Back_15mm_Ch23095

Communication System: LTE; Frequency: 707.5 MHz; Duty Cycle: 1:1

Medium: MSL_750_160909 Medium parameters used: $f = 707.5$ MHz; $\sigma = 0.914$ S/m; $\epsilon_r = 56.151$; $\rho = 1000$ kg/m³

Ambient Temperature : 23.5 °C; Liquid Temperature : 22.5 °C

DASY5 Configuration:

- Probe: EX3DV4 - SN3955; ConvF(10.36, 10.36, 10.36); Calibrated: 2015/11/24;
- Sensor-Surface: 1.4mm (Mechanical Surface Detection)
- Electronics: DAE4 Sn778; Calibrated: 2016/5/12
- Phantom: SAM_Left; Type: QD000P40CD; Serial: TP:1644
- Measurement SW: DASY52, Version 52.8 (8); SEMCAD X Version 14.6.10 (7373)

Area Scan (71x131x1): Interpolated grid: dx=1.500 mm, dy=1.500 mm

Maximum value of SAR (interpolated) = 0.363 W/kg

Zoom Scan (5x5x7)/Cube 0: Measurement grid: dx=8mm, dy=8mm, dz=5mm

Reference Value = 19.50 V/m; Power Drift = -0.01 dB

Peak SAR (extrapolated) = 0.385 W/kg

SAR(1 g) = 0.299 W/kg; SAR(10 g) = 0.234 W/kg

Maximum value of SAR (measured) = 0.354 W/kg

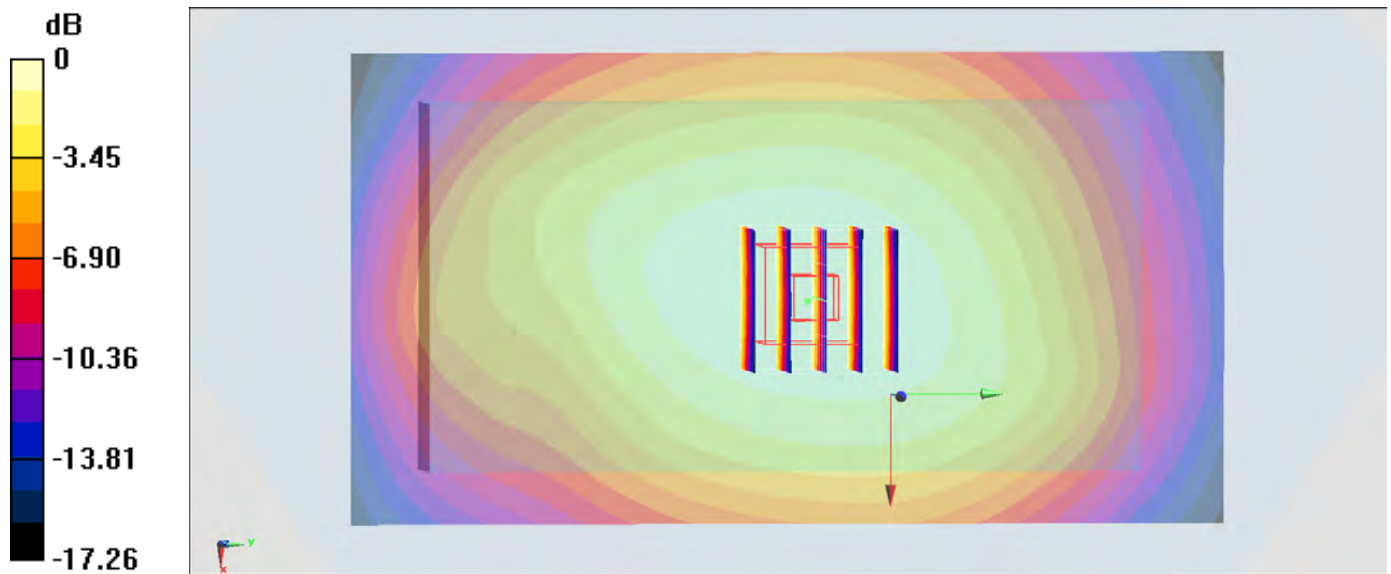

0 dB = 0.363 W/kg = -4.40 dBW/kg

#44_LTE Band 13_10M_QPSK_1_25_Back_15mm_Ch23230

Communication System: LTE ; Frequency: 782 MHz;Duty Cycle: 1:1

Medium: MSL_750_160909 Medium parameters used: $f = 782$ MHz; $\sigma = 0.983$ S/m; $\epsilon_r = 55.502$; $\rho = 1000$ kg/m³

Ambient Temperature : 23.5 °C ; Liquid Temperature : 22.5 °C

DASY5 Configuration:

- Probe: EX3DV4 - SN3955; ConvF(10.36, 10.36, 10.36); Calibrated: 2015/11/24;
- Sensor-Surface: 1.4mm (Mechanical Surface Detection)
- Electronics: DAE4 Sn778; Calibrated: 2016/5/12
- Phantom: SAM_Left; Type: QD000P40CD; Serial: TP:1644
- Measurement SW: DASY52, Version 52.8 (8);SEMCAD X Version 14.6.10 (7373)

Area Scan (71x131x1): Interpolated grid: dx=1.500 mm, dy=1.500 mm

Maximum value of SAR (interpolated) = 0.327 W/kg

Zoom Scan (5x5x7)/Cube 0: Measurement grid: dx=8mm, dy=8mm, dz=5mm

Reference Value = 17.95 V/m; Power Drift = 0.04 dB

Peak SAR (extrapolated) = 0.352 W/kg

SAR(1 g) = 0.268 W/kg; SAR(10 g) = 0.203 W/kg

Maximum value of SAR (measured) = 0.324 W/kg

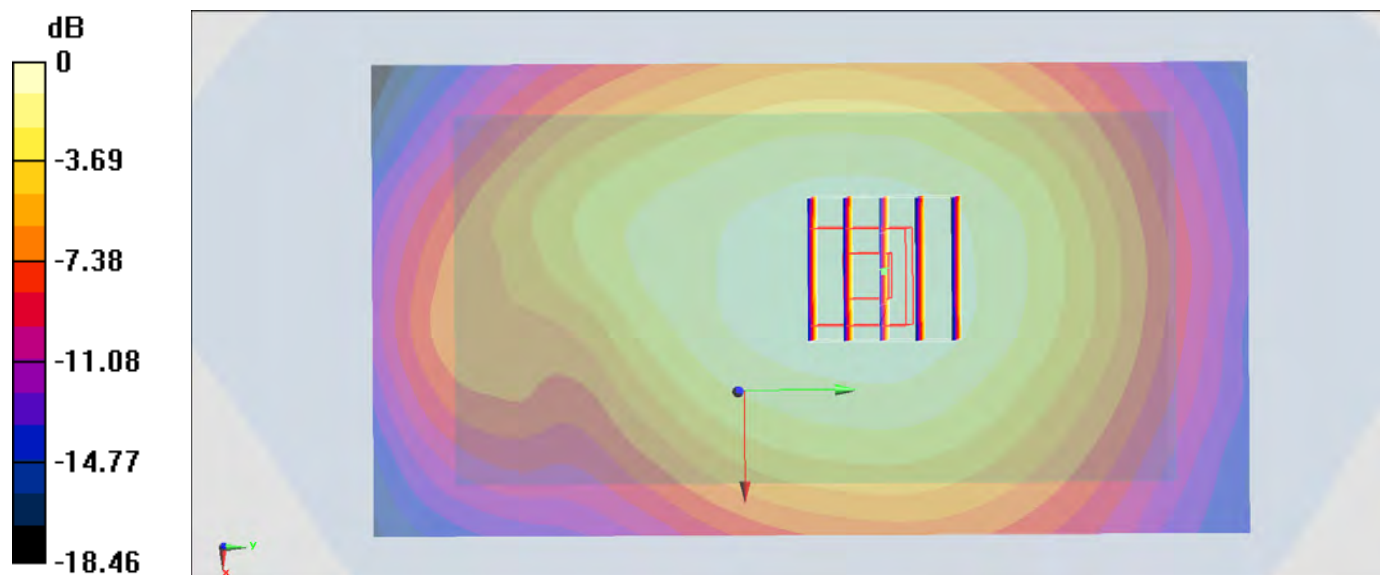

0 dB = 0.327 W/kg = -4.85 dBW/kg

#45_LTE Band 25_20M_QPSK_1_49_Back_15mm_Ch26340

Communication System: LTE; Frequency: 1880 MHz; Duty Cycle: 1:1

Medium: MSL_1900_160907 Medium parameters used: $f = 1880$ MHz; $\sigma = 1.52$ S/m; $\epsilon_r = 55.812$; $\rho = 1000$ kg/m³

Ambient Temperature : 23.4 °C; Liquid Temperature : 22.4 °C

DASY5 Configuration:

- Probe: EX3DV4 - SN3955; ConvF(7.89, 7.89, 7.89); Calibrated: 2015/11/24;
- Sensor-Surface: 1.4mm (Mechanical Surface Detection)
- Electronics: DAE4 Sn778; Calibrated: 2016/5/12
- Phantom: SAM_Left; Type: QD000P40CD; Serial: TP:1644
- Measurement SW: DASY52, Version 52.8 (8); SEMCAD X Version 14.6.10 (7373)

Area Scan (71x71x1): Interpolated grid: dx=1.500 mm, dy=1.500 mm

Maximum value of SAR (interpolated) = 1.05 W/kg

Zoom Scan (5x5x7)/Cube 0: Measurement grid: dx=8mm, dy=8mm, dz=5mm

Reference Value = 22.27 V/m; Power Drift = 0.06 dB

Peak SAR (extrapolated) = 1.13 W/kg

SAR(1 g) = 0.729 W/kg; SAR(10 g) = 0.442 W/kg

Maximum value of SAR (measured) = 0.993 W/kg

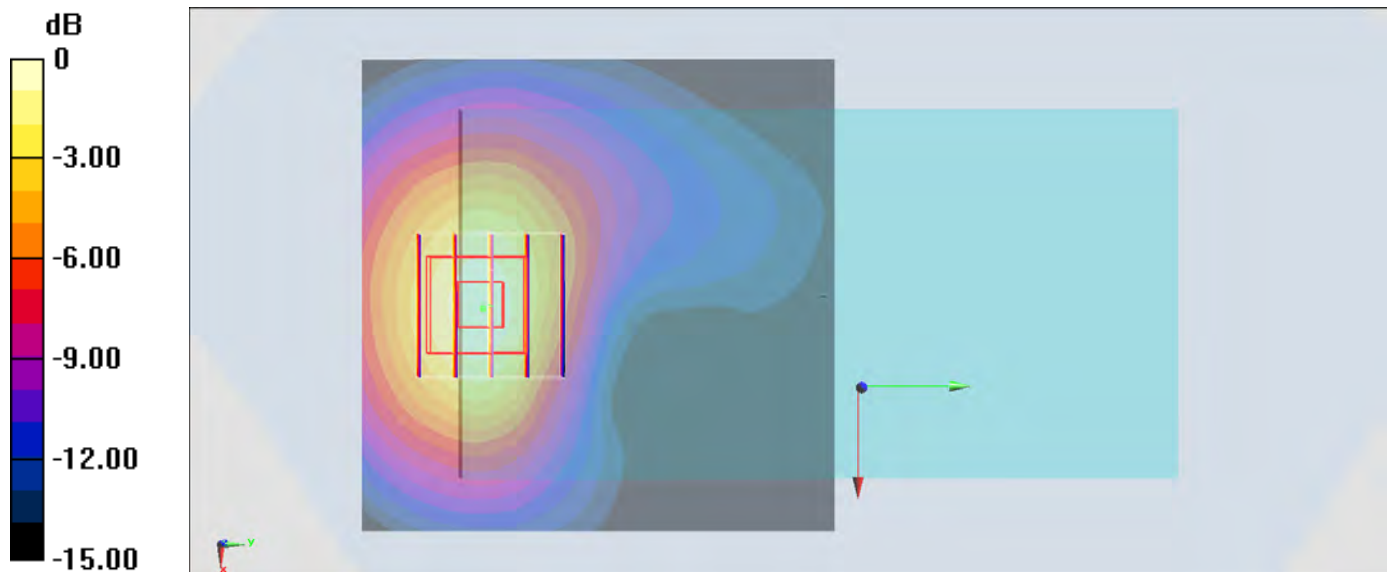

0 dB = 1.05 W/kg = 0.21 dBW/kg

#46_LTE Band 26_15M_QPSK_1_37_Front_0mm_Ch26865;Soft Holster

Communication System: LTE ; Frequency: 831.5 MHz;Duty Cycle: 1:1

Medium: MSL_850_160907 Medium parameters used : $f = 831.5$ MHz; $\sigma = 0.965$ S/m; $\epsilon_r = 57.187$; $\rho = 1000$ kg/m³

Ambient Temperature : 23.4 °C ; Liquid Temperature : 22.4 °C

DASY5 Configuration:

- Probe: EX3DV4 - SN3955; ConvF(10.08, 10.08, 10.08); Calibrated: 2015/11/24;
- Sensor-Surface: 1.4mm (Mechanical Surface Detection)
- Electronics: DAE4 Sn778; Calibrated: 2016/5/12
- Phantom: SAM_Left; Type: QD000P40CD; Serial: TP:1644
- Measurement SW: DASY52, Version 52.8 (8);SEMCAD X Version 14.6.10 (7373)

Area Scan (71x121x1): Interpolated grid: dx=1.500 mm, dy=1.500 mm

Maximum value of SAR (interpolated) = 0.493 W/kg

Zoom Scan (5x5x7)/Cube 0: Measurement grid: dx=8mm, dy=8mm, dz=5mm

Reference Value = 20.04 V/m; Power Drift = 0.15 dB

Peak SAR (extrapolated) = 0.585 W/kg

SAR(1 g) = 0.364 W/kg; SAR(10 g) = 0.229 W/kg

Maximum value of SAR (measured) = 0.498 W/kg

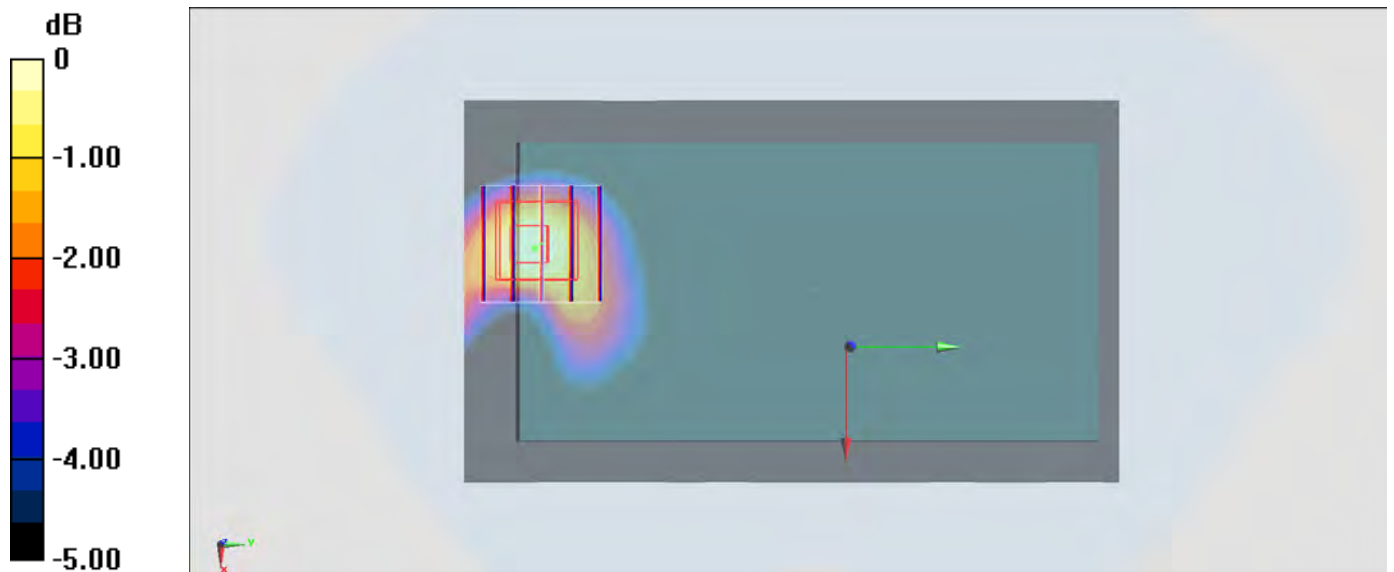

0 dB = 0.493 W/kg = -3.07 dBW/kg

#47_WLAN2.4GHz_802.11b 1Mbps_Back_15mm_Ch6;Ant 1

Communication System: 802.11b; Frequency: 2437 MHz; Duty Cycle: 1:1.014

Medium: MSL_2450_160908 Medium parameters used: $f = 2437$ MHz; $\sigma = 1.965$ S/m; $\epsilon_r = 52.622$; $\rho = 1000$ kg/m³

Ambient Temperature : 23.6 °C ; Liquid Temperature : 22.6 °C

DASY5 Configuration:

- Probe: EX3DV4 - SN3697; ConvF(6.9, 6.9, 6.9); Calibrated: 2015/9/28;
- Sensor-Surface: 1.4mm (Mechanical Surface Detection)
- Electronics: DAE4 Sn1388; Calibrated: 2015/9/25
- Phantom: SAM_Right; Type: QD000P40CD; Serial: TP:1383
- Measurement SW: DASY52, Version 52.8 (8); SEMCAD X Version 14.6.10 (7331)

Area Scan (81x151x1): Interpolated grid: dx=1.200 mm, dy=1.200 mm

Maximum value of SAR (interpolated) = 0.212 W/kg

Zoom Scan (7x7x7)/Cube 0: Measurement grid: dx=5mm, dy=5mm, dz=5mm

Reference Value = 5.616 V/m; Power Drift = -0.18 dB

Peak SAR (extrapolated) = 0.254 W/kg

SAR(1 g) = 0.143 W/kg; SAR(10 g) = 0.080 W/kg

Maximum value of SAR (measured) = 0.211 W/kg

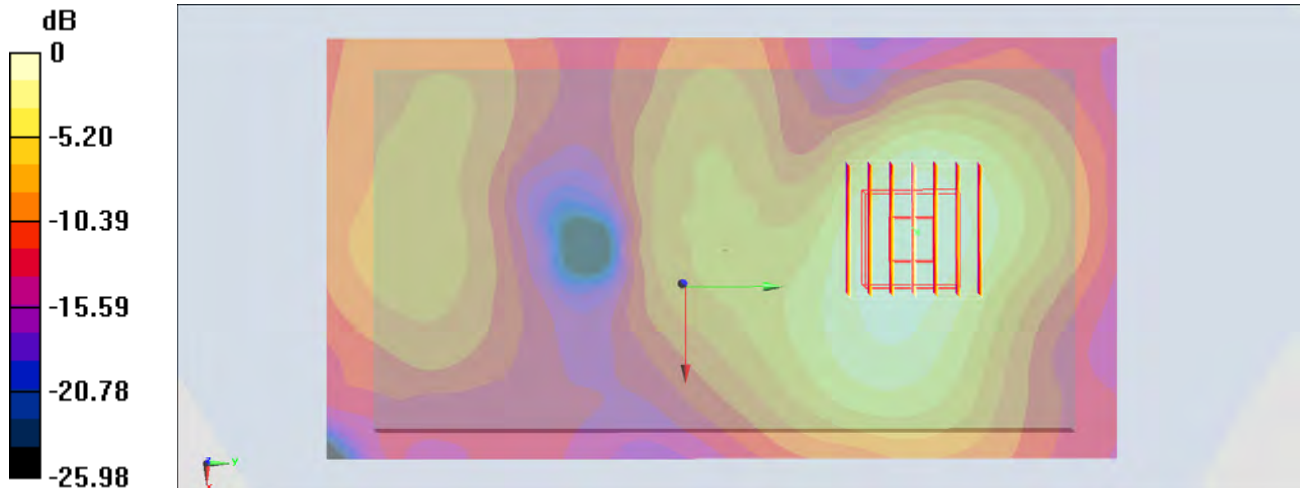

0 dB = 0.211 W/kg = -6.76 dBW/kg

#48_WLAN5GHz_802.11a 6Mbps_Back_15mm_Ch52;Ant 2

Communication System: 802.11a ; Frequency: 5260 MHz;Duty Cycle: 1:1.077

Medium: MSL_5G_160909 Medium parameters used: $f = 5260$ MHz; $\sigma = 5.483$ S/m; $\epsilon_r = 46.873$; $\rho = 1000$ kg/m³

Ambient Temperature : 23.9 °C ; Liquid Temperature : 22.9 °C

DASY5 Configuration:

- Probe: EX3DV4 - SN3931; ConvF(4.48, 4.48, 4.48); Calibrated: 2015/10/1;
- Sensor-Surface: 1.4mm (Mechanical Surface Detection)
- Electronics: DAE3 Sn577; Calibrated: 2015/9/24
- Phantom: SAM_Right; Type: QD000P40CD; Serial: TP:1383
- Measurement SW: DASY52, Version 52.8 (8);SEMCAD X Version 14.6.10 (7331)

Area Scan (121x101x1): Interpolated grid: dx=1.000 mm, dy=1.000 mm

Maximum value of SAR (interpolated) = 0.586 W/kg

Zoom Scan (7x7x7)/Cube 0: Measurement grid: dx=4mm, dy=4mm, dz=1.4mm

Reference Value = 0.7770 V/m; Power Drift = 0.17 dB

Peak SAR (extrapolated) = 0.998 W/kg

SAR(1 g) = 0.317 W/kg; SAR(10 g) = 0.137 W/kg

Maximum value of SAR (measured) = 0.647 W/kg

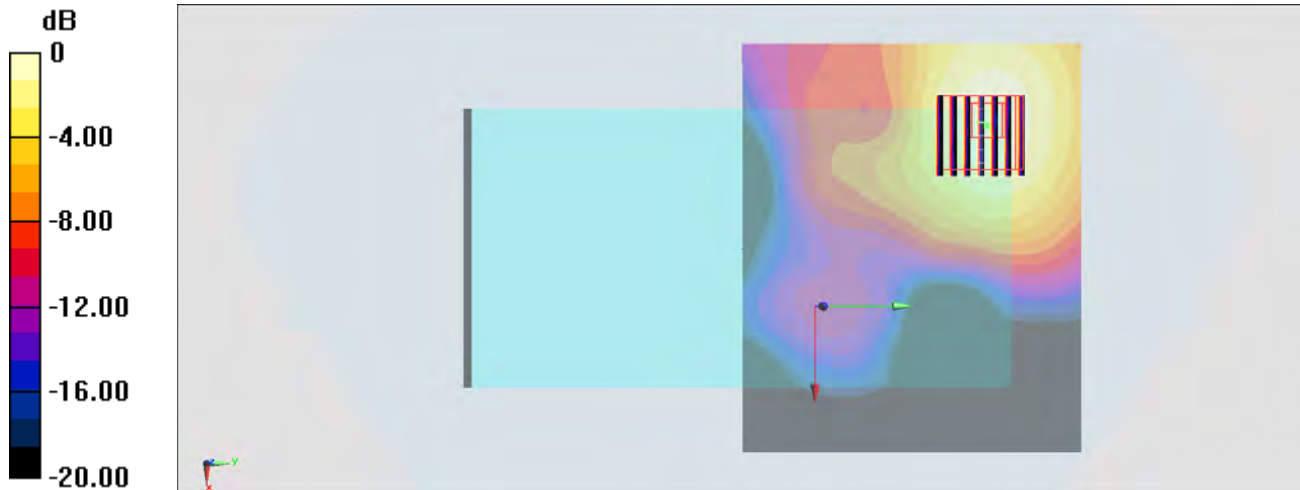

0 dB = 0.647 W/kg = -1.89 dBW/kg

#49_WLAN5GHz_802.11a 6Mbps_Back_15mm_Ch116;Ant 2

Communication System: 802.11a; Frequency: 5580 MHz;Duty Cycle: 1:1.077

Medium: MSL_5G_160912 Medium parameters used: $f = 5580$ MHz; $\sigma = 5.901$ S/m; $\epsilon_r = 46.262$; $\rho = 1000$ kg/m³

Ambient Temperature : 23.5 °C ; Liquid Temperature : 22.5 °C

DASY5 Configuration:

- Probe: EX3DV4 - SN3931; ConvF(3.84, 3.84, 3.84); Calibrated: 2015/10/1;
- Sensor-Surface: 1.4mm (Mechanical Surface Detection)
- Electronics: DAE3 Sn577; Calibrated: 2015/9/24
- Phantom: SAM-Right; Type: SAM; Serial: 1795
- Measurement SW: DASY52, Version 52.8 (8);SEMCAD X Version 14.6.10 (7373)

Area Scan (121x101x1): Interpolated grid: dx=1.000 mm, dy=1.000 mm

Maximum value of SAR (interpolated) = 0.697 W/kg

Zoom Scan (7x7x7)/Cube 0: Measurement grid: dx=4mm, dy=4mm,dz=1.4mm

Reference Value = 12.61 V/m; Power Drift = -0.08 dB

Peak SAR (extrapolated) = 1.07 W/kg

SAR(1 g) = 0.321 W/kg; SAR(10 g) = 0.134 W/kg

Maximum value of SAR (measured) = 0.693 W/kg

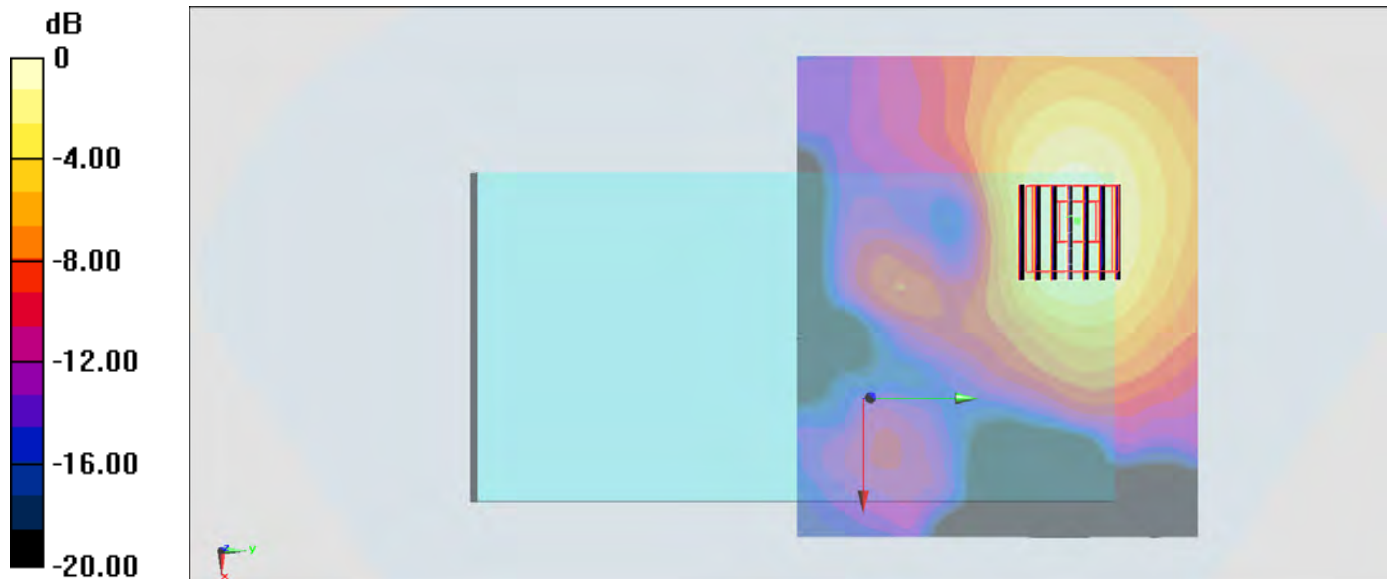

0 dB = 0.697 W/kg = -1.57 dBW/kg

#50_WLAN5GHz_802.11a 6Mbps_Back_15mm_Ch165;Ant 2

Communication System: 802.11a; Frequency: 5825 MHz; Duty Cycle: 1:1.077

Medium: MSL_5G_160912 Medium parameters used: $f = 5825$ MHz; $\sigma = 6.23$ S/m; $\epsilon_r = 45.864$; $\rho = 1000$ kg/m³

Ambient Temperature : 23.5 °C; Liquid Temperature : 22.5 °C

DASY5 Configuration:

- Probe: EX3DV4 - SN3931; ConvF(3.98, 3.98, 3.98); Calibrated: 2015/10/1;
- Sensor-Surface: 1.4mm (Mechanical Surface Detection)
- Electronics: DAE3 Sn577; Calibrated: 2015/9/24
- Phantom: SAM-Right; Type: SAM; Serial: 1795
- Measurement SW: DASY52, Version 52.8 (8); SEMCAD X Version 14.6.10 (7373)

Area Scan (121x101x1): Interpolated grid: dx=1.000 mm, dy=1.000 mm

Maximum value of SAR (interpolated) = 0.693 W/kg

Zoom Scan (7x7x7)/Cube 0: Measurement grid: dx=4mm, dy=4mm, dz=1.4mm

Reference Value = 11.90 V/m; Power Drift = -0.16 dB

Peak SAR (extrapolated) = 1.13 W/kg

SAR(1 g) = 0.313 W/kg; SAR(10 g) = 0.127 W/kg

Maximum value of SAR (measured) = 0.699 W/kg

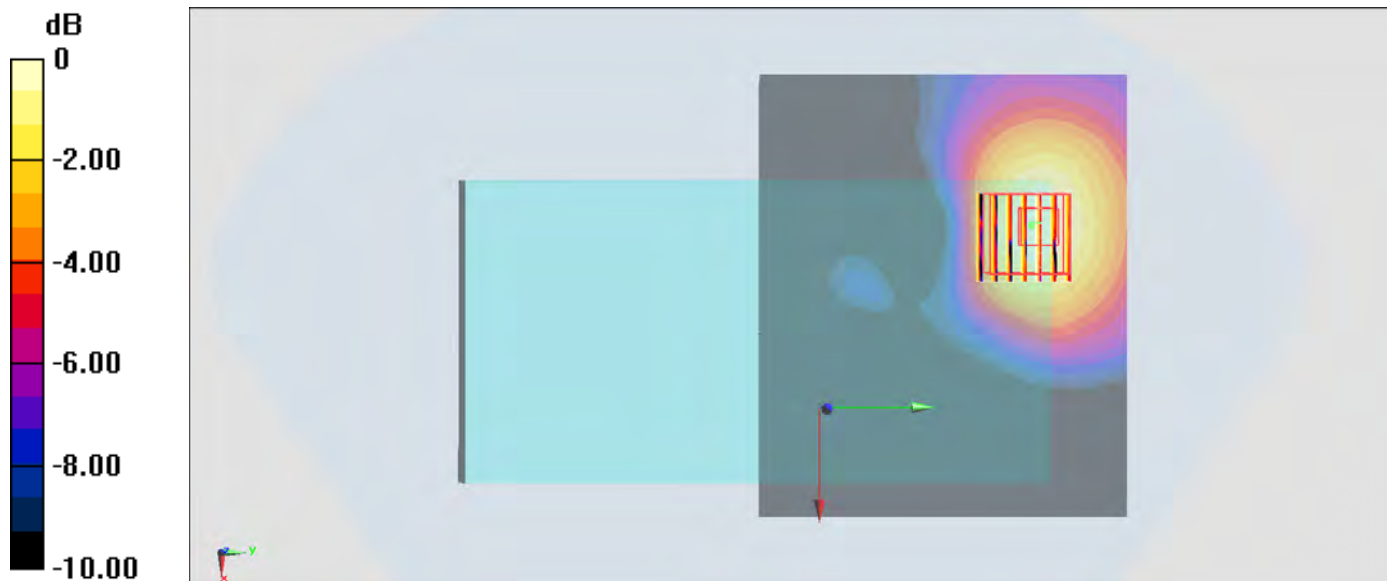

0 dB = 0.693 W/kg = -1.59 dBW/kg

#51_Bluetooth_GFSK_Back_15mm_Ch39

Communication System: Bluetooth ; Frequency: 2480 MHz; Duty Cycle: 1:1.20

Medium: MSL_2450_160921 Medium parameters used: $f = 2480$ MHz; $\sigma = 2.001$ S/m; $\epsilon_r = 52.18$; $\rho = 1000$ kg/m³

Ambient Temperature : 23.4 °C ; Liquid Temperature : 22.4 °C

DASY5 Configuration:

- Probe: EX3DV4 - SN3925; ConvF(7.64, 7.64, 7.64); Calibrated: 2016/5/26;
- Sensor-Surface: 1.4mm (Mechanical Surface Detection)
- Electronics: DAE3 Sn495; Calibrated: 2016/5/27
- Phantom: SAM-Right; Type: SAM; Serial: 1795
- Measurement SW: DASY52, Version 52.8 (8); SEMCAD X Version 14.6.10 (7331)

Area Scan (81x151x1): Interpolated grid: dx=1.200 mm, dy=1.200 mm

Maximum value of SAR (interpolated) = 0.000984 W/kg

Zoom Scan (7x7x7)/Cube 0: Measurement grid: dx=5mm, dy=5mm, dz=5mm

Reference Value = 0.4440 V/m; Power Drift = 0.10 dB

Peak SAR (extrapolated) = 0.00125 W/kg

SAR(1 g) = 6.91e-006 W/kg; SAR(10 g) = 1.14e-006 W/kg

Maximum value of SAR (measured) = 0.00236 W/kg

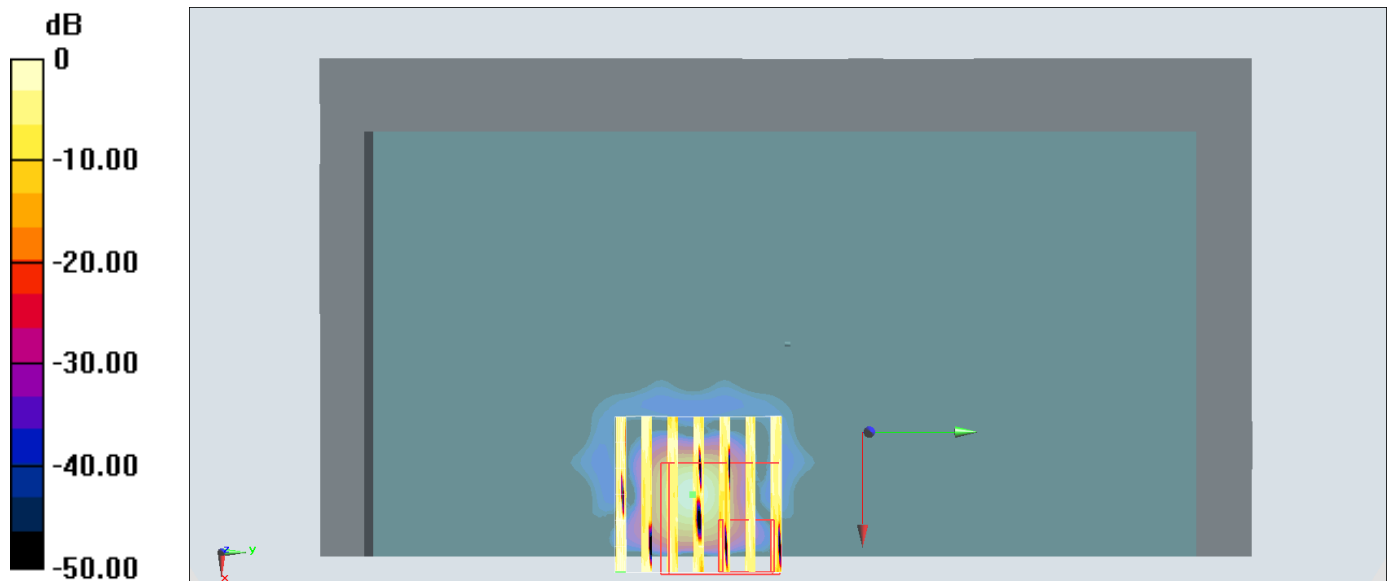

0 dB = 0.000984 W/kg = -30.07 dBW/kg